

dyson

DC
14

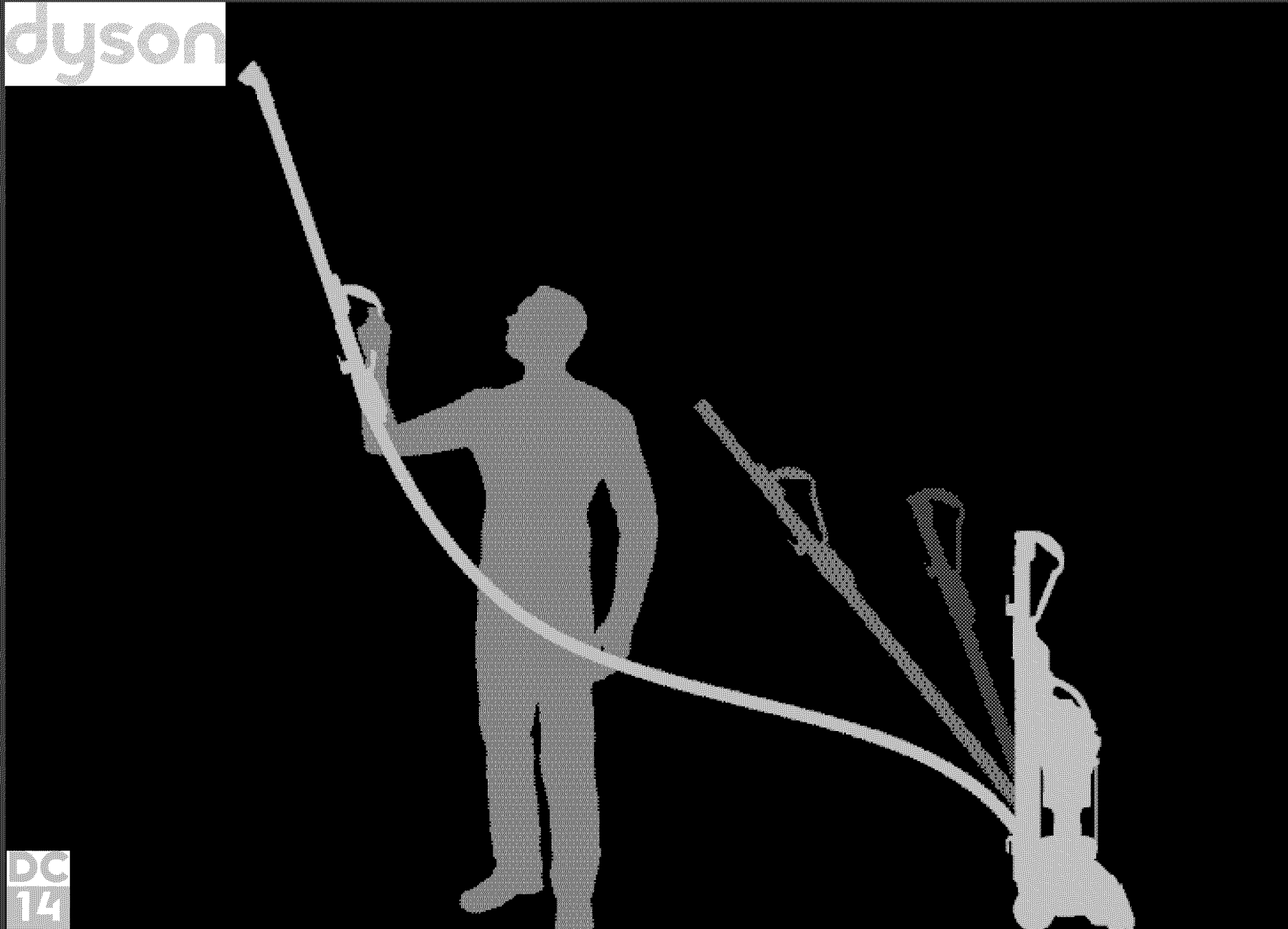

Owner's manual
Please read this guide carefully
before using your DC14.

IMPORTANT SAFETY INSTRUCTIONS

READ ALL INSTRUCTIONS BEFORE USING THIS VACUUM CLEANER

When using an electrical appliance, basic precautions should always be followed, including the following:

WARNING

TO REDUCE THE RISK OF FIRE, ELECTRIC SHOCK OR INJURY:

- 1 Do not leave plugged in. Unplug from electrical outlet when not in use and before servicing.
- 2 Do not use outdoors or on wet surfaces or to vacuum water or other liquids – electric shock and personal injury could occur.
- 3 Do not allow to be used as a toy. Close attention is necessary when used by or near children.
- 4 You are responsible for making sure that your vacuum cleaner is not used by anyone unable to operate it properly.
- 5 Use only as described in this manual. Use only with Dyson recommended or approved attachments and accessories.
- 6 Check to ensure your electricity supply corresponds to that shown on the rating plate, which can be found on the base of the machine between the wheels. The machine must only be used as rated.
- 7 Do not use with a damaged cord or plug. If the machine is not functioning properly, has been dropped, damaged, left outdoors, or immersed in liquid, contact the Dyson Helpline on 1-866-693-9766.
- 8 Do not pull or carry by the cord, do not use the cord as a handle, do not close a door on the cord or pull the cord around sharp edges or corners. Do not run the machine over the cord. Keep the cord away from heated surfaces and open flames.
- 9 Do not unplug by pulling on the cord. To unplug, grasp the plug, not the cord.
- 10 Hold plug when rewinding onto cord reel. Do not allow plug to whip when rewinding.
- 11 Do not handle the plug or machine with wet hands.
- 12 Do not use the machine without the clear bin™ and the filters in place.
- 13 Do not put any objects into openings in the machine. Do not use with any opening blocked; keep free of dust, lint, hair and anything that may reduce air flow.
- 14 Keep hair, loose clothing, fingers, and all parts of body away from openings in the machine and moving parts such as the brushbar.
- 15 Do not use the machine to pick up sharp hard objects, small toys, pins, paper clips etc. because they may damage the machine.
- 16 The use of an extension cord is not recommended.
- 17 Store the machine indoors. Put the machine away after use with the cord coiled safely, to prevent tripping accidents.
- 18 Turn off all controls before unplugging.
- 19 Take extra care when cleaning on stairs; always work with the machine at the bottom of the stairs. Do not put the machine on chairs, tables etc, keep it on the floor.
- 20 Do not pick up anything that is burning or smoking, such as cigarettes, matches, or hot ashes.
- 21 Do not use to pick up flammable or combustible liquids, such as gasoline, or use in areas where they may be present.
- 22 When vacuuming, certain carpets may generate small static charges in the clear bin™ or wand. These are not associated with the electricity supply. To minimize any effect from this, do not put your hand or insert any object into the clear bin™ unless you have first emptied it and rinsed it out with cold water.
- 23 Use only identical replacement parts.
- 24 Do not carry out any maintenance or repair work other than that shown in this manual or advised by the Helpline.

SAVE THESE INSTRUCTIONS

THIS APPLIANCE IS INTENDED FOR HOUSEHOLD USE ONLY

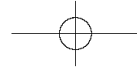

Owner's manual

Please read this guide carefully before using your DC14.

Important safety instructions	Page 2
Assembling your DCO7	4
Using your DCO7	6
Using the tools	8
Emptying the clear bin™	10
Cleaning the lifetime filter	12
Where to look for blockages	14
Warranty and customer care	16

Important safety instructions

Important safety instructions

Important safety instructions

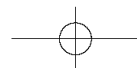
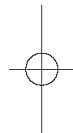
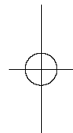

Assembling your DC14

Important safety instructions

Important safety instructions

Box contents

- CAUTION**
- Please see the back of the manual for optional accessories.
 - If you have any questions, please call the Dyson helpline on 1-866-693-9766 or log on to www.dyson.com

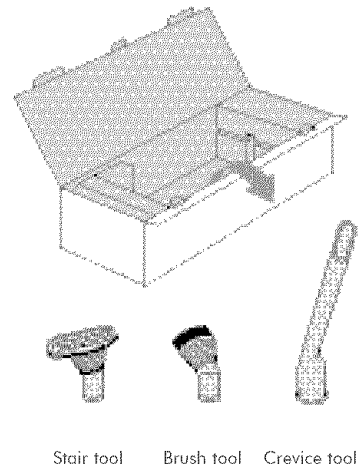

Stair tool Brush tool Crevice tool

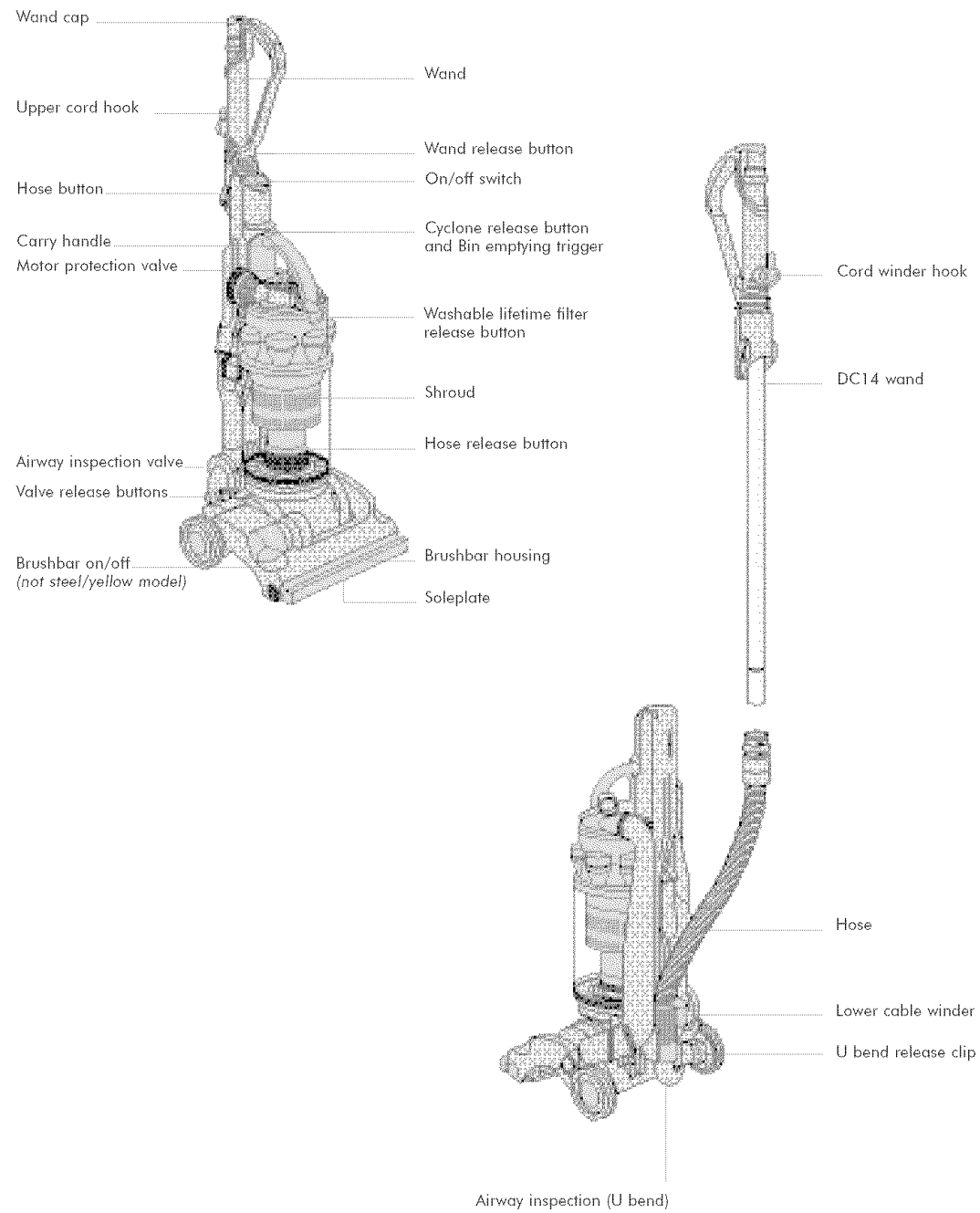
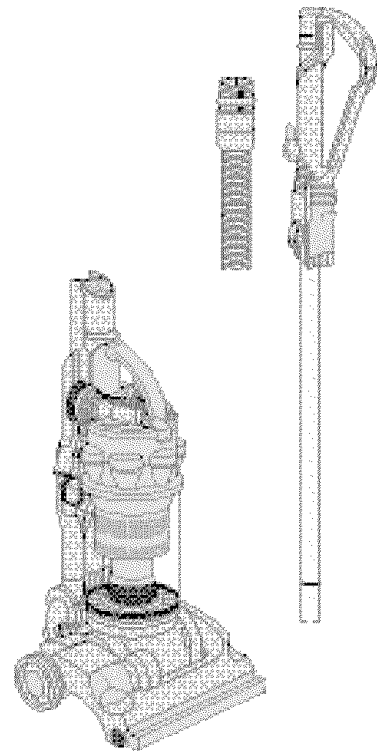

Assembling your DC14

⚠ CAUTION

- Ensure the wand cap cover is closed.
- Ensure hose is kept straight when inserting wand into hose.

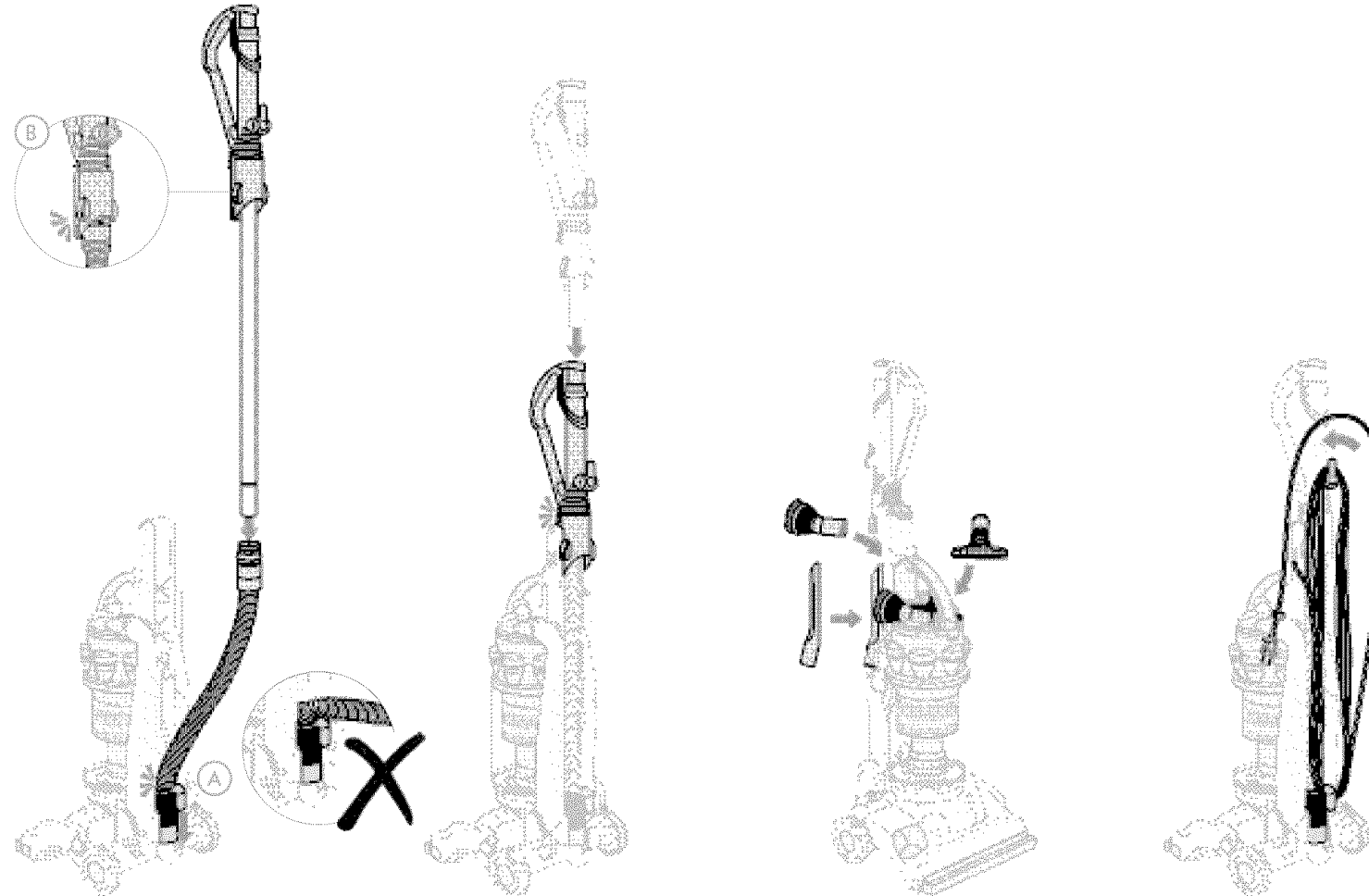

A Slide hose into guides at back of machine and click into place.

B Slide wand straight down in to hose until it clicks into place. Ensure hose does not bend.

Click wand handle into top of machine.

Click tools into place.

Wind cable counter-clockwise around cord winders and secure with clip. To quickly release cord, rotate cord wind release.

Assembling your DC14

Important safety instructions

Important safety instructions

Using your DC14

Important safety instructions

Important safety instructions

Using your DC14

CAUTION

- The machine is intended for domestic use only.
- Fine dust such as plaster dust should only be vacuumed in very small amounts.
- Do not press the cyclone release catch while carrying the machine.
- Ensure the cyclone pack is secured to the machine.
- Do not shake the machine while carrying.
- Keep hair and loose fabrics away from wand cap when machine is on.
- Use machine in Bare Floor mode on fine or delicate carpets.
- Ensure the machine is in an upright position before adjusting the setting.

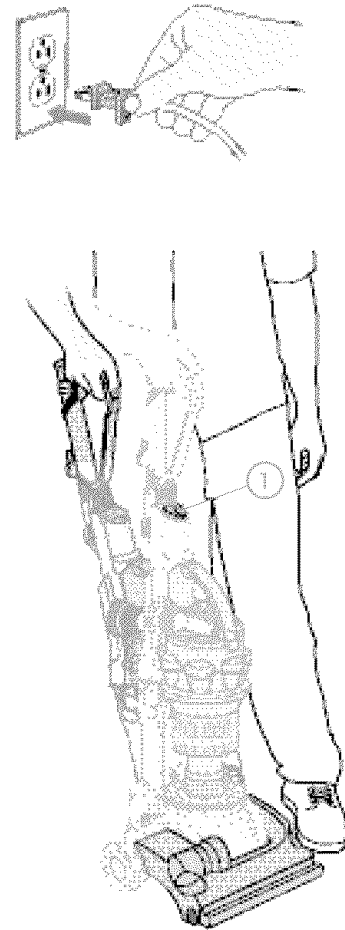

After plugging machine into mains, press on/off button **1**, push cleaner head down with foot and pull handle towards you.

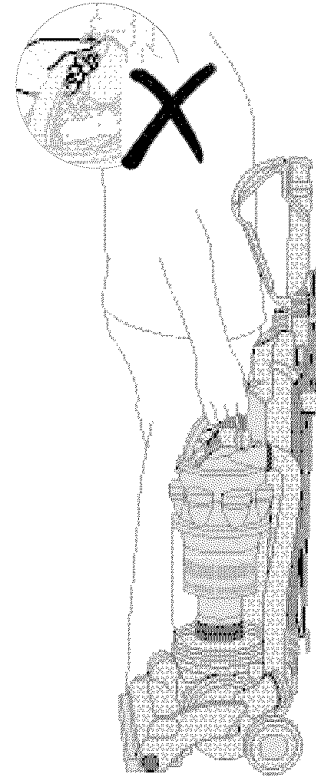

Use the carry handle to lift the machine.

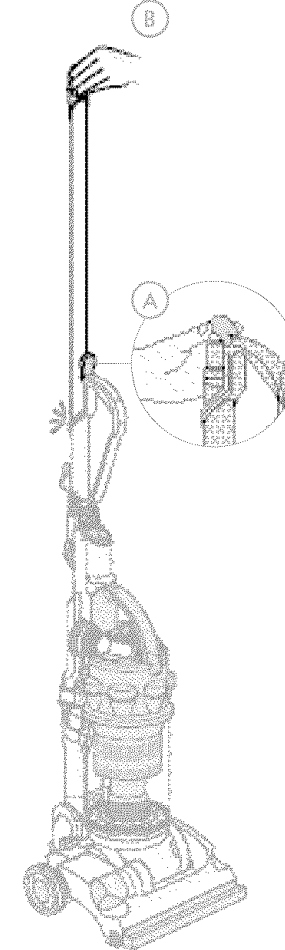

Tools

- A** Push back wand cap.
- B** Pull wand from inside wand handle until it locks into place.

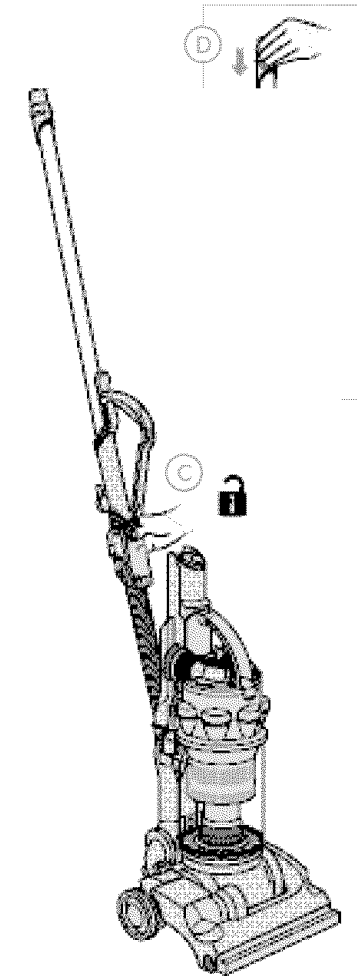

- C** Press button to release hose and wand handle from machine.
- D** To push wand back inside hose, ensure hose is straight. Press the wand release button and push wand back inside wand handle.

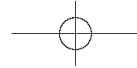

Using your DC14 tools

⚠ CAUTION

- Powerful suction can cause the hose to 'pull back' in use – please take care when cleaning stairs.
- For your safety, when the hose is fully extended, grasp firmly by the hose, not the tool.
- To avoid personal injury and to prevent the machine from falling when cleaning stairs, always place it at the bottom of the stairs.

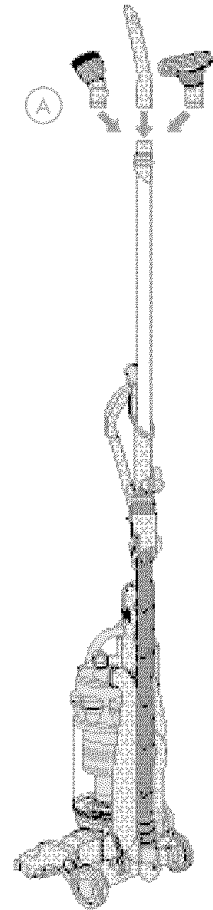

A Tools can be fitted directly to the end of the wand and hose for cleaning hard to reach places.

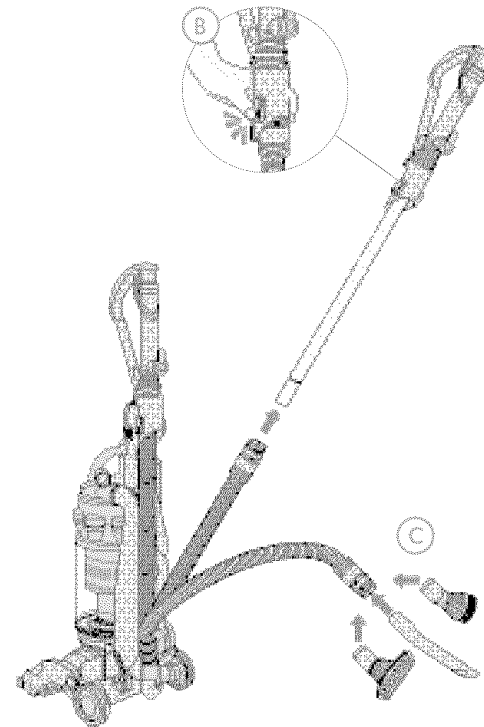

B To fit tools directly to hose, first extend the wand. Then press side buttons to remove wand handle from the hose.



C The tools can be fitted directly to the end of the hose.

Always work with the machine at the bottom of the stairs.

Using your DC14 tools

Important safety instructions

Important safety instructions

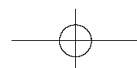
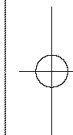
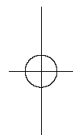

Emptying the clear bin™

Important safety instructions

Important safety instructions

Emptying the clear bin™

CAUTION

- Turn power off and unplug before emptying the bin. Failure to do so could result in electric shock or personal injury.

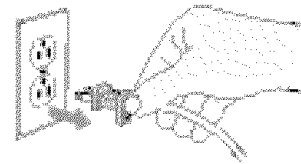

- Do not use the machine without the clear bin™ in place.



The British Allergy Foundation considers that this product may in proper use reduce exposure to both House Dust Mite (Der p 1) and Cat Allergen (Fel d 1). It is strongly recommended that a sensitive person should take care when emptying the clear bin™. We recommend the manufacturers' emptying instructions should be strictly followed.

Assessment carried out by BAF indicate that an individual's exposure can be reduced but this does not mean that an individual's allergic symptoms will necessarily diminish. BAF's opinion applies only to the products and allergen stated. The product should be used only for its intended purpose and strictly in accordance with the manufacturers' instructions at all times.

Exposure to allergens can be dangerous. If you believe that you may suffer from an allergy you should seek medical advice. The British Allergy Foundation is a national charity (Charity Reg. No. 1003726) founded in 1991 with the aim of improving awareness, prevention and treatment of allergy.

The Foundation continually strives to help sufferers to help themselves, often seeking to avoid or reduce exposure to relevant allergens. The Seal of Approval scheme forms a part of this initiative.

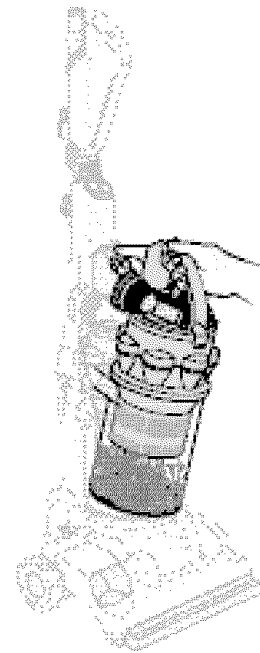

Empty the clear bin™ as soon as the **MAX** mark is reached. Press cyclone release button to release cyclone from machine.

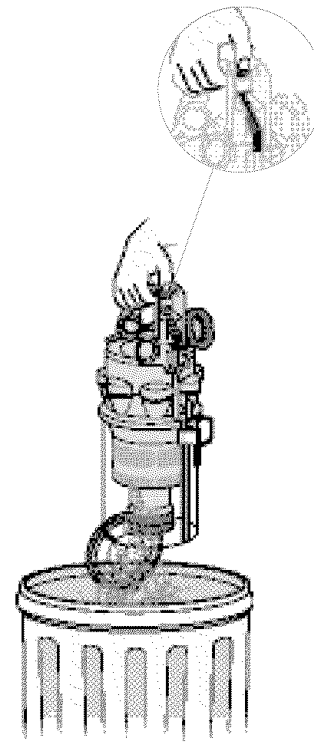

Option A
Push the red, bin emptying button as shown to release the bin base and empty directly into trash.

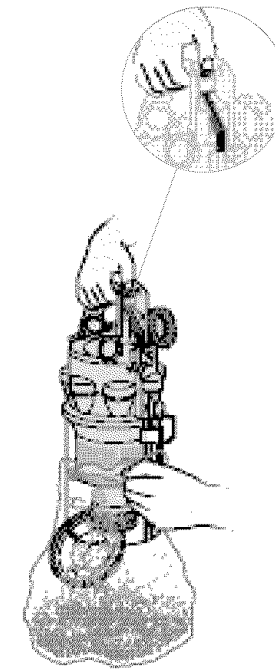

Option B
Emptying in a bag is recommended for allergy sufferers. Place bin in bag and push red bin emptying button to release bin base.

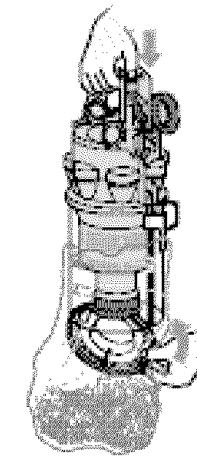

Let the dust settle, close bin base securely before removing from bag. Close bin base securely and place back onto machine.

Cleaning the Clear bin™

⚠ CAUTION

- Do not use detergents, polishes or air fresheners to clean the clear bin™.
- Do not immerse the cleaner in water.
- Ensure the bin is completely dry before refitting.

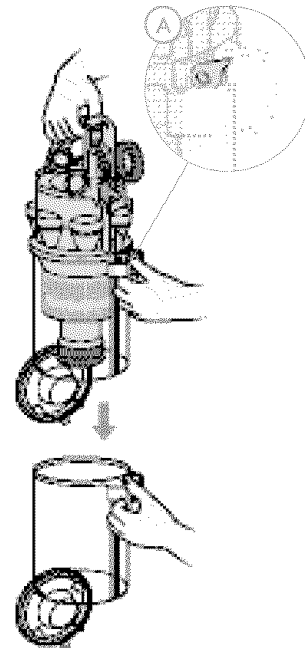

Cleaning the shroud *(if necessary)*

Ensure the bin has been emptied and bin base is open.

Press catch A to release clear bin™.

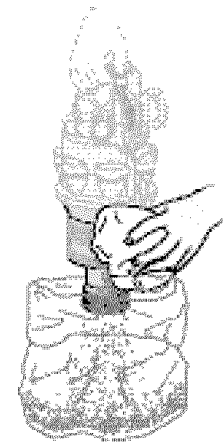

Clean shroud with a cloth or small brush to remove lint or debris.



Cleaning the clear bin™

Clean clear bin™ with a cloth or small brush.

- Do not use detergents, polishes or air fresheners.
- Do not immerse the cleaner in water.
- Ensure the bin is completely dry before refitting.

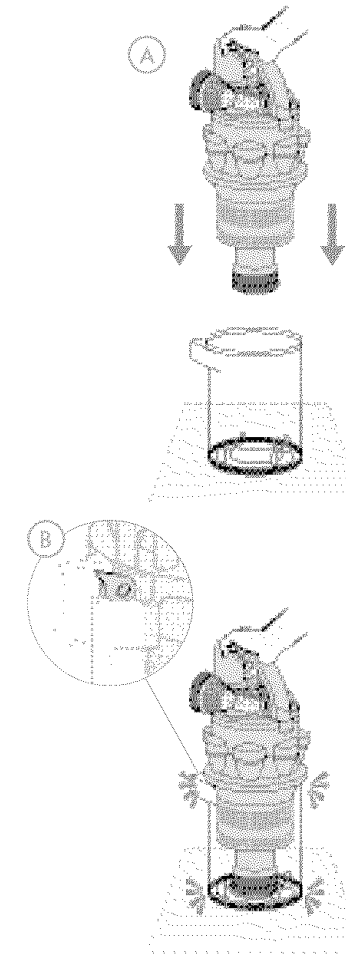

Replacing the bin

A Hold the carry handle and place the cyclone into the clear bin™.

B Line up the catches and push down to click in to place. Ensure the clear bin™ is secure before replacing on the machine.

Cleaning the Clear bin™

Important safety instructions

Important safety instructions

Washing the filter at least every 6 months

Important safety instructions

Important safety instructions

Washing the filter at least every 6 months

⚠ CAUTION

- Filter must be washed every 6 months according to instructions to maintain performance.
- Turn power off and unplug before checking for blockages. Failure to do so could result in electric shock or personal injury.

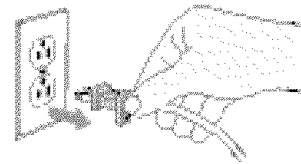

- Do not use detergent to clean filter.
- Do not put the filter in the dishwasher, washing machine, oven, tumble dryer, microwave or near an open flame.

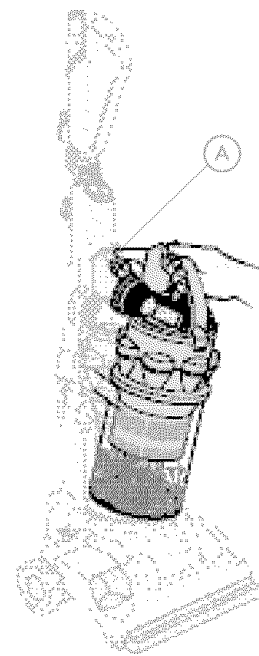
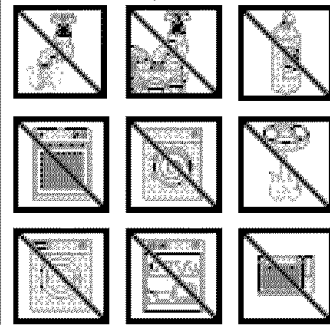

The filter may require washing more frequently than 6 months based on individual vacuuming habits. Press cyclone release button **A** to release cyclone pack.

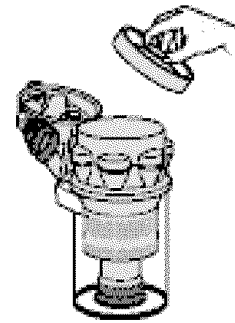
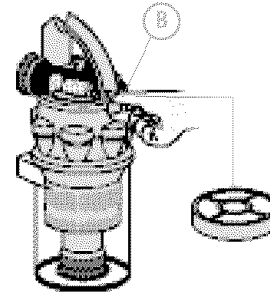

Accessing the filter

Lift washable lifetime filter release button **B** and remove filter from machine.

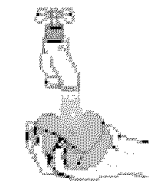
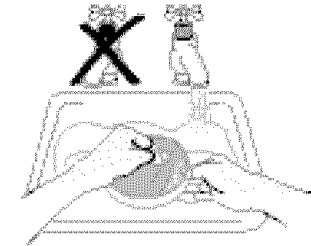

Washing the filter

- Wash filter and case in cold water only.
- Only wash blue foam and yellow cage.
- Do not use detergent.
- Do not put the filter in the dishwasher, washing machine, oven, tumble dryer, microwave or near an open flame.

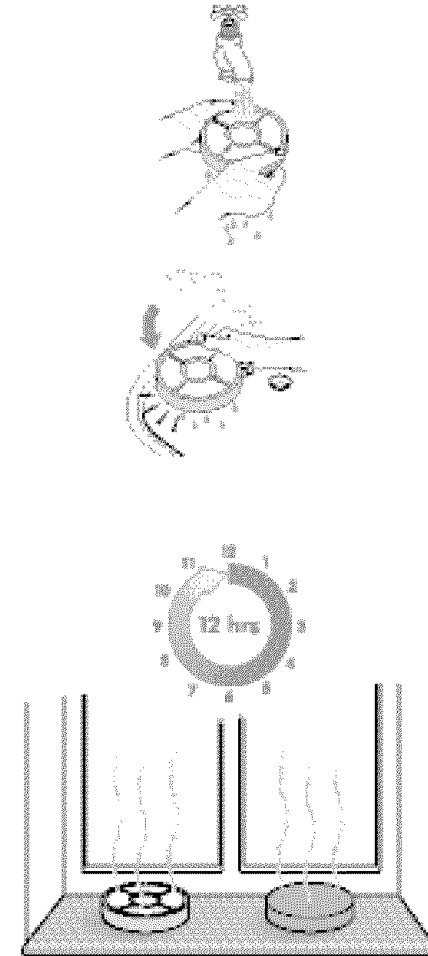

Wash filter and case until water runs clear.

Dry for at least 12 hours.

Ensure filter and case are completely dry before refitting onto the machine.

Finding blockages

⚠ CAUTION

- Turn power off and unplug before checking for blockages. Failure to do so could result in electric shock or personal injury.

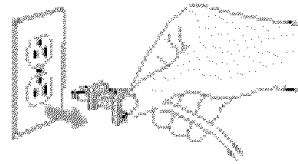

- If any part of your machine becomes blocked, it may overheat and then automatically shut off. Unplug machine and leave to cool down.

Please note: Clearing blockages is not covered by your machine's limited warranty.

Beware of sharp objects when clearing blockages.

Replace all parts of the machine before using it.

If you hear a loud ratchet noise it means the brushbar is obstructed.

Disconnect the machine before removing the obstruction.

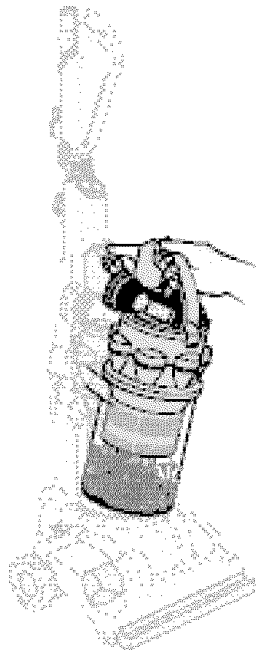
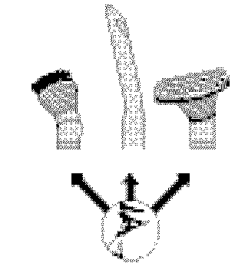

Check tools are clear of blockages.

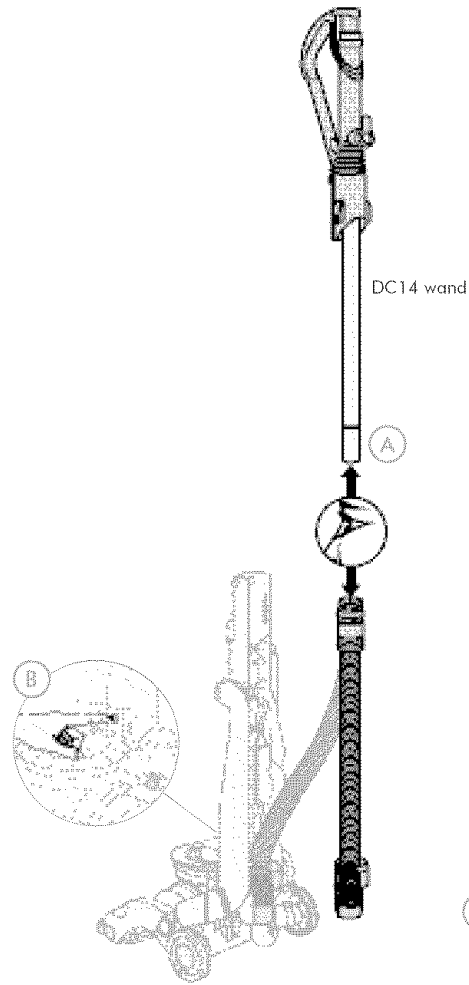

- A** Release wand from vacuum by pressing hose button and sliding hose off wand. Check inside wand and hose for blockages.
- B** Press hose release button at front of machine and slide hose out with lower cord hook at rear.

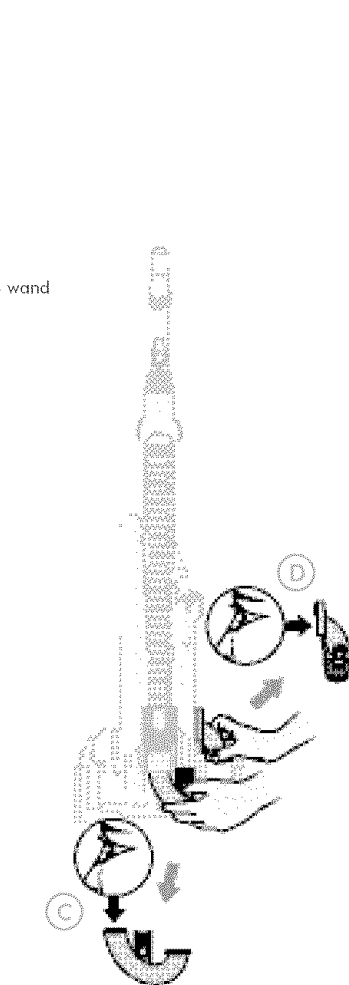

- U bend inspection**
- C** Tilt machine forward, slide out U bend and check inside for blockages.
- Airway inspection**
- D** Squeeze valve release buttons and check inside for blockages.

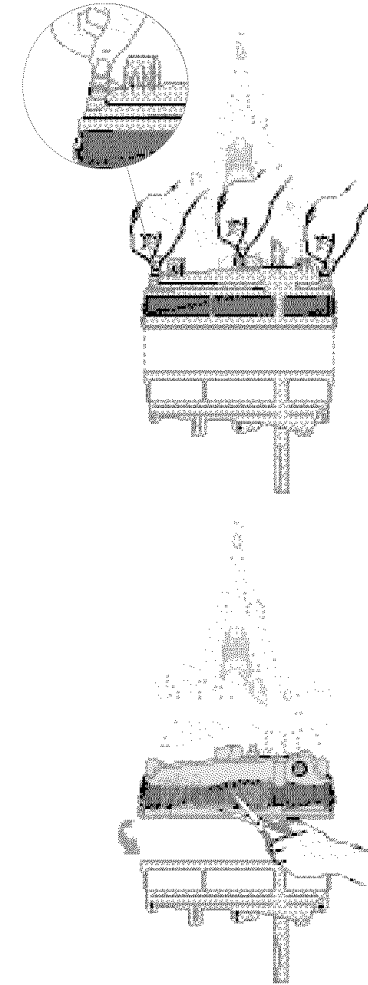

- Brushbar obstructions**
- Lie cleaner on its front.
- Undo soleplate fasteners using a coin and remove soleplate.
- Remove lint and hair from brushbar.
- Replace soleplate and tighten fasteners.
- Ensure soleplate is fitted correctly when replacing.

Finding blockages

Important safety instructions

Important safety instructions

Changing/fitting the belt

Important safety instructions

Important safety instructions

Changing/fitting the belt

CAUTION

- Turn power off, unplug machine and allow machine to cool for 1 hour before changing/fitting belt. Failure to do so could result in electric shock or personal injury.

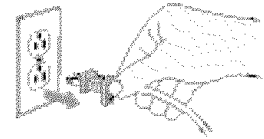

- Ensure soleplate is in correct position before use.
- Make sure all parts have been replaced securely before using your machine.

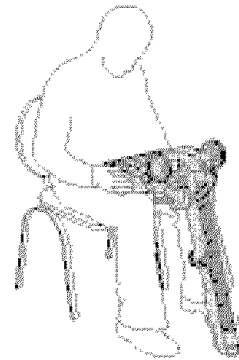

Remove wand and turn machine upside down.

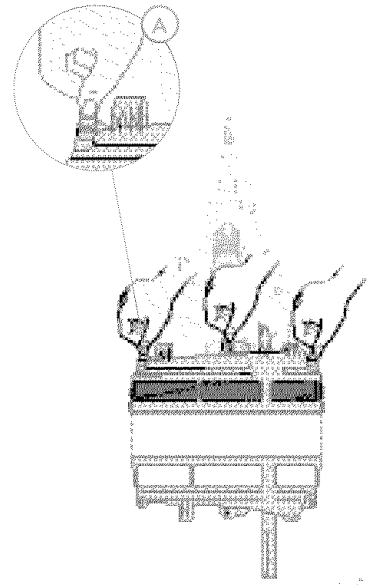

A Undo fasteners using a coin, slide back end caps and remove soleplate.

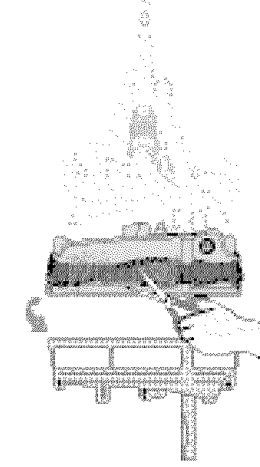
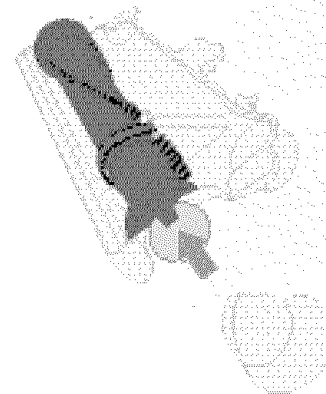

B Remove dirt or debris and check spindle is clean.

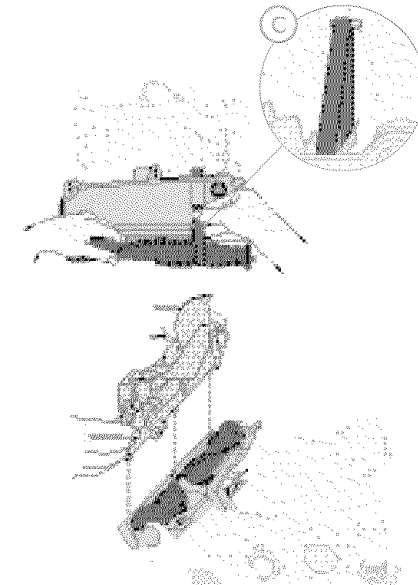
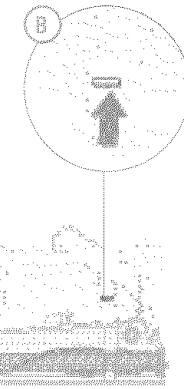

C To replace the belt, remove the brushbar, loop belt around brushbar and feed through hole.



D Check end caps are in place.

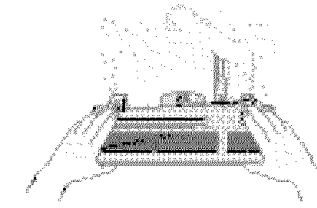

Changing/fitting the belt

CAUTION

- Ensure soleplate is in correct position before use.

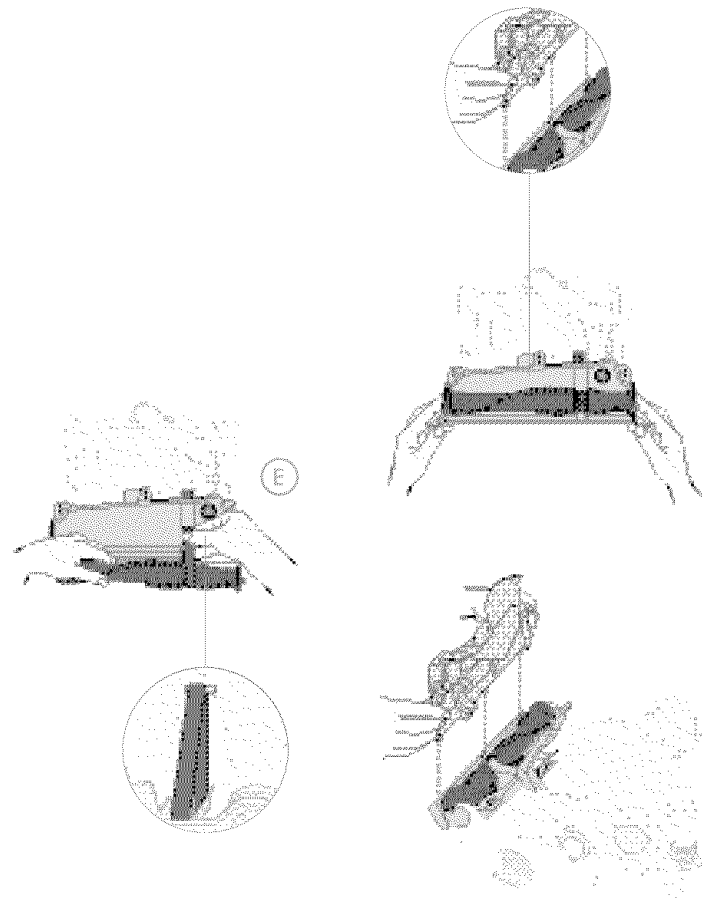

E Use back of cleaner as lever, loop belt around thumb. Turn the belt 90 degrees, stretch and release over spindle.
Belt must be free of twists as shown.

F Rest the three tabs on inside of yellow bumper strip and secure soleplate back into position.
G Ensure soleplate is in correct position before use.

Optional: maintaining the Upholstery tool

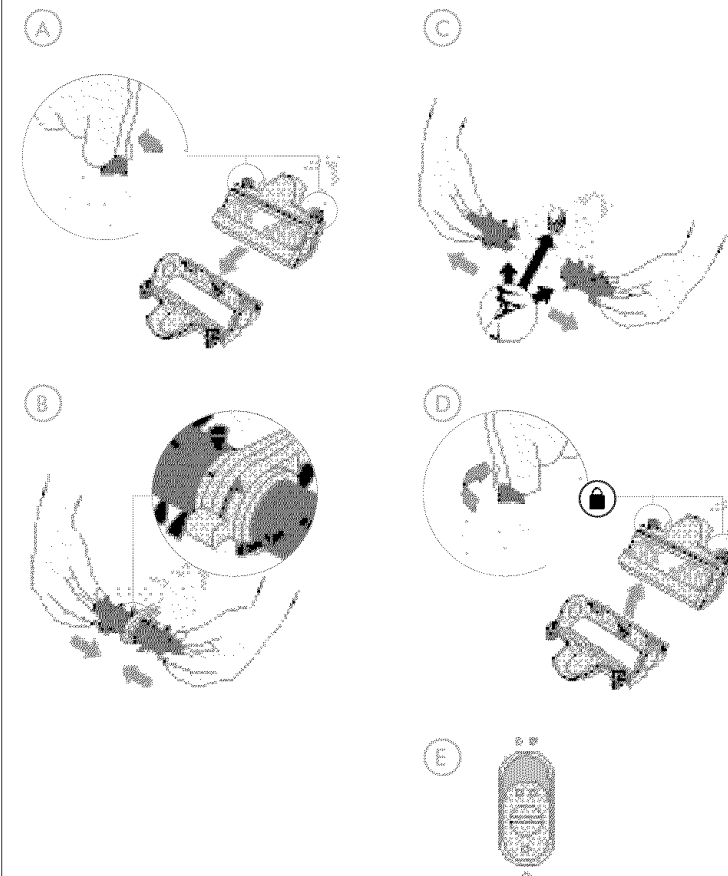

Optional: Upholstery tool
A Release catches and remove the soleplate.
B Remove both brushbars and clear away thread and hair.

C To reassemble, match the arrows on the brushbar to the arrows on central support.
D Align front of soleplate with front of tool and secure all 3 catches.
E Ensure slider is set as shown.

Changing/fitting the belt

Important safety instructions

Important safety instructions

Dyson customer care

Important safety instructions

Important safety instructions

Dyson customer care

CAUTION

If you have a question about your Dyson, call the Dyson helpline with your serial number (found underneath your machine).

Important Information

Check that your electricity supply corresponds to that shown on the rating plate. The machine must be used as rated.

If the supply cord or the appliance is damaged, disconnect from the electric outlet immediately. The supply cord must be replaced by Dyson, Inc or our appointed agent to avoid a hazard.

This appliance is not intended for use by young children or infirm persons without supervision.

Young children should be supervised to ensure that they do not play with the appliance.

Do not use the vacuum cleaner if the cord or plug are damaged or if the cleaner has been damaged, dropped or has come in to contact with water or any other liquid. In these cases, contact the Helpline.

When vacuuming, certain carpets may generate small static charges in the clear bin.™ These are entirely harmless and not associated with the main supply. To minimise any effect from this, do not put your hand or insert any object in to the clear bin unless you have emptied it and

rinsed it out with cold water.

Do not use the vacuum cleaner if any parts appear to be faulty, missing or damaged.

Do not carry out any maintenance work other than that shown in this manual or advised by the Helpline and do not put anything in to the openings or moving parts of the machine.

Only use parts recommended by Dyson; failure to do so could invalidate your warranty.

European conformity information

A sample of this product has been tested and found to be in conformity with the following European Directives: 73/23/EEC Low voltage (safety) Directive, 93/68/EEC CE Marking Directive, 89/336/EEC EMC Directive.

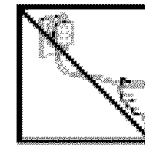

Do not pull on the cord.



Do not place on stairs above you.



Do not put your hands near the brushbar when in use.



Do not use near open flame.

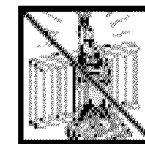

Do not leave cleaner near heat sources.



Do not pick up water or liquids.

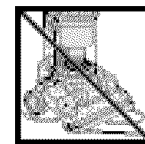

Do not run over the cord.



Do not pick up burning objects.

Dyson Customer Care

Every new Dyson vacuum cleaner has a 2 year limited warranty.

If you have a question about your Dyson, call the Dyson Customer Helpline with your serial number and details of where/when you bought the cleaner.

Most question can be solved over the phone by one of our trained Helpline staff.

If your cleaner needs further attention, we aim to have it repaired and tested within 3 working days.

Your serial number can be found on your rating plate which is underneath the machine beneath the wheels.



Note your serial number for future reference:

DC14 accessories

The items can be used with your DC14. For further information visit the Dyson website www.dyson.com

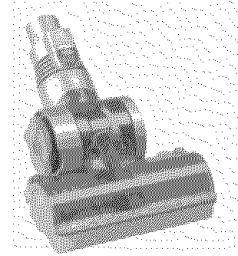

Mini Turbine Head

Improved Turbine head removes dirt from upholstery and stairs.

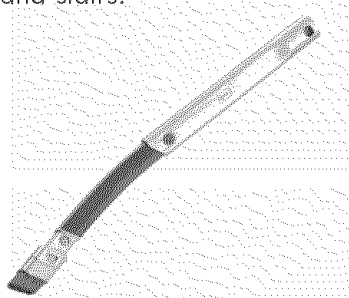

Flexi crevice tool

Extends and flexes to clean awkward gaps.

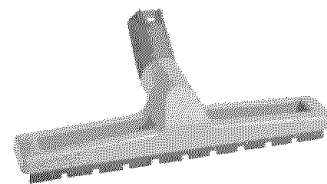

Bare floor tool

Long bristled tool prevents damage to delicate floors.

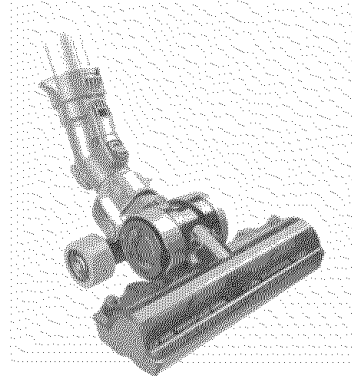

Low reach clean air Turbine head

Powerfully cleans hard to reach places including

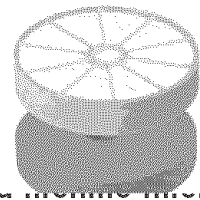

Extra cleaning filter

To replace your filter while it is being washed so you are never without your Dyson.

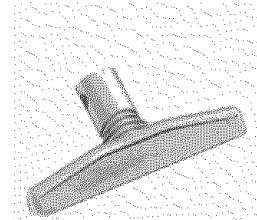

Mattress cleaning tool

Picks up dust from your mattress, comforter and cushions.



Cleaning Pack

1. Groomer

Long bristles work zorb carpet maintenance powder deep into carpets.

2. Zorb carpet maintenance (750g)*

Millions of tiny sponges absorb dirt from the carpet, to keep new carpets looking new with none of the drawbacks of wet cleaning.

3. Dyzolv spot cleaner (230ml)*

Contains 4 active agents to clean spots and spills e.g grease, food, drinks and soil. Ideal for wool and stain resistant carpets and rugs.

* Items not approved by British Allergy Foundation

Dyson customer care

Important safety instructions

Important safety instructions

Warranty and customer care

2 year limited warranty

Household use

Your Dyson vacuum cleaner is warranted against original defects in material and workmanship for a period of two years from date of purchase, when used only for private household purposes and in accordance with the Owner's Manual. This warranty provides, at no cost to you, all labor and parts to place your vacuum cleaner in proper operating condition during the warranty period.

For further details of the warranty including limitations and exclusions, and to register your purchase, please refer to the product registration form found in your instruction pack.

Dyson customer care

If you have a question about your Dyson vacuum cleaner, call the Dyson Helpline at **1-866-693-9766** with your serial number and details of where/when you bought the cleaner. The serial number can be found on the base of your machine between the wheels.

Most questions can be solved over the phone by one of our Helpline staff.

If your cleaner needs service, call the Dyson Helpline we will discuss with you the options available for service. If your machine is under warranty, your machine will be repaired at no cost. To reach the Dyson Helpline call at **1-866-693-9766**, or visit Dyson online at www.dyson.com.

Important safety instructions

Servicing of double insulated appliances

A double insulated appliance is marked with one or more of the following: The words "DOUBLE INSULATION" or "DOUBLE INSULATED" or the double insulation symbol (square within a square).



In a double insulated appliance, two systems of insulation are provided instead of grounding. No grounding means is provided on a double insulated appliance, nor should a means for grounding be added to the appliance. Servicing a double insulated appliance requires extreme care and knowledge of the system, and should be done only by qualified service personnel.

Replacement parts for a double insulated appliance must be identical to the parts they replace.

Important safety instructions

This product is protected by the following intellectual property rights:

Patent/Patent Application numbers:

US10/468,870; JP2002-567124; EP1361812; AU2002-567124; GB2393383; PCT/GB2003/004058; PCT/GB2003/003928; AU744408; EP1119282; JP2000-575411; US6,519,807; AU2002231965; EP1361813; JP2002-567126; US10/468,653; AU744362; EP1121043; JP2000-575409; US6,572,078; AU757043; EP1052923; JP2000-523902; US6,691,849; GB0326102.1; AU2002-226556; EP1370172; JP2002-567120; US10/468,676; AU2002-225207; EP1361814; JP2002-567129; AU2001-240894; EP1268076; GB2360719; JP2001-572220; US10/239,426; AU2002-225232; EP1361815; GB2372435; JP2002-567134; US10/468,304; GB2372436; AU637 272; EP0636338; JP1 948 863; US5,078,761 REGISTERED DESIGNS AND DESIGN APPLICATIONS AU154578; EP000090865; GB3012888; JP2003-34801; US29/193,623; GB3015739

Please note: Small details may vary from those shown.