

PERFORMANCE
SERIES™

Char-Broil
KEEPERS OF THE FLAME



ASSEMBLY MANUAL
463450805

**THIS GRILL IS FOR
OUTDOOR USE ONLY**

CAUTION: Read and follow all safety statements, assembly instructions and use and care directions before attempting to assemble and cook.

INSTALLER/ASSEMBLER:
Leave these instructions with consumer.

CONSUMER: Keep this manual for future reference.

▲ WARNING

Failure to follow all manufacturer's instructions could result in serious personal injury and/or property damage.

▲ CAUTION

Some parts may contain sharp edges - especially as noted in the manual! Wear protective gloves if necessary.

If you have any questions or need assistance during assembly, please call 1-800-241-7548.

Visit us on the web at:
www.charbroil.com

PRECISION GRILLING TECHNOLOGY

Necessary tools for assembly of your grill is a Phillips head screwdriver. CAUTION: When using a power screwdriver set it to low torque.

Size and type of hardware used in assembly of your grill may vary, but will not affect grill integrity,

“NEW”

T. L. M. - Torque Locking Method

①

②

③

Screw + Thru Part + Formed Lock = **Solid Lock Cart Structure**

- The cart assembly utilizes the new T.L.M. fastening method.
- No need for the old style “Bolt & Nut” combination

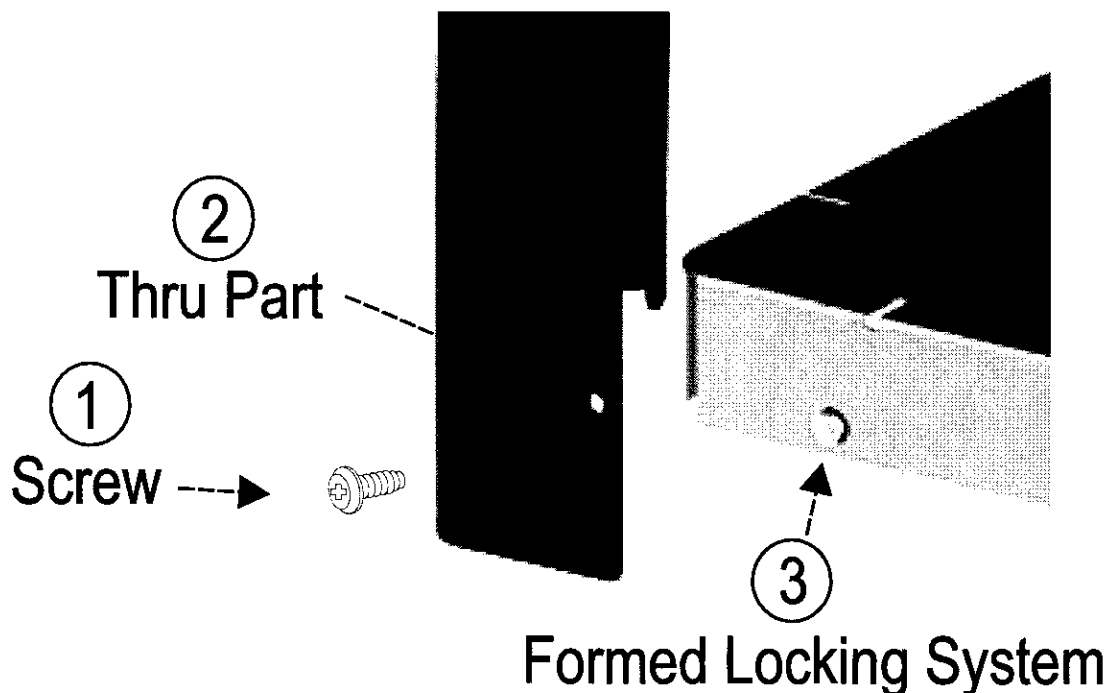

1

Items to Assemble

- 1 Long Leg Assembly
- 1 Short Leg Assembly
- 8 Screws

- A** Place bottom shelf on table or grill container.
- B** Insert tabs on long leg assembly into bottom shelf.
- C** Attach leg assembly with one screw on each side.
- D** Repeat step B and C for short leg assembly.

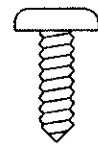

Qty: 8

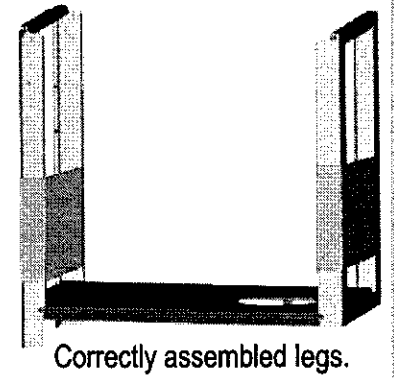
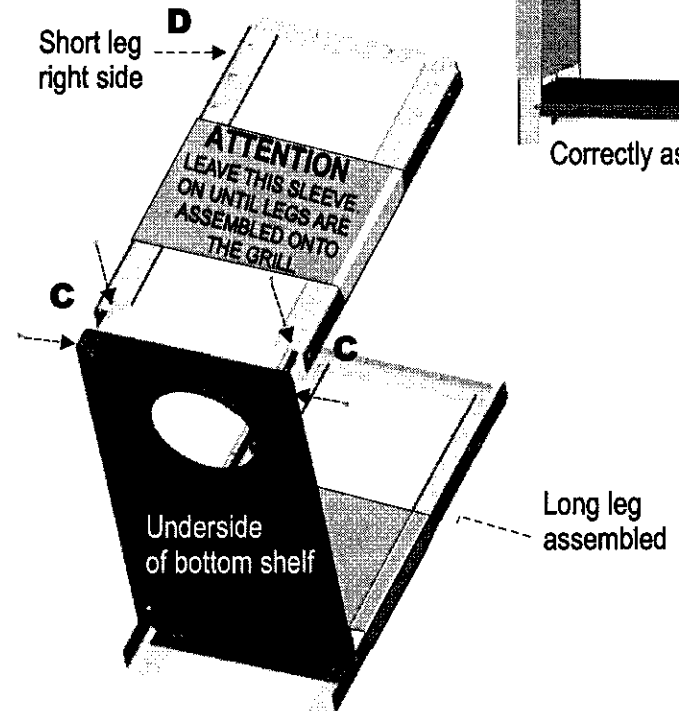
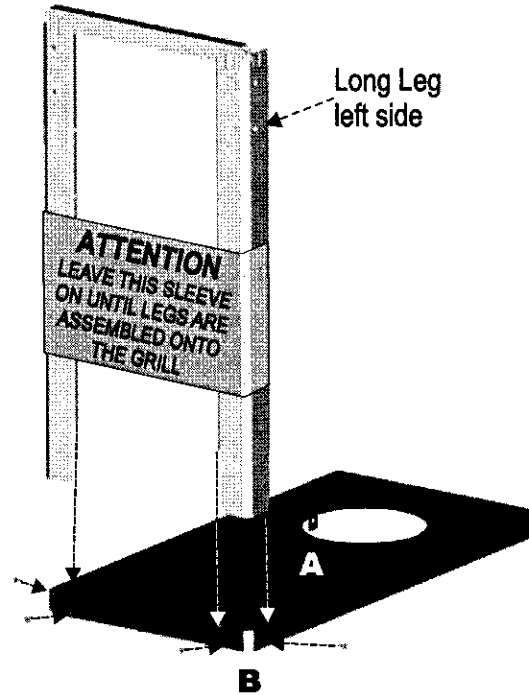

2

Items to Assemble

- 2 Wheels
- 1 Axle Rod
- 2 Washer Head Screw
- 1 U-Nut
- 1 Tank Thumbscrew
- 1 Flanged Hex Nut
- 2 Leg Extenders

CAUTION: Ends of screws have sharp points

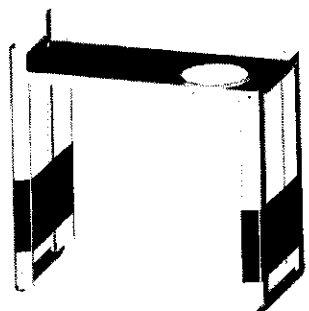

Turn cart upside down

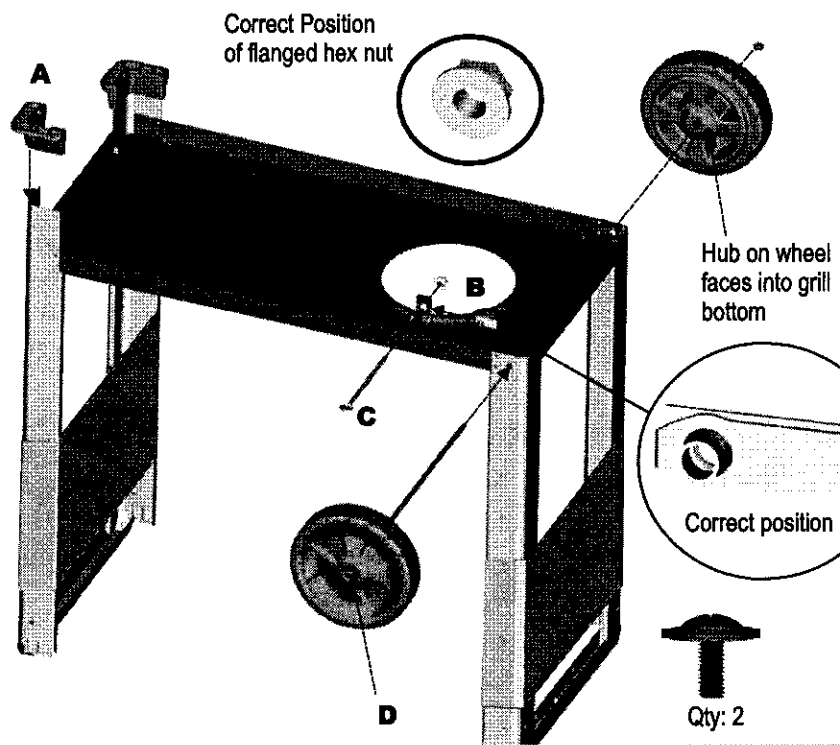

- A** Attach leg extenders. Check to make sure leg extender is seated all the way into the leg.
- B** Attach u-nut to tab. See enlargement of u-nut for correct position.
- C** Thread tank thumbscrew into hole and u-nut. Screw flanged hex nut onto end of tank thumbscrew.
- D** Attach washer head screw to axle rod. Slide wheel on axle rod. Insert axle rod/wheel into large hole in bottom shelf. Attach other wheel and washer head screw. **Note: Hand hold axle rod to tighten washer head screw.**

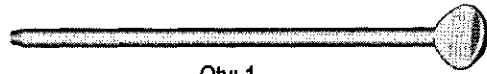

Qty: 1
Not to scale

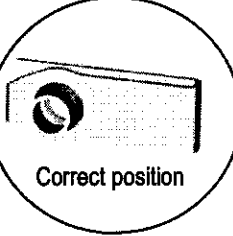

Correct position



Qty: 1



Qty: 2



Qty: 1
Not to scale

Stand cart upright and remove cardboard sleeves

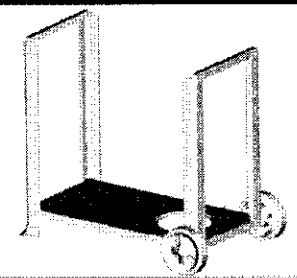

3

Items to Assemble
4 Rails (all identical)
10 Screws

A Overlap rails and hook tabs into slots. Pull rails to latch
B Attach rail and legs with two screws in each corner.
C Attach one screw in center of each rail.

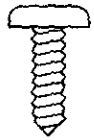

Qty: 10

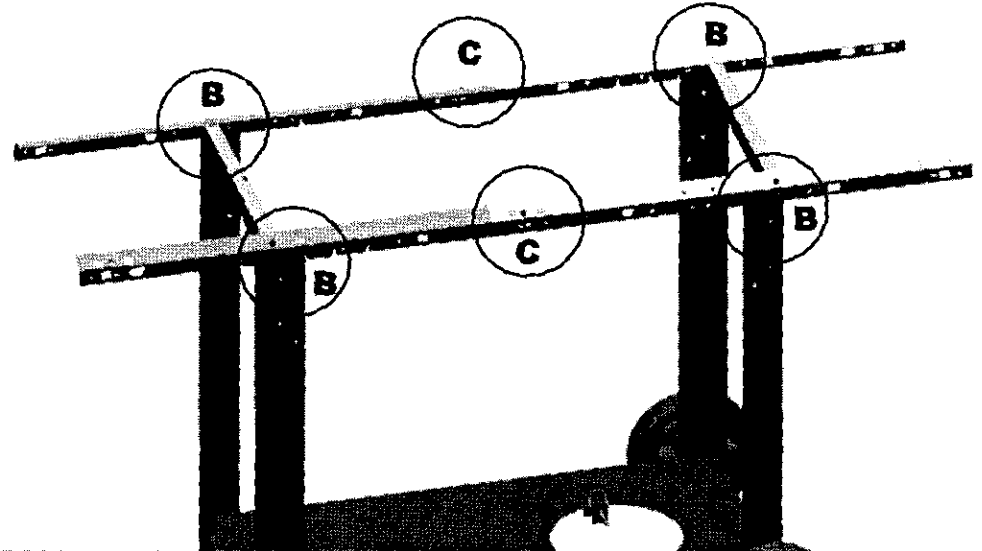
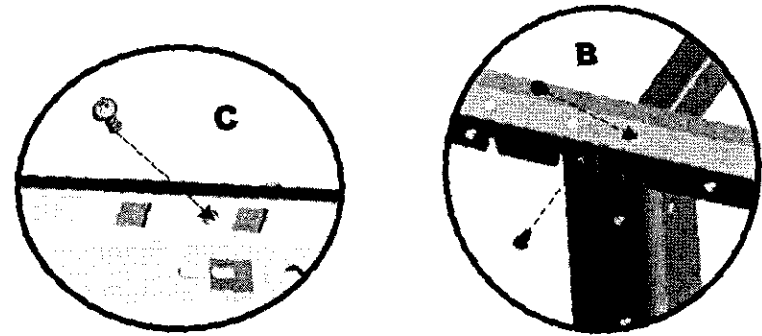
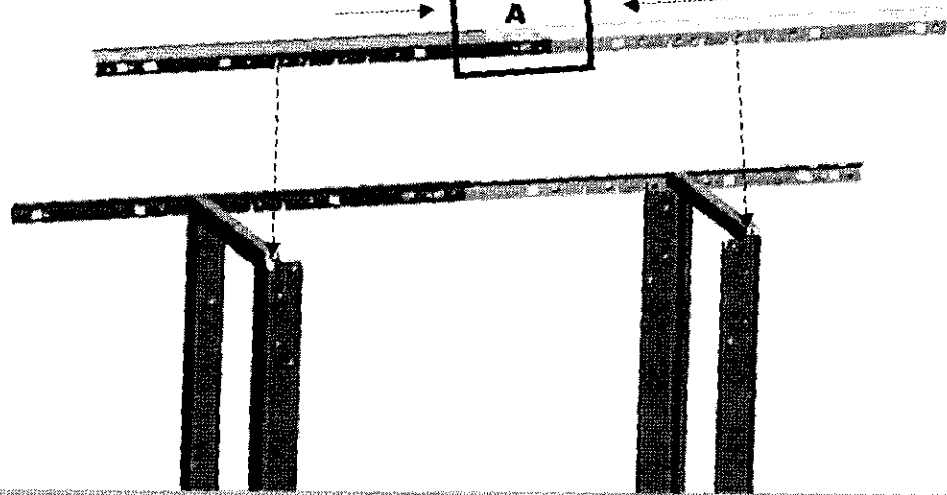
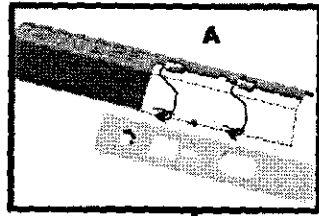

© 2008 The Home Depot. All rights reserved. Home Depot is a registered trademark of The Home Depot. Home Depot is not responsible for any damage to property or injury to persons resulting from the use of this information.

© 2008 The Home Depot. All rights reserved. Home Depot is a registered trademark of The Home Depot. Home Depot is not responsible for any damage to property or injury to persons resulting from the use of this information.

4

Items to Assemble

1 Front Panel

2 Push Pins

A Place tabs on front panel beside leg tabs.

B Insert push pins into front panel and legs.

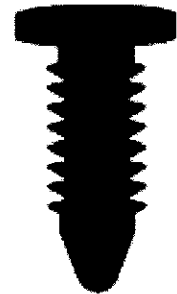

Qty: 2

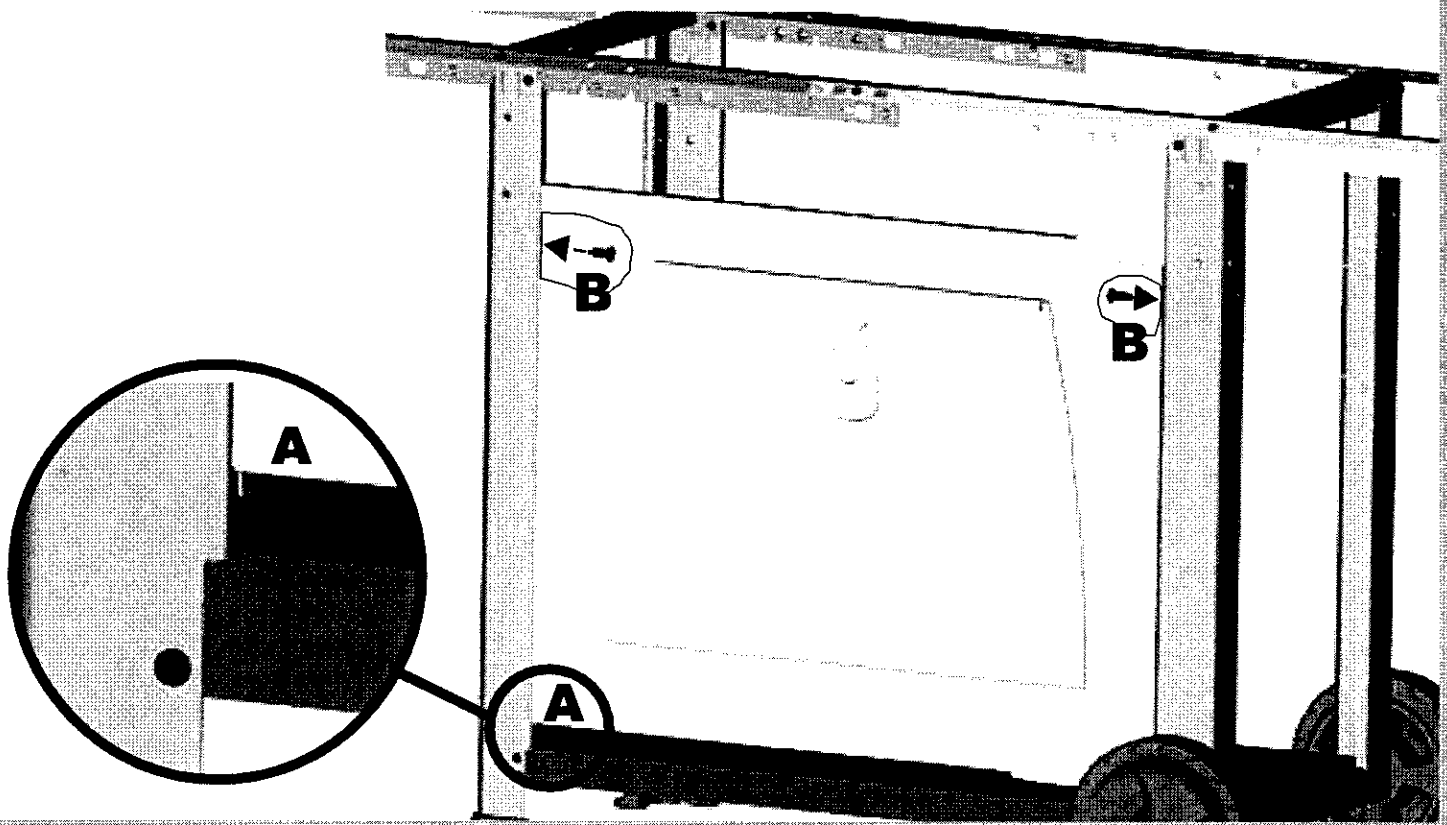

5

- Items to Assemble
1 Hose Heat Shield
1 Screw

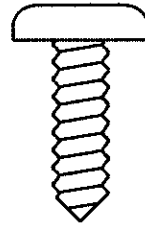

Qty: 1

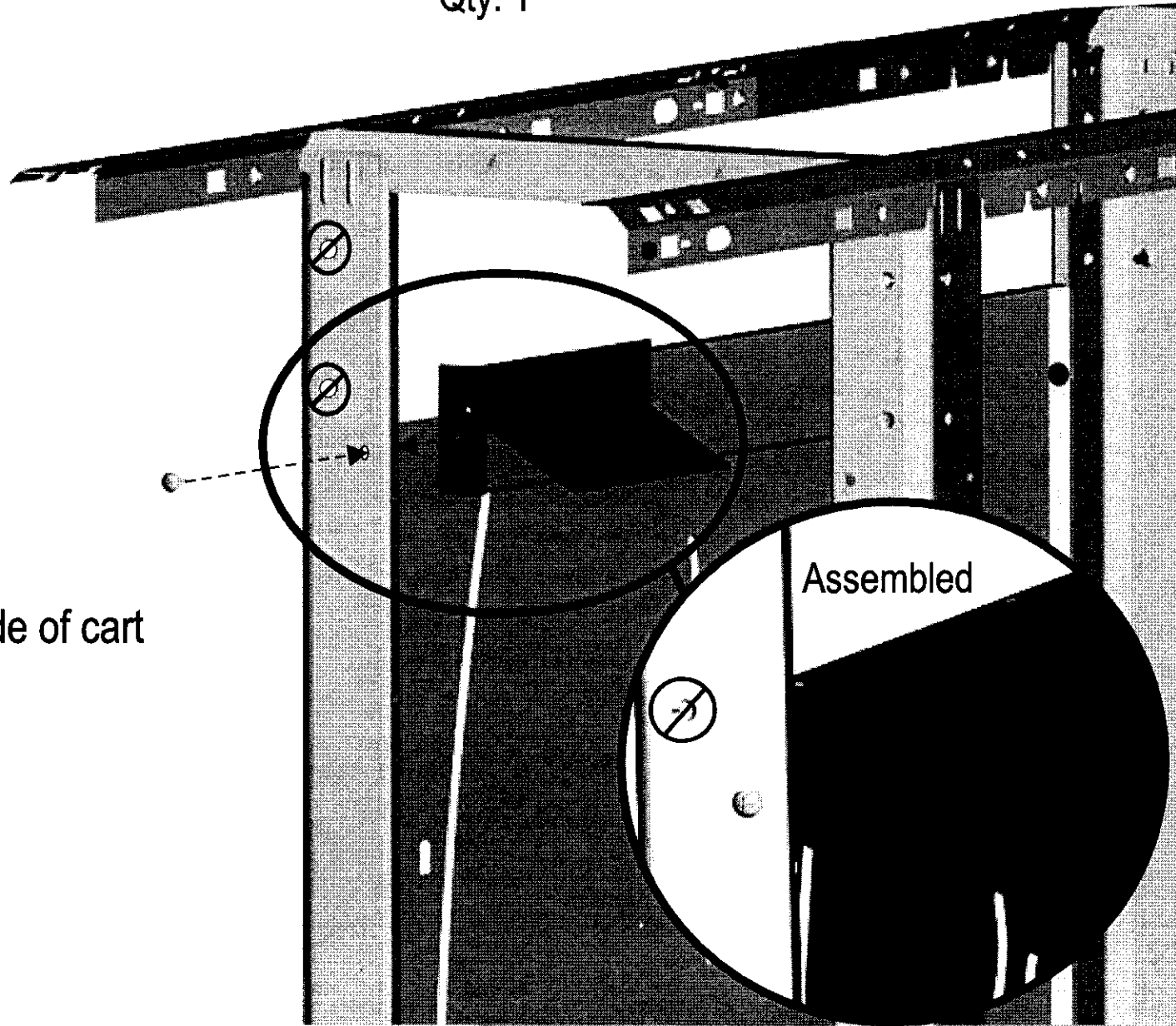

Right side of cart

Assembled

6

Items to Assemble

1 Condiment Basket

1 Push Pin

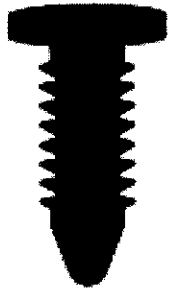

Qty: 1

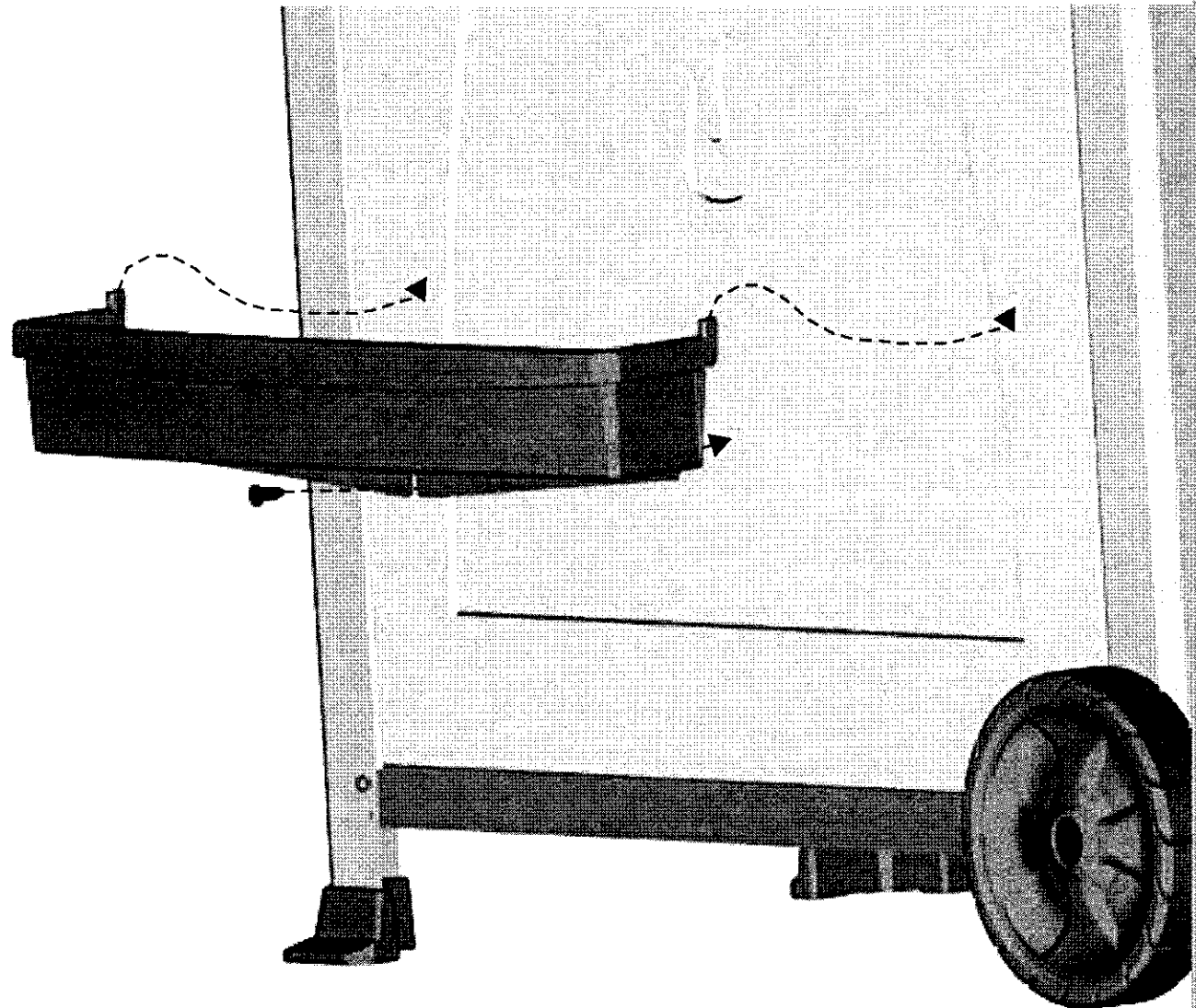

7

Items to Assemble
1 Grill Bottom Assembly
4 Screws

- A** Angle grill bottom assembly around and under the rails.
- CAUTION: Be careful not to dislodge burner tubes.**
- B** Make sure ribs on each side of bottom casting are nestled into notches on casting seat.
- C** Attach four screws inside grill bottom and into casting seat.

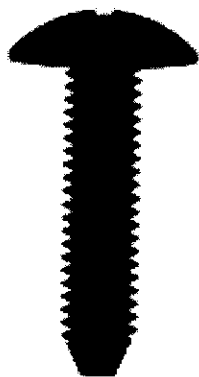

Qty: 4

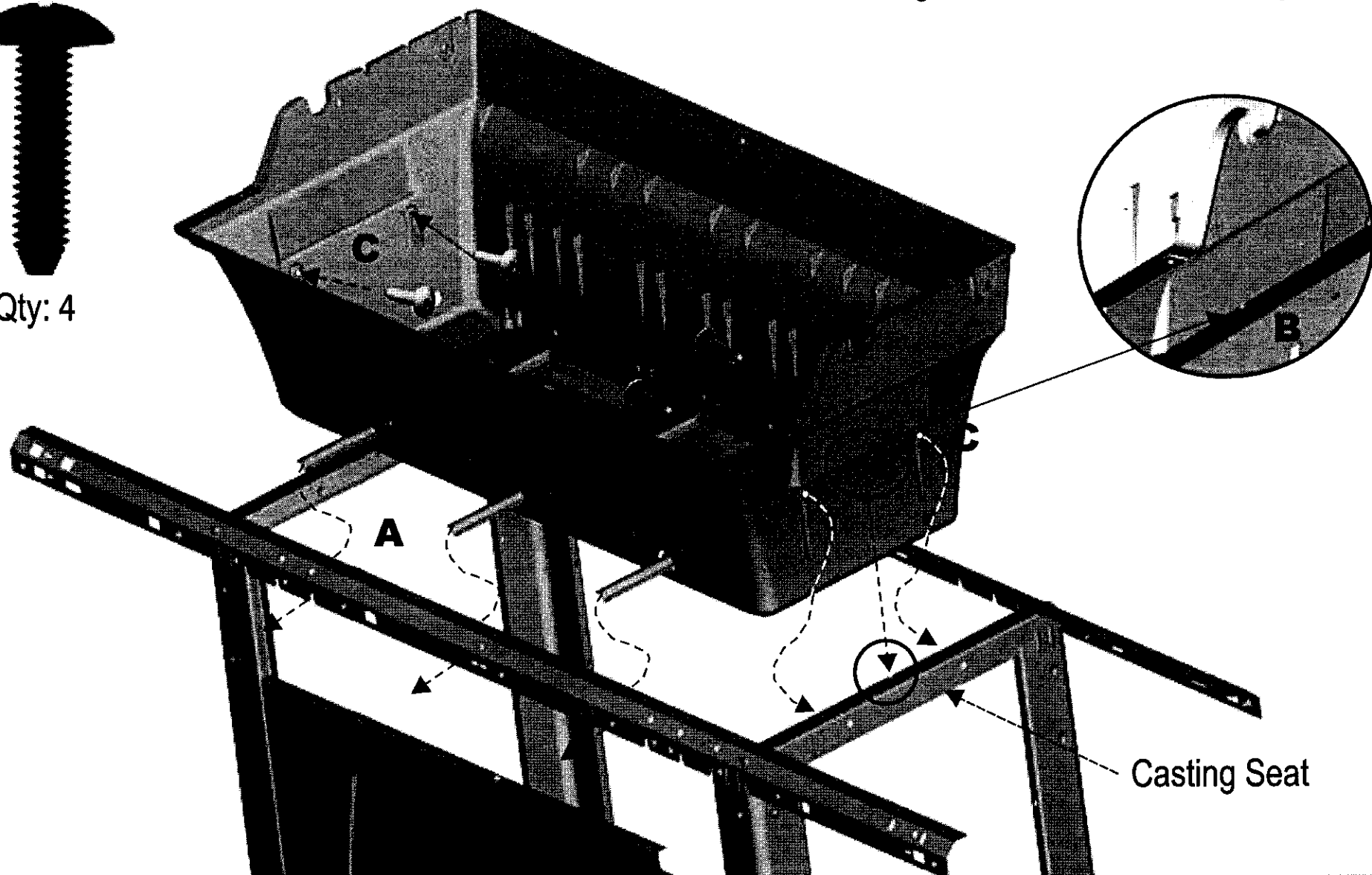

8

Items to Assemble

1 Electrode w/Wing Nut or Nut

A Inside bottom casting insert electrode and finger tighten with wing nut or nut.

View of electrode attached and aligned with a porthole in the burner.

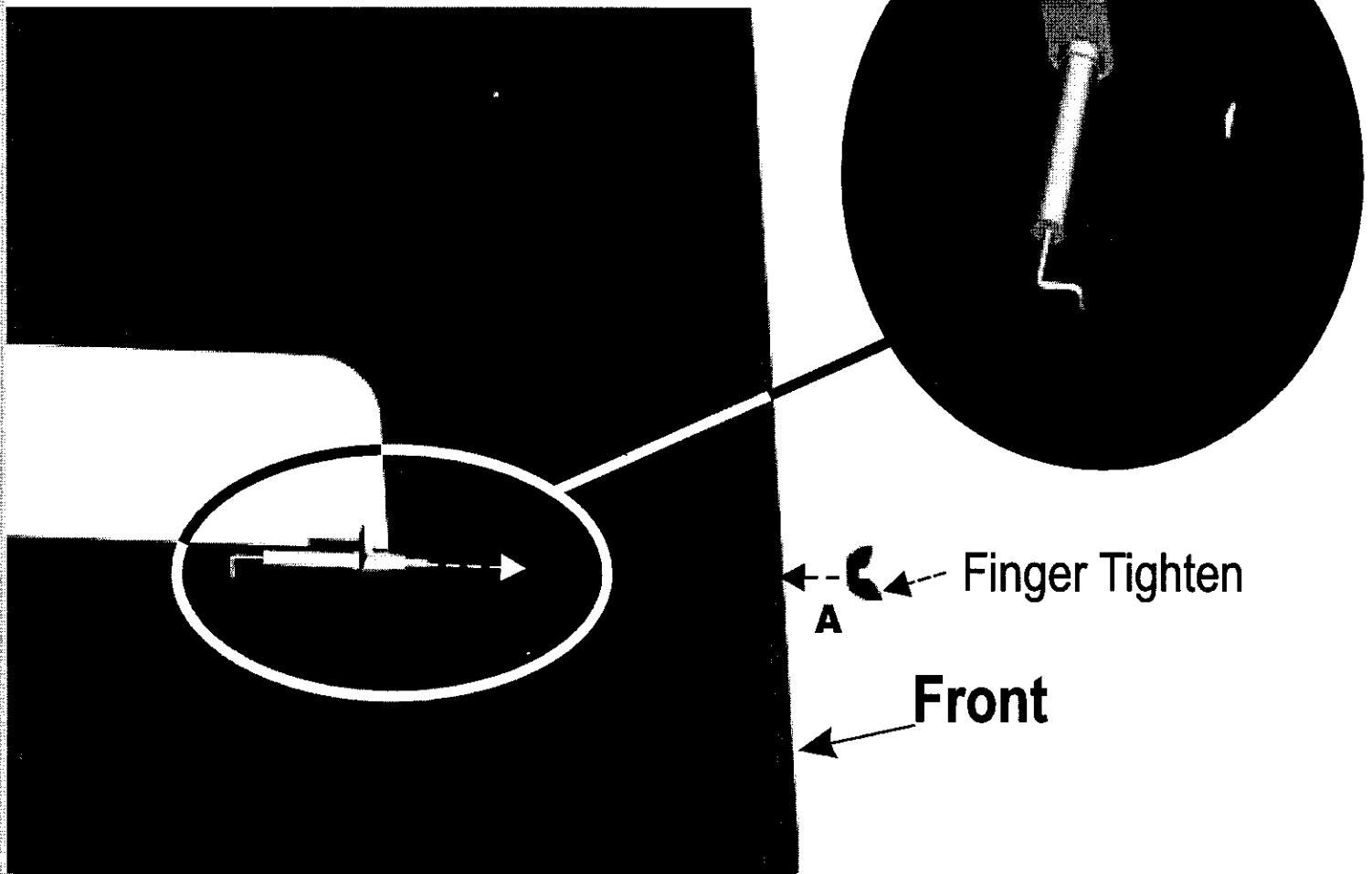

9

Items to Assemble
1 Console Assembly
3 Screws

Loosen long wire and place behind front panel. Do not connect at this time.

- A** Hold control panel close to bottom casting. Attach short ignitor wire to electrode.
- B** Insert regulator into opening in front panel.
- C** Position valves into burner tubes (see burner-valve view). Rotate control panel up and rest flange over rail.
- D** Attach control panel to legs with a screw in top hole. On the right side attach a screw in second hole.

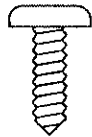

Qty:3

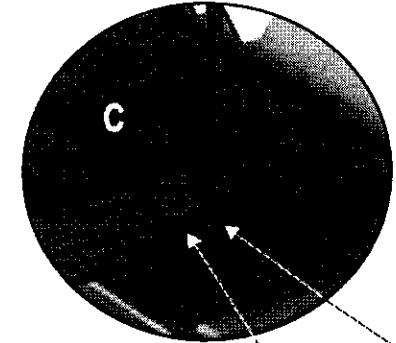
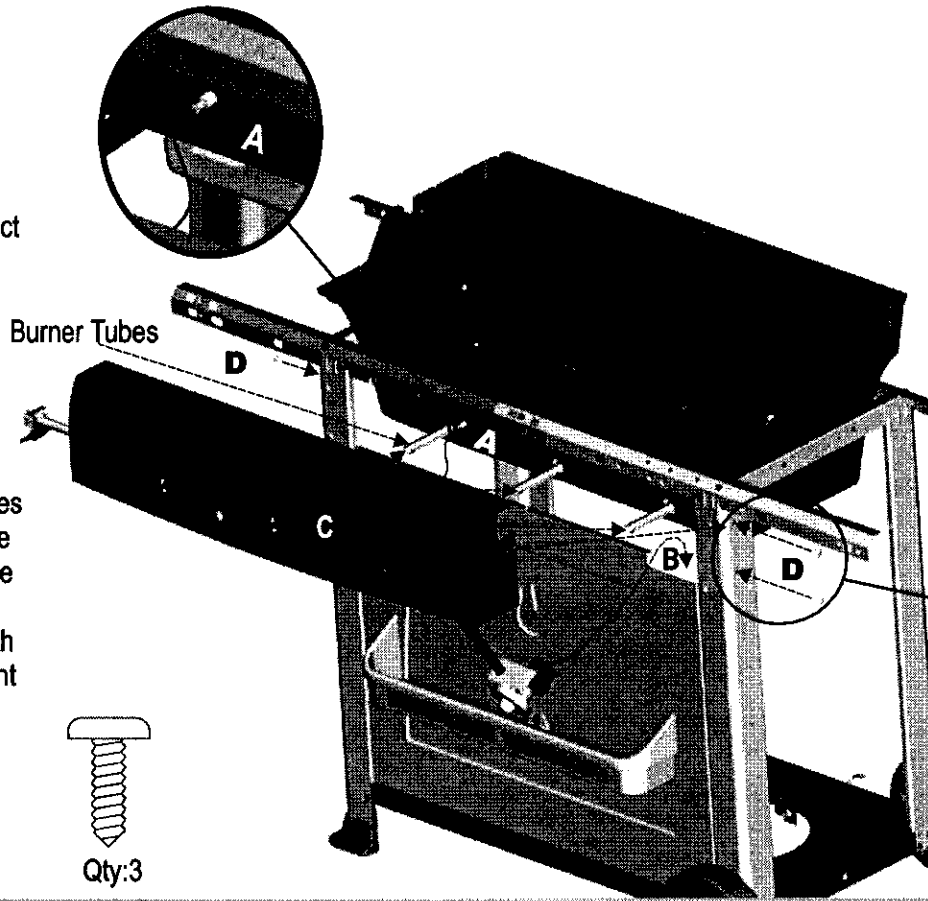

Correctly assembled burner tube and valve.

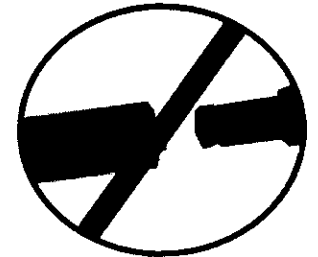
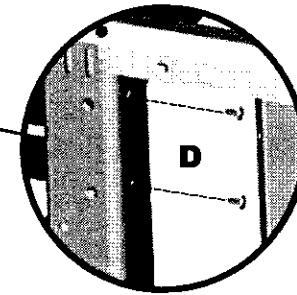

10

Items to Assemble
1 Shelf

- A** Shows a close up of the rectangle hole that holds the shelf in place. Slide side shelf onto rails until it is fully secured.
- B** Shows shelf properly attached.

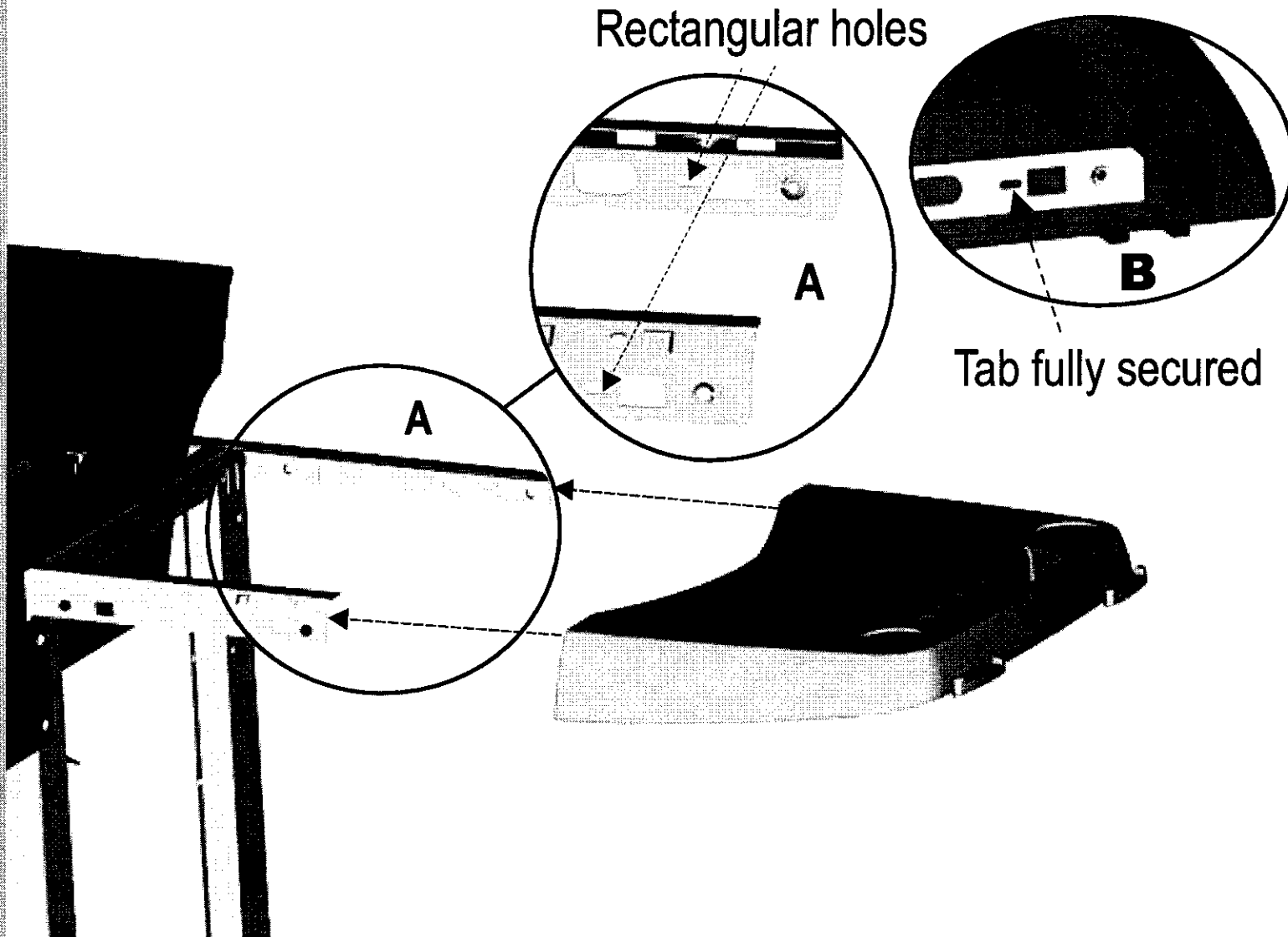

11

Items to Assemble

- 1 Sideburner Assembly
- 4 Screws
- 1 Sideburner Burner
- 1 Wing Nut
- 1 Sideburner Grate

- A** Slide sideburner assembly onto rails. Attach with 4 screws.
- B** Insert sideburner burner into sideburner assembly. Make sure valve fits into tube before attaching wing nut to sideburner burner.
- C** Place sideburner grate onto sideburner assembly.

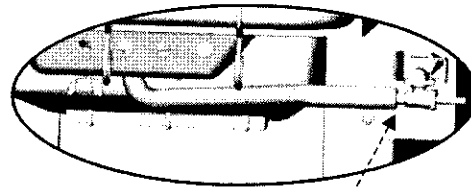

Sideburner tube and valve properly engaged.

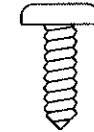

Qty: 4

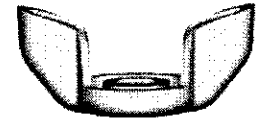

Qty: 1

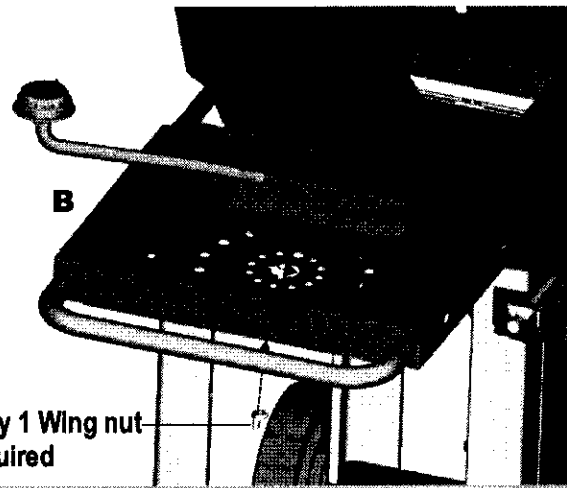
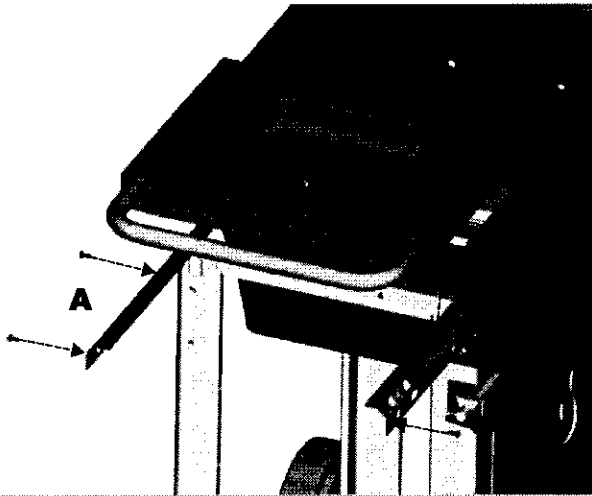

Only 1 Wing nut required

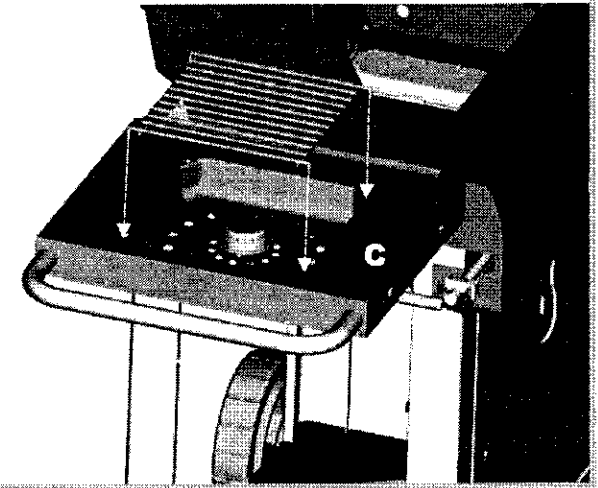

12

Items to Assemble

- 1 Fascia
- 1 Screw

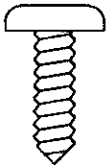

Qty:1

- A** Insert tabs on fascia into 2 slots on sideburner assembly. Fasten fascia into second hole through control panel and leg.
- B** Attach long wire from electrode ignition module to electrode beneath sideburner.

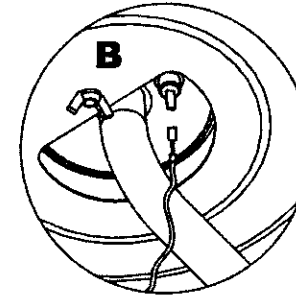

Caution:
If there is a plastic sleeve on the sideburner electrode, remove it before connecting the long wire.

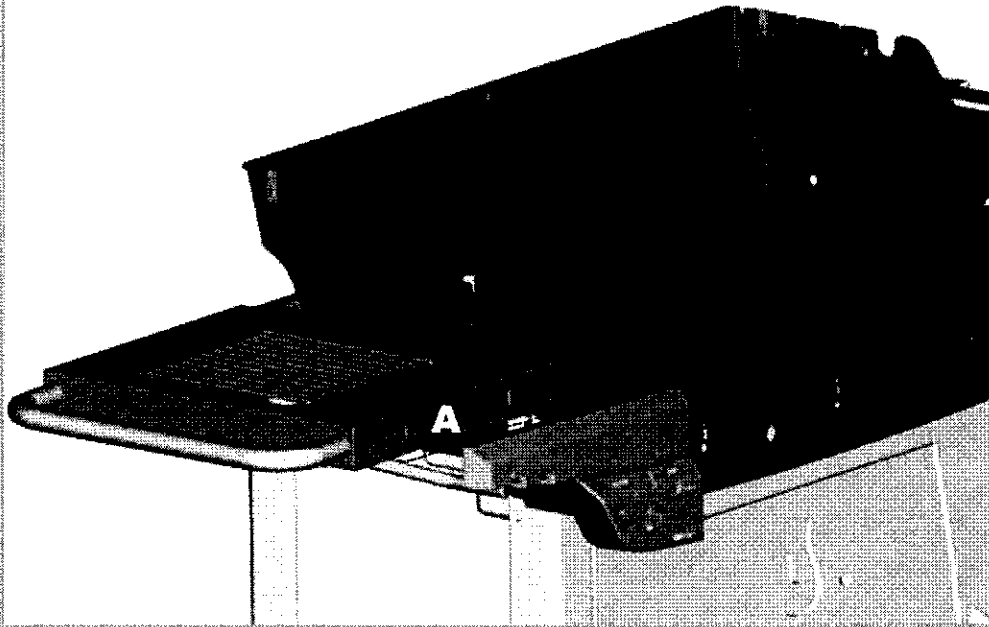

Looking underneath sideburner

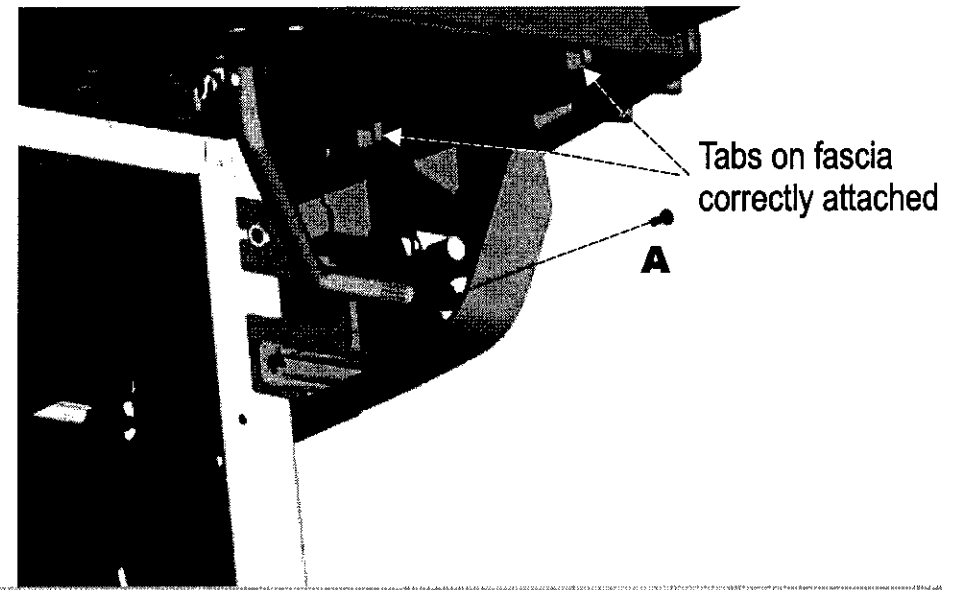

13

Items to Assemble:

- 1 Top Casting
- 2 Shoulder Bolts
- 1 Handle
- 2 Wing Nuts
- 4 Control Knobs
- 1 Ignition Button
- 1 AAA Battery

- A** Attach handle to top casting.
- B** Attach top casting with shoulder bolts.
- C** Insert + side of battery into ignitor module. Note correct position to hold ignitor button. Push on button once to engage seal.
- D** Place knobs on valve stems.

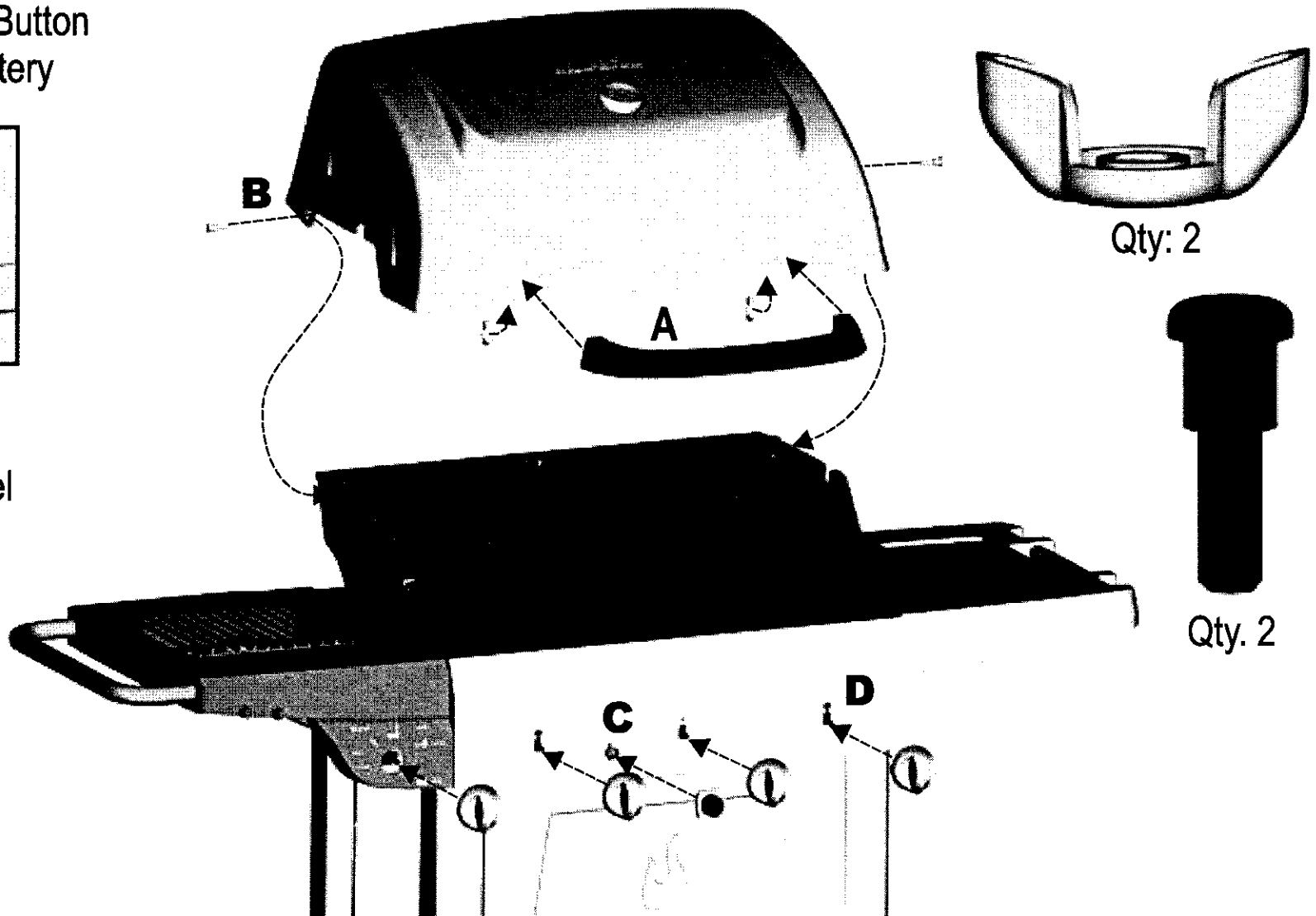
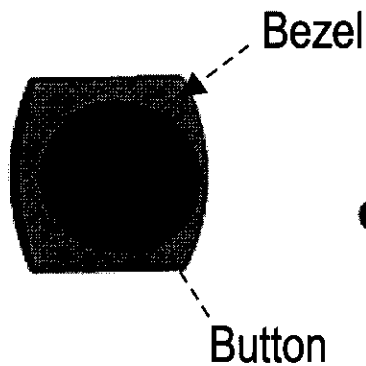
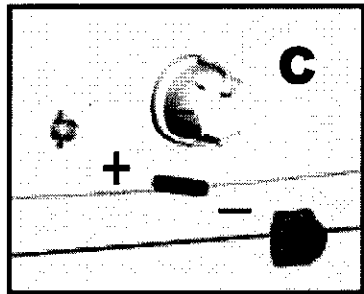

13

Items to Assemble:

3 Vaporizer Tents

3 Cooking Grids

1 Warming Rack

A Note correct position of vaporizer tents directly over burners.

B Place cooking grids as shown.

C Place warming rack in slots on bottom casting.

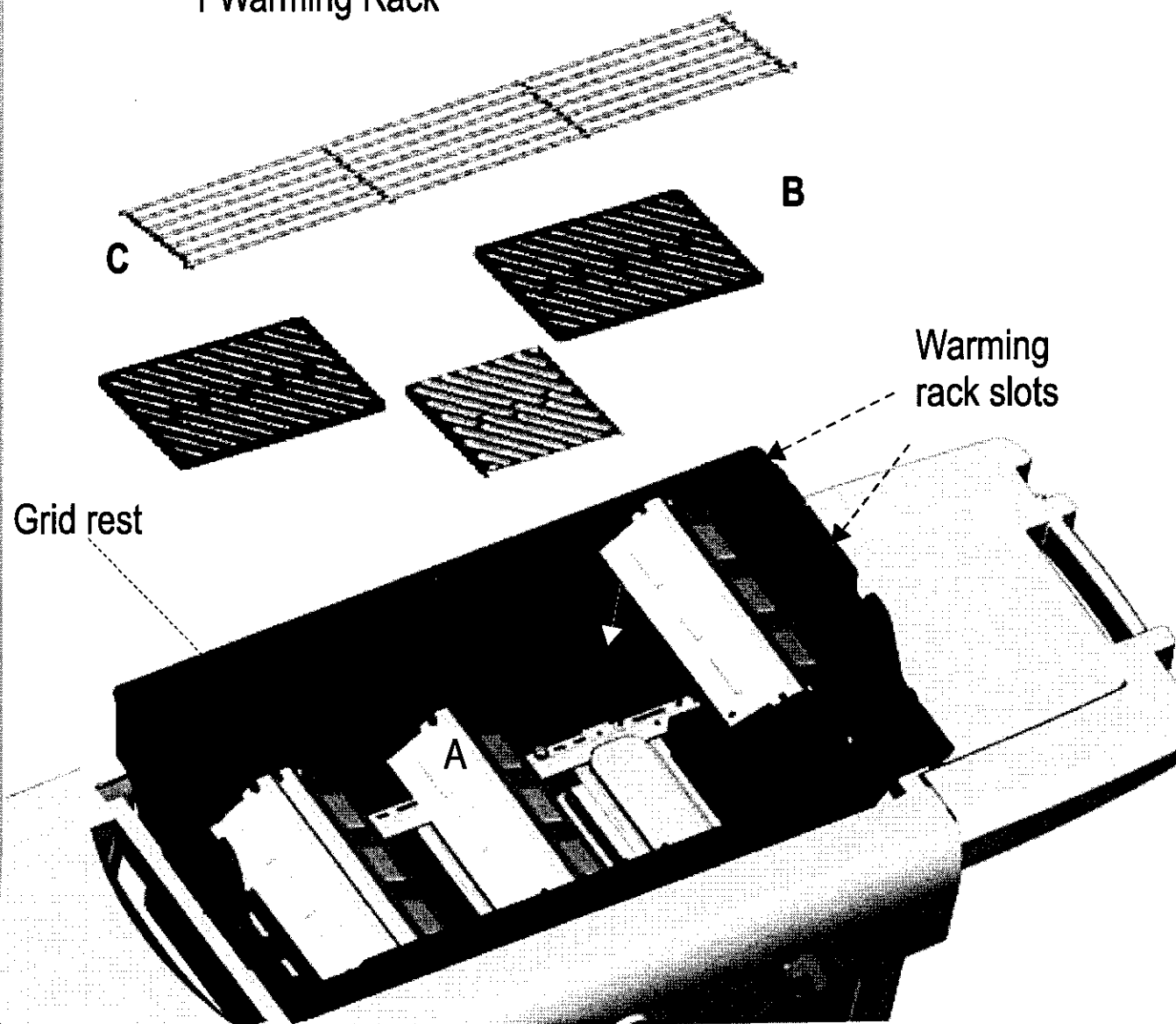

14

Items to Assemble:
1 (purchased) LP Tank

LP tank is sold separately. Use only with an (over-fill protection device) OPD equipped LP tank. Fill and leak check before attaching to grill and regulator.

Place LP tank into hole in bottom shelf. Tighten thumbscrew to hold LP tank securely in place.

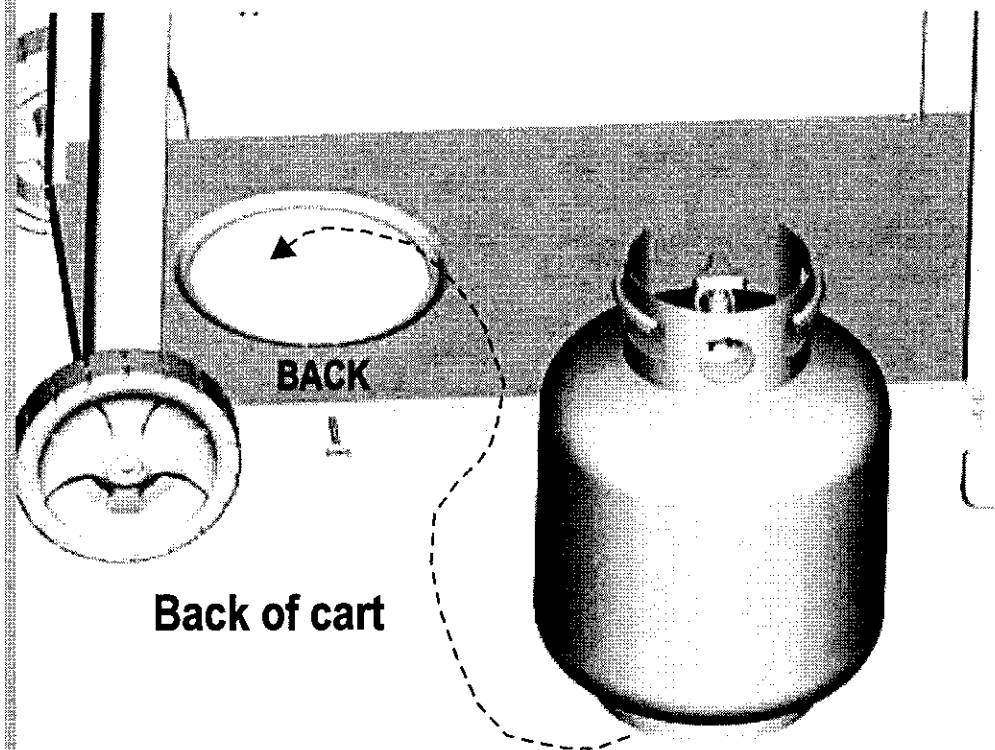

⚠ CAUTION

- Tank collar opening must face to front of cart once tank is attached.
- Failure to install tank correctly may allow gas hose to be damaged in operation, resulting in the risk of fire.

See the Use & Care manual to correctly install the LP Tank, Leak Test and do the Burner Flame Check.



15

Items to Assemble

1 Grease Tray Assembly

1 Grease Pan

- A Slide grease tray into brackets on bottom casting.
- B Slide grease pan into brackets on grease tray.

	CAUTION	
<p>Failure to install the grease tray will cause hot grease to drip from bottom of grill with risk of fire or property damage.</p>		

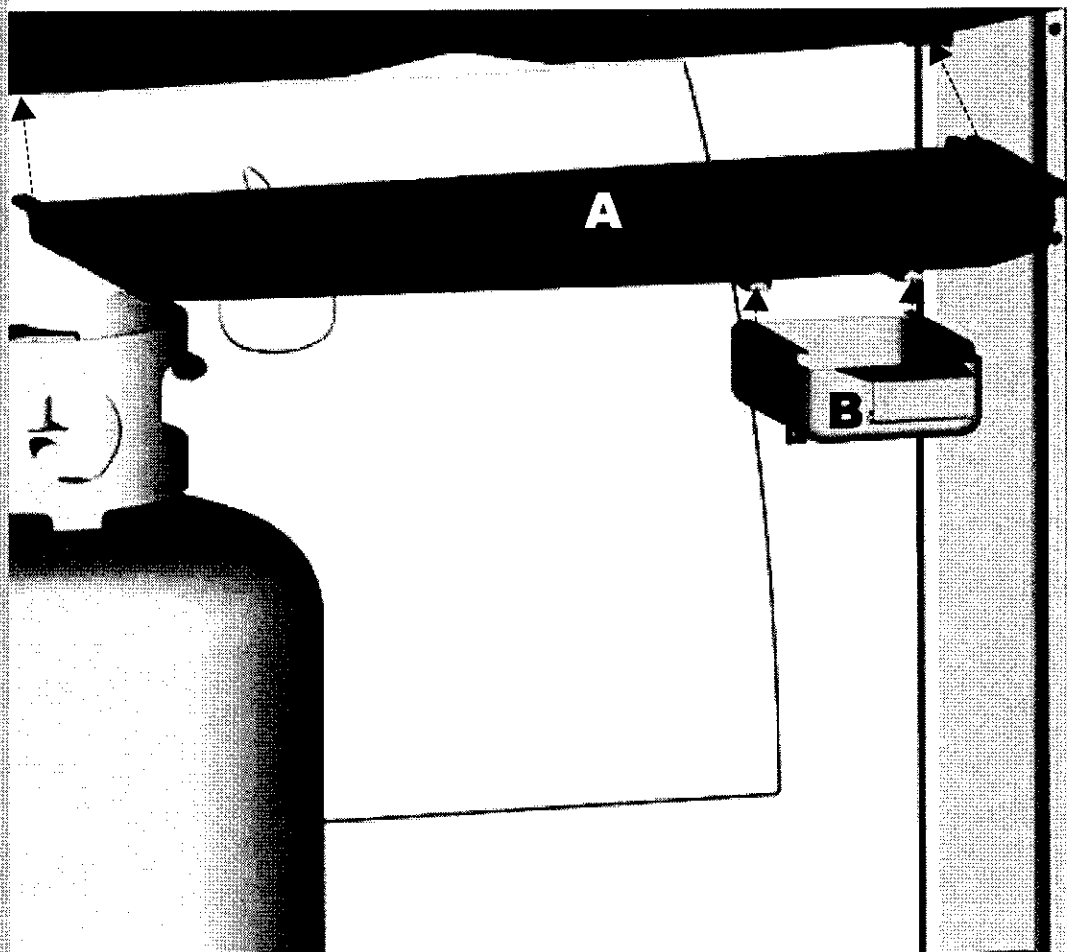

You may have hardware left over after completing assembly of your grill. This is normal as in some cases we have included extra hardware to ensure you have enough.