

Installation Works and Procedures

for



**CS-C9CKPG CU-C9CKP6G
CS-C12CKPG CU-C12CKP6G**

Required tools for Installation Works

- | | | |
|--|----------------------|--------------------|
| 1. Phillips screw driver | 7. Reamer | 14. Torque wrench |
| 2. Level gauge | 8. Knife | 18 N•m (1.8 kgf.m) |
| 3. Electric drill, hole core drill
(ø70 mm) | 9. Gas leak detector | 42 N•m (4.2 kgf.m) |
| 4. Hexagonal wrench (4 mm) | 10. Measuring tape | 55 N•m (5.5 kgf.m) |
| 5. Spanner | 11. Thermometer | 15. Vacuum pump |
| 6. Pipe cutter | 12. Megameter | 16. Gauge manifold |
| | 13. Multimeter | |

SAFETY PRECAUTIONS

- Read the following "SAFETY PRECAUTIONS" carefully before installation.
- Electrical work must be installed by a licensed electrician.
- The caution items stated here must be followed because these important contents are related to safety. The meaning of each indication used is as below. Incorrect installation will cause harm or damage, and the seriousness is classified by the following indications.

	WARNING	This indication shows the possibility of death or serious injury.
	CAUTION	This indication shows the possibility of injury or damage to properties.

The items to be followed are classified by the symbols:

	Symbol with white background denotes an item that is PROHIBITED.
--	--

- Carry out test running to confirm that no abnormality occurs after the installation. Then, explain to user the operation, care and maintenance as stated in instructions. Please remind the customer to keep the operating instructions for future reference.

WARNING

- 1) Engage dealer or specialist for installation. If installation done by the user is defective, it will cause water leakage, electrical shock or fire.
- 2) Install according to these installation instructions only. If installation is defective, it will cause water leakage, electrical shock or fire.
- 3) Use the attached accessories parts and specified parts for installation. Otherwise, it will cause the set to fall, water leakage, fire or electrical shock.
- 4) Install at a strong and firm location which is able to withstand the set's weight. If the strength is not enough or installation is not properly done, the set will drop and cause injury.
- 5) For installation work, follow all electrical, building, plumbing, local codes, regulations and these installation instructions. If electrical circuit capacity is not enough or a defect is found in electrical work, it will cause electrical shock or fire.
- 6) Use the UL listed or CSA approved AWG16 wire (or heavier wire) and connect tightly for indoor/outdoor connection. Connect tightly and clamp the wire so that no external force will be acted on the terminal. If connection or fixing is not perfect, it will cause heat-up or fire at the connection.
- 7) Wire routing must be properly arranged so that control board cover is fixed properly. If control board cover is not fixed perfectly, it will cause heat-up at connection point of terminal, fire or electrical shock.
- 8) When carrying out piping connection, take care not to let air substances other than the specified refrigerant enter into the refrigeration cycle. Otherwise, it will cause lower capacity, abnormal high pressure in the refrigeration cycle, explosion and injury.

CAUTION

- 1) This equipment must be earthed. It may cause electrical shock if grounding is not perfect.
- 2) Do not install the unit at place where leakage of flammable gas may occur. If gas leaks and accumulates around the unit, it may cause fire. 
- 3) Carry out drainage piping as mentioned in installation instructions. If drainage is not done properly, water may enter the room and damage the furniture.

ATTENTION

- 1) Selection of the installation location.
Select an installation location which is rigid and strong enough to support or hold the unit, and select a location for easy maintenance.
- 2) Power supply connection to the room air conditioner.
Connect the power supply of the room air conditioner to the mains.
Power supply point should be in an easily accessible place for power disconnection in case of emergency.
Power supply connection to a circuit breaker for the permanent connection. Use an approved 15A (CU-C9CKP6G) and 20A (CU-C12CKP6G) fuse or circuit breaker for the permanent connection.
It must be a double pole switch with a minimum 3 mm contact gap.
- 3) Do not release refrigerant.
Do not release refrigerant during piping work for installation, reinstallation and during repairing a refrigeration parts. Take care of the liquid refrigerant, it may cause frostbite.
- 4) Installation work.
Two people may be required to carry out installation.
- 5) Do not install this appliance in a laundry room or other location where water may drip from the ceiling, etc.

Attached accessories.

No.	Accessories part	Qty.	No.	Accessories part	Qty.
1	Installation plate	1	5	Air purifying filter	1
2	Installation plate fixing screw	6	6	Solar refreshing deodorizing filter	1
3	Remote control	1	7	Remote control holder	1
4	Battery	2	8	Remote control holder fixing screw	2

Applicable piping kit
 CZ-3F5, 7AEN (CS-C9CKPG)
 CZ-4F5, 7, 10AN (CS-C12CKPG)

SELECT THE BEST LOCATION

INDOOR UNIT

- ❑ There should not be any heat source or steam near the unit.
- ❑ There should not be any obstacles blocking the air circulation.
- ❑ A place where air circulation in the room is good.
- ❑ A place where drainage can be easily done.
- ❑ A place where noise prevention is taken into consideration.
- ❑ Do not install the unit near the doorway.
- ❑ Ensure there is adequate space (indicated by arrows) from the wall, ceiling, fence or other obstacles.
- ❑ Recommended installation height for indoor unit should be at least 7.5 ft (2.3 m).

OUTDOOR UNIT

- ❑ If an awning is built over the unit to prevent direct sunlight or rain, be careful that heat radiation from the condenser is not obstructed.
- ❑ Keep animals and plants away from the unit as they may be affected by the hot air discharged.
- ❑ Keep the spaces (indicated by arrows) from wall, ceiling, fence or other obstacles.
- ❑ Do not place near any obstacles which may cause a short circuit of the discharged air.
- ❑ If piping length is over the common length, additional refrigerant should be added as shown in the table.

Model	Piping size		Common Length ft (m)	Max. Elevation ft (m)	Max. Piping Length ft (m)	Additional Refrigerant g (oz)
	Gas	Liquid				
CS-C9CKPG	3/8"	1/4"	24.6 ft (7.5 m)	10.4 ft (3 m)	32.6 ft (10 m)	0.11 oz (10 g)
CS-C12CKPG	1/2"	3/8"	24.6 ft (7.5 m)	10.4 ft (3 m)	40.5 ft (12.3 m)	0.11 oz (10 g)

Indoor/Outdoor Unit Installation Diagram

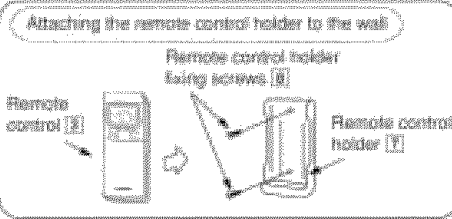
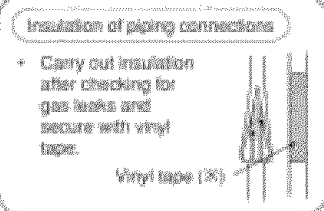
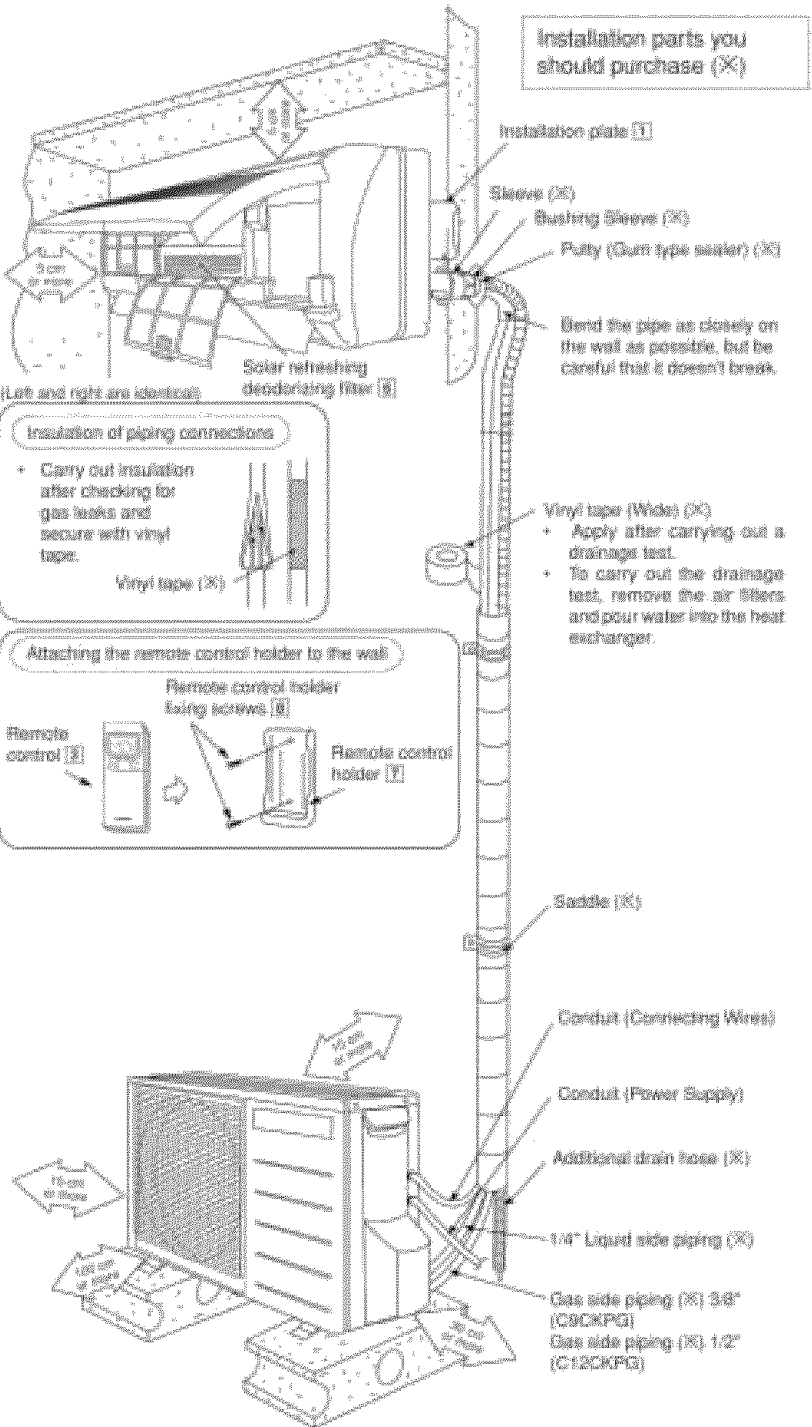
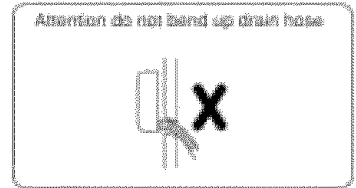
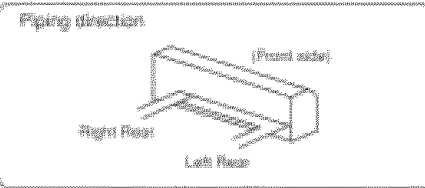

• This illustration is for explanation purposes only. The indoor unit will actually face a different way.

1

SELECT THE BEST LOCATION (Refer to "Select the best location" section)

2

HOW TO FIX INSTALLATION PLATE

The mounting wall must be strong and solid enough to prevent it from the vibration.

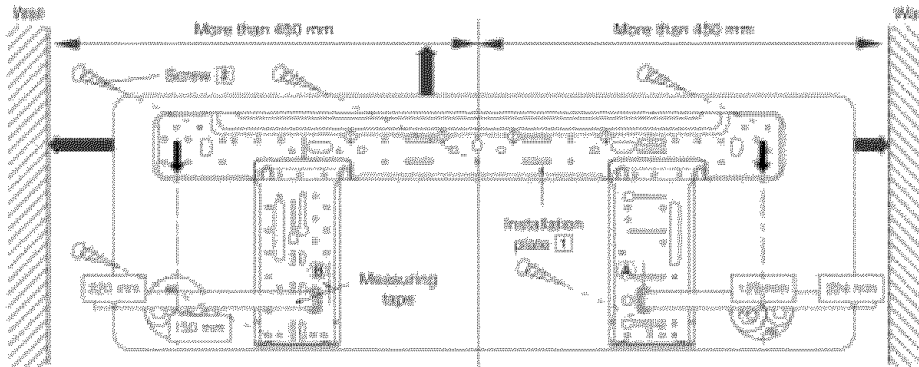

The centre of installation plate should be at more than 450 mm at right and left of the wall.
 The distance from installation plate edge to ceiling should be more than 67 mm.
 From installation plate left edge to unit's left side is 47 mm.
 From installation plate right edge to unit's right is 73 mm.

- (B) : For left side piping, piping connection for liquid should be about 14 mm from this line.
- : For left side piping, piping connection for gas should be about 56 mm from this line.
- : For left side piping, piping connecting wire should be about 785 mm from this line.

1. Mount the installation plate on the wall with 5 screws or more.
 (If mounting the unit on the concrete wall consider using anchor bolts.)
 - Always mount the installation plate horizontally by aligning the marking-off line with the thread and using a level gauge.
2. Drill the piping plate hole with $\phi 70$ mm hole-core drill.
 - Line according to the arrows marked on the lower left and right side of the installation plate. The meeting point of the extended line is the centre of the hole. Another method is to put measuring tape at position as shown in the diagram above. The hole centre is obtained by measuring the distance namely 150 mm and 125 mm for left and right holes respectively.
 - Drill the piping hole at either the right or the left and the hole should be slightly slanted to the outdoor side.

3

TO DRILL A HOLE IN THE WALL AND INSTALL A SLEEVE OF PIPING

1. Insert the piping sleeve to the hole.
2. Fix the bushing to the sleeve.
3. Cut the sleeve until it extrudes about 15 mm from the wall.

CAUTION

When the wall is hollow, please be sure to use the sleeve for tube ass'y to prevent dangers caused by mice biting the connecting wire.

4. Finish by sealing the sleeve with putty or caulking compound at the final stage.

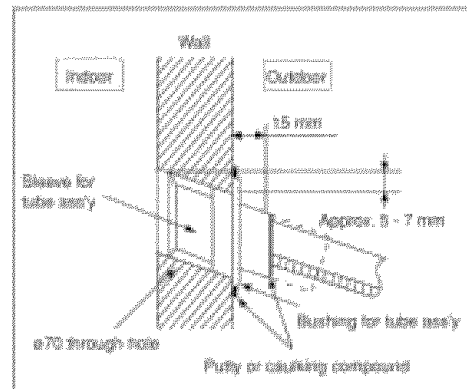

1

SELECT THE BEST LOCATION (Refer to "Select the best location" section)

2

INSTALL THE OUTDOOR UNIT

- After selecting the best location, start installation according to Indoor/Outdoor Unit Installation Diagram.
- Fix the unit on concrete or rigid frame firmly and horizontally by bolt nut (ø10 mm).
 - When installing on roof, please take into consideration strong winds and earthquakes. Please fasten the installation stand firmly with bolt or nails.

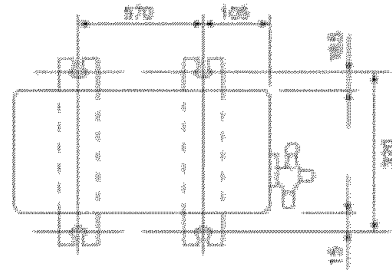

3

CONNECTING THE PIPING

Connecting The Piping To Indoor Unit

Please make flare after inserting flare nut (located at joint portion of tube assembly) onto the copper pipe.
(In case of using long piping)

Connect the piping

- Align the center of piping and sufficiently tighten the flare nut with fingers.
- Further tighten the flare nut with torque wrench in specified torque as stated in the table.



Model	Piping size (Torque)	
	Gas	Liquid
CS-C9CKPG	3/8" [42 N·m]	1/4" [18 N·m]
CS-C12CKPG	1/2" [55 N·m]	1/4" [18 N·m]

Connecting The Piping To Outdoor Unit

Decide piping length and then cut by using pipe cutter. Remove burrs from cut edge. Make flare after inserting the flare nut (located at valve) onto the copper pipe.
Align center of piping to valves and then tighten with torque wrench to the specified torque as stated in the table.

CUTTING AND FLARING THE PIPING

- Please cut using pipe cutter and then remove the burrs.
- Remove the burrs by using reamer. If burrs are not removed, gas leakage may be caused. Turn the piping end down to avoid the metal powder entering the pipe.
- Please make flare after inserting the flare nut onto the copper pipes.



When properly flared, the internal surface of the flare will evenly shine and be even thickness. Since the flare part comes into contact with the connector, carefully check the flare finish.

4 INDOOR UNIT INSTALLATION

1. FOR THE RIGHT REAR PIPING

Pull out the indoor piping

Install the indoor Unit

Secure the indoor Unit

Insert the connecting wire

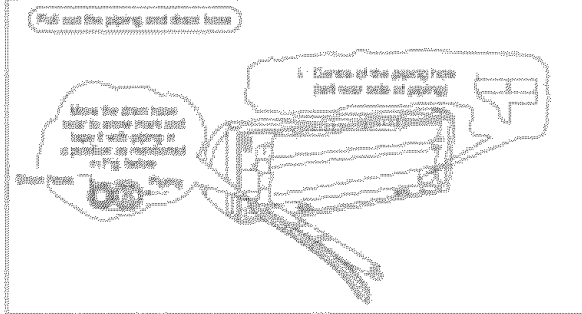

Install the indoor Unit

Push the indoor unit onto the upper portion of installation plate. (Engage the indoor unit with the upper edge of the installation plate). Ensure the hooks are properly seated on the installation plate by moving it left and right.

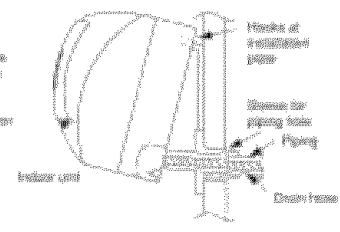

Secure the indoor Unit

1. Tape the extra power supply cord in a bundle and keep it behind the cabinet.
 - Ensure that the power supply cord is not changed in between the unit's hook (2 positions) and installation plate.
2. Press the lower left and right side of the unit against the installation plate until proper engage with these slots is clear will be found.

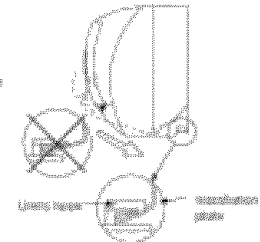

2. FOR THE EMBEDDED PIPING

Replace the drain hose

Band the embedded piping

- Use a spring band to be attached to band the piping to fix the piping to installation plate.

Install the indoor Unit

Cut and flare the embedded piping

- When determining the dimension of the piping, take the unit all the way to the bottom of installation plate.
- Refer to the section "Cutting and flaring the piping".

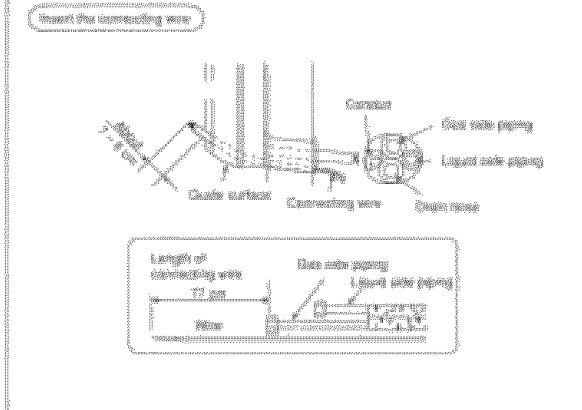

To know that the unit, push the [FLARE] markings of the bottom unit, and pull it slightly towards the left to engage the flange from the left.

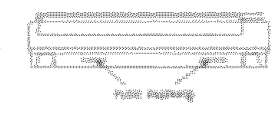

Pull the connecting wire into indoor Unit

- The main and outside connecting wire are to be connected without crossing the main pipe.

Connect the piping

- Please refer to "Connecting the piping" section in indoor unit section. (Please refer our book after installing the outdoor piping and the linkage connection.)

Insulate and finish the piping

- Please refer to "Indoor/Outdoor Line Installation Diagram".

Secure the indoor Unit

(This can be used for left rear piping also.)

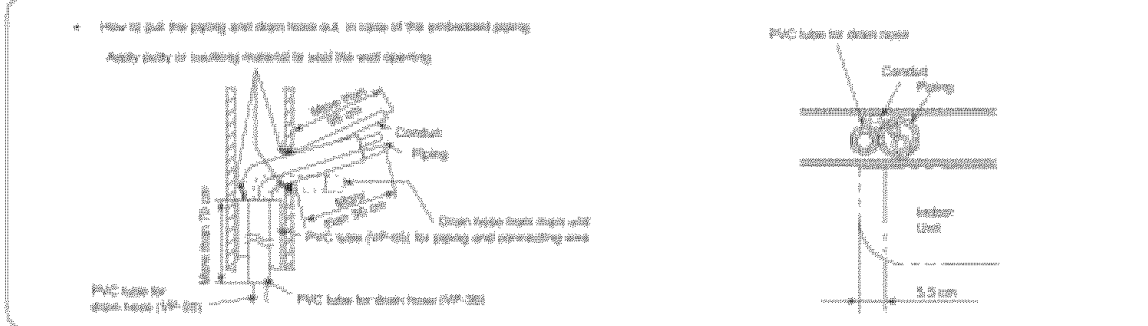
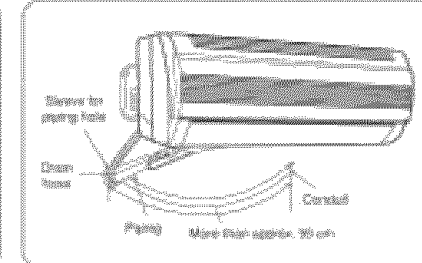
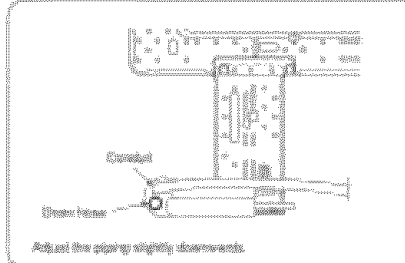
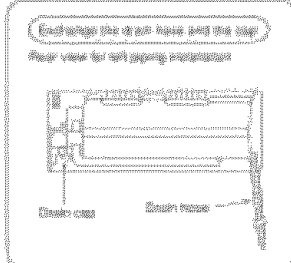

4 EVACUATION OF THE EQUIPMENT

WHEN INSTALLING AN AIR CONDITIONER, BE SURE TO EVACUATE THE AIR INSIDE THE INDOOR UNIT AND PIPES with the following procedure:

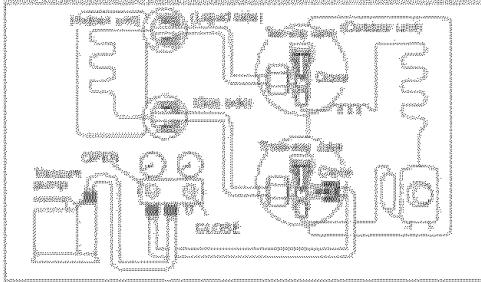

1. Connect a charging hose with a push pin to the Low and High side of a charging set and the service port of the 3-way valve.
 - Be sure to connect the end of the charging hose with the push pin to the service port.
2. Connect the other hose of the charging set to a vacuum pump.
3. Turn on the power switch of the vacuum pump and make sure that the needle in the gauge moves from 0 cmHg (0 MPa) to -76 cmHg (-0.1 MPa). Then evacuate the air approximately ten minutes.
4. Close the valve of both the Low and High sides of the charging set and turn off the vacuum pump. Make sure that the needle in the gauge stops moving after approximately five minutes.

Note: BE SURE TO PERFORM THIS PROCEDURE IN ORDER TO AVOID REFRIGERANT GAS LEAKAGE.
5. Disconnect the charging hose from the vacuum pump and from the service port of the 3-way valve.
6. Tighten the service port caps of the 3-way valve or a torque of 18 N•m with a torque wrench.
7. Remove the valve caps of both of the 2-way valve and 3-way valve. Position both of the valves to "OPEN" using a hexagonal wrench (4 mm).
8. Mount valve caps onto the 2-way valve and the 3-way valve.
 - Be sure to check for gas leakage.

CAUTION

- If gauge needle does not move from 0 cmHg (0 MPa) to -76 cmHg (-0.1 MPa), in step ③ above take the following measure:
- If the leak stops when the piping connections are tightened further, continue working from step ③.
- If the leak does not stop when the connections are retightened, repair the location of leak.
- Do not release refrigerant during piping work for installation and reinstallation. Take care when using liquid refrigerant, as it may cause frostbite.

5 OUTDOOR UNIT ELECTRICAL WIRING

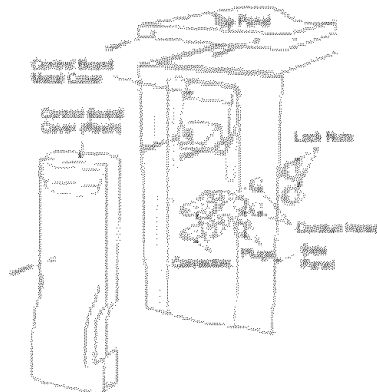

1. Remove Top Panel.
2. Remove Control Board Cover (Metal & Resin)
3. Remove Plugs.
4. Fix the conduit connectors to the conduit holes with lock-nuts, then secure them against the side panel.
5. Connecting wire between indoor unit and outdoor unit should be UL listed or CSA approved 4 x AWG16 wire.

CS-CU-C9CKPG, C12CKPG

Terminals on the indoor unit	1	2	3	
Color of wires	White	Black	Red	Blue
Terminals on the outdoor unit	1	2	3	

5. Secure the wire onto the control board with the holder (clammer).

7. Wire connection to the power supply (115V 60Hz) through circuit breaker.
 - Connect the UL listed or CSA approved power wires (AWG14) to the terminal board, and connect the other end of the wires to circuit breaker.

Terminals on the outdoor unit	L	N	
Color of wires	Black	White	Blue
Terminals on the circuit breaker	(L)	(N)	

Note: Secure the wires onto the control board with the holder (clammer).

8. After completing wiring connections, reattach the control board cover (metal and resin) and the top panel to the original position with the screws.

6 PIPE INSULATION

1. Please carry out insulation at pipe connection portion as mentioned in Indoor/Outdoor Unit Installation Diagram. Please wrap the insulated piping end to prevent water from going inside the piping.
2. If drain hose or connecting piping is in the room (where dew may form), please increase the insulation by using POLY-E FOAM with a thickness of 6 mm or more.

5

INDOOR UNIT ELECTRICAL WIRING

1. Remove the control board metal cover.

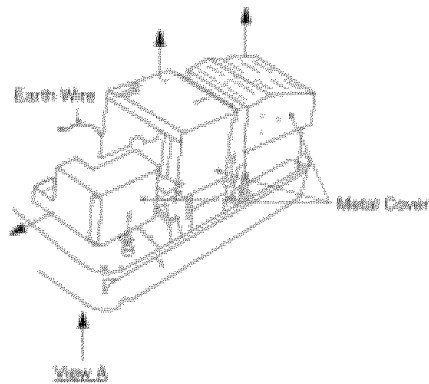

2. Unscrew the conduit cover & fix the conduit connector to conduit cover with lock nut, then secure it against chassis.

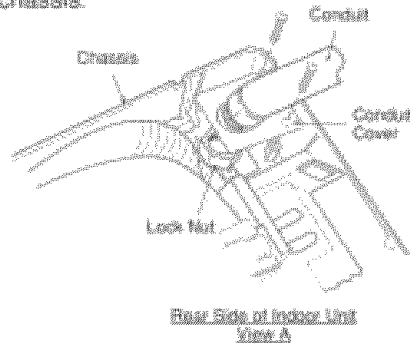

3. Connecting wire between indoor unit and outdoor unit should be UL listed or CSA approved 4 x AWG16 wire.

- Ensure the color of wires of outdoor unit and the terminal Nos. are the same as the indoor's respectively.
- Earth lead wire should be longer than the other lead wires as shown in the figure for the electrical safety in case the cord slips out from the anchorage.

CS/CU-C9CKPG, C12CKPG

Terminals on the indoor unit	1	2	3	
Color of wires				
Terminals on the outdoor unit	1	2	3	

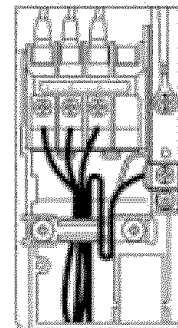

- Secure the wire onto the control board with the holder (clammer).

4. After completing wiring connections, reattach the metal cover to the original location.

INSTALLATION OF AIR PURIFYING FILTERS

1. Open the front panel.
2. Remove the air filters.
3. Put air purifying filter (left) and solar refreshing deodorizing filter (right) into place as shown in illustration at right.

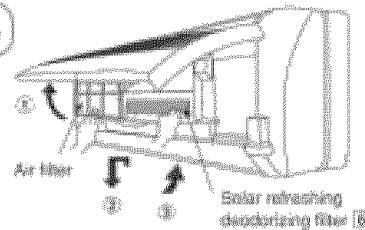

HOW TO TAKE OUT FRONT GRILLE

Please follow the steps below to take out front grille if necessary such as when servicing.

1. Set the vertical airflow direction louver to the horizontal position.
2. Slide down the two caps on the front grille as shown in the illustration at right, and then remove the two mounting screws.
3. Pull the lower section of the front grille towards you to remove the front grille.

When reinstalling the front grille, first set the vertical airflow direction louver to the horizontal position and then carry out above steps 2 - 3 in the reverse order.

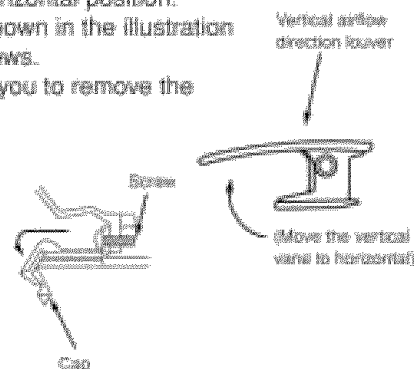

AUTO SWITCH OPERATION

The below operations will be performed by pressing the "AUTO" switch.

1. AUTO OPERATION MODE

The Auto operation will be activated immediately once the Auto Switch is pressed.

2. TEST RUN OPERATION (FOR PUMP DOWN/SERVICING PURPOSE)

The Test Run operation will be activated if the Auto Switch is pressed continuously for more than 5 sec. to below 10 sec. A "pep" sound will occur at the fifth sec., in order to identify the starting of Test Run operation.

3. REMOTE CONTROLLER RECEIVING SOUND ON/OFF

The ON/OFF of Remote Controller receiving sound can be changed over by pressing the "AUTO" Switch continuously for 10 sec. and above. A "pep", "pep" sound will occur at the tenth sec., in order to indicate the "ON/OFF" change over of remote control receiving sound.

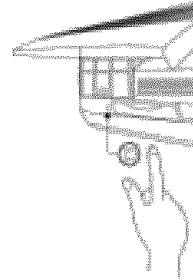

CHECK THE DRAINAGE

- Open front panel and remove air filters.
(Drainage checking can be carried out without removing the front grille.)
- Pour a glass of water into the drain tray-styrofoam.
- Ensure that water flows out from drain hose of the indoor unit.

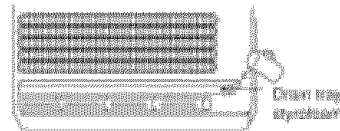

EVALUATION OF THE PERFORMANCE

- Operate the unit at cooling operation mode for fifteen minutes or more.
- Measure the temperature of the intake and discharge air.
- Ensure the difference between the intake temperature and the discharge is more than 8°C (46.4°F).

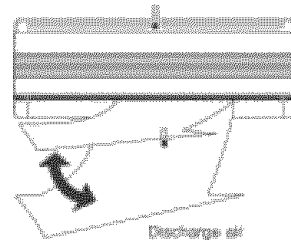

CHECK ITEMS

- | | |
|--|--|
| <input type="checkbox"/> Is there any gas leakage at flare nut connections? | <input type="checkbox"/> Is the indoor unit properly hooked to the installation plate? |
| <input type="checkbox"/> Has the heat insulation been carried out at flare nut connection? | <input type="checkbox"/> Is the power supply voltage compliant with rated value? |
| <input type="checkbox"/> Is the connecting wire being fixed to terminal board firmly? | <input type="checkbox"/> Is there any abnormal sound? |
| <input type="checkbox"/> Is the connecting wire being clamped firmly? | <input type="checkbox"/> Is the cooling operation normal? |
| <input type="checkbox"/> Is the drainage ok?
(Refer to "Check the drainage" section) | <input type="checkbox"/> Is the thermostat operation normal? |
| <input type="checkbox"/> Is the earth wire connection properly done? | <input type="checkbox"/> Is the remote control's LCD operation normal? |
| | <input type="checkbox"/> Is the air purifying filter installed? |

MATSUSHITA ELECTRIC INDUSTRIAL CO., LTD.

Web Site : <http://www.panasonic.co.jp/global/>

ENGLISH

F612332

PRINTED IN MALAYSIA