



# XL44™ Self-Cleaning Gas Convection Ranges

**Safety Instructions** . . . 2, 4-8  
*Anti-tip device* . . . . . 4, 43, 51

**Operating Instructions, Tips**

*Aluminum foil* . . . . . 17  
*Clock and timer* . . . . . 19  
*Electric warming drawer* . . . 28-29  
**Oven** . . . . . 16-27  
*Baking* . . . . . 17, 20  
*Broiling, Broiling guide* . . . . 18  
*Convection cooking* . . . . . 22-23  
*Door latch* . . . . . 30, 31  
*Electric ignition* . . . . . 16, 49  
*Light bulb replacement* . . . . . 39  
*Oven control* . . . . . 12  
*Preheating* . . . . . 17  
*Probe* . . . . . 21  
*Roasting, Roasting guide* . . . . . 17, 20, 24-25  
*Self-cleaning instructions* . . 30-31  
*Shelves* . . . . . 16  
*Special features of your oven control* . . . . . 13-15  
*Timed baking* . . . . . 20, 26  
*Type of margarine* . . . . . 27  
*Surface cooking* . . . . . 9-11  
*Control settings* . . . . . 9  
*Electric glass top warming zone* . . . . . 11

**Care and Cleaning**

*Broiler pan and grid* . . . . . 36  
*Burner assembly* . . . . . 32, 33  
*Burner grates* . . . . . 34  
*Control panel* . . . . . 38  
**Cooktop** . . . . . 34-35  
*Glass* . . . . . 35  
*Porcelain* . . . . . 34  
*Door removal* . . . . . 36  
*Oven bottom* . . . . . 36  
*Oven vents* . . . . . 38  
*Self-cleaning instructions* . . 30-31  
*Shelves* . . . . . 39  
*Top light* . . . . . 39  
*Warming drawer* . . . . . 37

**Before You Call For Service**

*Thermostat adjustment—do it yourself* . . . . . 27  
*Troubleshooting tips* . . . . . 52-55

**Preparation**

*Air adjustment* . . . . . 50  
*Flame size* . . . . . 49  
*Flooring under the range* . . . . 43  
*Installation instructions* . . . 40-51  
*Leveling* . . . . . 50  
*LP* . . . . . 51

**Consumer Services**

**GE Answer Center® 800.626.2000**  
*Important phone numbers* . . . . . Back Cover  
*Model and serial number location* . . . . . 3  
*Product registration* . . . . . 3, 57, 58  
*Warranty* . . . . . 59

**Owner's Manual and Installation Instructions**

JGB910  
JGB920



**IMPORTANT SAFETY INFORMATION.  
READ ALL INSTRUCTIONS BEFORE USING.**

*Safety Instructions*

*Operating Instructions*

*Installation Instructions*

*Troubleshooting Tips*

*Customer Service*

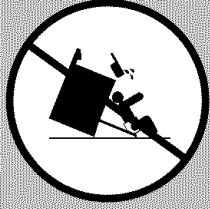

**⚠ WARNING!**  
**ANTI-TIP DEVICE**

- ALL RANGES CAN TIP
- INJURY TO PERSONS COULD RESULT
- INSTALL ANTI-TIP DEVICES PACKED WITH RANGE
- SEE INSTALLATION INSTRUCTIONS

**WARNING:** If the information in this manual is not followed exactly, a fire or explosion may result causing property damage, personal injury or death.

- Do not store or use gasoline or other flammable vapors and liquids in the vicinity of this or any other appliance.
- **WHAT TO DO IF YOU SMELL GAS**
  - Do not try to light any appliance.
  - Do not touch any electrical switch; do not use any phone in your building.
  - Immediately call your gas supplier from a neighbor's phone. Follow the gas supplier's instructions.
  - If you cannot reach your gas supplier, call the fire department.
- Installation and service must be performed by a qualified installer, service agency or the gas supplier.





## IMPORTANT!

---

Fill out the Consumer Product Registration Card.

**Two easy ways to register your appliance!**

- Through the internet at [www.geappliances.com](http://www.geappliances.com)
- Complete and mail the enclosed Product Registration Card

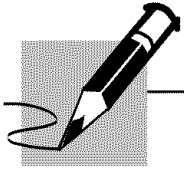

## FOR YOUR RECORDS

---

**Write the model and serial numbers here:**

# \_\_\_\_\_

# \_\_\_\_\_

You can find them on a label on the front of the range behind the warming drawer.

**Staple sales slip or cancelled check here.**

Proof of the original purchase date is needed to obtain service under the warranty.

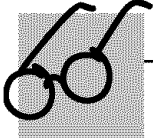

## READ THIS MANUAL

---

Inside you will find many helpful hints on how to use and maintain your range properly. Just a little preventive care on your part can save you a great deal of time and money over the life of your range.

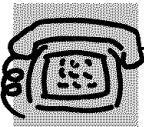

## IF YOU NEED SERVICE

---

You'll find many answers to common problems in the *Before You Call For Service* section. If you review our chart of *Troubleshooting Tips* first, you may not need to call for service at all.

If you do need service, you can relax knowing help is only a phone call away. A list of toll-free customer service numbers is included in the back section of this manual. Or, you can always call the GE Answer Center® at 800.626.2000, 24 hours a day, 7 days a week.

# IMPORTANT SAFETY INFORMATION. READ ALL INSTRUCTIONS BEFORE USING.

Safety Instructions

Operating Instructions

Installation Instructions

Troubleshooting Tips

Customer Service

## **⚠ WARNING!**

*For your safety, the information in this manual must be followed to minimize the risk of fire or explosion, electric shock, or to prevent property damage, personal injury, or loss of life.*

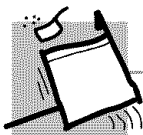

## **⚠ WARNING ANTI-TIP DEVICE**

**All ranges can tip and injury could result.**

*To prevent accidental tipping of the range, attach it to the wall by installing the Anti-Tip device supplied.*

*To check if the device is installed and engaged properly, carefully tip the range forward. The Anti-Tip device should engage and prevent the range from tipping over.*

If you pull the range out from the wall for any reason, make sure the device is properly engaged when you push the range back against the wall. If it is not, there is a possible risk of the range tipping over and causing injury if you or a child stand, sit or lean on an open door.

Please refer to the Anti-Tip device information in this manual. Failure to take this precaution could result in tipping of the range and injury.

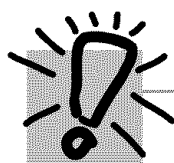
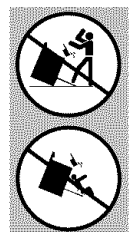

## IMPORTANT SAFETY NOTICE

*The California Safe Drinking Water and Toxic Enforcement Act requires the Governor of California to publish a list of substances known to the state to cause birth defects or other reproductive harm, and requires businesses to warn customers of potential exposure to such substances.*

*Gas appliances can cause minor exposure to four of these substances, namely benzene, carbon monoxide, formaldehyde and soot, caused primarily by the incomplete combustion of natural gas or LP fuels. Properly adjusted burners, indicated by a bluish rather than a yellow flame, will minimize incomplete combustion. Exposure to these substances can be minimized by venting with an open window or using a ventilation fan or hood.*

*Fluorescent light bulbs and safety valves on standing pilot ranges contain mercury. If your model has these features, they must be recycled according to local, state and federal codes.*



## SAFETY PRECAUTIONS

*Have the installer show you the location of the range gas shut-off valve and how to shut it off if necessary.*

- Have your range installed and properly grounded by a qualified installer, in accordance with the Installation Instructions. Any adjustment and service should be performed only by qualified gas range installers or service technicians.
- Do not attempt to repair or replace any part of your range unless it is specifically recommended in this manual. All other service should be referred to a qualified technician.
- Plug your range into a 120-volt grounded outlet only. Do not remove the round grounding prong from the plug. If in doubt about the grounding of the home electrical system, it is your personal responsibility and obligation to have an ungrounded outlet replaced with a properly grounded, three-prong outlet in accordance with the National Electrical Code. Do not use an extension cord with this appliance.

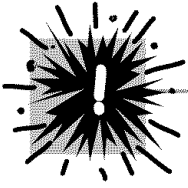

## SAFETY PRECAUTIONS

- Locate the range out of kitchen traffic path and out of drafty locations to prevent pilot outage (on standing pilot models) and poor air circulation.
- Be sure all packaging materials are removed from the range before operating it to prevent fire or smoke damage should the packaging material ignite.
- Be sure your range is correctly adjusted by a qualified service technician or installer for the type of gas (natural or LP) that is to be used. Your range can be converted for use with either type of gas. See the *Installation of the range* section.
 

**WARNING:** These adjustments must be made by a qualified service technician in accordance with the manufacturer's instructions and all codes and requirements of the authority having jurisdiction. Failure to follow these instructions could result in serious injury or property damage. The qualified agency performing this work assumes responsibility for the conversion.
- After prolonged use of a range, high floor temperatures may result and many floor coverings will not withstand this kind of use. Never install the range over vinyl tile or linoleum that cannot withstand such type of use. Never install it directly over interior kitchen carpeting.
- Do not leave children alone or unattended where a range is hot or in operation. They could be seriously burned.
- Do not allow anyone to climb, stand or hang on the oven door, storage drawer, warming drawer or cooktop. They could damage the range and even tip it over, causing severe personal injury.
- **CAUTION:** Items of interest to children should not be stored in cabinets above a range or on the backsplash of a range—children climbing on the range to reach items could be seriously injured.
- For your safety, never use your appliance for warming or heating the room.
- Never wear loose fitting or hanging garments while using the appliance. Be careful when reaching for items stored in cabinets over the range. Flammable material could be ignited if brought in contact with flame or hot oven surfaces and may cause severe burns.
- Do not store flammable materials in an oven, a range storage drawer, a warming drawer or near a cooktop.
- Do not store or use combustible materials, gasoline or other flammable vapors and liquids in the vicinity of this or any other appliance.
- Do not let cooking grease or other flammable materials accumulate in or near the range.
- Do not use water on grease fires. Never pick up a flaming pan. Turn the controls off. Smother a flaming pan on a surface burner by covering the pan completely with a well-fitting lid, cookie sheet or flat tray. Use a multi-purpose dry chemical or foam-type fire extinguisher.
 

Flaming grease outside a pan can be put out by covering it with baking soda or, if available, by using a multi-purpose dry chemical or foam-type fire extinguisher.

Flame in the oven or warming drawer can be smothered completely by closing the oven door or drawer and turning the control to off or by using a multi-purpose dry chemical or foam-type fire extinguisher.
- Let the burner grates and other surfaces cool before touching them or leaving them where children can reach them.
- Never block the vents (air openings) of the range. They provide the air inlet and outlet that are necessary for the range to operate properly with correct combustion. Air openings are located at the rear of the cooktop, at the top and bottom of the oven door, and at the bottom of the range under the warming drawer, storage drawer or kick panel.

# IMPORTANT SAFETY INFORMATION. READ ALL INSTRUCTIONS BEFORE USING.

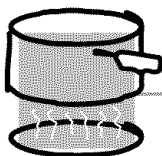

## ⚠ **WARNING!** SURFACE BURNERS

Use proper pan size—avoid pans that are unstable or easily tipped. Select cookware having flat bottoms large enough to cover burner grates. To avoid spillovers, make sure cookware is large enough to contain the food properly. This will both save cleaning time and prevent hazardous accumulations of food, since heavy spattering or spillovers left on range can ignite. Use pans with handles that can be easily grasped and remain cool.

- Always use the **LITE** position (on electric ignition models) or the **HI** position (on standing pilot models) when igniting the top burners and make sure the burners have ignited.
- Never leave the surface burners unattended at high flame settings. Boilovers cause smoking and greasy spillovers that may catch on fire.
- Adjust the top burner flame size so it does not extend beyond the edge of the cookware. Excessive flame is hazardous.
- Use only dry pot holders—moist or damp pot holders on hot surfaces may result in burns from steam. Do not let pot holders come near open flames when lifting cookware. Do not use a towel or other bulky cloth in place of a pot holder.
- When using glass cookware, make sure it is designed for top-of-range cooking.
- To minimize the possibility of burns, ignition of flammable materials and spillage, turn cookware handles toward the side or back of the range without extending over adjacent burners.
- Carefully watch foods being fried at a high flame setting.
- Always heat fat slowly, and watch as it heats.
- Do not leave any items on the cooktop. The hot air from the vent may ignite flammable items and will increase pressure in closed containers, which may cause them to burst.
- If a combination of oils or fats will be used in frying, stir together before heating or as fats melt slowly.
- Use a deep fat thermometer whenever possible to prevent overheating fat beyond the smoking point.
- Use the least possible amount of fat for effective shallow or deep-fat frying. Filling the pan too full of fat can cause spillovers when food is added.
- When flaming foods are under the hood, turn the fan off. The fan, if operating, may spread the flames.
- Do not use a wok on the cooking surface if the wok has a round metal ring that is placed over the burner grate to support the wok. This ring acts as a heat trap, which may damage the burner grate and burner head. Also, it may cause the burner to work improperly. This may cause a carbon monoxide level above that allowed by current standards, resulting in a health hazard.
- Foods for frying should be as dry as possible. Frost on frozen foods or moisture on fresh foods can cause hot fat to bubble up and over the sides of the pan.
- Never try to move a pan of hot fat, especially a deep fat fryer. Wait until the fat is cool.
- Do not leave plastic items on the cooktop—they may melt if left too close to the vent.
- Keep all plastics away from the surface burners.
- To avoid the possibility of a burn, always be certain that the controls for all burners are at the **OFF** position and all grates are cool before attempting to remove them.
- If range is located near a window, do not hang long curtains that could blow over the surface burners and create a fire hazard.
- If you smell gas, turn off the gas to the range and call a qualified service technician. Never use an open flame to locate a leak.
- Always turn the surface burner controls off before removing cookware.

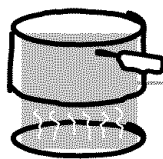

## **▲ WARNING!**

### **GLASS COOKTOP SURFACE** (on some models)

Use care when touching the glass cooktop surface. The glass surface of the cooktop will retain heat after the controls have been turned off.

- Avoid scratching the glass cooktop surface. The glass surface can be scratched with items such as sharp instruments, rings or other jewelry and rivets on clothing.
  - Do not operate the cooktop if the glass is broken. Spillovers or cleaning solution may penetrate a broken cooktop and create a risk of electrical shock. Contact a qualified technician immediately should your glass cooktop surface become broken.
  - Never use the glass cooktop surface as a cutting board.
  - Do not place or store items that can melt or catch fire on the glass cooktop surface, even when it is not being used.
  - Be careful when placing spoons or other stirring utensils on glass cooktop surface when it is in use. They may become hot and could cause burns.
  - Clean the cooktop surface with caution. If a wet sponge or cloth is used to wipe spills on a hot surface, be careful to avoid steam burns. Some cleaners can produce noxious fumes if applied to a hot surface.
- NOTE:** We recommend that you avoid wiping any surface areas until they have cooled and the indicator light has gone off. Sugar spills are the exception to this. Please see *Cleaning the glass cooktop surface* section.
- When the cooktop surface is cool, use only the recommended cleaning cream to clean the cooktop.
  - To avoid possible damage to the cooking surface, do not apply cleaning cream to the glass surface when it is hot.
  - After cleaning, use a dry cloth or paper towel to remove all cleaning cream residue.
  - Read and follow all instructions and warnings on the cleaning cream labels.

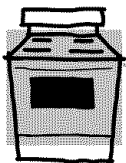

### **ELECTRIC WARMING DRAWER**

- The purpose of the warming drawer is to hold hot cooked foods at serving temperature. Always start with hot food; cold food cannot be heated or cooked in the warming drawer.
  - Do not use the warming drawer to dry newspapers. If overheated, they can catch on fire.
  - Do not leave paper products, cooking utensils or food in the warming drawer when not in use.
  - Never leave jars or cans of fat drippings in or near your warming drawer.
  - Always keep wooden and plastic utensils and canned food a safe distance away from your warming drawer.
  - Do not warm food in the warming drawer for more than two hours.
  - **Do not touch the heating element or the interior surface of the warming drawer.** These surfaces may be hot enough to burn.
- REMEMBER:** The inside surface of the warming drawer may be hot when the drawer is opened.
- Use care when opening the drawer. Open the drawer a crack and let hot air or steam escape before removing or replacing food. Hot air or steam which escapes can cause burns to hands, face and/or eyes.
  - Do not use aluminum foil to line the drawer. Foil is an excellent heat insulator and will trap heat beneath it. This will upset the performance of the drawer and it could damage the interior finish.

# IMPORTANT SAFETY INFORMATION. READ ALL INSTRUCTIONS BEFORE USING.



## COOK MEAT AND POULTRY THOROUGHLY...

*Cook meat and poultry thoroughly—meat to at least an INTERNAL temperature of 160°F. and poultry to at least an INTERNAL temperature of 180°F. Cooking to these temperatures usually protects against foodborne illness.*



## OVEN

*Stand away from the range when opening the door of a hot oven. The hot air and steam that escape can cause burns to hands, face and eyes.*

- Do not use the oven for a storage area. Items stored in the oven can ignite.
- Keep the oven free from grease buildup.
- Place the oven shelves in the desired position while the oven is cool.
- Pulling out the shelf to the stop-lock is a convenience in lifting heavy foods. It is also a precaution against burns from touching hot surfaces of the door or oven walls. The lowest position “R” is not designed to slide.
- Do not heat unopened food containers. Pressure could build up and the container could burst, causing an injury.
- Never use aluminum foil to line the oven bottom. Improper use of foil could start a fire.
- Do not use aluminum foil anywhere in the oven except as described in this manual. Misuse could result in a fire hazard or damage to the range.
- When using cooking or roasting bags in the oven, follow the manufacturer’s directions.
- Do not use your oven to dry newspapers. If overheated, they can catch fire.
- Use only glass cookware that is recommended for use in gas ovens.
- Always remove the broiler pan from range as soon as you finish broiling. Grease left in the pan can catch fire if oven is used without removing the grease from the broiler pan.
- When broiling, if meat is too close to the flame, the fat may ignite. Trim excess fat to prevent excessive flare-ups.
- Make sure the broiler pan is in place correctly to reduce the possibility of grease fires.
- If you should have a grease fire in the broiler pan, press the **CLEAR/OFF** pad, and keep the oven door closed to contain fire until it burns out.



## SELF-CLEANING OVEN

- Be sure to wipe up excess spillage before self-cleaning operation.
- Before self-cleaning the oven, remove the shelves, broiler pan, grid and other cookware.
- Do not clean the door gasket. The door gasket is essential for a good seal. Care should be taken not to rub, damage or move the gasket.
- Clean only parts listed in this Owner’s Manual.
- If the self-cleaning mode malfunctions, turn the oven off and disconnect the power supply. Have it serviced by a qualified technician.
- Do not use oven cleaners. No commercial oven cleaner or oven liner of any kind should be used in or around any part of the oven. Residue from oven cleaners will damage the inside of the oven when the self-clean cycle is used.



*Read and follow this Safety Information carefully.*

**SAVE THESE INSTRUCTIONS**



# Using the gas surface burners.

Throughout this manual, features and appearance may vary from your model.

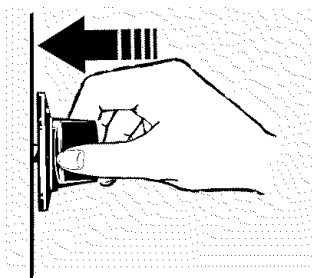

Push the control knob in and turn it to the LITE position.

## How to Light a Gas Surface Burner

Push the control knob in and turn it to the **LITE** position.

You will hear a little **clicking** noise—the sound of the electric spark igniting the burner.

Turn the knob to adjust the flame size. If the knob stays at **LITE**, it will continue to click.

When one burner is turned to **LITE**, all the burners spark. Do not attempt to disassemble or clean around any burner while another burner is on. An electric shock may result, which could cause you to knock over hot cookware.

## Sealed Gas Burners

The smaller burner (right rear position) will give the best simmer results. It offers precise cooking performance for delicate foods, such as sauces or foods which need to cook over low heat for a long time. It can be turned down to a very low simmer setting.

The largest burners are higher powered than the others and will bring liquids to a boil quicker.

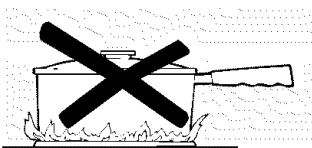

## How to Select Flame Size

For safe handling of cookware, never let the flames extend up the sides of the cookware.

Watch the flame, not the knob, as you reduce heat. The flame size on a gas burner should match the cookware you are using.

Any flame larger than the bottom of the cookware is wasted and only serves to heat the handle.

## In Case of Power Failure

In case of a power failure, you can light the gas surface burners on your range with a match. Hold a lit match to the burner, then push in and turn the control knob to the **LITE** position. Use extreme caution when lighting burners this way.

Surface burners in use when an electrical power failure occurs will continue to operate normally.

## Before Lighting a Gas Burner

- If drip pans are supplied with your range, they should be used at all times.
- Make sure all grates on the range are in place before using any burner.

## After Lighting a Gas Burner

- Do not operate the burner for an extended period of time without cookware on the grate. The finish on the grate may chip without cookware to absorb the heat.
- Be sure the burners and grates are cool before you place your hand, a pot holder, cleaning cloths or other materials on them.

## Using the gas surface burners (cont.).

### Top-of-Range Cookware

**Aluminum:** Medium-weight cookware is recommended because it heats quickly and evenly. Most foods brown evenly in an aluminum skillet. Use saucepans with tight-fitting lids when cooking with minimum amounts of water.

**Cast-Iron:** If heated slowly, most skillets will give satisfactory results.

**Enamelware:** Under some conditions, the enamel of some cookware may melt. Follow cookware manufacturer's recommendations for cooking methods.

**Glass:** There are two types of glass cookware—those for oven use only and those for top-of-range cooking (saucepans, coffee and teapots). Glass conducts heat very slowly.

**Heatproof Glass Ceramic:** Can be used for either surface or oven cooking. It conducts heat very slowly and cools very slowly. Check cookware manufacturer's directions to be sure it can be used on gas ranges.

**Stainless Steel:** This metal alone has poor heating properties and is usually combined with copper, aluminum or other metals for improved heat distribution. Combination metal skillets usually work satisfactorily if they are used with medium heat as the manufacturer recommends.

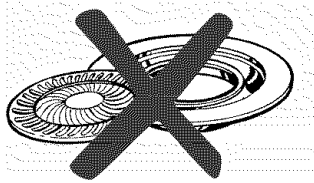

### Stove Top Grills

Do not use stove top grills on your sealed gas burners. If you use the stove top grill on the sealed gas burner, it will cause incomplete combustion and can result in exposure to carbon monoxide levels above allowable current standards.

*This can be hazardous to your health.*



Use a flat-bottomed wok.

### Wok This Way

We recommend that you use a flat-bottomed wok. They are available at your local retail store.

Only a flat-bottomed wok should be used. Do not use a flat-bottomed wok with a wok holder.

Do not use a flat-bottomed wok on a support ring. Placing the ring over the burner or grate may cause the burner to work improperly, resulting in carbon monoxide levels above allowable current standards. This could be dangerous to your health.

# Using the electric glass top warming zone (on some models).

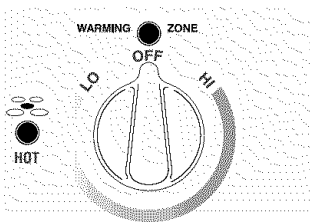

The **WARMING ZONE**, located in the back center of the glass surface, will keep hot, cooked food at serving temperature. Always start with hot food. Do not use to heat cold food.

Push and turn the control knob to any desired setting.

For best results, all foods on the **WARMING ZONE** should be covered with a lid or aluminum foil. When warming pastries or breads, the cover should be vented to allow moisture to escape.

Always use potholders or oven mitts when removing food from the **WARMING ZONE**, as cookware and plates will be hot.

A **HOT** surface indicator light will glow when the glass surface is hot and will remain on until the surface is cool enough to touch.

A **WARMING ZONE** indicator light will glow when the unit is on.

**NOTE:** The **WARMING ZONE** cannot be used during a self-clean cycle.

Food Type	Control Setting
Breads/Pastries	LO
Casseroles	LO
Dinner Plates with Food	LO
Eggs	LO
Gravies	LO
Meats	Medium
Sauces	Medium
Soups (cream)	Medium
Stews	Medium
Vegetables	Medium
Fried Foods	HI
Hot Beverages	HI
Soups (liquid)	HI

The chart above shows initial suggested settings only. The temperature, type and amount of food, and the time held will affect the quality of the food.

**CAUTION:** Do not warm food on the **WARMING ZONE** for more than two hours.

- Do not use plastic wrap to cover food. Plastic may melt onto the surface and be very difficult to clean.
- Use only cookware recommended for oven or top-of-range cooking.



Never cook directly on the glass. Always use cookware.

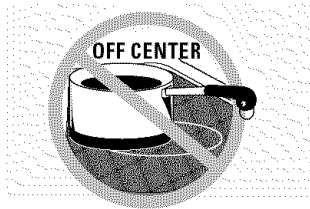

Always place the pan in the center of the warming zone.

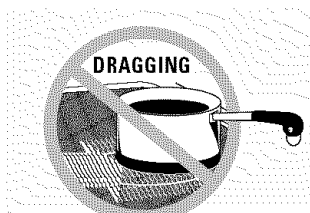

## About the glass surface (on some models)...

The **WARMING ZONE** features heating units beneath a smooth glass surface.

The **WARMING ZONE** unit will cycle on and off to maintain your selected control setting.

It is safe to place hot cookware on the glass surface even when the cooktop is cool.

- Water stains (mineral deposits) are removable using the cleaning cream or full strength white vinegar.
- Use of window cleaner may leave an iridescent film on the cooktop. The cleaning cream will remove this discoloration.

Do not slide cookware across the cooktop because it can scratch the glass—the glass is scratch resistant, not scratch proof.

- Don't store heavy items above the cooktop. If they drop onto the cooktop, they can cause damage.
- Do not use the surface as a cutting board.

**NOTE:** A slight odor is normal when a new cooktop is used for the first time. It is caused by the heating of new parts and insulating materials and will disappear in a short time.

**NOTE:** On some models with a white glass cooktop, it is normal for the surface to appear discolored when it is hot. This is temporary and will disappear as the glass cools.

## Using the oven controls.

Throughout this manual, features and appearance may vary from your model.

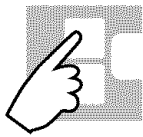
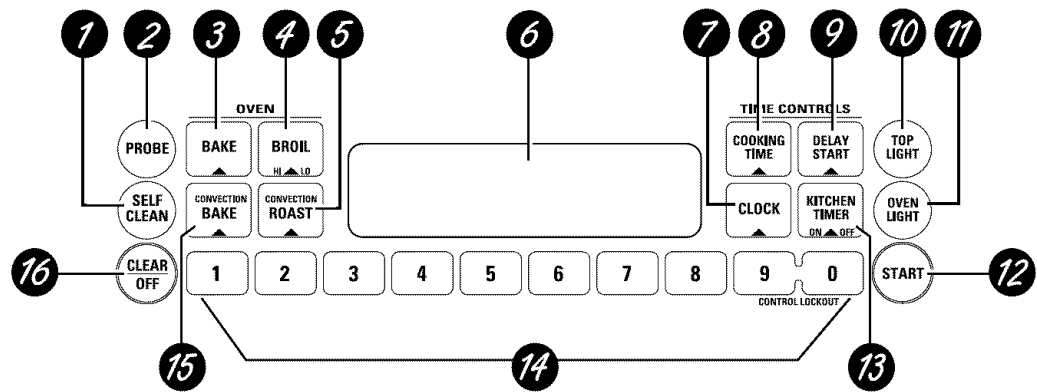

## Oven Control, Clock and Timer Features and Settings

- 1** **SELF CLEAN Pad**  
Touch this pad to select the self-cleaning function. See the *Using the self-cleaning oven* section.
- 2** **PROBE Pad (on some models)**  
Touch this pad when using the probe to cook food to the desired internal temperature.
- 3** **BAKE Pad**  
Touch this pad to select the bake function.
- 4** **BROIL HI/LO Pad**  
Touch this pad to select the broil function.
- 5** **CONVECTION ROAST Pad**  
Touch this pad to select roasting with the convection function.
- 6** **Display**  
Shows the time of day, oven temperature, whether the oven is in the bake, broil, convection, or self-cleaning mode and the times set for the timer or automatic oven operations.  
  
*If "F-" and a number or letter" flash in the display and the oven control signals, this indicates a function error code.*  
  
*If your oven was set for a timed oven operation and a power outage occurred, the clock and all programmed functions must be reset.*  
  
*The time of day will flash in the display when there has been a power outage.*  
  
*If "Err" appears in the display, you have tried to set a time or temperature outside of the control's limits. Press CLEAR/OFF and enter a new setting.*
- 7** **CLOCK Pad**  
Touch this pad before setting the clock.
- 8** **COOKING TIME Pad**  
Touch this pad and then touch the number pads to set the amount of time you want your food to cook. The oven will shut off when the cooking time has run out.
- 9** **DELAY START Pad**  
Use along with **COOKING TIME** or **SELF CLEAN** pads to set the oven to start and stop automatically at a time you set.
- 10** **TOP LIGHT Pad**  
Touch this pad to turn the surface light on or off.
- 11** **OVEN LIGHT Pad**  
Touch this pad to turn the oven light on or off.
- 12** **START Pad**  
Must be touched to start any cooking or cleaning function.
- 13** **KITCHEN TIMER ON/OFF Pad**  
Touch this pad to select the timer feature.
- 14** **Number Pads**  
Use to set any function requiring numbers such as the time of day on the clock, the timer, the oven temperature, the internal food temperature, the start time and length of operation for timed baking and self-cleaning.
- 15** **CONVECTION BAKE Pad**  
Touch this pad to select baking with the convection function.
- 16** **CLEAR/OFF Pad**  
Touch this pad to cancel **ALL** oven operations except the clock and timer.

## Special features of your oven control.

Your new touch pad control has additional features that you may choose to use. The following are the features and how you may activate them.

The special feature modes can only be activated while the display is showing the time of day. They remain in the control's memory until the steps are repeated.

When the display shows your choice, touch the **START** pad. The special features will remain in memory after a power failure.

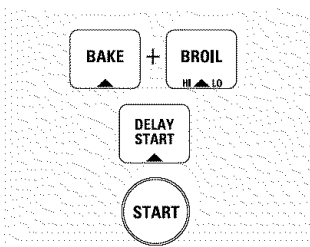

### 12 Hour Shut-Off

With this feature, should you forget and leave the oven on, the control will automatically turn off the oven after 12 hours during baking functions or after 3 hours during a broil function.

If you wish to turn **OFF** this feature, follow the steps below.

- 1 Touch the **BAKE** and **BROIL HI/LO** pads at the same time for 3 seconds until the display shows **SF**.

- 2 Touch the **DELAY START** pad. The display will show **12 shdn** (12 hour shut-off). Touch the **DELAY START** pad again and the display will show **no shdn** (no shut-off).

- 3 Touch the **START** pad to activate the no shut-off and leave the control set in this special features mode.

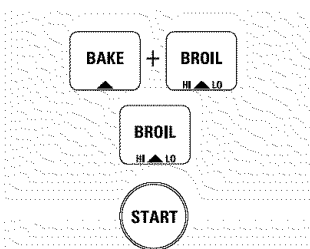

### Fahrenheit or Celsius Temperature Selection

Your oven control is set to use the Fahrenheit temperature selections but you may change this to use the Celsius selections.

- 1 Touch the **BAKE** and **BROIL HI/LO** pads at the same time for 3 seconds until the display shows **SF**.

- 2 Touch the **BROIL HI/LO** pad. The display will show **F** (Fahrenheit).

- 3 Touch the **BROIL HI/LO** pad again. The display will show **C** (Celsius).

- 4 Touch the **START** pad.

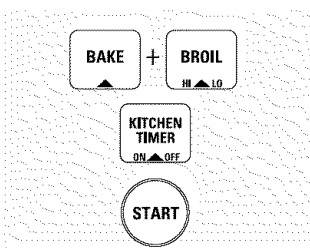

### Tones at the End of a Timed Cycle

At the end of a timed cycle, 3 short beeps will sound followed by one beep every 6 seconds until the **CLEAR/OFF** pad is touched. This continual 6 second beep may be canceled.

To cancel the 6 second beep:

- 1 Touch the **BAKE** and **BROIL HI/LO** pads at the same time for 3 seconds until the display shows **SF**.

- 2 Touch the **KITCHEN TIMER ON/OFF** pad. The display shows **CON BEEP** (continual beep). Touch the **KITCHEN TIMER ON/OFF** pad again. The display shows **BEEP**. (This cancels the one beep every 6 seconds.)

- 3 Touch the **START** pad.

## Special features of your oven control (cont.).

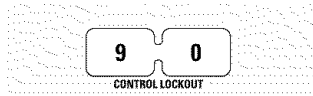

### Control Lockout (on some models)

Your control will allow you to lock out the touch pads so they cannot be activated when touched or cleaning the glass panel.

To lock the controls:

- 1 Touch the **9** and **0** touch pads at the same time for 3 seconds until the control beeps twice. The display will show **LOC** continuously and the time of day if not blacked out.

**NOTE:** All cooking and timing functions will be cancelled when locking out the control.

- 2 To unlock the control, touch the **9** and **0** touch pads at the same time for 3 seconds until the control beeps twice, and **LOC** will be removed from the display.

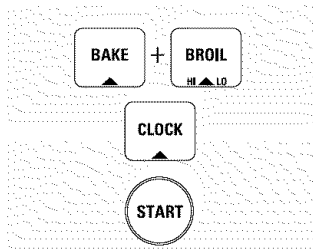

### 12 Hour, 24 Hour or Clock Black-Out

Your control is set to use a 12 hour clock.

If you would prefer to have a 24 hour military time clock or black-out the clock display, follow the steps below.

- 1 Touch the **BAKE** and **BROIL HI/LO** pads at the same time for 3 seconds until the display shows **SF**.
- 2 Touch the **CLOCK** pad once. The display will show **12 hr**. If this is the choice you want, touch the **START** pad.

Touch the **CLOCK** pad again to change to the 24 hour military time clock. The display will show **24 hr**. If this is the choice you want, touch the **START** pad.

Touch the **CLOCK** pad again to black-out the clock display. The display will show **OFF**. If this is the choice you want, touch the **START** pad.

**NOTE:** If the clock is in the black-out mode you will not be able to use the Delay Start function.

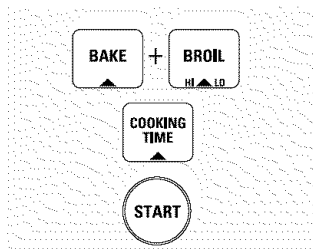

### Cook and Hold

Your new control has a cook and hold feature that keeps cooked foods warm for up to 3 hours after the cooking function is finished.

This feature can only be used when timed cooking.

To activate this feature, follow the steps below.

- 1 Touch the **BAKE** and **BROIL HI/LO** pads at the same time for 3 seconds until the display shows **SF**.

- 2 Touch the **COOKING TIME** pad. The display will show **Hid OFF**.

Touch the **COOKING TIME** pad again to activate the feature. The display will show **Hid ON**.

- 3 Touch the **START** pad to activate the cook and hold feature and leave the control set in this special features mode.

**Notes.**

---

***Safety Instructions***

***Operating Instructions***

***Installation Instructions***

***Troubleshooting Tips***

***Customer Service***

## Using the oven.

To avoid possible burns, place the shelves in the desired position before you turn the oven on.

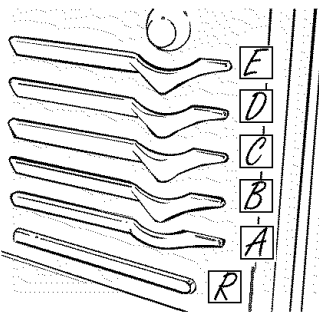

The oven has 5 shelf positions.  
It also has a special low shelf position (R) for extra large items, such as a large turkey.

### Before you begin...

The shelves have stop-locks, so that when placed correctly on the supports, they will stop before coming completely out, and will not tilt.

When placing and removing cookware, pull the shelf out to the bump on the shelf support.

**To remove a shelf**, pull it toward you, tilt the front end up and pull it out.

**To replace**, place the end of the shelf (stop-locks) on the support, tilt up the front and push the shelf in.

**NOTE:** The shelf is not designed to slide out at the special low shelf (R) position.

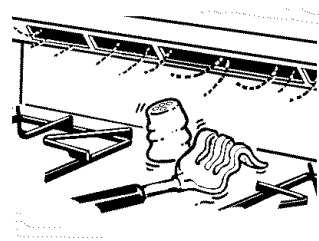

Plastic items on the cooktop may melt if left too close to the vent.  
Vent appearance and location vary.

### Oven Vent

Your oven is vented through ducts at the rear of the range. Do not block these ducts when cooking in the oven—it is important that the flow of hot air from the oven and fresh air to the oven burner be uninterrupted. Avoid touching the vent openings or nearby surfaces during oven or broiler operation—they may become hot.

- Handles of pots and pans on the cooktop may become hot if left too close to the vent.
- Do not leave plastic items on the cooktop—they may melt if left too close to the vent.
- Do not leave any items on the cooktop. The hot air from the vent may ignite flammable items and will increase pressure in closed containers, which may cause them to burst.
- Metal items will become very hot if they are left on the cooktop, and could cause burns.

### Power Outage

**CAUTION:** Do not make any attempt to operate the electric ignition oven during an electrical power failure.

The oven or broiler cannot be lit during a power failure. Gas will not flow unless the glow bar is hot.

If the oven is in use when a power failure occurs, the oven burner shuts off and cannot be re-lit until power is restored. This is because the flow of gas is automatically stopped and will not resume when power is restored until the glow bar has reached operating temperature.

### Oven Light

Touch the **OVEN LIGHT** pad on the upper control panel to turn the light on or off.



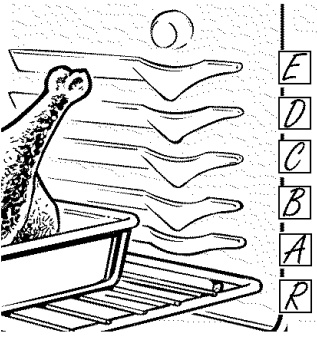

The oven has a special low shelf (R) position just above the oven bottom. Use it when extra cooking space is needed, for example, when cooking a large turkey. The shelf is not designed to slide out at this position.

### How to Set the Oven for Baking or Roasting

- 1 Touch the **BAKE** pad.
- 2 Touch the number pads to set the desired temperature.
- 3 Touch the **START** pad.

The word **ON** and **100°** will be displayed. As the oven heats up, the display will show the changing temperature. When the oven reaches the temperature you set, a tone will sound.

To change the oven temperature during **BAKE** cycle, press the **BAKE** pad and then the number pads to get the new temperature.

- 4 Check food for doneness at minimum time on recipe. Cook longer if necessary.
- 5 Touch the **CLEAR/OFF** pad when cooking is complete.

Type of Food	Shelf Position
Frozen pies (on cookie sheet)	B or C
Angel food cake, bundt or pound cakes	A
Biscuits, muffins, brownies, cookies, cupcakes, layer cakes, pies	C
Casseroles	B or C
Roasting	R or A

### Preheating and Pan Placement

Preheat the oven if the recipe calls for it. To preheat, set the oven at the correct temperature. Preheating is necessary when convection baking and for good results when baking cakes, cookies, pastry and breads.

For ovens without a preheat indicator light or tone, preheat 10 minutes.

Baking results will be better if baking pans are centered in the oven as much as possible. Pans should not touch each other or the walls of the oven. If you need to use two shelves, stagger the pans so one is not directly above the other, and leave approximately 1½" between pans, from the front, back and sides of the wall.

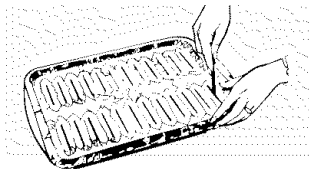

Cut slits in the foil just like the grid.

### Aluminum Foil

Never cover the oven bottom with aluminum foil.

You can use aluminum foil to line the broiler pan and broiler grid. However, you must mold the foil tightly to the grid and cut slits in it just like the grid.

Aluminum foil may also be used to catch a spillover.

Never entirely cover a shelf with aluminum foil. This will disturb the heat circulation and result in poor baking.

A smaller sheet of foil may be used to catch a spillover by placing it on a lower shelf several inches below the food.

### Oven Moisture

As your oven heats up, the temperature change of the air in the oven may cause water droplets to form on the door glass. These droplets are harmless and will evaporate as the oven continues to heat up.

## Using the oven (cont.).

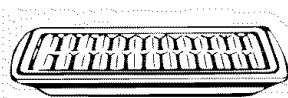

Always use the broiler pan and grid that came with your oven. It is designed to minimize smoking and spattering by trapping juices in the shielded lower part of the pan.

### How to Set the Oven for Broiling

- 1 Place the meat or fish on the broiler grid in the broiler pan.
- 2 Follow suggested shelf positions in the *Broiling Guide*.
- 3 The oven door **must** be closed during broiling.
- 4 Touch the **BROIL HI/LO** pad once for **HI Broil**.

To change to **LO Broil**, touch the **BROIL HI/LO** pad again.

- 5 Touch the **START** pad.
- 6 When broiling is finished, touch the **CLEAR/OFF** pad.

Serve the food immediately, and leave the pan outside the oven to cool during the meal for easiest cleaning.

Use **LO Broil** to cook foods such as poultry or thick cuts of meat thoroughly without over-browning them.

The size, weight, thickness, starting temperature, and your preference of doneness will affect broiling times. This guide is based on meats at refrigerator temperature.

*†The U.S. Department of Agriculture says "Rare beef is popular, but you should know that cooking it to only 140°F. means some food poisoning organisms may survive." (Source: [Safe Food Book, Your Kitchen Guide](#), USDA Rev. June 1985.)*

### Broiling Guide

Food	Quantity and/or Thickness	Shelf Position	First Side Time (min.)	Second Side Time (min.)	Comments
<b>Bacon</b>	1/2 lb. (about 8 thin slices)	C	4	3	Arrange in single layer.
<b>Ground Beef</b> Well Done	1 lb. (4 patties) 1/2 to 3/4" thick	D	10-11	7	Space evenly. Up to 8 patties take about the same time.
<b>Beef Steaks</b>					Steaks less than 1" thick cook through before browning. Pan frying is recommended. Slash fat.
Rare†	1" thick	C	9	7	
Medium	1 to 1½ lbs.	C	12	5-6	
Well Done		C	13	8-9	
Rare†	1½" thick	C	10	6-7	
Medium	2 to 2½ lbs.	C	12-15	10-12	
Well Done		C	25	16-18	
<b>Chicken</b>	1 whole 2 to 2½ lbs., split lengthwise 4 bone-in breasts	B	30-35	15-20	Brush each side with melted butter. Broil skin-side-down first.
<b>Lobster Tails</b>	2-4 6 to 8 oz. each	C	13-16	Do not turn over.	Cut through back of shell. Spread open. Brush with melted butter before broiling and after half of broiling time.
<b>Fish Fillets</b>	1/4 to 1/2" thick	D	6	6	Handle and turn very carefully. Brush with lemon butter before and during cooking, if desired. Preheat broiler to increase browning.
<b>Ham Slices</b> (precooked)	1" thick	C	8	8	
	1/2" thick	D	6	6	
<b>Pork Chops</b> Well Done	2 (1/2" thick) 2 (1" thick) about 1 lb.	D D	10 15	8 8	Slash fat.
<b>Lamb Chops</b> Medium	2 (1" thick) about 10	D	8	4-7	Slash fat.
Well Done	to 12 oz.	D	10	10	
Medium	2 (1½" thick) about 1 lb.	D	10	4-6	
Well Done		D	17	12-14	

# Using the clock and timer.

Not all features are on all models.



Make sure the clock is set to the correct time of day.

## To Set the Clock

The clock must be set to the correct time of day for the automatic oven timing functions to work properly. The time of day cannot be changed during a timed baking or self-cleaning cycle.

- 1 Touch the **CLOCK** pad.
- 2 Touch the number pads.

Touch the number pads the same way you read them. For example, to set 12:34, touch the number pads **1**, **2**, **3** and **4** in that order.

If number pads are not touched within one minute after you touch the **CLOCK** pad, the display reverts to the original setting. If this happens, touch the **CLOCK** pad and reenter the time of day.

- 3 Touch the **START** pad until the time of day shows in the display. This enters the time and starts the clock.

To check the time of day when the display is showing other information, simply touch the **CLOCK** pad. The time of day shows until another pad is touched.



The timer is a minute timer only.  
The **CLEAR/OFF** pad does not affect the timer.

## To Set the Timer

The timer does not control oven operations. The maximum setting on the timer is 9 hours and 59 minutes.

- 1 Touch the **KITCHEN TIMER ON/OFF** pad.
- 2 Touch the number pads until the amount of time you want shows in the display. The maximum number of minutes that can be entered is 60. To set additional time, you will need to set it by hours and minutes. For example, to enter 1 hour and 30 minutes, touch **1**, **3** and **0** in that order.

If you make a mistake, press the **KITCHEN TIMER ON/OFF** pad and begin again.

- 3 Touch the **START** pad. After pressing the **START** pad, **SET** disappears; this tells you the time is counting down, although the display does not change until one minute has passed.

- 4 When the timer reaches **:00**, the control will beep 3 times followed by one beep every 6 seconds until the **KITCHEN TIMER ON/OFF** pad is touched.

The 6 second tone can be canceled by following the steps in the Special features of your oven control section under Tones at the End of a Timed Cycle.

## To Reset the Timer

If the display is still showing the time remaining, you may change it by touching the **KITCHEN TIMER ON/OFF** pad, then touch the number pads until the time you want appears in the display.

If the remaining time is not in the display (clock, delay start or cooking time are in the display), recall the remaining time by touching the **KITCHEN TIMER ON/OFF** pad and then touching the number pads to enter the new time you want.

## To Cancel the Timer

Touch the **KITCHEN TIMER ON/OFF** pad twice.

## Power Outage

If a flashing time is in the display, you have experienced a power failure. Reset the clock.

To reset the clock, touch the **CLOCK** pad. Enter the correct time of day by touching the appropriate number pads. Touch the **START** pad.

## Using the timed baking and roasting features.

**NOTE:** Foods that spoil easily—such as milk, eggs, fish, stuffings, poultry and pork—should not be allowed to sit for more than 1 hour before or after cooking. Room temperature promotes the growth of harmful bacteria. Be sure that the oven light is off because heat from the bulb will speed harmful bacteria growth.

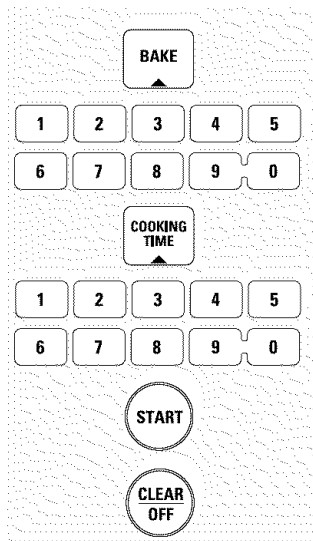

### How to Set an Immediate Start and Automatic Stop

The oven will turn on immediately and cook for a selected length of time. At the end of the cooking time the oven will turn off automatically.

- 1 Touch the **BAKE** pad.
- 2 Using the number pads, enter the desired temperature.
- 3 Touch the **COOKING TIME** pad.

**NOTE:** If your recipe requires preheating, you may need to add additional time to the length of the cooking time.

- 4 Using the number pads, enter the desired baking time. The oven temperature and the cooking time that you entered will be displayed.
- 5 Touch the **START** pad.

The word **ON** and **100°** will be displayed. The cook time will begin to count down. As the oven heats up, the display will show the changing temperature. When the oven reaches the temperature you set, 3 beeps will sound.

At the end of timed baking, the oven will turn off. The end of cycle tone will sound.

Touch the **CLEAR/OFF** pad to clear the display.

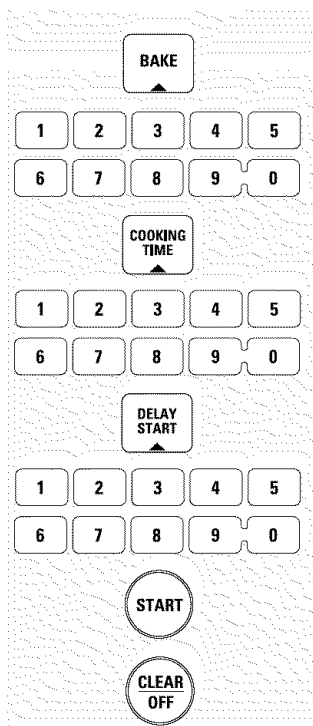

### How to Set a Delayed Start and Automatic Stop

You can set the oven control to delay-start the oven, cook for a specific length of time and then turn off automatically.

Make sure the clock shows the correct time of day.

- 1 Touch the **BAKE** pad.
- 2 Using the number pads, enter the desired temperature.
- 3 Touch the **COOKING TIME** pad.

**NOTE:** If your recipe requires preheating, you may need to add additional time to the length of the cooking time.

- 4 Using the number pads, enter the desired baking time.
- 5 Touch the **DELAY START** pad.
- 6 Using the number pads, enter the time of day you want the oven to turn on and start cooking.
- 7 Touch the **START** pad.

**NOTE:** An attention tone will sound if you are using timed baking and do not touch the **START** pad after entering the baking temperature.

If you would like to check the times you have set, touch the **DELAY START** pad to check the start time you have set or touch the **COOKING TIME** pad to check the length of cooking time you have set.

The oven will turn on automatically. The word **ON** and **100°** will be displayed. The cook time will begin to count down.

As the oven heats up, the display will show the changing temperature. The oven will cook for the programmed cooking time and shut off automatically.

At the end of timed baking, the oven will turn off. The end of cycle tone will sound.

Touch the **CLEAR/OFF** pad to clear the display.

## Using the probe (on some models).

For many foods, especially roasts and poultry, internal food temperature is the best test for doneness. The temperature probe takes the guesswork out of roasting by cooking foods to the exact doneness you want.

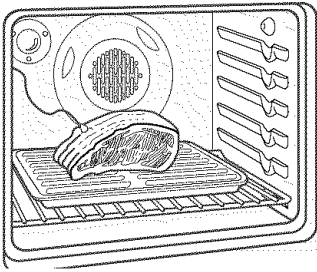

The temperature probe has a skewer-like probe at one end and a plug at the other end that goes into the outlet in the oven.

Use of probes other than the one provided with this product may result in damage to the probe.

Use the handles of the probe and plug when inserting and removing them from the food and outlet.

- To avoid damaging your probe, do not use tongs to pull on the cable when removing it.
- To avoid breaking the probe, make sure food is completely defrosted before inserting.
- To prevent possible burns, do not unplug the probe from the outlet until the oven has cooled.

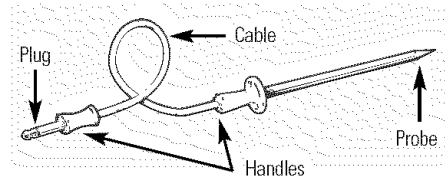

- Never leave your probe inside the oven during a self-cleaning cycle.
- Do not store the probe in the oven.

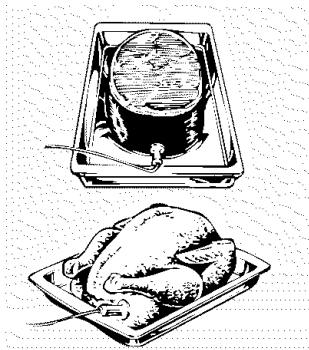

After preparing the meat and placing it on a trivet or on the broiler pan grid, follow these directions for proper probe placement.

Insert the probe completely into the meat. It should not touch the bone, fat or gristle.

For roasts with no bone, insert the probe into the meatiest part of the roast. For bone-in ham or lamb, insert the probe into the center of the lowest large muscle.

Insert the probe into the center of dishes such as meat loaf or casseroles.

Insert the probe into the meatiest part of the inner thigh from below and parallel to the leg of a whole turkey.

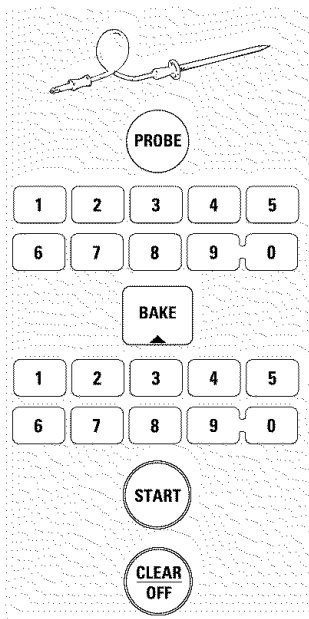

### How to Set the Oven For Roasting When Using the Probe

- 1 Insert the probe into the food.
- 2 Plug the probe into the outlet in the oven. Make sure it's pushed all the way in. Close the oven door.
- 3 Touch the **PROBE** pad.
- 4 Touch the number pads to set the desired internal food or meat temperature.
- 5 Touch the **BAKE** pad.
- 6 Touch the number pads to set the desired oven temperature.
- 7 Touch the **START** pad.

The display will flash if the probe is inserted into the outlet and you have not set a probe temperature and touched the **START** pad.

After the internal temperature of the food reaches 100°F., the changing internal temperature will be shown in the display.

- 8 When the internal temperature of the food reaches the number you have set, the probe and the oven turn off and the oven control signals. To stop the signal, touch the **CLEAR/OFF** pad. Use hot pads to remove the probe from the food. Do not use tongs to pull on it—they might damage it.

To change the oven temperature during the Roast cycle, touch the **BAKE** pad and then the number pads to set the new temperature.

- If the probe is removed from the food before the final temperature is reached, a tone will sound and the display will flash until the probe is removed from the oven.
- You can use the timer even though you cannot use timed oven operations while using the probe.

## Using the convection oven.

The convection oven fan shuts off when the oven door is opened. **DO NOT** leave the door open for long periods of time while using convection cooking.

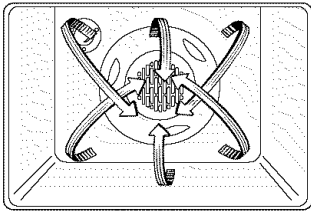

In a convection oven, a fan circulates hot air over, under and around the food. This circulating hot air is evenly distributed throughout the oven cavity. As a result, foods are evenly cooked and browned—often in less time than with regular heat.

To help you understand the difference between convection bake and roast and traditional bake and roast, here are some general guidelines.

### Convection Bake

- Preheat the oven. See the *Using the Oven—Preheating and Pan Placement* section.
- Ideal for foods cooked on multiple shelves.
- Good for large quantities of baked foods.
- Good results with cookies, biscuits, brownies, cupcakes, cream puffs, sweet rolls, angel food cake and bread.

The convection fan circulates the heated air evenly over and around the food.

### Convection Roast

- Good for large tender cuts of meat, uncovered.

The convection fan circulates the heated air evenly over and around the food. Using the grid and broiler pan provided, heated air will be circulated over and around the food being roasted. The heated air seals in juices quickly for a moist and tender product while, at the same time, creating a rich golden brown exterior.

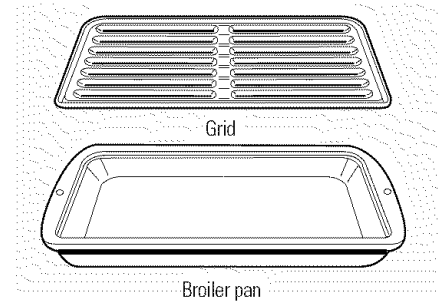

Roasts or poultry should be cooked on shelf position (A).

When you are convection roasting it is important that you use the broiler pan and grid for best convection roasting results. The pan is used to catch grease spills and the grid is used to prevent grease spatters.

- Place the shelf in shelf position (A).
- Place the grid on the broiler pan.

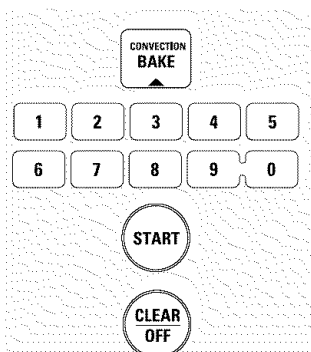

### Automatic Convection Conversion

You can use your favorite recipes in the convection oven.

When using **CONVECTION BAKE**, the oven will automatically convert the oven temperature from regular baking to Convection Bake temperatures.

**1** Using the number pads, enter the temperature recommended in the recipe.

**2** Touch the **START** pad.

The display will show the temperature you entered from your recipe. The oven will automatically convert it to the convection cooking temperature.

**3** Touch the **CLEAR/OFF** pad when baking is finished.

- Use pan size recommended.
- Some package instructions for frozen casseroles or main dishes have been developed using commercial convection ovens. For best results in this oven, preheat the oven and use the temperature on the package.

### Cookware for Convection Cooking

Before using your convection oven, check to see if your cookware leaves room for air circulation in the oven. If you are baking with several pans, leave space between them. Also, be sure the pans do not touch each other or the walls of the oven.

### Paper and Plastic

Heat-resistant paper and plastic containers that are recommended for use in regular ovens can be used in convection ovens. Plastic cookware that is heat-resistant to temperatures of 400°F. can also be used, when oven is below 400°F.

### Metal and Glass

Any type of cookware will work in your convection oven. However, metal pans heat the fastest and are recommended for convection baking.

■ *Darkened or matte-finished pans will bake faster than shiny pans.*

■ *Glass or ceramic pans cook more slowly.*

When baking cookies, you will get the best results if you use a flat cookie sheet instead of a pan with low sides.

For recipes like oven-baked chicken, use a pan with low sides. Hot air cannot circulate well around food in a pan with high sides.

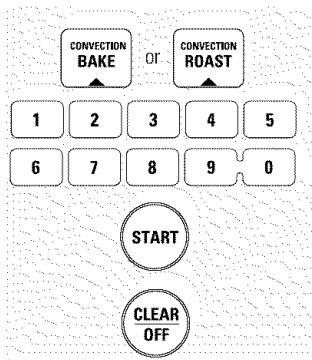

### How to Set the Oven for Convection Baking or Roasting

- 1 Touch the **CONVECTION BAKE** or **CONVECTION ROAST** pad.
- 2 Touch the number pads to set the desired oven temperature.
- 3 Touch the **START** pad.

To change the oven temperature, touch the **CONVECTION BAKE** or **CONVECTION ROAST** pad and then the number pads to set the new temperature.

When the oven starts to heat the changing temperature, starting at 100°F., will be displayed. When the oven reaches the temperature you set, 3 beeps will sound.

- 4 Touch the **CLEAR/OFF** pad when finished.

**NOTE:** You will hear a fan while cooking with convection. The fan will stop when the door is opened but the heat will not turn off. The fan will not start until the preheat temperature is reached.

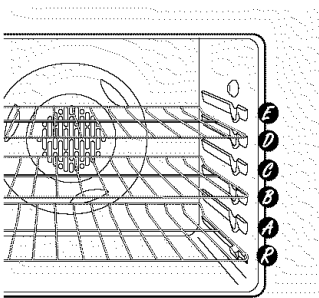

When convection baking with only 1 shelf, follow the shelf positions recommended in the Using the Oven section.

### Multi-Shelf Baking

Because heated air is circulated evenly throughout the oven, foods can be baked with excellent results using multiple shelves.

Multi-shelf baking may increase cook times slightly for some foods but the overall result is time saved. Cookies, muffins, biscuits, and other quick breads give very good results with multi-shelf baking.

When baking larger foods on 3 shelves, place one shelf in the 2nd (A) position, one on the 4th (C) position and the third shelf in the 6th (E) position.

When baking cookies, place the shelves in the 4th (C), 5th (D), and 6th (E) positions.

## Using the convection oven (cont.).

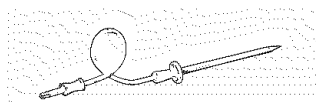

For best results when roasting large turkeys and roasts, we recommend using the probe included in the convection oven.

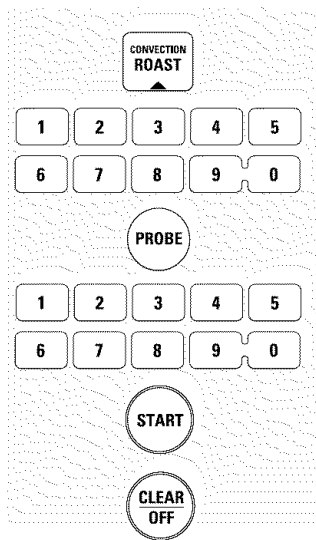

### How to Set the Oven for Convection Roasting when Using the Probe (on some models)

The display will flash **PROBE** and the oven control will signal if the probe is inserted into the outlet, and you have not set a probe temperature and touched the **START** pad.

- 1 Place the shelf in the shelf position (A). Insert the probe completely into the food.
- 2 Plug the probe into the outlet in the oven. Make sure it is pushed all the way in. Close the oven door.
- 3 Touch the **CONVECTION ROAST** pad.
- 4 Touch the number pads to set the desired oven temperature.
- 5 Touch the **PROBE** pad.
- 6 Touch the number pads to set the desired internal food temperature.

To change the oven temperature during the Convection Roast cycle, touch the **CONVECTION ROAST** pad and then touch the number pads to set the new desired temperature.

- 7 Touch the **START** pad.

When the oven starts to heat, the word **LO** will be in the display.

After the internal temperature of the food reaches 100°F., the changing internal temperature will be shown in the display.

- 8 When the internal temperature of the food reaches the number you have set, the probe and the oven turn off and the oven control signals. To stop the signal, touch the **CLEAR/OFF** pad. Use hot pads to remove the probe from the food. Do not use tongs to pull on it—they might damage it.

**CAUTION:** To prevent possible burns, do not unplug the probe from the oven outlet until the oven has cooled. Do not store the probe in the oven.

#### NOTE:

- If the probe is removed from the food before the final temperature is reached, a tone will sound and the display will flash until the probe is removed from the oven.
- You will hear a fan while cooking with this feature. The fan will stop when the door is opened but the heat will not turn off.
- You can use the timer even though you cannot use timed oven operations while using the probe.



## Convection Roasting Guide

Meats			Minutes/Lb.	Oven Temp.	Internal Temp.	
<b>Beef</b>	Rib (3 to 5 lbs.)	Rare†	20–24	325°F.	140°F.	
		Medium	24–28	325°F.	160°F.	
		Well	28–32	325°F.	170°F.	
	Boneless Rib, Top Sirloin	Rare†	20–24	325°F.	140°F.	
Medium		24–28	325°F.	160°F.		
Well		28–32	325°F.	170°F.		
Beef Tenderloin	Rare†	10–14	325°F.	140°F.		
	Medium	14–18	325°F.	160°F.		
	Pot Roast (2 ½ to 3 lbs.) chuck, rump		35–45	300°F.	170°F.	
<b>Pork</b>	Bone-in (3 to 5 lbs.)		23–27	325°F.	170°F.	
	Boneless (3 to 5 lbs.)		23–27	325°F.	170°F.	
	Pork Chops (½ to 1" thick)	2 chops	30–35 total	325°F.	170°F.	
		4 chops	35–40 total	325°F.	170°F.	
6 chops		40–45 total	325°F.	170°F.		
<b>Ham</b>	Canned (3 lbs. fully cooked)		14–18	325°F.	140°F.	
	Butt (5 lbs. fully cooked)		14–18	325°F.	140°F.	
	Shank (5 lbs. fully cooked)		14–18	325°F.	140°F.	
<b>Lamb</b>	Bone-in (3 to 5 lbs.)	Medium	17–20	325°F.	160°F.	
		Well	20–24	325°F.	170°F.	
	Boneless (3 to 5 lbs.)	Medium	17–20	325°F.	160°F.	
		Well	20–24	325°F.	170°F.	
<b>Seafood</b>	Fish, whole (3 to 5 lbs.)		30–40 total	400°F.		
	Lobster Tails (6 to 8 oz. each)		20–25 total	350°F.		
<b>Poultry</b>	Whole Chicken (2 ½ to 3 ½ lbs.)		24–26	350°F.	180°–185°F.	
	Cornish Hens Unstuffed (1 to 1½ lbs.)		50–55 total	350°F.	180°–185°F.	
			55–60 total	350°F.	180°–185°F.	
	Duckling (4 to 5 lbs.)		24–26	325°F.	180°–185°F.	
	Turkey, whole*	Unstuffed (10 to 16 lbs.)		8–11	325°F.	180°–185°F.
		Unstuffed (18 to 24 lbs.)		7–10	325°F.	180°–185°F.
Turkey Breast (4 to 6 lbs.)		16–19	325°F.	170°F.		

\* Stuffed birds generally require 30–45 minutes additional roasting time. Shield legs and breast with foil to prevent over-browning and drying of skin.

† The U.S. Department of Agriculture says "Rare beef is popular, but you should know that cooking it to only 140° F. means some food poisoning organisms may survive." (Source: *Safe Food Book. Your Kitchen Guide. USDA Rev. June 1985.*)

## Using the timed features for convection baking.

You will hear a fan while cooking with this feature. The fan will stop when the door is opened but the heat will not turn off.

**NOTE:** Foods that spoil easily—such as milk, eggs, fish, stuffings, poultry and pork—should not be allowed to sit for more than 1 hour before or after cooking. Room temperature promotes the growth of harmful bacteria. Be sure that the oven light is off because heat from the bulb will speed harmful bacteria growth.

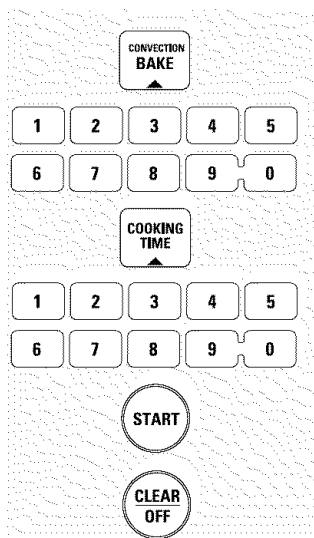

### How to Set an Immediate Start and Automatic Stop

The oven will turn on immediately and cook for a selected length of time. At the end of the cooking time the oven will turn off automatically.

- 1 Touch the **CONVECTION BAKE** pad.
- 2 Touch the number pads to set the desired oven temperature.
- 3 Touch the **COOKING TIME** pad.

**NOTE:** If your recipe requires preheating, you may need to add additional time to the length of the cooking time.

- 4 Touch the number pads to set the desired length of cooking time. The minimum cooking time you can set is 1 minute.

The oven temperature that you set and the cooking time that you entered will be in the display.

- 5 Touch the **START** pad.

The display shows the oven temperature that you set and the cooking time countdown. The display starts changing once the temperature reaches 100°F.

- 6 At the end of timed convection bake the oven will turn off. The end of cycle tone will sound. Touch the **CLEAR/OFF** pad to clear the display if necessary.
- 7 Remove the food from the oven. Remember, foods that are left in the oven continue cooking after the controls are off.

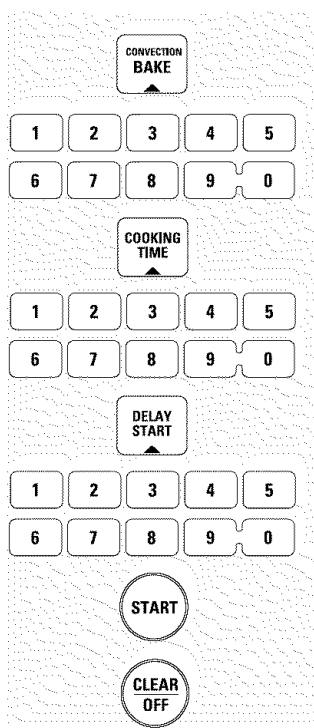

### How to Set a Delayed Start and Automatic Stop

You can set the oven control to delay-start the oven, cook for a specific length of time and then turn off automatically.

Make sure the clock shows the correct time of day.

- 1 Touch the **CONVECTION BAKE** pad.
- 2 Touch the number pads to set the desired oven temperature.
- 3 Touch the **COOKING TIME** pad.

**NOTE:** If your recipe requires preheating, you may need to add additional time to the length of the cooking time.

- 4 Touch the number pads to set the desired cooking time.
- 5 Touch the **DELAY START** pad.
- 6 Touch the number pads to set the time of day you want the oven to turn on and start cooking.

If you would like to check the times you have set, touch the **DELAY START** pad to check the start time you have set or touch the **COOKING TIME** pad to check the length of cooking time you have set.

- 7 Touch the **START** pad.

**NOTE:** An attention tone will sound if you are using timed baking and do not touch the **START** pad after entering the baking temperature.

When the oven turns on at the time of day you have set, the display will show the changing temperature (starting at 100°F.) and the cooking time countdown.

At the end of timed convection bake the oven will turn off. The end of cycle tone will sound.

- 8 Touch the **CLEAR/OFF** pad to clear the display if necessary. When baking is finished, remove the food from the oven. Remember, even though the oven shuts off automatically, foods continue cooking after the controls are off.

## Adjust the oven thermostat—Do it yourself!

You may find that your new oven cooks differently than the one it replaced. Use your new oven for a few weeks to become more familiar with it. If you still think your new oven is too hot or too cold, you can adjust the thermostat yourself.

Do not use thermometers, such as those found in grocery stores, to check the temperature setting of your oven. These thermometers may vary 20–40 degrees.

**NOTE:** This adjustment will not affect the broiling or the self-cleaning temperatures. The adjustment will be retained in memory after a power failure.

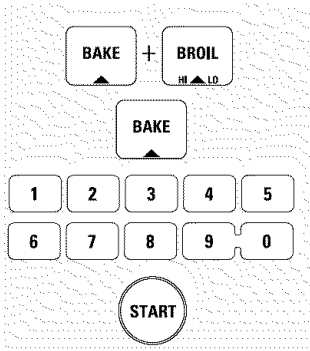

### To Adjust the Thermostat

- 1 Touch the **BAKE** and **BROIL HI/LO** pads at the same time for 3 seconds until the display shows **SF**.
- 2 Touch the **BAKE** pad. A two digit number shows in the display.  
Touch **BAKE** once to decrease (-) the oven temperature, or twice to increase (+).
- 3 The oven temperature can be adjusted up as much as 35°F. or down as much as 35°F. Touch the number pads the same way you read them. For example, to change the oven temperature 15°F., touch **1** and **5**.

- 4 When you have made the adjustment, touch the **START** pad to go back to the time of day display. Use your oven as you would normally.

**NOTE:** The thermostat adjustment for Baking will also affect Convection Baking or Convection Roasting.

## The type of margarine will affect baking performance!

Most recipes for baking have been developed using high fat products such as butter or margarine (80% fat). If you decrease the fat, the recipe may not give the same results as with a higher fat product.

Recipe failure can result if cakes, pies, pastries, cookies or candies are made with low fat spreads. The lower the fat content of a spread product, the more noticeable these differences become.

Federal standards require products labeled “margarine” to contain at least 80% fat by weight. Low fat spreads, on the other hand, contain less fat and more water. The high moisture content of these spreads affects the texture and flavor of baked goods. For best results with your old favorite recipes, use margarine, butter or stick spreads containing at least 70% vegetable oil.

# Using the electric warming drawer.

The warming drawer will keep hot, cooked foods at serving temperature. Always start with hot food. Do not use to heat cold food other than crisping crackers, chips or dry cereal.

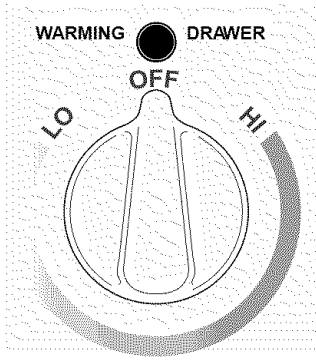

### Control Knob

Push and turn the control knob to any desired setting.

**NOTE:** The warming drawer cannot be used during a self-clean cycle.

<b>LO</b> .....	140–170°F
<b>Medium</b> (mid-position on the knob) .....	170–210°F
<b>HI</b> .....	210–250°F

### ON Signal Light

The **ON** signal light is located above the control knob and glows when the knob is in the on position. It stays on until the knob is moved to the **OFF** position.

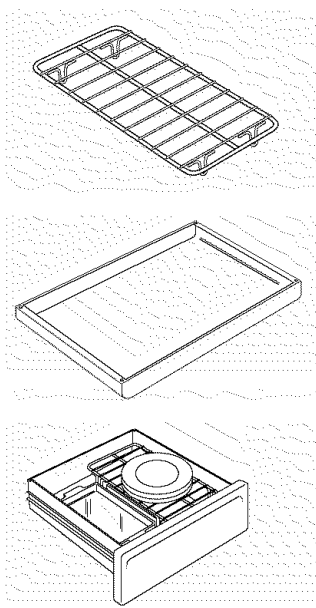

### Pan

- For use in the warming drawer only. Do not use in the oven.
- Use the side handle edges to lift the pan in and out of the drawer for ease of cleaning.
- Do not put liquid or water in the warming pan.

### Rack

- For use in the warming drawer only. Do not use in the oven.
- Rack will fit from front to back.
- Preheat with the rack in place.
- Using the rack allows for double stacking of items.

### When Using the Warming Drawer

The warming drawer will keep hot, cooked foods at serving temperature. Always start with hot food. Do not use to heat cold food other than crisping crackers, chips or dry cereal.

**Do not line the warming drawer or pan with aluminum foil. Foil is an excellent heat insulator and will trap heat beneath it. This will upset the performance of the drawer and could damage the interior finish.**

- Allow time for the drawer to be preheated:
- LO** .....10–15 minutes
- Medium** (mid-position on the knob) .....25–30 minutes
- HI** .....25–35 minutes
- Preheat prior to use according to recommended times.

- Do not put liquid or water in the warming drawer.
- For moist foods, cover them with a lid or aluminum foil.
- For crisp foods, leave them uncovered.
- Food should be kept hot in its cooking container or transferred to a heat-safe serving dish.

**CAUTION:** Plastic containers or plastic wrap will melt if in direct contact with the drawer, pan or a hot utensil. Melted plastic may not be removable and is not covered under your warranty.

- Remove serving spoons, etc., before placing containers in warming drawer.

### Temperature Selection Chart

To keep several different foods hot, set the temperature to the food needing the highest setting. Place the items needing the highest setting on the bottom of the drawer and items needing less heat on the rack.

- The temperature, type and amount of food, and the time held will affect the quality of the food.
- Food in heat-safe glass and glass-ceramic utensils may need a higher thermostat setting as compared to food in metal utensils.
- Repeated opening of the drawer allows the hot air to escape and the food to cool.
- Allow extra time for the temperature inside the drawer to stabilize after adding items.
- With large loads it may be necessary to use a higher thermostat setting and cover some of the cooked food items.
- Do not use plastic containers or plastic wrap.

Food Type	Control Setting
Bacon	HI
Eggs	HI
Fish	HI
Gravy, sauces	HI
Ham	HI
Onion rings	HI
Pies	LO
Pizza	HI
Potatoes, baked	HI
Potatoes, mashed	LO
Tortilla Chips	LO

**CAUTION:** Do not keep food in the warming drawer for more than two hours.

### To Crisp Stale Items

- Place food in low-sided dishes or pans.
- Preheat on **LO** setting.
- Check crispness after 45 minutes. Add time as needed.

### To Warm Serving Bowls and Plates

To warm serving bowls and plates, set the control on **LO**.

- Use only heat-safe dishes.
- Place empty dishes on the rack to raise them off the bottom of the drawer. Placing dishes on the warming drawer bottom may cause them to become extremely hot and could damage them.
- If you want to heat fine china, please check with the manufacturer of the dishes for their maximum heat tolerance.

- You may warm empty serving dishes while preheating the drawer.

- When holding hot, cooked foods and warming empty serving dishes at the same time, place the serving dishes on the rack and the food on the bottom of the drawer.

**CAUTION:** Dishes will be hot. Use pot holders or mitts when removing hot dishes.

## Using the self-cleaning oven.

The oven door must be closed and all controls set correctly for the cycle to work properly.

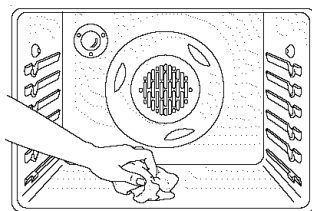

Wipe up heavy soil on the oven bottom.

### Before a Clean Cycle

For the first self-clean cycle, we recommend venting your kitchen with an open window or using a ventilation fan or hood.

Remove the shelves, broiler pan, broiler grid, probe, all cookware and any aluminum foil from the oven.

The oven shelves can be self-cleaned, but they will darken, lose their luster and become hard to slide.

Soil on the front frame of the range and outside the gasket on the door will need to be cleaned by hand. Clean these areas with hot water, soap-filled steel-wool pads or cleansers such as Soft Scrub®. Rinse well with clean water and dry.

Do not clean the gasket. The fiberglass material of the oven door gasket cannot withstand abrasion. It is essential for the gasket to remain intact. If you notice it becoming worn or frayed, replace it.

Wipe up any heavy spillovers on the oven bottom.

Make sure the oven light bulb cover is in place and the oven light is off.

**IMPORTANT:** The health of some birds is extremely sensitive to the fumes given off during the self-cleaning cycle of any range. Move birds to another well ventilated room.

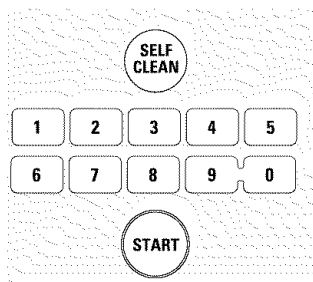

### How to Set the Oven for Cleaning

- 1 Touch the **SELF CLEAN** pad.
- 2 Using the number pads, enter the desired clean time, if a time other than 4 hours is needed.

Clean cycle time is normally 4 hours. You can change the clean time to any time between 3 hours and 5 hours, depending on how dirty your oven is.

- 3 Touch the **START** pad.

The door locks automatically. The display will show the clean time remaining. It will not be possible to open the oven door until the temperature drops below the lock temperature and the **LOCKED DOOR** light goes off.

When the **LOCKED DOOR** light is off, open the door.

The oven shuts off automatically when the clean cycle is complete.

- The words **LOCK DOOR** will flash and the oven control will signal if you set the clean cycle and forget to close the oven door.
- To stop a clean cycle, touch the **CLEAR/OFF** pad. When the **LOCKED DOOR** light goes off indicating the oven has cooled below the locking temperature, open the door.

The oven door must be closed and all controls set correctly for the cycle to work properly.

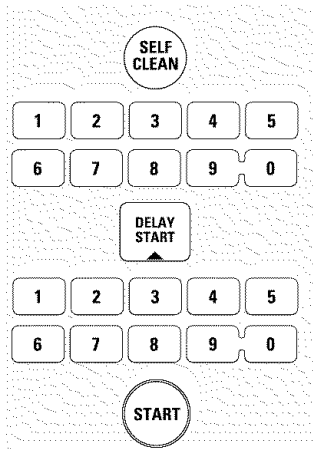

### How to Delay the Start of Cleaning

Make sure the clock shows the correct time of day.

- 1 Touch the **SELF CLEAN** pad.
- 2 Using the number pads, enter the desired clean time.
- 3 Touch the **DELAY START** pad. The earliest start time you can set will appear in the display.
- 4 Using the number pads, enter the time of day you want the clean cycle to start.

- 5 Touch the **START** pad.

The door locks automatically. The display will show the start time. It will not be possible to open the oven door until the temperature drops below the lock temperature and the **LOCKED DOOR** light goes off.

When the **LOCKED DOOR** light is off, open the door.

### After a Clean Cycle

You may notice some white ash in the oven. Wipe it up with a damp cloth after the oven cools.

*If white spots remain, remove them with a soap-filled steel-wool pad and rinse thoroughly with a vinegar and water mixture.*

These deposits are usually a salt residue that cannot be removed by the clean cycle.

If the oven is not clean after one clean cycle, repeat the cycle.

■ You cannot set the oven for cooking until the oven is cool enough for the door to unlock.

■ While the oven is self-cleaning, you can touch the **CLOCK** pad to display the time of day. To return to the clean countdown, touch the **COOKING TIME** pad.

■ If the shelves become hard to slide, apply a small amount of vegetable oil or cooking oil to a paper towel and wipe the edges of the oven shelves with the paper towel.

## Care and cleaning of the range.

Be sure electrical power is off and all surfaces are cool before cleaning any part of the range.

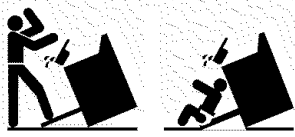

If your range is removed for cleaning, servicing or any reason, be sure the anti-tip device is re-engaged properly when the range is replaced. Failure to take this precaution could result in tipping of the range and cause injury.

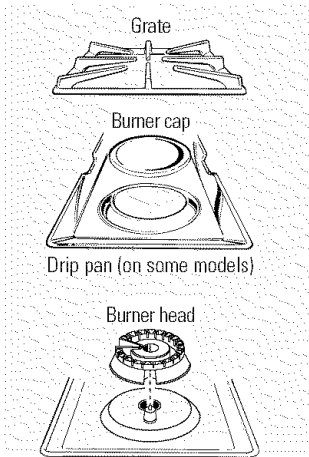

### Sealed Burner Assemblies—porcelain cooktop models

Turn all controls **OFF** before removing the burner parts and drip pans (if so equipped).

The burner grates, caps, burner heads and drip pans (if so equipped) can be lifted off, making them easy to clean.

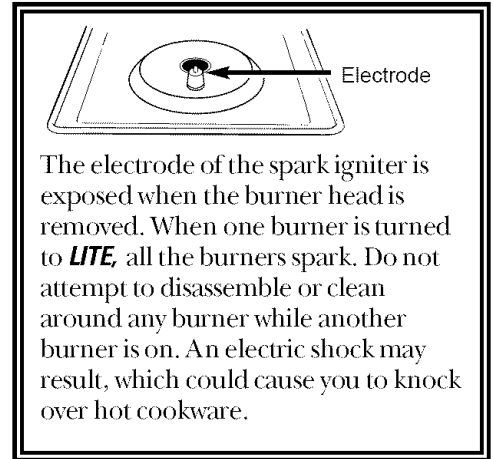

The electrode of the spark igniter is exposed when the burner head is removed. When one burner is turned to **LITE**, all the burners spark. Do not attempt to disassemble or clean around any burner while another burner is on. An electric shock may result, which could cause you to knock over hot cookware.

**▲ CAUTION:** Do not operate the burner without all burner parts and drip pans (if so equipped) in place.

Use a sewing needle or twist-tie to unclog the small hole in the burner head.

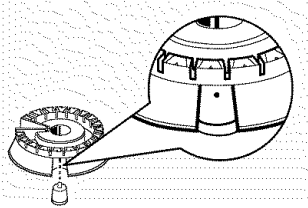

After cleaning, make sure the slot in the burner head is positioned over the electrode.

### Burner Heads

**NOTE:** Before removing the burner heads and caps, remember their size and location. Replace them in the same location after cleaning.

For proper ignition, make sure the small hole in the section that fits over the electrode is kept open. A sewing needle or wire twist-tie works well to unclog it.

The slits in the burner heads of your range must be kept clean at all times for an even, unhampered flame.

You should clean the surface burners routinely, especially after bad spillovers, which could clog these openings.

To remove burned-on food, soak the burner heads in a solution of mild liquid detergent and hot water for 20-30 minutes. For more stubborn stains, use a toothbrush.

Before putting the burner head back, shake out excess water and then dry it thoroughly by setting it in a warm oven for 30 minutes.

Replace the burner heads and caps. Make sure that the heads and caps are replaced in the correct location. There are 2 large, one medium and one small head and cap.

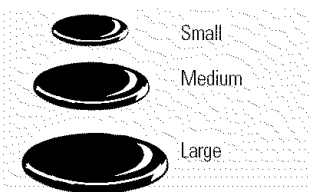

### Burner Caps

Lift off when cool. Wash burner caps in hot, soapy water and rinse with clean water. You may scour with a plastic scouring pad to remove burned-on food particles.

Dry them in a warm oven or with a cloth—don't reassemble them wet. Replace the burner caps.

Make sure that caps are replaced on the correct size burner. There are 2 large, one medium and one small head and cap.



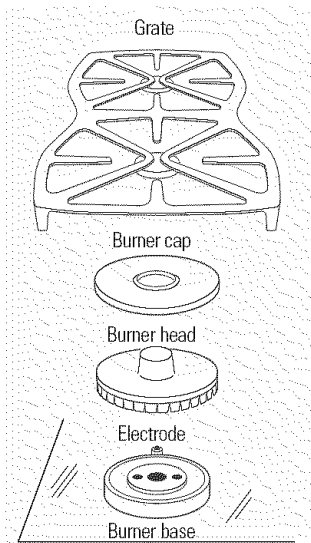

### Sealed Burner Assemblies—glass cooktop models

Turn all controls **OFF** before removing the burner parts.

The burner grates, caps, and burner heads can be lifted off, making them easy to clean.

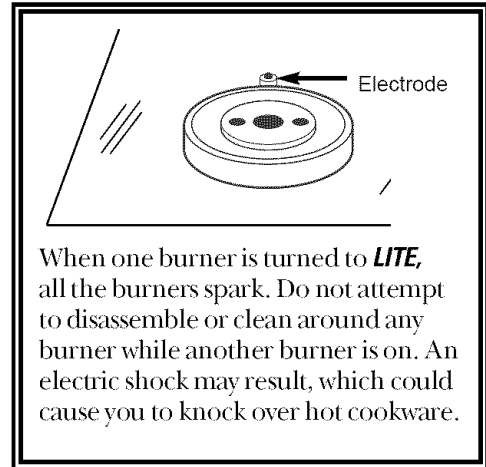

When one burner is turned to **LITE**, all the burners spark. Do not attempt to disassemble or clean around any burner while another burner is on. An electric shock may result, which could cause you to knock over hot cookware.

**CAUTION:** Do not operate the burner without all burner parts in place.

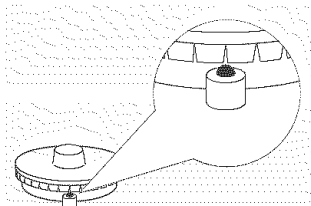

After cleaning, make sure the nipple in the burner head is positioned toward the electrode. Rotate the burner head around the burner base until it is level and securely seated.

### Burner Heads

**NOTE:** Before removing the burner heads and caps, remember their size and location. Replace them in the same location after cleaning.

The slits in the burner heads of your range must be kept clean at all times for an even, unhampered flame.

You should clean the surface burners routinely, especially after bad spillovers, which could clog these openings.

To remove burned-on food, soak the burner heads in a solution of mild liquid detergent and hot water for 20-30 minutes. For more stubborn stains, use a toothbrush.

Before putting the burner head back, shake out excess water and then dry it thoroughly by setting it in a warm oven for 30 minutes.

Replace the burner heads and caps. Make sure that the heads and caps are replaced in the correct location. There are 2 large, one medium and one small head and cap.

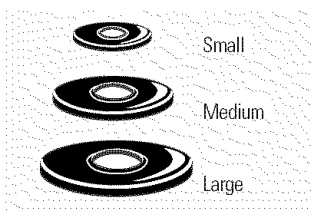

### Burner Caps

Lift off when cool. Wash burner caps in hot, soapy water and rinse with clean water. You may scour with a plastic scouring pad to remove burned-on food particles.

Dry them in a warm oven or with a cloth—don't reassemble them wet. Replace the burner caps.

Make sure that caps are replaced on the correct size burner. There are 2 large, one medium and one small head and cap.

## Care and cleaning of the range (cont.).

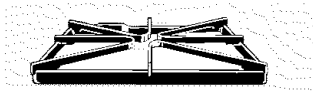

Appearance may vary

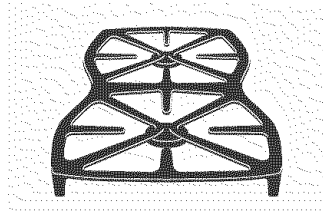

### Burner Grates

Lift out when cool. Grates should be washed regularly and, of course, after spillovers. Wash them in hot, soapy water and rinse with clean water. When replacing the grates, be sure they are positioned securely over the burners.

Do not operate a burner for an extended period of time without cookware on the grate. The finish on the grate may chip without cookware to absorb the heat.

To remove burned-on food, use a soap-filled scouring pad.

Although they are durable, the grates will gradually lose their shine, regardless of the best care you can give them. This is due to their continual exposure to high temperatures. You will notice this sooner with lighter color grates.

**NOTE:** Do not clean the grates in a dishwasher or in a self-cleaning oven.

### For porcelain cooktop models only:

- After cleaning the grates, dry them thoroughly by putting them in a warm oven for a few minutes. Do not put the grates back on the range while they are wet. When replacing the grates, make sure they are positioned securely over the burners.
- To prevent rusting on cast iron grates, apply a light coating of cooking oil on the bottom of the grates.

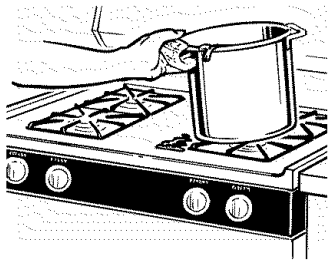

### Cooktop Surface (on porcelain cooktop models)

To avoid damaging the porcelain enamel surface of the cooktop and to prevent it from becoming dull, clean up spills right away. Foods with a lot of acid (tomatoes, sauerkraut, fruit juices, etc.) or foods with high sugar content could cause a dull spot if allowed to set.

When the surface has cooled, wash and rinse. For other spills such as fat splatterings, etc., wash with soap and water once the surface has cooled. Then rinse and polish with a dry cloth.

**NOTE:** Do not store flammable materials in an oven or near the cooktop. Do not store or use combustible materials, gasoline or other flammable vapors and liquids in the vicinity of this or any other appliance.

# Cleaning the glass cooktop surface (on some models).

Clean the glass surface with cleaning cream before you use the cooktop for the first time. Also, clean the glass surface after each use. This helps protect the top and makes clean-up easier.

To clean the cooktop seal around the edge of the glass, let a wet cloth rest on it for a few minutes, then wipe clean. Use a mild detergent if needed.

Do not use a knife or any sharp object on the seal because it will cut or damage it.

## Normal Cleaning

Use only a recommended cleaning cream, such as Cerama Brite or another cooktop cleaning cream, on the glass cooktop surface.

To maintain and protect the surface of your new glass cooktop follow these steps.

- 1 Before you use the cooktop for the first time, clean it with cleaning cream. This helps protect the top and makes clean-up easier.

- 2 Remove the grates and clean the surface with the cleaning cream after each use.
- 3 Rub a few drops (less is better) of the cleaning cream onto soiled area using a damp paper towel. Buff with a dry paper towel until all soil and cream are removed.

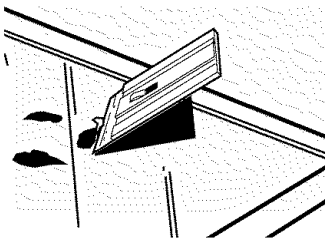

Using a razor scraper will not damage the surface if the 45° angle is maintained.

## For Heavy, Burned-On Soil...

- 1 Allow the cooktop and grates to cool.
- 2 Remove the grates and apply a few drops of cleaning cream to the cool, soiled area. Spread the cream across the entire soiled area.
- 3 Hold scraper at a 45° angle against the glass ceramic surface. This 45° angle makes the scraping easier.
- 4 Scrape soil with the enclosed razor scraper. Keep small amount of cream on the soil as you scrape. Heavily soiled areas may require repeated applications of cream.

It will be necessary to press down on the razor scraper while scraping the soiled area with cooktop cream.

Be sure to use a new sharp razor scraper. Do not use a dull or nicked blade.

- 5 If any soil remains, repeat the steps listed above.

To order more cream and/or scrapers for cleaning your glass cooktop surface, please call our toll-free number:

**National Parts Center . . . . .800-626-2002**

**Cleaner . . . . .# WX10X300**  
**Scraper . . . . .# WX5X1614**  
**Cream & scraper kit . . . . .# WB64X5027**

**Our testing shows that if you are cooking high sugar mixtures such as jelly or fudge and have a spillover, permanent damage to the cooktop surface may occur unless the spillover is immediately removed.**

## Special Care for Sugary Spills

Be sure to use a new sharp razor scraper. Do not use a dull or nicked blade.

Sugary spillovers (such as jellies, fudge, candy syrups) or melted plastics can cause pitting of the surface of your cooktop (not covered by the warranty) unless the spill is removed while still hot. **Special care should be taken when removing hot substances.**

- 1 Turn off all surface units and, with an oven mitt, remove hot pans and grates.
- 2 Wearing an oven mitt, hold the razor scraper at a 45° angle to the cooktop. Scrape the hot spill to a cool area outside the surface unit.

- 3 With the spill in a cool area, use a dry paper towel to remove any excess. Any spillover remaining should be left until the surface of the cooktop has cooled. Do not use the surface unit until all of the spillover has been removed. Follow the steps under *Heavy Burned-On Soil* to continue the cleaning process.

## Care and cleaning of the range (cont.)

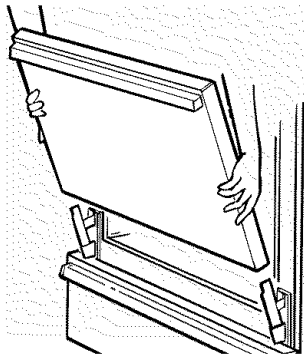

Lift the door straight up and off the hinges.

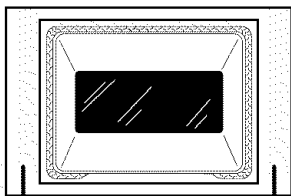

The gasket is designed with a gap at the bottom to allow for proper air circulation.

Do not rub or clean the door gasket—it has an extremely low resistance to abrasion.

If you notice the gasket becoming worn, frayed or damaged in any way or if it has become displaced on the door, you should have it replaced.

### Lift-Off Oven Door

The oven door is removable, but it is heavy. You may need help removing and replacing the door.

**To remove the door**, open it a few inches to the special stop position that will hold the door open. Grasp firmly on each side and lift the door straight up and off the hinges.

**NOTE:** Be careful not to place hands between the hinge and the oven door frame as the hinge could snap back and pinch fingers.

**To replace the door**, make sure the hinges are in the special stop position. Position the slots in the bottom of the door squarely over the hinges. Then lower the door slowly and evenly over both hinges at the same time. If the hinges snap back against the oven frame, pull them back out.

### To clean the inside of the door:

- Do not allow excess water to run into any holes or slots in the door.
- Because the area inside the gasket is cleaned during the self clean cycle, you do not need to clean this by hand. Any soap left on the liner causes additional stains when the oven is heated.

- The area outside the gasket can be cleaned with a soap-filled steel wool or plastic pad.

### To clean the outside of the door:

- Use soap and water to thoroughly clean the top, sides and front of the oven door. Rinse well. You may also use a glass cleaner to clean the glass on the outside of the door.
- Spillage of marinades, fruit juices, tomato sauces and basting materials containing acids may cause discoloration and should be wiped up immediately. When the surface is cool, clean and rinse.
- Do not use oven cleaners, cleansing powders or harsh abrasives on the outside of the door.

### Oven Bottom

The oven bottom has a porcelain enamel finish. To make cleaning easier, protect the oven bottom from excessive spillovers by placing a cookie sheet on the shelf below the shelf you are cooking on. This is particularly important when baking a fruit pie or other foods with a high acid content. Hot fruit fillings or other foods that are highly acidic (such as tomatoes, sauerkraut, and sauces with vinegar or lemon juice) may cause pitting and damage to the porcelain enamel surface and should be wiped up immediately.

We don't recommend using aluminum foil on the oven bottom. It can affect air flow if the holes are blocked and it can concentrate heat at the bottom of the oven, resulting in poor baking performance.

To clean up spillovers, use soap and water, an abrasive cleaner or soap-filled steel-wool pad. Rinse well to remove any soap before self-cleaning.

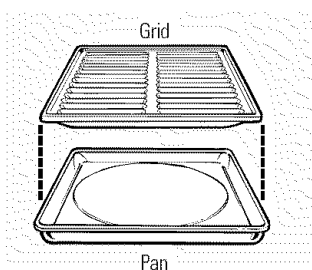

### Broiler Pan and Grid

After broiling, remove the broiler pan from the oven. Remove the grid from the pan. Carefully pour out grease from the pan into a proper container. Wash and rinse the broiler pan and grid in hot water with a soap-filled or plastic scouring pad.

If food has burned on, sprinkle the grid with detergent while hot and cover with wet paper towels or a dishcloth. Soaking the pan will remove burned-on foods.

The broiler pan and grid may be cleaned with a commercial oven cleaner.

Both the broiler pan and grid can also be cleaned in a dishwasher.

Do not store a soiled broiler pan and grid anywhere in the range.

**CAUTION:** Do not clean the broiler pan or grid in a self-cleaning oven.

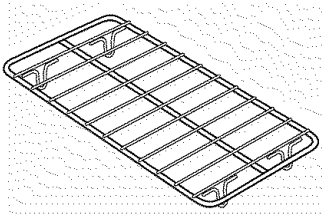

### Warming Drawer Rack

Clean the rack with detergent and water. After cleaning, rinse the rack with clean water and dry with a clean cloth.

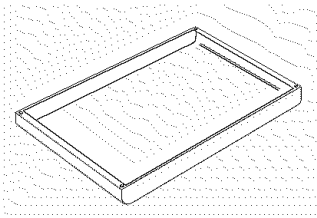

### Warming Drawer Pan

The warming drawer has a removable pan for easy cleaning.

Remove the pan, using the side edge handles and clean it with detergent and water. After cleaning, rinse with clean water and dry with a clean cloth. Replace the pan in the warming drawer.

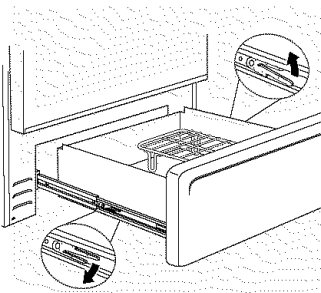

### Removable Warming Drawer (on some models)

Before performing any adjustments, cleaning or service, disconnect the range electrical power supply at the household distribution panel by removing the fuse or switching off the circuit breaker. Make sure the warming drawer heating element is cool.

#### To replace the warming drawer:

- 1 Place the left drawer rail around the inner left rail guide and slide it in slightly to hook it.
- 2 Place the right drawer rail around the inner right rail guide and slide it in slightly to hook it.
- 3 Slide the drawer all the way in.

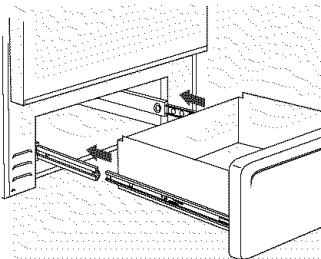

Most cleaning can be done with the drawer in place. However, the drawer may be removed if further cleaning is needed. Use soap and warm water to thoroughly clean.

#### To remove the warming drawer:

- 1 Pull the drawer straight out until it stops.
- 2 Press the left rail release down and push the right rail release up, while pulling the drawer forward and free.

## Care and cleaning of the range (cont.).

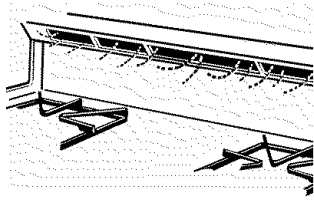

*Vent appearance and location vary.*

### Oven Air Vents

Never block the vents (air openings) of the range. They provide the air inlet and outlet that are necessary for the range to operate properly with correct combustion.

Air openings are located at the rear of the cooktop, at the top and bottom of the oven door, and at the bottom of the range, under the warming drawer.

### Upper Control Panel

*Lock out the touch pads before cleaning.*

See the *Control Lockout* information in the *Special features of your oven control* section in this manual.

Clean up splatters with a damp cloth.

You may also use a glass cleaner.

Remove heavier soil with warm soapy water. Do not use abrasives of any kind.

*Unlock the touch pads after cleaning.*

See the *Control Lockout* information in the *Special features of your oven control* section in this manual.

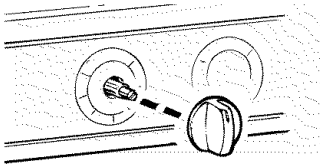

*Pull the knob straight off the stem.*

### Lower Control Panel and Knobs

It's a good idea to wipe the control panel after each use of the oven. Clean with mild soap and water or vinegar and water, rinse with clean water and polish dry with a soft cloth.

Do not use abrasive cleansers, strong liquid cleaners, plastic scouring pads or oven cleaners on the control panel—they will damage the finish. A 50/50 solution of vinegar and hot water works well.

The control knobs may be removed for easier cleaning. To remove a knob, pull it straight off the stem. If knob is difficult to remove, place a towel or dishcloth between the knob and control panel and pull gently. Wash the knobs in soap and water or a vinegar and hot water solution.

Metal parts can be cleaned with soap and water. Do not use steel wool, abrasives, ammonia, acids or commercial oven cleaners. Dry with a soft cloth.



### Oven Shelves

Clean the shelves with an abrasive cleanser or steel wool. After cleaning, rinse the shelves with clean water and dry with a clean cloth.

**NOTE:** Take the shelves out of the oven before you begin the self-clean cycle.

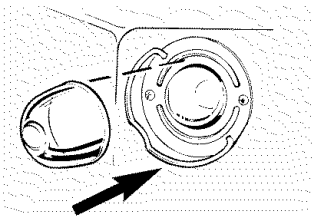

Wire cover holder.

### Oven Light Replacement

**CAUTION:** Before replacing your oven light bulb, disconnect the electrical power to the range at the main fuse or circuit breaker panel. Be sure to let the light cover and bulb cool completely.

The oven light bulb is covered with a removable glass cover that is held in place with a bail-shaped wire. Remove the oven door, if desired, to reach cover easily.

#### To remove:

- 1 Hold a hand under the cover so it doesn't fall when released. With fingers of the same hand, firmly push back the wire cover holder. Lift off the cover.

**Do not remove any screws to remove the cover.**

- 2 Do not touch hot bulb with a wet cloth. Replace bulb with a 40-watt household appliance bulb.

#### To replace cover:

- 1 Place it into the groove of the light receptacle. Pull the wire forward to the center of the cover until it snaps into place. When in place, the wire holds the cover firmly. Be certain the wire is in the depression in the center of the cover.
- 2 Connect electrical power to the range.

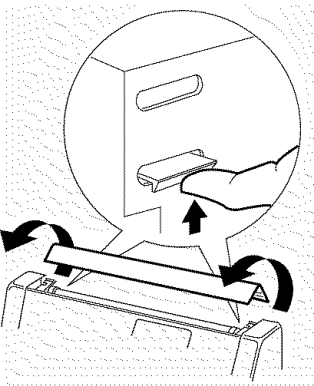

### Fluorescent Top Light

**CAUTION:** Do not touch the bulb with wet hands or when the bulb is hot. Never wipe the light area with a wet cloth. Electrical power must be shut off if you have to replace the bulb.

- 1 Raise the clips on the back, on both sides, and free the back of the canopy.
- 2 Roll the canopy up and off.
- 3 Remove the fluorescent light bulb. Replace the bulb with one of the same length and wattage.
- 4 Replace the canopy by placing the front in the groove and rolling it back. Snap it into place over the back clips on both sides.

## Installation of the range.

Read these instructions completely and carefully.



### BEFORE YOU BEGIN

Installation of this range must conform with local codes, or in the absence of local codes, with the National Fuel Gas Code, ANSI Z223.1, latest edition. In Canada, installation must conform with the current Natural Gas Installation Code, CAN/CGA-B149.1 or the current Propane Installation Code, CAN/CGA-B149.2, and with local codes where applicable. This range has been design-certified by the American Gas Association according to ANSI Z21.1, latest edition and Canadian Gas Association according to CAN/CGA-1.1 latest edition.

As with any appliance using gas and generating heat, there are certain safety precautions you should follow. You will find these precautions in the *Important Safety Information* section in the front of this manual. Read them carefully.

**IMPORTANT:** Save these instructions for the local electrical inspector's use.

**NOTE TO INSTALLER:** Leave these instructions with the appliance after installation is completed.

**NOTE TO CONSUMER:** Keep this Owner's Manual and Installation Instructions for future use.

**NOTE:** This appliance must be properly grounded.

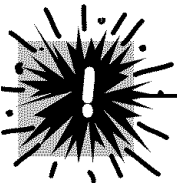

### FOR YOUR SAFETY

Do not store or use combustible materials, gasoline or other flammable vapors and liquids in the vicinity of this or any other appliance.

#### If you smell gas:

- 1 Open windows.
- 2 Don't touch electrical switches.
- 3 Extinguish any open flame.
- 4 Immediately call your gas supplier.



### TOOLS YOU WILL NEED

- Phillips and flat-blade screwdrivers
- Pencil and ruler
- Two pipe wrenches (one for backup)
- 1½" open-end or adjustable wrench
- Nut drivers or wrenches: 3/16" and 1/4"

### ADDITIONAL MATERIALS YOU MAY NEED:

- Gas line shut-off valve
- Pipe joint sealant or UL-approved pipe thread tape with Teflon\* that resists action of natural and LP gases
- Flexible metal appliance connector (1/2" I.D.)  
A 5-foot length is recommended for ease of installation but other lengths are acceptable. Never use an old connector when installing a new range.
- Flare union adapter for connection to gas supply line (3/4" or 1/2" NPT x 1/2" I.D.)
- Flare union adapter for connection to pressure regulator on range (1/2" NPT x 1/2" I.D.)

\*Teflon: Registered trademark of DuPont



Read these instructions completely and carefully.



## **WARNING!** INSTALLATION SAFETY INSTRUCTIONS

*Improper installation, adjustment, alteration, service or maintenance can cause injury or property damage. Refer to this manual. For assistance or additional information, consult a qualified installer, service agency, manufacturer (dealer) or the gas supplier.*

Never reuse old flexible connectors. The use of old flexible connectors can cause gas leaks and personal injury. Always use **NEW** flexible connectors when installing a gas appliance.

**IMPORTANT:** Remove all packing material and literature from oven before connecting gas and electrical supply to range.

**CAUTION:** Do not attempt to operate the oven of this range during a power failure (Electric Ignition models only).

- Have your range installed by a qualified installer.
- Your range must be electrically grounded in accordance with local codes or, in the absence of local codes, in accordance with the National Electrical Code (ANSI/NFPA 70, latest edition). In Canada, electrical grounding must be in accordance with the current CSA C22.1 Canadian Electrical Code Part 1 and/or local codes. See *Electrical Connections* in this section.
- Before installing your range on linoleum or any other synthetic floor covering, make sure the floor covering can withstand 180°F. without shrinking, warping or discoloring. Do not install the range over carpeting unless a sheet of 1/4" thick plywood or similar insulator is placed between the range and carpeting.
- Make sure the wall coverings around the range can withstand heat generated by the range up to 200°F.
- Avoid placing cabinets above the range. To reduce the hazard caused by reaching over the open flames of operating burners, install a ventilation hood over the range that projects forward at least 5" beyond the front of the cabinets.

- The ventilating hood must be constructed of sheet metal not less than 0.0122" thick. Install above the cooktop with a clearance of not less than 1/4" between the hood and the underside of the combustible material or metal cabinet. The hood must be at least as wide as the appliance and centered over the appliance. Clearance between the cooking surface and the ventilation hood surface **MUST NEVER BE LESS THAN 24 INCHES.**

**EXCEPTION:** Installation of a listed microwave oven or cooking appliance over the cooktop shall conform to the installation instructions packed with that appliance.

- If cabinets are placed above the range, allow a minimum clearance of 30" between the cooking surface and the bottom of unprotected cabinets.
- If a 30" clearance between cooking surface and overhead combustible material or metal cabinets cannot be maintained, protect the underside of the cabinets above the cooktop with not less than 1/4" insulating millboard covered with sheet metal not less than 0.0122" thick.
- Clearance between the cooking surface and protected cabinets **MUST NEVER BE LESS THAN 24 INCHES.** The vertical distance from the plane of the cooking surface to the bottom of adjacent overhead cabinets extending closer than 1" to the plane of the range sides must not be less than 18". (See the *Dimensions and Clearances* illustration in this section.)
- **CAUTION:** Items of interest to children should not be stored in cabinets above a range or on the backsplash of a range—children climbing on the range to reach items could be seriously injured.

# Installation of the range (cont.).

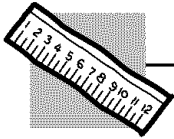

## DIMENSIONS AND CLEARANCES

Provide adequate clearances between the range and adjacent combustible surfaces. These dimensions must be met for safe use of your range. The location of the electrical outlet and pipe opening (see Gas Pipe and Electric Outlet Locations) may be adjusted to meet specific requirements.

The range may be placed with 0" clearance (flush) at the back wall.

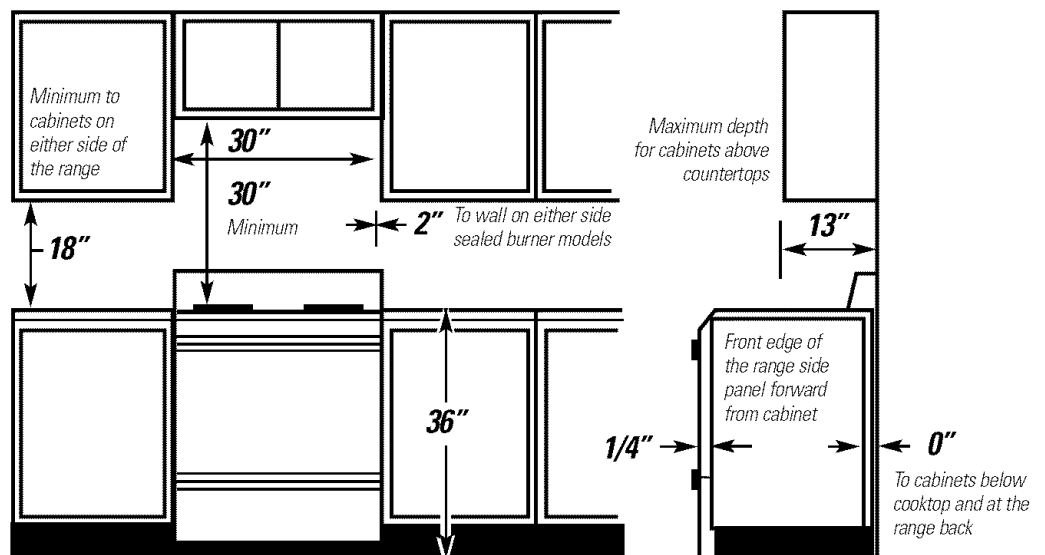
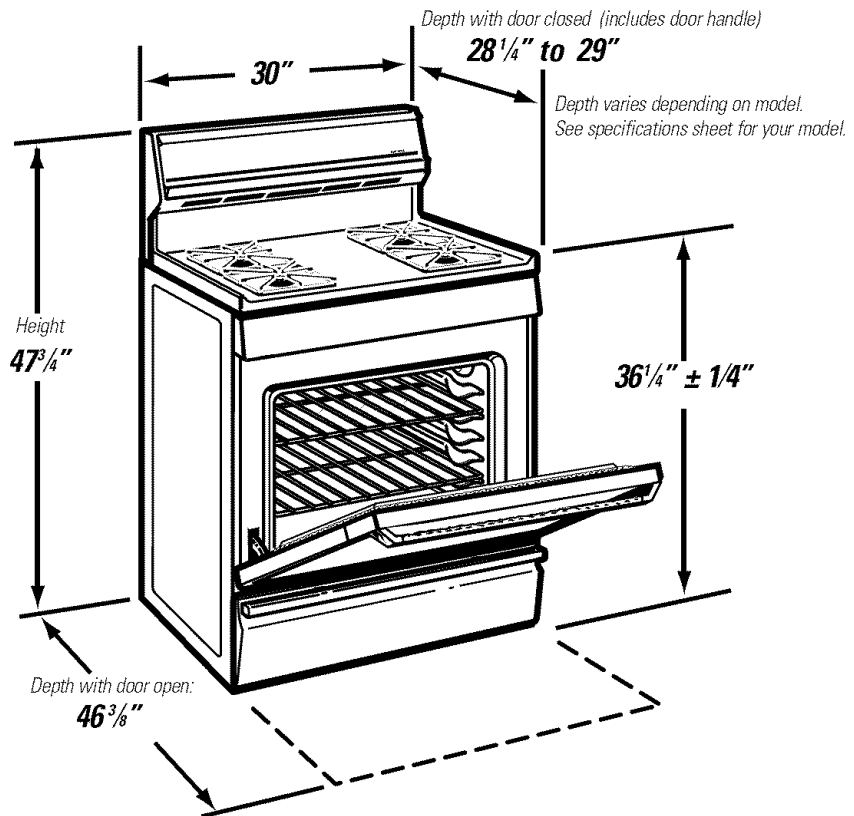

Read these instructions completely and carefully.

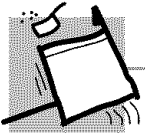

## **⚠ WARNING!** ANTI-TIP DEVICE

**All ranges can tip and injury could result.**

To prevent accidental tipping of the range, attach an approved Anti-Tip device to the wall. (See *Installing the Anti-Tip Device* in this section.) To check if the device is installed and engaged properly, carefully tip the range forward. The Anti-Tip device should engage and prevent the range from tipping over.

If you pull the range out from the wall for any reason, make sure the Anti-Tip device is engaged when you push the range back against the wall.

- For your safety, never use your range for warming or heating the room. Your oven and cooktop are not designed to heat your kitchen. Top burners should not be operated without cookware on the grate. Such abuse could result in fire and damage to your range and will void your warranty.
- Do not store or use combustible materials, gasoline or other flammable vapors and liquids in the vicinity of this or any other appliance. Explosions or fires could result.
- Do not use oven for a storage area. Items stored in the oven can ignite.
- Do not let cooking grease or other flammable materials accumulate in or near the range.

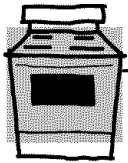
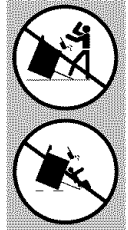

## LOCATION

Do not locate the range where it may be subject to strong drafts. Any openings in the floor or wall behind the range should be sealed. Make sure the openings around the base of the range that supply fresh air for combustion and ventilation are not obstructed by carpeting or woodwork.

Your range, like many other household items, is heavy and can settle into soft floor coverings such as cushioned vinyl or carpeting. Use care when moving the range on this type of flooring. It is recommended that the following simple and inexpensive instructions be followed to protect your floor.

The range should be installed on a sheet of plywood (or similar material). When the floor covering ends at the front of the range, the area that the range will rest on should be built up with plywood to the same level or higher than the floor covering.

This will allow the range to be moved for cleaning or servicing. Also, make sure your floor covering will withstand 180°F. (See the *Installation Safety Instructions* section.)

Make sure the wall coverings around your range can withstand the heat generated (up to 200°F.) by the range. (See the *Installation Safety Instructions* section.)



## IMPORTANT!

Remove all tape and packaging. Make sure the burners are properly seated and level.

Take the accessory pack out of the oven.

Check to be sure that no range parts have come loose during shipping.

## Installation of the range (cont.)

### 7 Provide Adequate Gas Supply

Your range is designed to operate at a pressure of 4" of water column on natural gas or, if designed for LP gas (propane or butane), 10" of water column.

Make sure you are supplying your range with the type of gas for which it is designed.

This range is convertible for use on natural or propane gas. If you decide to use this range on LP gas, conversion must be made by a qualified LP installer before attempting to operate the range on that gas.

For proper operation, the pressure of natural gas supplied to the regulator must be between 4" and 13" of water column.

For LP gas, the pressure supplied must be between 10" and 13" of water column.

When checking for proper operation of the regulator, the inlet pressure must be at least 1" greater than the operating (manifold) pressure as given above.

The pressure regulator located at the inlet of the range manifold must remain in the supply line regardless of whether natural or LP gas is being used.

A flexible metal appliance connector used to connect the range to the gas supply line should have an I.D. of 1/2" and be 5 feet in length for ease of installation. In Canada, flexible connectors must be single wall metal connectors no longer than 6 feet in length.

### 2 Connect the Range to Gas

Shut off the main gas supply valve before disconnecting the old range and leave it off until the new hook-up has been completed. Don't forget to relight the pilot on other gas appliances when you turn the gas back on.

Because hard piping restricts movement of the range, the use of an A.G.A.-certified flexible metal appliance connector is recommended unless local codes require a hard-piped connection.

Never use an old connector when installing a new range. If the hard piping method is used, you must carefully align the pipe; the range cannot be moved after the connection is made.

To prevent gas leaks, put pipe joint compound on, or wrap pipe thread tape with Teflon\* around, all male (external) pipe threads.

**A** Install a manual gas line shut-off valve in the gas line in an easily accessed location outside of the range. Make sure everyone operating the range knows where and how to shut off the gas supply to the range.

**B** Install male 1/2" flare union adapter to the 1/2" NPT internal thread elbow at inlet of regulator. On models equipped with standard twin burners, install the male pipe thread end of the 1/2" flare union adapter to the 1/2" NPT internal thread at inlet of pressure regulator. Use a backup wrench on the regulator fitting to avoid damage.

When installing the range from the front, remove the 90° elbow for easier installation.

**C** Install male 1/2" or 3/4" flare union adapter to the NPT internal thread of the manual shut-off valve, taking care to back-up the shut-off valve to keep it from turning.

**D** Connect flexible metal appliance connector to the adapter on the range. Position range to permit connection at the shut-off valve.

**E** When all connections have been made, make sure all range controls are in the off position and turn on the main gas supply valve. Use a liquid leak detector at all joints and connections to check for leaks in the system.

**CAUTION: DO NOT USE A FLAME TO CHECK FOR GAS LEAKS.**

When using test pressures greater than 1/2 psig to pressure test the gas supply system of the residence, disconnect the range and individual shut-off valve from the gas supply piping. When using test pressures of 1/2 psig or less to test the gas supply system, simply isolate the range from the gas supply system by closing the individual shut-off valve.

\*Teflon: Registered trademark of DuPont

Read these instructions completely and carefully.

### Gas Pipe and Electrical Outlet Locations

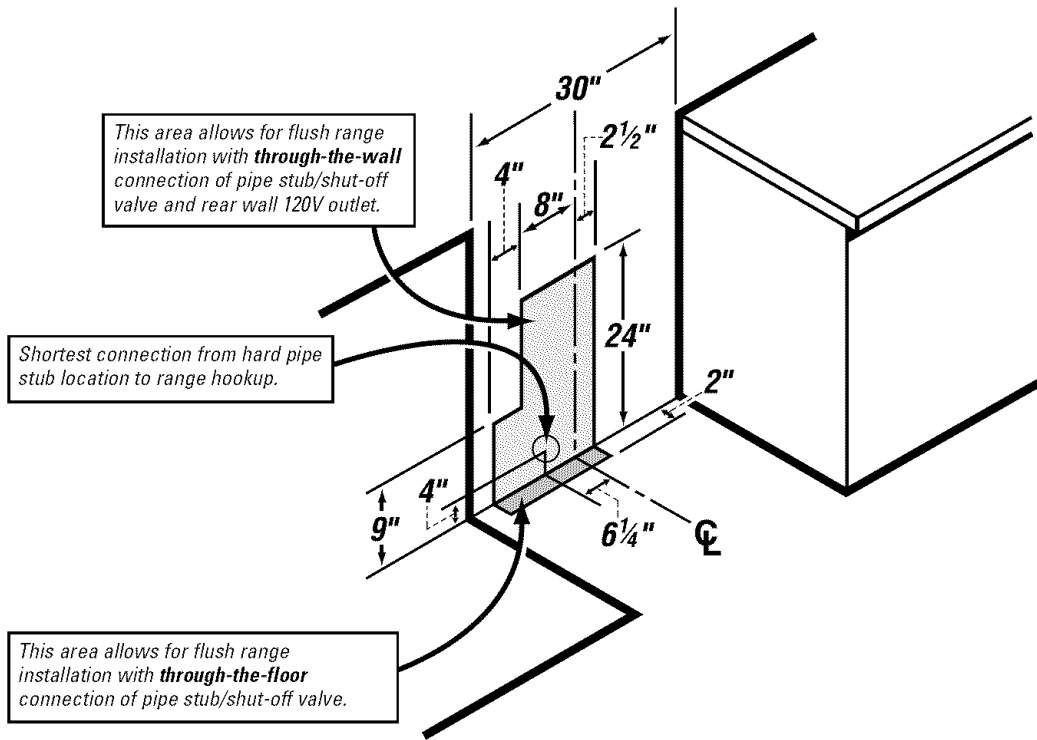

# Installation of the range (cont.)

## Flexible Connector Hookup

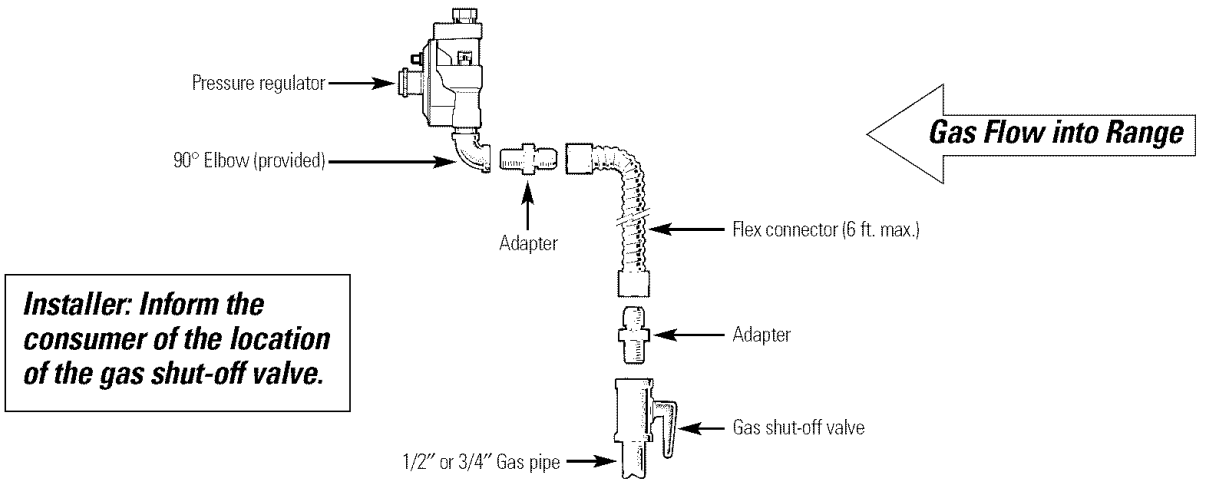

## Rigid Pipe Hookup

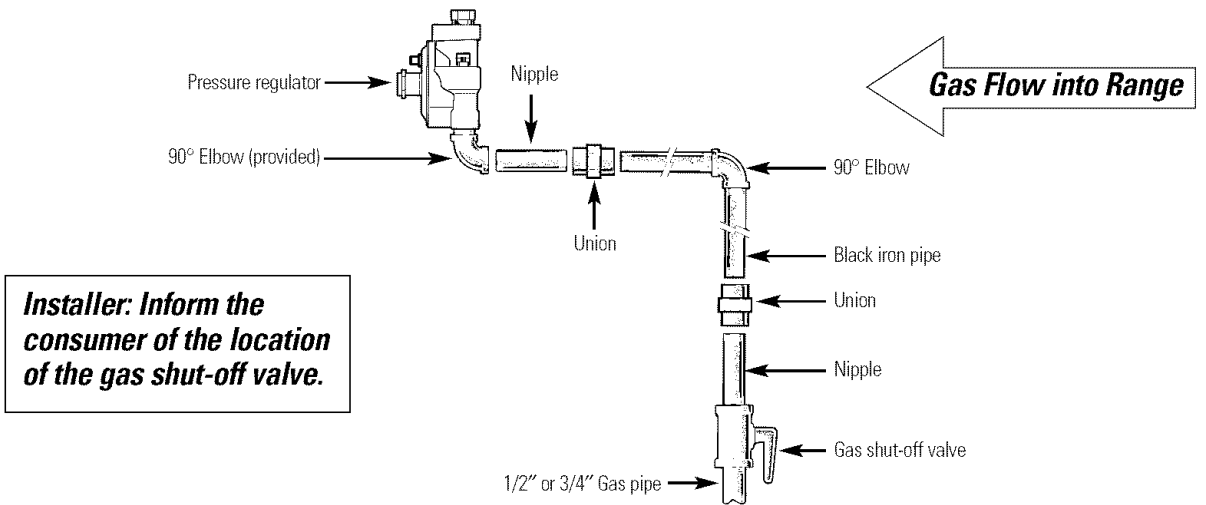

Read these instructions completely and carefully.

### 3 Electrical Connections

#### Electrical Requirements

120-volt, 60 Hertz, properly grounded branch circuit protected by a 15-amp or 20-amp circuit breaker or time delay fuse.

#### Extension Cord Cautions

Because of potential safety hazards associated with certain conditions, we strongly recommend against the use of an extension cord. However, if you still elect to use an extension cord, it is absolutely necessary that it be a UL-listed, 3-wire grounding-type appliance extension cord and that the current carrying rating of the cord in amperes be equivalent to, or greater than, the branch circuit rating.

#### Grounding

**IMPORTANT—(Please read carefully)**

**FOR PERSONAL SAFETY, THIS APPLIANCE MUST BE PROPERLY GROUNDED.**

#### Preferred Method

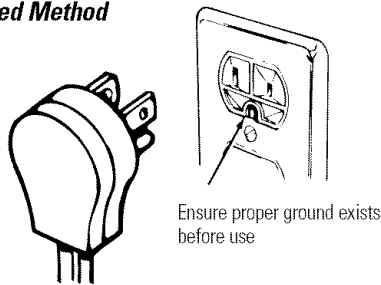

The power cord of this appliance is equipped with a three-prong (grounding) plug which mates with a standard three-prong grounding wall receptacle to minimize the possibility of electric shock hazard from this appliance.

The customer should have the wall receptacle and circuit checked by a qualified electrician to make sure the receptacle is properly grounded.

Where a standard two-prong wall receptacle is encountered, it is the personal responsibility and obligation of the customer to have it replaced with a properly grounded three-prong wall receptacle.

**DO NOT, UNDER ANY CIRCUMSTANCES, CUT OR REMOVE THE THIRD (GROUND) PRONG FROM THE POWER CORD.**

#### A Usage Situations where Appliance Power Cord will be Disconnected Infrequently.

An adapter may be used only on a 15-amp circuit. Do not use an adapter on a 20-amp circuit. Where local codes permit, a **TEMPORARY CONNECTION** may be made to a properly grounded two-prong wall receptacle by the use of a UL-listed adapter, available at most hardware stores. The larger slot in the adapter must be aligned with the larger slot in the wall receptacle to provide proper polarity in the connection of the power cord.

#### Temporary Method

(Adapter plugs not permitted in Canada)

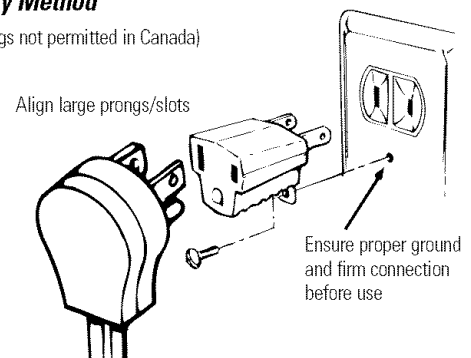

**CAUTION:** Attaching the adapter ground terminal to the wall receptacle cover screw does not ground the appliance unless the cover screw is metal, and not insulated, and the wall receptacle is grounded through the house wiring. The customer should have the circuit checked by a qualified electrician to make sure the receptacle is properly grounded.

When disconnecting the power cord from the adapter, always hold the adapter with one hand. If this is not done, the adapter ground terminal is very likely to break with repeated use. Should this happen, **DO NOT USE** the appliance until a proper ground has again been established.

## Installation of the range (cont.).

### 3 Electrical Connections

#### **B Usage Situations where Appliance Power Cord will be Disconnected Frequently.**

Do not use an adapter plug in these situations because disconnecting of the power cord places undue strain on the adapter and leads to eventual failure of the adapter ground terminal. The customer should have the two-prong wall receptacle replaced with a three-prong (grounding) receptacle by a qualified electrician before using the appliance.

The installation of appliances designed for mobile home installation must conform with the Manufactured Home Construction and Safety Standard, Title 24 CFR, Part 3280 (formerly the Federal Standard for Mobile Home Construction and Safety, Title 24, HUD, Part 280) or, when such standard is not applicable, the Standard for Manufactured Home Installations, latest edition (Manufactured Home Sites, Communities and Set-Ups), ANSI A225.1, latest edition, or with local codes. In Canada, mobile home installation must be in accordance with the current CAN/CSA Z240/MH Mobile Home Installation Code.

#### **Electric Disconnect**

- Locate disconnect plug on the range back.
- Pinch sides of connector and pull out of range back.

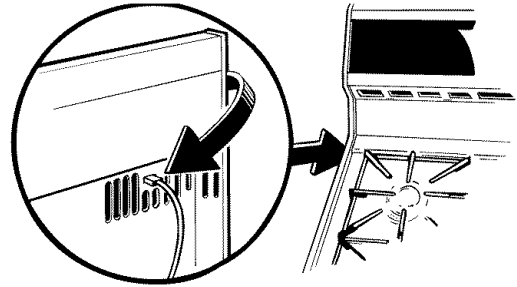

### 4 Seal the Openings

Seal any openings in the wall behind the range and in the floor under the range when hookups are completed.

### 5 Check Ignition of Surface Burners

Operation of all cooktop and oven burners should be checked after the range and gas supply lines have been carefully checked for leaks.

#### **Electric Ignition Models**

Select a top burner knob and simultaneously push in and turn to **LITE** position. You will hear a **clicking** sound indicating proper operation of the spark module. Once the air has been purged from the supply lines, burners should light within 4 seconds. After burner lights, rotate knob out of the **LITE** position. Try each burner in succession until all burners have been checked.



Read these instructions completely and carefully.

### Quality of Flames

The combustion quality of burner flames needs to be determined visually.

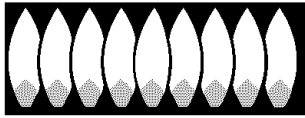

**(A) Yellow flames—**  
Call for service

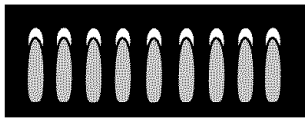

**(B) Yellow tips on  
outer cones—**  
Normal for LP gas

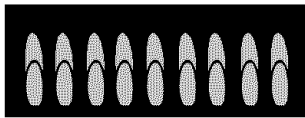

**(C) Soft blue  
flames—Normal for  
natural gas**

If burner flames look like (A), call for service. Normal burner flames should look like (B) or (C), depending on the type of gas you use.

With LP gas, some yellow tipping on outer cones is normal.

### 6 Check Ignition of Oven Burner

The oven is designed to operate quietly and automatically. To operate the oven, press the **BAKE** pad and then press the number pads until **350°** appears in the display. Touch the **START** pad. After 30-90 seconds, the oven burner will ignite and burn until the set temperature is reached. The oven burner will continue to cycle on and off as necessary to maintain the oven at the temperature indicated by the display.

To check ignition of the broil burner, touch the **BROIL HI/LO** pad and then the **START** pad. After 30-90 seconds, the broil burner will ignite.

**Electric ignition models** require electrical power to operate. In case of a power outage, the oven burners on these models cannot be lit manually with a match. Gas will not flow unless the glow bar is hot.

If the oven is in use when a power outage occurs, the burner will shut off and cannot be re-lit until power is restored.

## Installation of the range (cont.).

### 7 Adjust Broil and Oven Burner Air Adjustment Shutters if Necessary

Air adjustment shutters for the top and bottom burners regulate the flow of air to the flames.

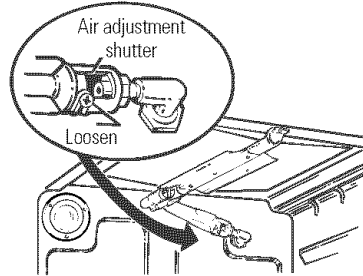

The air adjustment shutter for the top (broil) burner is in the center of the rear wall of the oven.

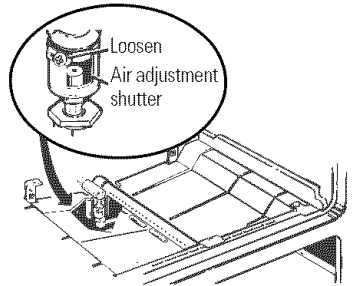

The shutter for the bottom (oven) burner is near the back wall behind the warming drawer. Remove the drawer. See the *Care and cleaning of the range* section.

To adjust the flow of air to either burner, loosen the Phillips head screw and rotate the shutter toward open or closed position as needed.

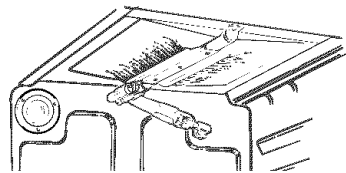

The flames for the top (broil) burner should be steady with approximately 1" blue cones and should not extend out over the edges of the burner baffle.

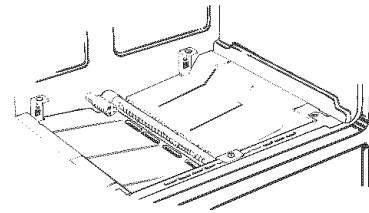

To determine if the bottom burner flames are burning properly, remove the oven bottom. Flames should have approximately 1" blue cones and, if range is supplied with natural gas, should burn with no yellow tipping. (With most LP gas, small yellow tips at the end of outer cones are normal.) Flames should not lift off burner ports. If lifting is observed, gradually reduce air shutter opening until flames are stabilized.

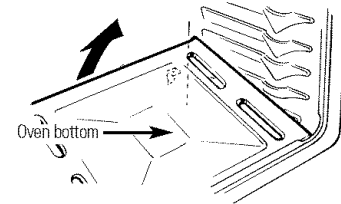

#### To remove the oven bottom:

- A** Remove the knurled screws holding down rear of the oven bottom.
- B** Grasp the oven bottom at finger slots on each side.
- C** Lift the rear of the oven bottom enough to clear the lip of the range frame, push it back, and then pull it up and out.

### 8 Leveling the Range

**A** Remove the warming drawer. See the *Care and cleaning of the range* section.

**B** Use a 3/16" open-end or socket wrench to back out both rear leveling legs approximately 2 turns.

**C** Use a 1 1/8" open-end or adjustable wrench to back out the front leveling legs two turns.

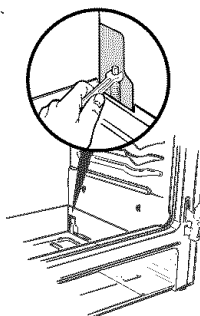

**D** Install the oven shelves in the oven and position the range where it will be installed.

**E** Check for levelness by placing a spirit level or a cup, partially filled with water, on one of the oven shelves. If using a spirit level, take two readings—with the level placed diagonally first in one direction and then the other.

**F** Adjust the leveling legs until the range is level.

**G** After the range is level, slide the range away from the wall so that the Anti-Tip device can be installed.

Read these instructions completely and carefully.

## 9 Installing the Anti-Tip Device

### WARNING:

- Range must be secured with an approved Anti-Tip device.
- Unless properly installed, the range could be tipped by you or a child standing, sitting or leaning on an open door.
- After installing the Anti-Tip device, verify that it is in place by carefully attempting to tilt the range forward.
- This range has been designed to meet all recognized industry tip standards for all normal conditions.
- The use of this device does not preclude tipping of the range when not properly installed.
- If the Anti-Tip device supplied with the range does not fit this application, use the universal Anti-Tip device WB02X7909.

- A** Mark the wall where the **RIGHT EDGE** of the range is to be located. Be sure to allow for the countertop overhang if you intend to install the range next to cabinets.

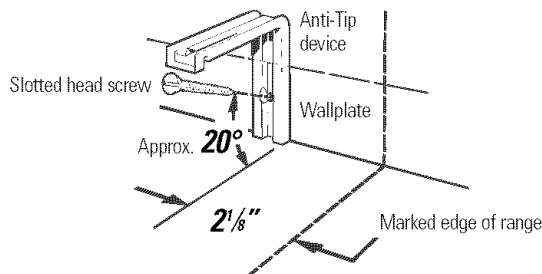

- B** Locate the outside edge of the device  $2\frac{1}{8}$ " toward the center of the range from the marked edge of the range.

- C** Using the device as a template, mark the position of the hole for the screw.

- D** For wood construction, drill a pilot hole at an angle of 20 degrees from the horizontal. A nail or awl may be used if a drill is not available.

Mount the Anti-Tip device with the screw provided.

For cement or concrete construction, you will need a  $1/4$ " x  $1\frac{1}{2}$ " lag bolt and a  $1/2$ " O.D. sleeve anchor, which are not provided. Drill the recommended size hole for the hardware.

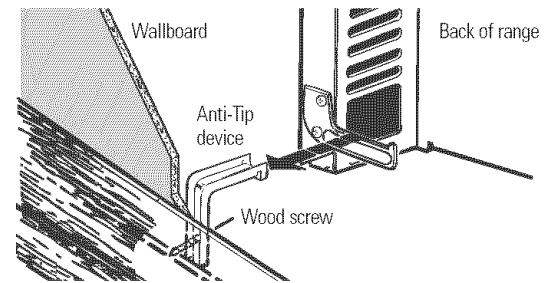

Install the sleeve anchor into the drilled hole and then install the lag bolt through the device. The bolts must be properly tightened as recommended for the hardware.

- E** Slide the range against the wall, and check for proper installation by grasping the front edge of the cooktop and carefully attempting to tilt the range forward.

### When All Hookups Are Completed:

**MAKE SURE ALL CONTROLS ARE LEFT IN THE OFF POSITION.**

**MAKE SURE THE FLOW OF COMBUSTION AND VENTILATION AIR TO THE RANGE IS UNOBSTRUCTED.**

### Converting to LP Gas (or converting back to natural gas from LP)

This range leaves the factory set for use with natural gas. If you want to convert to LP gas, the conversion must be performed by a qualified LP gas installer.

The conversion instructions, sticker and LP orifices can be found attached to the range next to the pressure regulator.

There is a second set of instructions included in the envelope containing the product wiring diagrams on the back of the range. Keep these instructions and the orifices in case you want to convert back to natural gas.

# Before You Call For Service...



## Troubleshooting Tips

Save time and money! Review the charts on the following pages first and you may not need to call for service.

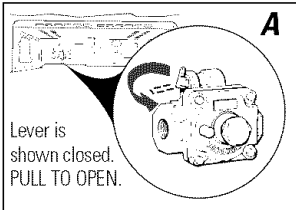
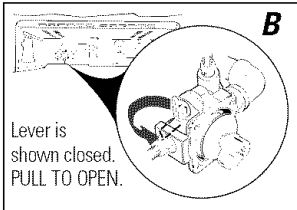
Problem	Possible Causes	What To Do
Top burners do not light or do not burn evenly	Plug on range is not completely inserted in the electrical outlet.	<ul style="list-style-type: none"> <li>Make sure electrical plug is plugged into a live, properly grounded outlet.</li> </ul>
	Burner slits on the side of the burner may be clogged.	<ul style="list-style-type: none"> <li>Remove the burner heads and clean them. Check the electrode area for burned-on food or grease. See the <i>Care and cleaning of the range</i> section.</li> </ul>
	Improper burner assembly.	<ul style="list-style-type: none"> <li>Make sure the burner parts are installed correctly. See the <i>Care and cleaning of the range</i> section.</li> </ul>
Burner flames very large or yellow	Improper air to gas ratio.	<ul style="list-style-type: none"> <li>If range is connected to LP gas, contact the person who installed your range or made the conversion.</li> </ul>
Surface burners light but oven does not	The oven gas shut-off valve may have accidentally been moved during cleaning or moving.	<ul style="list-style-type: none"> <li>To check the oven gas shut-off valve, remove the warming drawer (see the <i>Care and cleaning of the range</i> section) and look for the gas shut-off lever at the back of the range. Follow the directions in box <b>A</b> or <b>B</b> that match your regulator type.</li> </ul>
		<div style="display: flex; justify-content: space-around;"> <div style="text-align: center;">  <p>Lever is shown closed. PULL TO OPEN.</p> </div> <div style="text-align: center;">  <p>Lever is shown closed. PULL TO OPEN.</p> </div> </div>
Tiny scratches (may appear as cracks) or abrasions on cooktop glass surface	Incorrect cleaning methods being used.	<ul style="list-style-type: none"> <li>Use recommended cleaning procedures.</li> </ul>
	<p>Cookware with rough bottoms being used or coarse particles (salt or sand) were between the cookware and the surface of the cooktop.</p> <p>Cookware has been slid across the cooktop surface.</p>	<ul style="list-style-type: none"> <li>Be sure cookware bottoms and cookware are clean before use. Use cookware with smooth bottoms. Tiny scratches are not removable but will become less visible in time as a result of cleaning.</li> </ul>
Areas of discoloration on the glass cooktop surface	Improper cookware being used.	<ul style="list-style-type: none"> <li>Marks from aluminum and copper pans as well as mineral deposits from water or food can be removed with the cleaning cream.</li> </ul>
	Hot surface on a model with a white glass cooktop.	<ul style="list-style-type: none"> <li>This is normal. The surface may appear discolored when it is hot. This is temporary and will disappear as the glass cools.</li> </ul>
Plastic melted to the glass cooktop surface	Hot cooktop came into contact with plastic placed on the hot cooktop.	<ul style="list-style-type: none"> <li>See the <i>Special Care</i> information in the <i>Cleaning the glass cooktop surface</i> section.</li> </ul>
Pitting of the glass cooktop surface	Hot sugar mixture spilled on the cooktop.	<ul style="list-style-type: none"> <li>Call a qualified technician for replacement.</li> </ul>

<b>Problem</b>	<b>Possible Causes</b>	<b>What To Do</b>
<b>Florescent top light does not work</b>	Fluorescent bulb is loose or defective.	<ul style="list-style-type: none"> <li>• Adjust or replace. See the <i>Care and cleaning of the range</i> section.</li> </ul>
	Switch operating the light is broken.	<ul style="list-style-type: none"> <li>• Call for service.</li> </ul>
<b>Control signals after entering cooking time or start time</b>	You forgot to enter a bake temperature or cleaning time.	<ul style="list-style-type: none"> <li>• Touch the <b>BAKE</b> pad and desired temperature or the <b>SELF CLEAN</b> pad and desired clean time.</li> </ul>
<b>Food does not bake or roast properly</b>	Oven controls improperly set.	<ul style="list-style-type: none"> <li>• See the <i>Using the oven</i> section.</li> </ul>
	Shelf position is incorrect.	<ul style="list-style-type: none"> <li>• See the <i>Using the oven</i> section.</li> </ul>
	Incorrect cookware or cookware of improper size being used.	<ul style="list-style-type: none"> <li>• See the <i>Using the oven</i> section.</li> </ul>
	Oven thermostat needs adjustment.	<ul style="list-style-type: none"> <li>• See the <i>Adjust the oven thermostat—Do it yourself!</i> section.</li> </ul>
	Clock not set correctly.	<ul style="list-style-type: none"> <li>• See the <i>Using the clock and timer</i> section.</li> </ul>
	Aluminum foil used improperly in the oven.	<ul style="list-style-type: none"> <li>• See the <i>Care and cleaning of the range</i> section.</li> </ul>
<b>Food does not broil properly</b>	Oven bottom not securely seated in position.	<ul style="list-style-type: none"> <li>• See the <i>Installation of the range</i> section.</li> </ul>
	Oven controls improperly set.	<ul style="list-style-type: none"> <li>• Make sure you touch the <b>BROIL HI/LO</b> pad.</li> </ul>
	Oven door not closed.	<ul style="list-style-type: none"> <li>• See the <i>Using the oven</i> section.</li> </ul>
	Improper shelf position being used.	<ul style="list-style-type: none"> <li>• See the <i>Broiling Guide</i>.</li> </ul>
	Food being cooked in a hot pan.	<ul style="list-style-type: none"> <li>• Use the broiling pan and grid that came with your range. Make sure it is cool.</li> </ul>
	Cookware not suited for broiling.	<ul style="list-style-type: none"> <li>• Use the broiling pan and grid that came with your range.</li> </ul>
	Aluminum foil used on the the broiling pan and grid has not been fitted properly and slit as recommended.	<ul style="list-style-type: none"> <li>• See the <i>Using the oven</i> section.</li> </ul>
Oven bottom not securely seated in position.	<ul style="list-style-type: none"> <li>• See the <i>Installation of the range</i> section.</li> </ul>	
<b>Oven temperature too hot or too cold</b>	Oven thermostat needs adjustment.	<ul style="list-style-type: none"> <li>• See the <i>Adjust the oven thermostat—Do it yourself!</i> section.</li> </ul>
<b>Clock and timer do not work</b>	Plug on range is not completely inserted in the electrical outlet.	<ul style="list-style-type: none"> <li>• Make sure electrical plug is plugged into a live, properly grounded outlet.</li> </ul>
	A fuse in your home may be blown or the circuit breaker tripped.	<ul style="list-style-type: none"> <li>• Replace the fuse or reset the circuit breaker.</li> </ul>
	Oven controls improperly set.	<ul style="list-style-type: none"> <li>• See the <i>Using the clock and timer</i> section.</li> </ul>

## Before You Call For Service (cont.)...



### Troubleshooting Tips

Problem	Possible Causes	What To Do
<b>Oven light does not work</b>	Light bulb is loose or defective.	• Tighten or replace the bulb.
	Plug on range is not completely inserted in the electrical outlet.	• Make sure electrical plug is plugged into a live, properly grounded outlet.
<b>Oven will not self-clean</b>	The oven temperature is too high to set a self-clean operation.	• Allow the range to cool to room temperature and reset the controls.
	Oven controls improperly set.	• See the <i>Using the self-cleaning oven</i> section.
<b>"Crackling" or "popping" sound</b>	This is the sound of the metal heating and cooling during both the cooking and cleaning functions.	• This is normal.
<b>Excessive smoking</b>	Excessive soil.	• Touch the <b>CLEAR/OFF</b> pad. Open the windows to rid the room of smoke. Wait until the <b>LOCKED DOOR</b> light goes off. Wipe up the excess soil and reset the clean cycle.
<b>Oven door will not open after a clean cycle</b>	Oven too hot.	• Allow the oven to cool below locking temperature.
<b>Oven not clean after a clean cycle</b>	Oven controls not properly set.	• See the <i>Using the self-cleaning oven</i> section.
	Oven was heavily soiled.	• Clean up heavy spillovers before starting the clean cycle. Heavily soiled ovens may need to self-clean again or for a longer period of time.
<b>"LOCK DOOR" flashes in the display</b>	The self-clean cycle has been selected but the door is not closed.	• Close the oven door.
<b>LOCKED DOOR light is on when you want to cook</b>	The oven door is locked because the temperature inside the oven has not dropped below the locking temperature.	• Touch the <b>CLEAR/OFF</b> pad. Allow the oven to cool.
<b>"F—and a number or letter" flash in the display</b>	You have a function error code.	• Touch the <b>CLEAR/OFF</b> pad. Allow the oven to cool for one hour. Put the oven back into operation.
	If the function code repeats.	• Disconnect all power to the range for 5 minutes and then reconnect power. If the function error code repeats, call for service.
<b>"Probe" appears in the display</b>	This is reminding you to enter a probe temperature after plugging in the probe.	• Enter a probe temperature.

<b>Problem</b>	<b>Possible Causes</b>	<b>What To Do</b>
<b>Display goes blank</b>	A fuse in your home may be blown or the circuit breaker tripped.	<ul style="list-style-type: none"> <li>Replace the fuse or reset the circuit breaker.</li> </ul>
	The clock is in the black-out mode.	<ul style="list-style-type: none"> <li>See the <i>Special features of your oven control</i> section.</li> </ul>
<b>Display flashes</b>	Power failure.	<ul style="list-style-type: none"> <li>Reset the clock.</li> </ul>
<b>Unable to get the display to show "SF"</b>	Oven control pads were not pressed properly.	<ul style="list-style-type: none"> <li>The <b>BAKE</b> and <b>BROIL HI/LO</b> pads must be touched at the same time and held for 3 seconds.</li> </ul>
<b>Power outage, clock flashes</b>	Power outage or surge.	<ul style="list-style-type: none"> <li>Reset the clock. If the oven was in use, you must reset it by touching the <b>CLEAR/OFF</b> pad, setting the clock and resetting any cooking function.</li> </ul>
<b>"Burning" or "oily" odor emitting from the vent</b>	This is normal in a new oven and will disappear in time.	<ul style="list-style-type: none"> <li>To speed the process, set a self-clean cycle for a minimum of 3 hours. See the <i>Using the self-cleaning oven</i> section.</li> </ul>
<b>Strong odor</b>	An odor from the insulation around the inside of the oven is normal for the first few times the oven is used.	<ul style="list-style-type: none"> <li>This is temporary.</li> </ul>
<b>Fan noise</b>	The convection fan may turn on and off automatically.	<ul style="list-style-type: none"> <li>This is normal. The convection fan will run until the function is over or the door is opened.</li> </ul>
<b>Convection fan not working</b>	Preheat temperature not reached.	<ul style="list-style-type: none"> <li>Fan will start automatically once the preheat temperature is reached.</li> </ul>
<b>Drawer does not slide smoothly or drags</b>	The drawer is out of alignment.	<ul style="list-style-type: none"> <li>Fully extend the drawer and push it all the way in. See the <i>Care and cleaning of the range</i> section.</li> </ul>
	Drawer is over-loaded or load is unbalanced.	<ul style="list-style-type: none"> <li>Reduce weight. Redistribute drawer contents.</li> </ul>
<b>Warming zone or warming drawer will not work</b>	A fuse in your home may be blown or the circuit breaker tripped.	<ul style="list-style-type: none"> <li>Replace the fuse or reset the circuit breaker.</li> </ul>
	The oven is self-cleaning.	<ul style="list-style-type: none"> <li>Wait for the self-clean cycle to finish and the oven to cool.</li> </ul>
	Controls improperly set.	<ul style="list-style-type: none"> <li>See the <i>Using the electric glass top warming zone</i> section.</li> <li>See the <i>Electric warming drawer</i> section.</li> </ul>
<b>Excessive condensation in the warming drawer</b>	Liquid in warming drawer.	<ul style="list-style-type: none"> <li>Remove liquid.</li> </ul>
	Uncovered foods.	<ul style="list-style-type: none"> <li>Cover food with lid or aluminum foil.</li> </ul>
	Temperature setting too high.	<ul style="list-style-type: none"> <li>Reduce temperature setting.</li> </ul>
<b>Food dries out in the warming drawer</b>	Moisture escaping.	<ul style="list-style-type: none"> <li>Cover food with lid or aluminum foil.</li> </ul>

<b><i>Customer Service</i></b>	<b><i>Troubleshooting Tips</i></b>	<b><i>Installation Instructions</i></b>	<b><i>Operating Instructions</i></b>	<b><i>Safety Instructions</i></b>
--------------------------------	------------------------------------	---	--------------------------------------	-----------------------------------

## ***Notes***

---



## GE Service Protection Plus™

GE, a name recognized worldwide for quality and dependability, offers you Service Protection Plus™—comprehensive protection on all your appliances—**No Matter What Brand!**

**Benefits Include:**

- Backed by GE
- All brands covered
- Unlimited service calls
- All parts and labor costs included
- No out-of-pocket expenses
- No hidden deductibles
- One 800 number to call

***We'll Cover Any Appliance.  
Anywhere. Anytime.\****

You will be completely satisfied with our service protection or you may request your money back on the remaining value of your contract. No questions asked. It's that simple.

Protect your refrigerator, dishwasher, washer and dryer, range, TV, VCR and much more—**any brand!** Plus there's no extra charge for emergency service and low monthly financing is available. Even icemaker coverage and food spoilage protection is offered. You can rest easy, knowing that all your valuable household products are protected against expensive repairs.

Place your confidence in GE and call us in the U.S. toll-free at **800-626-2224** for more information.

\*All brands covered, up to 20 years old, in the continental U.S.

 Cut here

Please place in envelope and mail to:

***General Electric Company***  
**Warranty Registration Department**  
**P.O. Box 32150**  
**Louisville, KY 40232-2150**

# Consumer Product Ownership Registration

Dear Customer:

Thank you for purchasing our product and thank you for placing your confidence in us.

We are proud to have you as a customer!

**Follow these three steps to protect your new appliance investment:**

**1** Complete and mail your **Consumer Product Ownership Registration** today. Have the peace of mind of knowing we can contact you in the unlikely event of a safety modification.

**2** After mailing the registration below, store this document in a safe place. It contains information you will need should you require service. Our service number is 800 GE CARES (800-432-2737).

**3** Read your Owner's Manual carefully. It will help you operate your new appliance properly. If you have questions, or need more information, call the **GE Answer Center®** 800.626.2000.

Model Number

Serial Number

**Important: If you did not get a registration card with your product, detach and return the form below to ensure that your product is registered, or register online at [www.geappliances.com](http://www.geappliances.com).**

 Cut here

## Consumer Product Ownership Registration



Model Number

Serial Number

Mr.  Ms.  Mrs.  Miss

First Name

Last Name

Street Address

Apt. #

E-mail Address

City  State  Zip Code

Date Placed In Use Month  Day  Year  Phone Number --

Occasionally, we may allow selected companies to send you information.

Check here if you do not want this information.



**GE Appliances**

General Electric Company  
Louisville, Kentucky  
[www.geappliances.com](http://www.geappliances.com)

# GE Gas Range Warranty

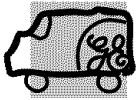

All warranty service provided by our Factory Service Centers or an authorized Customer Care® technician. For service, call 800-GE-CARES.

## For The Period Of: GE Will Replace, At No Charge To You:

### One Year

From the date of the original purchase

**Any part** of the range which fails due to a defect in materials or workmanship. During this **full one-year warranty**, GE will also provide, **free of charge**, all labor and in-home service to replace the defective part.

### Five Years

From the date of the original purchase (on glass cooktop models only)

**A replacement glass cooktop** if it should crack due to thermal shock, discolor, or crack at the rubber seal between the glass cooktop and the porcelain edge. It will also be replaced if the pattern wears off or if the warming zone surface unit burns out. During this **five-year warranty**, you will be responsible for any labor or in-home service.

## What GE Will Not Cover:

- Service trips to your home to teach you how to use the product.
- Improper installation.
- Failure of the product if it is abused, misused, or used for other than the intended purpose or used commercially.
- Damage to the glass cooktop caused by hardened spills of sugary materials or melted plastic that are not cleaned according to the directions in the Owner's Manual.
- Damage to the glass cooktop caused by use of cleaners other than the recommended cleaning creams.
- Replacement of house fuses or resetting of circuit breakers.
- Damage to the product caused by accident, fire, floods or acts of God.
- Incidental or consequential damage to personal property caused by possible defects with this appliance.

*This warranty is extended to the original purchaser and any succeeding owner for products purchased for home use within the USA. In Alaska, the warranty excludes the cost of shipping or service calls to your home.*

*Some states do not allow the exclusion or limitation of incidental or consequential damages. This warranty gives you specific legal rights, and you may also have other rights which vary from state to state. To know what your legal rights are, consult your local or state consumer affairs office or your state's Attorney General.*

**Warrantor: General Electric Company, Louisville, KY 40225**

## Service Telephone Numbers.

---

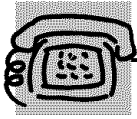

### GE Answer Center® 800.626.2000

The GE Answer Center® is open 24 hours a day, 7 days a week.



### In-Home Repair Service 800-GE-CARES (800-432-2737)

Expert GE repair service is only a phone call away.

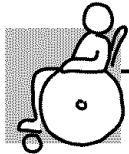

### Special Needs Service 800.626.2000

#### 800-TDD-GEAC (800-833-4322)

GE offers, free of charge, a brochure to assist in planning a barrier-free kitchen for persons with limited mobility.



### Service Contracts 800-626-2224

Purchase a GE service contract while your warranty is still in effect and you'll receive a substantial discount. GE Consumer Service will still be there after your warranty expires.

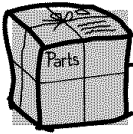

### Parts and Accessories 800-626-2002

Individuals qualified to service their own appliances can have parts or accessories sent directly to their homes (VISA, MasterCard and Discover cards are accepted).

**Instructions contained in this manual cover procedures to be performed by any user. Other servicing generally should be referred to qualified service personnel. Caution must be exercised, since improper servicing may cause unsafe operation.**



### Service Satisfaction

If you are not satisfied with the service you receive from GE:

**First**, contact the people who serviced your appliance.

**Next**, if you are still not pleased, write all the details—including your phone number—to:

Manager, Consumer Relations  
 GE Appliances  
 Appliance Park  
 Louisville, KY 40225