

Haier®

What The World Comes Home To™

Room Air Conditioner Electronic Control

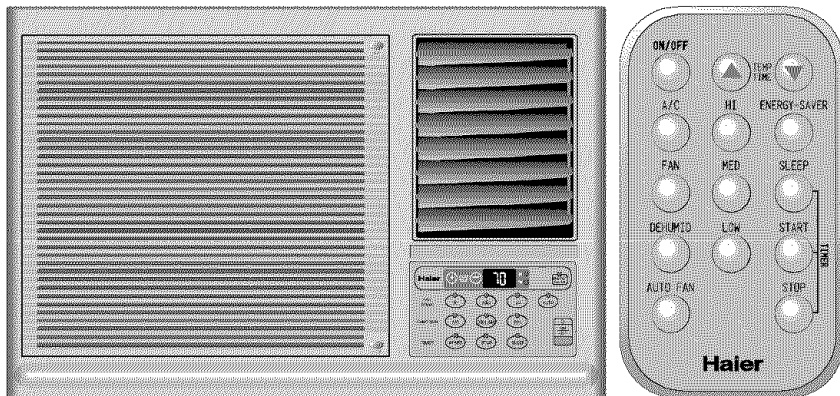

User Manual

*Read instructions before installing.
Call 1-877-337-3639 for questions on parts and services*

A Word From Haier

Thank You for buying a dependable, energy saving and easy to operate HAIER room air conditioner. This manual contains useful information for you to maintain, operate, install and safely use your room air conditioner. Your air conditioner cleans, cools and dehumidifies the air in your room to provide you with the ultimate level of comfort.





Please read instructions carefully before using the product. Also, do not forget to fill out and mail the **Product Registration Card**.

Product Registration

Record Your Model and Serial Number.

For all your service calls during the warranty period the following information will be needed. Attach the sales receipt to this guide and keep for future reference. This information can be obtained from the serial plate, which is on your air conditioner. This is either on the cabinet (side or back) or you may have to remove the front grille to locate it.

Model Number:
 Serial Number:
 Date of Purchase:
 Dealer's Name:
 Dealer's Address:
 Dealer's Phone Number:

TABLE					
RECEPTACLE AND FUSE TYPES					
RATED VOLTS	125/60		250/60		
AMPS	15	20	15	20	30
WALL OUTLET					
FUSE SIZE	15	20*	15	20*	30
TIME DELAY FUSE (or circuit breaker)	Plug	Plug	Plug		

SAFETY PRECAUTIONS

WARNING: *Following these basic precautions will reduce the risk of fire, electrical shock, injury or death when using your air conditioner.*



- 1) Air conditioner must be connected to proper electrical outlet with the correct electrical supply. *(see table)*
- 2) Proper grounding must be ensured to reduce the risk of shock and fire. **DO NOT CUT OR REMOVE THE GROUNDING PRONG.** If you do not have a three-prong electric receptacle outlet in the wall, have a certified electrician install the proper receptacle. The wall receptacle **MUST** be properly grounded.
- 3) Do not use if power cord is frayed or otherwise damaged. Also avoid using it if there are cracks or abrasion damage along the length, plug or connector.
- 4) **DO NOT USE AN ADAPTER OR AN EXTENSION CORD.**
 - 5) When installing your air conditioner in a window, make sure the window is strong enough to hold the weight of the air conditioner. You also want to secure and correctly install your air conditioner properly to prevent it from falling. Extra brackets and or support may be required depending on your window.
 - 6) Do not block airflow inside or outside the air conditioner with blinds, drapes, protective covers, shrubs or bushes.
 - 7) Be careful of sharp edges on the front and rear fins of the unit that could cut and cause serious injury.
 - 8) Be careful when lifting the air conditioner to install or remove the unit. Always use two or more people for this.
 - 9) Always unplug the air conditioner before servicing it or moving it.

Table Of Contents

	PAGE
A Word From Haier	1
Product Registration	1
Safety Precautions	2
Warnings	4
Electrical Safety	4
Tips	5
Energy Saving Guide	5
Features	6-7
Operating Guide	8-14
Normal Operating Sounds	8
Operating Instructions	8-14
Installations	15-24
Parts	16
Tools	17
Installing Unit into A Window	18-25
Clean and Care Guide	26-27
Troubleshooting	27-28
Warranty Information	29

WARNINGS



Following the safety messages is very important.
These messages can save you from being injured or killed.
Warning symbols alert you to be careful and means **Danger**. Always follow instructions to be safe and reduce chances of injury or death.
Warning and **Danger** signs will precede safety messages.

Electrical Safety



Grounding: This room air conditioner must be grounded.
Grounding reduces the risk of electric shock by providing an escape wire for the electric current. The power cord has a grounding wire with a grounding plug. Plug it into an outlet that is properly installed and grounded.

WARNING: Improper use of the grounding plug can result in a risk of electric shock. Call a qualified electrician if you don't understand the grounding instructions or if you are not sure if the air conditioner is properly grounded. If the wall electrical outlet is not grounded, please contact an electrician to have it replaced with a properly grounded outlet.

Do not, under any circumstances, cut or remove the third (ground) prong from the power cord.

Adapter Plug: We strongly advise against using an adapter plug.

Tips

- Air Conditioners are designed for use in a double hung window or through the wall installation only. (As applicable in your model)
- While installing unit be sure to tilt air conditioner $\frac{1}{4}$ inch outward to have the water drip outside the house.
- ⚠️ • Install the unit on the north side as normally that is the shaded side. This will enhance the operation of your unit.
- Window has to be strong for installation. Extra brackets and or support may be required depending on your window.
- Measure the window before installing, if the window is too big for the unit you may require professional installation.
- ⚠️ • Use correct electric voltage and proper ampere for the unit to run effectively.
- ⚠️ • Only let a certified electrician do any modifications to your electrical outlet.

Energy Saving Guide

- When installing your air conditioner make sure to seal all areas where there is a possibility of air leakage.
- Airflow should not be blocked inside either by curtains, drapes or furniture or outside by shrubs or bushes.
- Do not needlessly use an electrical light or other appliances that produce heat.
- Keep the vent closed on the air conditioner when in the cooling function.
- Keep the blinds and the drapes drawn on all the other windows.
- While cooking use an exhaust fan in the kitchen to remove the excess heat produced.
- Always use the correct BTU size air conditioner to cool the room to attain optimum efficiency.

Features

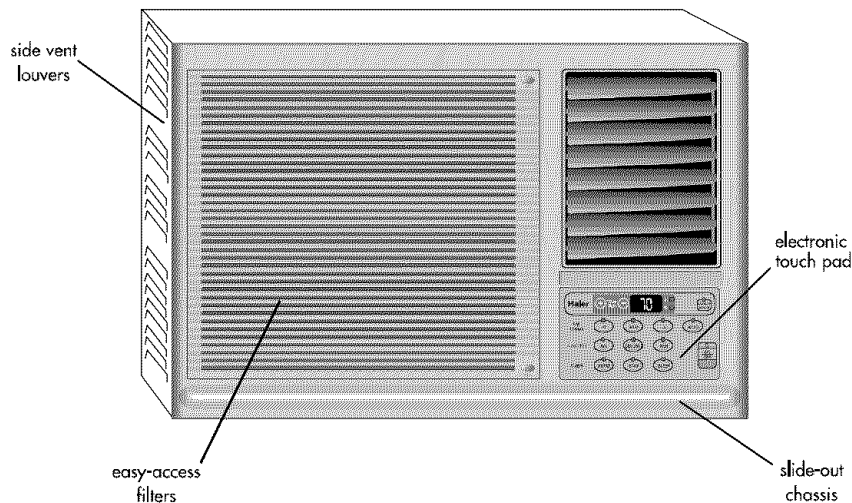

(All features not on all models)

1. Thermostat

This allows you to adjust the temperature of the air. The lower the setting the cooler the air temperature. With this you can set the temperature to your desired comfort level. You can set the temperature between 61° F and 86° F

2. Fan Speed

With this you can control the fan speed as well as the A/C (cooling) speed.

You have 3 levels of A/C Speed for you to set at your desired level. LO will circulate air at the lowest velocity, MED at medium velocity and HIGH will circulate at the maximum.

You have 2 levels of Fan Speed to set at your desired comfort level. MED and LO.

Auto Fan allows the room temperature to set the fan speed. When the function is set, fan speed is to be determined according to the difference between the set temperature and the temperature inside the room. Once the set temperature is reached the fan will run at the LO Setting.

3. Function.

Your air conditioner has 3 Functions.

a) A/C.

Here the air conditioner will operate the compressor and the desired fan speed set to give you chilled

cold air for your comfort.

b) Dehumid.

This enables your air conditioner to operate as a dehumidifier as well. It will remove the excess moisture from the air to keep your room at a comfortable dry stage. You can use this feature alone in case you do not desire to use the air conditioner.

c) Fan Only

You can run the fan only on not so hot days. The fan can be set to run at 2 speeds (med fan, low fan) as desired by you.

4. Energy Saver

When turned "ON" the fan will shut off 3 minutes after the compressor cycle off. This will not only save you electrical and energy costs but also shuts off the unnecessary noise of the fan motor running. In the "OFF" position the fan will not shut off when the compressor cycles off. The fan will keep running at the set level.

5. Timer

Your air conditioner can be set to go on or off at your desire. This can be done up to 12 hours in advance.

6. Vent (not in all models)

This feature helps you to exhaust any stale unwanted air from the room and draw fresh outside air in the room. To circulate the air, bring the lever to the open position (right). To retain the cool it is best to keep this in the closed mode (left).

7. 4 Way Air Flow

These air directional louvers let you control the direction of the airflow in your required direction. The airflow can be directed up – down – right side – left side.

8. Slide Out Chassis (not on all models)

Your Air Conditioner becomes more versatile with this feature. You have the option to install the unit in a window or the wall.

9. Window Install Kit

Enables you to install the air conditioner in a double hung window. Extra brackets or support may be needed depending on your window.

10. Remote Control

This full functional wireless remote allows you to operate your air conditioner from a distance. You need not have to get up to change the settings, the functions or to turn the unit on or off.

11. LED Display Electronic Control Panel

The 4 function LED displays Room Temperature, Temperature Setting, Timer Setting and Time Remaining to Stop / Start the unit. Electronic Control Panel lets you set the temperature to the Exact Temperature you desire.

12. Sleep

When activated, this feature automatically sets an 8 hour shut off timer. The unit will shut off in 8 hours.

Operating Guide

Normal Operating Sounds

The following sounds are normally heard during the operation of an air conditioner.

- Cool airflow movement as dictated by the set fan speed.
- Water sounds. This is normal as your air conditioner acts as a dehumidifier also. Thus you will hear water sounds from water drops falling on the condenser.
- As the refrigerant flows through the inner sealed tubing a rushing noise may be heard.
- Rattling or vibrating noises may be heard due to poor wall or window installation.
- High pitch compressor sound may be heard.

Operating Instructions

Following are the operating instructions of your electronic air conditioner.

After installing your air conditioner plug it in to the proper electrical outlet in the wall. Keep the vent in the closed position. Now set the air conditioner at your comfort level. This full functional wireless remote allows you to operate your air conditioner without having to get up and go to the unit. The full function feature allows you to change the settings and turn the unit on or off from the remote itself. This control pad works the same as the control pad on the air conditioner.

(See Fig. # 1)

Fig. # 1

Remote Control

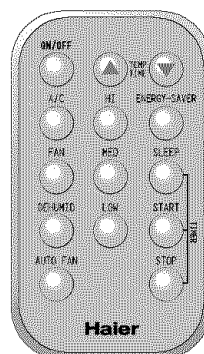

After you plug in the unit it will perform a self test. All the display lights will turn on for 3 seconds. The LED display will read "88". If any display light fails to turn on you may need service on the unit. After the 3 seconds self test the unit will automatically go to the stand by mode. Now all lights will be off and you will have to turn "ON" by pressing the On/Off key. After pressing "On/Off", the unit starts to work and enters the status of "Fan Only" with low setting. You will have to press the (+) or (-) key on the Temp/Time to set the temperature at your desired comfort. You can choose between 61°F and 86°F. Once the temperature is set you can raise or lower it by pressing the (+) or (-) keys. (Only when the unit is cooling or dehumidifying, can the temperature setting be adjusted.) (See Fig. # 2)

Fig. # 2

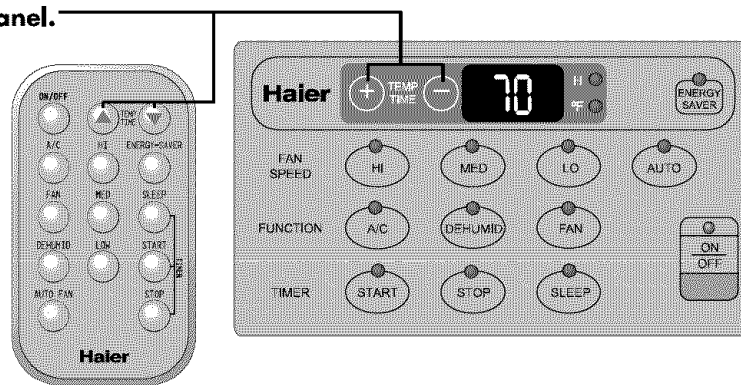
Control Panel.

Having set the temperature you will set the function of the air conditioner. If you want to cool the room press the A/C function. If you need to only remove the moisture press the Dehumid function. If you just need to use the fan only, press the Fan function. (See Fig. # 3)

Fig. # 3
Control Panel.

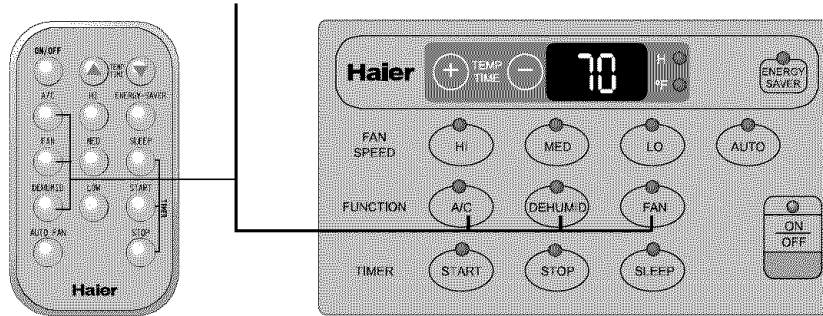

Once the function mode is decided you will have to set the fan speed. If you choose the A/C mode you can run the fan in one of the 3 speeds Hi, Med., Lo or in the Auto speed. In the Auto speed the fan will start at High, Med or Lo as the temperature varies in the room.

T_r : temperature inside the room.

T_s : the set temperature.

When $T_r > T_s + 2^\circ\text{F}$, the Hi is to be automatically. When $T_r \leq T_s$, the Lo is to be set. When $T_s < T_r \leq T_s + 2^\circ\text{F}$, the Med is to be set. Once the set temperature in the room is reached the Auto fan setting will have the fan running on Lo. It takes 3 minutes to switch the fan speed. (See Fig. # 4)

Fig. # 4
Control Panel.

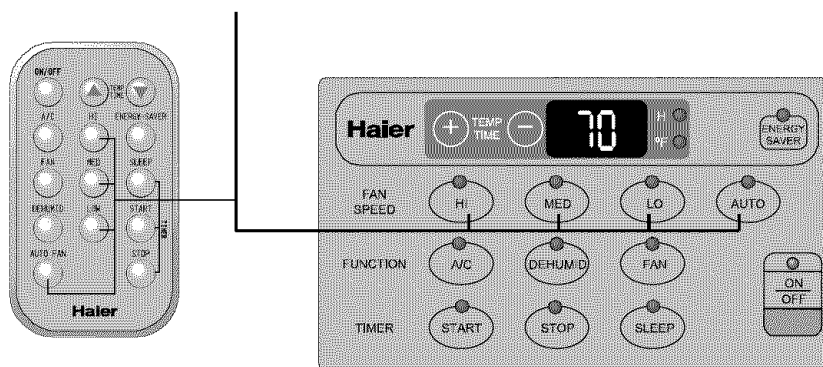

If you choose to use the Dehumid function. This will remove excess moisture from the air on excessively humid days.

Tr: temperature inside the room.

Ts: the set temperature.

1) When $Tr > Ts + 3^{\circ}F$, the compressor will run continuously the fan at the selected speed.

2) When $Ts - 1^{\circ}F < Tr < Ts + 3^{\circ}F$ the compressor will cycle for 10 minutes on and 6 minutes off.

3) When $Tr < Ts - 1^{\circ}F$, the compressor will shut off.

The dehumidification process takes place between the set temperature - 1 and $3^{\circ}F$ above the set temperature. (See Fig. # 5)

Fig. # 5

Control Panel.

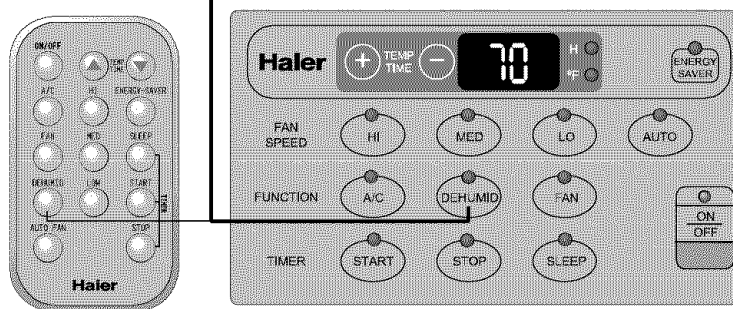

For cool days you may want to run the "Fan Only" function. Here the fan runs only at one of 2 speeds, Med. or Lo. The fan will not run at the High speed. (See Fig. # 6)

Fig. # 6

Control Panel.

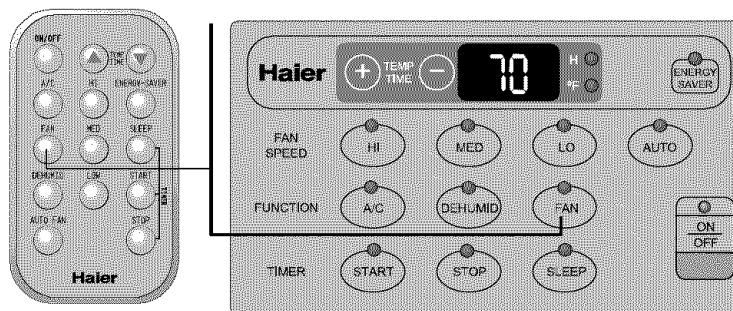

Timer start or Timer stop mode is used to pre-start or shut off your unit in advance. You can program this up to 12 hours in advance. You can use the Timer in 3 functions i.e. A/C, Dehumid. or Fan Only.

•Timer Start. (See Fig. # 7)

Unit must be on to set the timer. Unit will shut down automatically after it accepts the settings in 5 seconds. Use this mode to pre-set the start time of the unit 12 hours in advance.

a) Press Start, LED display will show "XX" (time set last time) when power is connected first time, LED display will show "01" .

b) Set desired number of hours by pressing the (+) pad of the Temp/Time buttons, one for each hour. If you passed the desired time use the (-) pad key to lower the selection.

•Timer Stop (See Fig. # 7)

Unit must be running to set the timer off. Use this to preset the time you would like the unit to shut off.

a) Press Stop, LED display will show "XX" (time set last time) when power is connected first time, LED display will show "01" .

b) Set desired number by pressing the (+) pad of the Temp/Time buttons. One for each hour. If you passed the desired time, use the (-) pad key to lower the selection.

When using the timer the unit will use/revert to the last A/C and fan settings when activated. The timer must be reset every time you choose to use it.

Fig. # 7

Control Panel

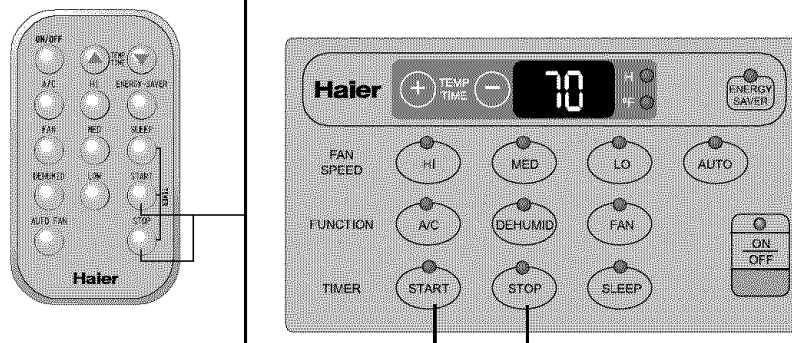

Pressing the mode one time, the setting of Timer start, Timer stop and sleep can be done. Pressing the mode for a second time, the setting is cancelled.

Sleep lets you preset the unit to shut off in 8 hours. Sleep works in the A/C function only. After pre-setting the temperature to a set degree, the temperature raises by 2 degree in the 1st hour and another 2 degree in the 2nd hour and then remains constant in the next 6 hours. As your body does not give out as much heat in the night and as nights generally become cooler this feature lets you sleep comfortably throughout the night without having to wake up to change the temperature settings.
(See Fig. # 8)

Fig. # 8

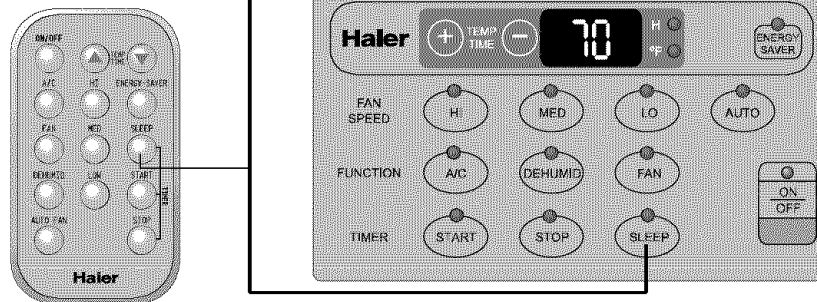
Control Panel

Energy Saver: By pressing this key you will activate the unit to go in the energy saver mode. The fan will be off 3 minutes after the compressor cycle off. By deactivating it the fan keeps running at the set speed even if the compressor shuts off. (See Fig. # 9) (This function is available in the cooling function only)

Fig. # 9



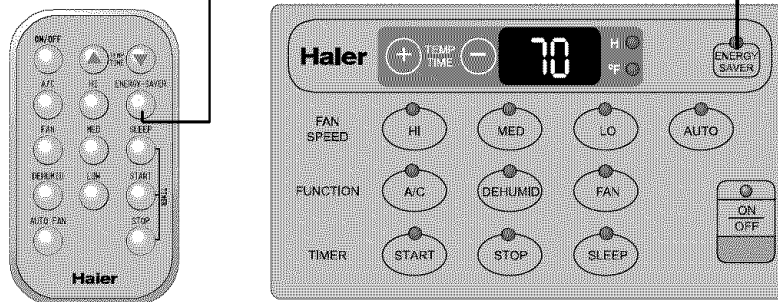



Control Panel



When unit is in "On" mode the LED display will show room temperature.
Press the (+) key to get set temperature. When unit is in "Timer Stop" function, LED display will show the time left for the unit to shut off.
To cancel Timer Stop press the main Off key.
"H" light is on the time is shown.
"F" light is on the temperature is shown.













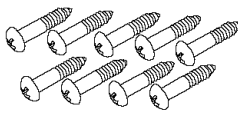



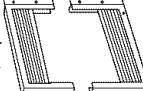

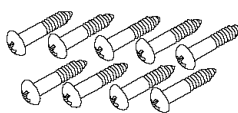

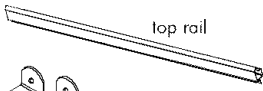

Installations

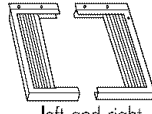
Before you install your air conditioner check the following:

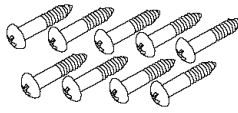
- 1) The unit is free of all obstructions inside and outside the room e.g. drapes, curtains, furniture, plants, shrubs, bushes, trees, other structures like building, garage etc. Air conditioner must have clear unobstructed airflow through the condenser to remove the heat.
- 2) The window is strong enough to hold the weight of the air conditioner. Extra brackets or supports may be needed depending on your windows.
- 3) The window sill and track are strong enough to hold the weight of the air conditioner.
- 4) The wall is strong enough to hold the unit. Extra brackets or supports may be needed depending on the wall.
- 5) There is adequate and proper power supply near the air conditioner.
-  6) DO NOT use adapter plugs.
-  7) DO NOT use extension cords.
-  8) DO NOT cut or remove the ground prong.
-  9) DO NOT modify the plug or the electrical wall outlet in any way. If plug does not fit the electrical outlet have a certified electrician do the necessary change.
-  10) DO NOT connect electrical power to the unit before installation.
-  11) DO NOT use if power cord is worn out, frayed or otherwise damaged. Avoid using if there are cracks or abrasion damage along the length, plug or connection.

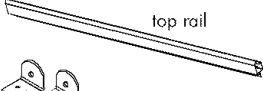
English

Parts

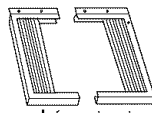
Parts Supplied					
 window seal gasket	 curtain attachment screws 13/32"	 curtain sash screws 31/32"	 Remote control	 basepan angle	 "CR2025" battery
Model: HWR08XC3-T				 left and right side curtains	
Parts Supplied					
 window seal gasket	 curtain attachment screws 13/32"	 curtain sash screws 31/32"	 Casement to window securance screw 1"	 basepan angle	 top rail
 drain elbow	 Remote control	 "CR2025" battery	 left and right side curtains		
Model: HWR10XC3-T					
Parts Supplied					
 window seal gasket	 curtain attachment screws 13/32"	 curtain sash screws 31/32"	 Casement to window securance screw 1"	 basepan angle	 top rail
 drain tube	 Remote control	 "CR2025" battery	 left and right side curtains		
Model: HWR12XC3-T					

Tools

You will need to have the following tools to help you in the installation of your air conditioner.

- Scissors
- Phillips Screwdriver
- Standard Screwdriver
- Pliers
- Wrench
- Drill and Drill Bits
- Tape Measure
- Gloves
- Level
- Sockets

Installing Unit into A Window

Window Opening Requirements

The air conditioner is designed to fit into double or single hung sash type windows. Each of the units comes with an installation kit that provides adjustable mounting louvers, to fill the gaps between the sides of the unit, and the window frame. The chart below reflects the dimensions of the units with, and without installation kits. Measure your window opening width and compare it to the chart below to ensure that it meets the minimum and maximum window width requirements.

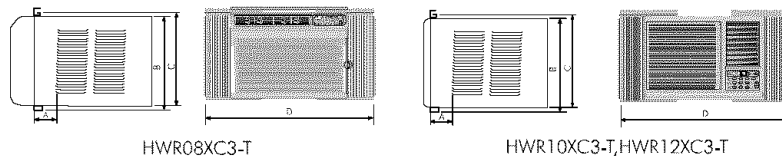

Model	HWR08XC3-T	HWR10XC3-T	HWR12XC3-T
Dimension			
A(inch)	$2\frac{9}{16}''$	$7\frac{15}{32}''$	$10\frac{5}{8}''$
B(inch)	$14\frac{3}{8}''$	$13\frac{31}{32}''$	$16\frac{11}{32}''$
C(inch)	$14\frac{9}{32}''$	$13\frac{31}{32}''$	$16\frac{11}{32}''$
D(inch) Max	$34\frac{1}{4}''$	$35\frac{1}{32}''$	$36\frac{5}{8}''$
D(inch) Min	$23\frac{5}{8}''$	$25\frac{9}{32}''$	$26\frac{27}{32}''$
Case High	$13\frac{13}{16}''$	$13\frac{3}{8}''$	$15\frac{3}{4}''$
Case Width	$20\frac{1}{4}''$	$20\frac{15}{32}''$	$22\frac{1}{16}''$
Case Depth	$12\frac{5}{8}''$	$20\frac{15}{32}''$	$23\frac{5}{8}''$

Model HWR08XC3-T

1 ASSEMBLE CURTAINS

Unpack unit on floor next to installation location.

Slide left-hand curtain assembly into left ends of top and bottom rails. Repeat for right-hand curtain assembly. Fasten curtain retainer strips to sides of outer case with six $1\frac{3}{32}''$ screws.

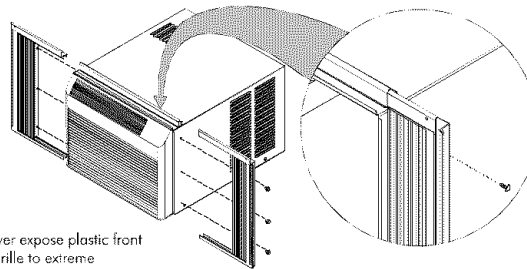

Caution: Never expose plastic front or grille to extreme temperatures.

2 PREPARE WINDOW FOR INSTALLATION

Inspect window track, sash, and sill for its ability to support the weight of air conditioner.

Measure width between window moldings to ensure Instant Mount will fit window frame. Instant Mount models are designed for windows wide (the detail See Page 18).

Instant Mount kit supplied with unit is designed for mounting in most double-hung windows **without storm windows**. For installation in window frame with storm window, modify sill by adding wood strips (not included) tinner and outer sills. This raises unit and eliminates interference of storm window frame.

Storm window installation

If storm window frame does not allow adequate clearance below sill (1/2" required), remove storm window frame or create clearance by adding a wood strip (at least 1 1/2" wide) along entire width of sill. Fasten wood strip to sill with at least three countersunk wood screws (not supplied with kit). This provides a smooth surface for mounting air conditioner.

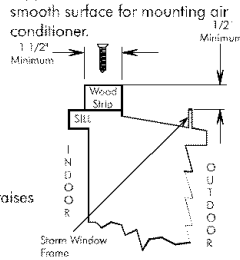

Mobile home window installation

Add wood strip (at least 1 1/2" wide) along entire width of window sill. Thickness of wood strip should match height of front lip on window frame. Fasten wood strip to sill with a minimum of three countersunk wood screws (not supplied with kit). This provides a smooth surface for mounting air conditioner.

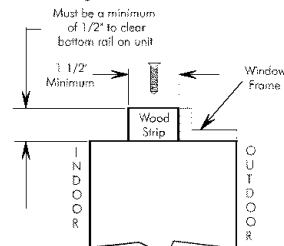

3 INSTALL UNIT IN WINDOW

Place unit in window. Lower sash until it rests behind front flange of top rail. Bottom rail must rest behind window sill.

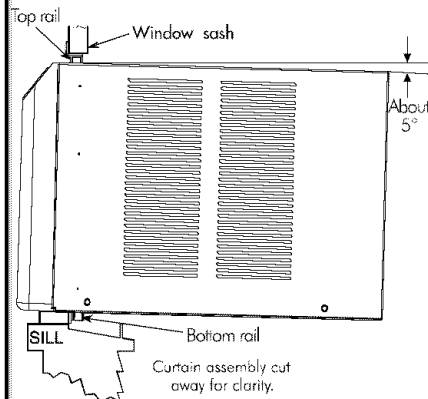

4 INSTALL BASEPAN ANGLE

Back front attachment screw out several turns and slip Basepan Angle over screw head. Snug screw with angle resting on window ledge. Install two 31/32" screws through angle into window ledge. Repeat for opposite side.

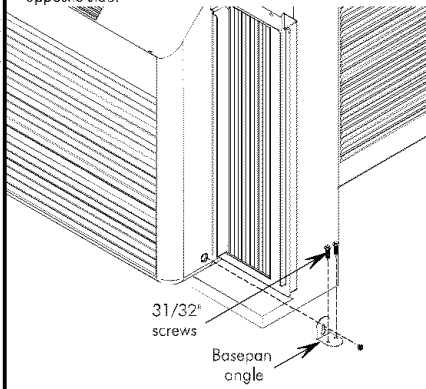

5 SECURE SIDE CURTAINS AND TOP MOUNTING RAIL

Expand curtains as far as possible. Install (2) 31/32" curtain sash screws. Install (3) 25-mm top mounting rail. For hard wood or metal window frames, drill a pilot hole to start screw.

IMPORTANT: Be careful not to drill pilot hole too deep. Add a piece of tape to the drill bit as a depth gauge. Also stay clear of glass. Be careful not to damage the function of the window.

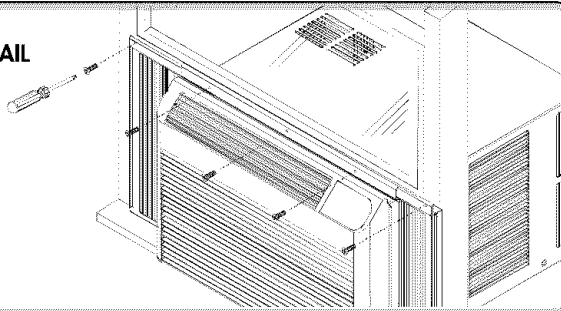

6 INSTALL SEAL GASKET

Cut window seal gasket to width of window. Stuff window seal gasket between outdoor window glass and top of indoor sash. This will stop air leakage which reduces efficiency.

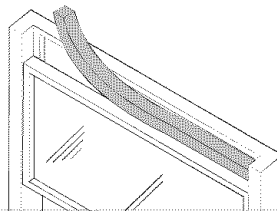

Models HWR10XC3-T HWR12XC3-T

7 PREPARE UNIT FOR INSTALLATION

Unpack unit on floor next to installation location. Remove front attachment screw. Separate the outercase from the front with a putty knife at the catch points designated by the arrows. Remove one screw securing basepan locking bracket. Remove two screws located in the rear of the outercase, securing basepan to outercase. Using the basepan handle, slowly and evenly pull chassis out from outercase.

Note: Cover putty knife blade with masking tape to guard against damage of the units finish. The filter is removed in this illustration for clarity only.

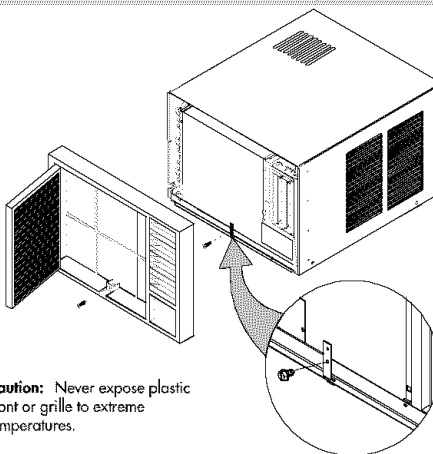

Caution: Never expose plastic front or grille to extreme temperatures.

2 ASSEMBLE CURTAINS/TOP RAIL

Install top rail with three 13/32" screws. Slide left-hand curtain assembly into left end of top and bottom rails. Repeat for right-hand curtain assembly. Fasten curtain retainer strips to sides of outer case with six 13/32" screws.

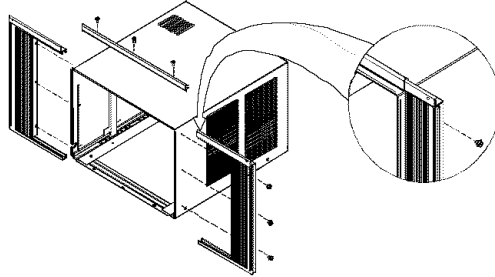

3 PREPARE WINDOW FOR INSTALLATION

Inspect window track, sash, and sill for its ability to support the weight of air conditioner.

Measure width between window moldings to ensure Instant Mount will fit window frame. Instant Mount models are designed for windows wide (the detail see page 18)

Storm window installation

If storm window frame does not allow adequate clearance below sill (1/2" required), remove storm window frame or create clearance by adding a wood strip (at least 1 1/2" wide) along entire width of sill. Fasten wood strip to sill with at least three countersunk wood screws (not supplied with kit). This provides a smooth surface for mounting air conditioner.

Mobile home window installation

Add wood strip (at least 1 1/2" wide) along entire width of window sill. Thickness of wood strip should match height of front lip on window frame. Fasten wood strip to sill with a minimum of three countersunk wood screws (not supplied with kit). This provides a smooth surface for mounting air conditioner.

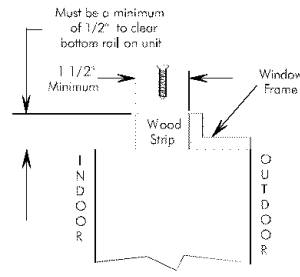
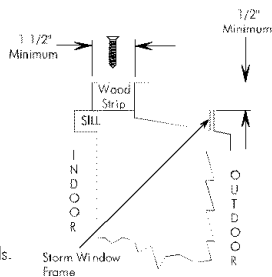

Instant Mount kit supplied with unit is designed for mounting in most double-hung windows **without storm windows**. For installation in window frame with storm window, modify sill by adding wood strips (not included) to inner and outer sills. This raises unit and eliminates interference of storm window frame.

4 INSTALL OUTER CASE IN WINDOW

Place outer case in window. Lower sash until it rests behind front flange of top rail. Bottom rail must rest behind window sill.

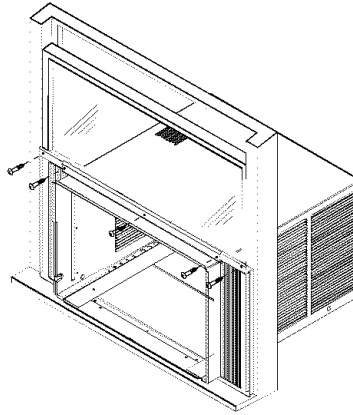
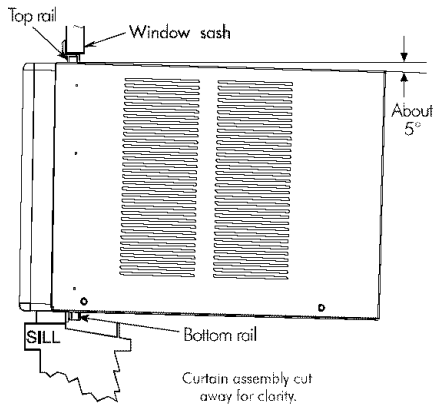

Expand both curtains to contact the window frame. Install two 31/32" screws. One in each upper right and left corner of the curtains. Install three 31/32" top mounting rail screws.

NOTE: To make screws easier to drive, drill a pilot hole into sash through clearance hole in curtains.

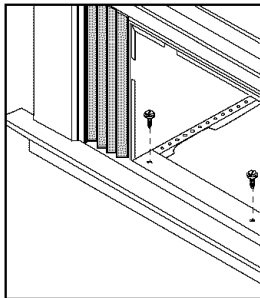

Use two case-to-window security screws (1") to fix the case to window sash.

5 INSTALL BASEPAN ANGLE

Install Two 31/32" screws through angle into window ledge. Repeat for opposite side.

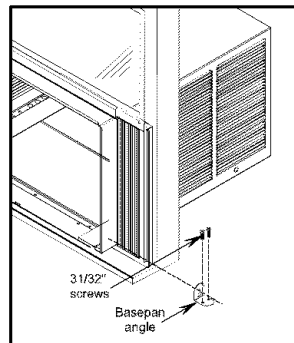

6 INSTALL SEAL GASKET

Cut window seal gasket to width of window. Stuff window seal strip between outdoor window glass and top of indoor sash. This will stop air leakage which reduces efficiency.
IMPORTANT: Stay clear of glass. Be careful not to damage the function of the window.

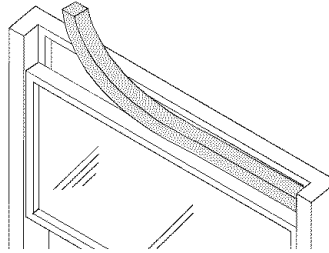

7 INSTALL DRAIN ELBOW

Adjust the direction of the drain tube(drain elbow) to make it be in line with the hole in the rear of unit; Insert the drain tube(drain elbow) into the hole and twist 90°.

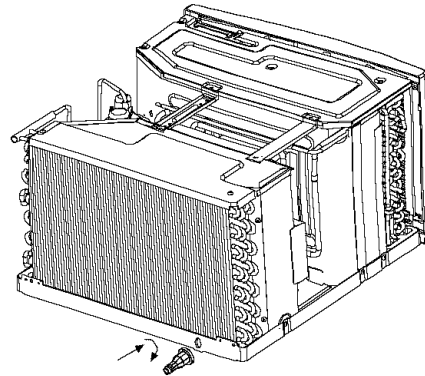

8 RETURN CHASSIS TO OUTER CASE

Find someone to help you replace chassis in outer case. Install basepan clip. Replace front panel, and grille.

Where possible install two screws in rear of outer case, removed in step one.

IMPORTANT: Because window sash helps keep unit in window, make certain window sash contacts outer case before reinstalling chassis.

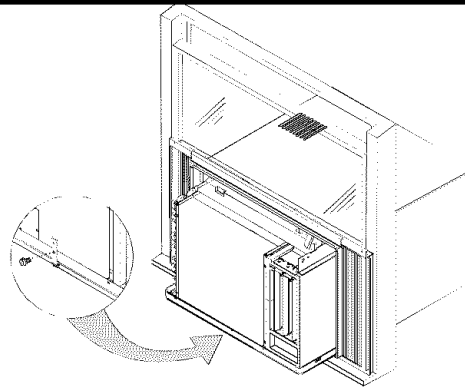

Wall Installations: slide-out chassis only

Note: Remove the 1 or 2 shipping screws on the rear of the air conditioner that hold the chassis to the outer shell casing. Once removed, these do not have to be re-installed. To ensure that your air conditioner is properly installed in the wall, it is recommended that it be installed by a certified technician who is familiar with through the wall installations.

1) Using wood, 1" or more in thickness, build a wooden frame to fit the casing/cabinet dimensions of the unit which you have purchased.

2) Measure the outside width and the height of the frame to determine the cutout dimensions necessary for the opening in the wall. The depth of the frame will depend on the depth of the wall. The finished frame must be set in the inside wall. The frame has to be squared and leveled. Remember the frame has to be nailed securely to the wall studs. (See Fig. # 19)

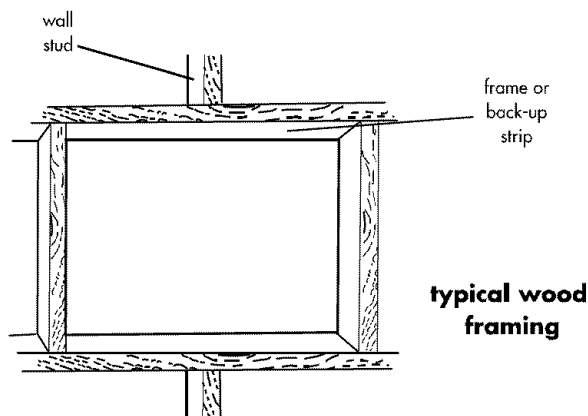

Fig. # 19

3) Now to install, insert the casing into the wall opening. (Remove the chassis out first following steps 1 – 6 in Slide-out chassis section). Make sure that the cabinet is at least 1/2" inch inside the room. Also the side louvers should not be blocked. This is to have proper air circulation in and around the compressor. (See Fig. # 20)

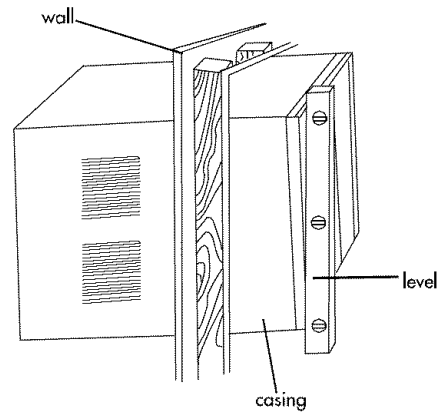

Fig. # 20

**typical casing
outward tip**

- 4) The casing should be tilted 1/4" outside so as to drain the excess dehumidified water.
- 5) Properly insulate any opening between the casing and the frame.
- 6) Using the screw holes on the sides of the unit, which are for the window mounting kit and the screw holes in the top mounting kit rail, attach the casing to the wood frame.
- 7) With the help of another person lift and put the chassis of the air conditioner in to the casing.
- 8) Screw the security screw into place and snap on the grille.
- 9) If the filter was removed during this process, reinsert the filter.

Care and Cleaning Guide

top-air
louvers

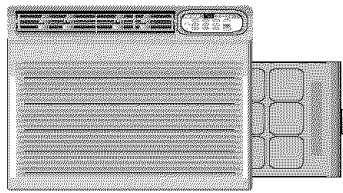
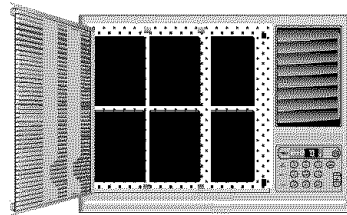

fig. # 21



side-air
louvers

fig. # 22

- **Always unplug your air conditioner before cleaning.**
- **Air filter needs to be cleaned at least once a month for your unit to operate at optimum efficiency.** The filter can be slid out from the side by pulling on the tab located on the middle right side of the front mask. **(See fig.# 21)** Or the filter may be accessed by pressing down on the top and bottom tabs located on the right side of the front mask. **(See fig.# 22)** The filter may be washed or vacuumed. Remove the excess water from the filter by gently shaking the filter. This will remove dust and particles trapped in the filter. After cleaning, reinstall the filter. **DO NOT use your air conditioner without the air filter in place.**
- **To clean the front panels or the cabinet DO NOT use harsh chemicals, abrasives, ammonia, chlorine, bleach, concentrated detergents, solvents or metal scouring pads.** Some of these chemicals may dissolve, damage and/or discolor your air conditioner.
- **Always use a soft cloth dampened with water or mild soap and water solution to wipe the front of the cabinet.**
Wipe dry with a soft cloth.

- To store your air conditioner, after the season, remove the unit from the window as per the installation guide. Repack the unit in its original box and store away. If your unit is installed in a wall or you do not intend to remove it from the window then cover the outside with a winter cover. This can be purchased from the retailer where you purchased your air conditioner or from your local hardware store.
- Before putting away your unit make sure any water left in the pan is removed and drained away. Water left in the pan could lead to Rusting or damage to the electrical connections.

Trouble-Shooting

If air conditioner does not operate:

- Check if unit is plugged in. The plug may have come loose.
- Check if the unit is in "Off" mode.

Air from air conditioner is warm:

- The A/C setting may need to be raised.

Ice formation on cooling coils:

- Outside temperature too cold. Set the unit on fan only setting to defrost ice.
- Lower temperature setting. Temperature setting may be too cold.
- Unit BTU may be too high for the room.

Air conditioner working but room not cooling:

- Room may have appliances that produce heat. Use an exhaust fan to remove excess heat.
- Redirect the airflow. Remove any obstacles.
- All doors and windows need to be closed so cool air does not escape the room.
- Air filter may need cleaning.
- Unit BTU may be too low for the required cooling area.
- On extreme hot & humid days air conditioners may take a little longer to cool.

Air conditioner is making noise when cooling:

You may hear sounds of air movement, water, compressor clicking on and off or window vibrations. Read Operating Guide – Normal Operating Sounds. (See page 8)

Water in the air conditioner cabinet:

This is normal as your air conditioner not only cools but also dehumidifies the air. If there is water dripping inside the room, check the installation of the unit. The unit may need to be reinstalled. (See page 19,22)

Limited Warranty

This warranty covers all defects in workmanship or materials for:

1. The mechanical and electrical parts (including labor costs) contained in this Haier product, for a period of 12 months, from the date of purchase, (commercial or rental application, the warranty is 90 days).
2. The sealed system and compressor contained in this Haier product is for a period of 5 years, from the date of purchase (excluding labor costs after the initial 12 month period). In commercial or rental use, the additional limited compressor warranty is for 1 year and 9 months, (excluding labor costs after the initial 90 days period).

You must keep and be able to provide your original sales receipt as proof of the date of purchase.

Who is covered?

The original retail purchaser of this Haier product.

What will be done?

Haier will repair or replace, in your home, any mechanical, electrical part or the compressor, which proves defective in normal household, use for a period of 12 months. Haier will repair or replace (excluding labor costs) the sealed system and compressor (parts only) for an additional 4 year period.

How can you get service?

1. Contact your nearest Haier authorized Service Depot. For the name of the Service Depot nearest you, contact Haier at (877) 337-3639.
2. All service must be performed, by an authorized Haier Service Depot.

THIS WARRANTY COVERS UNITS WITHIN THE CONTINENTAL UNITED STATES, CANADA AND PUERTO RICO AND DOES NOT COVER:

- Damages from improper installation
- Damages in shipping
- Damages from misuse, abuse, accident, alteration, lack of proper care and maintenance
- Damages from service, by other than an authorized dealer or service center
- Labor, service, transportation and shipping charges for the removal of defective parts and installation of a replacement part, beyond the initial 12 month period.

THIS LIMITED WARRANTY IS GIVEN IN LIEU OF ALL OTHER WARRANTIES, EXPRESS OR IMPLIED, INCLUDING THE WARRANTIES OF MERCHANTABILITY AND FITNESS FOR A PARTICULAR PURPOSE.

The remedy provided in this warranty is exclusive and is granted in lieu of all other remedies. This warranty does not cover incidental or consequential damages. Some states do not allow the exclusion of incidental or consequential damages, so this limitation may not apply to you. Some states do not allow limitations on how long an implied warranty lasts, so this limitation may not apply to you. This warranty gives you specific legal rights, and you may also have other rights, which vary from state to state.

IMPORTANT

Do Not Return This Product To The Store

If you have a problem with this product, please contact the "Haier Customer Satisfaction Center" at 1-877-337-3639.

DATED PROOF OF PURCHASE REQUIRED FOR WARRANTY SERVICE

**FOR SPECIFIC ELECTRICAL RATING,
REFER TO ELECTRICAL RATING NAMEPLATE ON YOUR UNIT**

Made in China

Haier[®]

What The World Comes Home To™

**Haier America
New York, NY 10018**

Printed in China