

OPERATION MANUAL

SHARP®

LCD COLOR TV

LC-13SH1U (13 INCH EASEL TYPE TABLE STAND)
LC-15SH1U (15 INCH EASEL TYPE TABLE STAND)
LC-20SH1U (20 INCH EASEL TYPE TABLE STAND)

FEATURES

- **MTS/SAP Tuner**
- **181 Channel Selection**- All VHF/UHF channels plus up to 125 cable channels.
- **PLL Frequency Synthesized Tuning**- The latest PLL frequency synthesized electronic tuning system provides free and easy channel selection and lets you tune directly to any channel using the number buttons (0-9 and +100-key) on the remote control.
- **On-Screen Function Display**
- **Remote Control**
- **Sleep Timer**
- **Closed Caption Decoder**- You may view specially labeled (cc) TV programs, movies, news, prerecorded tapes, etc. with either a dialogue caption or text display added to the program.
- **Auto Shut Off Function**- If there is no signal input from the antenna terminal and no user operation for 15 minutes, the TV will turn itself off automatically.
- **V-CHIP**- Enables parents to prevent their children from watching inappropriate material on TV.
- **S-VIDEO Input**- allows you to get better picture detail and clarity for the playback of S-VHS VCR tapes, Video Discs, Satellite System, Video Game or Video Cameras.
- **Component Input**

PRECAUTIONS

- Place your TV in a room with adequate ventilation.
- Keep your TV set away from sources of direct heat, such as heat registers or direct sunlight.
- Do not place your TV on soft surfaces, such as rugs or blankets.
- Leave enough room for air to circulate around the bottom, top and back of the set.

This manual describes the LC-13SH1U, LC-15SH1U, and LC-20SH1U. These three models are different in size and shape, but operate identically. The LC-20SH1U is illustrated in this manual.



Products that have earned the ENERGY STAR® are designed to protect the environment through superior energy efficiency.

Warranties are located on the back of the Spanish Operation Manual.

1EMN20180
9HS1EMN20180

Printed in China
L0171UB/L0270UA/L0370UA * * * *

DEAR SHARP CUSTOMER

Thank you for your purchase of the Sharp LCD COLOR TV. To ensure safety and many years of trouble-free operation of your product, please read the IMPORTANT SAFEGUARDS carefully before using this product.

IMPORTANT SAFEGUARDS

1. Read instructions-All the safety and operating instructions should be read before the appliance is operated.
2. Retain Instructions-The safety and operating instructions should be retained for future reference.
3. Heed Warnings-All warnings on the appliance and in the operating instructions should be adhered to.
4. Follow Instructions-All operating and use instructions should be followed.
5. Cleaning-Unplug TV from the wall outlet before cleaning. Do not use liquid cleaners or aerosol cleaners. Use a damp cloth for cleaning.
EXCEPTION: A product that is meant for uninterrupted service and that for some specific reason, such as the possibility of the loss of an authorization code for a CATV converter, is not intended to be unplugged by the user for cleaning or any other purpose, may exclude the reference to unplugging the appliance in the cleaning description otherwise required in item 5.
6. Attachments-Do not use attachments not recommended by the TV manufacturer as they may cause hazards.
7. Water and Moisture-Do not use this TV near water, for example, near a bath tub, wash bowl, kitchen sink, or laundry tub, in a wet basement, or near a swimming pool, and the like.
8. Accessories-Do not place this TV on an unstable cart, stand, tripod, bracket, or table. The TV may fall, causing serious injury to someone, and serious damage to the appliance. Use only with a cart, stand, tripod, bracket, or table recommended by the manufacturer, or sold with the TV.
PORTABLE CART WARNING

S3726A
9. Ventilation-Slots and openings in the cabinet and the back or bottom are provided for ventilation and to ensure reliable operation of the TV and to protect it from overheating, these openings must not be blocked or covered. The openings should never be blocked by placing the TV on a bed, sofa, rug, or other similar surface. This TV should never be placed near or over a radiator or heat register. This TV should not be placed in a built-in installation such as a bookcase or rack unless proper ventilation is provided or the manufacturer's instructions have been adhered to.
10. Power Sources-This TV should be operated only from the type of power source indicated on the marking label. If you are not sure of the type of power supply to your home, consult your appliance dealer or local power company. For TVs intended to operate from battery power, or other sources, refer to the operating instructions.
11. Grounding or Polarization-This TV is equipped with a polarized alternating-current line plug (a plug having one blade wider than the other). This plug will fit into the power outlet only one way. This is a safety feature. If you are unable to insert the plug fully into the outlet, try reversing the plug. If the plug should still fail to fit, contact your electrician to replace your obsolete outlet. Do not defeat the safety purpose of the polarized plug.
12. Power-Cord Protection-Power-supply cords should be routed so that they are not likely to be walked on or pinched by items placed upon or against them, paying particular attention to cords at plugs, convenience receptacles, and the point where they exit from the appliance.
13. Outdoor Antenna grounding-If an outside antenna or cable system is connected to the TV, be sure the antenna or cable system is grounded so as to provide some protection against voltage surges and built-up static charges. Article 810 of the National Electrical Code, ANSI/NFPA No. 70, provides information with respect to proper grounding of the mast and supporting structure, grounding of the lead-in wire to an antenna discharge unit, size of grounding conductors, location of antenna-discharge unit, connection to grounding electrodes, and requirements for the grounding electrode. (Fig. A)
14. Lightning-For added protection for this TV receiver during a lightning storm, or when it is left unattended and unused for long periods of time, unplug it from the wall outlet and disconnect the antenna or cable system. This will prevent damage to the TV due to lightning and power-line surges.
15. Power Lines-An outside antenna system should not be located in the vicinity of overhead power lines or other electric light or power circuits, or where it can fall into such power lines or circuits. When installing an outside antenna system, extreme care should be taken to keep from touching such power lines or circuits as contact with them might be fatal.
16. Overloading-Do not overload wall outlets and extension cords as this can result in a risk of fire or electric shock.
17. Object and Liquid Entry-Never push objects of any kind into this TV through openings as they may touch dangerous voltage points or short out parts that could result in a fire or electric shock. Never spill liquid of any kind on the TV.
18. Servicing-Do not attempt to service this TV yourself as opening or removing covers may expose you to dangerous voltage or

excessive force, and uneven surfaces may cause the appliance and cart combination to overturn.



CAUTION: TO REDUCE THE RISK OF ELECTRIC SHOCK, DO NOT REMOVE COVER (OR BACK) NO USER SERVICEABLE PARTS INSIDE. REFER SERVICING TO QUALIFIED SERVICE PERSONNEL.

 THIS SYMBOL INDICATES THAT DANGEROUS VOLTAGE CONSTITUTING A RISK OF ELECTRIC SHOCK IS PRESENT WITHIN THIS UNIT.

 THIS SYMBOL INDICATES THAT THERE ARE IMPORTANT OPERATING AND MAINTENANCE INSTRUCTIONS IN THE LITERATURE ACCOMPANYING THE APPLIANCE.

The important note is located on the rear of the cabinet.

WARNING:
TO REDUCE THE RISK OF FIRE OR ELECTRIC SHOCK, DO NOT EXPOSE THIS APPLIANCE TO RAIN OR MOISTURE.

CAUTION: TO PREVENT ELECTRIC SHOCK, MATCH WIDE BLADE OF PLUG TO WIDE SLOT, FULLY INSERT.

FCC WARNING- This equipment may generate or use radio frequency energy. Changes or modifications to this equipment may cause harmful interference unless the modifications are expressly approved in the instruction manual. The user could lose the authority to operate this equipment if an unauthorized change or modification is made.

U.S.A. ONLY

"Note to CATV system installer: This reminder is provided to call the CATV system installer's attention to Article 820-40 of the National Electrical Code that provides guidelines for proper grounding and, in particular, specifies that the cable ground shall be connected to the grounding system of the building, as close to the point of cable entry as practical."

This product utilizes tin-lead solder, and fluorescent lamp containing a small amount of mercury. Disposal of these materials may be regulated due to environmental considerations. For disposal or recycling information, please contact your local authorities or the Electronic Industries Alliance: www.eia.org

The LCD panel used in this product is made of glass. Therefore, it can break when the product is dropped or applied with impact. Be careful not to be injured by broken glass pieces in case the LCD panel breaks.

The LCD panel is a very high technology product with 921,600 thin film transistors, giving you fine picture details. Occasionally, a few non-active pixels may appear on the screen as a fixed point of blue, green or red. Please note that this does not affect the performance of your product.

To prevent fire, never place any type of candle or flames on the top or near the TV set.

To prevent fire or shock hazard, do not expose this product to dripping or splashing. No objects filled with liquids, such as vases, should be placed on the product.

The serial number of this product may be found on the back of the TV. No others have the same serial number as yours. You should record the number and other vital information here and retain this book as a permanent record of your purchase to aid identification in case of theft.

U.S.A. ONLY

IMPORTANT:

To aid reporting in case of loss or theft, please record the TV's model and serial numbers in the space provided. The numbers are located at the rear of the TV.

Model No.:
Serial No

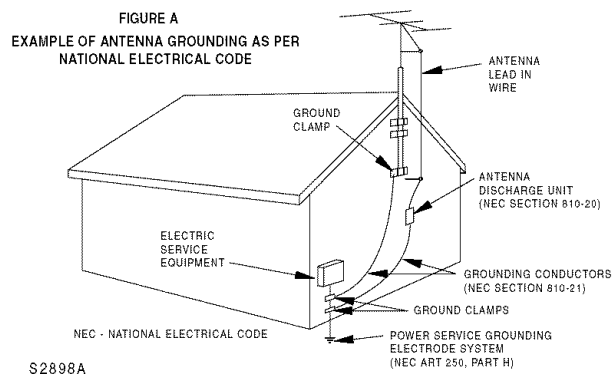

tection against voltage surges and built-up static charges. Article 810 of the National Electrical Code, ANSI/NFPA No. 70, provides information with respect to proper grounding of the mast and supporting structure, grounding of the lead-in wire to an antenna discharge unit, size of grounding conductors, location of antenna-discharge unit, connection to grounding electrodes, and requirements for the grounding electrode. (Fig. A)

14. Lightning-For added protection for this TV receiver during a lightning storm, or when it is left unattended and unused for long periods of time, unplug it from the wall outlet and disconnect the antenna or cable system. This will prevent damage to the TV due to lightning and power-line surges.
15. Power Lines-An outside antenna system should not be located in the vicinity of overhead power lines or other electric light or power circuits, or where it can fall into such power lines or circuits. When installing an outside antenna system, extreme care should be taken to keep from touching such power lines or circuits as contact with them might be fatal.
16. Overloading-Do not overload wall outlets and extension cords as this can result in a risk of fire or electric shock.
17. Object and Liquid Entry-Never push objects of any kind into this TV through openings as they may touch dangerous voltage points or short out parts that could result in a fire or electric shock. Never spill liquid of any kind on the TV.
18. Servicing-Do not attempt to service this TV yourself as opening or removing covers may expose you to dangerous voltage or

19. other hazards. Refer all servicing to qualified service personnel.
19. Damage Requiring Service-Unplug this TV from the wall outlet and refer servicing to qualified service personnel under the following conditions:
 - a. When the power supply cord or plug is damaged or frayed.
 - b. If liquid has been spilled, or objects have fallen into the TV.
 - c. If the TV has been exposed to rain or water.
 - d. If the TV does not operate normally by following the operating instructions. Adjust only those controls that are covered by the operating instructions, as improper adjustment of other controls may result in damage and will often require extensive work by a qualified technician to restore the TV to its normal operation.
 - e. If the TV has been dropped or damaged in any way.
 - f. When the TV exhibits a distinct change in performance-this indicates a need for service.
20. Replacement Parts-When replacement parts are required, be sure the service technician uses replacement parts specified by the manufacturer that have the same characteristics as the original part. Unauthorized substitutions may result in fire, electric shock, injury to persons or other hazards.
21. Safety Check-Up-On completion of any service or repairs to this TV, ask the service technician to perform routine safety checks to determine that the TV is in proper operating condition.
22. Heat-This TV product should be situated away from heat sources such as radiators, heat registers, stoves, or other products (including amplifiers) that produce heat.

TABLE STAND

EASEL TYPE

The angle of the TV has to be kept at 18°.

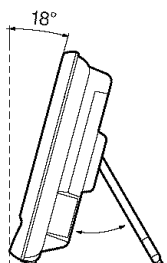

CAUTION:

Be careful not to hurt your fingers with the stand. Do not pick up the TV by its stand.

OPERATING CONTROLS AND FUNCTIONS

- FRONT PANEL -

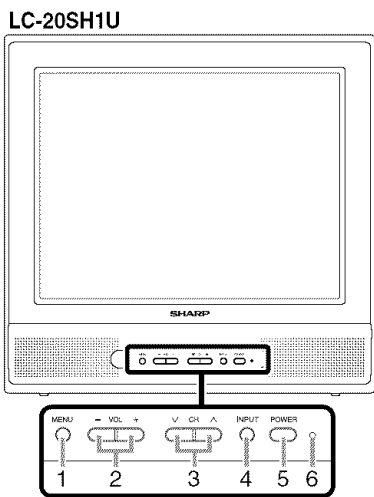

- MENU button**- Press to display the menu on the TV screen.
- VOL (ume) +/- buttons**- Press to control the volume level.
Press to determine the setting mode from the menu on the TV screen (only the VOL + button).
Press to select or adjust from a particular menu (for example: Language Selection, Channel Presetting, Closed Caption Selection, Picture Adjustment or V-CHIP Set Up).
- CH (annel) ▲/▼ buttons**- Press to select memorized channel.
Press to select the setting mode from the menu on the TV screen.
Press to select item you want to adjust in the picture control mode.
- INPUT button**- Press to select TV or video input (AV1 or AV2) mode.
(See USING AUDIO/VIDEO INPUT JACKS.)
- POWER button**- Press to turn the TV ON or OFF (standby).
- Power indicator**- Lights up when power is on.

- REMOTE CONTROL -

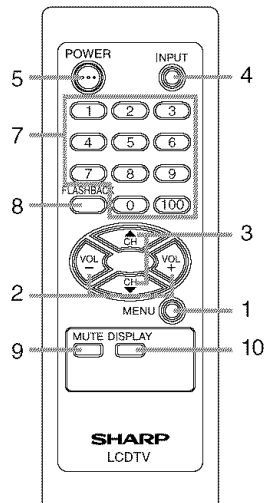

- Number buttons**- Press two digits to directly access the desired channel.
Remember to press a "0" before a single digit channel.
100 button- Press to select cable channels higher than 99.
- FLASHBACK button**- Press to go back to the previously viewed channel. For example, pressing this button once will change channel display from CH 3 (present channel) to CH 10 (previously viewed channel) and pressing it a second time will return from CH 10 to CH 3.
- MUTE button**- Press to mute the sound portion of the TV program (Volume level display turns LIGHT RED from LIGHT BLUE). Press this button again or press the VOL + or - button to restore sound.
- DISPLAY button**- Press to display the channel number or input source on the screen. If you press it again, the display will disappear.
- COMPONENT (Y/Pb/Pr) video input jacks**- AV2: Connect to the component video out jacks of a DVD or set top box.

- REAR PANEL -

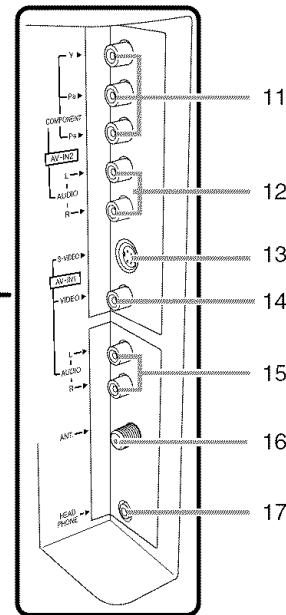
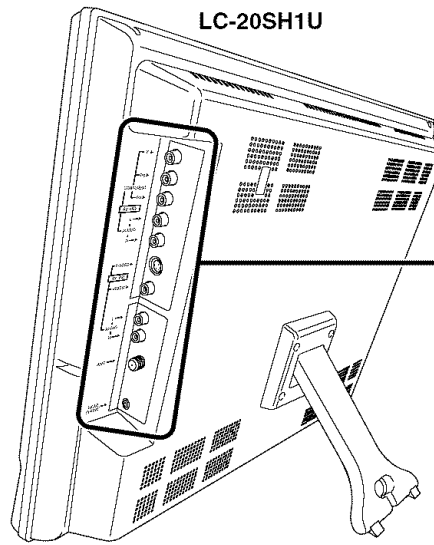

- If HDTV (480p/720p/1080i) signals are input to these jacks, "NOT AVAILABLE" will appear on the black background.
- AUDIO L/R input jacks**- AV2: Connect to the left/right audio output jacks of a DVD player or set top box.
 - S-VIDEO input jack**- AV1: Connect to the S-VIDEO output jack of a video camera or VCR using the S-VIDEO cable (not supplied).
Note: The S-VIDEO jack is given priority over the VIDEO jack.
 - VIDEO input jack**- AV1: Connect to the video output jack of a video camera, VCR or video game.
 - AUDIO L/R input jacks**- AV1: Connect to the left/right audio output jacks of a video camera, VCR or video game.
Note: The AUDIO L (input) jack is for mono input. The sound is heard from both speakers. Use this jack for monaural audio equipment to be hooked up.

- ANT(enna), in jack**- Connect to an antenna, cable system or satellite system.
- HEADPHONE jack**- Connect headphone (not supplied) for personal listening.
Note: Do not connect earphones that have an L-shaped plug. The plug may interfere with the cabinet.

[INSTALLING THE BATTERIES]

- Remove the battery compartment cover on the remote unit.
- Insert 2 "AA" penlight batteries into battery compartment in the direction as indicated by the polarity (+ / -) markings. Batteries installed with incorrect polarity may damage the remote unit.
- Replace the cover.

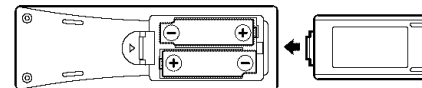

PREPARATION FOR USE

CONNECTIONS

[ANTENNA CONNECTION]

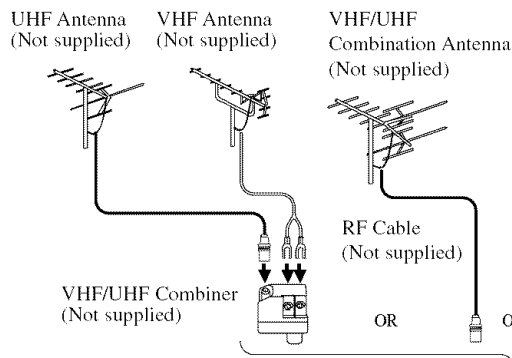

[CATV/SATELLITE CONNECTION]

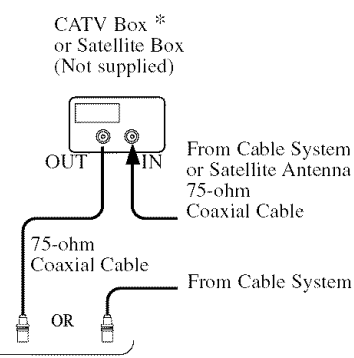

LC-20SH1U

*Some cable TV systems use scrambled signals and require a special converter to receive these channels. Consult your local cable company.

CHANNEL PRESETTING

To preset a channel or to change a preset channel, follow the procedure below.

- Press the POWER button to turn on the TV.
- Press the MENU button so that the menu display appears on the TV screen.
- Press the CH ▲ or ▼ button to point to "CHANNEL SET UP".
Then press the VOL + button.
- Press the CH ▲ or ▼ button to point to "AUTO PRESET CH".
Then press the VOL + button.
The tuner scans and memorizes all active channels in your area.
 - The TV distinguishes between standard TV channels and cable (CATV) channels.
 - When AUTO PRESET CH is completed, the lowest memorized channel reappears on the screen. When there is no signal to ANT. in jack, "NO TV SIGNAL" will appear. In this case, please check the antenna connections, then try again the auto preset channel.
 - After completing AUTO PRESET CH, you can use CH ▲ or ▼ buttons for the memorized channels.
 - The TV may memorize TV channels as CATV channels if the reception conditions are poor. If this happens, try the AUTO PRESET CH action again when reception conditions are better.

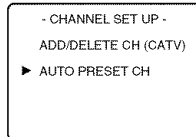
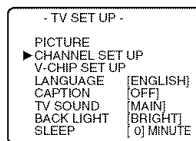

[ADD/DELETE FUNCTION]

- Press the MENU button so that the menu display appears on the TV screen.
- Press the CH ▲ or ▼ button to point to "CHANNEL SET UP".
Then, press the VOL + button.
- Press the VOL + button so that "ADD/DELETE CH" is selected.
- Deleting a Channel:**
 - Use the CH ▲ or ▼ button to select the channel you wish to delete, then press the VOL + button so the channel number on the top right corner of the TV screen turns into RED.
- Adding a Channel:**
 - Use the Number buttons to input the channel you wish to add, then press the VOL + button so the channel number on the top right corner of the TV screen turns into BLUE.

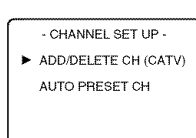
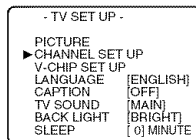

LANGUAGE SELECTION

If you want to change the language of the on-screen menu, follow the procedure below.

- Connect the power cord to a standard AC outlet.
Note: If some digits appear in the corner of the screen, press the POWER button without unplugging the power cord.
- Press the POWER button to turn on the TV.
- Press the MENU button so that the menu display appears on the TV screen.
- Press the CH ▲ or ▼ button to point to "LANGUAGE".
- Select [ENGLISH], [ESPAÑOL] or [FRANÇAIS] by using the VOL + or - button.
- Press the MENU button to exit the menu.

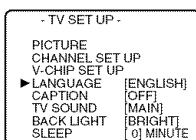
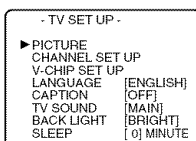

RESUME FUNCTION

If the power fails or is disconnected while the TV is powered on, the TV will turn on automatically when the power resumes.

PREPARATION FOR USE (Continued)

MTS (Multi-Channel Television Sound) SYSTEM

You can listen to a program in MTS stereo following the steps below.

Menu Selection Type of broadcast	MAIN	MONO	SAP
Regular	-None-	-None-	-None-
Stereo broadcast	STEREO	MONO	STEREO
SAP	MAIN	MAIN	SAP

To show the status, press the DISPLAY button on the remote control.

SAP: Second Audio Program, which means your program, can also be received in a second language or sometimes a radio station.

[To Select STEREO, MONO or SAP in Stereo broadcast]

- 1) Press the MENU button so that the menu display appears on the TV screen.
- 2) Press the CH ▲ or ▼ button to point to "TV SOUND".
- 3) Press the VOL + or – button to select your desired stereo mode.

([MAIN], [MONO] or [SAP])

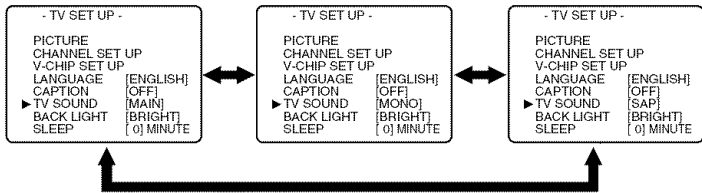

- 4) Press the MENU button to exit the menu.

OPERATIONS

WATCHING A TV PROGRAM

- 1) Press the POWER button to turn on the TV.
- 2) Select the desired channel with the CH ▲ or ▼ button or the Number buttons.
- 3) Adjust the volume to the desired listening level using the VOL + or – button.
- 4) Adjust picture controls for a natural looking image. (See "PICTURE ADJUSTMENT".)

USING AUDIO/VIDEO INPUT JACKS

When you use the AUDIO/VIDEO input jacks, select "AV1" or "AV2" mode by pressing the INPUT button.

- To use the jacks of AV-IN1 on the TV, select "AV1".
- To use the jacks of AV-IN2 on the TV, select "AV2".

Note: When you use the S-VIDEO connection, S-VIDEO jack is given priority over the VIDEO jack.

OPERATIONS (Continued)

SETTING THE SLEEP TIMER

Use Sleep Timer to program the TV to shut off in a certain amount of time.

- 1) Press the POWER button to turn on the TV.
- 2) Press the MENU button so that the menu display appears on the TV screen.
- 3) Press the CH ▲ or ▼ button to point to "SLEEP".

Then press the VOL + button.

- 4) Press the VOL + or – until the correct amount of time appears on the TV screen.

The time increases by 30 minutes. You may set a Sleep Timer of 30, 60, or 90 minutes.

Note: When you disconnect the unit from the AC outlet or when you have a power failure, the sleep time will be lost.

To cancel the sleep timer:
Press the VOL + or – repeatedly until "SLEEP [0] MINUTE" is displayed.

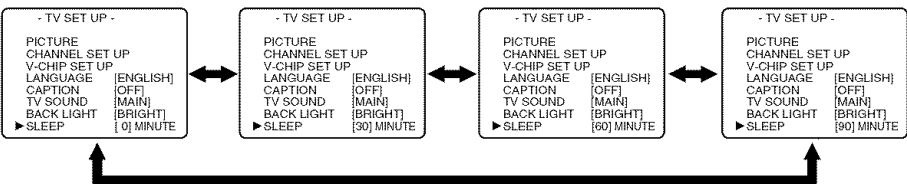

PICTURE ADJUSTMENT

- 1) Press the MENU button so that the menu display appears on the TV screen.
- 2) Press the CH ▲ or ▼ button to point "PICTURE". Then press the VOL + button.
- 3) Select the feature you wish to adjust with the CH ▲ or ▼ button and adjust it with the VOL + or – button.

↔ : Press the CH ▲ or ▼ button.

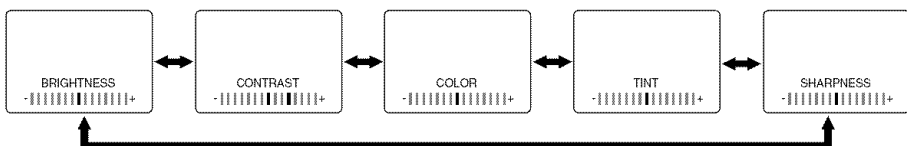

Note: In the above steps, the picture adjustment display will disappear from the TV screen automatically after approximately 5 seconds if you do not press any buttons. Press the MENU and VOL + button so that "PICTURE" is selected. Then press the CH ▲ or ▼ button repeatedly until the display returns to the screen.

	VOL –	VOL +
BRIGHTNESS	to decrease brightness	to increase brightness
CONTRAST	to decrease contrast	to increase contrast
COLOR	to pale	to brilliant
TINT	to purple	to green
SHARPNESS	to soft	to clear

CLOSED CAPTION

[CLOSED CAPTION SELECTION]

This TV can receive Caption and Text.

You may view specially labeled (cc) TV programs, movies, news and prerecorded tapes, etc. with either a dialogue caption or text display added to the program.

- 1) Press the MENU button so that the menu display appears on the TV screen.
- 2) Press the CH ▲ or ▼ button to point to "CAPTION".
- 3) Press the VOL + or – button to select the mode you wish.
- 4) When done, press the MENU button to exit the menu.

↔ : Press the VOL + or – button.

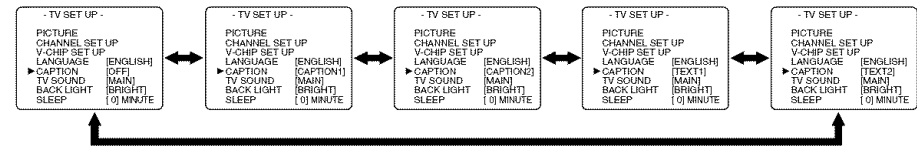

[CAPTION MODE]

- 1) Closed Caption Characters can be displayed on the TV screen only when the received broadcast signal contains Caption Signals.

- 2) **Paint-on mode:** Displays input characters on the screen immediately.

Pop-on mode: Once characters are stored in memory, they are displayed all at once.

Roll-up mode: Displays the characters continuously by scrolling (max. 4 lines)

Note: If [CAPTION1] or [CAPTION2] is selected but a Closed Caption signal is not included, characters will not be displayed.

[TEXT MODE]

- 1) Displays the text on the screen by scrolling (max. 7 lines).
- 2) If the received broadcast signal does not contain caption or text signals, no change will occur.

Notes:

- 1) When your TV receives a special effects playback signal (i.e., Search, Slow and Still) from a VCR's video output channel (CH3 or CH4), your TV may not display the correct caption or text.
- 2) Captions and texts may not match the TV voice exactly.
- 3) Interference may cause the closed caption system not to function properly.
- 4) The caption or text characters will not be displayed while the menu display or functions display is shown.
- 5) **If you see this screen:**



If your TV displays a black box on the screen, this means that your TV is set to TEXT mode. To clear screen, select [CAPTION1], [CAPTION2] or [OFF].

BACK LIGHT SELECTION

- 1) Press the MENU button so that the menu display appears on the TV screen.
- 2) Press the CH ▲ or ▼ button to point to "BACK LIGHT".
- 3) Press the VOL + or – button to select the mode you wish.
- 4) When done, press the MENU button to exit the menu.

↔ : Press the VOL + or – button.

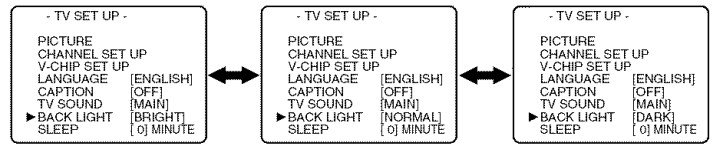

V-CHIP SET UP

V-CHIP enables parents to prevent their children from watching inappropriate material on TV.

V-CHIP reads the ratings for programming (except for news and sports programs, unedited movies on premium cable channels, and Emergency Broadcast System signals), then denies access to programming if the program's rating meets or exceeds the limitations you select. In this case, "PROTECTED PROGRAM by ..." message appears on the TV screen.

To block certain ratings, follow the steps below.

- Programming may be rated by the Motion Picture Association of America (MPAA) or according to the Television Parental Guidelines. In order to block any inappropriate programming, set your limits in both places (MPAA RATING and TV RATING).
- You cannot access the menu when the "PROTECTED PROGRAM by ..." message appears. In this case, change to an unblocked channel, then press the MENU button.

[MPAA RATING SET UP]

- 1) Press the MENU button so that the menu display appears on the TV screen.
- 2) Press the CH ▲ or ▼ button to point to "V-CHIP SET UP". Then press the VOL + button.
- 3) Use the number buttons to enter 4-digit access code. The default access code is 0000. If you have not set up your personal access code, you should use 0000.
- 4) Press the CH ▲ or ▼ button to point to "MPAA RATING". Then press the VOL + button.
- 5) Press the CH ▲ or ▼ button to point to your desired item. Then press the VOL + button to select [BLOCK] or [VIEW].

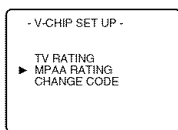
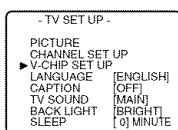

OPERATIONS (Continued)

<Selection>	<Rating Category Explanations>
• G:	General Audience
• PG:	Parental Guidance suggested.
• PG-13:	Unsuitable for children under 13
• R:	Restricted; under 17 requires accompanying parent or adult guardian
• NC-17:	No one under 17 admitted
• X:	Mature audience only

▶ G	[VIEW]
▶ PG	[VIEW]
▶ PG-13	[VIEW]
▶ R	[VIEW]
▶ NC-17	[VIEW]
▶ X	[VIEW]

- When you select the rating category and set it to [BLOCK], the higher rating will turn to [BLOCK] automatically. Also, the lower rating will turn to [VIEW] automatically.
 - When you turn "G" to [BLOCK] or [VIEW], the all ratings will turn to [BLOCK] or [VIEW] automatically.
 - When you turn "X" to [VIEW], then all ratings will turn to [VIEW] automatically.
- 6) Press the MENU button to exit the menu.

[TV RATING SET UP]

- 1) Press the MENU button so that the menu display appears on the TV screen.
- 2) Press the CH ▲ or ▼ button to point to "V-CHIP SET UP". Then press the VOL + button.
- 3) Use the number buttons to enter 4-digit access code. The default access code is 0000. If you have not set up your personal access code, you should use 0000.
- 4) Press the CH ▲ or ▼ button to point to "TV RATING". Then press the VOL + button.
- 5) Press the CH ▲ or ▼ button to point to your desired item. Then press the VOL + button to select [BLOCK] or [VIEW].

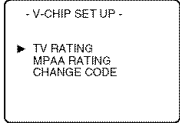

▶ TV-Y	[VIEW]
▶ TV-Y7 ()	[VIEW]
▶ TV-G	[VIEW]
▶ TV-PG()	[VIEW]
▶ TV-14 ()	[VIEW]
▶ TV-MA ()	[VIEW]

<Selection>	<Rating Category Explanations>
• TV-Y:	Appropriate for all children
• TV-Y7:	Appropriate for children seven and older
• TV-G:	General Audience
• TV-PG:	Parental Guidance suggested.
• TV-14:	Unsuitable for children under 14
• TV-MA:	Mature audience only

- When you select the rating category and set it to [BLOCK], the higher rating will turn to [BLOCK] automatically. Also, the lower rating will turn to [VIEW] automatically.
 - When you turn "TV-Y" to [BLOCK] or [VIEW], then all ratings will turn to [BLOCK] or [VIEW] automatically.
 - When you turn "TV-MA" to [VIEW], then all ratings will turn to [VIEW] automatically.
- 6) Press the MENU button to exit the menu.

[V-CHIP SET UP SUB RATINGS]

When you select TV-Y7, TV-PG, TV-14 or TV-MA and you press the VOL + button, the sub-ratings will appear on the TV screen.

If you select the rating category (example: TV-PG) and set it to [BLOCK] or [VIEW], the sub-ratings (example: V for Violence) will turn to [BLOCK] or [VIEW] automatically.

You can set the sub-ratings to [BLOCK] or [VIEW] individually when the rating category is set to [BLOCK]. To set the sub-ratings individually, follow the steps below.

- **When you select [TV-Y7]:**
Press the CH ▲ or ▼ button to select "FV" (Fantasy Violence). Then press the VOL + button to select [BLOCK] or [VIEW].
- **When you select [TV-PG], [TV-14] or [TV-MA]:**
Press the CH ▲ or ▼ button to select "D" (Suggestive Dialogue), "L" (Coarse Language), "S" (Sexual Situation) or "V" (Violence). Then press the VOL + button to select [BLOCK] or [VIEW].
Note: When you select [TV-MA], "D" does not appear on the TV screen.
- The sub-ratings which set to [BLOCK] appear next to the rating category in the "TV RATING" menu.
- Press the MENU button to exit the menu.

TV-Y	[VIEW]
▶ TV-Y7 ()	[VIEW]
▶ TV-PG(DLSV)	[BLOCK]
▶ TV-14 (DLSV)	[BLOCK]
▶ TV-MA(LSV)	[BLOCK]

TV-Y7	[BLOCK]
▶ FV	[BLOCK]

TV-PG	[BLOCK]
▶ D	[BLOCK]
▶ L	[BLOCK]
▶ S	[BLOCK]
▶ V	[BLOCK]

[V-CHIP ACCESS CODE]

To change access code, follow steps.

- 1) Press the MENU button, then press the CH ▲ or ▼ button to select "V-CHIP SET UP". Press the VOL + button to continue.
 - 2) Press the number buttons to enter your old access code. If you have never set up your personal access code, use 0000.
 - 3) Press the CH ▲ or ▼ button to select "CHANGE CODE". Then press the VOL + button to continue.
 - 4) Use the number buttons to enter your desired access code in the NEW CODE space. Then enter the same code in the CONFIRM CODE space. Your new access code is set. You will return to the "V-CHIP SET UP".
- If the code in the CONFIRM CODE space does not match the code in the NEW CODE space, repeat step 4, making sure you enter the same new code exactly in the CONFIRM CODE space.

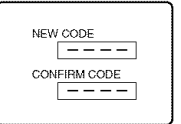
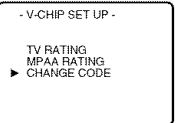
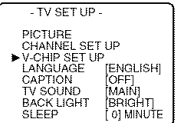

- NOTES:**
- If a power failure occurs, the default code, 0000, will be the active access code again.
 - If you connect the power cord to an AC outlet that is controlled by a wall switch, your personal access code will be erased every time you turn off the power at the wall switch. The default code will be the active code again.

[IF YOU FORGET YOUR ACCESS CODE]

You should restore the access code to default code, 0000. To restore 0000 as your personal access code, unplug the TV's power cord for 10 seconds, then plug it in again.

TROUBLESHOOTING GUIDE

Sometimes a performance problem can be easily solved by checking seemingly apparent but often overlooked possibilities. Before arranging for service, check these items. It could save your time and money.

QUICK SERVICE CHECK LIST	PROBLEM	Remote Control Doesn't Work													
		Bars On Screen	Picture Distorted	Picture Rolls Vertically	No Color	Poor Reception on Some Channels	Weak Picture	Lines or Streaks in Picture	Ghosts in picture	Picture Blurred	Sound OK, Picture Poor	Picture OK, Sound Poor	No Picture or Sound	Different color marks on screen	Black or Luminous point on Screen
Try a new channel, if OK, then possible station trouble.															
Is TV plugged in?		X													
Power at outlet?															
Is TV's POWER button on?															
Is antenna connected to terminal on the back of the set?															
If outside antenna is being used, check for broken wire.		X	X	X	X	X	X	X	X	X	X	X	X	X	X
Check for local interference.		X	X	X	X	X	X	X	X	X	X	X	X	X	X
Turn off with POWER button and then turn it on after about a minute.															
Adjust COLOR control.					X										
Adjust CONTRAST & BRIGHT control.										X					
Check batteries in Remote Control.		X													
Move the TV away from the nearby appliances which have Magnetism.															X
Turn off using the POWER button, then turn it on again 30 minutes or so later.															
Temperature around is too low.				X							X				
Life of the Back Light is approximately 50,000 hours. Ask the Service Center to replace.															
It is quality of the LCD Panel.															X

Closed Caption Problem	Possible Remedy
My TV is showing captions that are misspelled.	You are watching a live broadcast and spelling errors made by the closed captioning production company may pass through uncorrected. A prerecorded program will not show any misspelled words because of the normal time available for editing the captions.
My TV will not show the text in its entirety or there is a delay of what is being said.	Captions that are delayed a few seconds behind the actual dialogue are common for live broadcasts. Most captioning production companies can display a dialogue to a maximum of 220 words per minute. If a dialogue exceeds that rate, selective editing is used to insure that the captions remain up-to-date with the current TV screen dialogue.
My captions are scrambled with white boxes on the TV screen.	Interference caused by building, power lines, thunderstorms, etc. may cause scrambled or incomplete captions to appear.
My program guide listed a TV show as being closed captioned but none of the captions were displayed.	Broadcasters may at times use a time compression process to the actual program so that additional advertising time can be given. Since the decoder cannot read the compressed information, captions will be lost.
My prerecorded videotape does not show any captions. The tape box mentions it being closed captioned.	The videotape was either an illegal copying or the tape duplicating company accidentally left out the captioning signals during the copying process.
My TV screen shows a black box on certain channels.	You are in the TEXT mode. Select CAPTION mode or CAPTION [OFF].

The LCD panel is manufactured to provide many years of useful life. Occasionally a few non active pixels may appear as a tiny spec of color. This in not to be considered a defect in the LCD screen.

MAINTENANCE

CABINET CLEANING

- Wipe the front panel and other exterior surfaces of the TV with a soft cloth immersed in lukewarm water and wrung dry.
- Never use a solvent or alcohol. Do not spray insecticide liquid near the TV. Such chemicals may cause damage and discoloration to the exposed surfaces.

PICTURE SCREEN CLEANING

If the LCD panel should require cleaning, wipe it with a cotton or soft cloth. Before cleaning the picture screen, disconnect the power cord.

SUPPLIED ACCESSORIES

Remote control unit (UREMT21SH001/9HSUREMT21SH001)	Operation Manual (1EMN20180/9HS1EMN20180) (1EMN20181/9HS1EMN20181)
Batteries ("AA" x 2)	

SPECIFICATIONS

GENERAL SPECIFICATIONS	OTHER SPECIFICATIONS
Television system: NTSC-M TV Standard	Remote control: Digital encoded infrared light system
Closed Caption System: §15.119/FCC	Power requirements: AC120V, 60Hz
Channel coverage	Power consumption (Maximum): 56W
VHF: 2 ~ 13	LCD: 13"
UHF: 14 ~ 69	Dimensions (H x W x D): 12-3/4" x 13" x 3-13/16"
CATV: 2 ~ 13, A ~ W, W+1 ~ W+84, A-5 ~ A-1, 5A	(including the table stand) (325mm x 330mm x 97mm)
Tuning System: 181 channel frequency synthesized tuning system	Weight: 6.8 lbs. (3.1kg)
Channel access: Direct access keyboard, programmable scan and up/down	(including the table stand)
Terminals	[LC-15SHIU]
Antenna input: VHF/UHF/CATV 75 ohm unbalanced (F-type)	Power consumption (Maximum): 65W
S-Video input: Mini DIN 4-pin jack	LCD: 15"
Video input: RCA connector x 1	Dimensions (H x W x D): 14-1/16" x 14-15/16" x 3-13/16"
Audio input: RCA connector x 4	(including the table stand) (357mm x 379mm x 97mm)
Component video input: One pin jack (Y), 1Vpp (75 ohm) Two pin jacks (Pe/Ps), 700mVpp (75 ohm)	Weight: 7.9 lbs. (3.6kg)
Headphone: 1/8" stereo (3.5 mm)	(including the table stand)
Stereo Sound System	[LC-20SHIU]
2 speakers	Power consumption (Maximum): 73W
2 ways AV input	LCD: 20"
Sound output: 1W, 8 ohm x 2	Dimensions (H x W x D): 17-1/2" x 19-7/16" x 4-3/16"
	(including the table stand) (445mm x 493mm x 107mm)
	Weight: 11.9 lbs. (5.4kg)
	(including the table stand)

• Designs and specifications are subject to change without notice and without our legal obligation.
• If there is a discrepancy between languages, the default language will be English.