

SAMSUNG

LT-P326W

TFT-LCD TELEVISION

→ **Owner's
Instructions**

This device is a Class B digital apparatus.

Chapter 1: Your New TV

List of Features	1
List of Parts	1
Familiarizing Yourself with Your New TV	2
Right-side Panel Buttons	2
Rear Panel Jacks	3
Remote Control	4
Installing Batteries in the Remote Control	6
If remote control doesn't work	6

Chapter 2: Installation

Connecting VHF and UHF Antennas	7
Antennas with 300-ohm Flat Twin Leads	7
Antennas with 75-ohm Round Leads	8
Separate VHF and UHF Antennas	8
Connecting Cable TV	8
Cable without a Cable Box	8
Connecting to a Cable Box that Descrambles All Channels	9
Connecting to a Cable Box that Descrambles Some Channels	9
Connecting HDMI	11
How to connect Core	11
Connecting a VCR	12
Connecting an S-VHS VCR	13
Connecting a DVI-D Cable	13
Connecting a DVD Player	14
Connecting a Digital TV Set-Top Box	14
Connecting a PC	14
ANYNET	16
What is the Anynet	16
Anynet	17
Connecting TV + DVD/VCR Combo:	
Connecting AV Signal Cables	18
Connecting TV + DVD Receiver: Connecting AV Signal Cables	19
Connecting TV + DVD Combo + DVD Receiver:	
Connecting AV Signal Cables	20

Chapter 3: Operation

Turning the TV On and Off	21
Changing Channels	21
Using the Channel Buttons	21
Using the Pre-CH Button to select the Previous Channel	21
Adjusting the Volume	21
Using Mute	21
Viewing the Display	22
Viewing the Menus	22
Setting Up Your Remote Control	23
Remote Control Codes	26

Chapter 4: Special Features

Plug & Play Feature	27
Memorizing the Channels	28
Selecting the Video Signal-source	28
Storing Channels in Memory (Automatic Method)	29
Adding and Erasing Channels (Manual Method)	30
Labeling Channels	30
To set-up your Favorite Channels	31
To Select Source	31
To Edit the Input Source Name	32

Using Automatic Picture Settings	33
Customizing the Picture	34
Using Automatic Sound Settings	35
Customizing the Sound	36
Selecting a Menu Language	37
Setting the Blue Screen Mode	38
Fine Tuning Channels	39
LNA (Low Noise Amplifier)	40
Viewing Picture-in-Picture	41
Activating Picture-in-Picture	41
Selecting a Signal Source (External A/V) for PIP	42
Swapping the Contents of the PIP and Main image	42
Changing the PIP Channel	42
Changing the Location of the PIP Window	42
Changing the Size of the PIP Window	42
DNIe(Digital Natural Image engine)	43
MCC (My Color Control)	44
Easy Control	44
Detail Control	45
I2C (Intelligent Image Control)	46
IBC (Intelligent Brightness Control)	47
Changing the Screen Size.	48
Freezing the Picture	48
Adjusting the Color Tone	49
Setting the TruSurround XT(SRS TSXT)	50
Automatic Volume Control	51
Special Sound Options	52
Adjusting the Headphone Sound	53
Selecting the Main or Sub Sound	54
Sub Woofer	55
Setting the Clock	56
Setting the On/Off Timer	57
Setting the Sleep Timer	59
Viewing Closed Captions	60
Using the V-Chip	62
Color Weakness	68
Selecting the Melody	69

Chapter 5: PC Display

Using Your TV as a Computer (PC) Display	70
How to Set up Your PC Software (Windows only)	70
How to Auto Adjust	71
Adjusting the Screen Quality	72
Changing the Screen Position	73
To Initialize the Screen Position or Color Settings	74

Chapter 6: Troubleshooting

Identifying Problems	75
----------------------------	----

Appendix

Installing the Stand	82
Wall Mount Installation Guide	83
Cleaning and Maintaining Your TV	85
Using Your TV in Another Country	85
Specifications	86
Display Modes	87

Chapter One

YOUR NEW TV

List of Features

- **MCC (My Color Control):**
Users can adjust colors to their preference by adjusting skin, sky and grass tones.
- **I2C (Intelligent Image Control):**
Automatically detects the input visual signal and adjusts to create optimum contrast.
- **IBC (Intelligent Brightness Control):**
Adjusts the screen brightness automatically depending on the brightness of the surrounding environment.
- **Color Weakness :**
This feature enables those with a color weakness to view images as those with normal vision.
- **JBL high performance built-in speakers:**
Enables reproduction of broadband frequency sound.

List of Parts

Please make sure the following items are included with your LCD TV.
If any items are missing, contact your dealer.

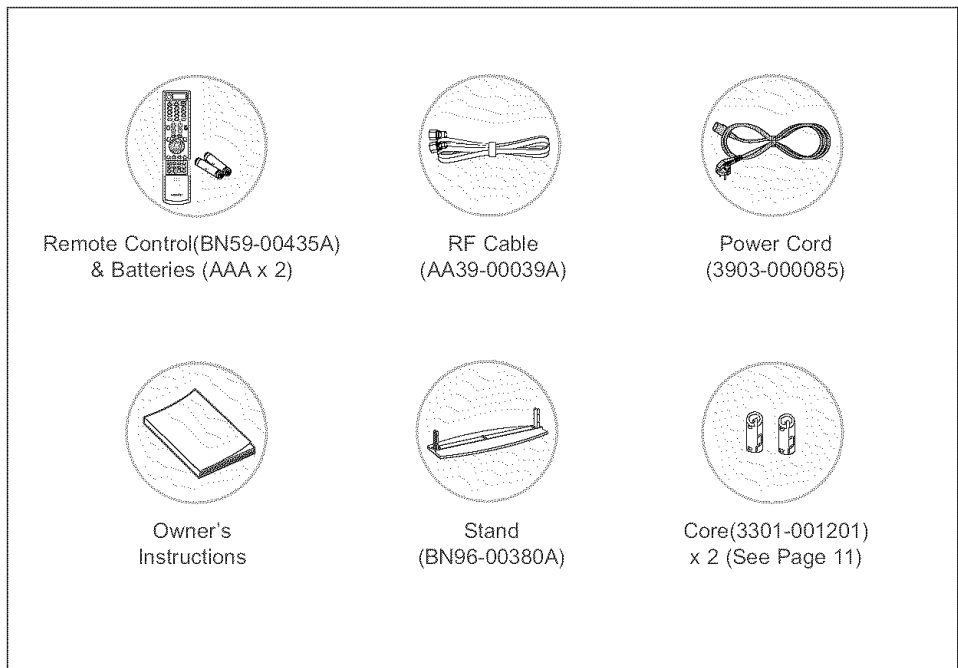



Familiarizing Yourself with Your New TV

Right-Side Panel Buttons

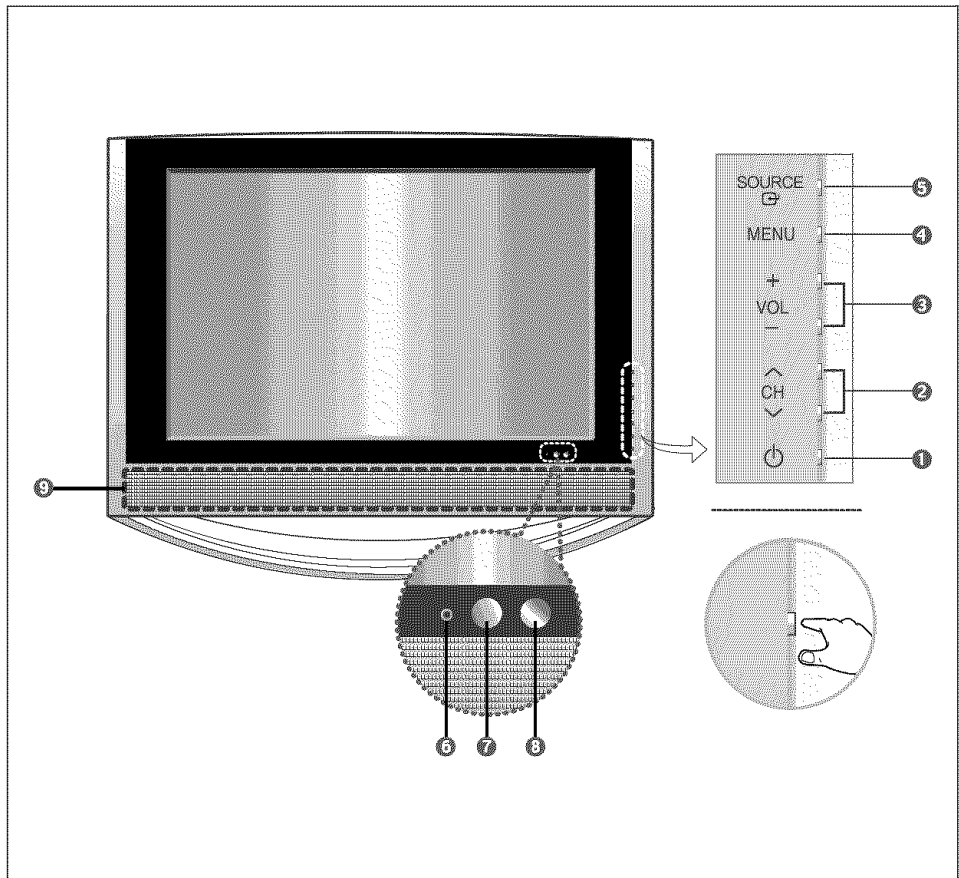
The buttons on the Right-side panel control your TV's basic features, including the on-screen menu. To use the more advanced features, you must use the remote control.



- 1**  **POWER**
Press to turn the TV on and off.
- 2**  **CH**
Press to change channels.
Also press to highlight various items on the on-screen menu.
- 3** **+ VOL -**
Press to increase or decrease the volume.
Also used to select items on the on-screen menu.
- 4** **MENU**
Press to see an on-screen menu of your TV's features.
- 5** **SOURCE** 
Displays a menu of all of the available input sources (TV, AV, S-VIDEO, Component 1, Component 2, HDMI, DVI, PC).
- 6** **POWER INDICATOR**
Lights when unit is in standby mode.
Lights green after setting on/off timer.
- 7** **REMOTE CONTROL SENSOR**
Aim the remote control towards this spot on the TV.
- 8** **LIGHT DETECTING SENSOR**
Adjusts brightness of screen automatically by detecting brightness of surrounding environment. This sensor works when IBC is on.
- 9** **SPEAKER**

Rear Panel Jacks

Use the rear panel jacks to connect an A/V component that will be connected continuously, such as a VCR or a DVD player.

For more information on connecting equipment, see pages 7-14.

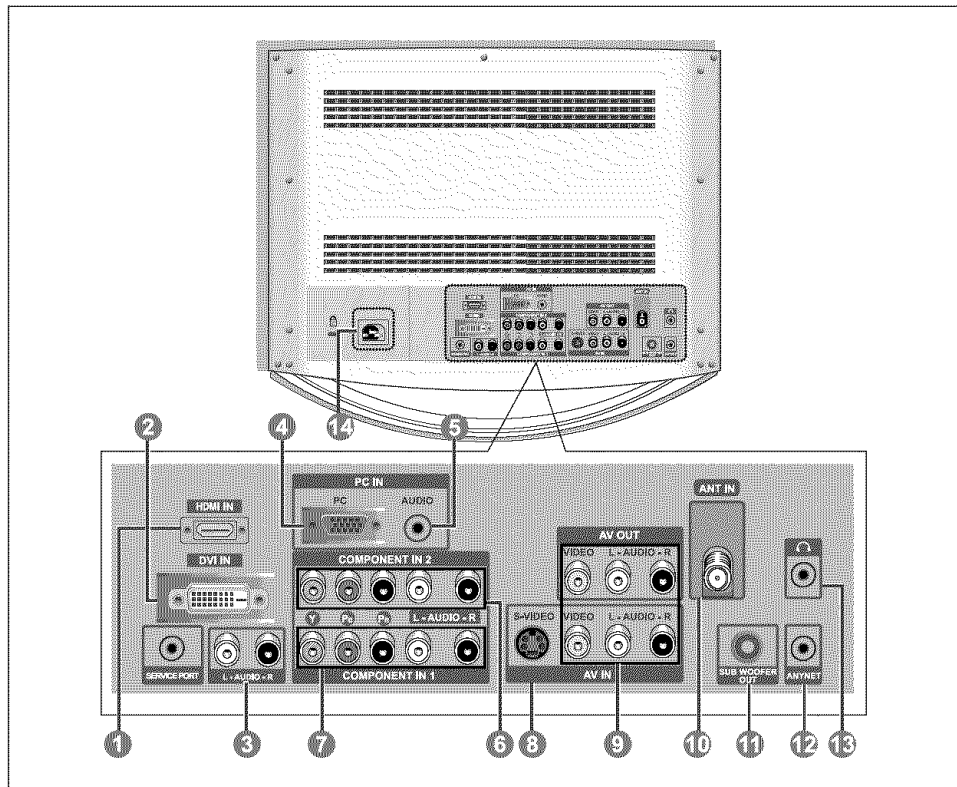

- | | |
|--|--|
| <p>1 HDMI IN
Supports connections between HDMI-connection-enabled AV devices (set top boxes, DVD players, AV receivers and digital TVs).</p> <p>2 DVI-D INPUT
Connect to the digital video output jack on your DVD/Set-top Box.
(DVI-D terminal does not support PC.)</p> <p>3 DVI-D AUDIO INPUT
Connect to the audio output jack on your DVD/Set-top Box.</p> <p>4 PC VIDEO (D-SUB) INPUT
Connect to the video output port on your PC.</p> <p>5 PC AUDIO (D-SUB) INPUT
Connect to the audio output jack on your PC.</p> <p>6 COMPONENT IN 2
Connect component video/audio from a DVD/VCR/Set-top Box.</p> | <p>7 COMPONENT IN 1
Connect component video/audio from a DVD/VCR/Set-top Box.</p> <p>8 S-VIDEO
Connect a Video signal from a camcorder or VCR.</p> <p>9 AV INPUT/OUTPUT
Connect a Video signal from a camcorder or VCR.</p> <p>10 ANT IN
Connect to an antenna or to a cable TV system.</p> <p>11 SUBWOOFER OUTPUT
Connect to an active (powered) subwoofer.</p> <p>12 ANYNET</p> <p>13 HEADPHONE JACK
Connect a set of external headphones for private listening.</p> <p>14 POWER INPUT</p> |
|--|--|

Remote Control

1 POWER

Turns the TV on and off.
(See Page 21)

2 P.SIZE

Press to change the screen size.
(See Page 48)

3 P.MODE

Adjusts the TV picture by selecting one of the preset factory settings.
(See Page 33)

4 MUTE

Press to temporarily cut off the sound. (See Page 21)

5 MENU

Displays the main on-screen menu.(See Page 22)

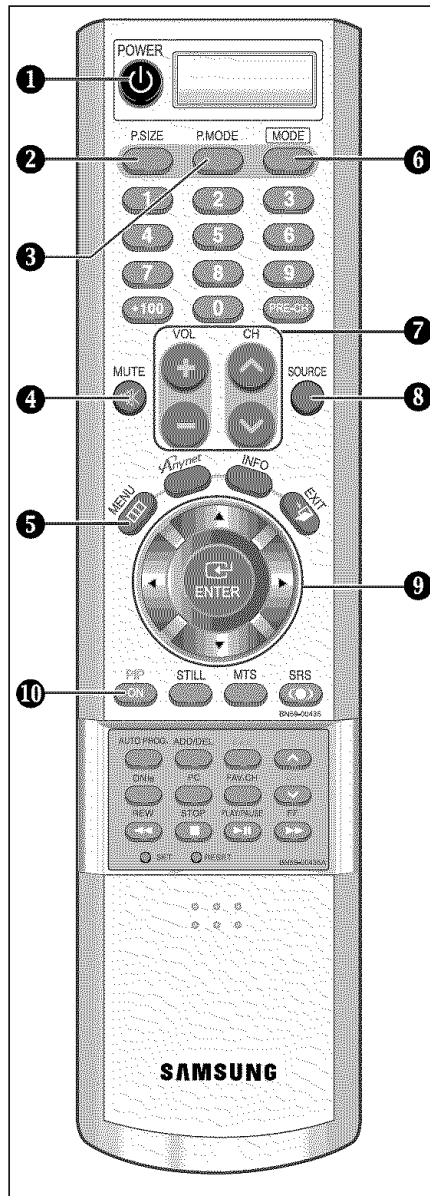

6 MODE

Selects a target device to be controlled by the Samsung remote control (TV, VCR, Cable, DVD, Samsung STB)
(See pages 23~26)

7 CH ^ and CH v (Channel UP/Down)

Press CH ^ or CH v to change channels. (See Page 21)

VOL + and VOL -

Press to increase or decrease the volume. (See Page 21)

8 SOURCE

Press to display all of the available video sources. (See Page 31)

9 UP / DOWN / LEFT / RIGHT / ENTER

Use to select on-screen menu items and change menu values. (The remote control will only function with VCR or DVD units that are compatible with the LCD TV.)

10 PIP FUNCTIONS

Picture-in-Picture ON/OFF
(See pages 41~42)

YOUR NEW TV

11 +100

Press to select channels over 100. For example, to select channel 121, press "+100", then press "2" and "1". (See Page 29)

12 Anynet

Press the Anynet button to bring up the Anynet menu. (See Page 16)

15 STILL

Press to stop the action during a particular scene. Press again to resume normal video. (See Page 48)

MTS

(Multi channel Television Stereo)

Press to choose stereo, mono or Separate Audio Program (SAP broadcast). (See Page 52)

SRS

(See Page 50)

14 AUTO PROG.

Press to automatically store selected TV/cable channels. (See Page 29)

ADD/DEL

Use to store and delete channels to/from memory. (See Page 30)

DNLe

Press to improve the digital video quality. (See Page 43)

PC MODE

Press to switch to the PC mode. (See pages 70~74)

FAV.CH

Tunes to the channels in your favorite channel list. (See Page 31)

15 VCR/DVD Functions

- Rewind
- Stop
- Play/Pause
- Fast/Forward

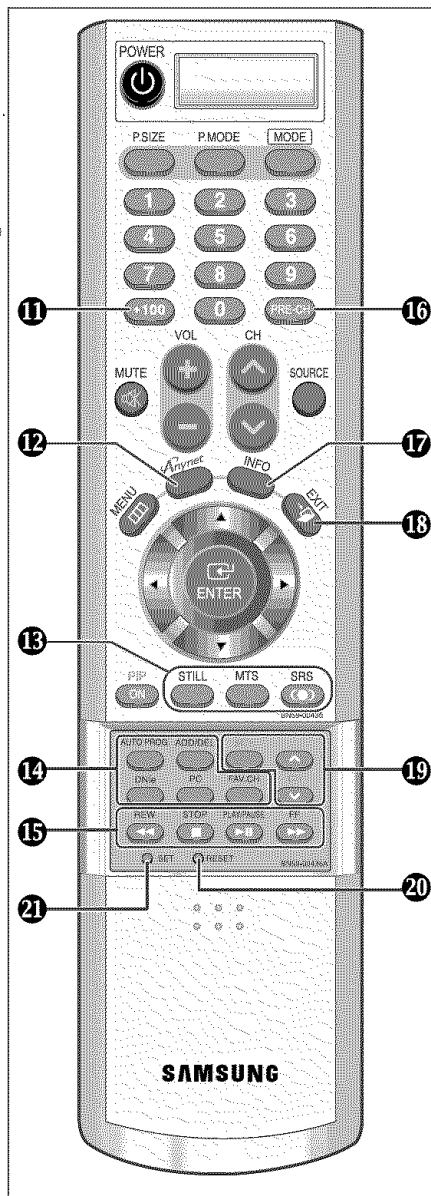

16 PRE-CH

Tunes to the previous channel. (See page 21)

17 INFO

Use to see information on the current broadcast. (See Page 22)

18 EXIT

Press to exit the menu.

19 SIZE

Press to make the PIP window double, large or small. (See Page 42)

^ CH v

Displays the available channels in sequence. (These buttons change channels in the PIP window only.) (See Page 42)

20 RESET

When your remote does not work, change the batteries and press the RESET button for 2-3 seconds before use.

21 SET BUTTON

SET button on TV remote control adjusts 5 separate devices - TV, VCR, Cable, DVD, or Samsung Set-top box. (See pages 23~26)

Installing Batteries in the Remote Control

- 1**
Slide the cover out completely.

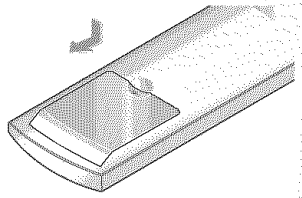

- 2**
Install two AAA size batteries.

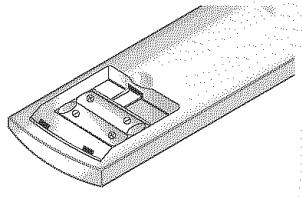

- 3**
Replace the cover.

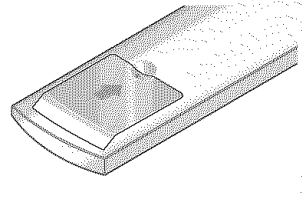

◀ Make sure to match the “+” and “-” ends of the batteries with the diagram inside the compartment.

◀ Remove the batteries and store them in a cool, dry place if you won't be using the remote control for a long time.

The remote control can be used up to about 23 feet from the TV.

(Assuming typical TV usage, the batteries last for about one year.)

If remote control doesn't work

Check the following:

1. Is the TV power switch on?
2. Are the plus and minus ends of the batteries reversed?
3. Are the batteries drained?
4. Is there a power outage, or is the power cord unplugged?
5. Is there a special fluorescent light or a neon sign nearby?

Chapter Two

INSTALLATION

Connecting VHF and UHF Antennas

If your antenna has a set of leads that look like this, see “Antennas with 300-ohm Flat Twin Leads” below.

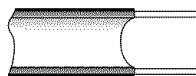

If your antenna has one lead that looks like this, see “Antennas with 75-ohm Round Leads” on page 8.



If you have two antennas, see “Separate VHF and UHF Antennas” on page 8.

Antennas with 300-ohm Flat Twin Leads

If you are using an off-air antenna (such as a roof antenna or “rabbit ears”) that has 300-ohm twin flat leads, follow the directions below.

1

Place the wires from the twin leads under the screws on a 300-75 ohm adaptor (not supplied). Use a screwdriver to tighten the screws.

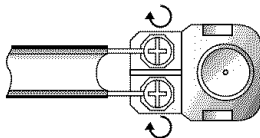

2

Plug the adaptor into the ANT IN terminal on the bottom of the back panel.

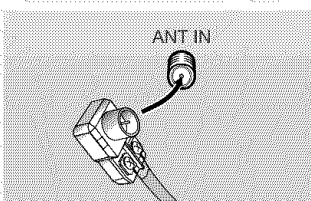

INSTALLATION

Antennas with 75-ohm Round Leads

1

Plug the antenna lead into the ANT IN terminal on the bottom of the back panel.

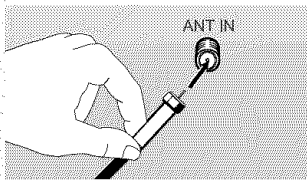

Separate VHF and UHF Antennas

If you have two separate antennas for your TV (one VHF and one UHF), you must combine the two antenna signals before connecting the antennas to the TV. This procedure requires an optional combiner-adaptor (available at most electronics shops).

1

Connect both antenna leads to the combiner.

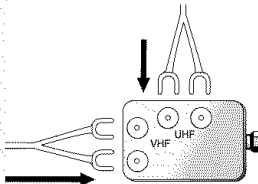

2

Plug the combiner into the ANT IN terminal on the bottom of the rear panel.

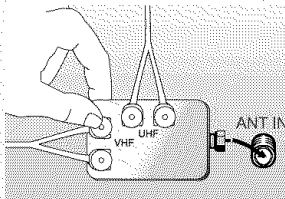

Connecting Cable TV

To connect to a cable TV system, follow the instructions below.

Cable without a Cable Box

1

Plug the incoming cable into the ANT IN terminal on back of the TV.

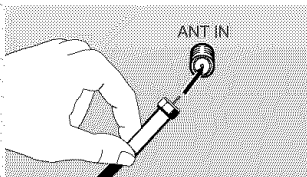

◀ Because this TV is cable-ready, you do not need a cable box to view unscrambled cable channels.

INSTALLATION

Connecting to a Cable Box that Descrambles All Channels

- 1**
Find the cable that is connected to the ANT OUT terminal on your cable box.

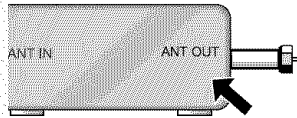

◀ This terminal might be labeled "ANT OUT", "VHF OUT", or simply, "OUT".

- 2**
Connect the other end of this cable to the ANT IN terminal on the back of the TV.

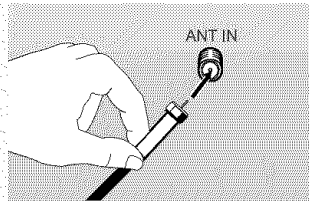

Connecting to a Cable Box that Descrambles Some Channels

If your cable box descrambles only some channels (such as premium channels), follow the instructions below. You will need a two-way splitter, an RF (A/B) switch, and four lengths of coaxial cable. (These items are available at most electronics stores.)

- 1**
Find and disconnect the cable that is connected to the ANTENNA IN terminal on your cable box.

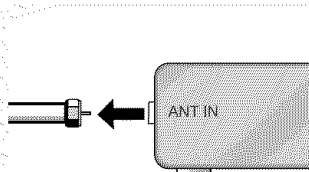

◀ This terminal might be labeled "ANT IN", "VHF IN", or simply, "IN".

- 2**
Connect this cable to a two-way splitter.

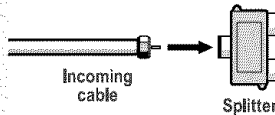

- 3**
Connect a coaxial cable between an OUTPUT terminal on the splitter and the IN terminal on the cable box.

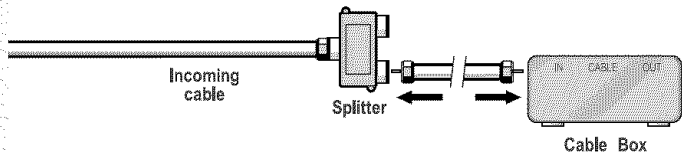

INSTALLATION

4

Connect a coaxial cable between the ANT OUT terminal on the cable box and the B-IN terminal on the A/B switch.

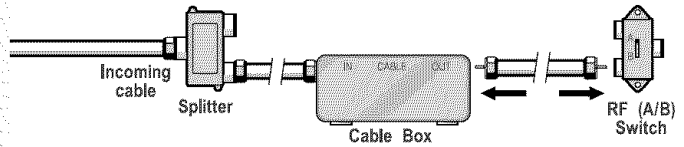

5

Connect another cable between the other OUT terminal on the splitter and the A-IN terminal on the RF (A/B) switch.

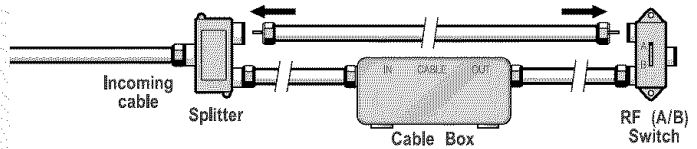

6

Connect the last coaxial cable between the OUT terminal on the RF (A/B) switch and the VHF/UHF terminal on the rear of the TV.

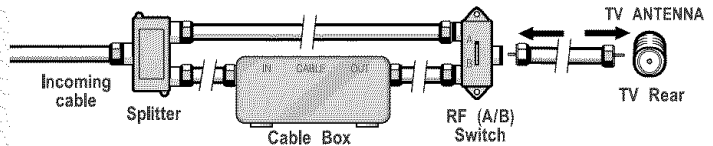

After you've made this connection, set the A/B switch to the "A" position for normal viewing. Set the A/B switch to the "B" position to view scrambled channels. (When you set the A/B switch to "B," you will need to tune your TV to the cable box's output channel, which is usually channel 3 or 4.)

Connecting HDMI

Supports connections between HDMI-connection-enabled AV devices (Set Top boxes, DVD players, AV receivers and digital TVs).

1

Connect HDMI cable from the TV to the input terminal of the HDMI device.

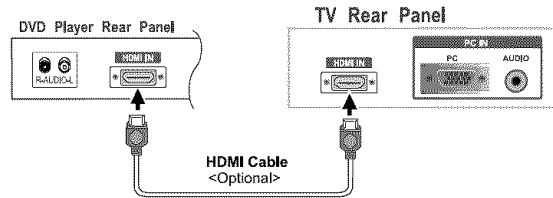

What is HDMI?

- **HDMI**, or high-definition multimedia interface, is a next-generation interface that enables the transmission of digital audio and video signals using a single cable without compression.
- **HDMI allows multiple** channels of digital audio (5.1 channels). The difference between **HDMI** and **DVI** is that the **HDMI** device is smaller in size, has the **HDCP (High Definition Content Protection)** coding feature installed, and supports multi - channel digital audio.

How to connect Core

Core provided reduces EMI(Electromagnetic Interference) noises from electrical or electronic products and prevents magnetic impact from ambient environment. After connecting AV cable of TV or Component cable, install Core as shown in the picture.

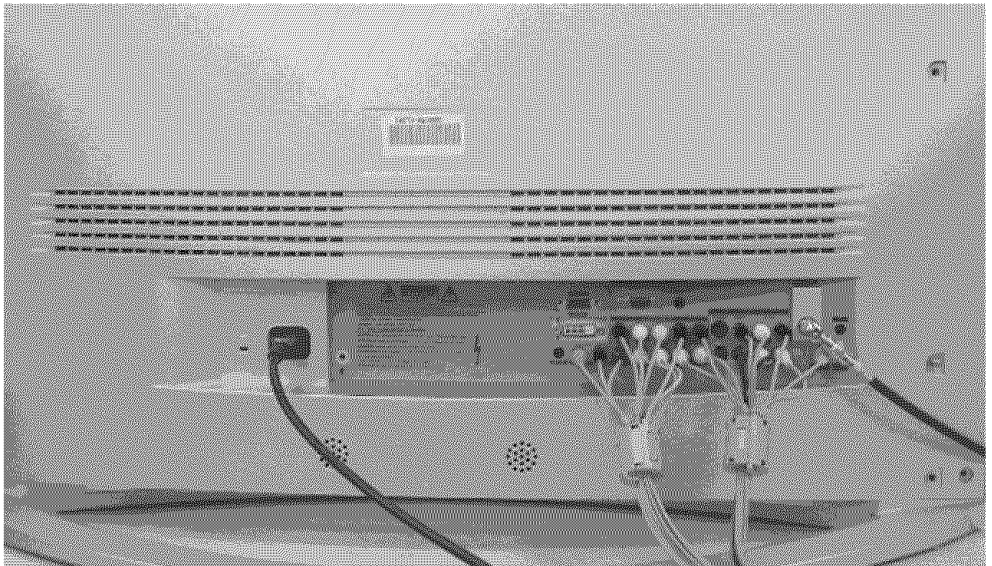

Connecting a VCR

These instructions assume that you have already connected your TV to an antenna or a cable TV system (according to the instructions on pages 7-10).

Skip step 1 if you have not yet connected to an antenna or a cable system.

- 1**
Unplug the cable or antenna from the back of the TV.

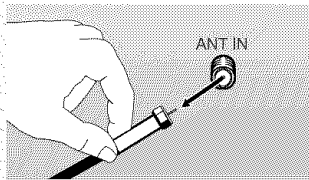

- 2**
Connect the cable or antenna to the ANT IN terminal on the back of the VCR.

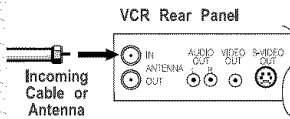

- 3**
Connect a coaxial cable between the ANT OUT terminal on the VCR and the antenna terminal on the TV.

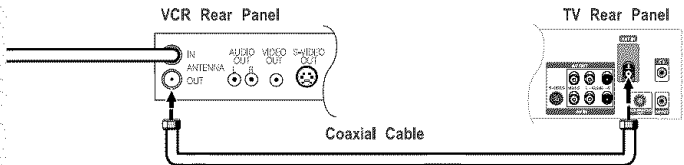

A coaxial cable is usually included with a VCR. (If not, check your local electronics store).

- 4**
Connect a set of audio cables between the AUDIO OUT jacks on the VCR and the AUDIO jacks on the TV.

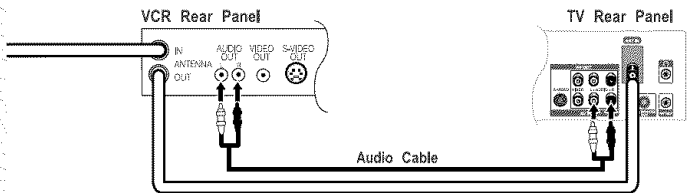

If you have a “mono” (non-stereo) VCR, use the Y-connector (not supplied) to hook up to the left and right audio input jacks of the TV. If your VCR is stereo, you must connect two cables.

- 5**
Connect a video cable between the VIDEO OUT jack on the VCR and the VIDEO jack on the TV.

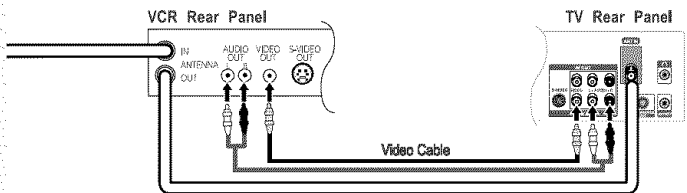

Follow the instructions in “Viewing a VCR or Camcorder Tape” to view your VCR tape.

* Each external input source device has a different back panel configuration.

Connecting an S-VHS VCR

Your Samsung TV can be connected to an S-Video signal from an S-VHS VCR. (This connection delivers a better picture as compared to a standard VHS VCR.)

1

To begin, follow steps 1–3 in the previous section to connect the antenna or cable to your VCR and your TV.

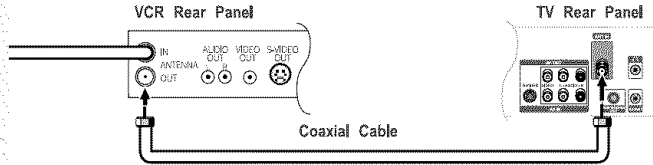

2

Connect a set of audio cables between the AUDIO OUT jacks on the VCR and the AUDIO INPUT jacks on the TV.

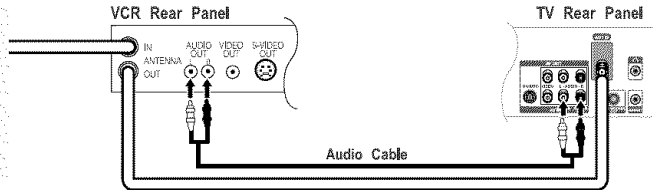

3

Connect an S-video cable between the S-VIDEO OUT jack on the VCR and the S-VIDEO INPUT jack on the TV.

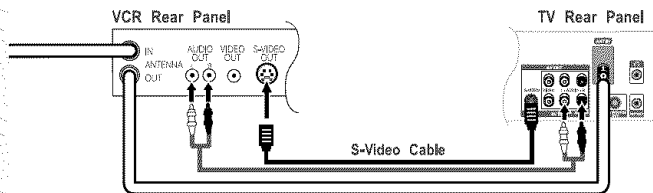

An S-video cable is usually included with an S-VHS VCR. (If not, check your local electronics store.)

* Each external input source device has a different back panel configuration.

Connecting a DVI-D Cable

1

Connect a DVI-D cable between the DVI-I INPUT connector on the TV and the DVI connector on the DVD player/ Set-Top BOX.

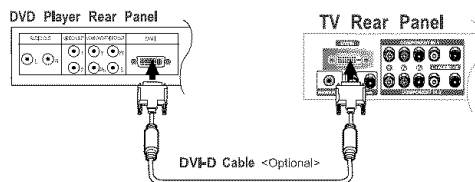

2

Connect a set of audio cables between the L-AUDIO-R jack on the TV and the AUDIO OUTPUT jacks on the DVD player/ Set-Top BOX.

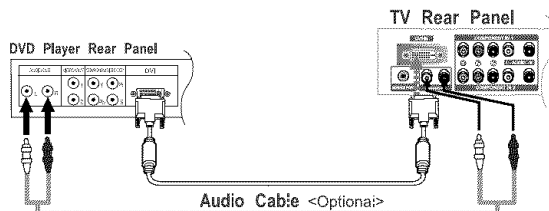

Note: If you are using a DVI-D cable to connect

1. Be sure to connect the audio cable (sold separately) as shown above to get normal TV sound.
2. See Appendix "Display Modes" for supported resolutions.
3. The screen may have shifted to the right or to the left after connecting the cable. The screen must be adjusted on the source (Set-top box).
4. Each external input source device has a different back panel configuration.

Connecting a DVD Player

The rear panel jacks on your TV make it easy to connect a DVD player to your TV.

1

Connect a set of audio cables between the COMPONENT1 or COMPONENT2 L, R AUDIO INPUT jacks on the TV and the AUDIO OUT jacks on the DVD player.



2

Connect a video cable between the COMPONENT1 or COMPONENT2 (Y, P_B, P_R) jacks on the TV and the Y, P_B, P_R jacks on the DVD player.

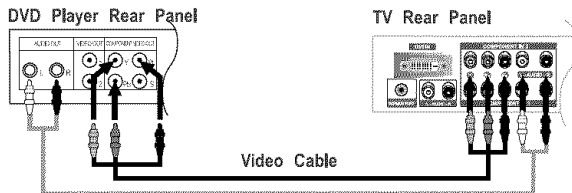

Note: For an explanation of Component video, see your DVD player owner's manual.

* Each external input source device has a different back panel configuration.

Connecting a Digital TV Set-Top Box

The connections for a typical set-top box are shown below.

1

Connect a set of audio cables between the L, R COMPONENT1 or COMPONENT2 AUDIO INPUT jacks on the TV and the AUDIO OUT jacks on the Set-Top Box.

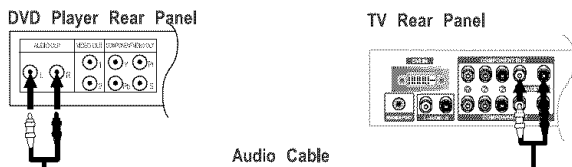

2

Connect a video cable between the COMPONENT1 or COMPONENT2 (Y, P_B, P_R) jacks on the TV and the Y, P_B, P_R jacks on the Set-Top Box.

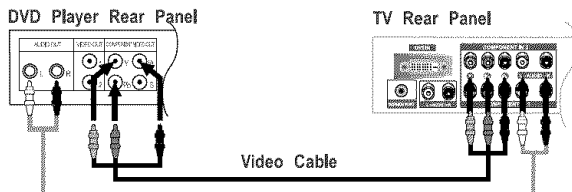

Note: For an explanation of Component video, see your Set-Top Box owner's manual.

* Each external input source device has a different back panel configuration.

Connecting a PC

Note: This figure shows the Standard Connector-jack panel.
The actual configuration on your TV may be different.

- Connect the D- Sub cable to “**PC (PC IN)**” on the rear of your set.
- Connect the stereo audio cable to “**AUDIO (PC IN)**” on the rear of your set and the other end to “Audio Out” of the sound card on your computer.

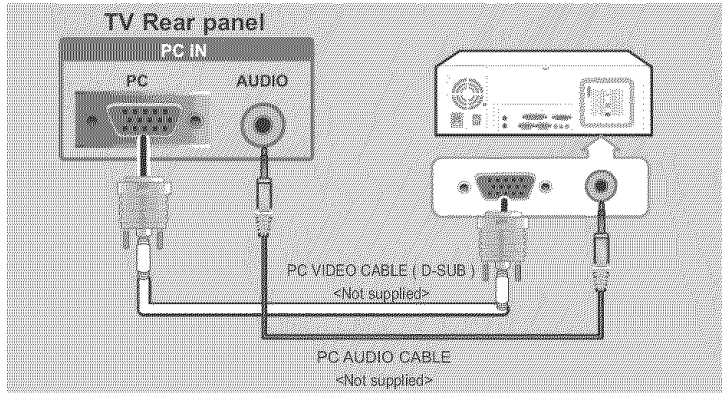

Anynet

Please refer to ‘Anynet AV Owner’s Instructions’ that is provided separately for the detailed information on Anynet.

1.What is the Anynet?

Anynet is an AV network system that enables you to easily control Samsung audio-video (AV) devices from your through the Anynet menu via a Samsung TV.

[Anynet Features and Benefits]

- Anynet allows you to access most features of any device connected to your TV set from a single remote control.

With Anynet, there is no need to use different remote controls for different devices. Moreover, there is no need to press separate buttons to switch devices.

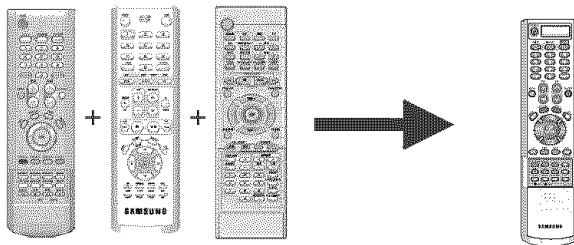

- Just choose a function from the Anynet menu and the rest of the process required is performed automatically via the network linking the devices. It frees you from the inconvenience of pressing separate buttons on separate devices several times to perform a task.
 - Ex} To play a DVD: Regular (Three remote controls; nine button presses)
 - Through Anynet (One remote control; three button presses)
- The Anynet network allows the devices connected to exchange control commands with one another and check the operating status. As a result, you can use your TV remote control to control your DVD player when you Play DVDs and to control the STB when you watch the STB (set-top box) programs.
- You can switch easily and conveniently between listening to the program you are currently watching through your TV speakers or through Home Theater with 5.1 channel speakers.

[Anynet is most convenient when]

- You watch content from external input source device such as DVDs, STB programs or the VCR.
- You need to change channels, adjust the volume or skip scenes while you are watching content from an external input source device.
- You want to switch between the TV speakers and the 5.1 channel speakers while you are watching a program

2. Anynet

1. Anynet System is available only for Samsung Anynet-supported AV devices.
2. See below for Anynet-supported devices.
(All devices except for 2 and 4 are soon to be added)

① DVD Player
② DVD/VCR Combo
③ DVD Recorder
④ DVD Receiver or Home Theater
⑤ DVD Recorder Combo
⑥ DVD Recorder Combo Receiver
⑦ AV Receiver
⑧ Satellite Set-Top Box
⑨ Cable Set-Top Box
⑩ HDTV Set-Top Box

 The Anynet does not support set-top box models T165 and K165.

3. All video cables are connected to the TV set.
4. Anynet System does not support more than one of the same type of devices.
5. One Anynet System menu can support up to two devices besides the TV.
6. Anynet System can support only one Home theater.
7. "Standard Connection" means a connection configuration in which no digital optical/coaxial cables are connected.
8. "Advanced Connection" means a connection configuration in which digital optical/coaxial cables are connected.
9. Anynet begins to operate when the Anynet-supported AV devices are plugged in and enter Standby mode.

3. Connecting TV + DVD/VCR Combo: Connecting AV Signal Cables

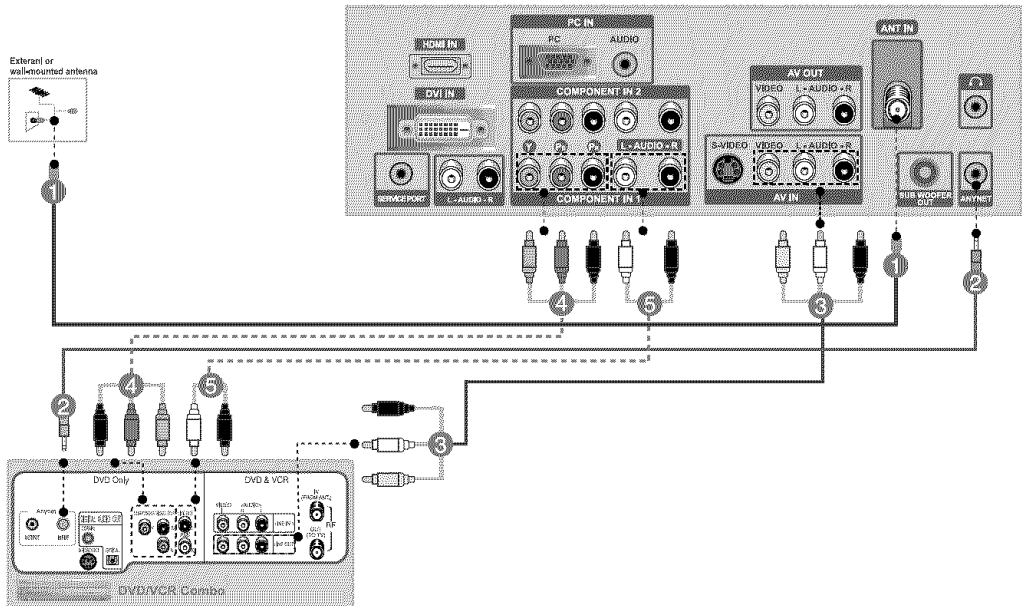

How to Connect the Cables (Connect in the order of numbers shown in the diagram.)

1. Antenna Cable: Connect the external antenna cable to the ANT IN port on the TV.
2. Anynet Connector: To use the Anynet, connect the Anynet port on the TV and the Anynet Input port on the DVD Combo using the Stereo-Stereo Anynet connector.
3. AV Connector: If you do not have a Component cable, connect the A/V output jacks on the DVD/VCR Combo to the AV IN jacks on the TV.
4. Component Cable (Sold Separately): If you have the component connector cable, connect Component Video Out jacks (DVD only) on the DVD/VCR Combo to the Component 1 Video Input jacks on the TV.
5. Audio Cable: After you complete step 4, connect the Component Audio Output jacks (DVD only) on the DVD/VCR Combo and the Component Input 1 L-Audio-R jacks on the TV.

4. Connecting TV + DVD Receiver: Connecting AV Signal Cables

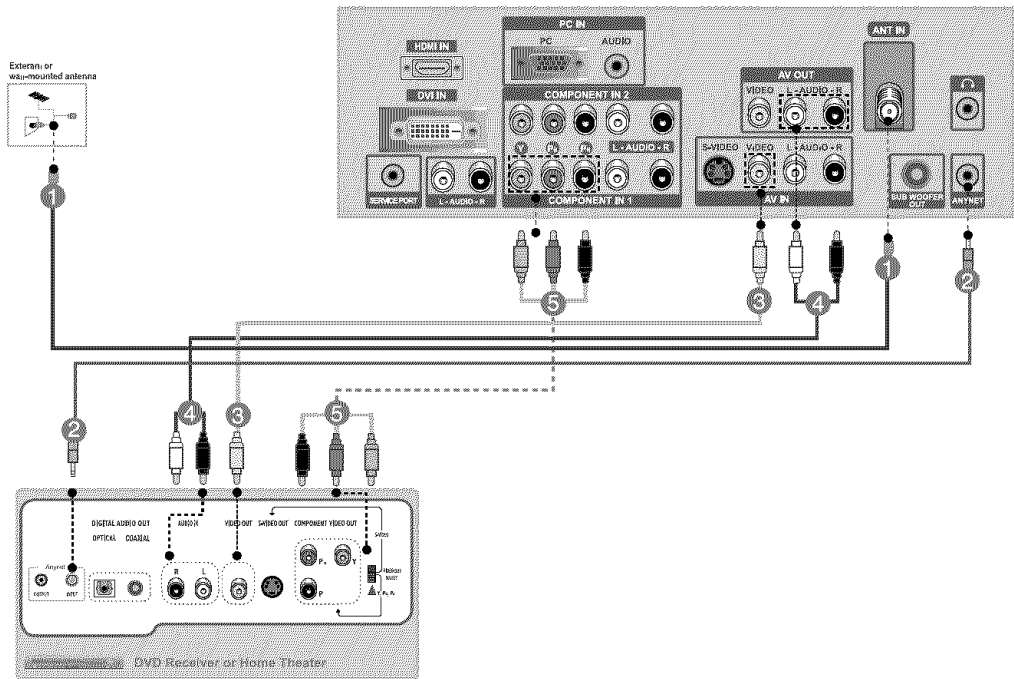

How to Connect the Cables (Connect in the order of numbers shown in the diagram.)

1. Antenna Cable: Connect the external antenna cable to the ANT Input port of the TV.
2. Anynet Connectors: To use the Anynet, connect the Anynet port on the TV and the Anynet Input port on the DVD Receiver using the Stereo-Stereo Anynet connector.
3. Video Connector: If you do not have the component connector, connect the Video Output port on the DVD Receiver and the AV IN port on the TV.
4. Audio Connector: Connect the Left-Audio-Right port of Monitor Output on the TV and the Audio Input port on the DVD Receiver.
5. Component Connector (Sold Separately): If you have the component connector, connect the Color Difference Component Output port on the DVD Receiver and the Component Input 1 YpbPr port on the TV.

5. Connecting TV + DVD Combo + DVD Receiver: Connecting AV Signal Cables

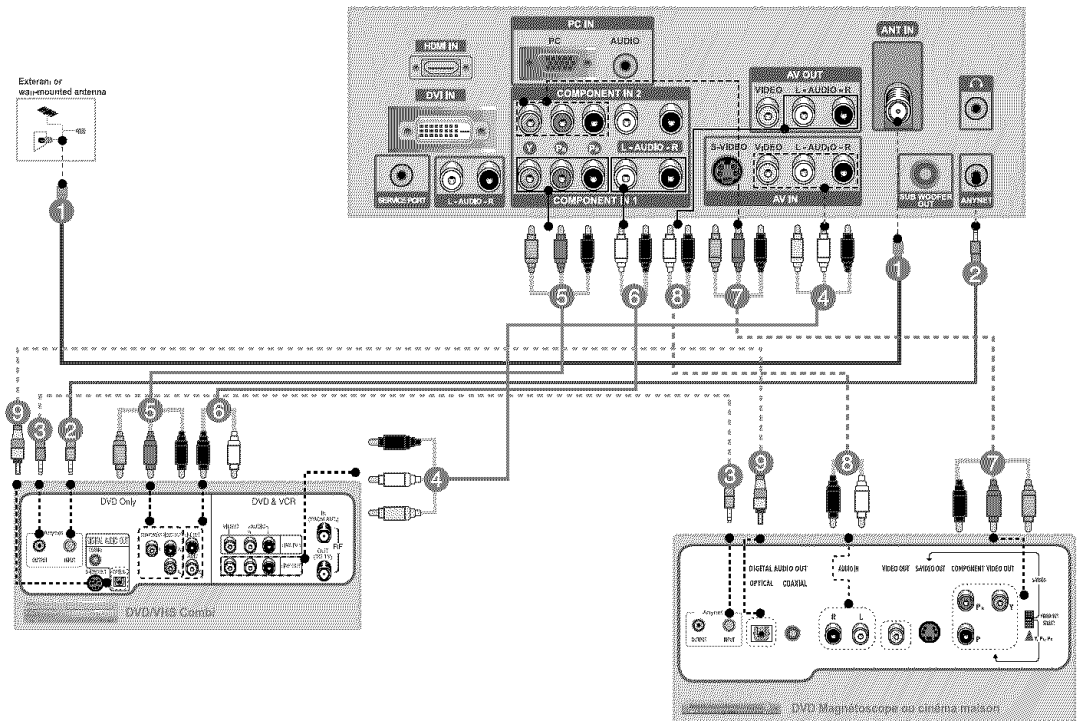

How to Connect the Cables (Connect in the order of numbers shown in the diagram.)

1. Antenna Cable: Connect the external antenna cable to the ANT IN port of the TV.
2. Anynet Connectors: To use Anynet, connect the Anynet port on the TV and the Anynet Input port on the DVD/VCR Combo using the Stereo-Stereo Anynet connector.
3. Anynet Connectors: To use Anynet, connect the Anynet Output port on the DVD/VCR Combo and the Anynet Input port on the DVD Receiver using the Stereo-Stereo Anynet connector.
4. AV Cable: If you do not have the component connector, connect the Output port of the AV output jacks on the DVD/VCR Combo to the AV IN jacks on the TV.
5. Component Connector (Sold Separately): If you have the component connector, Connect the Component Video Output jacks (DVD only) on the DVD/VCR Combo and the Component Input 1 "Y, P_B, P_R" jacks on the TV.
6. Audio Cable: Connect the L-Audio-R COMPONENT Audio In 1 jacks on the TV to the Analog Audio Output jacks on the DVD/VCR Combo.
7. Component Cable (Sold Separately): Connect Component Video Out jacks on the DVD Receiver to the COMPONENT Input 2 "Y, P_B, P_R" jacks on the TV.
8. Audio Cable: Connect the Left-Audio-Right port of Audio Output on the TV and the Audio Input port on the DVD Receiver.
9. Optical Cable (Sold Separately): If you have an optical cable, connect the Digital Audio Output Optical port on the DVD/VCR Combo to the Digital Input port on the DVD Receiver.
10. To enjoy 5.1-channel sound, go to "Set up" in the Anynet menu and select "Customized Setup".

Chapter Three

OPERATION

Turning the TV On and Off

Press the **POWER** button.

You can also use the Power button on the front panel.

Changing Channels

Using the Channel Buttons

1

Press the **CH** \wedge / \vee buttons to change channels.

When you press the **CH** \wedge / \vee buttons, the TV changes channels in sequence. You will see all the channels that the TV has memorized. (The TV must have memorized at least three channels). You will not see channels that were either erased or not memorized.

Using the PRE-CH Button to select the Previous Channel

1

Press the **PRE-CH** button.
The TV will switch to the last channel viewed.

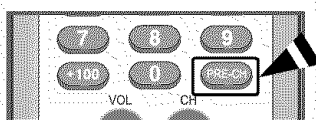

To quickly switch between two channels that are far apart, tune to one channel, then use the number button to select the second channel. Then use the **PRE-CH** button to quickly alternate between them.

Adjusting the Volume

1

Press the **VOL +/-** buttons to increase or decrease the volume.

Using Mute

At any time, you can temporarily cut off the sound using the Mute button.

1

Press **MUTE** and the sound cuts off.

The word "Mute" will appear in the lower-left corner of the screen.

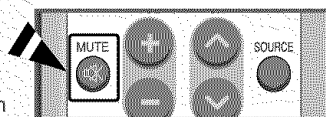

2

To turn mute off, press the **MUTE** button again, or simply press the **VOL +/-** buttons.

Viewing the Display

The display identifies the current channel and the status of certain audio-video settings.

1

Press the **INFO** button on the remote control.

The TV will display the channel, the type of sound, and the status of certain picture and sound settings.

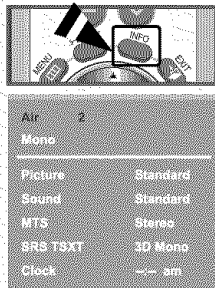

- ◀ The on-screen displays disappear after about ten seconds.
- ◀ Press the INFO button once more or wait approximately 10 seconds and it disappears automatically.
- ◀ Allows the user to adjust the settings according to his/her preference and shows the current settings.

Viewing the Menus

1

With the power on, press the **MENU** button.

The main menu appears on the screen. It's left

side has five icons: Input, Picture, Sound, Channel, Setup.

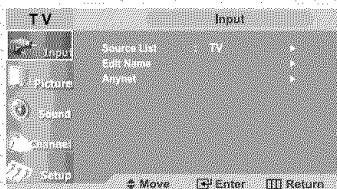

- ◀ The on-screen menus disappear from the screen after about two minutes.

2

Use the **UP/DOWN ▲▼** buttons to select one of the 5 icons. Then press **ENTER** to access the icon's sub-menu.

3

Press the **MENU** button to exit.

- ◀ You can also use the **MENU** (), CH Up/Down, Volume Up/Down and **SOURCE(ENTER)** buttons on the TV to make selections.

Setting Up Your Remote Control

After it has been set up properly, your remote control can operate in five different modes: TV, VCR, Cable, DVD or Samsung Set-top box. Pressing the corresponding button on the remote control allows you to switch between these modes, and control whichever piece of equipment you choose.

Note

The remote control might not be compatible with all DVD Players, VCRs and Cable boxes. This remote control is only compatible with Samsung Set-top boxes.

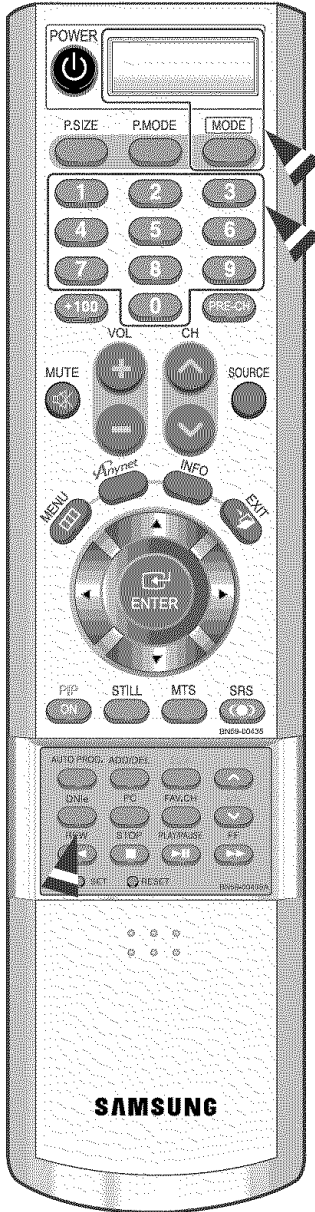

Setting Up the Remote to Operate Your VCR

- 1 Turn off your VCR.
- 2 Press the **MODE** button and make sure that the VCR LED is illuminated.
- 3 Press the **SET** button on your TV's remote control.
- 4 Using the number buttons on your remote control, enter three digits of the VCR code listed on page 26 of this manual for your brand of VCR. Make sure you enter three digits of the code, even if the first digit is a "0". (If more than one code is listed, try the first one.)
- 5 Press the Power button on the remote control. Your VCR should turn on if your remote is set up correctly.

If your VCR does not turn on after set up, repeat steps 2, 3, and 4, but try one of the other codes listed for your brand of VCR. If no other codes are listed, try each VCR code, 000 through 088.

Note on Using Remote Control Modes: VCR

When your remote control is in "VCR" mode, the volume buttons still control your TV's volume.

Setting Up the Remote to Operate Your Cable Box

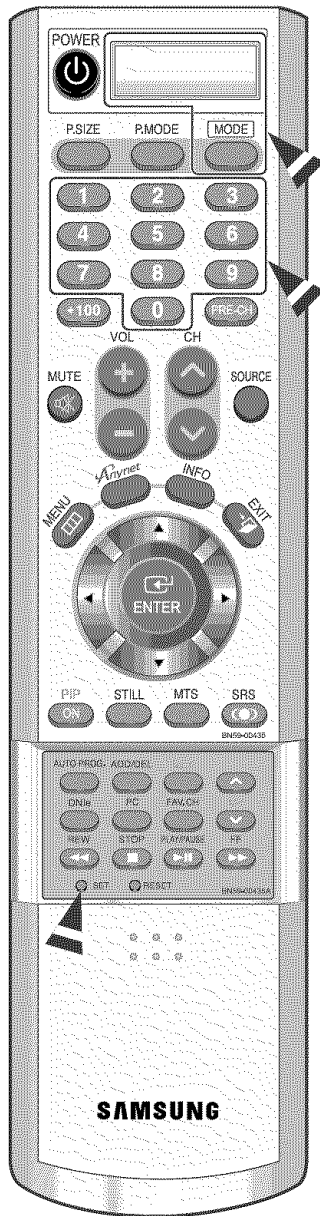

- 1 Turn off your cable box.
- 2 Press the **MODE** button and make sure that the Cable LED is illuminated.
- 3 Press the **SET** button on your TV's remote control.
- 4 Using the number buttons on your remote control, enter three digits of the cable box code listed on page 26 of this manual for your brand of cable box. Make sure you enter three digits of the code, even if the first digit is a "0."
If there is more than one code listed, try the first one.
- 5 Press the Power button on the remote control. Your cable box should turn on if your remote is set up correctly.

If your cable box does not turn on after set up, repeat steps 2, 3, and 4, but try one of the other codes listed for your brand of cable box. If no other codes are listed, try each code, 000 through 077.

Note on Using Remote Control Modes: Cable Box

When your remote control is in "Cable Box" mode, the volume buttons still control your TV's volume.

Setting Up the Remote to Operate Your DVD

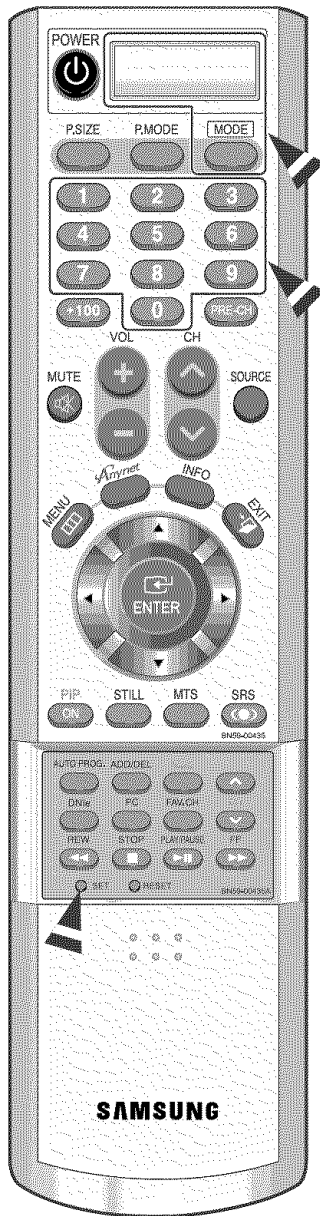

- 1 Turn off your DVD.
- 2 Press the **MODE** button and make sure that the DVD LED is illuminated.
- 3 Press the **SET** button on your TV's remote control.
- 4 Using the number buttons on your remote control, enter three digits of the DVD code listed on page 26 of this manual for your brand of DVD. Make sure you enter three digits of the code, even if the first digit is a "0."
If there is more than one code listed, try the first one.
- 5 Press the Power button on the remote control. Your DVD should turn on if your remote is set up correctly.

If your DVD does not turn on after set up, repeat steps 2, 3, and 4, but try one of the other codes listed for your brand of DVD. If no other codes are listed, try each code, 000 through 009.

Note on Using Remote Control Modes: DVD

When your remote control is in "DVD" mode, the volume buttons still control your TV's volume.

Remote Control Codes

VCR Codes

Admiral	015,088	kenwood	011,023,025,039,055	RCA	009,014,016,017,037,044,046,063,078
Aiwa	024	KLH	082	Samsung	000,016,022,031,041,051
Audio Dynamics	022,025	LG	001,002,007	Sansui	025
Akai	026,031,032	Lloyd	024	Sanyo	011,021
Bell&Howell	011	Logik	040	Scott	022,050,058,077
Broksonic	019	LXI	024	Sears	011,014,018,021,027,028,044,052,057
Candle	016,018,022,054,055,061	Magnavox	017,038,062,065	Sharp	015,036,048,054
Canon	017,062	Marantz	011,017,023,025,038,039,055,070	Shintom	026,035,040,064
Citizen	016,018,022,054,055,061	Marta		Signature	024
Colortyme	023	MEI		Sony	026,035,047
Craig	016,021	Memorex		Sylvania	017,024,038,062,065
Curtis-Mathes	009,016,017,023,024,055,062,073,076	MGA		Symphonic	024
Daewoo	003,004,005,006,007,008,022,054,085	Midland		Tandy	011,024
DB	025,023	Minota		Tashiko	
Dimensia	009	Mitsubishi		Tatung	039
Dynatech	024	Montgomery ward		Teac	024,039,078
Electrohome	036	MTC	016,024	Technics	
Emerson	017,018,019,022,024,029,032,036,043,050,051,056,058,066,071,074,076,077,079	Multitech	016,024,040,041	Temika	
		NEC	011,023,025,039,055,070,073	Teknika	018,030
Fisher	011,021,027,028,052,057,067	Optimus	015	TMK	076
Funai	024	Panasonic	017,062,084,086	Toshiba	014,022,028,057,058
GE		Pentax	014,044	Toshiko	018
Go Video	016	Pentex Reserch+	055	Totevision	016,018
Goldstar	018,023,055,069	Philco	017,038,062,065	Unitech	
General Electric	009,016,017,041,062	Philips	017,038	Vector Research	
Harman Kardon	023	Pioneer	014,025,042,059	Victor	
Hitach	014,024,044,045	Portland	053,054,061	Video Concepts	
Instant Replay	017	ProScan	009	Videosonic	
JC Penny	011,014,016,017,023,025,039,044,060,062	Quartz	011	Wards	
JCL	011,017,023,025,039,055	Quasar	017,053	Yamaha	
JVC		Radio Shack/Realistics	011,015,017,018,021,024,028,036,052,062	Zenith	

Cable Box Codes

Anvision	015,016	Macom	045,051	SAEWOO	007
Cable star	015,016	Magnavox	015,016,027,029,034,036,037,040,041,048,049	Signature	054
DeaRyung	003	Nawoo	001	Sprucer	035
DongKuk	004	NSC	017	Starcom	054
DaeHan	005	Oak	024,046	Stargate 2000	066
Eagle	015,016	Osk Sigma	024	Sylvania	019,067
Eastrm Int.		Panasonic	011,035,047,069	TaePyungYang	002
Eastern International	020	Philips	015,016,027,029,034,036,037,040,041,048,049	Texscan	019,067
General Instrument	054	Pioneer	026,028,052	Tocom	025,029,057,058,063
GI	012,013,023,031,032,033,038,044,075,076,077	Randtek	015,016	Unika	039,040,049
		RCA	008,035,074	Universal	059,060
Hamlin	011,012,020,021,042,056	Regal	011,020,021	Viewstar	015,016,027,029,034,036,037,040,041,048,049
Hitachi	045,051,054	Regency	010,041	Warner Amex	052
Jerrold	012,013,023,031,032,033,038,044,054,070,073	SA		Zenith	022,050,065,069
LG	006	Samsung	000,011,030,052,071,072		

DVD Codes

CurtisMathes	009	Toshiba	002
JVC	003	Panasonic	006
LG	001	Sony	004
Philips	007	Samsung	000
Proscan	008	Sharp	005
RCA	008		

Chapter Four

SPECIAL FEATURES

Plug & Play Feature

When the TV is initially powered On, two basic customer settings proceed automatically and subsequently: Setting Auto program, Clock.

1

Press the **POWER** button on the remote control.

The message "Plug & Play" is displayed.

A dark grey rectangular screen with the text "Plug & Play" centered in white.

2

Select the appropriate Language by pressing the **UP/DOWN ▲▼** buttons.

Press the **ENTER** button to confirm your choice.

The message "Antenna Input Check," is displayed with "OK" selected.

Press the **ENTER** button.

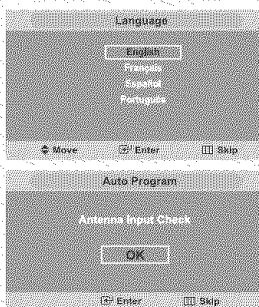

3

Press the **UP/DOWN ▲▼** buttons to select "Air", "STD", "HRC", or "IRC", then press the **ENTER** button.

Press the **ENTER** button to stop.

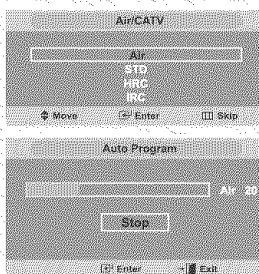

4

Press the **LEFT/RIGHT ◀▶** buttons to move to the "Hour", "Minute" or "am/pm".

Set the hour or minute by pressing the **UP/DOWN ▲▼** buttons. (Refer to "Setting the Clock" on page 56.)

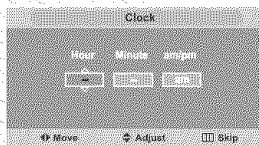

5

Press the **MENU** button to confirm your setting.

The message "Enjoy your watching." is displayed.

A dark grey rectangular screen with the text "Enjoy your watching" centered in white.

Memorizing the Channels

Your TV can memorize and store all of the available channels for both “off-air” (antenna) and cable channels. After the available channels are memorized, use the CH \wedge and CH \vee buttons to scan through the channels. This eliminates the need to change channels by entering the channel digits. There are three steps for memorizing channels: selecting a broadcast source, memorizing the channels (automatic) and adding and deleting channels (manual).

Selecting the Video Signal-source

Before your television can begin memorizing the available channels, you must specify the type of signal source that is connected to the TV (i.e., an antenna or a cable system).

1

Press the **MENU** button to display the menu.

Press the **UP/DOWN** $\blacktriangle/\blacktriangledown$ buttons to select “Channel”, then press the **ENTER** \square button.

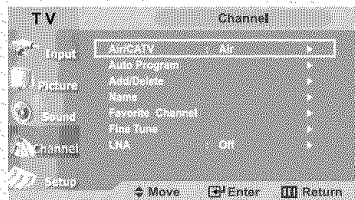

2

Press the **ENTER** \square button.

Repeatedly press the **UP/DOWN** $\blacktriangle/\blacktriangledown$ buttons to cycle through these choices: “Air”, “STD”, “HRC” or “IRC” (all cable TV).

Press the **EXIT** button to exit.

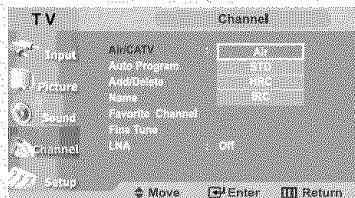

Note : STD, HRC and IRC identify various types of cable TV systems.

Contact your local cable company to identify the type of cable system that exists in your particular area.

At this point the signal source has been selected.

Proceed to “Storing Channels in Memory” (next page).

Storing Channels in Memory (Automatic Method)

1

First, select the correct signal source (Air, STD, HRC, IRC). See steps 1~2 on previous page.

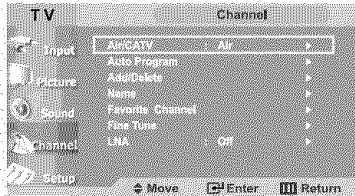

2

Press the UP/DOWN ▲▼ buttons to select "Auto Program". Press the ENTER button.

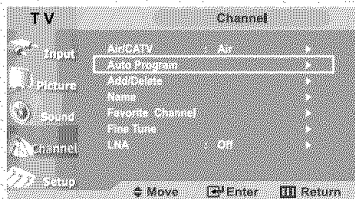

3

Press the LEFT/RIGHT ◀▶ buttons to select "Start", then press the ENTER button.

The TV will begin memorizing all of the available channels.

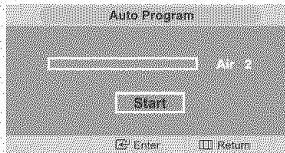

4

After all the available channels are stored, the Auto program menu reappears.

Press the EXIT button to exit.

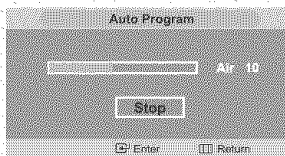

◀ The TV automatically cycles through all of the available channels and stores them in memory. This takes about one to two minutes.

Press ENTER at any time to interrupt the memorization process and return to the Channel menu.

To select channels over 100

Ex) Press **CH** → **0** → **8** to select channel 108.

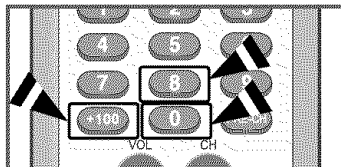

Adding and Erasing Channels (Manual Method)

1

Use the number buttons to directly select the channel to Add or Delete.

Press the **MENU** button to display the menu.

Press the **UP/DOWN ▲▼** buttons to select "Channel", then press the **ENTER** button.

Press the **UP/DOWN ▲▼** buttons to select "Add/Delete".

Press the **ENTER** button.

Press the **ENTER** to select "Add" or "Delete" (pressing **ENTER** toggles between the two).

Press the **EXIT** button to exit.

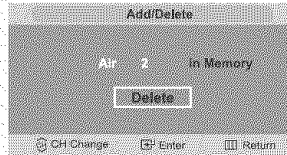
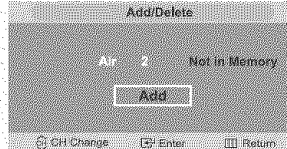
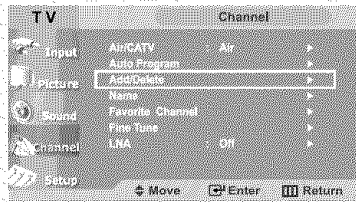

Alternate method:

Use the number buttons to directly select the channel that will be added or erased. Press the "ADD/DEL" button.

Repeatedly pressing **ENTER** will alternate between "Add" and "Delete".

Press the **EXIT** button to exit.

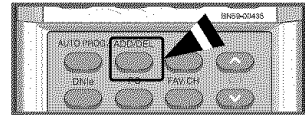

You can view any channel (including an erased channel) by using the number buttons on the remote control.

Labeling Channels

1

Press the **MENU** button to display the menu.

Press the **UP/DOWN ▲▼** buttons to select "Channel", then press the **ENTER** button.

Press the **UP/DOWN ▲▼** buttons to select "Name", then press the **ENTER** button.

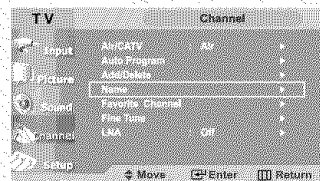

2

Press the **UP/DOWN ▲▼** buttons to select a channel.

You can assign a name to a channel.

Press the **LEFT/RIGHT ◀▶** buttons to move to "Labeling" and use the **UP/DOWN ▲▼** buttons to assign a name.

Repeat this procedure to enter up to four characters.

Press the **EXIT** button to exit.

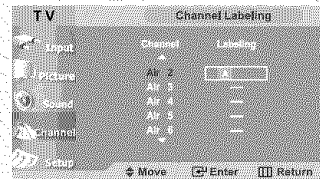
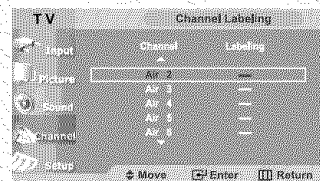

To Set-up Your Channels

1

Press the **MENU** button to display the menu.

Press the **UP/DOWN ▲▼** buttons to select "Channel", then press the **ENTER** button.

Press the **UP/DOWN ▲▼** buttons to select "Favorite Channel", then press the **ENTER** button.

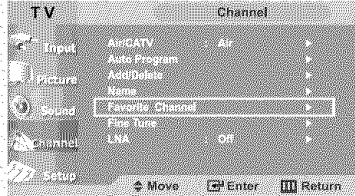

2

Press the **UP/DOWN ▲▼** buttons to select your favorite channels to watch among the labeled channels.

Press the **ENTER** button to add a check mark to set the channel as a favorite channel.

Press the **EXIT** button when done to exit.

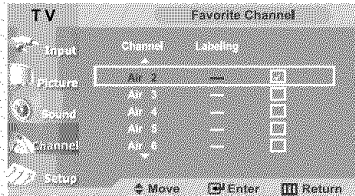
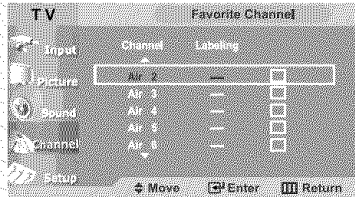

3

To select the Favorite channels, you have set-up, press the **FAV.CH** button on the remote.

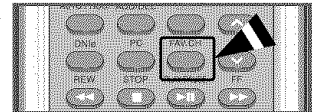

To Select Source

Use to select TV or other external input source connected to the TV.

Use to select the input source of your choice.

1

Press the **MENU** button to display the on-screen menu.

Press the **ENTER** button.

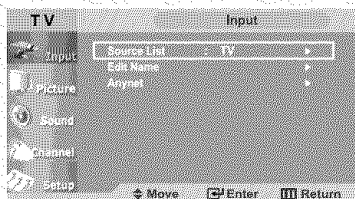

2

Press the **ENTER** button.

Press the **UP/DOWN ▲▼** buttons to select the Input source, then press the **ENTER** button.

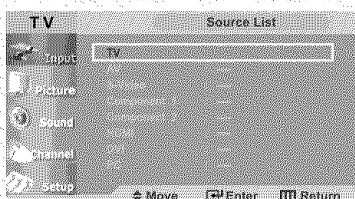

◀ If Connector is not connected, Source cannot be selected except TV. (in both main and sub-screen)

To Edit the Input Source Name

Name the input device connected to the input jacks to make your input source selection easier.

1

Press the **MENU** button to display the on-screen menu.

Press the **ENTER** button to select "Input".

Press the **UP/DOWN** buttons to select "Edit Name", then press the **ENTER** button.

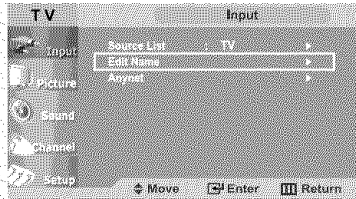

2

Press the **UP/DOWN** buttons to select "AV", "S-Video", "Component1", "Component2", "HDMI", "DVI", or "PC" input jack, then press the **ENTER** button.

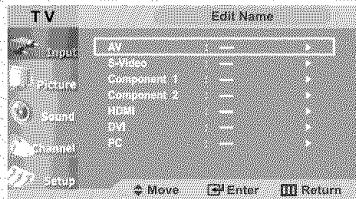

3

Press the **UP/DOWN** buttons to select "VCR", "DVD", "Cable STB", "HD STB", "Satellite STB", "AV Receiver", "DVD Receiver", "Game", "Camcorder", "DVD Combo", "DHR(DVD HDD Recorder)", or "PC" input source, then press the **ENTER** button.

Press the **EXIT** button to exit.

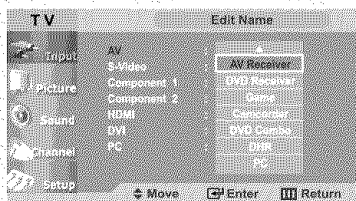
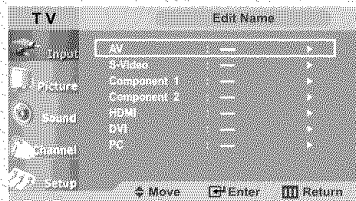

Using Automatic Picture Settings

Your TV has four automatic picture settings (“Dynamic”, “Standard”, “Movie”, and “Custom”) that are preset at the factory. You can activate either Dynamic, Standard, Movie, or Custom by pressing P.MODE (or by making a selection from the menu). Or, you can select “Custom” which automatically recalls your personalized picture settings.

1

Press the **MENU** button to display the menu.

Press the **UP/DOWN ▲▼** buttons to select “Picture”, then press the **ENTER** button.

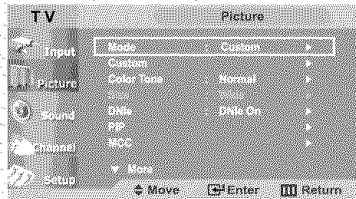

2

Press the **ENTER** button.

Press the **UP/DOWN ▲▼** buttons to select the “Dynamic”, “Standard”, “Movie”, or “Custom” picture setting.

Press **ENTER** button.

Press the **EXIT** button to exit.

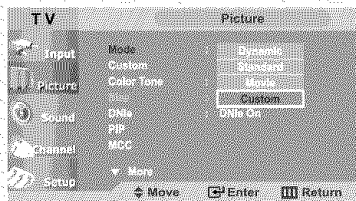

Alternate method:

Simply press the **P.MODE** button on the remote control to select one of the standard picture settings.

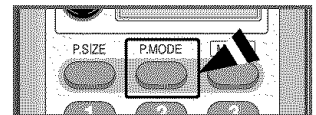

- Choose *Dynamic* to increase the clarity and sharpness of the picture.
- Choose *Standard* for the standard factory settings.
- Choose *Movie* when viewing the Movie.
- Choose *Custom* if you want to adjust the settings according to personal preference (see “Customizing the Picture, page 34).

Customizing the Picture

You can use the on-screen menus to change the contrast, brightness, sharpness, color and tint according to personal preference.

(Alternatively, you can use one of the “automatic” settings. See the previous page.)

1

Press the **MENU** button to display the menu.

Press the **UP/DOWN ▲▼** buttons to select “Picture”, then press the **ENTER** button.

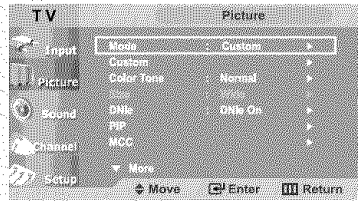

2

Press the **UP/DOWN ▲▼** buttons to select “Custom”, then press the **ENTER** button.

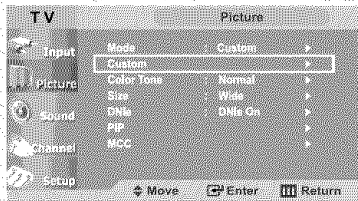

3

Press the **ENTER** button to select “Contrast”, “Brightness”, “Sharpness”, “Color”, or “Tint”.

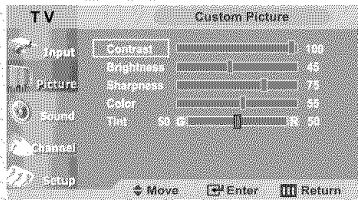

4

Press the **LEFT/RIGHT ◀▶** buttons to decrease or increase the value of a particular item.

For example, if you select “Contrast”, pressing **RIGHT ▶** increases it.

Press the **EXIT** button to exit.



Using Automatic Sound Settings

Your TV has five automatic sound settings (“Standard”, “Music”, “Movie”, “Speech” and “Custom”) that are preset at the factory. You can select “Custom Sound”, which automatically recalls your personalized sound settings.

1

Press the **MENU** button to display the menu.

Press the **UP/DOWN ▲▼** buttons to select “Sound”, then press the **ENTER** button.

Press the **ENTER** button.



2

Press the **UP/DOWN ▲▼** buttons repeatedly to select the “Standard”, “Music”, “Movie”, “Speech”, or “Custom” sound settings.

Press the **EXIT** button to exit.

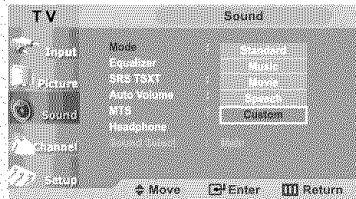

- Choose *Standard* for the standard factory settings.
- Choose *Music* when watching music videos or concerts.
- Choose *Movie* when watching movies.
- Choose *Speech* when watching a show that is mostly dialog (i.e., news).
- Choose *Custom* to recall your personalized settings.

Customizing the Sound

The sound settings can be adjusted to suit your personal preference.

(Alternatively, you can use one of the “automatic” settings. See the previous page.)

1

Press the **MENU** button to display the menu.

Press the **UP/DOWN ▲▼** buttons to select “Sound”, then press the **ENTER** button.

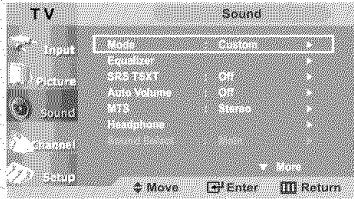

2

Press the **UP/DOWN ▲▼** buttons to select “Custom”, then press the **ENTER** button.

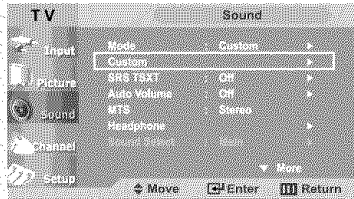

3

Press the **LEFT/RIGHT ◀▶** buttons to select a particular item to be changed.

Press the **UP/DOWN ▲▼** buttons to increase or decrease the value of a particular item.

Press the **EXIT** button to exit.

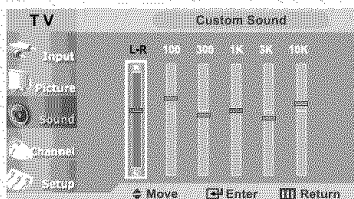
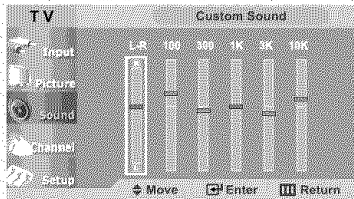

Note :The equalizer allows you to adjust frequencies to your preference.
The lowest frequency is 100 and 10K is the highest.

Selecting a Menu Language

1

Press the **MENU** button to display the menu.

Press the **UP/DOWN ▲▼** buttons to select "Setup", then press the **ENTER** button.



2

Press the **UP/DOWN ▲▼** buttons to select "Language".

Press the **ENTER** button.

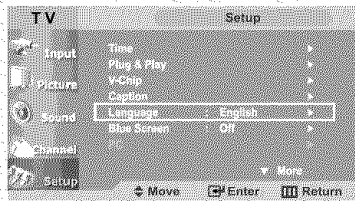

3

Press the **UP/DOWN ▲▼** buttons to select "English", "Français", "Español", or "Português".

Press the **EXIT** button to exit.

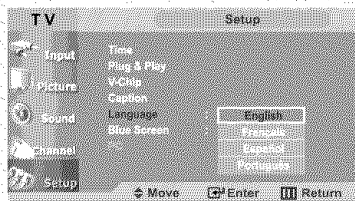

Setting the Blue Screen Mode

If no signal is being received or the signal is very weak, a blue screen automatically replaces the noisy picture background.

If you wish to continue viewing the poor picture, you must set the “Blue screen” mode to “Off”.

1

Press the **MENU** button to display the menu.

Press the **UP/DOWN ▲▼** buttons to select “Setup”, then press the **ENTER** button.



2

Press the **UP/DOWN ▲▼** buttons to select “Blue Screen”, then press the **ENTER** button.

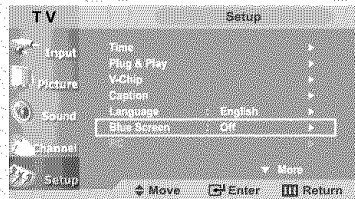

3

Press the **UP/DOWN ▲▼** buttons to set Blue Screen “On” or “Off”.

Press the **EXIT** button to exit.

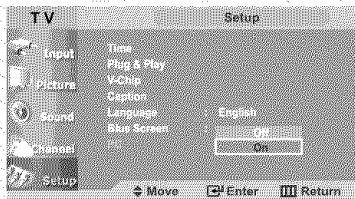

◀ Pressing the **UP/DOWN ▲▼** buttons will alternate between “On” and “Off”.

Fine Tuning Channels

Use fine tuning to manually adjust a particular channel for optimal reception.

1

Press the **MENU** button to display the menu.

Press the **UP/DOWN ▲▼** buttons to select "Channel", then press the **ENTER** button twice.

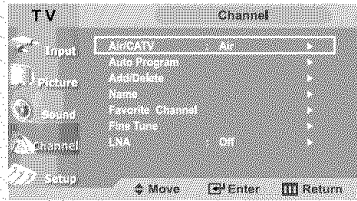

2

Press the **UP/DOWN ▲▼** buttons to select "Fine Tune", then press the **ENTER** button.

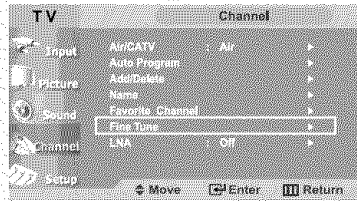

3

Press the **LEFT/RIGHT ◀▶** buttons to adjust the fine tuning.

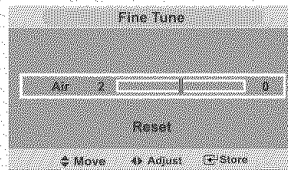

◀ If you do not store the fine-tuned channel in memory, adjustments are not saved.

4

To store the fine tuning setting in the TV's memory, press the **ENTER** button.

Press the **EXIT** button to exit.

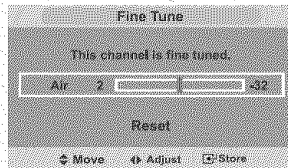

◀ Fine tuned channels that have been saved are marked with an asterisk "*" on the right-hand side of the channel number in the channel banner.

LNA (Low Noise Amplifier)

If the TV is operating in a weak-signal area, sometimes the LNA function can improve the reception (a low-noise preamplifier boosts the incoming signal).

1

Press the **MENU** button to display the menu.

Press the **UP/DOWN ▲▼** buttons to select "Channel", then press the **ENTER** button.

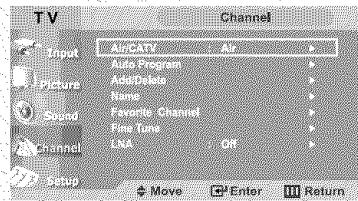

2

Press the **UP/DOWN ▲▼** buttons to select "LNA", then press the **ENTER** button.

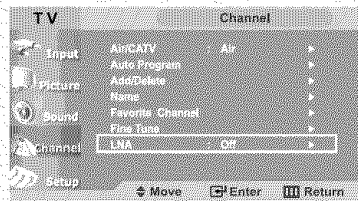

3

Press the **UP/DOWN ▲▼** buttons to set LNA "On" or "Off".

Press the **EXIT** button to exit.

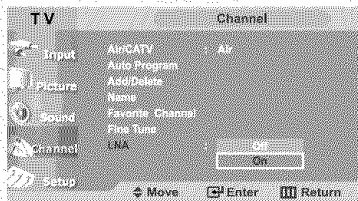

◀ Pressing the **UP/DOWN ▲▼** buttons will alternate between "On" and "Off".

Viewing Picture-in-Picture

This product has one built-in tuner, which does not allow PIP to function in the same mode. For example, you cannot watch one TV channel in the main screen, and a different one in the PIP screen. Please see 'PIP Settings' below for details.

You can use the PIP feature to simultaneously watch two video sources.

Note: While V-Chip is in operation, the PIP function cannot be used.

Activating Picture-in-Picture

1

Press the **MENU** button to display the menu.

Press the **UP/DOWN** ▲▼ buttons to select "Picture", then press the **ENTER** button.

Press the **UP/DOWN** ▲▼ buttons to select "PIP", then press the **ENTER** button.

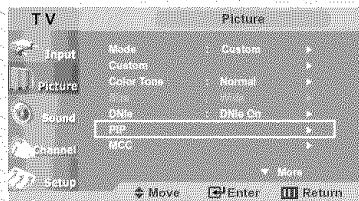

- ◀ Quick way to access the PIP menu:
Simply press the PIP button on the remote control.

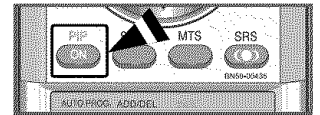

2

Press the **ENTER** button.

Press the **UP/DOWN** ▲▼ buttons to select "On".

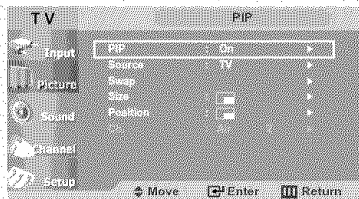
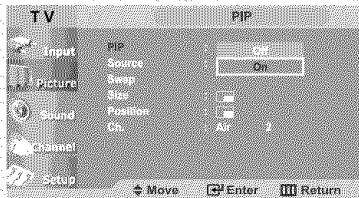

- ◀ If you turn the TV off while watching and turn it on again, the PIP window will disappear.

PIP Settings

O : PIP operates
X : PIP doesn't operate

Sub Picture Main Picture	TV	AV	S-Video	COMP 1	COMP 2	HDMI	DVI	PC
TV	O	O	O	O	O	O	O	O
AV	O	O	O	O	O	O	O	O
S-Video	O	O	O	O	O	O	O	O
COMP 1	O	O	O	X	X	X	X	X
COMP 2	O	O	O	X	X	X	X	X
HDMI	O	O	O	X	X	X	X	X
DVI	O	O	O	X	X	X	X	X
PC	O	O	O	X	X	X	X	X

Selecting a Signal Source (External A/V) for PIP

3

Press the **UP/DOWN ▲▼** buttons to select "Source", then press the **ENTER** button.

Select a source of the sub picture by pressing the **UP/DOWN ▲▼** buttons and press the **ENTER** button.

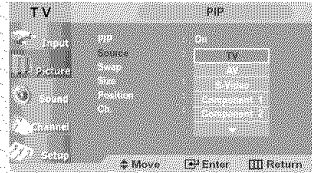

Note :If Connector is not connected, Source cannot be selected except TV.
(in both main and sub-screen)

Source selection is possible only when Component 1, Component 2, HDMI, DVI, or PC is connected.

Swapping the Contents of the PIP and Main image

4

Press the **UP/DOWN ▲▼** buttons to select "Swap", then press the **ENTER** button.

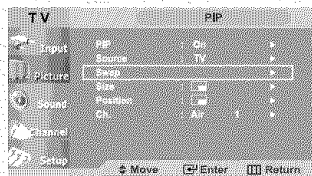

Changing the PIP Channel

5

Press the **UP/DOWN ▲▼** buttons to select "Ch.(Channel)", then press the **ENTER** button.

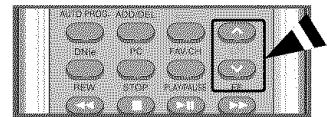
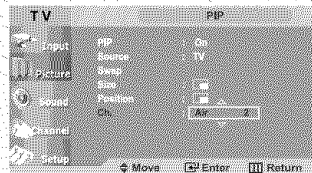

◀ You can select the channel that you want to view through sub picture by pressing the **UP/DOWN ▲▼** buttons.

Changing the Position of the PIP Window

6

Press the **UP/DOWN ▲▼** buttons to select "Position", then press the **ENTER** button.

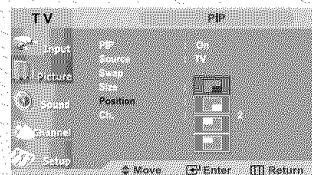

Changing the Size of the PIP Window

7

Press the **UP/DOWN ▲▼** buttons to select "Size", then press the **ENTER** button.

Press the **EXIT** button to exit.

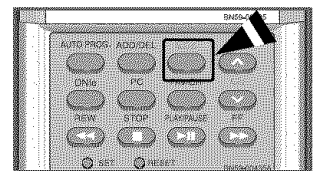
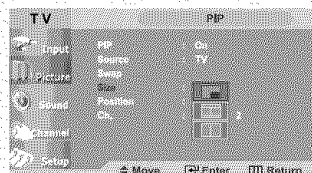

- When the PC is in energy saving mode, you cannot choose the PIP option.
- You may notice that the picture in the PIP window becomes slightly unnatural when you set the main screen to game or karaoke mode.
- Switch the main screen and the PIP window for normal viewing.

DNle (Digital Natural Image engine)

Samsung's New Technology brings you more detailed images with contrast, white enhancement and 3D noise reduction.

1

Press the **MENU** button to display the menu.

Press the **UP/DOWN ▲▼** buttons to select "Picture", then press the **ENTER** button.

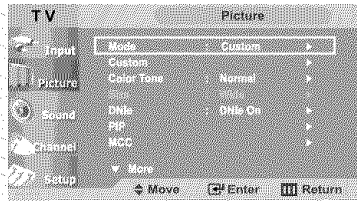

2

Press the **UP/DOWN ▲▼** buttons to select "DNle", then press the **ENTER** button.

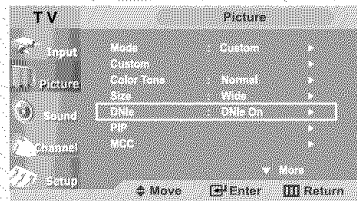

3

Press the **UP/DOWN ▲▼** buttons to select "DNle On", "DNle Off", "DNle Demo", then press the **ENTER** button.

Press the **EXIT** button to exit.

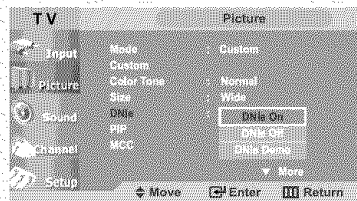

- DNle On: Improved picture mode as demonstrated by DNle Demo is activated.
- DNle Off: The mode is deactivated and the screen returns to its original condition.
- DNle Demo: The screen shows the improved image on the left-hand side and the original image on the right-hand side.

MCC (My Color Control)

MCC allows users to adjust colors to their preference, by adjusting skin, sky and grass tones using the predefined settings(Standard, Custom, Turkish Blue, Emerald Green, and Indian Pink) without affecting other colors on the screen.

Easy Control

1

Press the **MENU** button to display the menu.

Press the **UP/DOWN ▲▼** buttons to select "Picture", then press the **ENTER** button.

Press the **UP/DOWN ▲▼** buttons to select "MCC" then press the **ENTER** button.

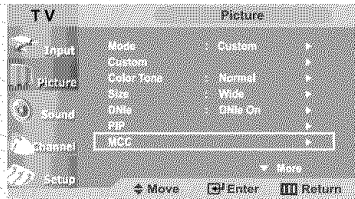

2

Press the **UP/DOWN ▲▼** buttons to select "Easy Control", then press the **ENTER** button.

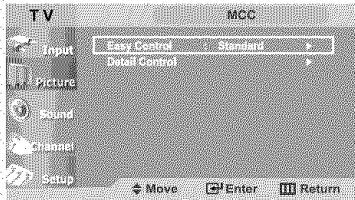

◀ This function doesn't work when Source is in PC mode, or DNIe is in off mode.



3

Press the **LEFT/RIGHT ◀▶** buttons to select among the various picture settings, then press **ENTER**.

The Original picture (before adjustment) is shown on the left side, while the selected mode is shown on the right.

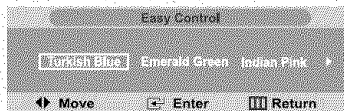
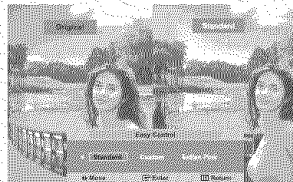

- The sources are displayed in the following order :
Turkish Blue - Emerald Green - Indian Pink - Standard - Custom

Detail Control

1

Press the **MENU** button to display the menu.

Press the **UP/DOWN ▲▼** buttons to select "Picture", then press the **ENTER** button.

Press the **UP/DOWN ▲▼** buttons to select "MCC" then press the **ENTER** button.

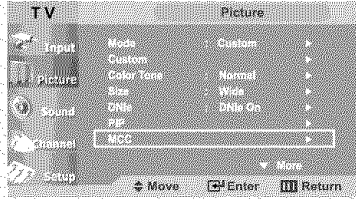

◀ You can adjust skin, sky and grass tones without using the predefined settings in custom mode.

2

Press the **UP/DOWN ▲▼** buttons to select "Detail Control", then press the **ENTER** button.

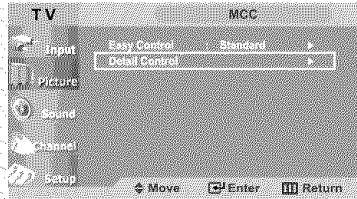

◀ This function doesn't work when the Source is in PC mode, or DNIe is in off mode.

3

Press the **UP/DOWN ▲▼** buttons to select the desired MCC color and press the **ENTER** button.

Press the **LEFT/RIGHT ◀▶** buttons to increase or decrease the value of a particular item.

Press the **EXIT** button to exit.

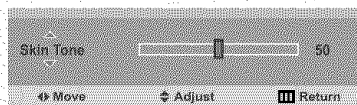
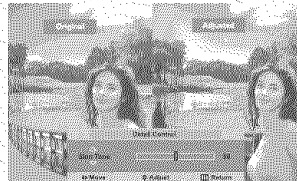
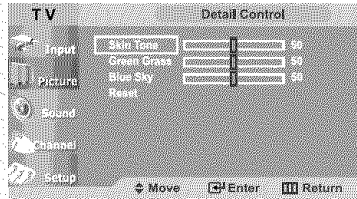

- The sources are displayed in the following order :
Skin Tone - Green Grass - Blue Sky- Reset

I2C (Intelligent Image Control)

I2C (Intelligent Image Control) automatically detects the inputted visual signal and adjusts to create optimum contrast.

1

Press the **MENU** button to display the menu.

Press the **UP/DOWN ▲▼** buttons to select "Picture", then press the **ENTER** button.

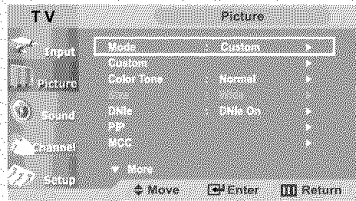

2

Press the **UP/DOWN ▲▼** buttons to select "I2C", then press the **ENTER** button.

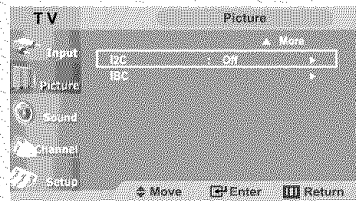

◀ This function doesn't work when the Source is in PC mode, or DNIe is in off mode.

3

Press the **UP/DOWN ▲▼** buttons to select "On" or "Off".

Press the **EXIT** button to exit.

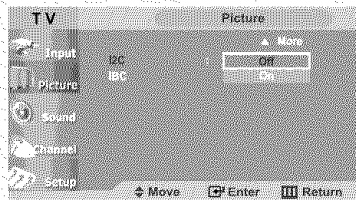

IBC (Intelligent Brightness Control)

The IBC (Intelligent Brightness Control) adjusts the screen brightness automatically by using a light detecting sensor.

1

Press the **MENU** button to display the menu.

Press the **UP/DOWN ▲▼** buttons to select "Picture", then press the **ENTER** button.

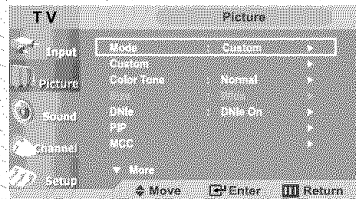

2

Press the **UP/DOWN ▲▼** buttons to select "IBC", then press the **ENTER** button.

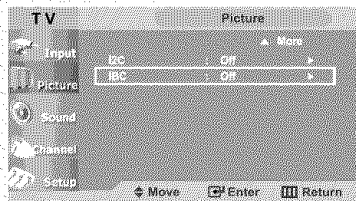

◀ This function doesn't work when the Source is in PC mode.

3

Press the **LEFT/RIGHT ◀▶** buttons to select "On" or "Off".

Press the **EXIT** button to exit.

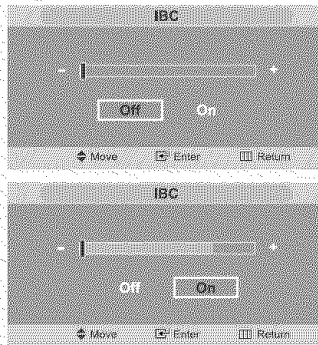

◀ Screen brightness is adjusted automatically depending on the brightness of the surrounding environment.

Changing the Screen Size

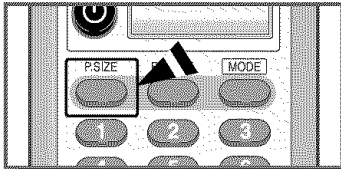

1

Press the **P.SIZE** button to change the screen size.

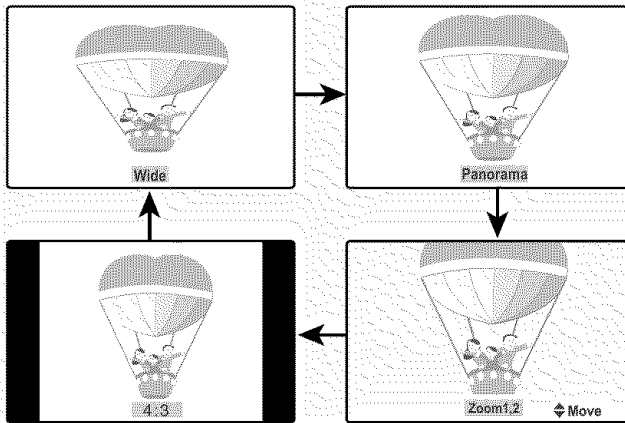

◀ Note : Only wide and size of 4:3 can be selected for PC Source.

- Wide : Sets the picture to 16:9 wide mode.
- Panorama : Use this mode for the wide aspect ratio of a panoramic picture.
- Zoom 1,2 : Magnifies the size of the picture on screen.
- 4:3 : Sets the picture to 4:3 normal mode.
This is the standard TV screen size.

Freezing the Picture

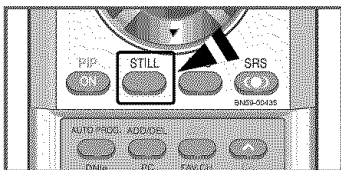

1

Press the **STILL** button to freeze a moving picture.

- Normal sound will still be heard.
- Press again to cancel.

Adjusting the Color Tone

You can change the color of the entire screen according to your preference.

1

Press the **MENU** button to display the menu.

Press the **UP/DOWN ▲▼** buttons to select "Picture", then press the **ENTER** button.

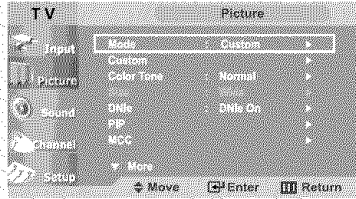

2

Press the **UP/DOWN ▲▼** buttons to select "Color Tone", then press the **ENTER** button.

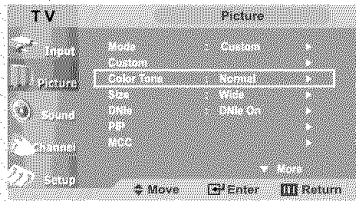

3

Press the **UP/DOWN ▲▼** buttons to select "Cool 2", "Cool 1", "Normal", "Warm 1", or "Warm 2".

Press the **EXIT** button to exit.

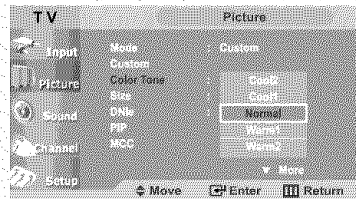

◀ Choose from the following Color Tone settings: "Cool 2", "Cool 1", "Standard", "Warm 1", "Warm 2" according to personal preference.

Setting the TruSurround XT(SRS TSXT)

Emphasizes midrange and bass and provides a simulated surround-sound experience.

1

Press the **MENU** button to display the menu.

Press the **UP/DOWN ▲▼** buttons to select "Sound", then press the **ENTER** button.

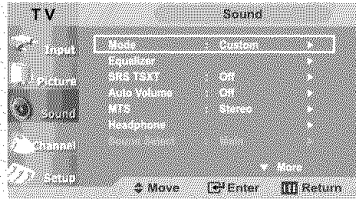

2

Press the **UP/DOWN ▲▼** buttons to select "SRS TSXT", then press the **ENTER** button.



3

Press the **UP/DOWN ▲▼** buttons to select "Off", "3D Mono", "Stereo", then press the **ENTER** button.

Press the **EXIT** button to exit.

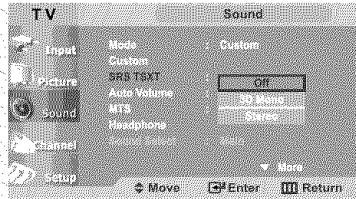

TRADEMARK & LABEL LICENSE NOTICE



is a trademark of SRS Labs, Inc. TruSurround XT technology is incorporated under license from SRS labs, Inc.

Automatic Volume Control

Reduces the differences in volume level among broadcasters.

1

Press the **MENU** button to display the menu.

Press the **UP/DOWN ▲▼** buttons to select "Sound", then press the **ENTER** button.

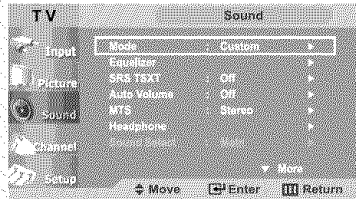

2

Press the **UP/DOWN ▲▼** buttons to select "Auto Volume", then press the **ENTER** button.

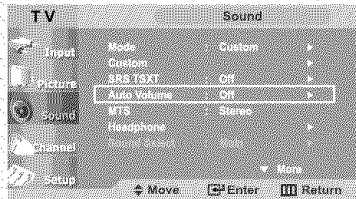

3

Press the **UP/DOWN ▲▼** buttons to set Auto Volume "On" or "Off"

Press the **EXIT** button to exit.

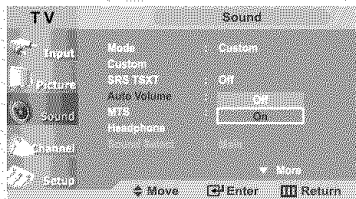

Special Sound Options

Choosing a Multi-Channel Sound (MTS) Soundtrack

Depending on the particular program being broadcast, you can listen to stereo, mono, or a Separate Audio Program. (SAP audio is usually a foreign-language translation. Sometimes SAP has unrelated information like news or weather).

1

Press the **MENU** button to display the menu.

Press the **UP/DOWN ▲▼** buttons to select "Sound", then press the **ENTER** button.

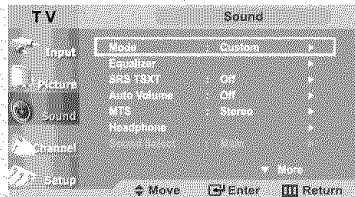

2

Press the **UP/DOWN ▲▼** buttons to select "MTS", then press the **ENTER** button.

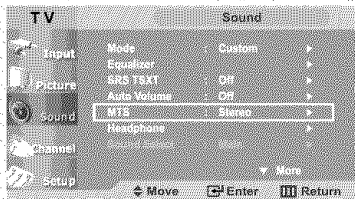

3

Press the **UP/DOWN ▲▼** buttons to select "Mono", "Stereo" or "SAP", then press the **ENTER** button.

Press the **EXIT** button to exit.

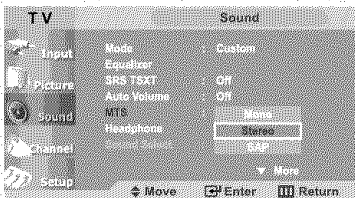

- Choose *Stereo* for channels that are broadcasting in stereo.
- Choose *Mono* for channels that are broadcasting in mono, or if you are having difficulty receiving a stereo signal.
- Choose *SAP* to listen to the Separate Audio Program, which is usually a foreign-language translation.

You can also change the MTS setting by pressing the "MTS" button on the remote control. (When you change channels, MTS is set to "Stereo" automatically. To listen in 'SAP' or 'Mono,' change the MTS setting).

Adjusting the Headphone Sound

The headphone option is especially useful when simultaneously watching the main screen and the PIP window.

◀ Note :Headphones must be purchased separately.

1

Press the **MENU** button to display the menu.

Press the **UP/DOWN ▲▼** buttons to select "Sound", then press the **ENTER** button.

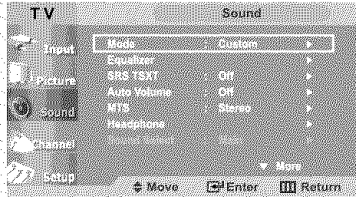

2

Press the **UP/DOWN ▲▼** buttons to select "Headphone", then press the **ENTER** button.

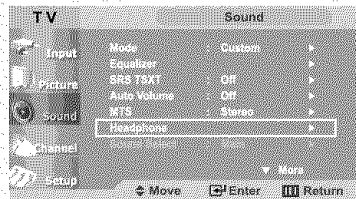

3

Press the **UP/DOWN ▲▼** buttons to select the particular item to be changed.

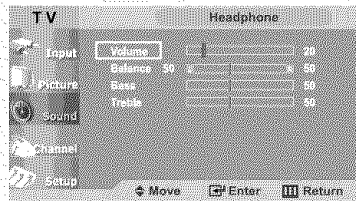

4

Press the **LEFT/RIGHT ◀▶** buttons to decrease or increase the value of a particular item.

Press the **EXIT** button to exit.

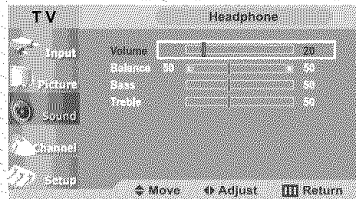

Selecting the Main or Sub Sound

You can select to hear sound from either the Main or Sub picture when PIP is On.

1

Press the **MENU** button to display the menu.

Press the **UP/DOWN ▲▼** buttons to select "Sound", then press the **ENTER** button.

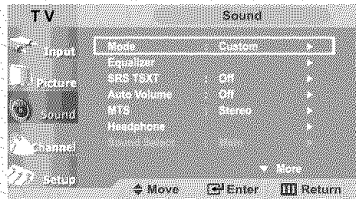

2

Press the **UP/DOWN ▲▼** buttons to select "Sound Select", then press the **ENTER** button.



3

Press the **UP/DOWN ▲▼** buttons to select "Main" or "Sub".

Select "Main" to hear the main TV sound and select "Sub" to hear the PIP window sound.

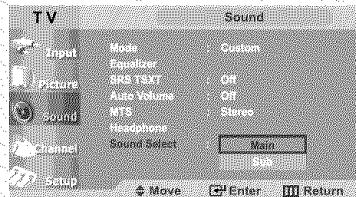

Press the **EXIT** button to exit.

Sub Woofer

The TV provides an output for hookup to an active(powered) subwoofer.

Note : Extra sub-woofer speaker is necessary to emphasize low-key sound.
Adjust cutoff frequency to emphasize the lower keys.

1

Press the **MENU** button to display the on-screen menu.

Press the **UP/DOWN ▲▼** buttons to select "Sound", then press the **ENTER** button.

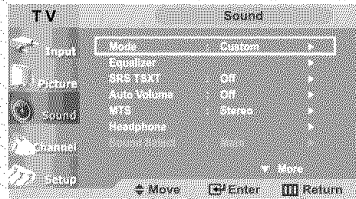

2

Press the **UP/DOWN ▲▼** buttons to select "Sub Woofer", then press the **ENTER** button.

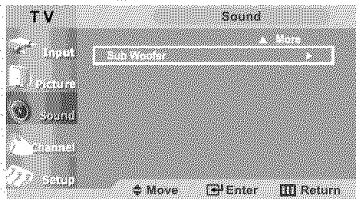

3

Press the **ENTER** button.

Press the **UP/DOWN ▲▼** buttons to select "On", then press the **ENTER** button.

Press the **UP/DOWN ▲▼** buttons to select the particular item to be changed.

Press the **LEFT/RIGHT ◀▶** buttons to decrease or increase the value of a particular item.

Press the **EXIT** button to exit.

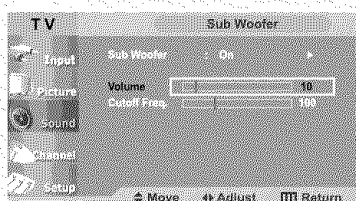
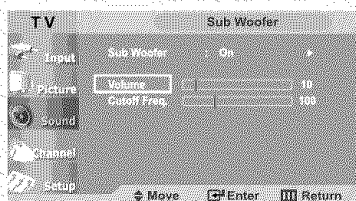
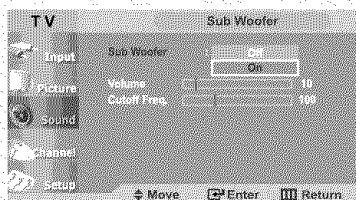
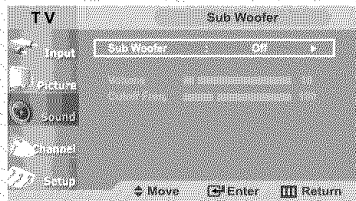

Setting the Clock

Setting the clock is necessary in order to use the various timer features of the TV. Also, you can check the time while watching the TV. (Just press the INFO button).

1

Press the **MENU** button to display the on-screen menu.

Press the **UP/DOWN ▲▼** buttons to select "Setup", then press the **ENTER** button.

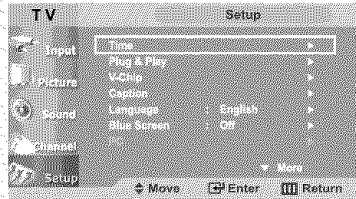

2

Press the **ENTER** button to select "Time", then press the **ENTER** button to select "Clock".

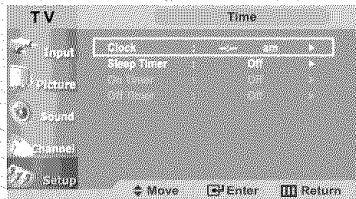

3

Press the **UP/DOWN ▲▼** buttons repeatedly until the correct "Hour" appears.

After the hour is entered, press the **LEFT/RIGHT ◀▶** buttons to select "Minute".

Press the **UP/DOWN ▲▼** buttons until the correct "Minute" appears.

Press the **LEFT/RIGHT ◀▶** buttons to select "am/pm" and adjust with the **UP/DOWN ▲▼** buttons.

Press the **EXIT** button to exit.

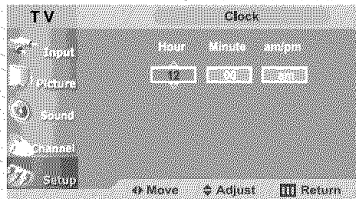

◀ Note : You can also set the time using the numeric buttons on the remote.

Setting the On/Off Timer

1

Press the **MENU** button to display the on-screen menu.

Press the **UP/DOWN ▲▼** buttons to select "Setup", then press the **ENTER** button.

Press the **ENTER** button to select "Time".



2

Press the **UP/DOWN ▲▼** buttons to select "On Timer", then press the **ENTER** button.

Press the **UP/DOWN ▲▼** buttons repeatedly to select the appropriate "Hour".

Press the **LEFT/RIGHT ◀▶** buttons repeatedly to select the appropriate minute (i.e., the time when the TV will turn on).

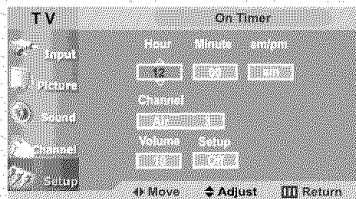
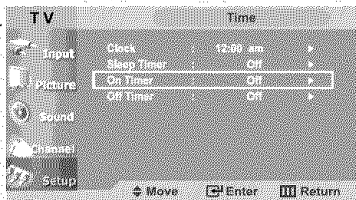
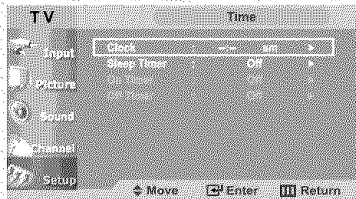

◀ Before using the timer, you must set the TV's clock. (See "Setting the Clock" on page 56)

◀ When you set the hours, make sure the correct time of day (am or pm) appears to the right of the time.

3

Press the **LEFT/RIGHT** ◀▶ buttons to select "Setup".

Press the **UP/DOWN** ▲▼ buttons to On Timer "On".
(Repeatedly pressing the **UP/DOWN** ▲▼ buttons will alternate between On and Off).

When finished, press the **ENTER** ⏏ button.

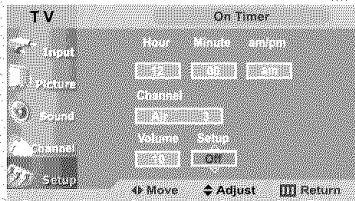

◀ To deactivate the "On Timer," select "Off" during this step.

4

To set the Off time, press the **UP/DOWN** ▲▼ buttons to select "Off Timer".

Press the **ENTER** ⏏ button and set the hours and minutes. (Follow the same procedure as in steps 2 and 3 above).

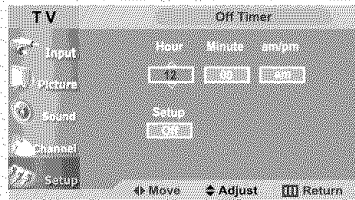
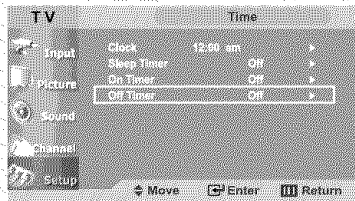

5

When finished setting the timer, press the **EXIT** button to exit.

• **Auto Power Off**

When you set the timer on, your television will be turned off if you do not operate any controls for 3 hours after the TV has been turned on with the 'Timer On' function. 'Auto power off' operates only when the TV has been turned on by the 'Timer on' function.

Setting the Sleep Timer

Set the timer for the TV to turn off at the preset time automatically.

Sleep timer

1

Press the **MENU** button to display the on-screen menu.

Press the **UP/DOWN ▲▼** buttons to select "Setup", then press the **ENTER** button.

Press the **ENTER** button to select "Time".

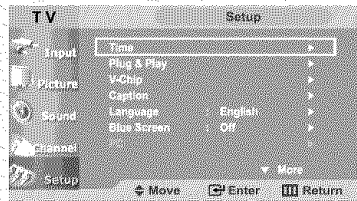

2

Press the **UP/DOWN ▲▼** buttons to select "Sleep Timer", then press the **ENTER** button.

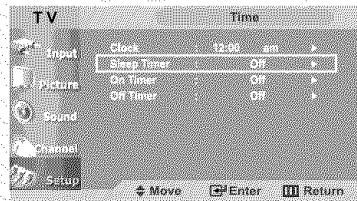

3

Press the **UP/DOWN ▲▼** buttons repeatedly until the correct time appears.

Press the **EXIT** button to exit.

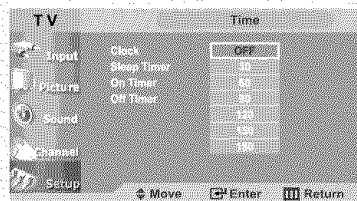

Viewing Closed Captions

Your TV decodes and displays the closed captions that are broadcast with certain TV shows. These captions are usually subtitles for the hearing impaired or foreign-language translations. All VCRs record the closed caption signal from television programs, so home-recorded video tapes also provide closed captions. Most pre-recorded commercial video tapes provide closed captions as well. Check for the closed caption symbol : **CC** .

1

Press the **MENU** button to display the on-screen menu.

Press the **UP/DOWN ▲▼** buttons to select "Setup", then press the **ENTER** button.

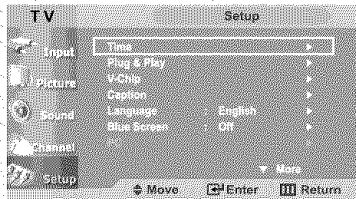

2

Press the **UP/DOWN ▲▼** buttons to select "Caption", then press the **ENTER** button.

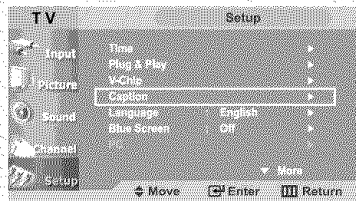

3

Press the **ENTER** button.

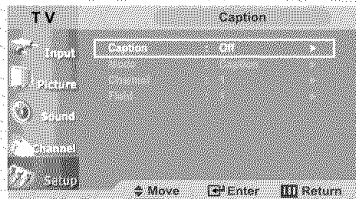

4

Press the **UP/DOWN ▲▼** buttons to set caption "Off" or "On", then press the **ENTER** button.

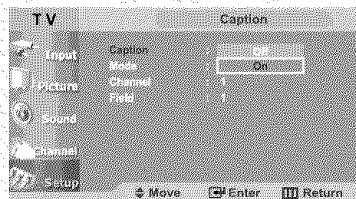

5

Depending on the particular broadcast, it might be necessary to alter the settings to "Channel" and "Field".

◀ Different channels and fields display different information: Field 2 carries additional information that supplements the information in Field 1. (For example, Channel 1 may have subtitles in English, while Channel 2 has subtitles in Spanish).

6

Press the **UP/DOWN ▲▼** buttons to select "Mode", then press the **ENTER** button.

Press the **UP/DOWN ▲▼** buttons to set "Caption" or "Text", then press the **ENTER** button.

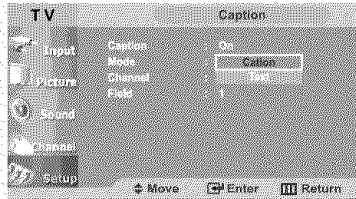
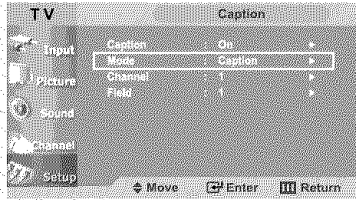

7

Press the **UP/DOWN ▲▼** buttons to select "Channel", then press the **ENTER** button.

Press the **UP/DOWN ▲▼** buttons to select "1" or "2", then press the **ENTER** button.

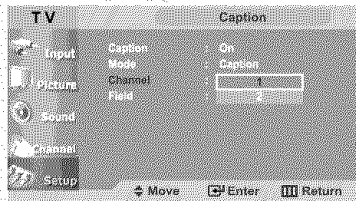
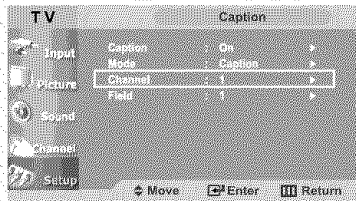

8

Press the **UP/DOWN ▲▼** buttons to select "Field", then press the **ENTER** button.

Press the **UP/DOWN ▲▼** buttons to select "1" or "2", then press the **ENTER** button.

Press the **EXIT** button to exit.

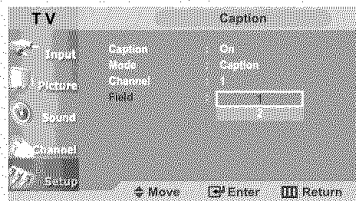
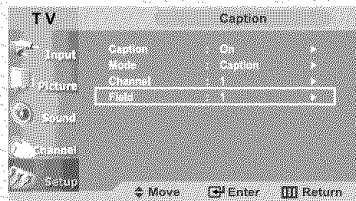

Using the V-Chip

The V-Chip feature automatically locks out programming that is deemed inappropriate for children. The user must first enter a Pin (personal ID number) before any of the V-Chip restrictions can be set up or changed.

Setting Up Your Personal ID Number (PIN)

1

Press the **MENU** button to display the menu.

Press the **UP/DOWN ▲▼** buttons to select "Setup", then press the **ENTER** button.

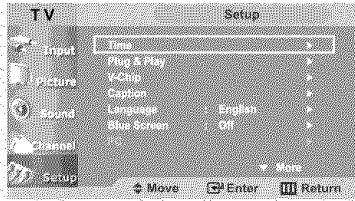

2

Press the **UP/DOWN ▲▼** buttons to select "V-Chip", then press the **ENTER** button.



3

The "Enter Pin" screen will appear. Enter your 4-digit Pin number.

Note: The default Pin number for a new TV set is "0-0-0-0."

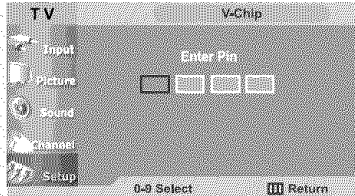

4

After entering a valid PIN number, the "V-Chip" screen will appear. Press the **UP/DOWN ▲▼** buttons to select "Change Pin".

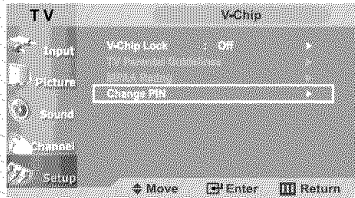

5

Press the **ENTER** button.

The Change Pin screen will appear. Choose any 4-digits for your PIN and enter them.

As soon as the 4 digits are entered, the "Confirm New Pin" screen appears. Re-enter the same 4 digits.

When the Confirm screen disappears, your Pin has been memorized.

Press the **EXIT** button to exit.

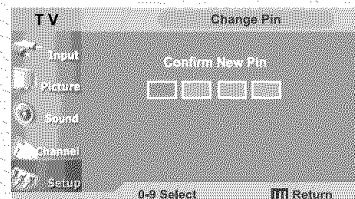
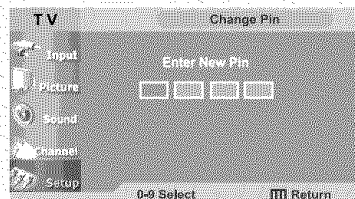

◀ Note: If you forget the Pin, press the remote-control buttons (with the unit "Off") in the following sequence, which resets the pin to 0-0-0-0:
POWER OFF → MUTE → 8 → 2 → 4 → POWER ON.

How to Enable/Disable the V-Chip

Note : PIP operation is disabled when the V-chip is on.

1

Press the **MENU** button to display the menu.

Press the **UP/DOWN ▲▼** buttons to select "Setup", then press the **ENTER** button.

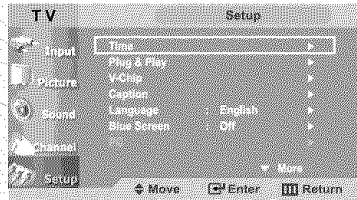

2

Press the **UP/DOWN ▲▼** buttons to select "V-Chip", then press the **ENTER** button.

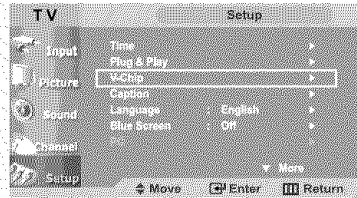

3

The "Enter Pin" screen will appear. Enter your 4-digit Pin number.

Note: The default Pin number for a new TV set is "0-0-0-0."

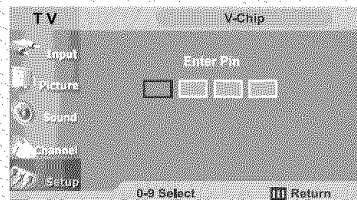

4

The "V-Chip" screen will appear, and "V-Chip Lock" will be selected.

To enable the V-Chip feature, press the **UP/DOWN ▲▼** buttons so that the "V-Chip Lock" is set to Yes. (Pressing the **UP/DOWN ▲▼** buttons will alternate between "On" and "Off".)

Press the **EXIT** button to exit.

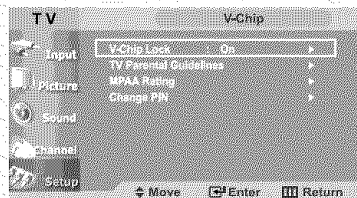

How to Set up Restrictions Using the 'TV Parental Guidelines'

First, set up a personal identification number (PIN), and enable the V-Chip. (See previous section.) Parental restrictions can be set up using either of two methods: The TV guidelines or the MPAA rating.

1

Press the **MENU** button to display the menu.

Press the **UP/DOWN ▲▼** buttons to select "Setup", then press the **ENTER** button.



2

Press the **UP/DOWN ▲▼** buttons to select "V-Chip", then press the **ENTER** button.

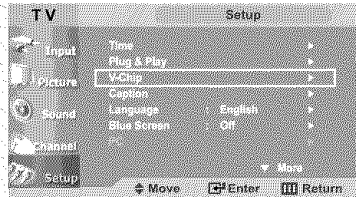

3

The "Enter Pin" screen will appear. Enter your 4-digit Pin number.

Note: The default Pin number for a new TV set is "0-0-0-0."

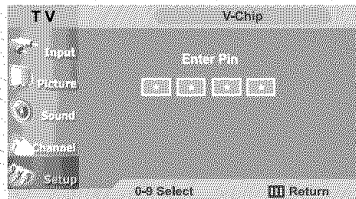
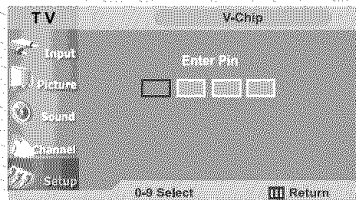

4

Press the **UP/DOWN ▲▼** buttons to select "TV Parental Guidelines", then press the **ENTER** button.

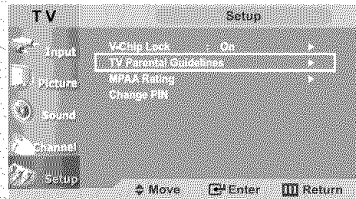

5

The "TV Parental Guidelines" screen will appear.

Press the **UP/DOWN ▲▼** buttons to select one of the six age-based categories:

TV-Y Young children
TV-Y7 Children 7 and over

TV-G General audience
TV-PG Parental guidance
TV-14 Viewers 14 and over
TV-MA Mature audience

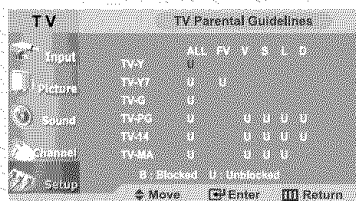

▶ Note: These categories consist of two separate groups : TV-Y and TV-Y7 (young children through age 7), and TV-G through TV-MA (everybody else). The restrictions for these two groups work independently: If a household includes very young children as well as young adults, the TV guidelines must be set up separately for each age group. (See next step.)

5

At this point, one of the TV-Ratings is selected.

Depending on your existing setup, the color of the letter "U" or "B" will be highlighted (changed to yellow). (U= Unblocked, B= Blocked)

When the color of the "U" or "B" is changed, press the **ENTER**() button to block or unblock the category.

To select a different TV-Rating, press the **UP/DOWN**  buttons and then repeat the process.

To **EXIT** this screen, press **MENU**() again.

Note 1: The TV-Y7, TV-PG, TV-14 and TV-MA have additional options.

See the next step to change any of the following sub-ratings:

- FV : Fantasy Violence
- D : Sexual suggestive Dialog
- L : Adult Language
- S : Sexual situation
- V : Violence

Note 2: The V-Chip will automatically block certain categories that are "more restrictive."

For example, if you block "TV-Y" category, then TV-Y7 will automatically be blocked.

Similarly, if you block the TV-G category, then all the categories in the "young adult" group will be blocked (TV-G, TV-PG, TV-14 and TV-MA). The sub-ratings (D, L, S, V) work together similarly. (See next section.)

6

How to set the FV, D, L, S and V sub-ratings.

First, select one of these TV-Ratings: TV-Y7, TV-PG, TV-14 or TV-MA (See Step 4, on previous page).

Next, while the TV-Rating is selected, repeatedly press the **LEFT** or **RIGHT** buttons.

This will cycle through the available sub-ratings (FV,L, S, D or V).

A highlighted letter ("U" or "B") will be displayed for each sub-rating. While the "U" or "B" is highlighted, press the **ENTER**() button to change the sub-rating.

Press **MENU**() once to save the TV guidelines.

To select a different TV-Rating, press the **UP/DOWN**  buttons and then repeat the process.

To exit this screen, press **MENU**() once again.

Note: The V-chip will automatically block certain categories that are "More restrictive".

For example, if you block the "L" sub-rating in TV-PG, then the "L" sub-ratings in TV-14 and TV-MA will automatically be blocked.

7

Press the **MENU** button to clear all the screens.

(Or proceed to the next section, and set up additional restrictions based on the MPAA codes).

How to Set up Restrictions Using the MPAA Ratings: G, PG, PG-13, R, NC-17, X

The MPAA rating system uses the Motion Picture Association of America (MPAA) system, and its main application is for movies.

When the V-Chip lock is on, the TV will automatically block any programs that are coded with objectionable ratings (either MPAA or TV-Ratings).

1

Press the **MENU** button to display the menu.

Press the **UP/DOWN ▲▼** buttons to select "Setup", then press the **ENTER** button.

Press the **UP/DOWN ▲▼** buttons to select "V-Chip", then press the **ENTER** button.

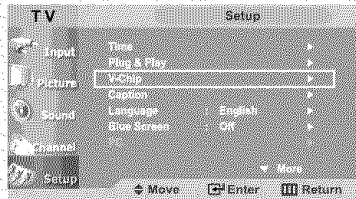

2

The "Enter Pin" screen will appear. Enter your 4-digit PIN number.

Note: The default Pin number for a new TV set is "0-0-0-0."

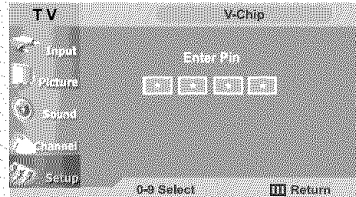
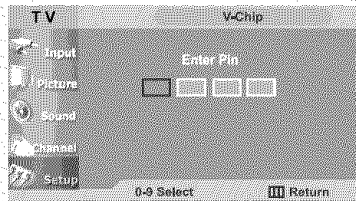

3

Press the **UP/DOWN ▲▼** buttons to select "MPAA rating", then press the **ENTER** button.

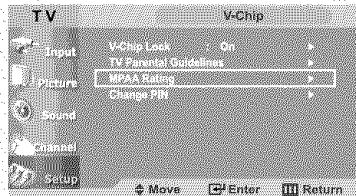

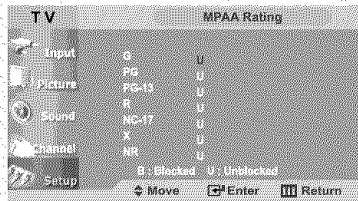

4

Repeatedly press the **UP/DOWN ▲▼** buttons to select a particular MPAA category. (When a category is selected, its color changes to yellow.)



G	General audience (no restrictions).
PG	Parental guidance suggested.
PG-13	PG-13 (Parents strongly cautioned).
R	R (Restricted. Children under 17 should be accompanied by an adult).
NC-17	No children under age 17.
X	X (Adults only).
NR	Not rated.

Press the **ENTER**() button to select “U” or “B”.

Press the **MENU**() button four times to save the settings and to clear all screens.

Note: The V-Chip will automatically block any category that is “more restrictive”.

For example, if you block the “PG-13” category, then “R,” “NC-17,” and “X” will automatically be blocked also.

How to Reset the TV after the V-Chip Blocks a Channel (‘Emergency Escape’)

If the TV is tuned to a restricted channel, the V-Chip will block it. The screen will go blank and the following message will appear: “Excessive rating”.

To resume normal viewing, tune to a different channel using the number buttons. Under certain conditions (depending on the rating of the local TV programs) the V-Chip might lock out all the channels.

In this case, use the Menu button for an “emergency escape”:

Select the V-Chip on the Menu. Enter your PIN number, and press the **ENTER**() button to temporarily disable the V-Chip Lock.

Color Weakness

This feature enables those with a color weakness to view images as those with normal color vision do. The feature provides nine different color adjustment layers for red, green and blue.

1

Press the **MENU** button to display the on-screen menu.

Press the **UP/DOWN ▲▼** buttons to select "Setup", then press the **ENTER** button.

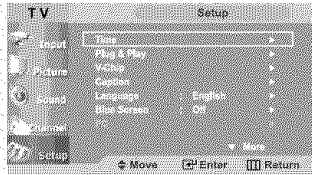

2

Press the **UP/DOWN ▲▼** buttons to select "Color Weakness", then press the **ENTER** button.

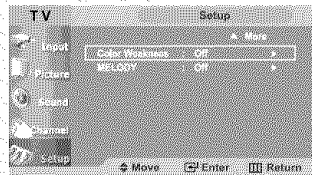

3

Press the **ENTER** button and then press the **UP/DOWN ▲▼** buttons to select "On", then press the **ENTER** button.

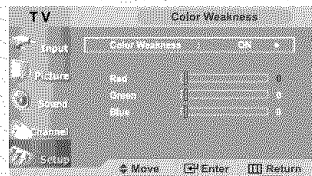
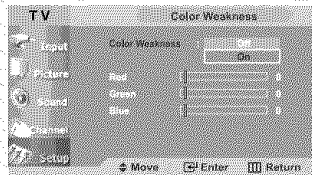

4

Press the **UP/DOWN ▲▼** buttons to select "Red", "Green", "Blue".

Press the **LEFT/RIGHT ◀▶** buttons to decrease or increase the value of a particular item.

Press the **EXIT** button to exit.

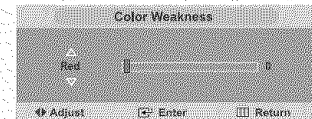
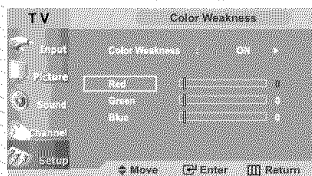

◀ This function doesn't work when the Source is in PC mode, or DNIe is in off mode.

Selecting the Melody

You can hear a melody sound when the television is powered on or off.

1

Press the **MENU** button to display the on-screen menu.

Press the **UP/DOWN ▲▼** buttons to select "Setup", then press the **ENTER** button.

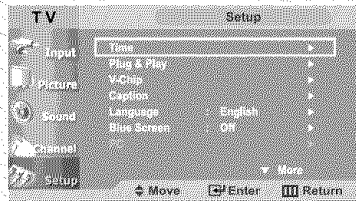

2

Press the **UP/DOWN ▲▼** buttons to select "Melody", then press the **ENTER** button.

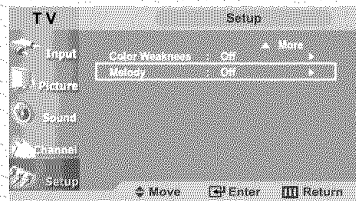

3

Press the **UP/DOWN ▲▼** buttons to select "Off" or "On".

Press the **EXIT** button to exit.

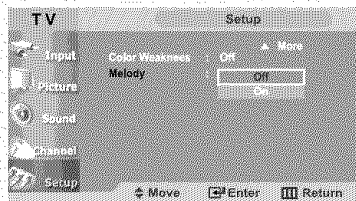

Chapter Five

PC DISPLAY

Using Your TV as a Computer (PC) Display

How to Set up Your PC Software (Windows only)

The Windows display-settings for a typical computer are shown below. However, the actual screens on your PC will probably look different, depending upon your particular version of Windows and your particular video card. Even if your actual screens look different, the same, basic set-up information will apply in most cases. (If not, contact your computer manufacturer or Samsung Dealer).



First, click on "Settings" on the Windows start menu.

While "Settings" is highlighted, move the cursor so that "Control Panel" is highlighted.

When the control panel screen appears, click on "Display" and a display dialog-box will appear.

Navigate to the "settings" tab on the display dialog-box.

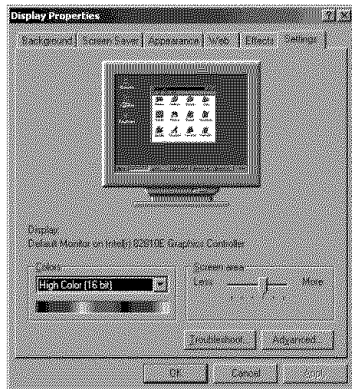
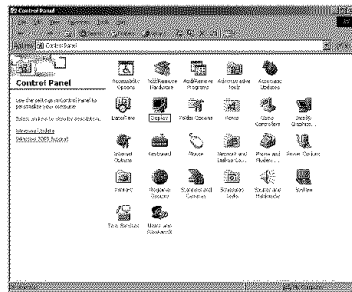

The two key variables that apply the TV-PC interface are "resolution" and "colors." The correct settings for these two variables are:

* Size
(sometimes called "resolution"):
1280 x 768 pixels

If a vertical-frequency option exists on your display settings dialog box, the correct value is "60" or "60 Hz". Otherwise, just click "OK" and exit the dialog box.

* See "Display Modes" on page 87.

How to Auto Adjust

Use the Auto Adjust function to have the TV set automatically adjust the video signals the monitor receives. The function also automatically fine-tunes the settings and adjusts the frequency values and positions.

Press the PC button on the remote control to select the PC mode.

1

Press the **MENU** button to display the menu.

Press the **UP/DOWN ▲▼** buttons to select "Setup", then press the **ENTER** button.

Press the **UP/DOWN ▲▼** buttons to select "PC", then press the **ENTER** button.



2

Press the **UP/DOWN ▲▼** buttons to select "Auto Adjust", then press the **ENTER** button.

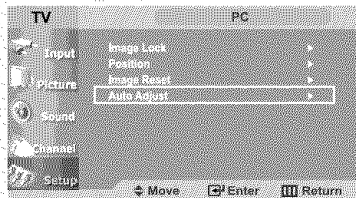

Adjusting the Screen Quality

The purpose of the picture quality adjustment is to remove or reduce picture noise. If the noise is not removed by fine tuning alone, then do the frequency adjustments to the utmost and fine tune again. After the noise has been reduced, re-adjust the picture so that it is aligned on the center of screen.

Press the **PC** button on the remote control to select the **PC** mode.

Note:This function does not work in **DVI-Digital** mode.

1

Press the **MENU** button to display the menu.

Press the **UP/DOWN ▲▼** buttons to select "Setup", then press the **ENTER** button.

Press the **UP/DOWN ▲▼** buttons to select "PC" then press the **ENTER** button.

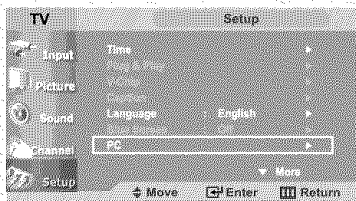

2

Press the **ENTER** button to select "Image Lock".

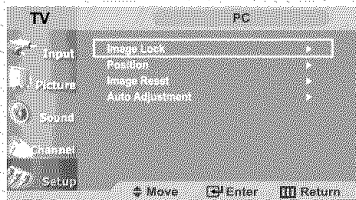

3

Press the **UP/DOWN ▲▼** buttons to select "Coarse" or "Fine", then press the **ENTER** button.

Press the **LEFT/RIGHT ◀▶** buttons to adjust the screen quality, vertical stripes may appear or the picture may be blurry.

Press the **EXIT** button to exit.

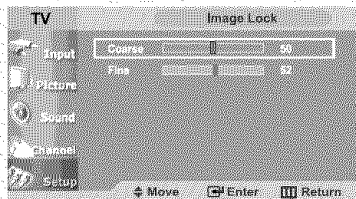

<Adjusting Coarse>



<Adjusting Fine>

Changing the Screen Position

Press the PC button on the remote control to select the PC mode.

1

Press the **MENU** button to display the menu.

Press the **UP/DOWN ▲▼** buttons to select "Setup", then press the **ENTER** button.



2

Press the **UP/DOWN ▲▼** buttons to select "PC", then press the **ENTER** button.

Press the **UP/DOWN ▲▼** buttons to select "Position", then press the **ENTER** button.

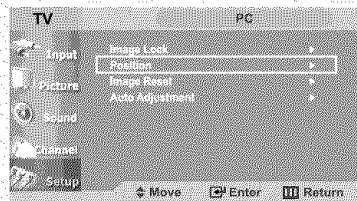
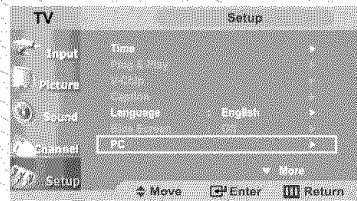

3

Press the **UP/DOWN ▲▼** buttons to adjust the V-Position.

Press the **LEFT/RIGHT ◀▶** buttons to adjust the H-Position.

Press the **EXIT** button to exit.

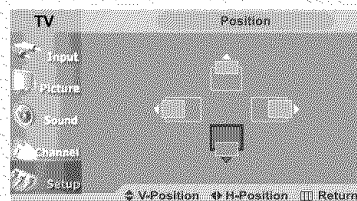
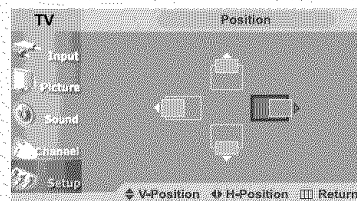

To Initialize the Screen Position or Color Settings

Press the PC button on the remote control to select the PC mode.

1

Press the **MENU** button to display the menu.

Press the **UP/DOWN ▲▼** buttons to select "Setup", then press the **ENTER** button.

Press the **UP/DOWN ▲▼** buttons to select "PC", then press the **ENTER** button.



2

Press the **UP/DOWN ▲▼** buttons to select "Image Reset", then press the **ENTER** button.

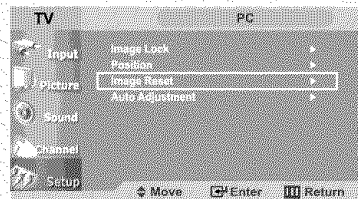

Press the **EXIT** button to exit.



Chapter Six

TROUBLESHOOTING

If the TV seems to have a problem, first try this list of possible problems and solutions. If none of these troubleshooting tips apply, call your nearest Samsung service center.

Identifying Problems

Problem	Possible Solution
Poor picture	Try another channel. Adjust the antenna. Check all wire connections.
Poor sound quality.	Try another channel. Adjust the antenna.
No picture or sound.	Try another channel. Press the TV/VIDEO button. Make sure the TV is plugged in. Check the antenna connections.
No sound or sound is too low at maximum volume.	First, check the volume of units connected to your TV (digital broadcasting receiver, DTV, DVD, cable broadcasting receiver, VCR, etc.). Then, adjust the TV volume accordingly.
Picture rolls vertically.	Check all wire connections.
The TV operates erratically.	Unplug the TV for 30 seconds, then try operating it again.
The TV won't turn on.	Make sure the wall outlet is working.
Remote control malfunctions	Replace the remote control batteries. Clean the upper edge of the remote control (transmission window). Check the battery terminals.
"Check Signal Cable" message.	Ensure that the signal cable is firmly connected to the PC sources.

Problem	Possible Solution
“Not Supported Mode!” message.	<ul style="list-style-type: none"> ■ Check the maximum resolution and the frequency of the Video Adapter. ■ Compare these values with the data in the Display Modes Timing Chart.
The image is too light or too dark.	<ul style="list-style-type: none"> ■ Adjust the Brightness and Contrast. ■ Adjust the Fine tuning.
Horizontal bars appear to flicker, jitter or shimmer on the image.	<ul style="list-style-type: none"> ■ Adjust the Coarse tuning and then adjust the Fine tuning.
Vertical bars appear to flicker, jitter or shimmer on the image.	<ul style="list-style-type: none"> ■ Adjust the Coarse tuning and then adjust the Fine tuning.
Screen is black and power indicator light blinks steadily.	<ul style="list-style-type: none"> ■ On your computer check: Power , Signal Cable(24-pin DVI) ■ The TV is using its power management system. ■ Move the computer's mouse or press a key on the keyboard.
Image is not stable and may appear to vibrate.	<ul style="list-style-type: none"> ■ If the setting is not correct, use your computer utility program to change the display settings. ■ NOTE: Your TV supports multiscan display functions within the following frequency domain: <ul style="list-style-type: none"> • Horizontal frequency: 30 kHz ~ 61 kHz • Vertical frequency: 56 Hz ~ 75 Hz • Maximum refresh rate: 1280 x 768 @ 60 Hz
Image is not centered on the screen.	<ul style="list-style-type: none"> ■ Adjust the horizontal and vertical position. ■ The screen position must be adjusted on the output source(i.e.. STB) with a digital signal.
If a still image is displayed for an extended period of time, residual images or blurring may appear.	<ul style="list-style-type: none"> ■ When you need to leave the monitor unused for an extended period of time, adjust the settings so that the monitor automatically goes into energy saving mode or activates the screen saver to display moving images.

Problem	Possible Solution
The Anynet does not function.	<ul style="list-style-type: none"> ■ Check to see if the device is an Anynet device. The Anynet System supports only Anynet-enabled devices. ■ The Anynet System supports up to one device from the Receiver product group and two devices from the DVD product group. Check to see if the Anynet devices are plugged in properly.
The remote control doesn't work.	<ul style="list-style-type: none"> ■ Check to see if the angle and the distance between the remote control and the device are appropriate and if there is any obstacle in the path between the remote control and the device. ■ Replace the remote control batteries. ■ Check to see if you selected the correct device (TV, DVD, VCR, cable or STB) to control using the [Mode] button. ■ Check to see if the remote control mode matches the input mode. ■ See if you pressed the correct function button. ■ Be sure to note that there are buttons on the remote control that are not available depending on the device mode.
I would like to start the Anynet.	<ul style="list-style-type: none"> ■ See if the Anynet devices are connected to the TV according to the connection diagram and make sure the proper Anynet Connection Setting has been selected. ■ Press the [Mode] button on the TV remote control to set the mode to TV. ■ Then, press the [Anynet] button to bring up the Anynet menu and choose a what AV device you want to see.
I would like to exit the Anynet.	<ul style="list-style-type: none"> ■ Press [TV/Input] button on the TV remote control. ■ Turn the TV off.
I would like to bring up the TV menu while using the Anynet.	<ul style="list-style-type: none"> ■ If you press the [Menu] button while you are using the Anynet Watch function, it can bring up the DVD menu, VCR menu or the Set-Top Box menu. ■ To view the TV menu, go to Anynet "Settings" and select "TV Menu." ■ Press the Menu button on the front of the TV.

Problem	Possible Solution
I would like to turn the Anynet device off.	<ul style="list-style-type: none"> ■ Press the [Power] button on the TV remote control while using the Anynet Watch function and the Anynet device that was automatically turned on by the Anynet System is turned off. (However, you cannot turn the device off in this manner if it was turned on manually.) ■ Press the Input button while using the Anynet Watch function and all Anynet devices except for the TV are turned off. ■ Select a different Watch menu item while using the Anynet Watch function and the Anynet device you have been watching is turned off.
Can't use Anynet.	<ul style="list-style-type: none"> ■ To change the remote control to Anynet mode, be sure to press the "Mode" button on the TV remote control to change to TV mode first.
Can't use (name of device).	<ul style="list-style-type: none"> ■ Check to see if the power code of the device is plugged in properly. ■ Check to see if the Anynet devices are connected properly according to the instructions.
Can't use in the current mode.	<ul style="list-style-type: none"> ■ The key is not supported in the current mode.
Anynet operating ...	<ul style="list-style-type: none"> ■ You cannot use the keys on the remote control while the Anynet settings are being adjusted or during a Watch TV or Watch STB. ■ Try the keys again after the application of the new Anynet settings or the mode switch is complete.
You cannot turn the device that is currently recording off.	<ul style="list-style-type: none"> ■ The device that is currently recording is not turned off when you press the power button. ■ To turn a device that is currently recording off, use the remote control of such device or the button on the front of the device.

Problem	Possible Solution
<p>The screenshot shows an Anynet error message: "Unable to find Anynet devices. Only Anynet devices are available to run." Below the message are buttons for "To Anynet", "Exit", "Move", and "Select".</p>	<p>See if there are Anynet devices connected. The Anynet System supports only Anynet devices. Check to see if the Anynet devices connected are plugged in properly. Check to see if the Anynet devices are connected properly according to the Anynet connection diagram. (Make sure that the Output port of the TV is connected to the Input port of the Anynet device and the Output port of the Anynet device is connected to the Input port of the other Anynet device.)</p>
<p>The screenshot shows an Anynet error message: "DVD/VCR combo video signal contents may not be able to run on this TV. Please set up the system." Below the message are buttons for "To Anynet", "Exit", "Move", and "Select".</p>	<p>Connect the video cable of the device to the TV according to the connection diagram. Then go to [Settings] in the Anynet menu and select [Basic Connection Setting] or [Advanced Connection Setting]. Check to see if the video cable is damaged. Then go to [Settings] in the Anynet menu and select [Basic Connection Setting] or [Advanced Connection Setting]. If the video cables are connected properly, set the input source to the Anynet device (Combo) using the Input button on the remote control and see if the display works properly. If it does not work properly, see Troubleshooting for such device (Combo).</p>
<p>The screenshot shows an Anynet error message: "DVD/VCR combo is unable to run. Set up the following the instructions." Below the message are buttons for "To Anynet", "Exit", "Move", and "Select".</p>	<p>Check to see if the device is plugged in properly. Then go to [Settings] in the Anynet menu and select [Basic Connection Setting] or [Advanced Connection Setting]. Check to see if the cables are connected properly according to the instructions. Then go to [Settings] in the Anynet menu and select [Basic Connection Setting] or [Advanced Connection Setting]. If the device is connected properly, turn the TV off and go to [Settings] in the Anynet menu and select [Basic Connection Setting] or [Advanced Connection Setting].</p>
<p>The screenshot shows an Anynet error message: "Identical DVD/VCR combo selected. Set up the following the instructions." Below the message are buttons for "To Anynet", "Exit", "Move", and "Select".</p>	<p>Check to see if two or more of the same type of device are connected and if so, remove all such devices but one. The Anynet System does not function when more than one of the same type of device is connected.</p>
<p>The screenshot shows an Anynet error message: "Excess number of devices found. Set up the following the instructions." Below the message are buttons for "To Anynet", "Exit", "Move", and "Select".</p>	<p>Check the number of the Anynet devices connected and connect the devices properly according to the connection diagram. Then go to [Settings] in the Anynet menu and select [Basic Connection Setting] or [Advanced Connection Setting]. (The Anynet System supports up to one device from the Receiver product group and two devices from the DVD product group.)</p>

Problem

Possible Solution

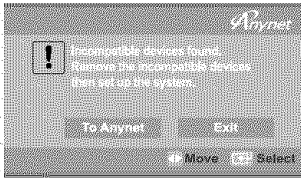

Make sure that the devices connected support the Anynet. Remove devices from the new Anynet product groups that are not supported by the Anynet version currently running on your TV. Then go to [Settings] in the Anynet menu and select [Basic Connection Setting] or [Advanced Connection Setting].

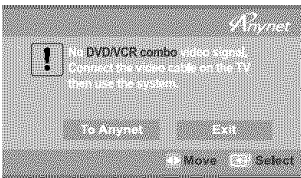

Connect the video cable of the device to the TV according to the connection diagram before use. Check to see if the video cable is connected to the same place now as it was at the time you selected the Connection Setting. To re-connect the video cable to a different location, re-select the Connection Setting and choose a device to watch. If the TV is in VCR mode, see if the tape has any noise. The device may not be able to detect the video signal if the noise level is high.

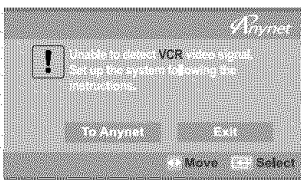

Connect the video cables of the VCR properly according to the connection diagram. Then go to [Anynet Settings] in the Anynet menu and select [Basic Connection Setting] or [Advanced Connection Setting]. (After selecting the connection settings, make sure that the Anynet device is selected for VCR viewing in the pop-up window.) If the cables are connected properly, see if the video cable of the VCR is damaged.



Check to see if the power cord of the device is plugged in operly. Check to see if the Anynet devices are connected properly according to the instructions.

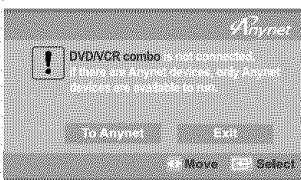

See if there are Anynet devices connected. The Anynet System supports only the Anynet devices. If you have Anynet devices to connect, connect the devices properly according to the connection diagram. Then go to [Anynet Settings] in the Anynet menu and select [Basic Connection Setting] or [Advanced Connection Setting].



You cannot use the "Play DVD" or "Play VCR" functions while the device is recording. Stop the recording before you use the "Play" functions.

TROUBLESHOOTING

Glossary	Content
The Anynet System	A system that allows controlling Samsung AV devices from the TV.
Watch TV Broadcast	When selected, this Anynet menu item automatically executes the steps involved in watching TV broadcasts on TV.
Play DVD	When selected, this Anynet menu item automatically executes the steps involved in watching DVD titles on TV.
Watch Satellite	When selected, this Anynet menu item automatically executes the steps involved in watching satellite programs on TV.
Switch to TV Remote Control Mode	Select this menu item to switch the mode of the remote control to TV mode.
Basic Connection Setting	A menu item to configure the system setting before using the Anynet System. (In setting up the Anynet System, use the connectors provided with the purchase of the products or buy separate video connectors to connect the devices.)
Advanced Connection Setting	A menu item to configure the system setting before using the Anynet System. (Choose this menu item when you use optical connectors to connect the Anynet devices.)
Select Audio Input Port	Use this menu item to select the port on the TV or the Receiver to which you connected the audio input port of the device during the Anynet system configuration.
RS232C cable	Used to transmit signals to the TV and other peripheral devices.
OPTICAL	Optical digital output port. The simple connection helps protect the device from electric interference, reducing the loss of electricity. It also allows accurate sound reproduction.
COAXIAL	Coaxial digital output port. Allows high capacity data transmission with minimum data loss and the resulting strong noise reduction capability allows accurate sound reproduction.
Subwoofer	Complements the low-sound reproduction capability of the front speakers.

Installing the Stand

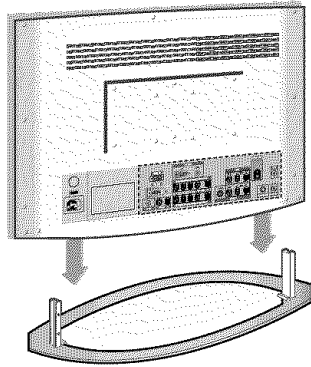

<1>

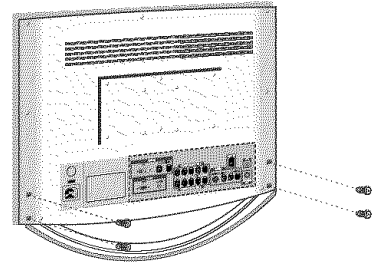

<2>

1

Lower the TV set in the direction of the arrow and fix the stand.

2

Use the four screws to tightly fix the stand.

Maintenance of Your LCD TV

WARNING: To avoid risk of electric shock, do not disassemble the TV cabinet (except for gaining access to the cable connectors as described on Chapter 2). Users cannot service the TV. User maintenance is restricted to cleaning as explained below:

Unplug the LCD TV from the power outlet before cleaning.

- To clean your flat panel display screen, lightly dampen a soft, clean cloth with water or mild detergent. If possible, use a special screen cleaning tissue or solution suitable for the antistatic coating.
- To clean the LCD TV cabinet, use a cloth lightly dampened with a mild detergent.
- Never use flammable cleaning material to clean your LCD TV or any other electrical apparatus.

Wall Mount Installation Guide

1. This Wall Mount is designed for Samsung's 32" LCD TV models and is sold separately.
2. Have a Samsung dealer install the Wall Mount.
3. Two or more people are required for installation.
4. Samsung is not responsible for any product damage or any injury caused by installation at the customer's discretion.

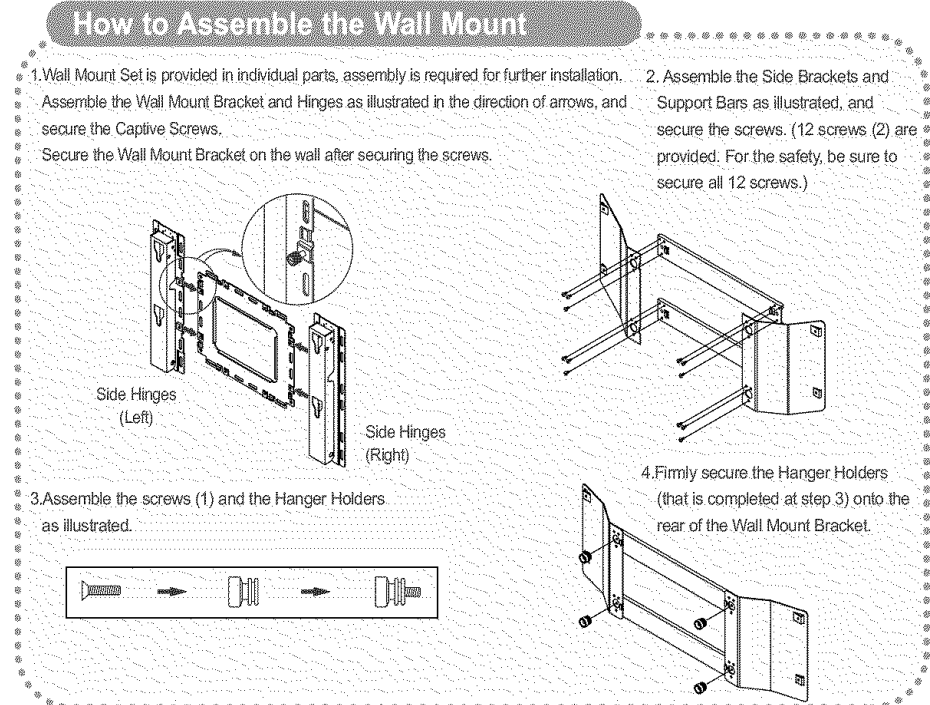
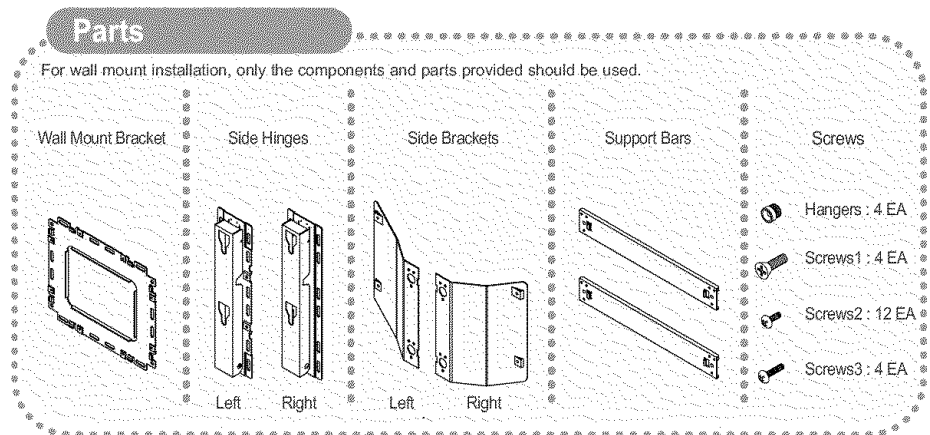

How to Secure the LCD TV to the Wall Mount

1. Attach the assembled left/right Side Brackets onto the rear side of the TV set and secure the screws(3).
2. Insert 4 Hangers into the grooves of the Wall Mount Bracket and then push the Hangers downwards to mount the TV set firmly. Be sure that the Hangers are firmly fixed onto the Wall Mount Bracket after mounting the TV set.

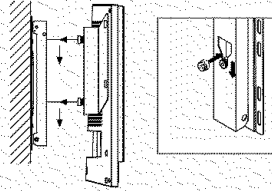
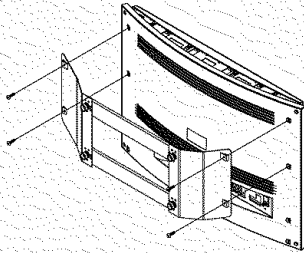

How to Adjust the Angle of the Wall Mount

Before the installation of the Wall Mount Bracket onto the wall, adjust the angle to 0°.

1. Hold onto the topside of the TV set and pull it in direction of arrows to adjust the angle. Hold onto the middle of the TV's topside for the angle adjustment.
2. The angle can be adjusted by 0 ~ 20°.

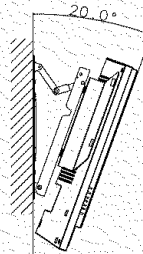
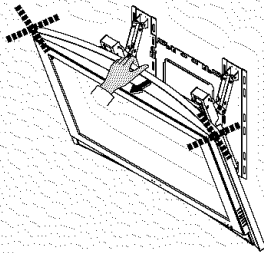

Installation Dimensions

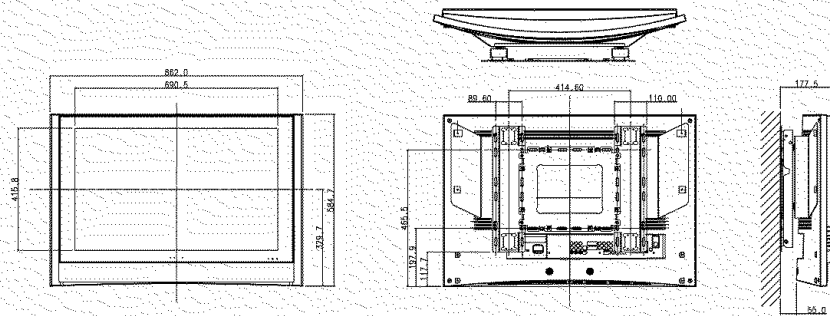

Cleaning and Maintaining Your TV

With proper care, your TV unit will give you many years of service. Please follow these guidelines to get the maximum performance from your TV.

Placement

- Do not place the TV near extremely hot, cold, humid or dusty places.
- Do not place the TV near appliances with electric motors that create magnetic fields, such as vacuum cleaners.
- Keep the ventilation openings clear; do not place the TV on a soft surface, such as cloth or paper.
- Place the TV in a vertical position only.

Liquids

- Do not handle liquids near or on the TV.
Liquids that spill into it can cause serious damage.

Cabinet

- Never open the cabinet or touch the parts inside.
- Wipe your TV with a clean, dry cloth.
Never use water, cleaning fluids, wax, or chemicals.
- Do not put heavy objects on top of the cabinet.

Temperature

- If your TV is suddenly moved from a cold to a warm place, unplug the power cord, and allow at least two hours for moisture that may have formed inside the unit to dry completely.

Using Your TV in Another Country

If you plan to take your TV with you to a foreign country, please be aware of the different television systems that are in use around the world. A TV designed for one system may not work properly with another system due to differences in the TV channel frequencies.

Specifications

Model Name		LT-P326W
Panel	Size Display Size (HxV) Type Pixel Pitch Viewing Angle	32.0" Diagonal 27.06 x 16.24 inches (687.36 x 412.42 mm) a-si TFT active matrix 0.537 (H) x 0.537 (V) mm 170/170 (H/V)
*Frequency	Horizontal Vertical Display Color	30 ~ 61 kHz 56 ~ 75 Hz 16,777,216 colors
Display Resolution	Maximum Mode	1280 x 768 @ 60 Hz
Input Signal	Sync Signal Video Signal	H/V Separate, TTL, P. or N. 0.7 Vp-p @ 75 ohm
Video	Color System Video System	NTSC CVBS, S-VHS
Component	Video In Audio In	1.0 Vp-p @ 75 ohm 500mVrms
Power Supply	Input	AC 120V~ 60 Hz
Power Consumption	Normal Power Saving	180 W < 5.0 W
Dimensions / Weight	Unit (WxDxH): body With Stand	33.93 x 4.95 x 23.01 inches (862.0 x 125.8 x 584.7 mm) 33.93 x 12.91 x 23.86 inches / 50.70 lbs (862.0 x 328.0 x 606.2 mm / 23.0 kg)
Environmental Considerations	Operating Temperature Operating Humidity Storage Temperature Storage Humidity	50 °F to 104 °F (10 °C to 40 °C) 10% to 80%, non-condensing -4 °F to 113 °F (-20 °C to 45 °C) 5% to 95%, non-condensing
Audio Characteristics	Audio Input 1 Audio Input 2 Headphone Out Frequency Response	RCA Jac (R, L), 0.5Vrms (-9dB) 3.5ø Stereo Jack, 0.5Vrms (-9dB) Max. 10mW Output (3.5ø Stereo Jack 32Ω) RF: 80Hz ~ 15kHz (at- 3dB) A/V: 80Hz ~ 20kHz (at - 3dB)

* Referring to Display Modes, page 87.

Display Modes

If the signal from the system equals the standard signal mode, the screen is adjusted automatically. If the signal from the system doesn't equal the standard signal mode, adjust the mode by referring to your Videocard user guide; otherwise there may be no video. For the display modes listed below, the screen image has been optimized during manufacture.

Mode	Resolution	Horizontal Frequency (kHz)	Vertical Frequency (Hz)	Pixel Clock Frequency (MHz)	Sync Polarity (H/V)
Macintosh	640 X 480	35.000	66.667	30.240	- / -
	832 X 624	49.726	74.551	49.500	+ / +
IBM	640 X 480	31.496	59.940	25.175	- / -
	720 X 400	31.469	70.087	28.322	- / -
VESA	640 X 480	37.861	72.809	31.500	- / -
	640 X 480	37.500	75.000	31.500	- / -
	800 X 600	37.879	60.317	40.000	+ / +
	800 X 600	48.077	72.188	50.000	+ / +
	800 X 600	46.875	75.000	49.500	+ / +
	1024 X 768	48.363	60.004	65.000	- / -
	1024 X 768	56.476	70.069	75.000	- / -
	1024 X 768	60.023	75.029	78.750	+ / +
GTF	1280 X 768	47.700	60.000	80.136	- / +

