

SAMSUNG

LTP227W

TFT-LCD TELEVISION

**Owner's
Instructions**

Chapter 1: Your New TV

List of Features	1
List of Parts	1
Familiarizing Yourself with Your New TV	2
Top Panel Buttons	2
Rear Panel Jacks	3
Remote Control	4
Installing Batteries in the Remote Control	6
The remote control doesn't work	6

Chapter 2: Installation

Connecting VHF and UHF Antennas	7
Antennas with 300-ohm Flat Twin Leads	7
Antennas with 75-ohm Round Leads	8
Separate VHF and UHF Antennas	8
Connecting Cable TV	8
Cable without a Cable Box	8
Connecting to a Cable Box that Descrambles All Channels	9
Connecting to a Cable Box that Descrambles Some Channels	9
Connecting a VCR	11
Connecting an S-VHS VCR	12
Connecting a DVD Player	13
Connecting a PC	14

Chapter 3: Special Features

Turning the TV On and Off	15
Changing Channels	15
Using the Channel Buttons	15
Using the Pre-CH Button to select the Previous Channel	15
Adjusting the Volume	15
Using Mute	15
Viewing the Display	16
Viewing the Menus	16

Chapter 4: Operation

Plug & Play Feature	17
Memorizing the Channels	18
Selecting the Video Signal-source	18
Storing Channels in Memory (Automatic Method)	19
To check the channels stored in memory	19
To select channels over 100	19
ADD and DEL Channels (Manual Method)	20
Labeling Channel	20
To select the Favorite Channels	21
To select TV/Video	21
To Edit the Input Source Name	22
Using Automatic Picture Settings	23
Customizing the Picture	24
Using Automatic Sound Settings	25
Customizing the Sound	26
Selecting a Menu Language	27
Setting the Blue Screen Mode	28

CONTENTS

Fine Tuning Channels	29
Viewing Picture-in-Picture	30
Activating Picture-in-Picture	30
PIP Settings	30
Changing the PIP Channel	31
Changing the Size of the PIP Window	31
Changing the Screen Size	32
Freezing the Picture	32
Adjusting the Color Tone	33
Setting the DNIe	34
For automatic volume control	35
To select the WOW option	36
Special Sound Options	37
Selecting the Main or Sub Sound	38
Adjusting the Headphone Sound	39
Setting the Clock	40
Setting the On/Off Timer	41
Setting the Sleep Timer	43
Viewing Closed Captions	44
Using the V-Chip	45
Setting Up Your Personal ID Number (PIN)	45
How to Enable/Disable the V-Chip	46
How to Set up Restrictions Using the 'TV guidelines'	46
How to Set up Restrictions using the MPAA Ratings:	
G, PG, PG-13, R, NC-17, X	48
How to Reset the TV after the V-Chip	
Blocks a Channel ('Emergency Escape')	49
Chapter 5: PC Display	
Using Your TV as a Computer (PC) Display	50
How to Set up Your PC Software (Windows only)	50
Adjusting the Screen Quality	51
Changing the Screen Position	52
To Initialize the Screen Position or Color Settings	53
PC(Digital/Analog) Signal Select	54
How to Auto Adjust	55
Using Automatic Picture Settings	56
Customizing the Picture	57
Adjusting the Color Tone	58
Chapter 6: Troubleshooting	
Identifying Problems	59
Appendix	
How to connect the cables and stand base	61
Using the Anti-Theft Kensington Lock	62
Retractable Stand	63
Cleaning and Maintaining Your TV	64
Using Your TV in Another Country	64
Specifications	65
Display Modes	66
Setting Up Your Remote Control	67
Remote Control Codes	70

Chapter One

YOUR NEW TV

List of Features

Your TV was designed with the latest technology.

This TV is a high-performance unit that includes the following special features:

- Easy-to-use remote control
- Easy-to-use on-screen menu system
- Automatic timer to turn the TV on and off
- Adjustable picture and sound settings that can be stored in the TV's memory
- Automatic channel tuning for up to 181 channels.(Air : 68 , STD : 113)
- A special filter to reduce or eliminate reception problems
- Fine tuning control for the sharpest picture possible
- A built-in multi-channel sound decoder for stereo and bilingual listening
- Built-in, dual channel speakers
- Headphone jack for private listening
- 16:9 letter box format available depending upon source

List of Parts

Please make sure the following items are included with your LCD TV.

If any items are missing, contact your dealer.

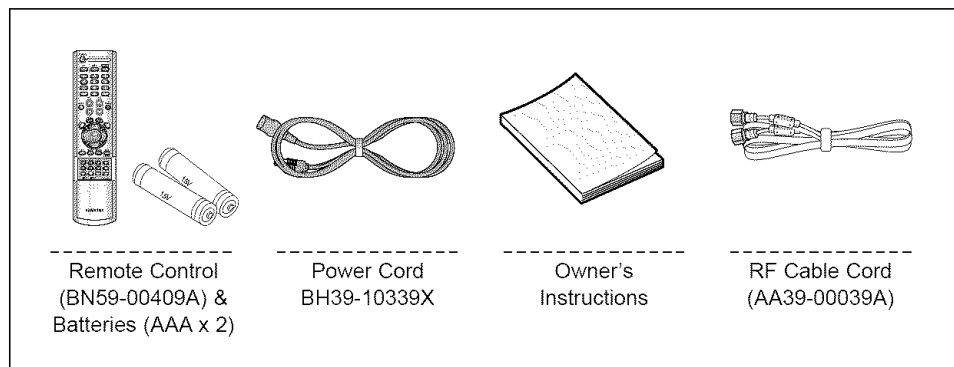



Familiarizing Yourself with Your New TV

Top Panel Buttons

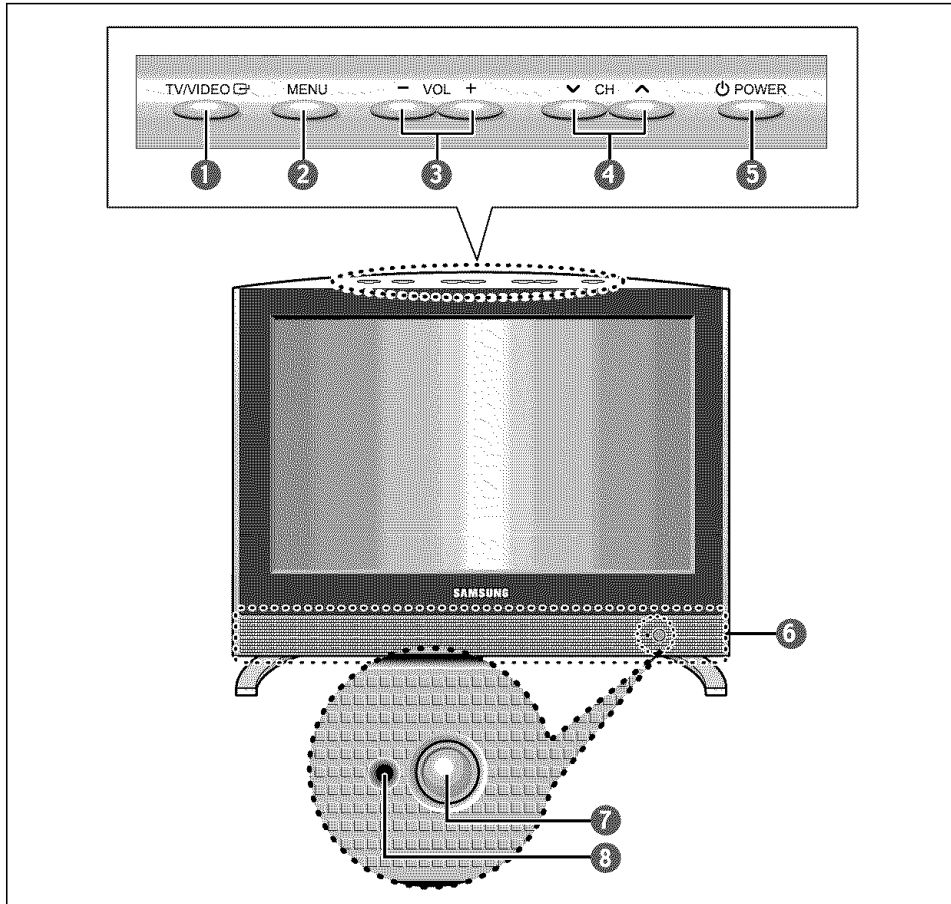
The buttons on the top panel control your TV's basic features, including the on-screen menu. To use the more advanced features, you must use the remote control.



- | | |
|--|---|
| <p>1 TV/VIDEO  (See Page 21)
Displays a menu of all of the available input sources (TV, VIDEO, S-VIDEO, Component 1, Component 2, PC/DVI).</p> <p>▶ You can also use the TV/Video() buttons on the control panel of the TV to make selections.</p> | <p>4 ∇ CH ▲
Press to change channels.
Also press to highlight various items on the on-screen menu.</p> |
| <p>2 MENU
Press to see an on-screen menu of your TV's features.</p> | <p>5 ⏻ POWER
Press to turn the TV on and off.</p> |
| <p>3 - VOL +
Press to increase or decrease the volume.</p> | <p>6 SPEAKER</p> <p>7 REMOTE CONTROL SENSOR
Aim the remote control towards this spot on the TV.</p> |
| | <p>8 POWER INDICATOR
Lights up when you turn the power off.</p> |

YOUR NEW TV

Rear Panel Jacks

Use the rear panel jacks to connect an A/V component that will be connected continuously, such as a VCR or a DVD player.

For more information on connecting equipment, see pages 7-14.

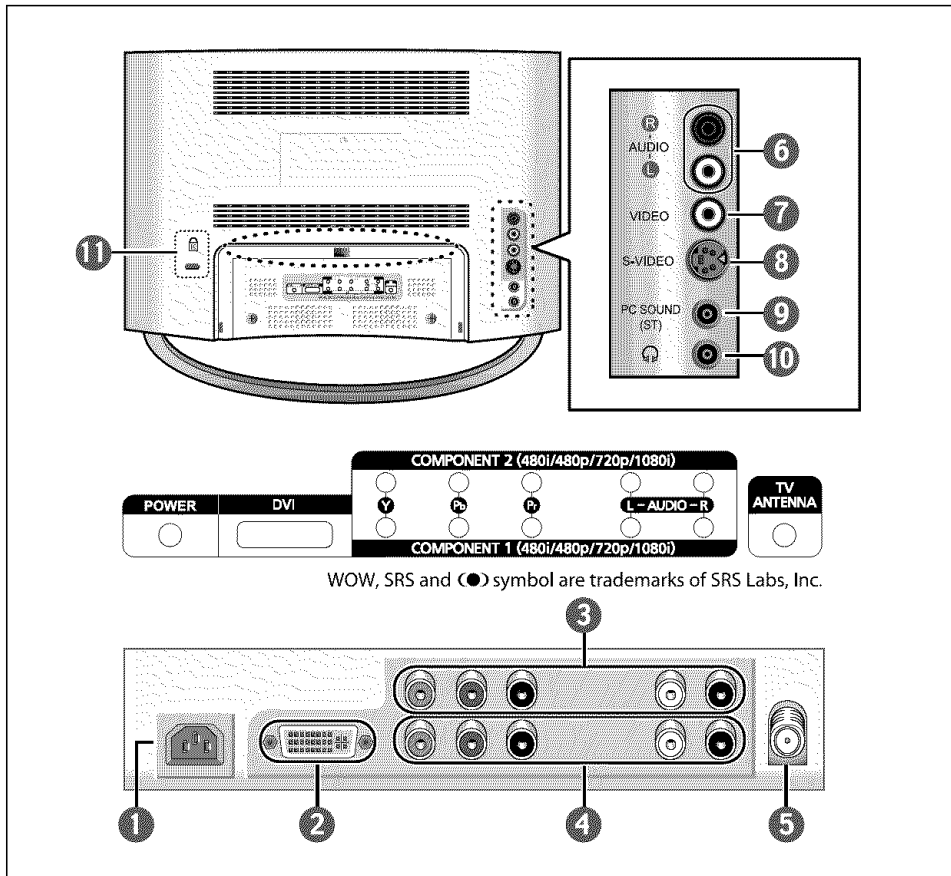

- 1 POWER INPUT**
- 2 PC VIDEO INPUT**
Connect to the video output port on your PC.
- 3 COMPONENT 2**
Connect a component video/audio.
- 4 COMPONENT 1**
Connect a component video/audio.
- 5 TV ANTENNA**
Connects to an antenna or to a cable TV system.
- 6 AUDIO INPUT**
Connect an audio signal(L/R) from a camcorder or VCR.
- 7 VIDEO INPUT**
Connect a video signal from a camcorder or VCR.
- 8 SUPER VIDEO INPUT**
Connect an S-Video signal from a camcorder or VCR.
- 9 PC SOUND INPUT**
- 10 HEADPHONE JACK**
Connect a set of external headphones to this jack for private listening.
- 11 KENSINGTON LOCK**
(See page 63)

YOUR NEW TV

Remote Control

Frequently Used Buttons

You can use the remote control up to a distance of about 23 feet from the TV.
When using the remote, always point it directly at the TV.

- 1 POWER**
Turns the TV on and off.
(See Page 15)
- 2 PC MODE**
Press to switch to the PC mode.
- 3 P.SIZE**
Press to change the screen size.
- 4 MUTE**
Press to temporarily cut off the sound. (See Page 15)
- 5 MENU**
Displays the main on-screen menu.

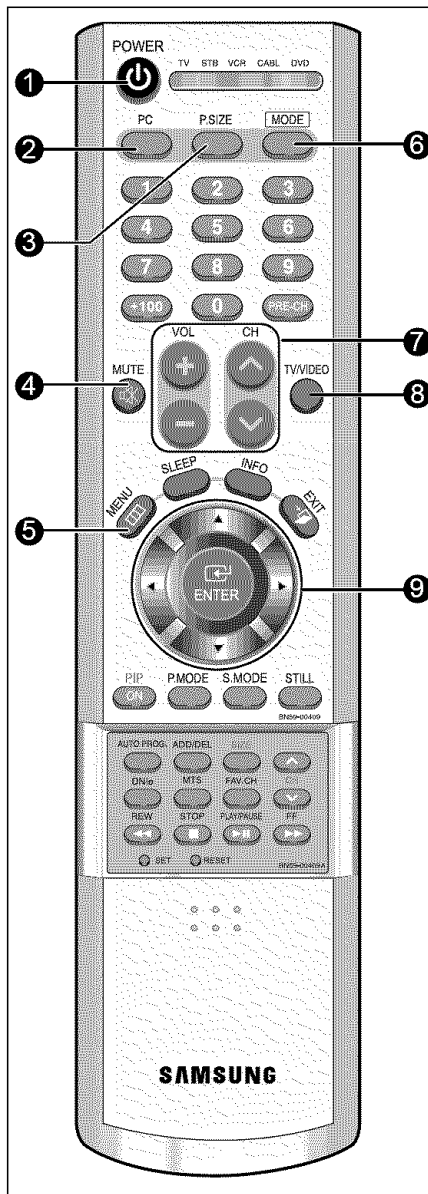

- 6 MODE**
Selects a target device to controlled by the samsung remote control (TV, STB, VCR, CABLE, DVD)
- 7 CH ^ and CH v (Channel UP/Down)**
Press CH ^ or CH v to change channels.
- VOL + and VOL -**
Press to increase or decrease the volume.
- 8 TV/VIDEO**
Press to display all of the available video sources.
- 9 JOYSTICK**
Use to select on-screen menu items and change menu values. (The remote control will only function with VCR or DVD units that are compatible with the LCD TV.)

YOUR NEW TV

Convenient Buttons

You can use the remote control up to a distance of about 23 feet from the TV.
When using the remote, always point it directly at the TV.

1 +100

Press to select channels over 100.
For example, to select channel 121, press "+100", then press "2" and "1".
(See Page 19)

2 Sleep Timer

Press to select a time for the TV to turn off automatically. (See Page 43)

3 P.MODE

Adjusts the TV picture by selecting one of the preset factory settings.
(See Page 23)

S.MODE

Adjust the TV sound by selecting one of the preset factory settings (or select your personal, customized sound settings). (See Page 25)

STILL

Press to stop the action during a particular scene. Press again to resume normal video. (See Page 32)

4 AUTO PROG.

Press to automatically store selected TV/cable channels.
(See Page 19)

ADD/DEL

Use to store and delete channels to/from memory. (See Page 20)

DNLe

Press to improve the digital video quality.

MTS

(Multi channel Television Stereo)

Press to choose stereo, mono or Separate Audio Program (SAP broadcast). (See Page 37)

FAV.CH

Tunes to the channels in your favorite channel list.

5 VCR/DVD Functions

- Rewind
- Stop
- Play/Pause
- Fast/Forward

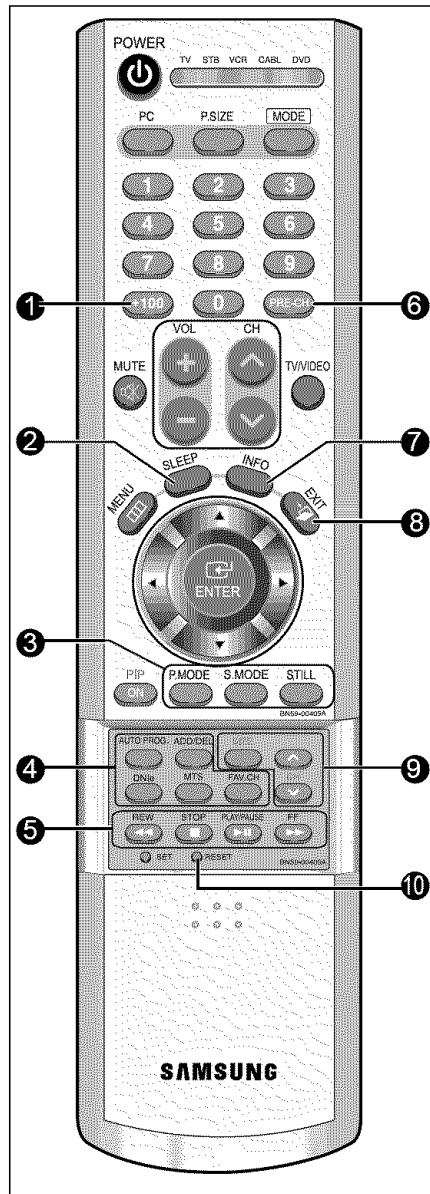

6 PRE-CH

Tunes to the previous channel.
(See Page 15)

7 Info Display

Use to see information on the current broadcast. (See Page 16)

8 EXIT

Press to exit the menu.

9 PIP

See the PIP screen section of this manual. (See Page 30)

SIZE

Press to make the PIP window double, large or small.

^ CH v

Displays the available channels in sequence.
(These buttons change channels in the PIP window only.)

10 RESET

When your remote does not work, change the batteries and press the RESET button for 2-3 seconds before use.

Installing Batteries in the Remote Control

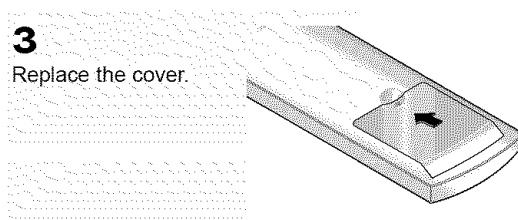
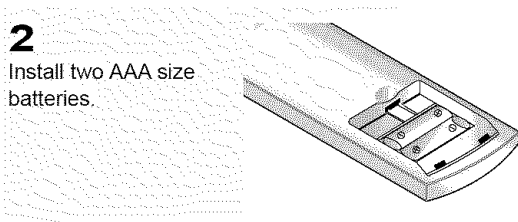
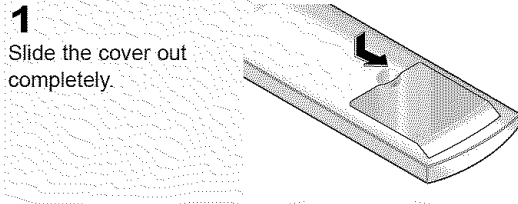

◀ Make sure to match the “+” and “-” ends of the batteries with the diagram inside the compartment.

◀ Remove the batteries and store them in a cool, dry place if you won't be using the remote control for a long time.

The remote control can be used up to about 23 feet from the TV.

(Assuming typical TV usage, the batteries last for about one year.)

The remote control doesn't work!

Check the following:

1. Is the TV power switch on?
2. Are the plus and minus ends of the batteries reversed?
3. Did the batteries run out?
4. Is the power out, or is the power cord unplugged?
5. Is there a special fluorescent light or a neon sign nearby?

Chapter Two

INSTALLATION

Connecting VHF and UHF Antennas

If your antenna has a set of leads that look like this, see “Antennas with 300-ohm Flat Twin Leads” below.

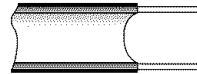

If your antenna has one lead that looks like this, see “Antennas with 75-ohm Round Leads” on page 8.



If you have two antennas, see “Separate VHF and UHF Antennas” on page 8.

Antennas with 300-ohm Flat Twin Leads

If you are using an off-air antenna (such as a roof antenna or “rabbit ears”) that has 300-ohm twin flat leads, follow the directions below.

1

Place the wires from the twin leads under the screws on a 300-75 ohm adaptor (not supplied). Use a screwdriver to tighten the screws.

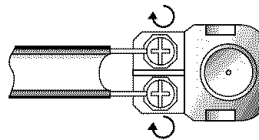

2

Plug the adaptor into the TV ANTENNA terminal on the bottom of the back panel.

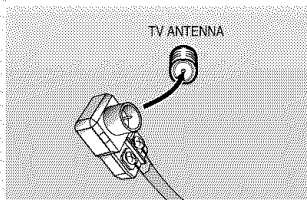

INSTALLATION

Antennas with 75-ohm Round Leads

- 1 Plug the antenna lead into the TV ANTENNA terminal on the bottom of the back panel.

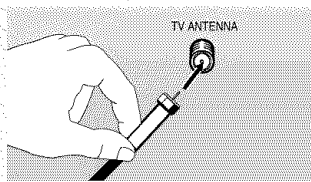

Separate VHF and UHF Antennas

If you have two separate antennas for your TV (one VHF and one UHF), you must combine the two antenna signals before connecting the antennas to the TV. This procedure requires a an optional combiner-adaptor (available at most electronics shops).

- 1 Connect both antenna leads to the combiner.

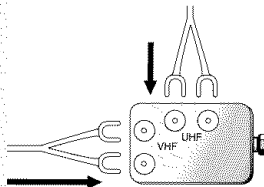

- 2 Plug the combiner into the TV ANTENNA terminal on the bottom of the rear panel.

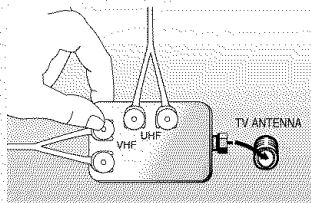

Connecting Cable TV

To connect to a cable TV system, follow the instructions below.

Cable without a Cable Box

- 1 Plug the incoming cable into the TV ANTENNA terminal on back of the TV.

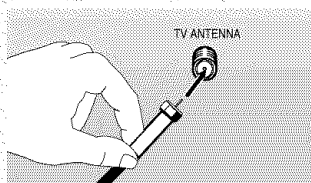

◀ Because this TV is cable-ready, you do not need a cable box to view unscrambled cable channels.

INSTALLATION

Connecting to a Cable Box that Descrambles All Channels

1

Find the cable that is connected to the ANTENNA OUT terminal on your cable box.

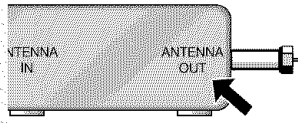

◀ This terminal might be labeled "ANT OUT", "VHF OUT", or simply, "OUT".

2

Connect the other end of this cable to the TV ANTENNA terminal on the back of the TV.

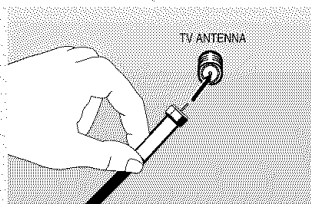

Connecting to a Cable Box that Descrambles Some Channels

If your cable box descrambles only some channels (such as premium channels), follow the instructions below. You will need a two-way splitter, an RF (A/B) switch, and four lengths of coaxial cable. (These items are available at most electronics stores).

1

Find and disconnect the cable that is connected to the ANTENNA IN terminal on your cable box.

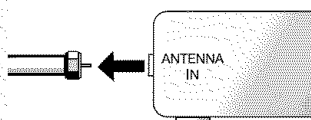

◀ This terminal might be labeled "ANT IN", "VHF IN", or simply, "IN".

2

Connect this cable to a two-way splitter.

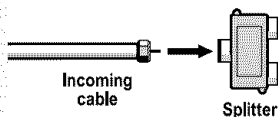

3

Connect a coaxial cable between an OUTPUT terminal on the splitter and the IN terminal on the cable box.

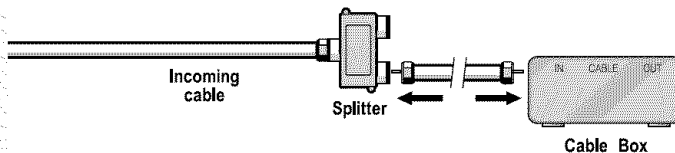

INSTALLATION

4

Connect a coaxial cable between the ANTENNA OUT terminal on the cable box and the B-IN terminal on the A/B switch.

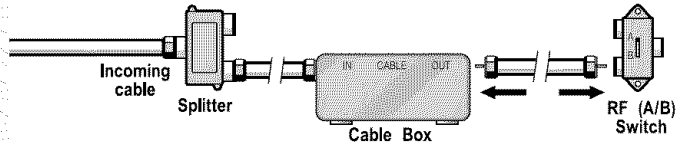

5

Connect another cable between the other OUT terminal on the splitter and the A-IN terminal on the RF (A/B) switch.

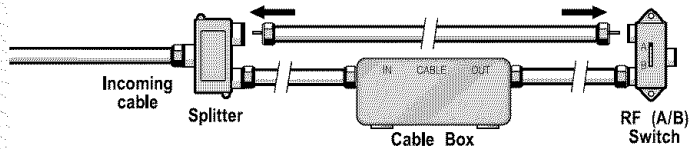

6

Connect the last coaxial cable between the OUT terminal on the RF (A/B) switch and the VHF/UHF terminal on the rear of the TV.

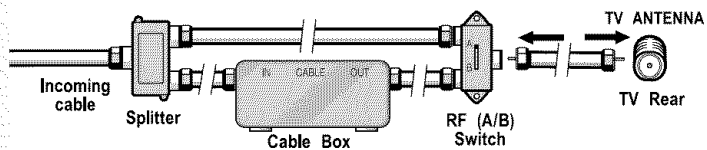

After you've made this connection, set the A/B switch to the "A" position for normal viewing. Set the A/B switch to the "B" position to view scrambled channels. (When you set the A/B switch to "B," you will need to tune your TV to the cable box's output channel, which is usually channel 3 or 4).

INSTALLATION

Connecting a VCR

These instructions assume that you have already connected your TV to an antenna or a cable TV system (according to the instructions on pages 7-9).

Skip step 1 if you have not yet connected to an antenna or a cable system.

1

Unplug the cable or antenna from the back of the TV.

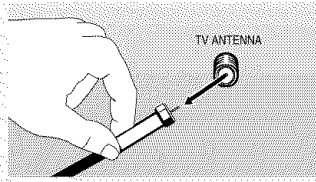

2

Connect the cable or antenna to the ANTENNA IN terminal on the back of the VCR.

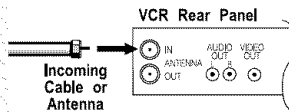

3

Connect a coaxial cable between the ANTENNA OUT terminal on the VCR and the antenna terminal on the TV.

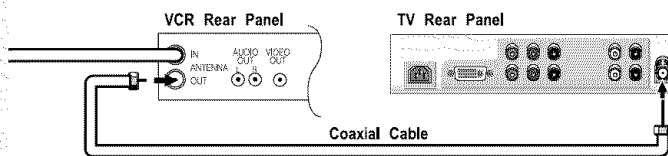

A coaxial cable is usually included with a VCR. (If not, check your local electronics store).

4

Connect a set of audio cables between the AUDIO OUT jacks on the VCR and the AUDIO jacks on the TV.

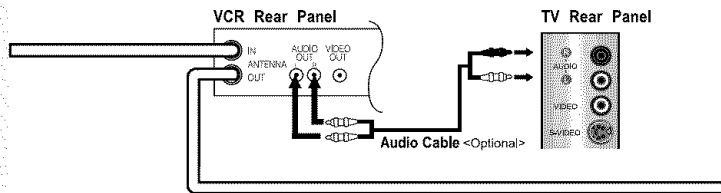

If you have a "mono" (non-stereo) VCR, use the Y-connector (not supplied) to hook up to the left or right audio input jacks of the TV.

If your VCR is stereo, you must connect two cables.

5

Connect a video cable between the VIDEO OUT jack on the VCR and the VIDEO jack on the TV.

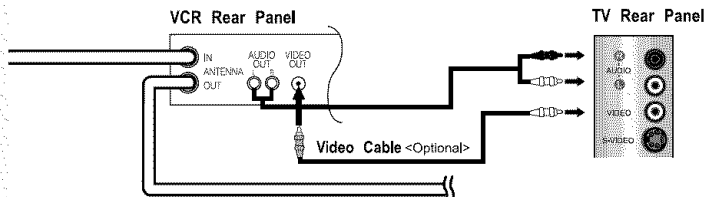

Follow the instructions in "Viewing a VCR or Camcorder Tape" to view your VCR tape.

* Each external input source device has a different back panel configuration.

INSTALLATION

Connecting an S-VHS VCR

Your Samsung TV can be connected to an S-Video signal from an S-VHS VCR. (This connection delivers a better picture as compared to a standard VHS VCR).

1

To begin, follow steps 1–3 in the previous section to connect the antenna or cable to your VCR and your TV.

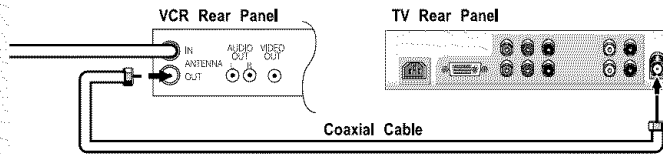

2

Connect a set of audio cables between the AUDIO OUT jacks on the VCR and the AUDIO INPUT jacks on the TV.

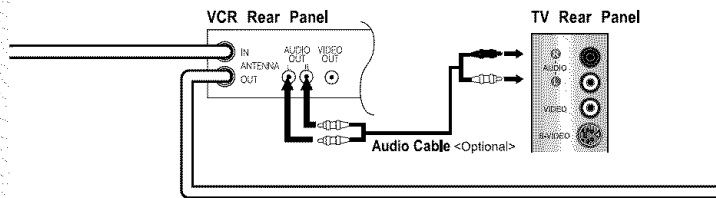

3

Connect an S-video cable between the S-VIDEO OUT jack on the VCR and the S-VIDEO INPUT jack on the TV.

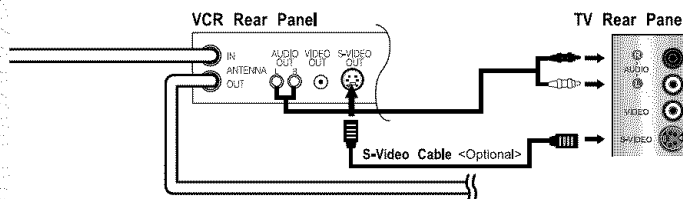

An S-video cable is usually included with an S-VHS VCR. (If not, check your local electronics store).

* Each external input source device has a different back panel configuration.

INSTALLATION

Connecting a DVD Player

The rear panel jacks on your TV make it easy to connect a DVD player to your TV.

1

Connect a set of audio cables between the L, R AUDIO INPUT jacks on the TV and the AUDIO OUT jacks on the DVD player.

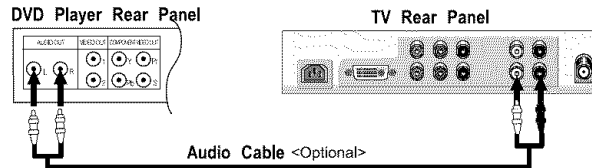

2

Connect a video cable between the COMPONENT1 (Y, Pb, Pr) jacks on the TV and the Y, Pb, Pr jacks on the DVD player.

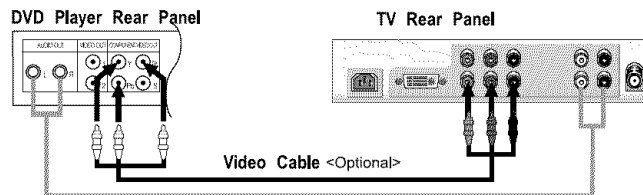

Note: For an explanation of Component video, see your DVD player owner's manual.

* Each external input source device has a different back panel configuration.

Connecting a DVD Player or Set-Top Box to the TV with a DVI-D Cable

1

Connect a DVI-D cable between the DVI-I INPUT connector on the TV and the DVI connector on the DVD player/ Set-Top BOX.

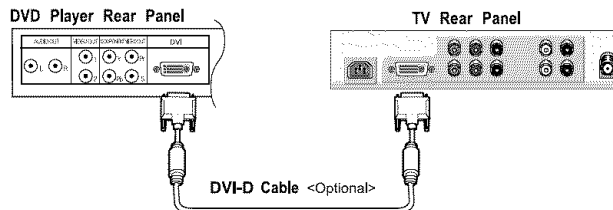

2

Connect a set of audio cables between the PC AUDIO INPUT jack on the TV and the AUDIO OUTPUT jacks on the DVD player/ Set-Top BOX.

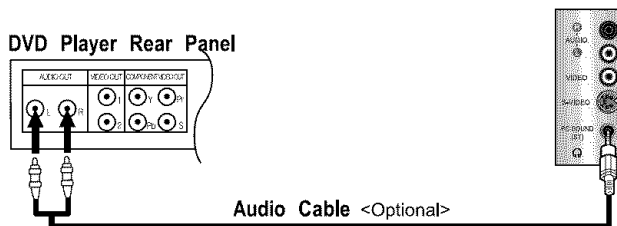

Note: If you are using a DVI-D cable to connect

1. Be sure to connect the audio cable (sold separately) as shown above to get normal TV sound.
2. See Appendix "Display Modes" for supported resolutions.
3. The screen may have shifted to the right or to the left after connecting the cable. Don't adjust the screen position in a Digital Signal.
4. Each external input Source device has a different back panel configuration.

Connecting a PC

Note: This figure shows the Standard Connector-jack panel.
The actual configuration on your TV may be different, depending on the model.

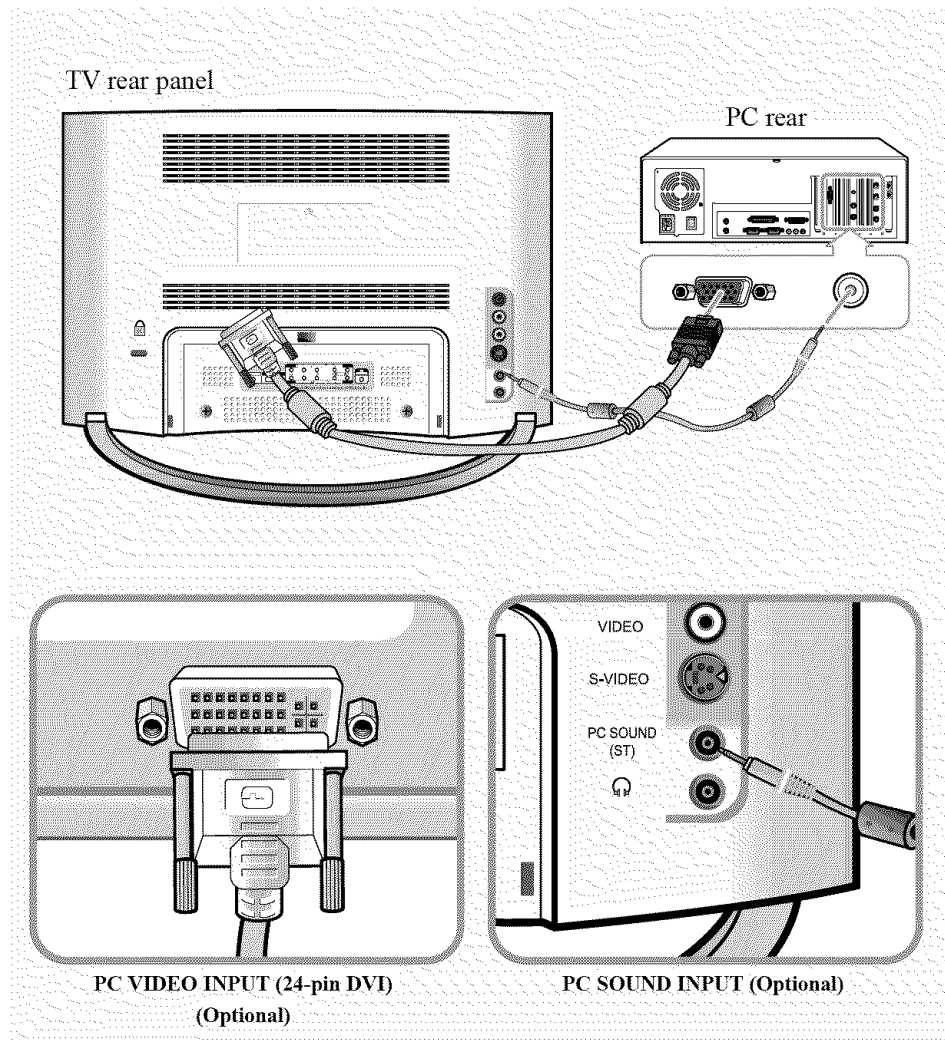

- **PC AUDIO INPUT**
Connect these to the audio-output jacks on your PC.

- **PC VIDEO INPUT**
Connect to the video output port on your PC.

* Each external input source device has a different back panel configuration.

Chapter Three

SPECIAL FEATURES

Turning the TV On and Off

Press the **POWER** button.
You can also use the Power button on the top panel.

Changing Channels

Using the Channel Buttons

1

Press the **CH ^ / ∨** buttons to change channels.

When you press the **CH ^ / ∨** buttons, the TV changes channels in sequence. You will see all the channels that the TV has memorized. (The TV must have memorized at least three channels). You will not see channels that were either erased or not memorized.

Using the PRE-CH Button to select the Previous Channel

1

Press the **PRE-CH** button.
The TV will switch to the last channel viewed.

To quickly switch between two channels that are far apart, tune to one channel, then use the number button to select the second channel. Then, use the **PRE-CH** button to quickly alternate between them.

Adjusting the Volume

1

Press the **VOL +/-** buttons to increase or decrease the volume.

Using Mute

At any time, you can temporarily cut off the sound using the Mute button.

1

Press **MUTE** and the sound cuts off.

The word “ Mute” will appear in the lower-left corner of the screen.

2

To turn mute off, press the **MUTE** button again, or simply press the **VOL +/-** buttons.

Viewing the Display

The display identifies the current channel and the status of certain audio-video settings.

1

Press the **INFO** button on the remote control.

The TV will display the channel, the type of sound, and the status of certain picture and sound settings.

Air	3
Mono	
Picture	Dynamic
Sound	Custom
MTS	Stereo
WOW	Off
Clock	12 : 00 pm

- ◀ The on-screen displays disappear after about ten seconds.
- ◀ Press the button once more or wait approximately 10 seconds and it disappears automatically.
- ◀ Allows the user to adjust the settings according to his/her preference and shows the current settings.

Viewing the Menus

1

With the power on, press the **MENU** button.

The main menu appears on the screen. It's left side has five icons: Input, Picture, Sound, Channel and Setup.

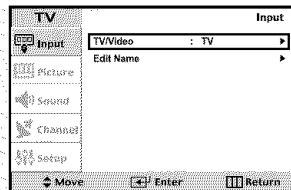

2

Use the **UP/DOWN ▲▼** buttons to select one of the 5 icons. Then press **ENTER (↵)** to access the icon's sub-menu.

3

Press the **MENU** button to exit.

- ◀ The on-screen menus disappear from the screen after about two minutes.

- ◀ You can also use the TV/Video (↵) buttons on the control panel of the TV to make selections.

Chapter Four

OPERATION

Plug & Play Feature

When the TV is initially powered On, two basic customer settings proceed automatically and subsequently: Setting Auto program, Clock.

1

Press the **POWER** button on the remote control.

The message "Plug & Play" is displayed.



Plug & Play

2

Press the **UP/DOWN▲▼** buttons to select "English", "Français", "Español", or "Português" then press the **ENTER**  button.

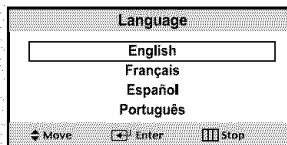

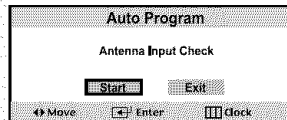

Press the **ENTER**  Button. The TV will begin memorizing all of the available channels.

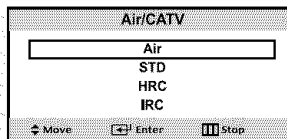

3

Press the **UP/DOWN▲▼** buttons to select "Air", "STD", "HRC" or "IRC", then press the **ENTER**  button.



Press the **ENTER**  button to stop.

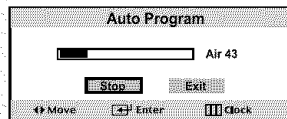

4

Press the **LEFT/RIGHT◀▶** buttons to move to the hour or minute. Set the hour or minute by pressing the **UP/DOWN▲▼** buttons. (refer to "Setting the Clock" on page 40).

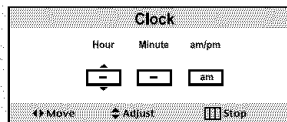

5

The message "Enjoy your watching." is displayed.



Enjoy your watching

Memorizing the Channels

Your TV can memorize and store all of the available channels for both “off-air” (antenna) and cable channels. After the available channels are memorized, use the CH ^ and CH v buttons to scan through the channels. This eliminates the need to change channels by entering the channel digits. There are three steps for memorizing channels: selecting a broadcast source, memorizing the channels (automatic) and adding and deleting channels (manual).

Selecting the Video Signal-source

Before your television can begin memorizing the available channels, you must specify the type of signal source that is connected to the TV (i.e., an antenna or a cable system).

1

Press the **MENU** button to display the menu.

Press the **UP/DOWN** buttons to select “Channel”, then press the **ENTER** button.

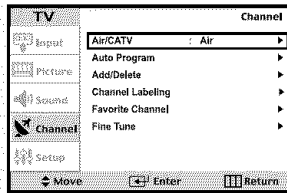

2

Repeatedly press the **ENTER** button to cycle through these choices: Air, STD, HRC or IRC (all cable TV).

Press the **UP/DOWN** buttons to select the Video signal source, then press the **ENTER** button.

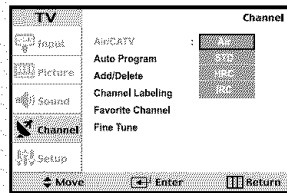

Note : STD, HRC and IRC identify various types of cable TV systems. Contact your local cable company to identify the type of cable system that exists in your particular area.

At this point the signal source has been selected. Proceed to “Storing Channels in Memory” (next page).

Storing Channels in Memory (Automatic Method)

1

First, select the correct signal source (Air, STD, HRC, IRC). See steps 1~2 on previous page.

Press the **MENU** button.

Press the **UP/DOWN▲▼** buttons to select "Channel", then press the **ENTER** button.

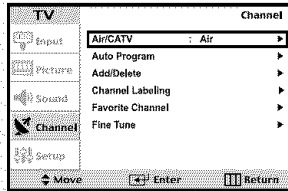

2

Press the **UP/DOWN▲▼** buttons to select "Auto program". Press the **ENTER** button.

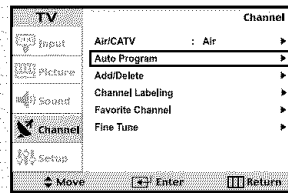

3

Press the **ENTER** button. The TV will begin memorizing all of the available channels.

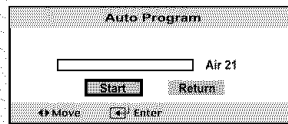

4

After all the available channels are stored, the Auto program menu reappears. Press the **MENU** button to exit.

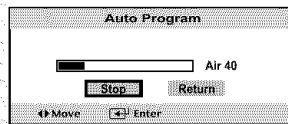

◀ The TV automatically cycles through all of the available channels and stores them in memory. This takes about one to two minutes.

Press **ENTER** at any time to interrupt the memorization process and return to the CHANNEL menu.

To check the channels stored in memory

Press the **CH ▲/▼** button.

- Only the channels stored in memory are selected.

To select channels over 100,

Ex) Press **100** → **08** → **00** to select channel 108.

ADD and DEL Channels (Manual Method)

1

Use the number buttons to directly select the channel to Add or Delete.

Press the **MENU** button to display the menu.

Press the **UP/DOWN ▲▼** buttons to select "Channel", then press the **ENTER** button.

Press the **UP/DOWN ▲▼** buttons to select "Add/Delete".

Press the **ENTER** button.

Press the **LEFT/RIGHT ◀▶** buttons to select "Add" or "Delete".

Press the **ENTER** button.

Press the **EXIT** button.

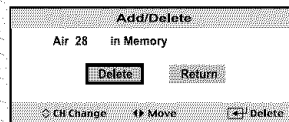
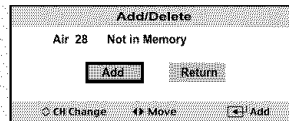
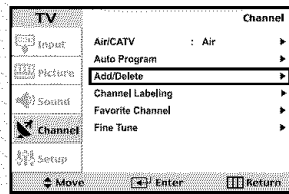

2(Alternate method)

Press the **ADD/DEL** button.

Repeatedly pressing **ENTER** will alternate between "Add" and "Delete".

Press the **LEFT/RIGHT ◀▶** buttons to select **Exit**, then press **ENTER** to exit.

You can view any channel (including an erased channel) by using the number buttons on the remote control.

Labeling Channel

1

Press the **MENU** button to display the menu.

Press the **UP/DOWN ▲▼** buttons to select "Channel", then press the **ENTER** button. **UP/DOWN ▲▼** buttons to select "Channel Labeling", then press the **ENTER** button.

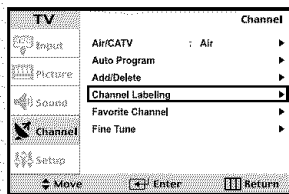

2

Press the **UP/DOWN ▲▼** buttons.

You can assign a name to a channel.

Press the **LEFT/RIGHT ◀▶** buttons to move to "Label" and use the **UP/DOWN ▲▼** buttons to assign a name.

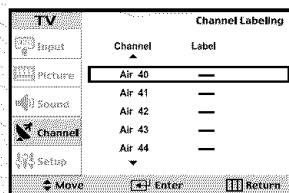

To select the Favorite Channels

1

Press the **MENU** button to display the menu.

Press the **UP/DOWN ▲▼** buttons to select "Channel", then press the **ENTER** button. **UP/DOWN ▲▼** buttons to select "Favorite Channel", then press the **ENTER** button.

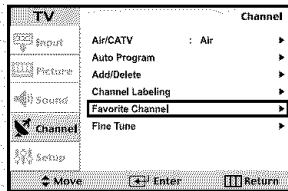

2

Press the **UP/DOWN ▲▼** buttons. You can select your favorite channels to watch among the labeled channels. Press the **UP/DOWN ▲▼** buttons to select "Channel" and press Enter to select channel to watch.

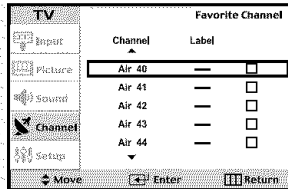

To select TV/VIDEO

Use to select TV or other external input sources connected to the TV.
Use to select the screen of your choice.

1

Press the **MENU** button to display the on-screen menu.

Press the **ENTER** button.

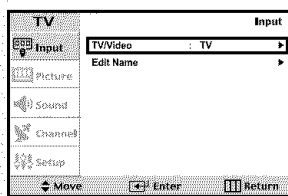

2

Press the **ENTER** button to select "TV", then press the **ENTER** button.

3

Press the **UP/DOWN ▲▼** buttons to select the Input source, then press **ENTER**.

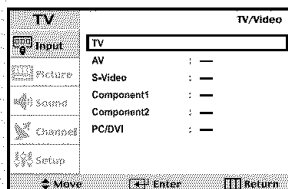

To Edit the Input Source Name

Name the input device connected to the input jacks to make your input source selection easier.

1

Press the **MENU** button to display the menu.

Press the **UP/DOWN ▲▼** buttons to select "Input" then press the **ENTER** button.

Press the **UP/DOWN ▲▼** buttons to select "Edit Name" then press the **ENTER** button.

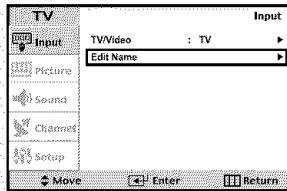

2

Press the **UP/DOWN ▲▼** buttons to select "AV", "S-Video", "Component1", "Component2" or "PC/DVI" then press the **ENTER** button.

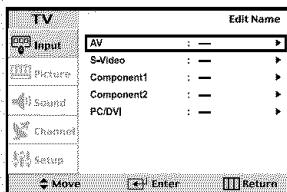

3

Press the **UP/DOWN ▲▼** buttons repeatedly until the correct VCR appears.

After the VCR is entered, press the **ENTER** button.

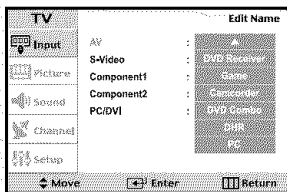
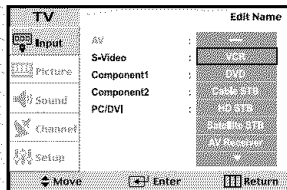

Using Automatic Picture Settings

Your TV has four automatic picture settings (“Dynamic”, “Standard”, “Movie”, and “Custom”) that are preset at the factory. You can activate either Dynamic, Standard, or Movie by pressing P.MODE (or by making a selection from the menu). Or, you can select “Custom” which automatically recalls your personalized picture settings.

1

Press the **MENU** button to display the menu.

Press the **UP/DOWN ▲▼** buttons to select “Picture”, then press the **ENTER** button twice.

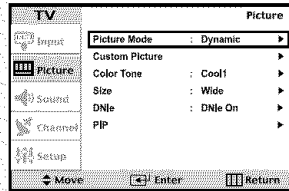

2

Press the **UP/DOWN ▲▼** buttons to select the “Dynamic”, “Standard”, “Movie” or “Custom” picture setting.

Press **ENTER**.
Press **MENU** twice to exit.

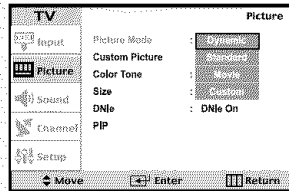

Alternate method:

Simply press the **P.MODE** button on the remote control to select one of the standard picture settings.

- Choose *Dynamic* to increase the clarity and sharpness of the picture.
- Choose *Standard* for the standard factory settings.
- Choose *Movie* when viewing the Movie.
- Choose *Custom* if you want to adjust the settings according to personal preference (see “Customizing the Picture, page 24).

Customizing the Picture

You can use the on-screen menus to change the contrast, brightness, sharpness, color and tint according to personal preference. (Alternatively, you can use one of the “automatic” settings. See the previous page).

1

Press the **MENU** button to display the menu.

Press the **UP/DOWN ▲▼** buttons to select “Picture”, then press the **ENTER** button.

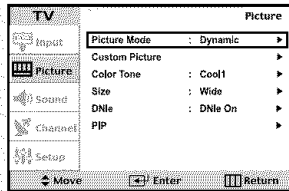

2

Press the **UP/DOWN ▲▼** buttons to select “Custom Picture”, then press the **ENTER** button.

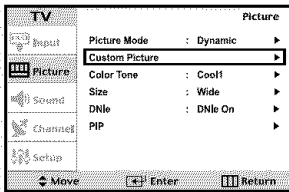

3

Press the **ENTER** button to select a particular item.

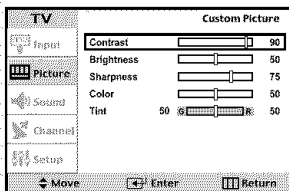

4

Press the **LEFT/RIGHT ◀▶** buttons to decrease or increase the value of a particular item. For example, if you select “Contrast”, pressing **RIGHT ▶** increases it.

Press the **MENU** button to exit.

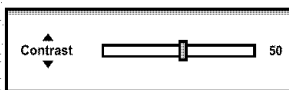

Press the **UP/DOWN ▲▼** buttons to select Contrast, Brightness, Sharpness, Color or Tint.

Using Automatic Sound Settings

Your TV has five automatic sound settings (“Standard”, “Music”, “Movie”, “Speech” and “Custom”) that are preset at the factory. You can activate any of them by pressing the S.MODE button (or by making a selection from the on-screen menu). Or, you can select “Custom Sound”, which automatically recalls your personalized sound settings.

1

Press the **MENU** button to display the menu.

Press the **UP/DOWN ▲▼** buttons to select “Sound”, then press the **ENTER** button.

Press the **UP/DOWN ▲▼** buttons to select “Sound Mode”, then press the **ENTER** button.

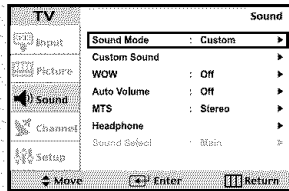

2

Press the **UP/DOWN ▲▼** buttons repeatedly to select the “Standard”, “Music”, “Movie”, “Speech”, or “Custom” sound settings. Press **MENU** to exit.



Alternate method:

Simply press the the **S.MODE** button on the remote control to select one of the standard sound settings.

- Choose *Standard* for the standard factory settings.
- Choose *Music* when watching music videos or concerts.
- Choose *Movie* when watching movies.
- Choose *Speech* when watching a show that is mostly dialogue (i.e., news).
- Choose *Custom* to recall your personalized settings.

Customizing the Sound

The sound settings can be adjusted to suit your personal preference.
 (Alternatively, you can use one of the “automatic” settings. See the previous page).

1

Press the **MENU** button to display the menu.

Press the **UP/DOWN ▲▼** buttons to select “Sound”, then press the **ENTER** button.

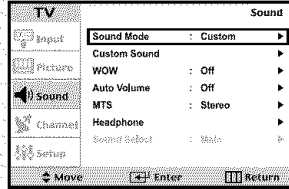

2

Press the **UP/DOWN ▲▼** buttons to select “Custom Sound”, then press the **ENTER** button.

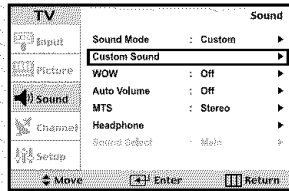

3

Press the **LEFT/RIGHT ◀▶** buttons to select a particular item to be changed.

Press the **UP/DOWN ▲▼** buttons to increase or decrease the value of a particular item.

Press the **MENU** button to exit.

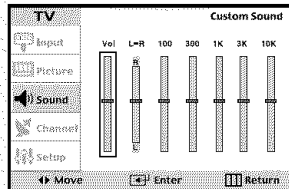

Selecting a Menu Language

1

Press the **MENU** button to display the menu.

Press the **UP/DOWN ▲▼** buttons to select "Setup", then press the **ENTER** button.

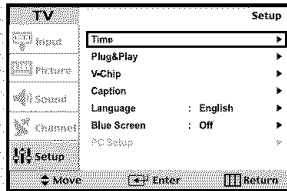

2

Press the **UP/DOWN ▲▼** buttons to select Language.

Press the **ENTER** button.



3

Press the **UP/DOWN ▲▼** buttons to select the language "English", "Français", "Español", or "Portugués".

Press the **MENU** button to exit.

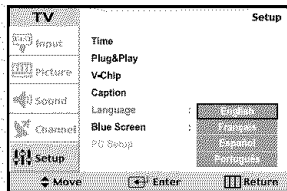

Setting the Blue Screen Mode

If no signal is being received or the signal is very weak, a blue screen automatically replaces the noisy picture background.

If you wish to continue viewing the poor picture, you must set the “Blue screen” mode to “Off”.

1

Press the **MENU** button to display the menu.

Press the **UP/DOWN ▲▼** buttons to select “Setup”, then press the **ENTER**  button.

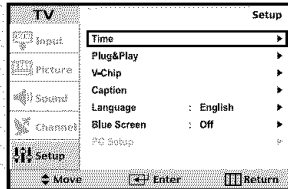

2

Press the **UP/DOWN ▲▼** buttons to select “Blue Screen”, then press the **ENTER**  button.



3

Press the **UP/DOWN ▲▼** buttons to set Blue Screen “On” or “Off”.

Press the **MENU** button to exit.



◀ Pressing the **UP/DOWN ▲▼** buttons will alternate between “On” and “Off”.

Fine Tuning Channels

Use fine tuning to manually adjust a particular channel for optimal reception.

1

Press the **MENU** button to display the menu.

Press the **UP/DOWN ▲▼** buttons to select "Channel", then press the **ENTER** button twice.

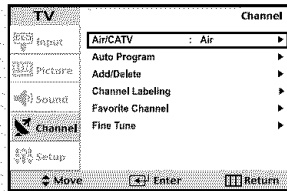

2

Press the **UP/DOWN ▲▼** buttons to select "Fine Tune", then press the **ENTER** button.

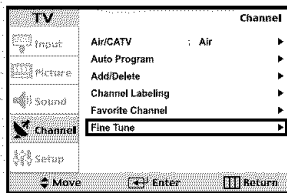

3

Press the **RIGHT ►** and **LEFT ◀** buttons to adjust the fine tuning.

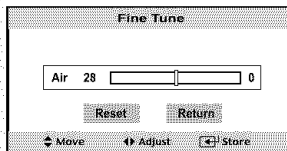

4

To store the fine tuning setting in the TV's memory, press the **ENTER** button.

To reset the fine tuning, press the **UP/DOWN ▲▼** buttons to select "Reset", then press the **ENTER** button.

Press the **MENU** button to exit.

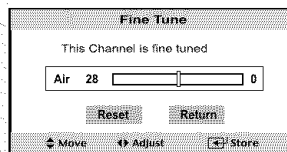
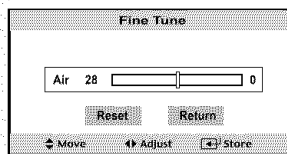

◀ If you do not store the channel in memory, adjustments to the settings are applied before you change the channel but are not saved. Therefore they return to the original settings once you move to another channel. User-adjusted channels are marked with an asterisk "*" on the right-hand side of the channel number in the channel banner.

Viewing Picture-in-Picture

This product has one tuner built-in, which does not allow PIP to function in the same mode. Please see 'PIP Settings' below for details.

You can use the PIP feature to simultaneously watch two video sources.

Note: While V-Chip is in operation, the PIP function cannot be used.

Activating Picture-in-Picture

1

Press the **MENU** button to display the menu.

Press the **UP/DOWN ▲▼** buttons to select "Picture", then press the **ENTER** button. Press the **UP/DOWN ▲▼** buttons to select "PIP".

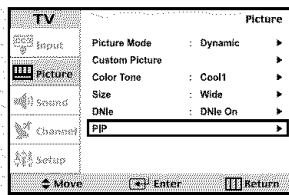

◀ Quick way to access the PIP menu:
Simply press the PIP button on the remote control.

2

Press the **ENTER** button to select PIP "On".

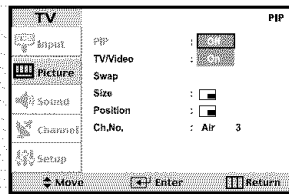

◀ If you turn the TV off while watching and turn it on again, the PIP window will disappear.

3

Press the **MENU** button to exit.

Note: Picture-in-Picture does not function when the V-chip is active.

PIP Settings

○ : PIP operates
X : PIP doesn't operate



Sub Picture \ Main Picture	TV	AV	S-Video	Component 1	Component 2	PC/DVI
TV	X	X	X	○	○	○
AV	X	X	X	○	○	○
S-Video	X	X	X	○	○	○
Component 1	○	○	○	X	X	X
Component 2	○	○	○	X	X	X
PC/DVI	○	○	○	X	X	X

Changing the PIP Channel

Press the PIP **CH**  button to change the channel that appears in the PIP window.

Changing the Size of the PIP Window

Press the **SIZE** button to alternate between a smaller and larger PIP window.

- When the PC is in energy saving mode, you cannot choose the PIP option.
- Press the  button once more to deselect PIP mode.
- You may notice that the picture in the PIP window becomes slightly unnatural when you set the main screen to game or karaoke mode. Switch the main screen and the PIP window for normal viewing.
- You can adjust picture position only by using the  size menu.

Changing the Screen Size

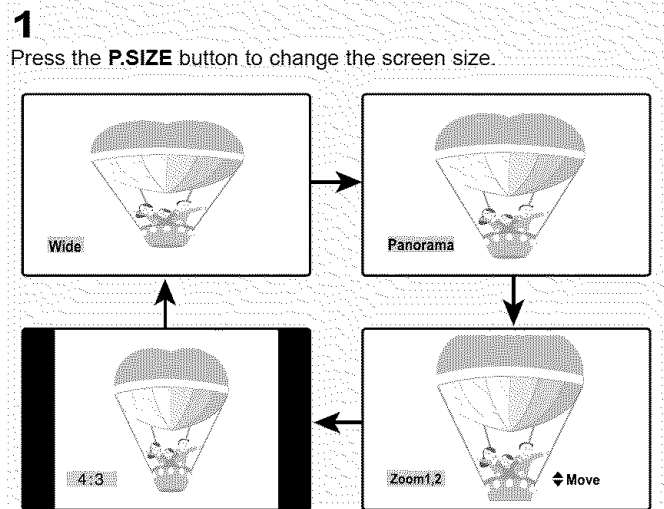

- Wide: Sets the picture to 16:9 wide mode.
- Panorama : Use this mode for the wide aspect ratio of a panoramic picture.
- Zoom 1,2 : Magnifies the size of the picture on screen.
- 4:3 : Sets the picture to 4:3 normal mode.
This is the standard TV screen size.

Freezing the Picture

- 1**
Press the **STILL** button to freeze a moving picture.
- Normal sound will still be heard.
- Press again to cancel.

Adjusting the Color Tone

You can change the color of the entire screen according to your preference.

1

Press the **MENU** button to display the menu.

Press the **UP/DOWN ▲▼** buttons to select "Picture", then press the **ENTER** button.

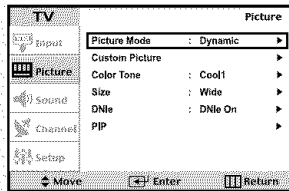

2

Press the **UP/DOWN ▲▼** buttons to select "Color Tone", then press the **ENTER** button.

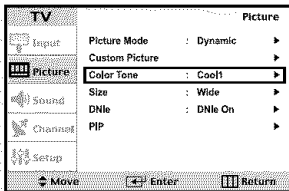

3

Press the **UP/DOWN ▲▼** buttons to select Color Tone.

Press the **MENU** button to exit.

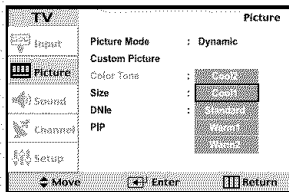

- ◀ Choose from the following Color Tone settings: "Cool 2", "Cool 1", "Standard", "Warm 1", "Warm 2" according to personal preference.

Setting the DNie

Samsung's New Technology brings you more detailed images with contrast, white enhancement and 3D noise reduction.

1

Press the **MENU** button to display the menu.

Press the **UP/DOWN ▲▼** buttons to select "Picture", then press the **ENTER** button.

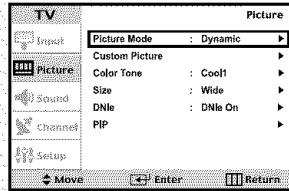

2

Press the **UP/DOWN ▲▼** buttons to select "DNie", then press the **ENTER** button.

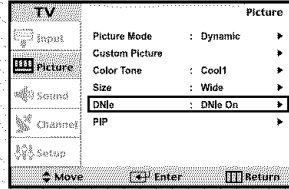

3

Press the **UP/DOWN ▲▼** buttons to select "Demo", "On" or "Off", then press the **ENTER** button.

Press the **MENU** button to exit.

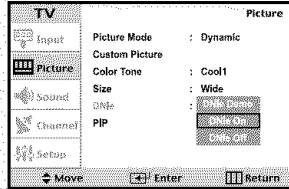

- DNie Demo: The screen shows the improved image on the left-hand side and the original image on the right-hand side.
- DNie On: Improved picture mode demonstrated by DNie Demo is activated.
- DNie Off: The mode is deactivated and the screen returns to its original condition.

For automatic volume control

Reduces the differences in volume level among broadcasters.

1

Press the **MENU** button to display the menu.

Press the **UP/DOWN ▲▼** buttons to select "Sound", then press the **ENTER** button.

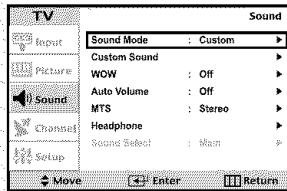

2

Press the **UP/DOWN ▲▼** buttons to select "Auto Volume", then press the **ENTER** button.



3

Press the **UP/DOWN ▲▼** buttons to set Auto Volume "On".

Press the **MENU** button to exit.

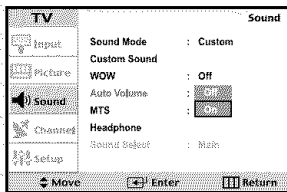

To select the WOW option

Emphasizes midrange and bass sound and provides a simulated surround-sound experience.

1

Press the **MENU** button to display the menu.

Press the **UP/DOWN ▲▼** buttons to select "Sound", then press the **ENTER** button.

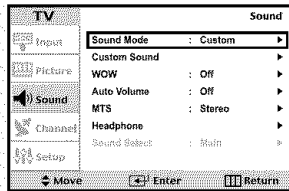

2

Press the **UP/DOWN ▲▼** buttons to select "WOW", then press the **ENTER** button.



3

Press the **UP/DOWN ▲▼** buttons to set WOW "On".

Press the **MENU** button to exit.

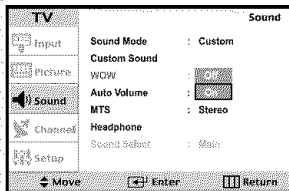

TRADEMARK & LABEL LICENSE NOTICE



is a trademark of SRS Labs, Inc.
WOW technology is incorporated under license from SRS labs, Inc.

Or
WOW, SRS and  symbol are trademarks of SRS Labs, Inc.

Special Sound Options

Choosing a Multi-Channel Sound (MTS) Soundtrack

Depending on the particular program being broadcast, you can listen to stereo, mono, or a Separate Audio Program. (SAP audio is usually a foreign-language translation. Sometimes SAP has unrelated information like news or weather).

1

Press the **MENU** button to display the menu.

Press the **UP/DOWN ▲▼** buttons to select “Sound”, then press the **ENTER** button.



2

Press the **UP/DOWN ▲▼** buttons to select “MTS”, then press the **ENTER** button.



3

Press the **UP/DOWN ▲▼** buttons to select “Mono”, “Stereo” or “SAP”, then press the **ENTER** button.

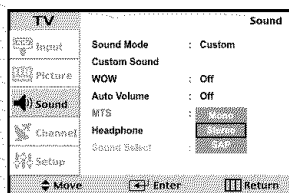

◀ Note : The text at the bottom of the menu tells you if the incoming audio is Mono, Stereo or SAP.

- Choose *Stereo* for channels that are broadcasting in stereo.
- Choose *Mono* for channels that are broadcasting in mono, or if you are having difficulty receiving a stereo signal.
- Choose *SAP* to listen to the Separate Audio Program, which is usually a foreign-language translation.

You can also change the MTS setting by pressing the “MTS” button on the remote control. (When you change channels, MTS is set to “Stereo” automatically. To listen in ‘SAP’ or ‘Mono,’ change the MTS setting).

Selecting the Main or Sub Sound

You can select either Main or Sub when PIP is On.

1

Press the **MENU** button to display the menu.

Press the **UP/DOWN ▲▼** buttons to select "Sound", then press the **ENTER** button.

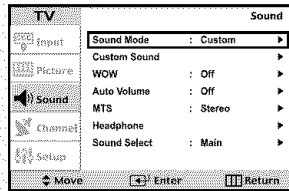

2

Press the **UP/DOWN ▲▼** buttons to select "Sound Select", then press the **ENTER** button.

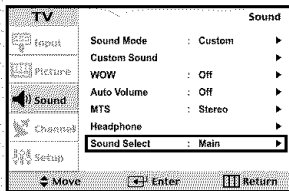

3

Press the **ENTER** button to select "Main" or "Sub".

Select "Main" to hear the main TV sound and select "Sub" to hear the PIP window sound.

Press the **MENU** button to exit.

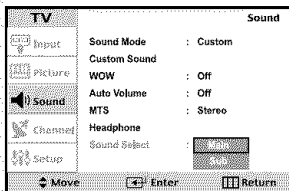

◀ Note :Sound Select can also be used to select the Main or Sub sound over the speakers.

Adjusting the Headphone Sound

The headphone option is especially useful when simultaneously watching the main screen and the PIP window.

1

Press the **MENU** button to display the menu.

Press the **UP/DOWN ▲▼** buttons to select "Sound", then press the **ENTER** button.

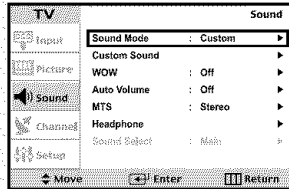

◀ Note :Headphones must be purchased separately.

2

Press the **UP/DOWN ▲▼** buttons to select "Headphone" and press the **ENTER** button.

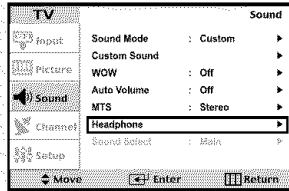

3

Press the **UP/DOWN ▲▼** buttons, then press the **ENTER** button to select the particular item to be changed.

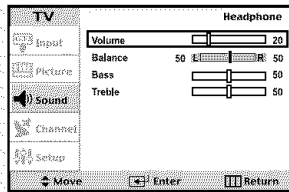

4

Press the **LEFT/RIGHT ◀▶** buttons to decrease or increase the value of a particular item.

Press the **MENU** button to Exit.

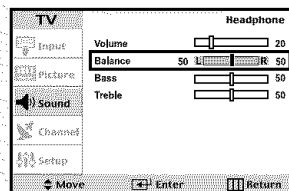

Setting the Clock

Setting the clock is necessary in order to use the various timer features of the TV. Also, you can check the time while watching the TV. (Just press the INFO button).

1

Press the **MENU** button to display the on-screen menu.

Press the **UP/DOWN ▲▼** buttons to select "Setup", then press the **ENTER** button.

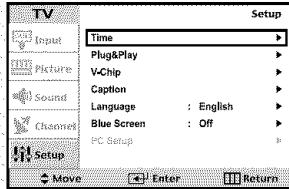

2

Press the **ENTER** button to select "Time", then press the **ENTER** button to select "Clock".

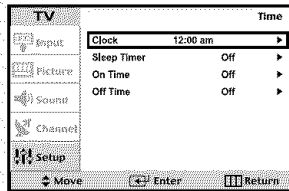

3

Press the **UP/DOWN ▲▼** buttons repeatedly until the correct hour appears.

After the hour is entered, press the **LEFT/RIGHT ◀▶** buttons to select "Minute".

Press the **UP/DOWN ▲▼** buttons until the correct minute appears.

Press the **LEFT/RIGHT ◀▶** buttons to select am/pm and adjust with the **UP/DOWN ▲▼** buttons.

Press the **MENU** button to Exit.

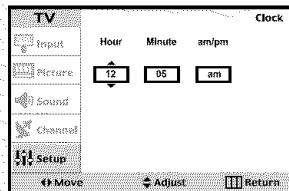

◀ Note : You can also set the time using the numeric buttons on the remote.

Setting the On/Off Timer

1

Press the **MENU** button to display the on-screen menu.

Press the **UP/DOWN ▲▼** buttons to select "Setup", then press the **ENTER** button twice.



2

Press the **ENTER** button, to select "Time".

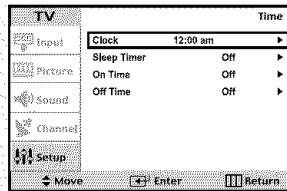

3

Press the **UP/DOWN ▲▼** buttons to select "On time", then press the **ENTER** button.

Press the **UP/DOWN ▲▼** buttons repeatedly to select the appropriate hour.

Press the **LEFT/RIGHT ◀▶** buttons repeatedly to select the appropriate minute (i.e., the time when the TV will turn on).

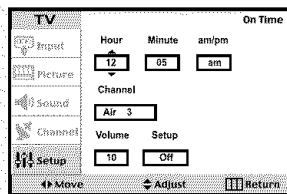
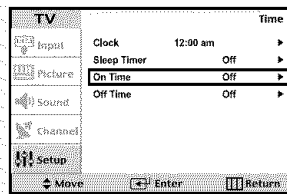



◀ Before using the timer, you must set the TV's clock.
(See "Setting the Clock" on page 40)

◀ When you set the hours, make sure the correct time of day (am or pm) appears to the right of the time.

OPERATION

4

Press the **LEFT/RIGHT**  buttons to select Setup.

Press the **UP/DOWN**  buttons to on-timer "On".
(Repeatedly pressing the **UP/DOWN**  buttons will alternate between On and Off).

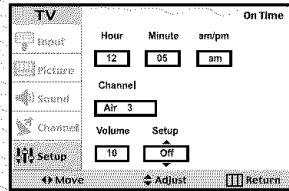

When finished, press the **ENTER**  button.

◀ To deactivate the "On time," select "Off" during this step.

5

To set the Off time, press the **UP/DOWN**  buttons to select "Off time".

Press the **ENTER**  button and set the hours and minutes. (Follow the same procedure as in steps 1~4 above).

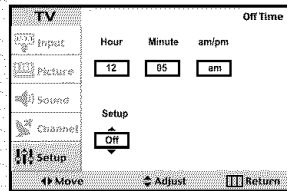
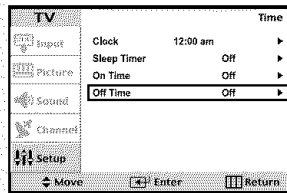

6

When finished setting the timer, press the **MENU** button to exit.

• Absent Power Off

When you set the timer on, your television will be turned off if you do not operate any controls for 3 hours after the TV has been turned on with the 'Timer On' function. 'Auto power off' operates only when the TV has been turned on by the 'Timer on' function.

Setting the Sleep Timer

Set the timer for the TV to turn off at the preset time automatically.

Sleep timer

1

Press the **MENU** button to display the on-screen menu.

Press the **UP/DOWN ▲▼** buttons to select "Setup", then press the **ENTER** button.

Press the **ENTER** button to select "Time".

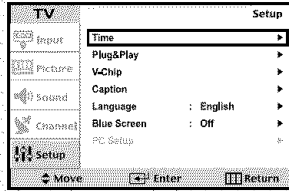

2

Press the **UP/DOWN ▲▼** buttons to select "Sleep Timer", then press the **ENTER** button.

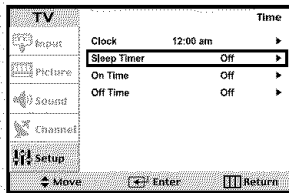

3

Press the **UP/DOWN ▲▼** buttons repeatedly until the correct time appears.

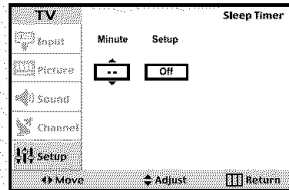

- Easy Way to Set the Sleep Timer**

Press the  button on the remote.

The number on the screen changes from Off • 30 • 60 • 90 • 120 • 150 • 180 • Off

Viewing Closed Captions

Your TV decodes and displays the closed captions that are broadcast with certain TV shows. These captions are usually subtitles for the hearing impaired or foreign-language translations. All VCRs record the closed caption signal from television programs, so home-recorded video tapes also provide closed captions. Most pre-recorded commercial video tapes provide closed captions as well. Check for the closed caption symbol in your television schedule and on the tape's packaging : **CC** .

1

Press the **MENU** button to display the on-screen menu.

Press the **UP/DOWN ▲▼** buttons to select "Setup", then press the **ENTER** button.

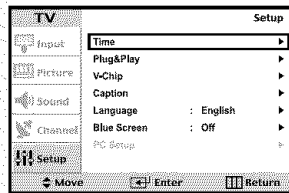

2

Press the **UP/DOWN ▲▼** buttons to select "Caption", then press the **ENTER** button.

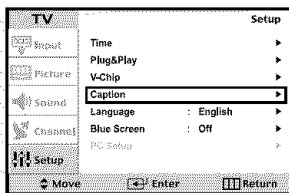

3

Press the **ENTER** button.

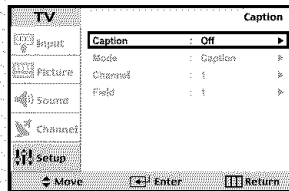

4

Press the **UP/DOWN ▲▼** buttons to set caption "Off/On", then press the **ENTER** button.

Press the **MENU** button to exit.

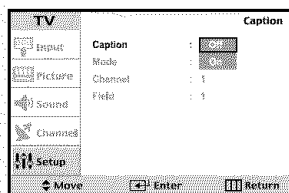

5

Depending on the particular broadcast, it might be necessary to make changes to "Channel" and "Field".

Press the **MENU** button to exit the menu.

◀ Different channels and fields display different information: Field 2 carries additional information that supplements the information in Field 1. (For example, Channel 1 may have subtitles in English, while Channel 2 has subtitles in Spanish).

Using the V-Chip

The V-Chip feature automatically locks out programming that is deemed inappropriate for children. The user must first enter a Pin (personal ID number) before any of the V-Chip restrictions can be set up or changed.

Setting Up Your Personal ID Number (PIN)

1

Press the **MENU** button to display the menu.

Press the **UP/DOWN ▲▼** buttons to select "Setup", then press the **ENTER** button.



2

Press the **UP/DOWN ▲▼** buttons to select "V-Chip", then press the **ENTER** button.



3

The "Enter Pin" screen will appear. Enter your 4-digit Pin number. Note: The default Pin number for a new TV set is "0-0-0-0."

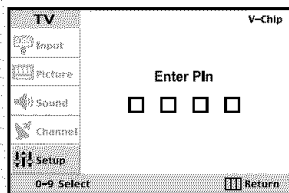

4

After entering a valid PIN number, the "V-Chip" screen will appear. Press the **UP/DOWN ▲▼** buttons to select "Change Pin."

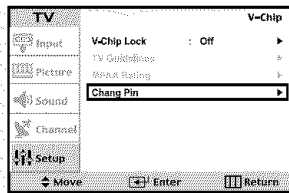

5

Press the **ENTER** button. The Change pin screen will appear. Choose any 4-digits for your Pin and enter them.

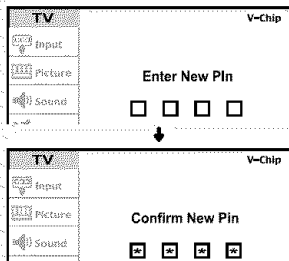

As soon as the 4 digits are entered, the "Confirm new Pin" screen appears. Re-enter the same 4 digits. When the Confirm screen disappears, your Pin has been memorized. Press the **MENU** button to exit.

◀ Note: If you forget the Pin, press the remote-control buttons in the following sequence, which resets the pin to 0-0-0-0:
POWER OFF → MUTE → 8 → 2 → 4 → POWER ON.

OPERATION

How to Enable/Disable the V-Chip

Note: V-Chip cannot be used during PIP operation.

1

Press the **MENU** button to display the menu.

Press the **UP/DOWN ▲▼** buttons to select "Setup", then press the **ENTER** button.

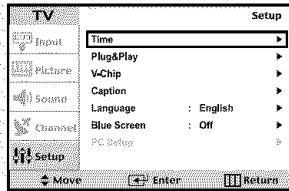

2

Press the **UP/DOWN ▲▼** buttons to select "V-Chip", then press the **ENTER** button.



3

The "Enter Pin" screen will appear. Enter your 4-digit Pin number.

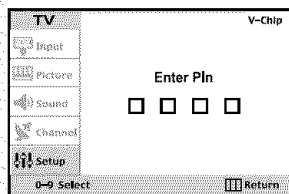

4

The "V-Chip" screen will appear, and "V-Chip Lock" will be selected.

To enable the V-Chip feature, press the **ENTER** button so that the "V-Chip Lock" is set to Yes. (Pressing the **UP/DOWN ▲▼** buttons will alternate between On and Off).

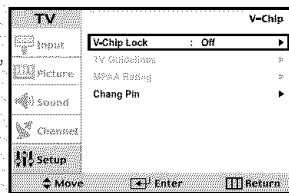

How to Set up Restrictions Using the 'TV guidelines'

First, set up a personal identification number (PIN), and enable the V-Chip. (See previous section). Parental restrictions can be set up using either of two methods: The TV guidelines or the MPAA rating.

1

Press the **MENU** button to display the menu.

Press the **UP/DOWN ▲▼** buttons to select "Setup", then press the **ENTER** button.



OPERATION

2

Press the **UP/DOWN ▲▼** buttons to select “V-chip”, then press the **ENTER** button.

The “Enter pin” screen will appear. Enter your 4-digit PIN number.

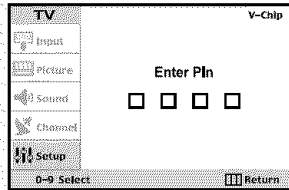

3

Press the **UP/DOWN ▲▼** buttons to select “TV Guidelines”, then press the **ENTER** button.

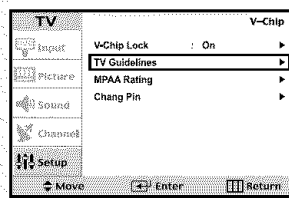

4

The “TV Guidelines” screen will appear. Press the **UP/DOWN ▲▼** buttons to select one of the six age-based categories:

TV-Y Young children
TV-Y7 Children 7 and over

TV-G General audience
TV-PG Parental guidance
TV-14 Viewers 14 and over
TV-MA Mature audience

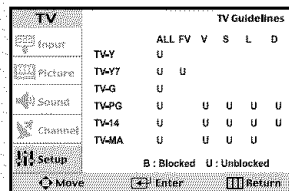

◀ Note: These categories consist of two separate groups : TV-Y and TV-Y7 (young children through age 7), and TV-G through TV-MA (everybody else).

The restrictions for these two groups work independently: If a household includes very young children as well as young adults, the TV guidelines must be set up separately for each age group. (See next step).

5

At this point, one of the TV-Ratings is selected.

Press the **ENTER** button: Depending on your existing setup, the color of the letter “U” or “B” will be highlighted. (U= Unblocked, B= Blocked)

When the color of the “U” or “B” is highlighted, press the **ENTER** button to block or unblock the category. A TV-Rating will be highlighted.

To exit this screen, press the **MENU** again. To select a different TV-Rating, press the **UP/DOWN ▲▼** buttons and then repeat the process.

Note 1: The TV-Y7, TV-PG, TV-14 and TV-MA have additional options. See the next step to change any of the following sub-ratings:

- FV: **F**antasy **V**iolence
- D: Sexual suggestive **D**ialog
- L: Adult **L**anguage
- S: **S**exual situation
- V: **V**iolence

Note 2: The V-Chip will automatically block certain categories that are “more restrictive.” For example, if you block “TV-Y” category, then TV-Y7 will automatically be blocked. Similarly, if you block the TV-G category, then all the categories in the “young adult” group will be blocked (TV-G, TV-PG, TV-14 and TV-MA). The sub-ratings (D, L, S, V) work together similarly. (See next section).

6

How to set the FV, D, L, S and V sub-ratings.

First, highlight one of these TV-Ratings: TV-Y7, TV-PG, TV-14 or TV-MA (See Step 4, on previous page).

Next, while the TV-Rating is selected, repeatedly press the **ENTER** (↵) button. This will cycle through the available sub-ratings (FV, L, S, D or V).

A highlighted letter (“U” or “B”) will be displayed for each sub-rating. While the “U” or “B” is highlighted, press the **ENTER** (↵) buttons to change the sub-rating.

Press **MENU** once to save the TV guidelines. A TV-Rating will be selected, and no letters “U” or “B” will be changed to yellow.

To exit this screen, press the **MENU** button again. To select a different TV-Rating, press the **UP/DOWN** ▲▼ buttons and then repeat the process.

Note: The V-chip will automatically block certain categories that are “More restrictive”. For example, if you block “L” sub-rating in TV-PG, then the “L” sub-ratings in TV-14 and TV-MA will automatically be blocked.

7

Press the **MENU** button three times to clear all the screens. (Or proceed to the next section, and set up additional restrictions based on the MPAA codes).

How to Set up Restrictions using the MPAA Ratings: G, PG, PG-13, R, NC-17, X

The MPAA rating system uses the Motion Picture Association of America (MPAA) system, and its main application is for movies. (Eventually, movie videocassettes will be encoded with MPAA ratings). When the V-Chip lock is on, the TV will automatically block any programs that are coded with objectionable ratings (either MPAA or TV-Ratings).

1

Press the **MENU** button to display the menu.

Press the **UP/DOWN** ▲▼ buttons to select “Setup”, then press the **ENTER** (↵) button.

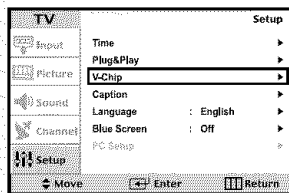

Press the **UP/DOWN** ▲▼ buttons to select “V-Chip”, then press the **ENTER** (↵) button.

2

The “Enter pin” screen will appear. Enter your 4-digit Pin number.

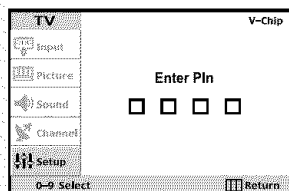

3

Press the **UP/DOWN ▲▼** buttons to select "MPAA Rating", then press the **ENTER (⏏)** button.

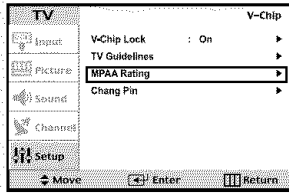

4

Repeatedly press the **UP/DOWN ▲▼** buttons to select a particular MPAA category. (When a category is selected, its color changes to yellow). Pressing the **UP/DOWN ▲▼** buttons will cycle through the MPAA categories:

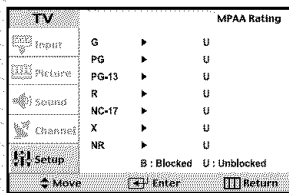

- G** General audience (no restrictions).
- PG** Parental guidance suggested.
- PG-13** PG-13 (Parents strongly cautioned).
- R** R (Restricted. Children under 17 should be accompanied by an adult).
- NC-17** No children under age 17.
- X** X (Adults only).
- NR** Not rated.

Press the **UP/DOWN ▲▼** buttons to select a category.

Press the **ENTER (⏏)** buttons to select "U" or "B".

Press the **MENU** button three times to save the settings and to clear all screens.

Note: The V-Chip will automatically block any category that is "more restrictive".

For example, if you block the "PG-13" category, then "R," "NC-17," and "X" will automatically be blocked also.

How to Reset the TV after the V-Chip Blocks a Channel ('Emergency Escape')

If the TV is tuned to a restricted channel, the V-Chip will block it. The screen will go blank and the following message will appear: "Excessive rating".

To resume normal viewing, tune to a different channel using the number buttons. Under certain conditions (depending on the rating of the local TV programs) the V-Chip might lock out all the channels.

In this case, use the Menu button for an "emergency escape".

Select the V-Chip on the Menu. Enter your PIN number, and press the **ENTER (⏏)** button to temporarily disable the V-Chip Lock.

Chapter Five

PC DISPLAY

Using Your TV as a Computer (PC) Display

How to Set up Your PC Software (Windows only)

The Windows display-settings for a typical computer are shown below. However, the actual screens on your PC will probably look different, depending upon your particular version of Windows and your particular video card. Even if your actual screens look different, the same, basic set-up information will apply in most cases. (If not, contact your computer manufacturer or Samsung Dealer).



First, click on "Settings" on the Windows start menu.

While "Settings" is highlighted, move the cursor so that "Control Panel" is highlighted.

When the control panel screen appears, click on "Display" and a display dialog-box will appear.

Navigate to the "settings" tab on the display dialog-box.

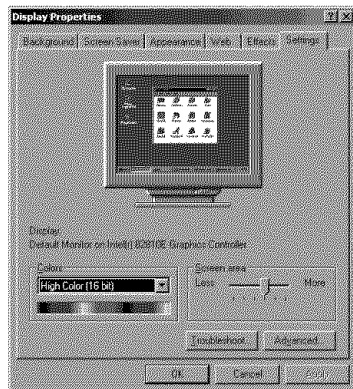
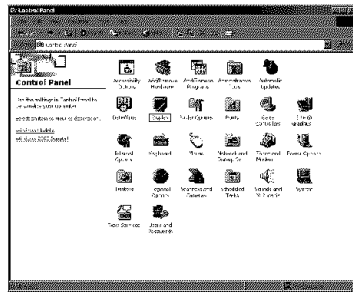

The two key variables that apply the TV-PC interface are "resolution" and "colors." The correct settings for these two variables are:

* Size (sometimes called "resolution"):
1280 x 720 pixels

If a vertical-frequency option exists on your display settings dialog box, the correct value is "60" or "60 Hz". Otherwise, just click "OK" and exit the dialog box.

* See "Display Modes" on page 66.

Adjusting the Screen Quality

The purpose of the picture quality adjustment is to remove or reduce picture noise. If the noise is not removed by fine tuning alone, then do the frequency adjustments to the utmost and fine tune again. After the noise has been reduced, re-adjust the picture so that it is aligned on the center of screen.

Press the PC button on the remote control to select the PC mode.

1

Press the **MENU** button to display the menu.

Press the **UP/DOWN ▲▼** buttons to select "Setup", then press the **ENTER** button.

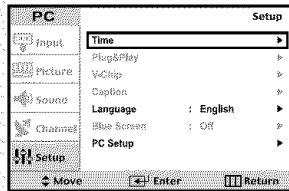

2

Press the **UP/DOWN ▲▼** buttons to select "PC Setup", then press the **ENTER** button.

Press the **ENTER** button to select "Image Lock", then press the **ENTER** button.

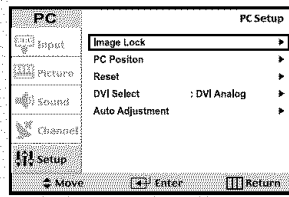

3

Press the **UP/DOWN ▲▼** buttons to select "Coarse or Fine", then press the **ENTER** button.

Press the **LEFT/RIGHT ◀▶** buttons to adjust the screen quality, vertical stripes may appear or the picture may be blurry.

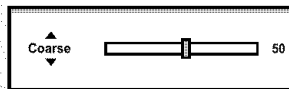
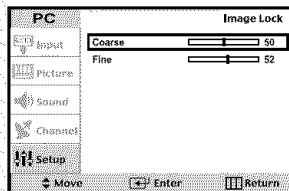

<Adjusting Coarse>

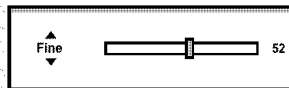

<Adjusting Fine>

4

When you are satisfied with the settings, press the **MENU** button repeatedly to return to normal viewing.

PC DISPLAY

Changing the Screen Position

Press the PC button on the remote control to select the PC mode.

1

Press the **MENU** button to display the menu.

Press the **UP/DOWN ▲▼** buttons to select "Setup", then press the **ENTER** button.

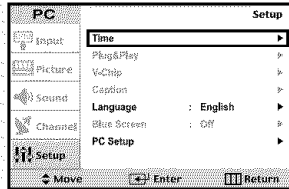

2

Press the **UP/DOWN ▲▼** buttons to select "PC Setup", then press the **ENTER** button.

Press the **UP/DOWN ▲▼** buttons to select "PC Position", then press the **ENTER** button.

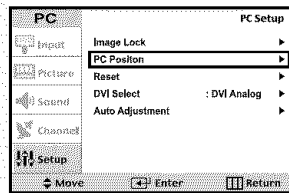

3

Press the **UP/DOWN ▲▼** buttons to adjusting the V-Position.

Press the **LEFT/RIGHT ◀▶** buttons to adjusting the H-Position.

Press the **MENU** button to exit.

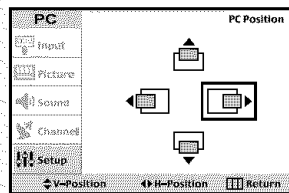

PC DISPLAY

To Initialize the Screen Position or Color Settings

1

Press the **MENU** button to display the menu.

Press the **UP/DOWN ▲▼** buttons to select "Setup", then press the **ENTER** button.



2

Press the **UP/DOWN ▲▼** buttons to select "PC Setup", then press the **ENTER** button.

Press the **UP/DOWN ▲▼** buttons to select "Reset", then press the **ENTER** button.

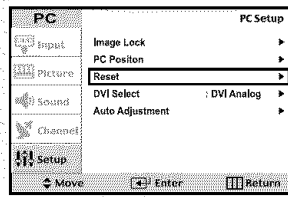

3

Press the **UP/DOWN ▲▼** buttons to select "Image Reset or Color reset", then press the **ENTER** button.

Press the **MENU** button to exit.

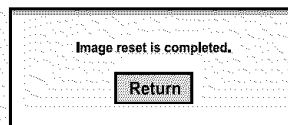
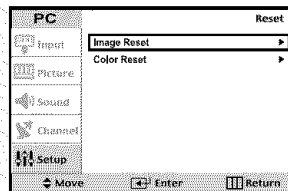

<Image Reset>

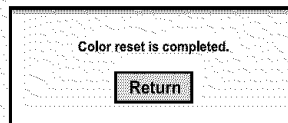

<Color Reset>

PC DISPLAY

PC(Digital/Analog) Signal Select

1

Press the **MENU** button to display the menu.

Press the **UP/DOWN ▲▼** buttons to select "Setup", then press the **ENTER** button.

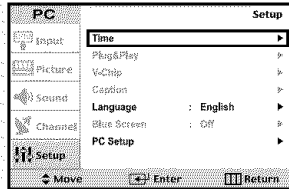

2

Press the **UP/DOWN ▲▼** buttons to select "PC Setup", then press the **ENTER** button.

Press the **UP/DOWN ▲▼** buttons to select "DVI Select", then press the **ENTER** button.

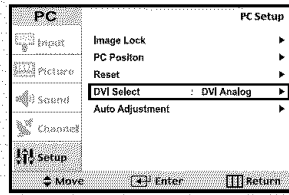

3

Press the **UP/DOWN ▲▼** buttons to select "DVI Analog or DVI Digital", then press the **ENTER** button.

Press the **MENU** button to exit.

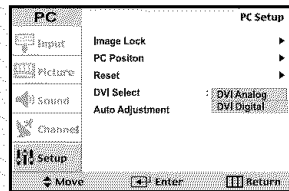

PC DISPLAY

How to Auto Adjust

Use the Auto Adjust function to have the TV set automatically adjust the video signals the monitor receives. The function also automatically fine-tunes the settings and adjusts the frequency values and positions.

1

Press the **MENU** button to display the menu.

Press the **UP/DOWN ▲▼** buttons to select "Setup", then press the **ENTER** button.

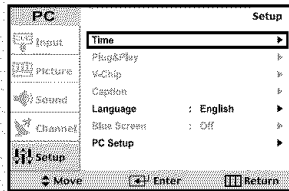

2

Press the **UP/DOWN ▲▼** buttons to select "PC Setup", then press the **ENTER** button.

Press the **UP/DOWN ▲▼** buttons to select "DVI Select", then press the **ENTER** button.

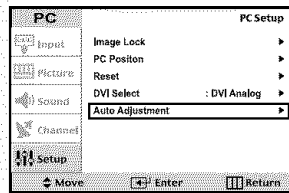

3

Press the **MENU** button to exit.

Auto Adjustment

Using Automatic Picture Settings

1

Press the **MENU** button to display the menu.

Press the **UP/DOWN ▲▼** buttons to select "Picture", then press the **ENTER** button twice.

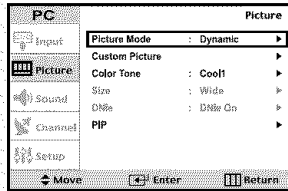

2

Press the **UP/DOWN ▲▼** buttons to select the "Dynamic", "Standard", "Movie" or "Custom" picture setting.

Press **ENTER** button.

Press **MENU** twice to exit.

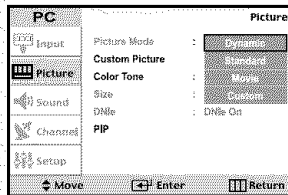

Customizing the Picture

You can use the on-screen menus to change the contrast, brightness, and sharpness according to personal preference.
(Alternatively, you can use one of the “automatic” settings.)

1

Press the **MENU** button to display the menu.

Press the **UP/DOWN ▲▼** buttons to select “Picture”, then press the **ENTER** button.

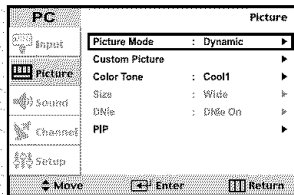

2

Press the **UP/DOWN ▲▼** buttons to select “Custom Picture”, then press the **ENTER** button.

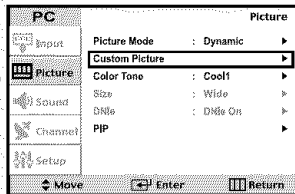

3

Press the **ENTER** button to select a particular item.

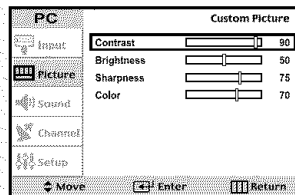

4

Press the **LEFT/RIGHT ◀▶** buttons to decrease or increase the value of a particular item. For example, if you select “Contrast”, pressing **RIGHT ▶** increases it.

Press the **MENU** button to exit.

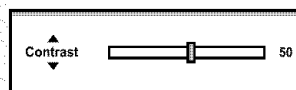

Press the **UP/DOWN ▲▼** buttons to select Contrast, Brightness, Sharpness or Color

Adjusting the Color Tone

You can change the color of the entire screen according to your preference.

1

Press the **MENU** button to display the menu.

Press the **UP/DOWN ▲▼** buttons to select "Picture", then press the **ENTER** button.

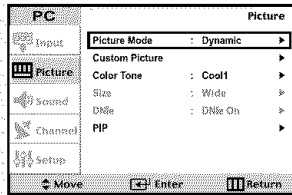

2

Press the **UP/DOWN ▲▼** buttons to select "Color Tone", then press the **ENTER** button.

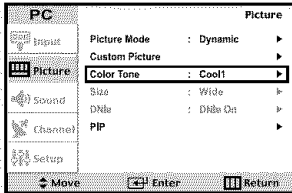

3

Press the **UP/DOWN ▲▼** buttons to select Color Tone.

Press the **MENU** button to exit.

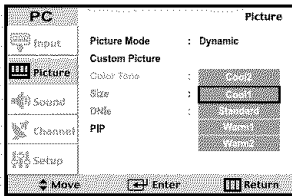

- ◀ Choose from the following Color Mode settings: "Cool2", "Cool1", "Standard", "Warm1", "Warm2", according to personal preference.

Chapter Six

TROUBLESHOOTING

If the TV seems to have a problem, first try this list of possible problems and solutions. If none of these troubleshooting tips apply, call your nearest Samsung service center.

Identifying Problems

Problem	Possible Solution
Poor picture	Try another channel. Adjust the antenna. Check all wire connections.
Poor sound quality.	Try another channel. Adjust the antenna.
No picture or sound.	Try another channel. Press the TV/VIDEO button. Make sure the TV is plugged in. Check the antenna connections.
No sound or sound is too low at maximum volume.	First, check the volume of units connected to your TV (digital broadcasting receiver, DTV, DVD, cable broadcasting receiver, VCR, etc.). Then, adjust the TV volume accordingly.
Picture rolls vertically.	Check all wire connections.
The TV operates erratically.	Unplug the TV for 30 seconds, then try operating it again.
The TV won't turn on.	Make sure the wall outlet is working.
Remote control malfunctions	Replace the remote control batteries. Clean the upper edge of the remote control (transmission window). Check the battery terminals.
"Check Signal Cable" message.	Ensure that the signal cable is firmly connected to the PC sources.

Problem	Possible Solution
“Not Supported Mode!” message.	Check the maximum resolution and the frequency of the Video Adapter. Compare these values with the data in the Display Modes Timing Chart.
The image is too light or too dark.	Adjust the Brightness and Contrast. Adjust the Fine tuning.
Horizontal bars appear to flicker, jitter or shimmer on the image.	Adjust the Coarse tuning and then adjust the Fine tuning.
Vertical bars appear to flicker, jitter or shimmer on the image.	Adjust the Coarse tuning and then adjust the Fine tuning.
Screen is black and power indicator light blinks steadily.	On your computer check: Power , Signal Cable(24-pin DVI) The TV is using its power management system. Move the computer's mouse or press a key on the keyboard.
Image is not stable and may appear to vibrate.	If the setting is not correct, use your computer utility program to change the display settings. NOTE: Your TV supports multiscan display functions within the following frequency domain: <ul style="list-style-type: none"> • Horizontal frequency: 30 kHz ~ 68 kHz • Vertical frequency: 56 Hz ~ 85 Hz • Maximum refresh rate: 1280 x 720 @ 60 Hz
Image is not centered on the screen.	Adjust the horizontal and vertical position. Don't adjust the screen position in a Digital Signal.
If a still image is displayed for an extended period of time, residual images or blurring may appear.	When you need to leave the monitor unused for an extended period of time, adjust the settings so that the monitor automatically goes into energy saving mode or activates the screen saver to display moving images.

How to connect the cables and stand base

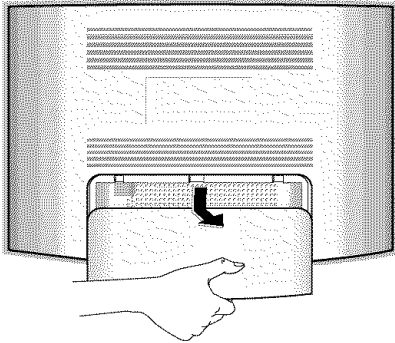

1 Remove the cover as shown in the picture.

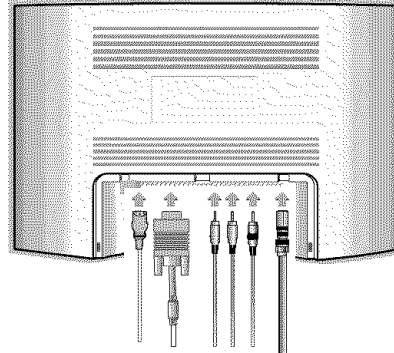

2 Connect the cables as shown in the picture.

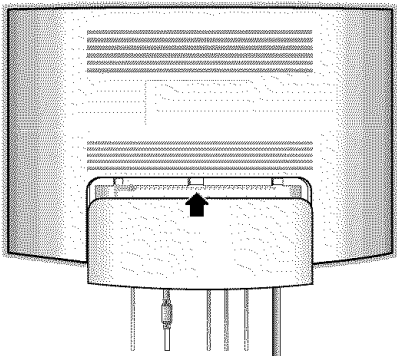

3 Replace the cover.

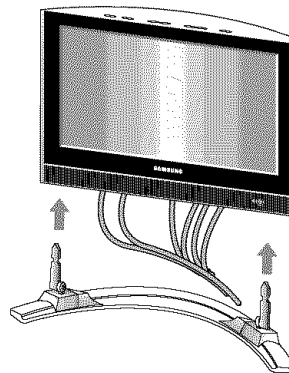

4 Attach the stand to the TV set as shown in the picture.

Note : The curved side of the stand base should be placed toward the back of the TV set as shown in the above figure.

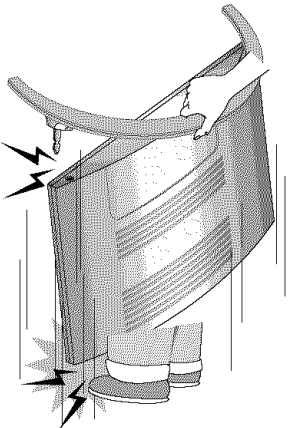

Do NOT lift the TV set by the stand.
The stand is not screwed to the TV set and lifting the set by the stand may cause injury.

Using the Anti-Theft Kensington Lock

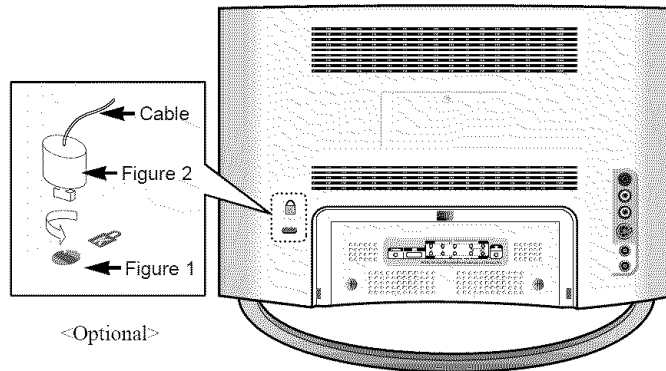

The Kensington lock is a device used to physically fix the system when using it in a public place. The locking device has to be purchased separately. The appearance and locking method may differ from the illustration depending on the manufacturer. Please refer to the manual provided with the Kensington lock for proper use.

1

Insert the locking device into the Kensington slot on the LCD TV(Figure 1), and turn it in the locking direction(Figure 2).

2

Connect the Kensington lock cable.

3

Fix the Kensington lock to a desk or a heavy stationary object.

Retractable Stand

Note: The maximum tilt angle is 7 degrees in the backward direction.

Please do not tilt the TV outside the specified range. Using excessive force to tilt the TV may cause permanent damage to the mechanical part of the stand.

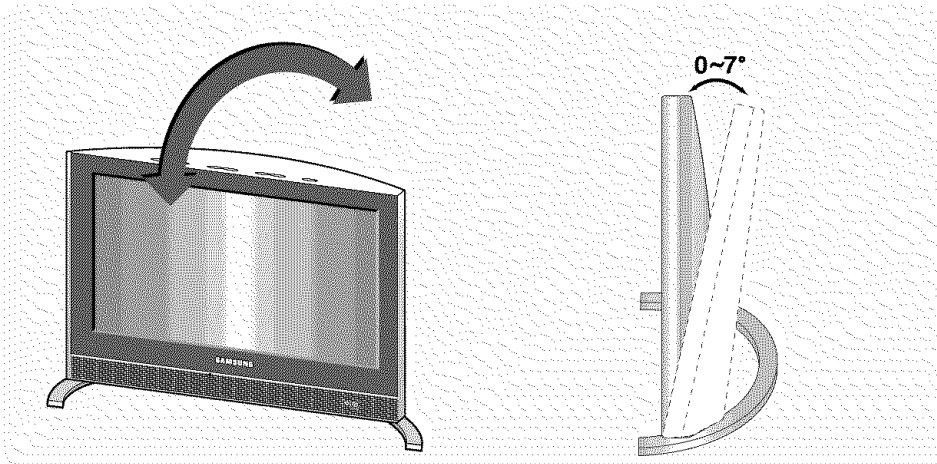

Cleaning and Maintaining Your TV

With proper care, your TV unit will give you many years of service. Please follow these guidelines to get the maximum performance from your TV.

Placement

- Do not place the TV near extremely hot, cold, humid or dusty places.
- Do not place the TV near appliances with electric motors that create magnetic fields, such as vacuum cleaners.
- Keep the ventilation openings clear; do not place the TV on a soft surface, such as cloth or paper.
- Place the TV in a vertical position only.

Liquids

- Do not handle liquids near or on the TV.
Liquids that spill into it can cause serious damage.

Cabinet

- Never open the cabinet or touch the parts inside.
- Wipe your TV with a clean, dry cloth. Never use water, cleaning fluids, wax, or chemicals.
- Do not put heavy objects on top of the cabinet.

Temperature

- If your TV is suddenly moved from a cold to a warm place, unplug the power cord, and allow at least two hours for moisture that may have formed inside the unit to dry completely.

Using Your TV in Another Country

If you plan to take your TV with you to a foreign country, please be aware of the different television systems that are in use around the world. A TV designed for one system may not work properly with another system due to differences in the TV channel frequencies.

APPENDIX

Specifications

Model Name		LTP227W
Panel	Size Display Size Type Pixel Pitch Viewing Angle	22.0 inch Diagonal 487.68 (H) X 274.32(V) mm PVA 0.381(H) X 0.381(V)mm 170(H)/170 (V)
*Frequency	Horizontal Vertical Display Color	30 ~ 68 kHz 56 ~ 85 Hz 16,194,277 colors
Display Resolution	Maximum Mode	1280 X 720 @ 60 Hz
Input Signal	Sync Signal Video Signal	H/V Separate, TTL, P. or N. RGB, Analog, 0.7 Vp-p @ 75 ohm
Video	Color System Video System	NTSC CVBS, S-VHS, RGB
Component	Video In Audio In	1.0 Vp-p @ 75 ohm 500mVrms
Power Supply	Input	AC 100 ~ 240 V (50/60Hz)
Power Consumption	Normal Power Saving	80 W < 5 W
Dimensions / Weight	Unit (WxDxH): body With Stand	23.58 x 4.43 x 16.45 inch / 18.21 lbs (599 x 112.7 x 418 mm / 8.26 kg) 23.58 x 8.24 x 17.28 inch / 19.79 lbs (599 x 209.4 x 439 mm / 8.98 kg)
Environmental Considerations	Operating Temperature Operating Humidity Storage Temperature Storage Humidity	50 °F to 104 °F (10 °C to 40 °C) 10% to 80% -13 °F to 113 °F (-25 °C to 45 °C) 5% to 95% -4
Audio Characteristics	Audio Input 1 Audio Input 2 Headphone Out Frequency Response	RCA Jack Red(R) White(L), 0.5Vrms (-9dB) 3.5ø Stereo Jack, 0.5Vrms (-9dB) Max. 10mW Output (3.5ø Stereo Jack 32) RF: 80Hz ~ 15kHz (at- 3dB) A/V: 80Hz ~ 20kHz (at - 3dB)

* Referring to Display Modes, page 66.

APPENDIX

Display Modes

If the signal from the system equals the standard signal mode, the screen is adjusted automatically. If the signal from the system doesn't equal the standard signal mode, adjust the mode by referring to your Videocard user guide; otherwise there may be no video. For the display modes listed below, the screen image has been optimized during manufacture.

Mode	Resolution	Horizontal Frequency (kHz)	Vertical Frequency (Hz)	Pixel Clock Frequency (MHz)	Sync Polarity (H/V)
Macintosh	640 X 480	35.000	66.667	30.240	- / -
	832 X 624	49.726	74.551	49.500	+ / +
IBM	640 X 480	31.496	59.940	25.175	- / -
	720 X 400	31.469	70.087	28.322	- / -
VESA	640 X 480	37.861	72.809	31.500	- / -
	640 X 480	37.500	75.000	31.500	- / -
	640 X 480	43.269	85.008	36.000	- / -
	800 X 600	35.156	56.250	36.000	+ / -
	800 X 600	37.879	60.317	40.000	+ / +
	800 X 600	48.077	72.188	50.000	+ / +
	800 X 600	46.875	75.000	49.500	+ / +
	800 X 600	53.674	85.061	56.250	- / -
	1024 X 768	48.363	60.004	65.000	- / -
	1024 X 768	56.476	70.069	75.000	- / -
	1024 X 768	60.023	75.029	78.750	+ / +
	1024 X 768	68.677	84.997	94.500	+ / +
GTF	1280 X 720	44.769	60.000	74.841	- / +

Setting Up Your Remote Control

After it has been set up properly, your remote control can operate in four different modes: TV, VCR, Cable, or DVD. Pressing the corresponding button on the remote control allows you to switch between these modes, and control whichever piece of equipment you choose.

Note

The remote control might not be compatible with all DVD Players, VCRs and Cable boxes.

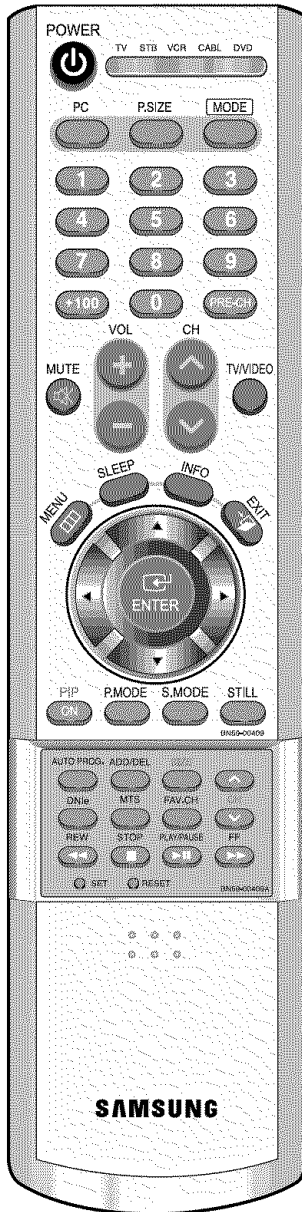

Setting Up the Remote to Operate Your VCR

- 1 Turn off your VCR.
- 2 Press the MODE button and make sure that the VCR LED is illuminated.
- 3 Press the Set button on your TV's remote control.
- 4 Using the number buttons on your remote control, enter three digits of the VCR code listed on page 70 of this manual for your brand of VCR. Make sure you enter three digits of the code, even if the first digit is a "0". (If more than one code is listed, try the first one.)
- 5 Press the Power button on the remote control. Your VCR should turn on if your remote is set up correctly.

If your VCR does not turn on after set up, repeat steps 2, 3, and 4, but try one of the other codes listed for your brand of VCR. If no other codes are listed, try each VCR code, 000 through 088.

Note on Using Remote Control Modes: VCR

When your remote control is in "VCR" mode, the volume buttons still control your TV's volume.

Setting Up the Remote to Operate Your Cable Box

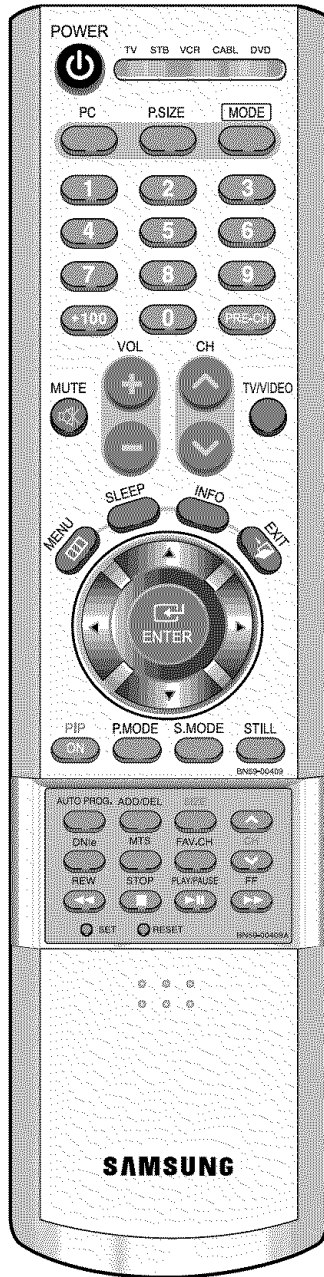

- 1 Turn off your cable box.
- 2 Press the MODE button and make sure that the Cable LED is illuminated.
- 3 Press the SET button on your TV's remote control.
- 4 Using the number buttons on your remote control, enter three digits of the cable box code listed on page 70 of this manual for your brand of cable box. Make sure you enter three digits of the code, even if the first digit is a "0."
If there is more than one code listed, try the first one.
- 5 Press the Power button on the remote control. Your cable box should turn on if your remote is set up correctly.

If your cable box does not turn on after set up, repeat steps 2, 3, and 4, but try one of the other codes listed for your brand of cable box. If no other codes are listed, try each code, 000 through 077.

Note on Using Remote Control Modes: Cable Box

When your remote control is in "Cable Box" mode, the volume buttons still control your TV's volume.

Setting Up the Remote to Operate Your DVD

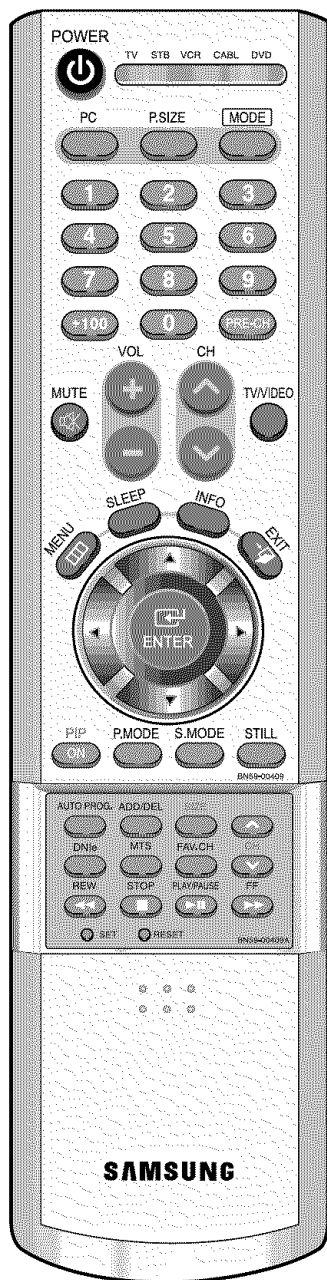

- 1 Turn off your DVD.
- 2 Press the MODE button and make sure that the DVD LED is illuminated.
- 3 Press the SET button on your TV's remote control.
- 4 Using the number buttons on your remote control, enter three digits of the DVD code listed on page 70 of this manual for your brand of DVD. Make sure you enter three digits of the code, even if the first digit is a "0."
If there is more than one code listed, try the first one.
- 5 Press the Power button on the remote control. Your DVD should turn on if your remote is set up correctly.

If your DVD does not turn on after set up, repeat steps 2, 3, and 4, but try one of the other codes listed for your brand of DVD. If no other codes are listed, try each code, 000 through 009.

Note on Using Remote Control Modes: DVD

When your remote control is in "DVD" mode, the volume buttons still control your TV's volume.

Remote Control Codes

VCR Codes

Admiral	015,088	kenwood	011,023,025,039,055	RCA	009,014,016,017,037,044,046,063,078
AIWA	024	KLH	082	Samsung	000,016,022,031,041,051
Audio Dynamics	022,025	LG	001,002,007	Sansui	025
Akai	026,031,032	Lloyd	024	Sanyo	011,021
Bell&Howell	011	Logik	040	Scott	022,050,058,077
Broksonic	019	LXI	024	Sears	011,014,018,021,027,028,044,052,057
Candle	016,018,022,054,055,061	Magnavox	017,038,062,065	Sharp	015,036,048,054
Canon	017,062	Marantz	011,017,023,025,038,039,055,070	Shintom	026,035,040,064
Citizen	016,018,022,054,055,061	Marta		Signature	024
ColorTyme	023	MEI		Sony	026,035,047
Craig	016,021	Memorex		Sylvania	017,024,038,062,065
Curtis-Mathes	009,016,017,023,024,055,062,073,076	MGA		Symphonic	024
Daewoo	003,004,005,006,007,008,022,054,085	Midland		Tandy	011,024
DB	025,023	Minota		Tashiko	
Dimensia	009	Mitsubishi		Tatung	039
Dynatech	024	Montgomery ward		Teac	024,039,078
Electrohome	036	MTC	016,024	Technics	
Emerson	017,018,019,022,024,029,032,036,043,050,051,056,058,066,071,074,076,077,079	Multitech	016,024,040,041	Temika	
Fisher	011,021,027,028,052,057,067	NEC	011,023,025,039,055,070,073	Teknika	018,030
Funai	024	Optimus	015	TMK	076
GE		Panasonic	017,062,084,086	Toshiba	014,022,028,057,058
Go Video	016	Pentax	014,044	Toshiko	018
Goldstar	018,023,055,069	Pentex Reserch+	055	Totevision	016,018
General Electric	009,016,017,041,062	Philco	017,038,062,065	Unitech	
Harman Kardon	023	Philips	017,038	Vector Research	
Hitach	014,024,044,045	Pioneer	014,025,042,059	Victor	
Instant Replay	017	Portland	053,054,061	Video Concepts	
JC Penney	011,014,016,017,023,025,039,044,060,062	ProScan	009	Videosonic	
JCL	011,017,023,025,039,055	Quartz	011	Wards	
JVC		Quasar	017,053	Yamaha	
		Radio Shack/Realistics	011,015,017,018,021,024,028,036,052,062	Zenith	

Cable Box Codes

Anvision	015,016	Macom	045,051	SAEWOO	007
Cable star	015,016	Magnavox	015,016,027,029,034,036,037,040,041,048,049	Signature	054
DeaRyung	003	Nawoo	001	Sprucer	035
DongKuk	004	NSC	017	Starcom	054
DaeHan	005	Oak	024,046	Stargate 2000	066
Eagle	015,016	Osk Sigma	024	Sylvania	019,067
Eastm Int.		Panasonic	011,035,047,069	TaePyungYang	002
Eastern International	020	Philips	015,016,027,029,034,036,037,040,041,048,049	Texscan	019,067
General Instrument	054	Pioneer	026,028,052	Tocom	025,029,057,058,063
GI	012,013,023,031,032,033,038,044,075,076,077	Randtek	015,016	Unika	039,040,049
Hamlin	011,012,020,021,042,056	RCA	008,035,074	Universal	059,060
Hitachi	045,051,054	Regal	011,020,021	Viewstar	015,016,027,029,034,036,037,040,041,048,049
Jerrold	012,013,023,031,032,033,038,044,054,070,073	Regency	010,041	Warner Amex	052
LG	006	SA		Zenith	022,050,065,069
		Samsung	000,011,030,052,071,072		

DVD Codes

CurtisMathes	009	Toshiba	002
JVC	003	Panasonic	006
LG	001	Sony	004
Philips	007	Samsung	000
Proscan	008	Sharp	005
RCA	008		

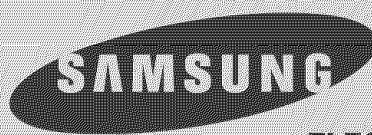

ELECTRONICS

U.S.A **Service Division**
Samsung Electronics America
400 Valley Road, Suite 201, Mount Arlington, NJ 07856
www.samsungusa.com

Canada **Samsung Customer Care**
Samsung Electronics Canada Inc.
7037 Financial Drive, Mississauga, Ontario, L5N 6R3
www.samsung.ca

TEL: 1-800-SAMSUNG(1-800-726-7864)