

Operating Guide | Warranty

Machine Numbers | C32A26 | C36A26

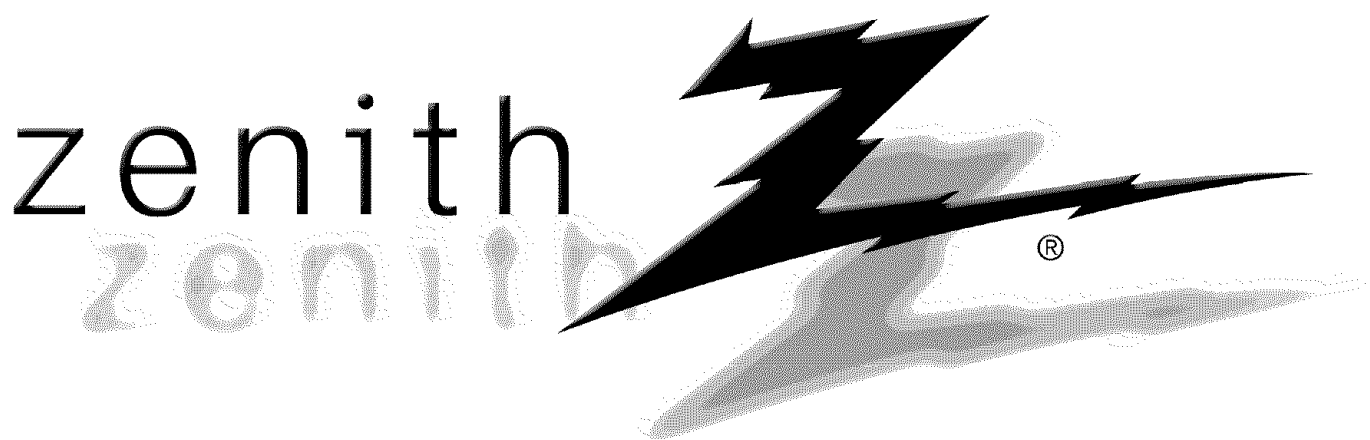

**RECORD YOUR MODEL NUMBER
(Now, while you can see it)**

The model and serial number of your new TV are located on the back of the TV cabinet. For your future convenience, we suggest that you record these numbers here:

MODEL NO. _____

SERIAL NO. _____



WARNING

RISK OF ELECTRIC SHOCK
DO NOT OPEN



WARNING:

TO REDUCE THE RISK OF ELECTRIC SHOCK DO NOT REMOVE COVER (OR BACK). NO USER SERVICEABLE PARTS INSIDE. REFER SERVICING TO QUALIFIED SERVICE PERSONNEL.



The lightning flash with arrowhead symbol, within an equilateral triangle, is intended to alert the user to the presence of uninsulated "dangerous voltage" within the product's enclosure that may be of sufficient magnitude to constitute a risk of electric shock to persons.



The exclamation point within an equilateral triangle is intended to alert the user to the presence of important operating and maintenance (servicing) instructions in the literature accompanying the appliance.

WARNING:

TO PREVENT FIRE OR SHOCK HAZARDS, DO NOT EXPOSE THIS PRODUCT TO RAIN OR MOISTURE.

POWER CORD POLARIZATION:

CAUTION: TO PREVENT ELECTRIC SHOCK, MATCH WIDE BLADE OF PLUG TO WIDE SLOT, FULLY INSERT.

ATTENTION: POUR ÉVITER LES CHOCS ÉLECTRIQUES, INTRODUIRE LA LAME LA PLUS LARGE DE LA FICHE DANS LA BORNE CORRESPONDANTE DE LA PRISE ET POUSSER JUSQU'AU FOND.

NOTE TO CABLE/TV INSTALLER:

This reminder is provided to call the cable TV system installer's attention to Article 820-40 of the National Electric Code (U.S.A.). The code provides guidelines for proper grounding and, in particular, specifies that the cable ground shall be connected to the grounding system of the building, as close to the point of the cable entry as practical.

REGULATORY INFORMATION:

This equipment has been tested and found to comply with the limits for a Class B digital device, pursuant to Part 15 of the FCC Rules. These limits are designed to provide reasonable protection against harmful interference when the equipment is operated in a residential installation. This equipment generates, uses and can radiate radio frequency energy and, if not installed and used in accordance with the instruction manual, may cause harmful interference to radio communications. However, there is no guarantee that interference will not occur in a particular installation. If this equipment does cause harmful interference to radio or television reception, which can be determined by turning the equipment off and on, the user is encouraged to try to correct the interference by one or more of the following measures:

- Reorient or relocate the receiving antenna.
- Increase the separation between the equipment and receiver.
- Connect the equipment into an outlet on a circuit different from that to which the receiver is connected.
- Consult the dealer or an experienced radio/TV technician for help.

COMPLIANCE:

The responsible party for this device compliance is:
Zenith Electronics Corporation, 2000 Millbrook Drive, Lincolnshire, IL 60069, USA, Phone 1-847-941-8000.

CAUTION:

Do not attempt to modify this product in any way without written authorization from Zenith Electronics Corporation. Unauthorized modification could void the user's authority to operate this product.

IMPORTANT SAFETY INSTRUCTIONS

Important safeguards for you and your new product

Your product has been manufactured and tested with your safety in mind. However, improper use can result in potential electrical shock or fire hazards. To avoid defeating the safeguards that have been built into your new product, please read and observe the following safety points when installing and using your new product, and save them for future reference.

Observing the simple precautions discussed in this operating guide can help you get many years of enjoyment and safe operation that are built into your new product.

This product complies with all applicable U.S. Federal safety requirements, and those of the Canadian Standards Association.

1. Read Instructions

All the safety and operating instructions should be read before the product is operated.

2. Follow Instructions

All operating and use instructions should be followed.

3. Retain Instructions

The safety and operating instructions should be retained for future reference.

4. Heed Warnings

All warnings on the product and in the operating instructions should be adhered to.

5. Cleaning

Unplug this product from the wall outlet before cleaning. Do not use liquid cleaners or aerosol cleaners. Use a damp cloth for cleaning.

6. Water and Moisture

Do not use this product near water for example, near a bath tub, wash bowl, kitchen sink, or laundry tub, in a wet basement, or near a swimming pool.

7. Accessories

Do not place this product on an unstable cart, stand, tripod, bracket, or table. The product may fall, causing serious injury to a child or adult, and serious damage to the product. Use only with a cart, stand, tripod, bracket, or table recommended by the manufacturer, or sold with the product. Any mounting of the product should follow the manufacturer's instructions, and should use a mounting accessory recommended by the manufacturer.

8. Transporting Product

A product and cart combination should be moved with care. Quick stops, excessive force, and uneven surfaces may cause the product and cart combination to overturn.



PORTABLE CART WARNING

9. Attachments

Do not use attachments not recommended by the product manufacturer as they may cause hazards.

10. Ventilation

Slots and openings in the cabinet are provided for ventilation and to ensure reliable operation of the product and to protect it from overheating, and these openings must not be blocked or covered. The openings should never be blocked by placing the product on a bed, sofa, rug, or other similar surface. This product should not be placed in a built-in installation such as a bookcase or rack unless proper ventilation is provided or the manufacturer's instructions have been adhered to.

11. Power Sources

This product should be operated only from the type of power source indicated on the marking label. If you are not sure of the type of power supply to your home, consult your product dealer or local power company. For products intended to operate from battery power, or other sources, refer to the operating instructions.

12. Line-Cord Polarization

This product is equipped with a polarized alternating-current line plug (a plug having one blade wider than the other). This plug will fit into the power outlet only one way. This is a safety feature. If you are unable to insert the plug fully into the outlet, try reversing the plug. If the plug should still fail to fit, contact your electrician to replace your obsolete outlet. Do not defeat the safety purpose of the polarized plug.

13. Power-Cord Protection

Power-supply cords should be routed so that they are not likely to be walked on or pinched by items placed upon or against them, paying particular attention to cords at plugs, convenience receptacles, and the point where they exit from the product.

(Continued on next page)

IMPORTANT SAFETY INSTRUCTIONS

(Continued from previous page)

14. Outdoor Antenna Grounding

If an outside antenna or cable system is connected to the product, be sure the antenna or cable system is grounded so as to provide some protection against voltage surges and built-up static charges. Article 810 of the National Electrical Code (U.S.A.), ANSI/ NFPA 70 provides information with regard to proper grounding of the mast and supporting structure, grounding of the lead-in wire to an antenna discharge unit, size of grounding conductors, location of antenna-discharge unit, connection to grounding electrodes, and requirements for the grounding electrode.

Example of Grounding According to National Electrical Code Instructions

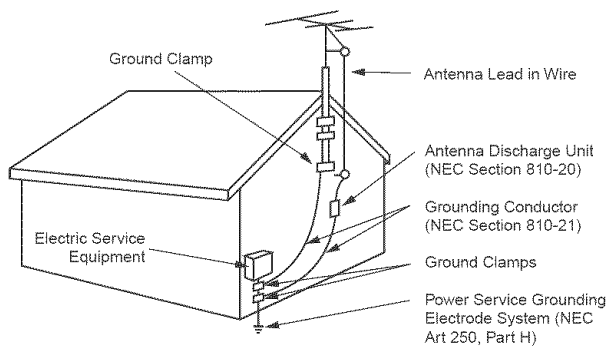

15. Lightning

For added protection for this product (receiver) during a lightning storm, or when it is left unattended and unused for long periods of time, unplug it from the wall outlet and disconnect the antenna or cable system. This will prevent damage to the product due to lightning and power-line surges.

16. Power Lines

An outside antenna system should not be located in the vicinity of overhead power lines or other electric light or power circuits, or where it can fall into such power lines or circuits. When installing an outside antenna system, extreme care should be taken to keep from touching such power lines or circuits as contact with them might be fatal.

17. Overloading

Do not overload wall outlets and extension cords as this can result in a risk of fire or electric shock.

18. Object and Liquid Entry

Never push objects of any kind into this product through openings as they may touch dangerous voltage points or short-out parts that could result in a fire or electric shock. Never spill liquid of any kind on the product.

19. Servicing

Do not attempt to service this product yourself as opening or removing covers may expose you to dangerous voltage or other hazards. Refer all servicing to qualified service personnel.

20. Damage Requiring Service

Unplug this product from the wall outlet and refer servicing to qualified service personnel under the following conditions:

- If the power-supply cord or plug is damaged.
- If liquid has been spilled, or objects have fallen into the product.
- If the product has been exposed to rain or water.
- If the product does not operate normally by following the operating instructions. Adjust only those controls that are covered by the operating instructions as an improper adjustment of other controls may result in damage and will often require extensive work by a qualified technician to restore the product to its normal operation.
- If the product has been dropped or the cabinet has been damaged.
- If the product exhibits a distinct change in performance.

21. Replacement Parts

When replacement parts are required, be sure the service technician has used replacement parts specified by the manufacturer or have the same characteristics as the original part. Unauthorized substitutions may result in fire, electric shock, or other hazards.

22. Safety Check

Upon completion of any service or repairs to this product, ask the service technician to perform safety checks to determine that the product is in proper operating condition.

23. Wall or Ceiling Mounting

The product should be mounted to a wall or ceiling only as recommended by the manufacturer.

24. Heat

The product should be situated away from heat sources such as radiators, heat registers, stoves, or other products (including amplifiers) that produce heat.

Table Of Contents

Turn to the next page to set up your Entertainment Machine™

Safety Warnings	2	Captions, Captions/Text	22
Important Safety Instructions	3 - 4	Language	23
Table of Contents	5	Source Menu	
		Select Main Picture and PIP sources	24
Step 1. Hook Up TV		Video Menu	25
Hookup Directory	6	Contrast, Brightness, Color, Tint, Sharpness, Color Temp: (Cool, Warm), EZ Picture: (Custom, Normal, Movie, Digital Pres, Video Game, Sports, Weak Signal, Night Time).	
TV and other Equipment Hookups		Audio Menu	26
Antenna	7	Bass, Treble, Balance, Audio Mode: (Stereo, Mono, SAP), Front Surround, EZ SoundRite, Speakers, EZ Sound: (Custom, Normal, Stadium, News, Music, Theater).	
Cable service	8	Parental Control Menu	27 - 29
Antenna with VCR	9	Restricts viewer programming.	
Cable Service with VCR	10	Special Menu	
Super VHS VCR/Digital Video Disk Player	11	EZ Timer	
External Audio Connections	12	Sleep Timer, On Time, Off Time, On/Off Timer	30
Step 2. Channel Search and Reception Setup		Channel Labels	31
EZ Program	13	XDS Display	32
(Select Antenna, or cable service and perform channel search)		PIP Menu	33
Remote Control TV Mode Key Functions	14	Picture-in-Picture Overview and Explanation 34 - 35	
Remote On-Screen Menu Operation	15	EZ Demo (On-screen menus overview)	36
Front Panel Controls	16	EZ Help	37
Selecting Viewing Sources	17	Remote Control Multi-Product Usage Programming 38 - 44	
On-Screen Menus/Displays Overview	18	Maintenance	45
On-Screen Displays	19	Trouble Shooting	46 - 48
Step 3. Customize Your TV's Features		Glossary	49
Setup Menu (Starts with page 13, EZ Program)		Notes	50
EZ Program	13	Zenith Accessory Products	Inside Back Cover
Add/Del/Surf	20	Warranty	Back Cover
EZ Clock	21		

Features on this TV also include:

PIP - 2-Tuner Picture-in-Picture, see page 34.

Programmable Remote Control - Remote may control up to 7 products, see page 38.

Extended data service (XDS) shows in-depth program information, see page 32.

EZ Features: Designed to make your viewing experience less work; see the EZ Help menu on page 3.

EZ Program	Finds channels in your area automatically.
EZ Clock	Sets the time in the TV's clock.
EZ Picture	Customizes video level settings.
EZ Sound	Adjusts sound based on program.
EZ SoundRite	Maintains and even sound level during programming volume variances.
EZ Timer	Sets times to turn TV on/off automatically.
EZ Mute	Displays Closed Captions/Text selection when TV sound is mute, while picture remains.
EZ Demo	Shows menus and displays on this TV.
EZ Help	Offers solutions to common problems on one convenient menu.

Note: Design and specifications are subject to change without prior notice.

Hookup Directory

This page directs you to the appropriate page for hook up of your Entertainment Machine

IMPORTANT!!

Use this page to decide where you need to begin your setup. First, find the line below that best describes what you want to do, then go to that page number.

Note: Design and specifications are subject to change without prior notification.

Antenna only

If you are using an antenna and no other equipment, go to page 7

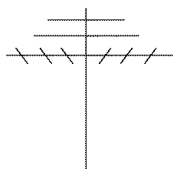

Cable only

If you subscribe to cable service and use no other equipment, go to page 8

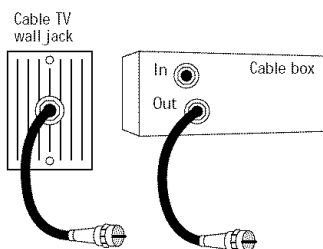

Antenna with VCR

If you are using an antenna and have a VCR, go to page 9

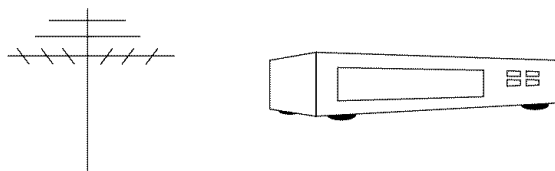

Cable and VCR

If you subscribe to cable service and have a VCR, go to page 10

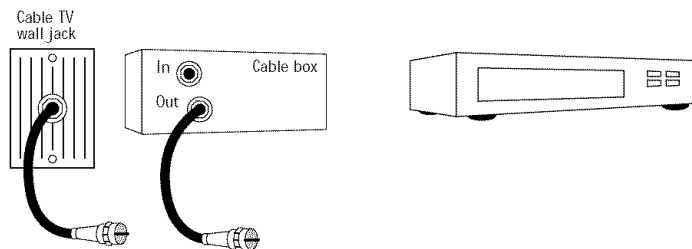

S-VHS/DVD/Stereo

If you have a Super VHS VCR, a DVD Player, go to page 11

If you want to connect Audio equipment, go to page 12

Hook Up an Over the Air Antenna

Connect an off air antenna to your Entertainment Machine

1 Hook up your Entertainment Machine, see diagrams at right.

2 Remove the back of the remote and put in two AAA batteries.

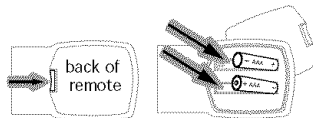

3 Plug in your TV. Do not plug it into a switched outlet.

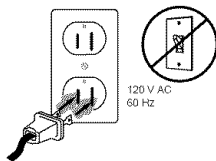

4 Go to page 13 to EZ Program your Entertainment Machine.

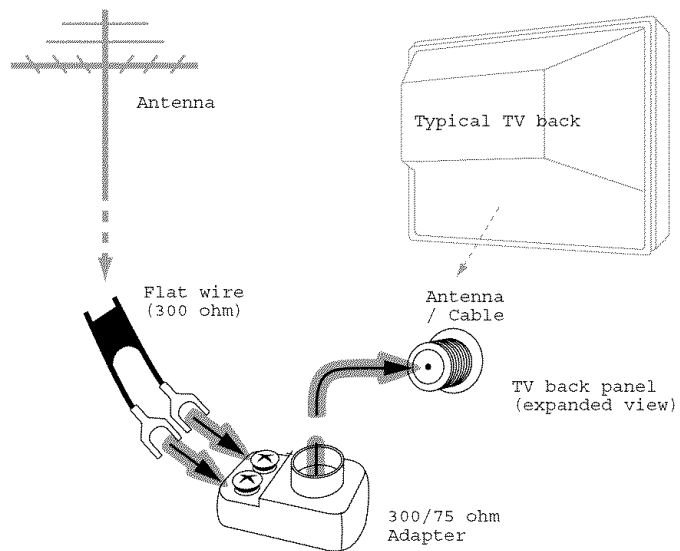

If you have a 75 ohm RF cable, then you don't need any adapters!



Remember, when screwing RF cables onto jacks, clockwise tightens, and counterclockwise loosens.



A 300 to 75 ohm adapter is not included with your Zenith Entertainment Machine.

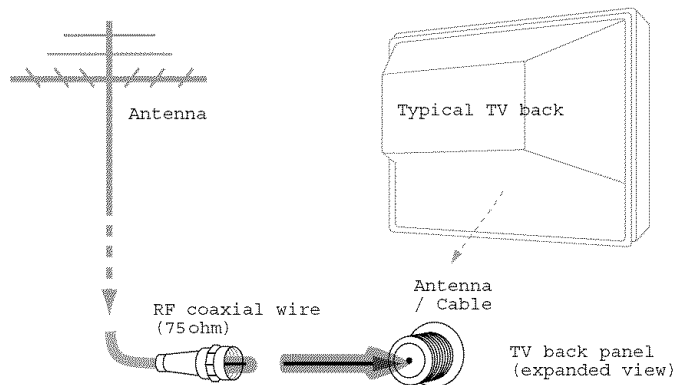

Mini glossary

- 75 OHM RF CABLE** The wire that comes from an off air antenna or cable service provider. Each end looks like a hex shaped nut with a wire sticking through the middle, and it screws onto the threaded jack on the back of your TV.
- 300-75 OHM ADAPTER** A small device that connects a two-wire 300 ohm antenna to a 75 ohm RF jack. They are usually about an inch long with two screws on one end and a round opening with a wire sticking out on the other end.

Hook Up Cable Service (CATV)

Connect Cable Service to your Entertainment Machine

1 Hook up your Entertainment Machine, see diagrams at right.

2 Remove the back of the remote and put in two AAA batteries.

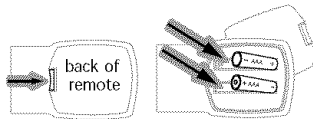

3 Plug in your TV. Do not plug it into a switched outlet.

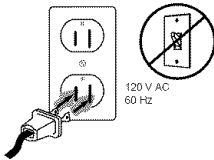

4 Go to page 13 to EZ Program your Entertainment Machine.



If you're using a cable box, leave your TV on channel 3 or 4 and use your cable box to change channels.



Remember to set the cable box output channel switch to channel 3 or 4.



If you're using a cable box, EZ Program (page 13) might only find the channel your cable service is on (usually channel 3 or 4). Don't worry, that's all you need!

Without Cable Box

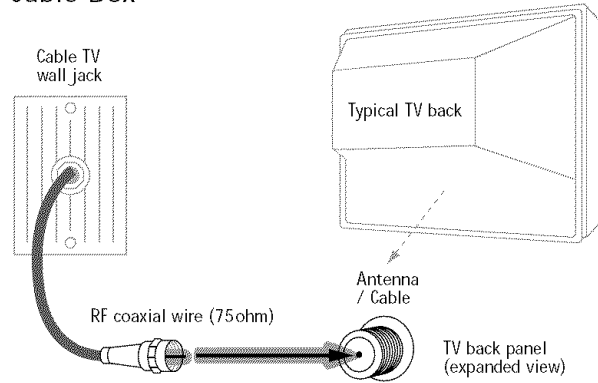

With Cable Box

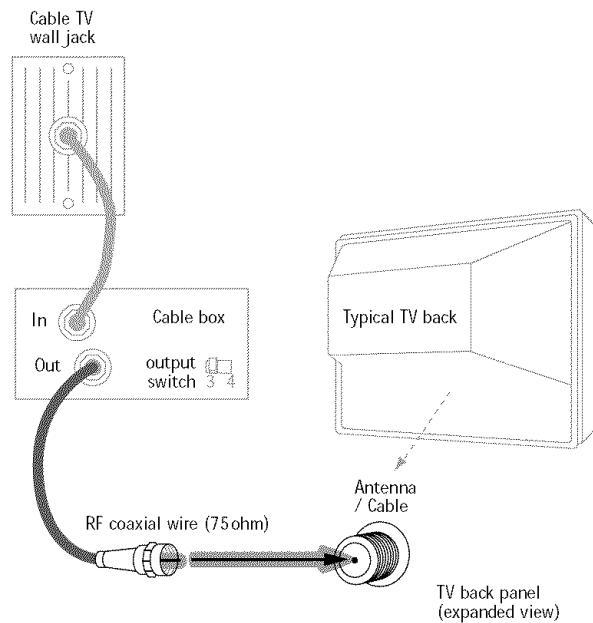

Mini glossary

CABLE SERVICE The wire that supplies all your cable TV (CATV) stations.

Hook Up Antenna and a VCR

Connect an off air antenna and VCR to your Entertainment Machine

1 Hook up your Entertainment Machine, see diagrams at right.

2 Remove the back of the remote and put in two AAA batteries.

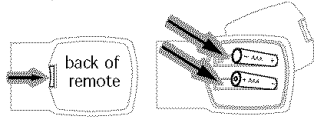

3 Plug in your TV. Do not plug it into a switched outlet.

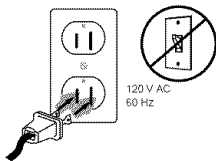

4 Go to page 13 to EZ Program your Entertainment Machine.



Remember to set the VCR output channel switch to channel 3 or 4.



Video sources provide better picture and sound.



Without A/V cable hookup, VCRs will not play videocassettes in stereo sound.

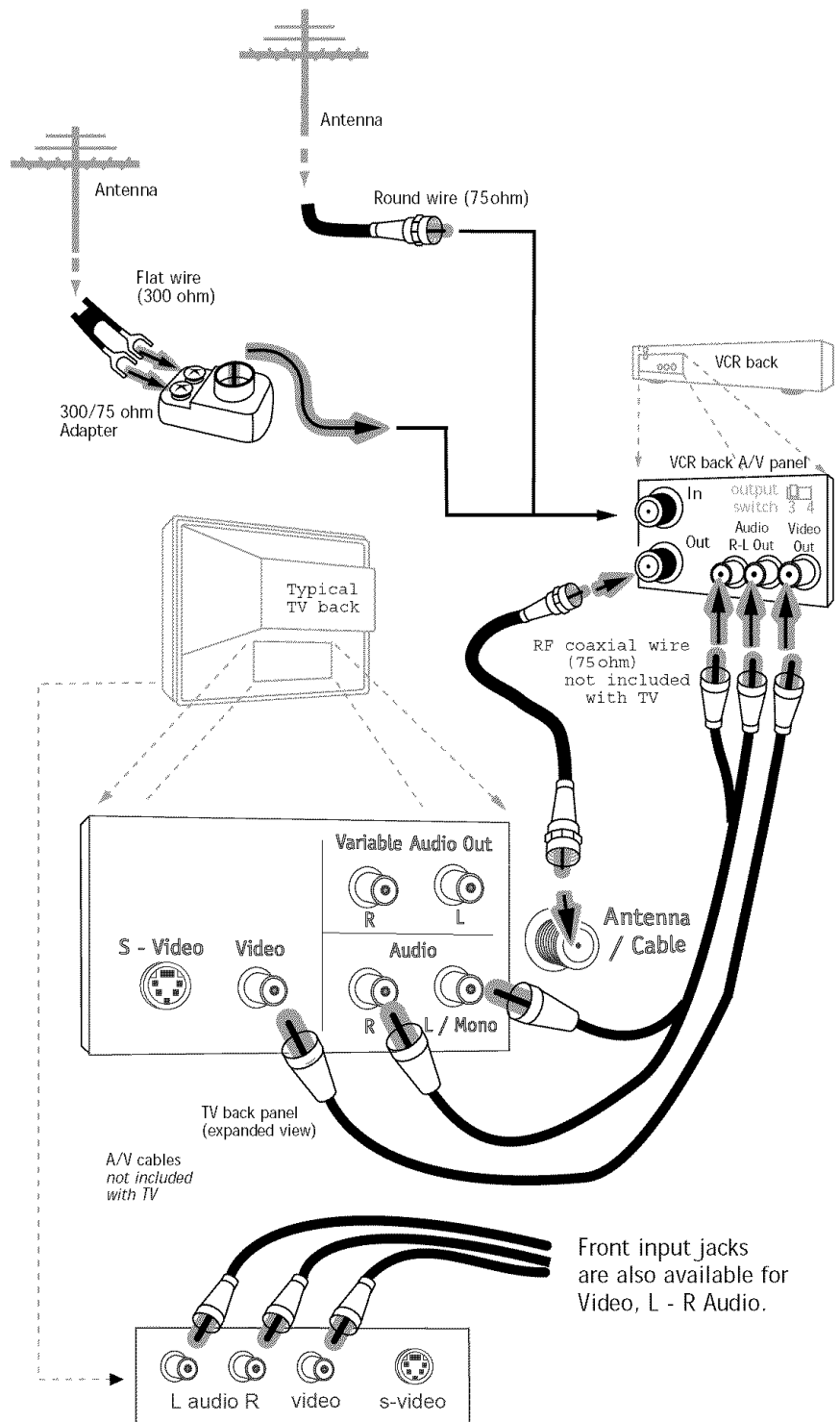

Hook Up Cable (CATV) and a VCR

Connect Cable service and a VCR to your Entertainment Machine

1 Hook up your Entertainment Machine, see diagrams at right.

2 Remove the back of the remote and put in two AAA batteries.

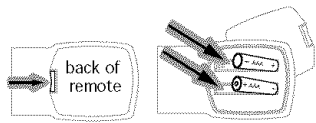

3 Plug in your TV. Do not plug it into a switched outlet.

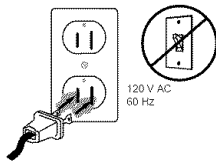

4 Go to page 13 to EZ Program your Entertainment Machine.



Leave your VCR and your television tuned to channel 3 or 4 and use the cable box to change channels.



Remember to set the cable box output channel switch to channel 3 or 4.



Auxiliary sources provide better picture and sound than do antenna or cable inputs.



No A/V cables are included with your Zenith Entertainment Machine.

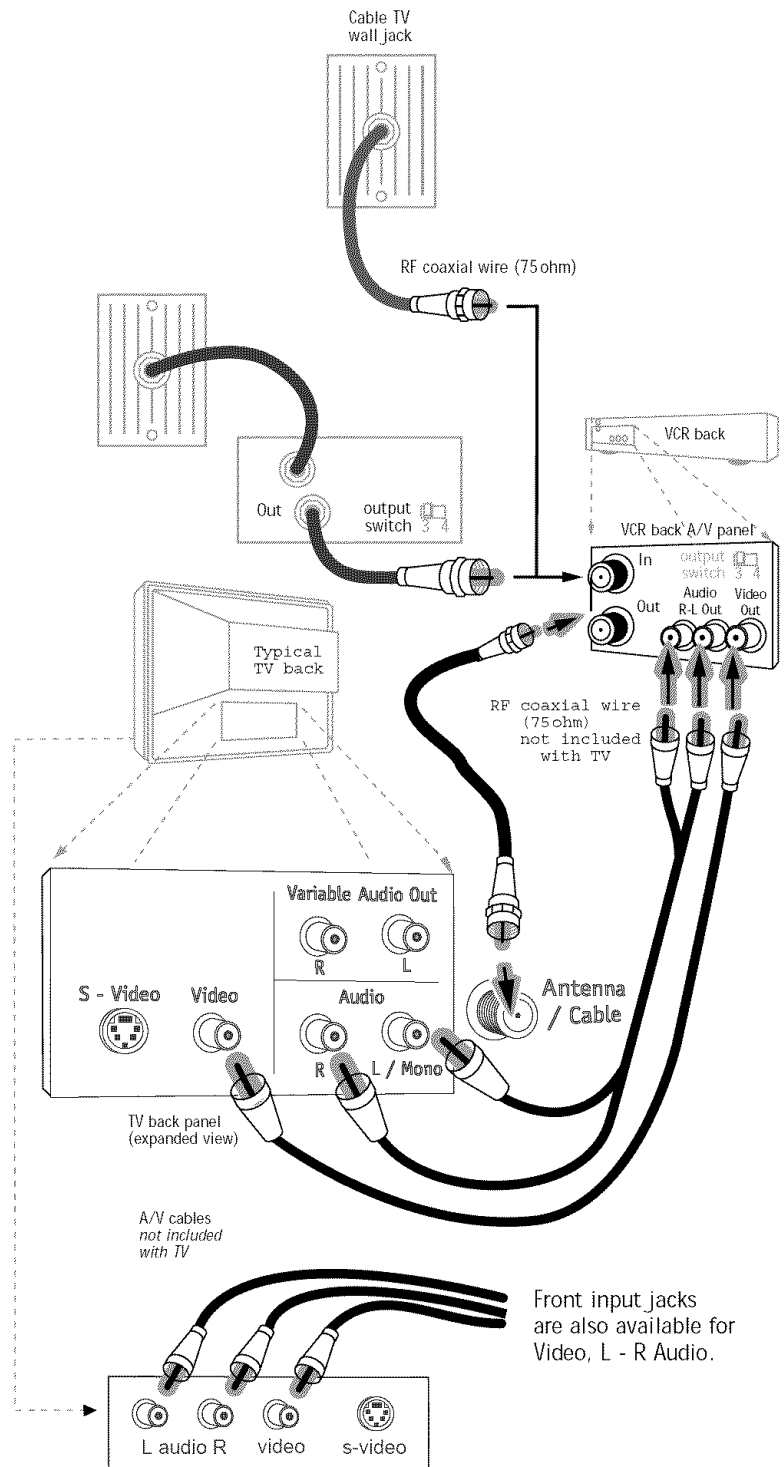

Super VHS VCR / DVD Player

Connecting a S-VHS VCR or DVD player to your Entertainment Machine

Super VHS VCR

- 1** Locate the Ant In jack on the back of your S-VHS VCR. Connect the cable line coming from your wall directly to this jack.
- 2** Now locate the Out to TV jack. Connect a cable from the Out to TV jack to the ANTENNA/CABLE jack on the back of your TV.
- 3** Find the audio and S-Video jacks on the back of your S-VHS VCR, and connect them following the instructions provided with your equipment.

DVD (Digital Video Disk) Player

Simply connect the S-Video/Audio out on the DVD to the S-Video, Audio R-L Mono on the TV.

(VCR Only)
Attach to cable wall jack, cable box, or antenna

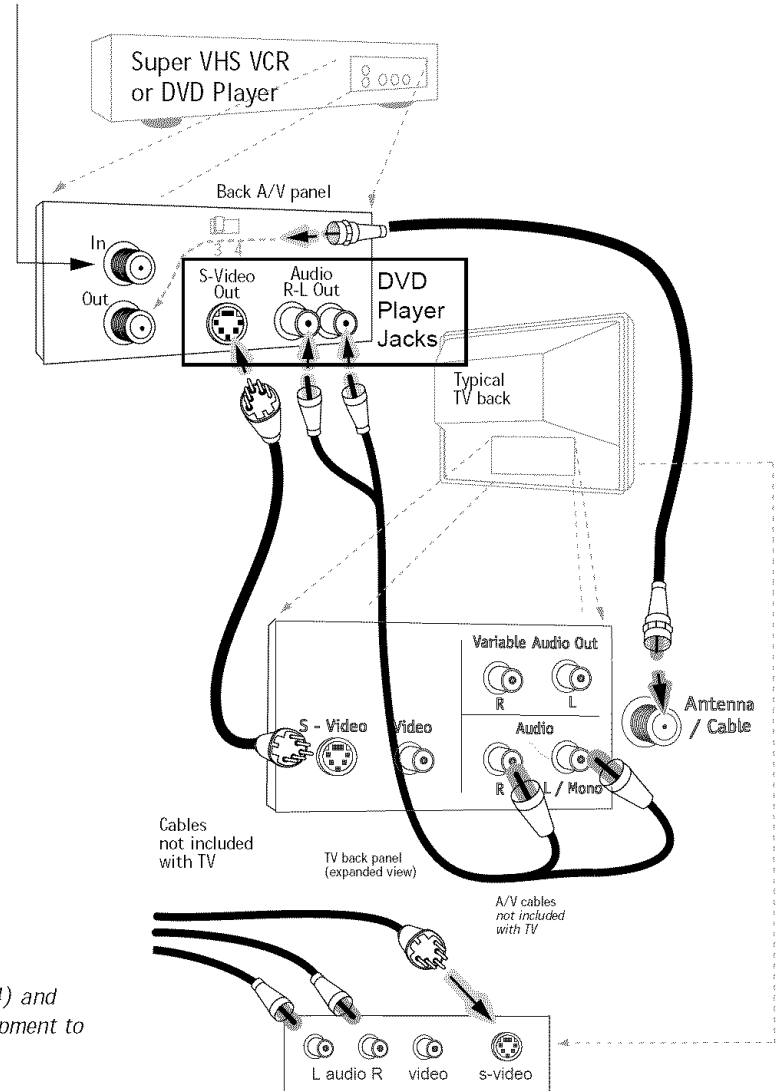

 To use with PIP: go to the Source Menu (page 24) and choose the jack you've connected your S-VHS equipment to as the Main or PIP source.

 Both Video and S-Video jacks are available. You can connect equipment to either of these input jacks but not at the same time. Use the R - L Audio input jacks with either the S-Video or Video input.

Mini glossary

- S-VHS Provides higher quality picture and sound than an ordinary VCR when connected to the S-Video jacks.
- DVD PLAYER Digital Video Disks can be connected to the S-Video jacks to provide the highest quality reproduction available from this technology.

External Audio Connection

Use your stereo to play the sound from your Entertainment Machine

1

Locate the jacks marked VARIABLE AUDIO OUT, R - L. These are for the stereo system. Connect the stereo system's cables, according to their color (red is the right channel, white the left) to these jacks.

Before you begin plugging in your stereo system, it's a good idea to put it in its approximate place first. That way you know how much wire you have or will need.

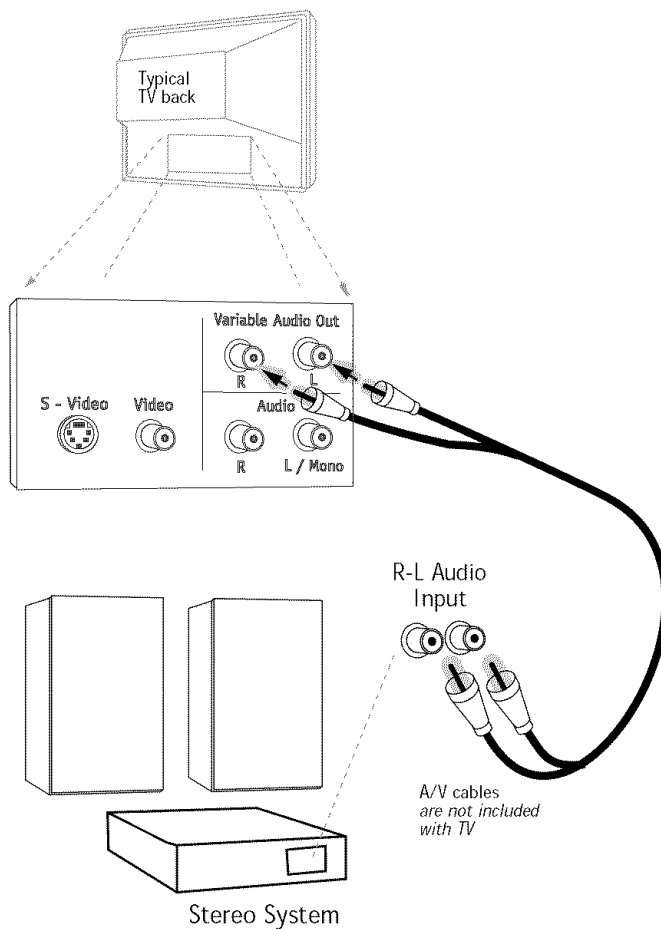

EZ Program (Channel Search)

Use EZ Program to automatically find and store in the TV's memory all the channels in your area

Select:

*AIR ANTENNA, If you receive over-the-air programs.
CABLE TV, If you subscribe to a cable service.*

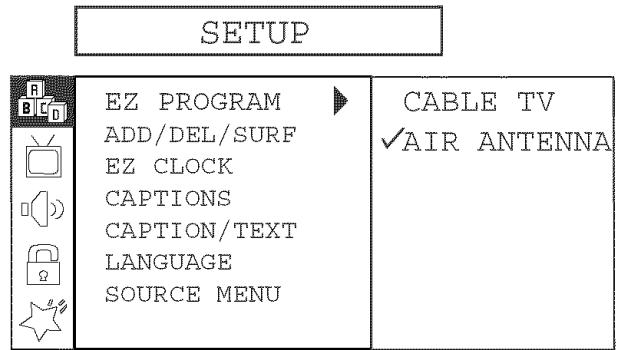

- 1** Press MENU repeatedly until the SETUP menu appears.
- 2** Using the Up or Down arrow on the remote control, select EZ Program on your screen.
- 3** Press the Right arrow to go to the EZ Program options.
- 4** Using the Up or Down arrow, choose either Air Antenna, or Cable TV on your screen.
- 5** Press the RIGHT arrow to begin the channel search.
- 6** When the search is complete, press QUIT repeatedly to return to TV viewing.



Note: EZ Program finds channels being received by the TV tuner.



Cable will not work unless you subscribe to a cable service.

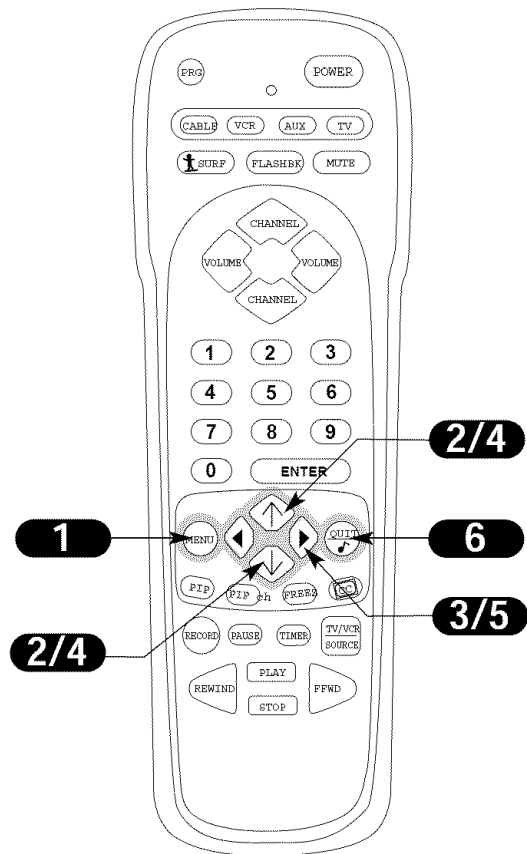

Mini glossary

- AIR ANTENNA** The device receiving the program signal broadcast over-the-air.
- CABLE TV** Your EZ Program selection, if you subscribe to a cable service.

Remote Key Functions for TV Mode

Note: Pressing TV puts remote into TV operating mode

A quick list of the keys on your remote and what they do in TV mode, see page 44 for remote key functions in the other modes

PRG (PROGRAM)
Programs your remote to operate other products. See page 38.

FLASHBK (FLASHBACK)
Return to the last channel viewed.

SURF
Press to turn Surf channel scan on and off for channel scanning using Channel Up/Down. On=Only Surf channels appear. Off=Normal channel scan.

CHANNEL UP / DOWN
Tunes to next available channel.

MENU
Shows on-screen menus for TV mode. See page 18.

(MENU) LEFT / RIGHT DIRECTIONAL ARROWS
The Left/Right directional arrows *select* and *adjust* menu options.

PIP FEATURES
For PIP (Picture-in-Picture) operation. See page 34.

TIMER
Displays the Sleep Timer Menu. See page 30.

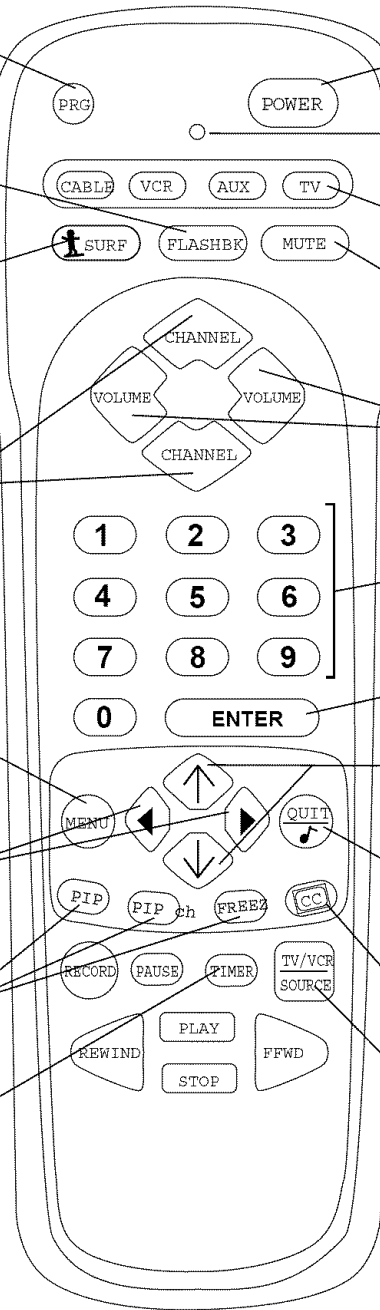

POWER
Turns TV On or Off.

LED INDICATOR LIGHT
Lights when keys are pressed.

CABLE / VCR / AUX / TV
Selects remote operating mode.

MUTE
Turns sound Off and On while the picture remains.

VOLUME LEFT / RIGHT
Adjusts the sound level.

NUMBER KEYPAD
Selects channels directly and enters numeric values for some options.

ENTER
Shows the Channel/Time display.

(MENU) UP / DOWN DIRECTIONAL ARROWS
The Up/Down directional arrows *select* and *adjust* menu options.

QUIT / MUTE
Removes on-screen menu/display from view. With no menus shown on-screen, turns front surround sound on and off.

CLOSED CAPTIONS
Selects Off, On, or EZ Mute.

TV / VCR SOURCE
Switches between watching TV through antenna/cable, or one of the video sources.



Keys dedicated to VCR functions will still operate your VCR while the remote is in TV mode.

remote control part number
MBR3458CT
(124-233-06)

On-Screen Menu Operation

Use either the remote or the TV front controls to access the on-screen menus

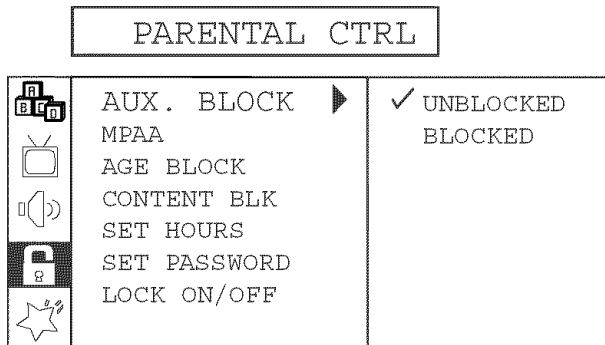

MENU NEXT MENU ◀ MOVE ▶ NEXT

- 1** Press MENU repeatedly on the remote control, to "select" one of the five main menus on your screen like PARENTAL CONTROL.
- 2** Use the UP/DOWN directional arrow to select an option like AUX. BLOCK. (You can select the other menu options like AGE BLOCK by pressing the UP or DOWN directional arrow repeatedly.)
- 3** Once the option is selected, in this case AUX BLOCK, press the RIGHT directional arrow to go to the next selection of options.
- 4** Use the UP or DOWN directional arrow to choose an option, in this case BLOCKED or UNBLOCKED.
- 5** When finished, press MENU repeatedly to go back to the main menu or press QUIT to remove the menus and submenus from the TV screen.



On-screen menus automatically disappear after about 10 seconds.



Remote must be in the TV mode for it to control the TV. Press TV on the remote to select TV mode.

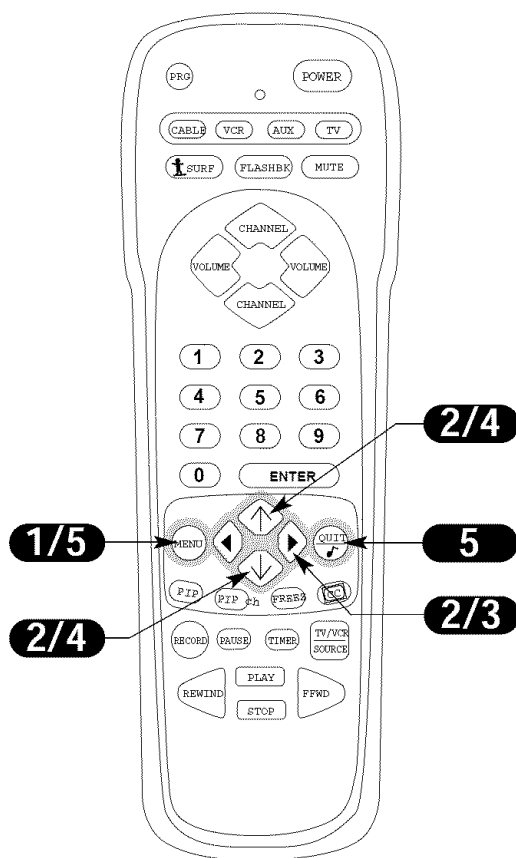

Mini glossary

MENU	On-screen displays you use to program the TV features.
UP/DOWN	Use the Menu UP or DOWN directional arrow to "select" or highlight and choose menu options.
LEFT/RIGHT	Use the Menu LEFT or RIGHT directional arrow to move to or return from the menu options listings.
QUIT	Exits menus and removes o-screen displays.
ENTER	Returns to the previously selected menu option on some menus.

Front Panel Controls

How to use your front control panel to operate the menus

When using the on-screen menus, the buttons on the TV front panel correspond to the remote control keys as follows:

CHANNEL = Moves Up/Down
VOLUME = Moves Left/Right

- 1** To access the on-screen menus, press MENU. Pressing MENU repeatedly will cycle through the available menus.
- 2** Highlight the option you want using the DOWN or UP Channel arrow.
- 3** ADJUST or change the selected feature using the LEFT or RIGHT Volume arrow.
- 4** Wait a few moments and the menus will disappear by themselves or press MENU repeatedly to remove menus.



Menus disappear by themselves. To get them back, press MENU again.



If you've lost your remote, you can get a new one by calling 1-800-255-6790 to purchase a replacement.

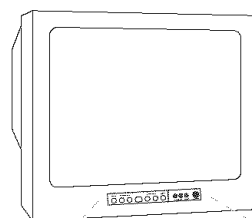

Typical TV Front Panel

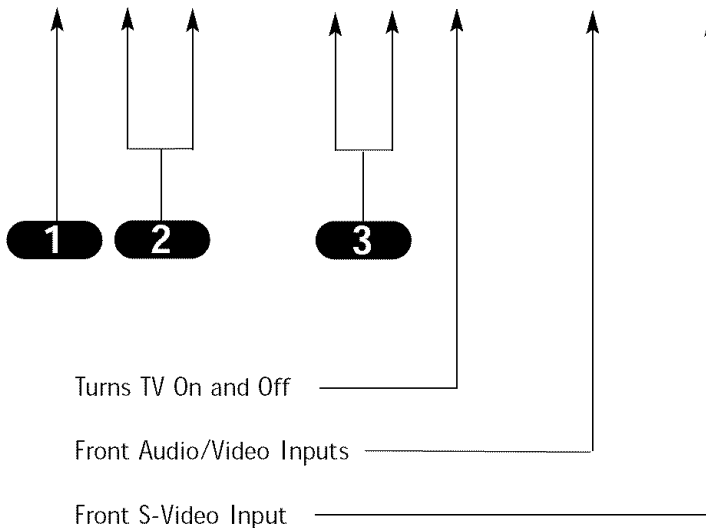
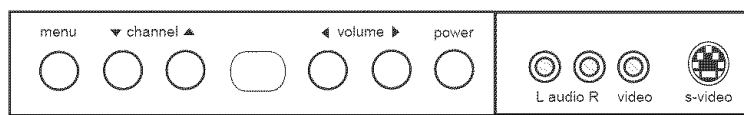

Selecting Viewing Sources

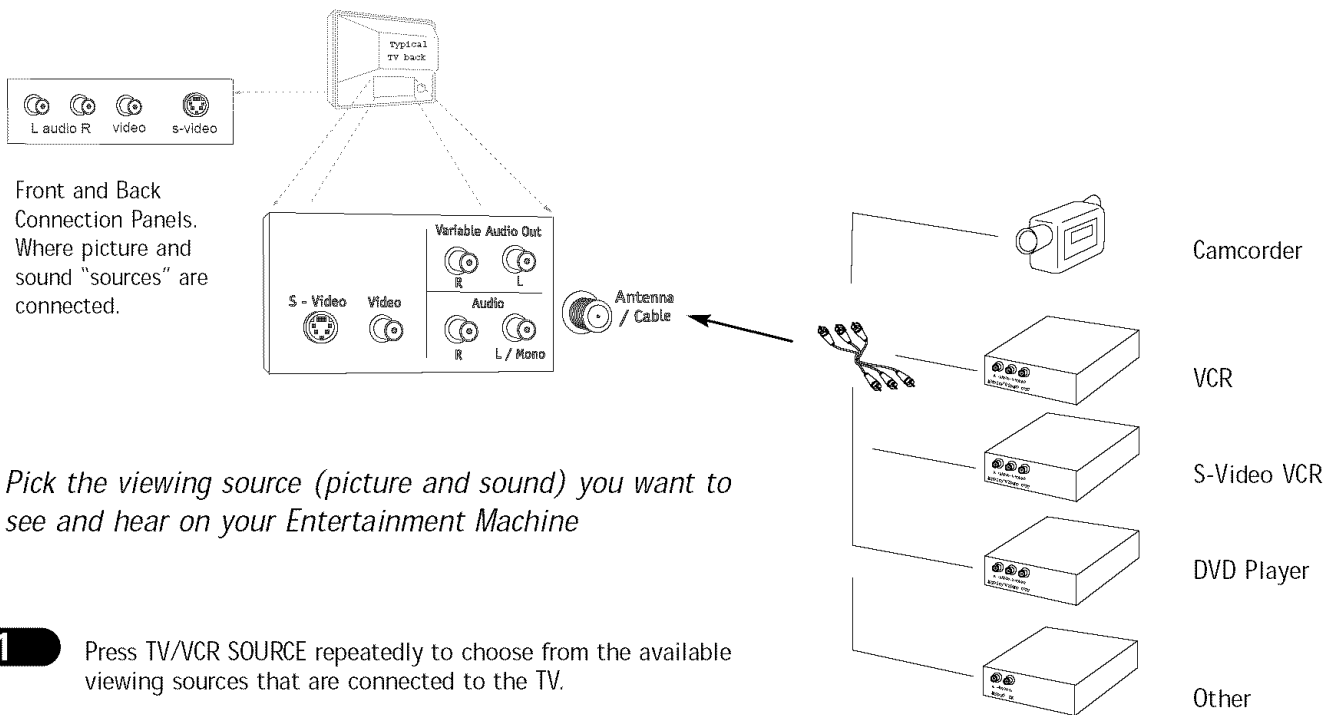

Pick the viewing source (picture and sound) you want to see and hear on your Entertainment Machine

1 Press TV/VCR SOURCE repeatedly to choose from the available viewing sources that are connected to the TV.

Available Sources:

Back Connections Panel

ANTENNA/CABLE: ANTENNA/CABLE on TV back Jackpack, Over-the-Air Antenna or Cable service signal source.

Video 1: Video on TV back Jackpack, Audio/Video Inputs.

S-Video 1: S-Video on TV back Jackpack, Audio/Video Inputs.

Front Connections Panel

Video 2: Video on TV Front Jackpack, Audio/Video Inputs.

S-Video 2: S-Video on TV Front Jackpack, Audio/Video Inputs.

Typical Equipment Sources

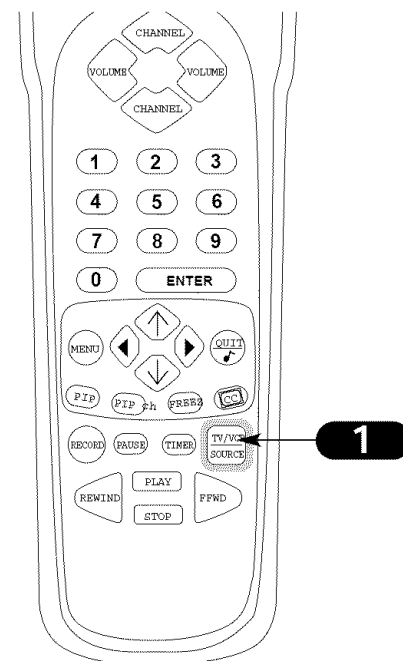

The sources you intend to view should be turned on.



You can connect equipment to the Video or S-Video jacks, but not at the same time. Use the Audio input jacks with either the S-Video or Video input.

Descriptions of the menus and displays on your Entertainment Machine

Menu Name	Page	Description/Function
ON-SCREEN MENUS		
SETUP	13	Sets the TV up and adjusts the basic features. Your options are:
EZ Program	13	Automatically finds and stores active channels you will choose using Channel Up/Down.
Add/Del/Surf	20	Choose which channels will appear when using Channel Up/Down. Adds favorite channels to Surf list.
EZ Clock	21	Sets the TV's clock.
Captions	22	Turns closed captioning on, off, or set it to come on when the television sound is muted.
Caption/Text	22	Chooses a captioning or text option.
Language	23	Chooses the language in which you want the on-screen menus to appear.
Source Menu	24	Selects which picture and sound will appear on your TV main screen and PIP inset picture.
VIDEO	25	Adjusts the picture for different viewing situations. Your options are: Contrast, Brightness, Color, Tint, Sharpness, Color Temperature, EZ Picture.
AUDIO	26	Customizes the sound to suit your room and taste. Your options are: Bass, Treble, Balance, Audio Mode, Front Surround, EZ Soundrite, Speakers, EZ Sound.
PARENTAL CTRL	27	Allows parents to block any program or A/V source for up to 99 hours, with the use of a password.
SPECIAL	30	Goes beyond basics and customizes your Entertainment Machine's features. Your options are:
EZ Timer	30	Sleep Timer Sets a time that the TV will automatically turn itself off. On Time Sets the time the TV will turn on automatically each day. Off Time Sets the time the TV will turn off automatically each day. On/Off Timer Enables or disables the On and Off Time features.
Channel Labels	32	Titles the channels with their network names (ABC, CBS, HBO, etc.).
XDS Display	32	On/Off. If available, shows program information when a channel is tuned or ENTER is pressed.
PIP Menu	33	Adjusts the Contrast, Color, Tint, and Size of the PIP picture.
EZ Demo	36	Demonstrates the on-screen menus that control the TV's setup and operational features.
EZ Help	37	Help menu offers several features from different menus that can be adjusted on one convenient menu.
ON-SCREEN DISPLAYS		
Surf's Up	19	Indicates channel selection is in Surf mode.
No Surfing	19	Indicates that Surf channel selection has been turned off and normal channel selection mode is on.
Mute	19	Indicates sound has been removed.
Volume Display	19	Shows the current sound level.
Channel/Time	19	Shows the current time, channel, video/incoming audio signal, and channel label if available.
PIP/Channel	19	Appears on the Channel/Time display if PIP is on.
Sleep Timer	19	Shows the chosen amount of time in which the TV will turn itself off.
Captions/Text	19	Selected caption or text option appears on-screen if provided by broadcaster.

On-Screen Displays

On-screen displays reveal the current status of your Entertainment Machine

A "Surf" Channels Mode Active Display

Press SURF to turn on Surf channels tuning mode; only channels specified as Surf channels will appear when using channel Up/Down.

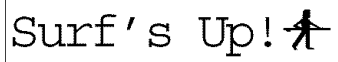

No Surfing

Press SURF to display "No Surfing!" and return to normal channel tuning mode.

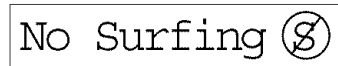

B Mute Display

Press MUTE to quiet sound.
Press MUTE again to remove the sound.
Press MUTE a third time to restore the sound.

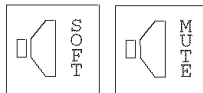

C Volume Display

Press the VOLUME Left/Right arrow on the remote control, to view the sound status.

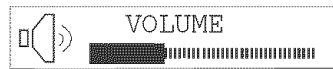

D Channel/Time Display (Shown above with PIP on)

Press ENTER on the remote control to view the Channel-Time-Incoming Audio signal display. Channel selection mode is indicated by flashing source; Main screen or PIP inset. Pressing QUIT/🎵 repeatedly with the Channel/Time display on-screen will move the note symbol allowing you to choose either main screen or PIP as the sound source.

E Remove On-Screen Displays and Menus

Press QUIT/🎵 to remove displays or menus, returning to TV viewing. Or, wait a few moments and the displays or menus will automatically disappear from the screen. 🎵 Turns front surround sound on or off, if no menus are shown on-screen.

F Captions/Text (Appear if available, see above)

Press CC repeatedly to select a Captions/Text option or to turn Captions/Text off.

G Sleep Timer Display

Press TIMER on the remote control to view the Sleep Timer Status Display. Press TIMER repeatedly to set the amount of time before the TV automatically turns itself off.

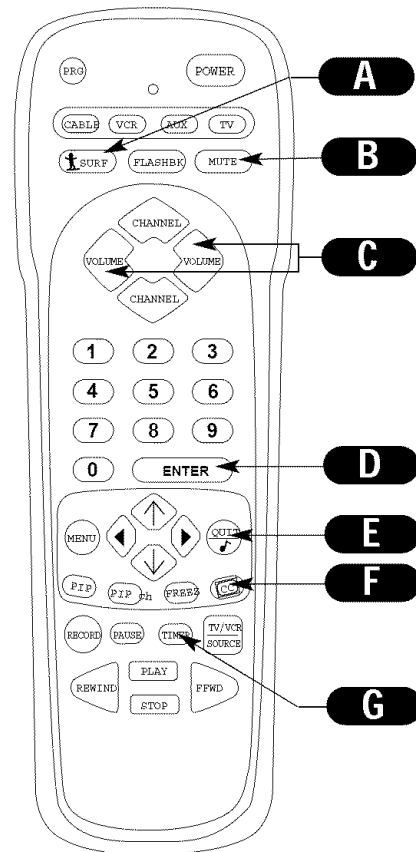
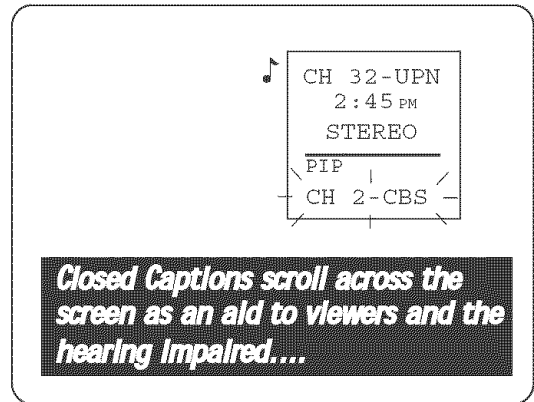
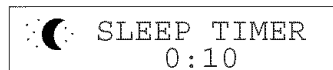

Add/Delete/Surf Channel Menu

Customize your channel selection list:
Add Channels not found by EZ Program

Delete channels you don't watch

Create a favorite channels list to "Surf"
- - with Surf on, only those channels specified
as Surf channels will appear when pressing the
Channel Up/Down keys

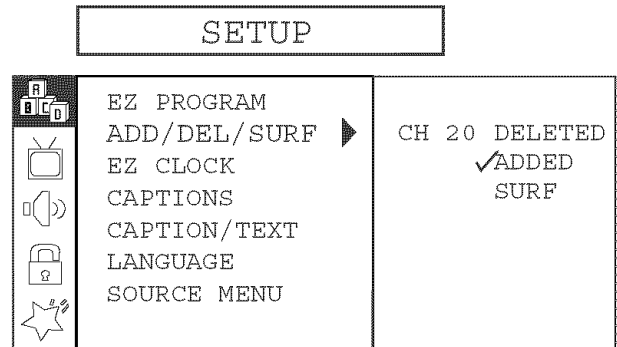

MENU NEXT MENU MOVE NEXT

- 1** Use the NUMBER keypad to go to the Channel you want to add, delete, or include in the Surf channel list.
- 2** Press MENU repeatedly until the SETUP menu appears.
- 3** Use the Up/Down arrow to highlight the Add/Del/Surf option, then press the Right (adjust) arrow.
- 4** Use the Up/Down arrow to pick ADDED or DELETED or SURF; move the check mark next to the option.
- 5** Use MENU to go back to the SETUP menu.
- 6** Press QUIT to remove menu when finished. Or, go to another channel you want to add, delete, or include as a Surf channel by using the NUMBER keypad to select the channel and repeat from Step 3.



If you've deleted a channel, it isn't gone for good. Just select it using the NUMBER keypad on the remote, or add it later.



Surf channels are automatically added.

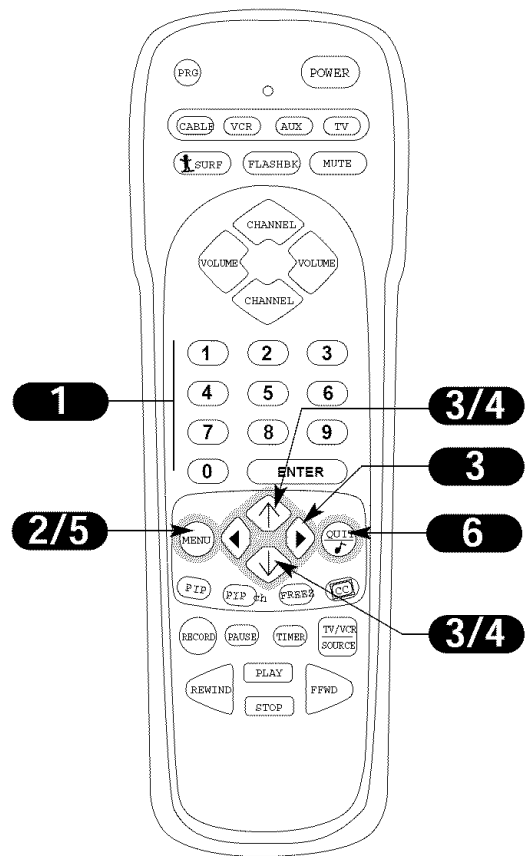

Mini glossary

- ADDED** Includes new channels to the channel list that you'll scroll through when using Channel Up/Down.
- DELETED** Removes channels that you don't watch from the channel list you'll scroll through using Channel Up/Down.
- SURF** Adds your favorite channels to the Surf channel list. Press SURF, channels you specify as Surf channels will be the only ones to appear when you use Channel Up/Down. Press SURF repeatedly to turn Surf off, (No Surfing!) and return TV to normal channel selection mode.

Setting the Clock

Set the clock yourself or have the TV do it for you

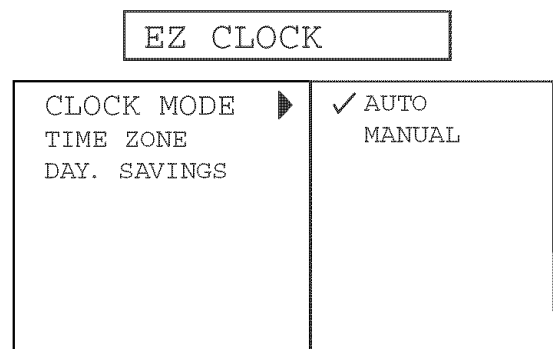
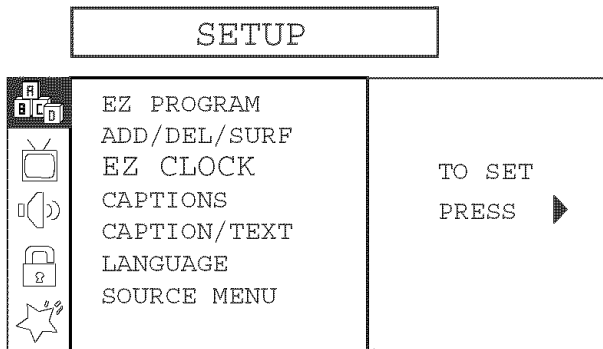

MENU NEXT MENU ◀ MOVE ▶ NEXT

◀ MOVE MENU BACK

- 1** In the Setup menu with the EZ Clock option highlighted, press the Adjust RIGHT arrow to go to the EZ Clock Menu.
- 2** Use the Select UP or DOWN arrows, the Adjust LEFT or RIGHT arrows, and the NUMBER keypad to set the clock menu options. As indicated on the menu, use FLASHBK to set AM or PM.

EZ Clock Menu Options

- 3** **Manual Mode**
User sets the EZ Clock options.
 - **Clock Mode:** Auto, Manual.
 - **Time Set:** Set Hours and minutes using the NUMBER keypad or the left/right arrow keys. Use Flashbk to set AM/PM.

- Automatic Mode**
TV sets the clock, but the user can enter the menus and make custom changes if needed.
- **Time Zone:** Auto, Eastern, Central, Mountain, Pacific.
 - **Daylight Savings:** Auto, Off, On.

- 4** Press ENTER or QUIT to return to TV viewing.

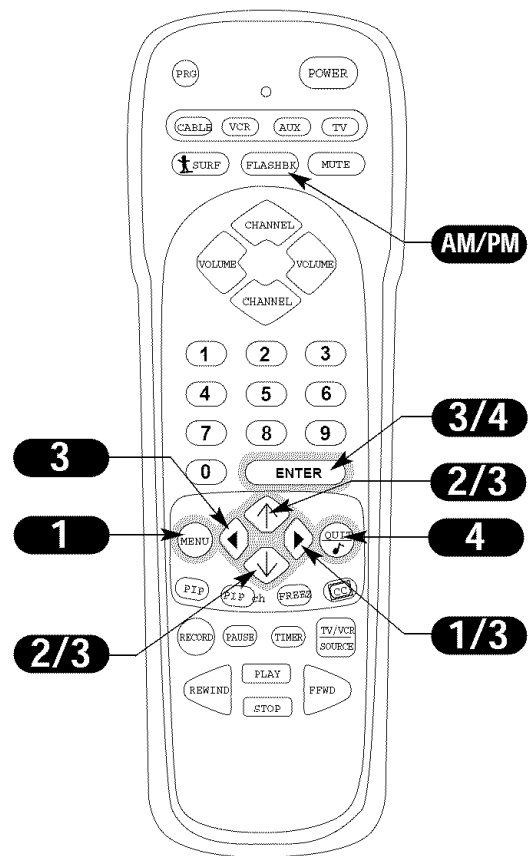

Mini glossary

- TIME** A four-number figure broken down into hours and minutes; first two numbers are hours, last two numbers are minutes.
- HOURS** First two numbers that are entered when setting the clock.
- MINUTES** The second two numbers that are entered when setting the clock.
- FLASHBK** Use to set AM or PM when setting time.

Selecting Captions/Text Options

Turn on Closed Captioning or Captions when sound is Muted, then choose a Closed Captions or Text option

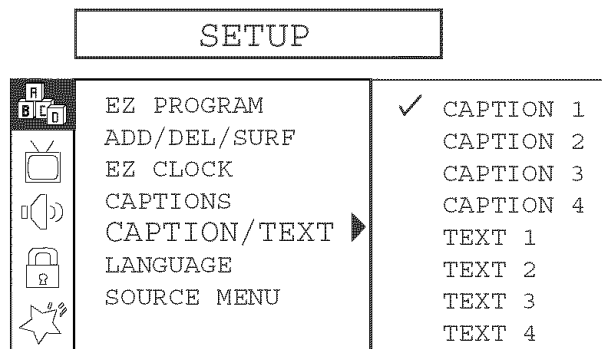
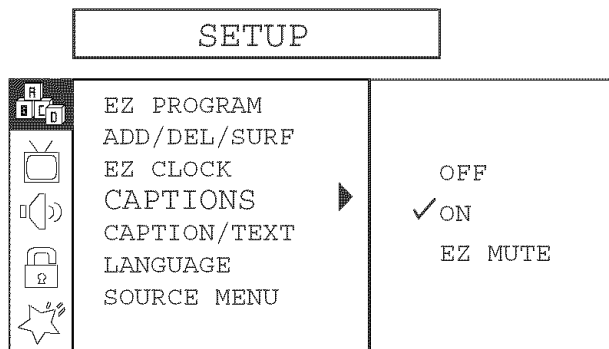

The Caption/Text feature sets up your Entertainment Machine to receive various closed caption and text options provided by broadcasters.

Availability and functionality of Caption/Text is determined only by the broadcaster.

- 1** Press MENU repeatedly until the SETUP menu appears.
- 2** Use the Up/Down arrow to highlight the Captions option, then press the Right arrow.
- 3** Use the Up/Down arrow to select Off, On or EZ Mute, then press the Right arrow.
 Note: If you selected either On or EZ Mute, then use the Up/Down/Left/Right arrows to choose an option from the Caption/Text menu: Caption 1, Caption 2, Caption 3, Caption 4, Text 1, Text 2, Text 3, or Text 4. The option will appear when the TV sound is muted or a program is tuned to that has Closed Captions or Text available.
- 4** Press QUIT to remove menu and return to TV viewing.

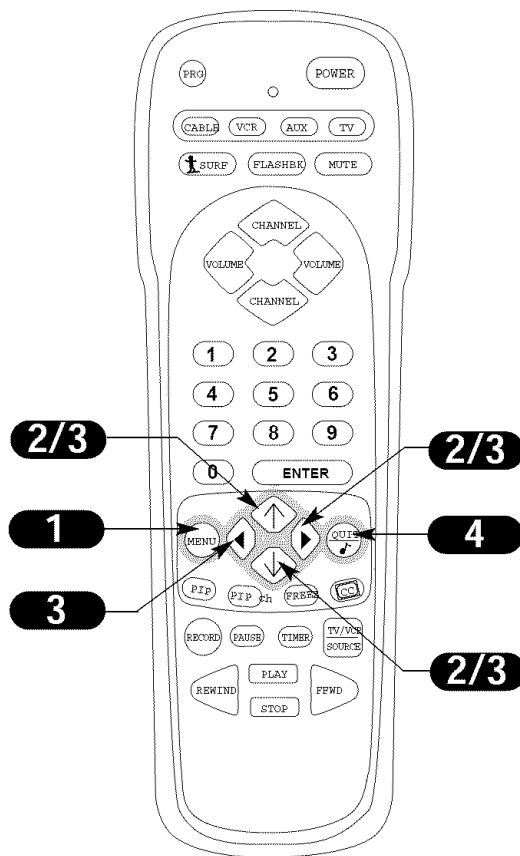

Captions come in handy when the television is on mute. Standard closed captioning is available using the Caption 1 option.



Not all programming has closed captioning or text available, even though Captions 1, 2, 3, 4, and Text 1, 2, 3, 4 are available to broadcasters.

Mini glossary

- CAPTIONS** The term for the words that scroll across the bottom of the TV screen; usually the audio portion of the program provided for the hearing impaired.
- TEXT** The term for the words that appear in a large black frame and almost cover the entire screen; usually messages provided by the broadcaster.

Selecting a Language for the Menus

Choose the language in which you want the on-screen menus to appear

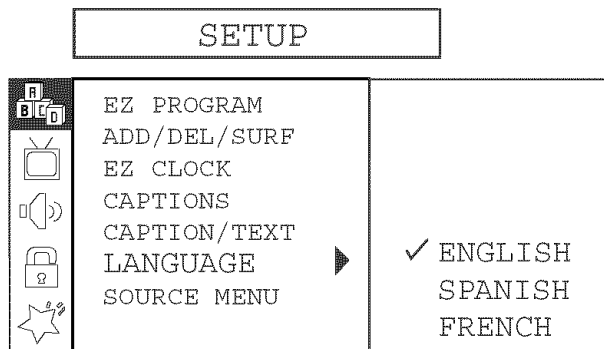

MENU NEXT MENU MOVE NEXT

- 1** Press MENU repeatedly to select the SETUP menu.
- 2** Use the Up/Down arrow to select the Language option on your screen, then press the Right arrow.
- 3** Use the Up/Down arrow to choose any of the following options: English, Spanish or French.
- 4** Press QUIT to remove menu and to return to TV viewing.

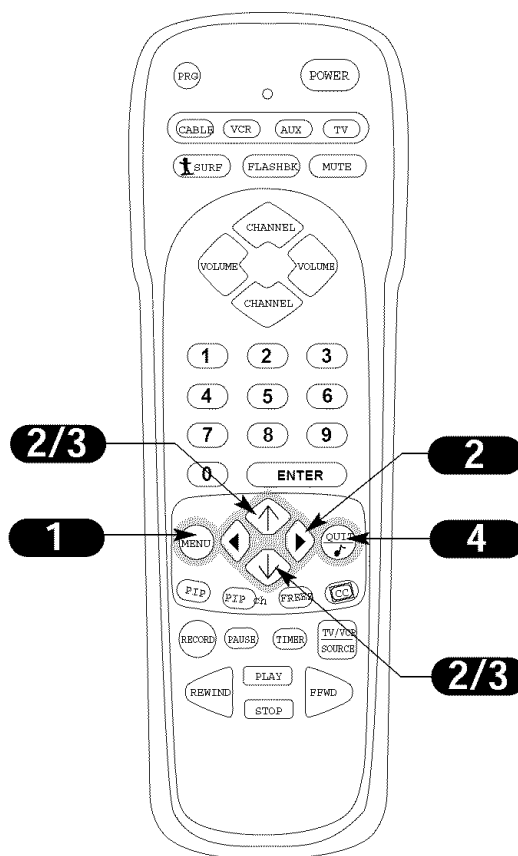

Selecting Main Picture/PIP Sources

Choose the picture and sound you want to view on the Main Picture Screen and the smaller PIP inset

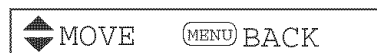
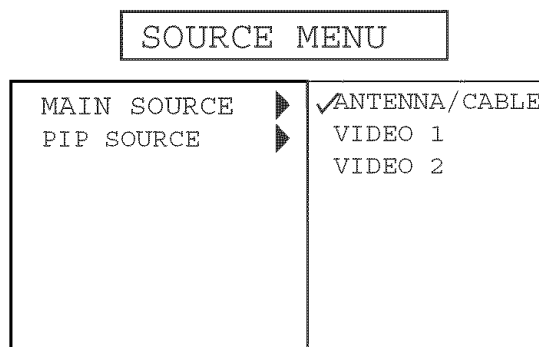
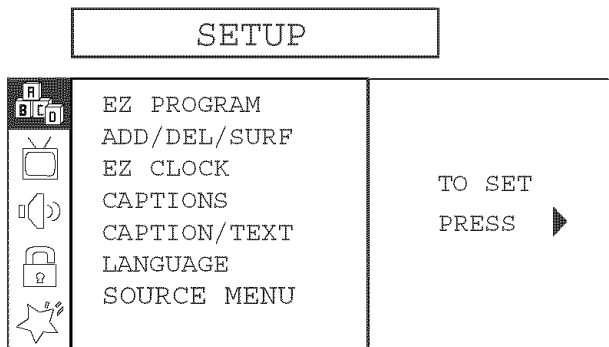

- 1** **Selecting Sources with the Menus**
Press MENU repeatedly to select the SETUP menu.
- 2** Use the Up/Down arrow to select SOURCE MENU, then press the Right arrow.
- 3** Use the Up/Down arrow to choose MAIN SOURCE or PIP SOURCE option, press the Right arrow.
- 4** Use Up/Down arrow to select ANTENNA/CABLE, Video 1, or Video 2.
- 5** After you have selected viewing sources for the Main picture screen and the smaller PIP inset, press QUIT to remove menus and return to TV viewing.

- A** **Using TV/VCR SOURCE to Choose Viewing Sources**
Press TV/VCR SOURCE repeatedly to scroll through the available sources: ANTENNA/CABLE, VIDEO 1, VIDEO 2.

With the smaller PIP inset picture on-screen, press PIP Ch repeatedly to toggle between Main Picture channel tuning mode and PIP inset channel tuning mode. (Pressing ENTER reveals what channel tuning mode the TV is in shown by the "blinking" on-screen display.)



No extra equipment required for PIP source. This TV has two tuners which allows the viewer to see two different channels at the same time; one channel on the Main picture and another channel on the PIP inset.

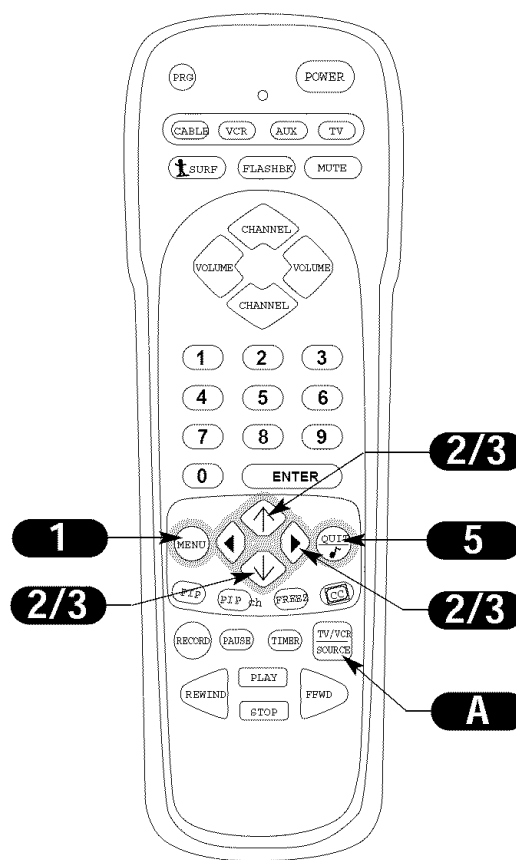

Mini glossary

- ANTENNA/CABLE The source from the ANTENNA/CABLE jack.
- VIDEO 1, 2 The equipment connected to the video input jacks on the back or front of the TV: VCR, DVD, camcorder etc.
- TV/VCR SOURCE The key on the remote control providing direct access to available sources.

Setting the Video Menu Options

Customize the picture to your personal viewing preferences

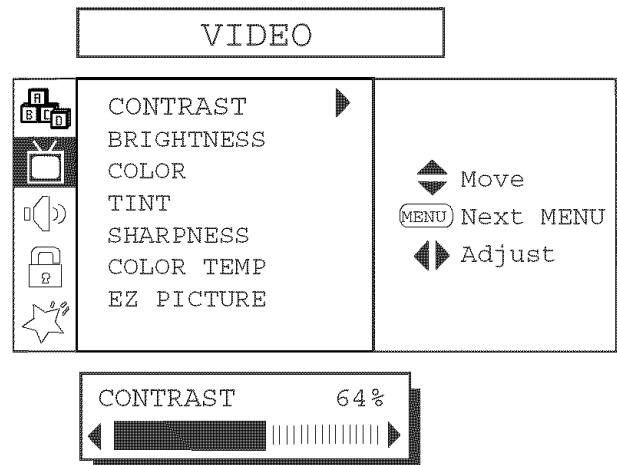

1 With the VIDEO menu on-screen, use the Up/Down arrow to select an option like EZ Picture, press the Right arrow to go to the EZ Picture menu selections.

2 Using the Up/Down arrow, select a Video menu feature. Your options are:

Contrast: Changes the amount of difference between black levels and white levels in your picture.

Brightness: Increases or decreases the amount of white in your picture.

Color: Adjusts levels of all colors.

Tint: Adjusts the relative amounts of the colors red and green in your picture.

Sharpness: Raises or lowers the definition of the picture. The lower the level, the softer the image will appear.

Color Temperature: Changes the overall picture appearance. Options are: Warm, Medium, Cool.

EZ Picture: Sets your viewing preference based on the viewed image's setting.

Options are: Custom, Normal, Movie, Digital Pres, Video Game, Sports, Weak Signal, Night Time.

3 After you have used the Up/Down and Left/Right arrows to select and adjust the VIDEO menu options to your preference, press QUIT to return to TV viewing.

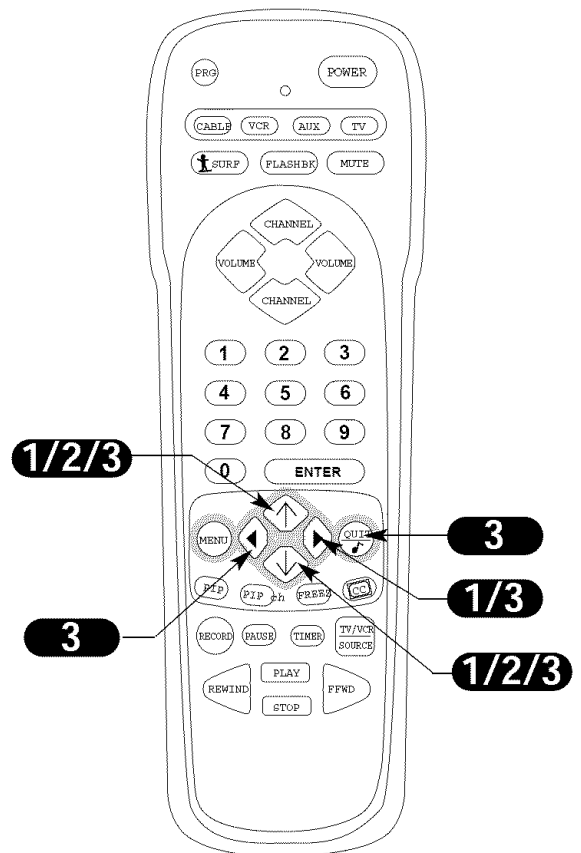

Mini glossary

Custom	The settings you have changed to your personal preferences.
Preset	Select this option to reset the video menu settings to their original levels.

Setting Audio Menu Options

Personalize the sound coming from your Entertainment Machine

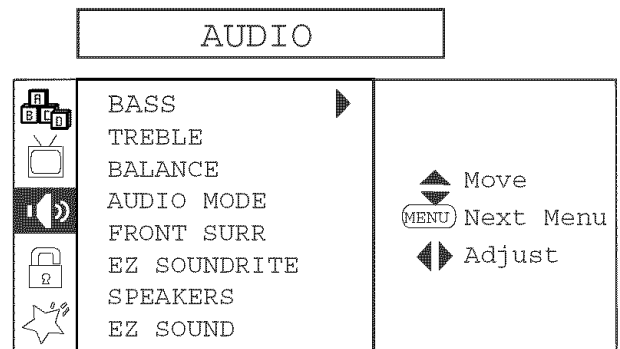

- 1** With the AUDIO menu selected and the Audio Mode option highlighted, press the Right arrow.
- 2** Using the Left/Right arrows, select your preferred settings. Choose from Mono, Stereo, or SAP. Audio Menu Options Include:
 - **Bass:** Increases/decreases lower-end sounds.
 - **Treble:** Increases/decreases higher-end sounds.
 - **Balance:** Allows you to put the sound more to the left or right channel.
 - **Audio Mode:** Chooses sound: Stereo, Mono, 2nd Audio/SAP.
 - **Front Surr:** Turns the front surround sound on or off. (Or QUIT/🎵 will turn front surround sound on and off, if no menus are shown on the screen.)
 - **EZ SoundRite:** Scans for changes in sound level during commercials, then adjusts the sound to match your current level.
 - **Speakers:** Turns the regular speakers on or off.
 - **EZ Sound:** Chooses from Custom, Normal, Stadium, News, Music, or Theater. (Normal resets all audio settings to original levels.)

3 Press the Left arrow to go back to the AUDIO menu and change other options settings to your preference.

4 Press QUIT to remove menu and return to TV viewing.



Not all programming is broadcast in stereo sound or has Second Audio Programming/SAP.



If 2nd Audio SAP is selected and none is present, audio may not be heard.

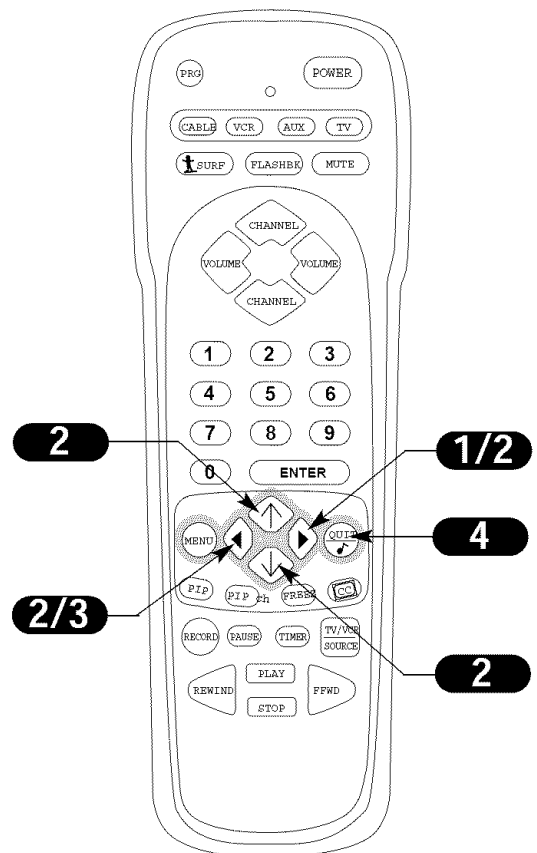

Mini glossary

AUDIO MODES

- | | |
|---------------|--|
| Mono | Sound is broadcast over one audio track. |
| Stereo | Sound is broadcast over two audio tracks, divided between the left and right speakers. |
| 2nd Audio/SAP | An extra audio signal that may be transmitted in addition to the regular audio portion of a broadcast. |

Parental Control Overview

This optional feature can be used to "block" undesirable programming from appearing on your TV
Note: If you use this feature, PIP will not be available.

Parental Control offers the user a wide variety of options and settings that restrict or "block" the programming that can appear on the TV. Parental Control allows the user the capability of defining which program rating they consider acceptable, to the younger or more sensitive viewer. It can be preset and turned either on or off by the user who specifies the secret 4-number code, the password. The number of hours blocked are specified. For complete coverage, General Audience and Children viewer blocks should both be programmed into the TV's memory. Viewer ratings are specified for both TV and the motion picture industry; both rating systems can be used. The ratings are based mainly on the ages of children.

Overview

To insure complete coverage for all TV programs, (movies and regular TV shows) choose a rating for "MPAA", from the selections below AND choose ratings from the "TV Parental Guideline Rating System" on the next page, using the Age Block option for General Audiences, and for Children. In addition to those, you may wish to include additional restrictions from the Content Block menu. See the Parental Control menu, and submenus example on the next page.

Things to Consider before Setting Up Parental Control

Determine which rating you consider acceptable to the viewer. (For example, if you choose TV-PG, all more restrictive ratings will be automatically blocked; the viewer will not be able to see: TV-PG, TV-14, or TV-MA rated programming.)

Do you want to block the auxiliary video source entirely? (Blocks the signal sent by the equipment, such as a VCR, connected to the TV Audio/Video input jacks; in the Aux. Block option.) Or leave unblocked, and have the restrictions you specified filter programming from the video source.

Block program "Content" based on individual parameters such as: Strong Dialog, Bad Language, Sex Scenes, Violence Scenes, or Fantasy Violence Scenes; in the Content Blk option.

How many hours do you want Parental Control to be active? You can set the Hours option for up to 99 hours.

Select a secret password; in the Set Password option. Use the NUMBER keys on the remote. Don't forget the password, it is the only way you can access the Parental Control menu and change rating selections, or turn Parental Control off.

Do you want Parental Control to be active all the time? If not, you can turn it on or off; with the Lock On/Off option.



You should set Parental Control viewing restrictions for General Audiences and for Children - - both should be active at the same time.



If you choose to leave the Aux inputs unblocked, the ratings you specify will still restrict the programming content that appears from the video sources.



Simply specifying one content block such as Sex Scenes, will not automatically block another content in the programs from appearing.



You cannot disable Parental Control by disconnecting the TV from power. Block hours will automatically reset to the original block time setting specified if power is disconnected.

Mini glossary

MOTION PICTURE ASSOCIATION OF AMERICA (MPAA) RATING SYSTEM

G	General Audiences	Content not offensive to most viewers.
PG	Parental Guidance Suggested	Content is such that parents may not want their children to view the program.
PG-13	Parental Guidance Suggested	Program is inappropriate for preteens, with a greater degree of offensive material than a PG rated program.
R	Restricted viewing	Not for children under age 17. Strong elements of sex and/or violence.
NC-17	Restricted Viewing	Not for children under age 17 under any circumstances. Strong sexual content.
X	Hard Core Films	Same as NC-17 rating.

Note: Zenith Electronics Corporation is not liable for any program content that appears when using this rating system; as always, user discretion is advised.

Using Parental Control

After you have read the preceding page, follow instructions below to set up and activate Parental Control

1

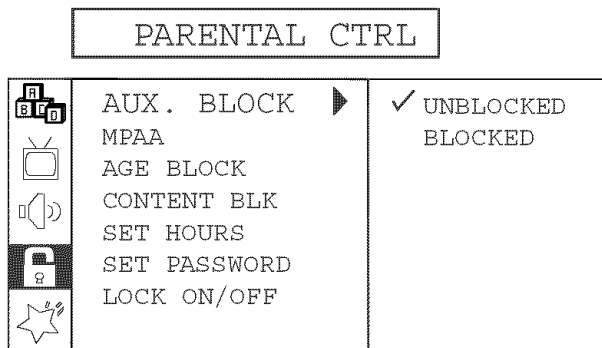

Follow These Instructions

Note: Use the remote control to set up Parental Control.

In the PARENTAL CONTROL menu, highlight the Content Block option, then press the RIGHT arrow.

Use the Up/Down arrow to select an option, like F. Violence (Fantasy Violence) for example, then press the Right arrow to go to the restrictions menu for Fantasy Violence.

Use the Up/Down arrow to select an acceptable rating like TV-Y7. (See the Mini Glossary, Ratings Charts on this and the previous page for rating meanings.)

Press the Left arrow to go back to select another Content Block classification like Language for example and then

choose an acceptable rating. Or, press the Left arrow repeatedly to return to the PARENTAL CONTROL menu to select and adjust other options.

After you have selected and adjusted the PARENTAL CONTROL menu options to your preferences, select and:

- Set the number of hours you want Parental Control on.
- Set your 4-number password
 - - use the NUMBERS on the remote.
- Set the Lock On/Off option to either on or off.

Press QUIT to remove menus from the screen.



No Rating, means the broadcast does not contain any rating information. Select the "No Rating" option and block it if appropriate.

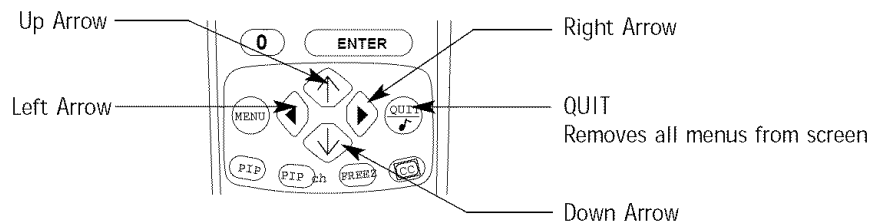

Mini glossary

TV PARENTAL GUIDELINE RATING SYSTEM

TV-G	General Audience	Considered suitable for all audiences; children may watch unattended.
TV-PG	Parental Guidance Suggested	Unsuitable for younger children, may contain: Suggestive Dialog, Bad Language, Sex, and Violence Scenes.
TV-14	Parents Strongly Cautioned	Unsuitable for children under 14, may contain: Strong Dialog, Bad Language, Sex, and Violence Scenes.
TV-MA	Mature Audience Only	Adults only, may contain: Strong Dialog, Bad Language, Sex, and Violence Scenes.

CHILDREN'S CLASSIFICATIONS

TV-Y	Children	Considered suitable for all children under 7 years old.
TV-Y7	Children 7 and over	Considered suitable for children over 7, may contain Fantasy Violence Scenes.

Parental Control Menu Structure

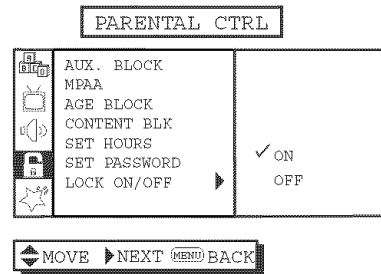
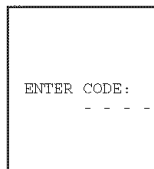
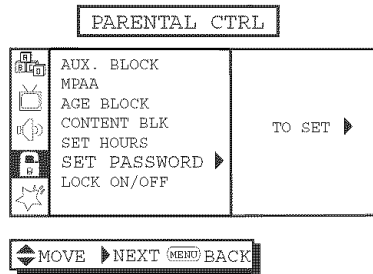
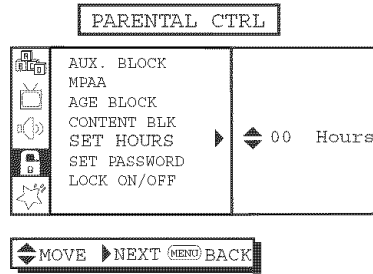
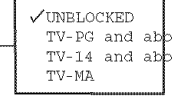
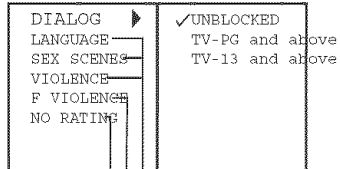
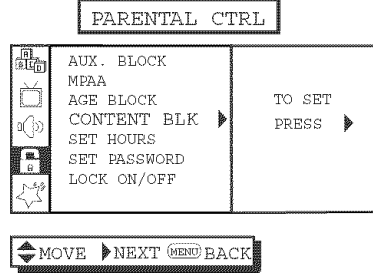
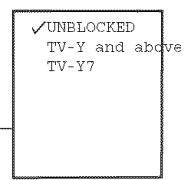
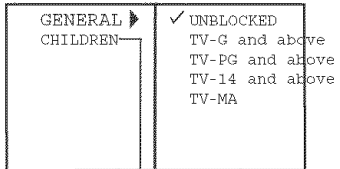
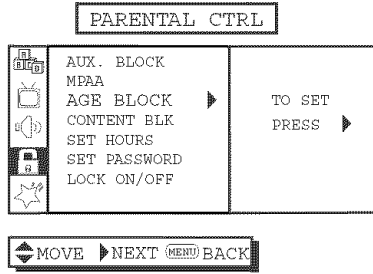
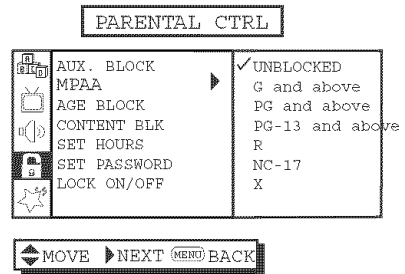
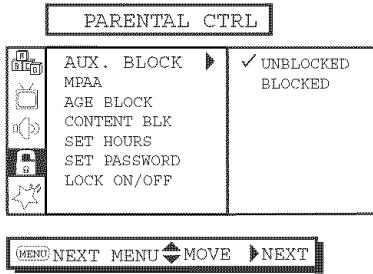

EZ Timer: Sleep and On/Off Timers

Set the Sleep Timer to automatically turn the TV off, after the preset time has expired
On/Off Timer to turn TV on and off each day at the specified time

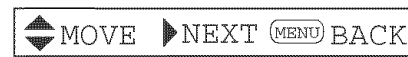
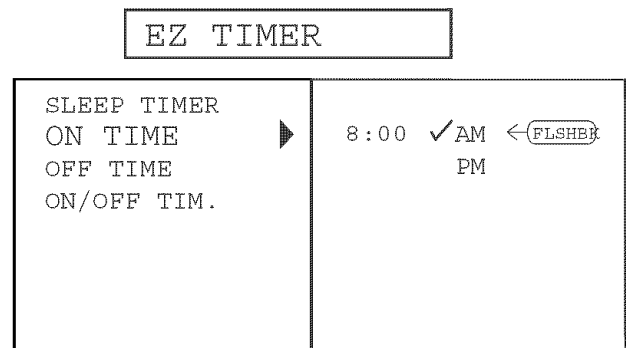
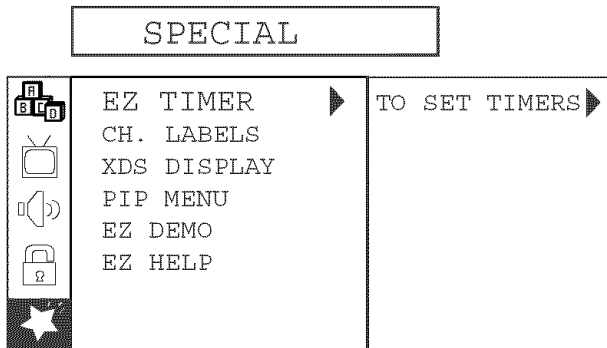

Sleep Timer Direct Access

- A** Press **TIMER** to place the Sleep Timer menu on the screen. Press **TIMER** repeatedly to scroll through the available sleep timer settings and choose one of the preset turn-off times. Options are: Off, 10, 20, 30, 60, 90, 120, 180, or 240 minutes. You can also set the Sleep Timer by using the menu.

Using the EZ Timer Menu

- B On Time**
With the EZ Timer menu selected, use Up/Down arrows to choose On Time, then press the Right arrow.

Use the NUMBER keypad or the Left/Right arrows to pick a time for the TV to automatically turn itself on each day. Use **FLSHBK** to choose AM or PM.

- B Off Time**
With the EZ Timer menu selected, use Up/Down arrows to choose Off Time, then press the Right arrow.

Use the number keypad or the Left/Right arrows to pick a time for the TV to automatically turn itself off each day. Use **FLSHBK** to choose AM or PM.

- B On/Off Timer**
With the EZ Timer menu selected, use Up/Down arrows to choose On/Off Timer, then press the Right arrow.

Choose either:
On-TV will automatically turn itself on and off each day at the specified times.
Off-TV will not turn itself on and off each day, but the turn on and turn off times will be retained in memory for future use.

- C** Press **QUIT** to return to TV viewing.

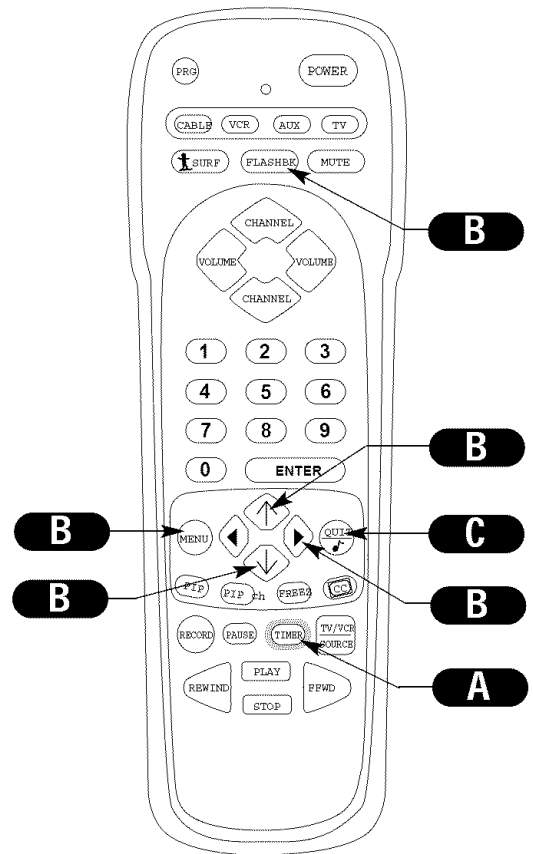

Selecting Channel Labels

Pick a preset label to help identify the network you just tuned to or are currently watching

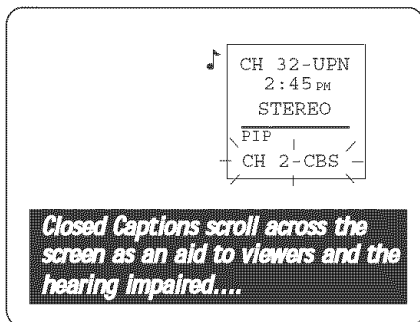

Channel/Time Display with Channel Labels

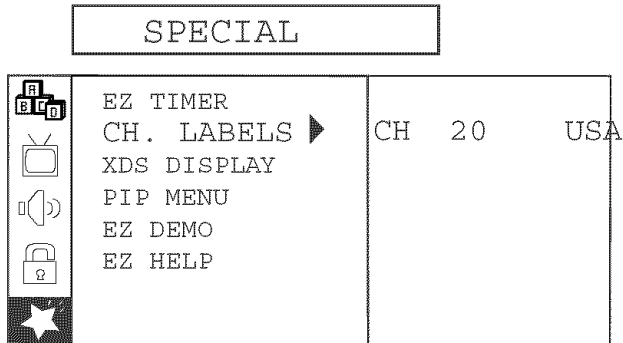

MENU NEXT MENU ◀ MOVE ▶ NEXT

- 1** Using the NUMBER keypad or the CHANNEL Up/Down arrow, pick the channel you want to label.
- 2** Press MENU repeatedly to choose the SPECIAL menu.
- 3** Use the Up/Down arrow to select CH. LABELS, then press the Right arrow.
- 4** **Select a Label for the Channel**
Press the Down arrow key (each press will bring up a different label) to go through the alphabetical listing, starting with A - B - C - D, etc.
Or, use the Up arrow key to go through the alphabetical listing backwards, starting with Z - Y - X - W, etc.
- - - Autolabel setting will show a label if one is provided by the broadcaster.
- 5** Press QUIT to accept the label and return to regular TV viewing or use the NUMBER keypad to select another label and repeat from Step 3.



If a channel label is picked, the Channel Label for the channel you are watching appears when you press ENTER or change to a different channel that also has a channel label, a convenient way to know which network you are viewing.



Some networks display their own channel labels.



Channel Labels do not appear for video sources.

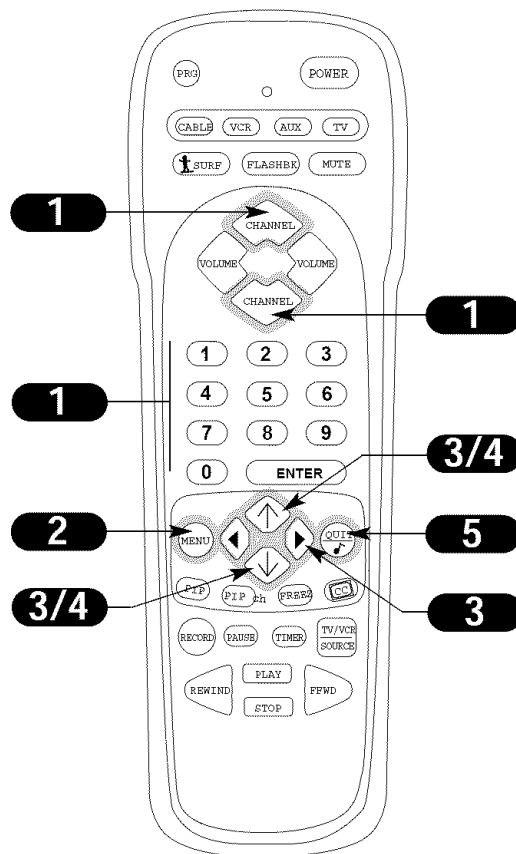

Mini glossary

- This label indicates that a label will appear if one is provided by the broadcaster.
- None This label prevents any labels from appearing.

XDS Display

Use the Extended Data Service to show in-depth program information

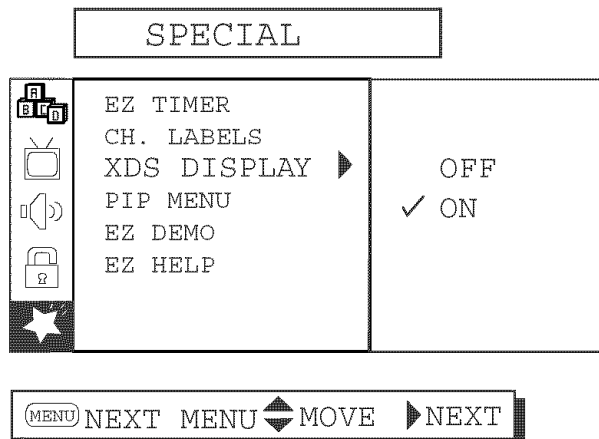
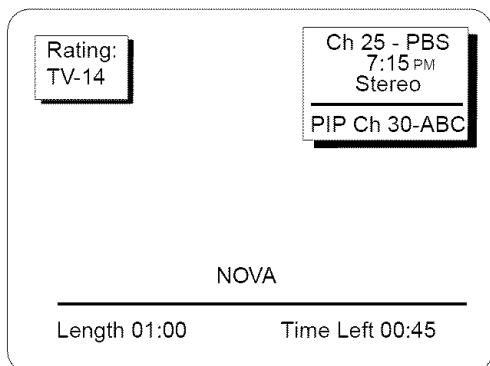

- 1** Press MENU repeatedly to select the SPECIAL menu on your screen.
- 2** Use the Up/Down arrow to select the XDS DISPLAY option, then press the Right arrow.
- 3** Use the Up/Down arrow to choose: On, or Off.
On, XDS Display will appear as channels are changed or ENTER is pressed.
Off, XDS Display will not appear.
- 4** Press QUIT to remove the menu and return to TV viewing.



At this printing, XDS data is only being provided by some broadcasters, and, as a result, may only be available on some channels.



Even though XDS data may be present, it may not be available during commercial or network breaks.

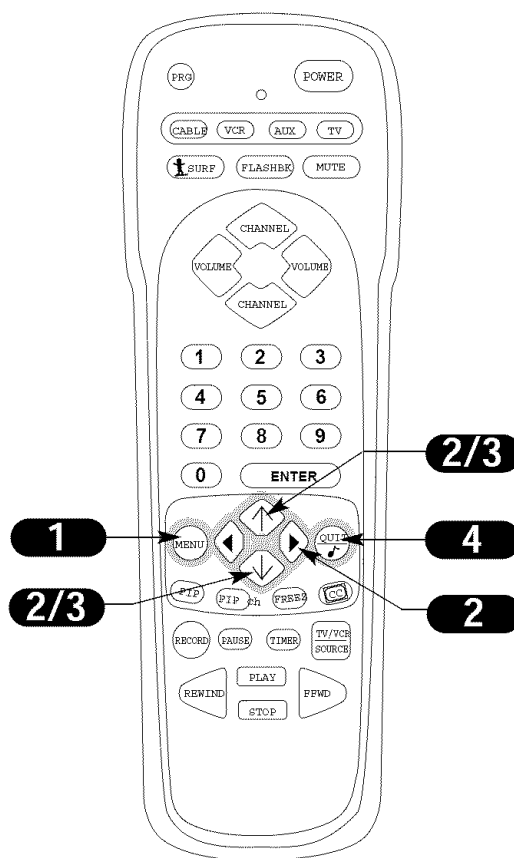

Mini glossary

XDS Extended Data Service - - if provided by the broadcaster, may show some or all of the following information: Channel/Time/Audio display, Network label if present, Title of program, Length of program in hours and minutes, and the Time remaining on the program in hours and minutes, Program content rating and if PIP is active, the PIP channel number.

Setting the PIP Inset Options

Customize the PIP inset appearance and size

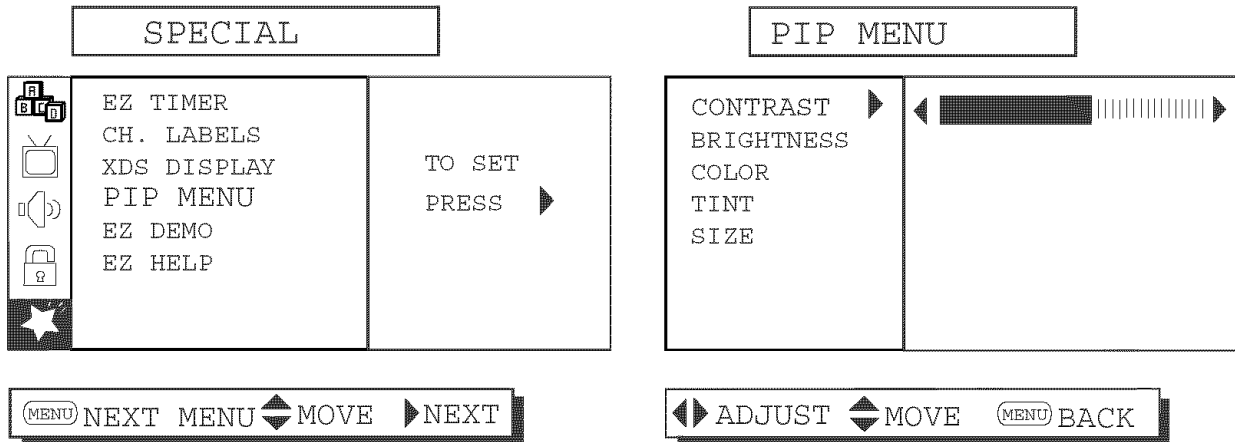

- 1** Press MENU repeatedly to select the SPECIAL menu on your screen.
- 2** Use the Up/Down arrow to highlight the PIP MENU option, then press the Right arrow.
- 3** Use the Up/Down/Left/Right arrows to select and change the PIP menu options.
 - **Contrast:** Changes the amount of difference between black levels and white levels in your picture.
 - **Brightness:** Increases or decreases the amount of white in your picture.
 - **Color:** Adjusts levels of all colors.
 - **Tint:** Adjusts the relative amounts of the colors red and green in your picture.
 - **Size:** Selects the PIP inset picture size. Options are: Large, Small.
- 4** Press QUIT to remove menu and return to TV viewing.



Turn to the next page for a more detailed description of the PIP feature.

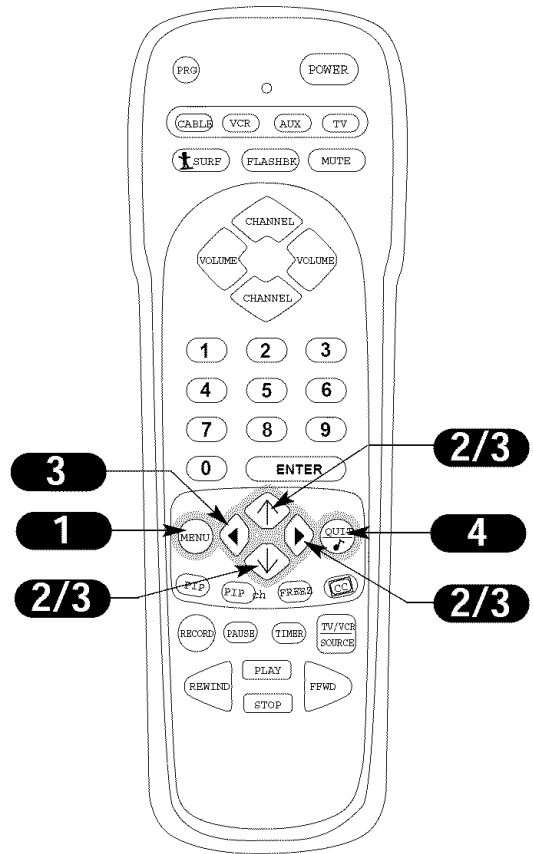

Two-Tuner PIP Overview

PIP = Picture-In-Picture

Think of PIP as a mini TV screen superimposed onto your main TV screen

Press PIP on the remote to place the PIP inset on the screen, press PIP again to remove it

YOUR PICTURE-IN-PICTURE FEATURE

The Picture-In-Picture (PIP) function allows you to put a smaller picture, called the "inset," on the bigger screen, or the "main" picture.

Normally you would need some other piece of equipment, like a VCR, to act as a tuner to receive and display a second channel at the same time. Your TV eliminates that need by giving you two tuners on one TV, on the Antenna/Cable source. PIP is always available, no matter what equipment you have.

Don't want to miss any of the big game, but hate commercials? Just put the game in the PIP inset, and Surf your favorite channels on the main picture screen.

WORKING WITH PIP

Just like your Entertainment Machine's main screen, PIP will need a source to take its image from. Set the main screen source to Antenna/Cable, then set the PIP source to Antenna/Cable, as an example. Then if you use the TV's tuner to pick your channels, you can enjoy 2-tuner PIP; channel scan capability for both the main screen and the PIP inset.

PIP will need a source from which to take its image. Put Antenna/Cable in the inset while you watch a video tape, from a VCR connected to Video 1. Have a DVD disk playing in the PIP inset, while you watch a videotape on the main screen

SOME TYPICAL PIP/MAIN SCREEN VIEWING SETUPS

1. You want to watch a videotape, but keep scanning for another movie or game. Set the PIP source to Video 1, or 2 and you can watch the VCR and TV, swapping between the two.
2. You want to watch your favorite live program on Antenna/Cable on the main picture and when a commercial break appears, swap to the PIP inset; which has a videotape in the VCR ready to play, or Surf your favorite channels using the Antenna/Cable source for the PIP inset.



PIP Inset Picture

Main Picture

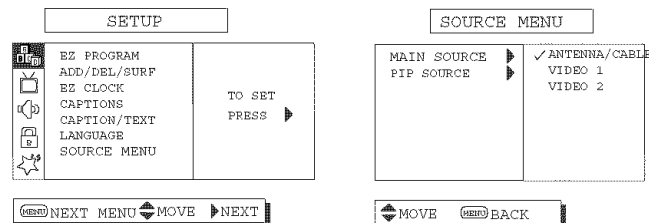

Use the Source Menu to choose Main screen and PIP sources.



If no equipment is connected to a source you select for the PIP inset, or if it is turned off, the PIP inset will be black.

Mini glossary

TUNER	A device that picks up broadcast signals and turns them into picture and sound.
A/V SOURCE	Other equipment connected to the TV Audio/Video source inputs on the TV back or front connections panel; Video 1 or Video 2.

Using the PIP Feature

Using two-tuner, Picture-in-Picture (PIP) features



PIP Inset Picture
Press PIP to turn PIP on and off.

Move PIP Around Screen
Press Right/Left arrows to move the PIP inset to the other corners of the screen.

Main Screen Picture
With PIP off, press FREEZ to place the Main screen picture in the PIP inset and "freeze" the image thereby turning PIP on. (A good way to freeze the image so you can write down phone numbers etc.)

Swap Main Picture with PIP
Press the Up/Down arrows repeatedly to swap the images between the Main picture and PIP inset.

Main Picture Source
In Main picture channel tuning mode, press TV/VCR SOURCE to change the source to ANTENNA/CABLE, Video 1, or Video 2. (Or, use the Setup Menu.)

Musical Note Symbol
Indicates if PIP or the Main screen is the sound source. (In this case sound is from Main screen source.) To change sound source, press QUIT repeatedly with the Channel/Time/Audio Display on-screen.

Channel/Time/Audio Source Display
Press ENTER to show display. Shows source for: Main picture, PIP, and sound source (Main or PIP).

Channel Tuning Mode
Press PIP ch repeatedly to switch channel tuning between Main screen and PIP inset. Flashing shows channel tuning mode; in this case, channel tuning is for the PIP inset. (When you press Channel Up/Down, the channels in the PIP inset change.)

PIP Source
In PIP channel tuning mode, press TV/VCR SOURCE to change the source for the PIP inset to ANTENNA/CABLE, Video 1, or Video 2. (Or, use the Setup Menu.)

PIP Key Functions

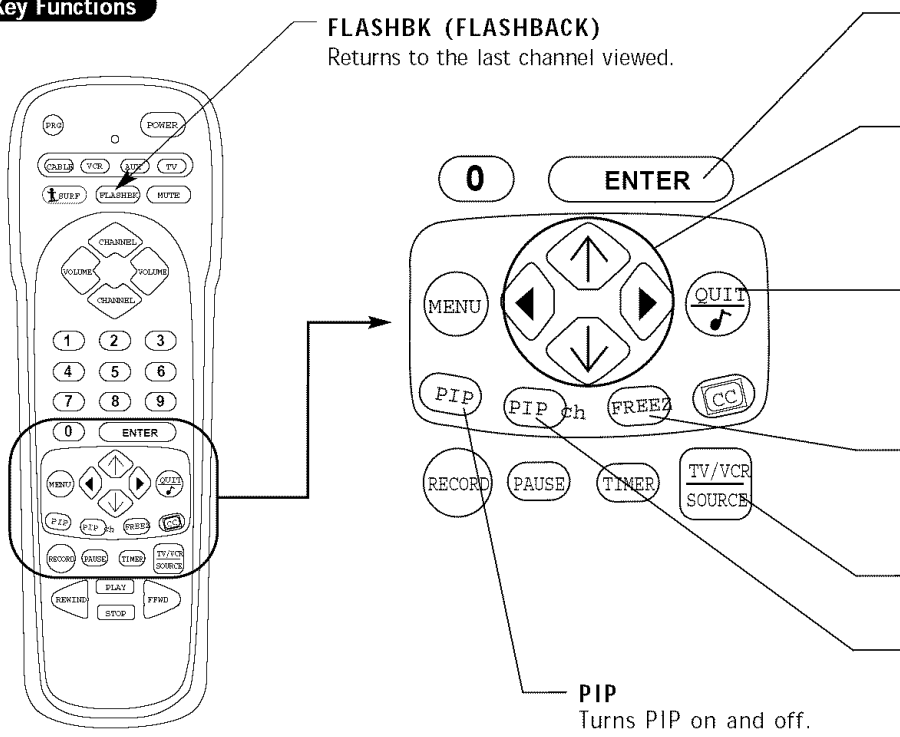

FLASHBK (FLASHBACK)
Returns to the last channel viewed.

ENTER
Shows Channel/Time Display on Main screen.

Up/Down/Left/Right Arrows
UP/DOWN ARROWS
Swap Main and PIP sources
LEFT/RIGHT ARROWS
Move PIP inset around screen.

QUIT
Chooses sound source. (With Channel/Time Display on-screen.)

FREEZ
PIP On: Freezes image in PIP inset.
PIP Off: Freezes Main screen picture in PIP inset and turns PIP on.

TV/VCR SOURCE
Chooses Main picture and PIP sources.

PIP CH
Chooses the channel tuning mode; Main screen channels or PIP channels.

PIP
Turns PIP on and off.

EZ Demo Menu

Your Entertainment Machine can show you the menus available

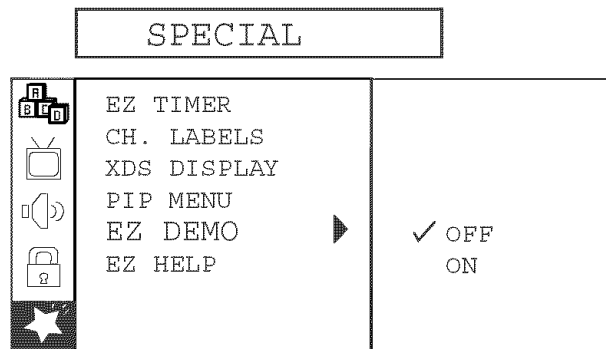

- 1** Press MENU repeatedly to select the SPECIAL menu.
- 2** Use the Up/Down arrow to select the EZ DEMO option, then press the Right arrow.
- 3** Use the Up/Down arrow to choose either: On; then press ENTER. EZ Demo will continue to run (even if the TV is turned off and on again) until it is turned off in the SPECIAL menu. Off; EZ Demo will not be active.
- 4** Press QUIT to remove menu and to return to TV viewing.



Even if the TV is turned off, the EZ Demo feature will continue to operate when the TV is turned on again.

The only way to turn EZ Demo off is to select Off, in the SPECIAL menu.

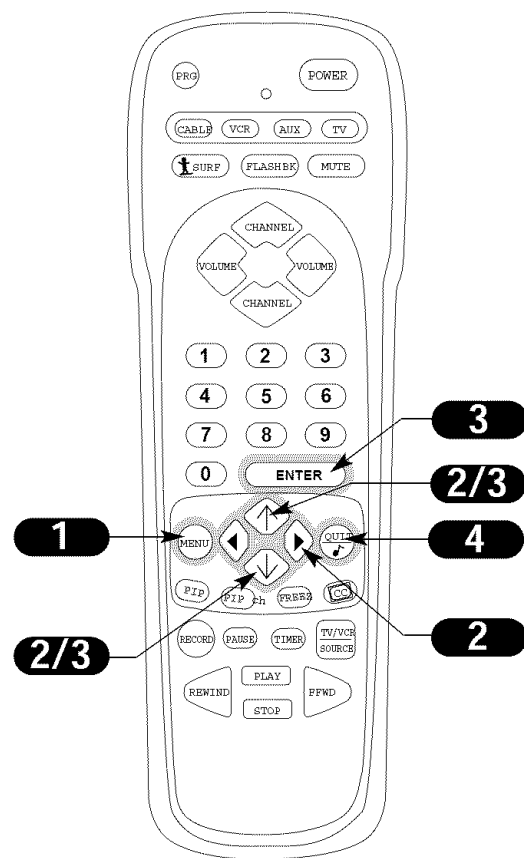

Mini glossary

EZ DEMO Feature provides an automatic demonstration of the on-screen menus on your Entertainment Machine. See and learn what features are available to you as EZ Demo cycles through the on-screen menus.

Using the EZ Help Menu

*Need Help?
Go to the on-screen EZ Help menu and
use it to solve the problems listed
below*

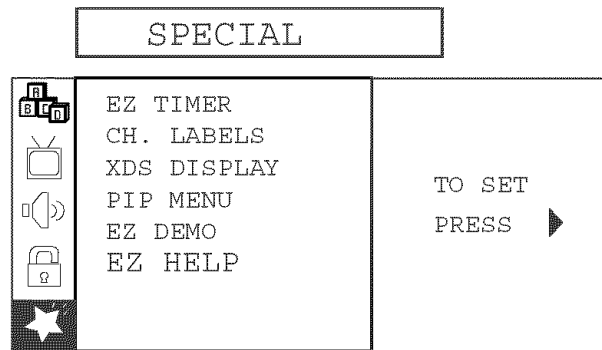

MENU NEXT MENU MOVE NEXT

- 1** Press MENU repeatedly to select the SPECIAL menu on your screen.
- 2** Use the Up/Down arrow to select the EZ HELP option, then press the Right arrow.
- 3** Use the (Up/Down/Right/Left arrow keys) as described on-screen to select the options below and correct the problem.
 - If you do not have any watchable channels:
Do a channel search.
 - If you want to add or delete a channel:
Adds or Deletes channels.
 - If your screen is stained:
Use Degaussing.
 - If you have a color problem:
Use viewing option for picture setting.
 - If there is a volume difference between channels:
Turn on Soundrite so sound level is maintained.
 - If there is noise in picture or picture is shaky:
Message shows some common problem solutions.
- 4** Press QUIT to remove the menu and return to TV viewing.

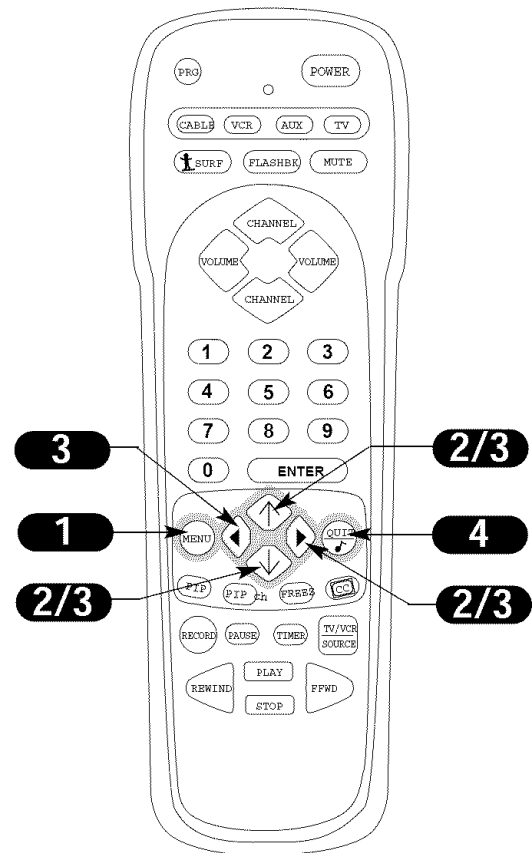

EZ Help offers solutions to common problems on one convenient menu.

Programming the Remote

Set up your remote to operate other IR controlled brand name devices:
VCRs, Cable Boxes, TVs, Satellite Receivers, DVD Players, Audio CD Players, Audio Tape Decks,
Audio Tuners and Amplifiers etc. See listing on pages 42/43

- 1 Turn on the device you want to program.
- 2 On the chart on page 42/43, find the type of device you're programming, and then find the brand name. Make a note of the three-number code, you'll need it soon.
- 3 Press and hold PRG. It's recessed so it doesn't get pushed accidentally. Use a small, blunt object. When the indicator light turns on, you can release PRG.
- 4 Push the key name with the type of device you're programming (VCR, CABLE, AUX, TV).
- 5 Using the NUMBER keypad, enter the three-number code you found on page 42/43.
- 6 Press ENTER to save the code. (The indicator light will flash 3 times, then turn off to indicate the code is valid.)
- 7 Point the remote at the device and push POWER. It should turn off. If not, try the other codes listed and continue from step three.

Note: To reset remote to factory settings, enter 9-1-1, in Step 5.

Note: After programming, be sure to press the mode key first to operate the device you have just programmed.



Programming your Zenith remote may allow you to use one remote to work up to 7 different devices.



Not all devices will work with your Zenith remote control.

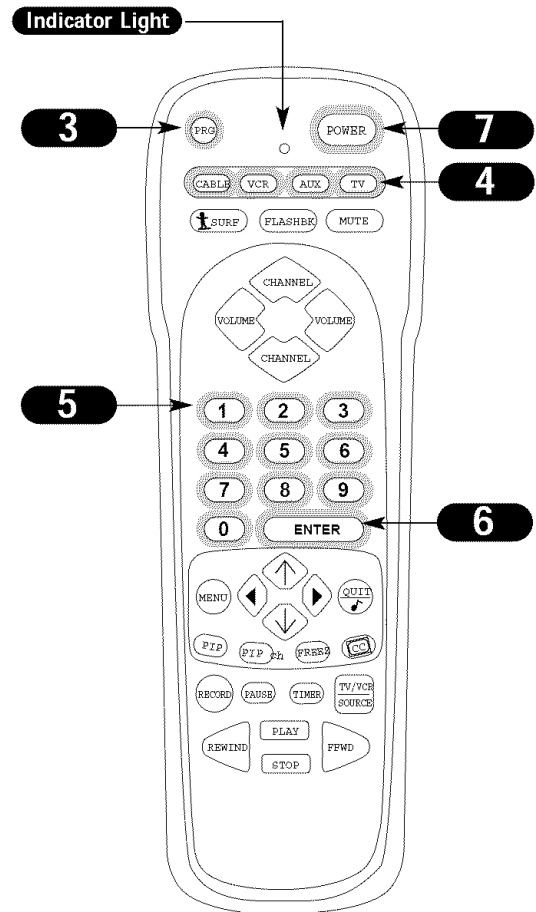

Mini glossary

PROGRAMMING	Procedure to set up remote to operate other equipment.
PRG	Programming mode key.
DEVICE	Infra-red remote controllable electronic accessory equipment.

Amplifier Volume Override

Control the volume on your home audio system without changing modes

- 1** Find the code that operates your amplifier. Test it to make sure it's the correct one by following the procedure in "Programming Your Remote" on the previous page.
- 2** Program your audio system into one of the available AUX modes: Aux, Aux+1, Aux+2, or Aux+3.
- 3** Press and hold PRG on your remote until the indicator light stays lit, then release.
- 4** Press 4-9-9; then ENTER on the remote. The indicator light will flash three times the code was accepted.

Audio system volume/mute now appears in all modes.
Note: You can also program Cable Box Volume and Mute control (if available) into your cable box mode (CABLE or AUX mode) by repeating the steps for programming on the previous page but entering 3-9-9, instead of a brand code, then pressing ENTER.



To put everything back to normal, reprogram the mode from Step 3 with the original brand code.



If you can't find the code for your amplifier, use the Auto Find feature on page 41.

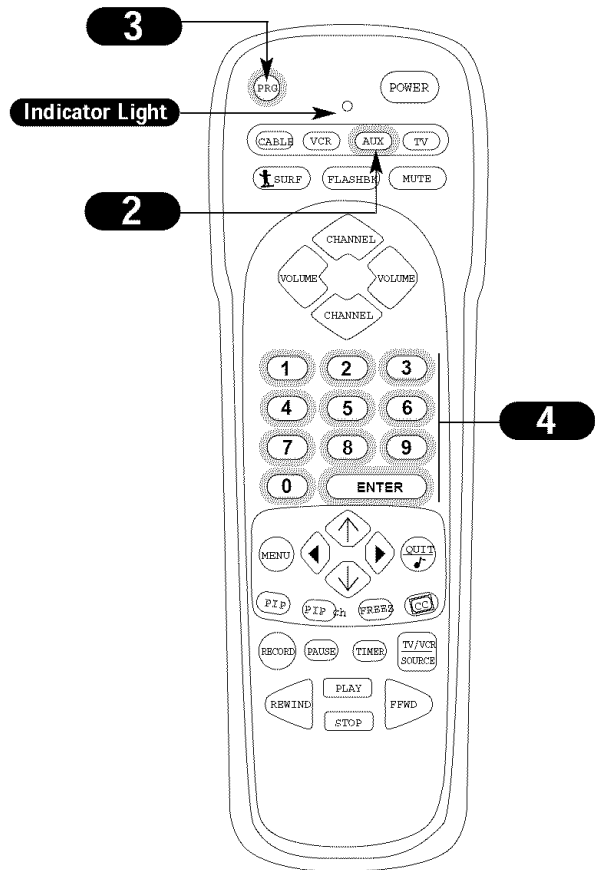

Mini glossary

AMPLIFIER	Audio device which sends sound to speakers, like an Audio Tuner, Receiver, or Amplifier. See Audio Tuners/Amp list on page 43.
CABLE BOX VOLUME/MUTE	Some cable boxes have volume controls.

Control up to seven different devices with your remote

- 1** Refer to the chart on page 42/43 to find the type and brand name of the device you're programming.
- 2** Press and hold down PRG with a small blunt object until the indicator light turns on, then release PRG.
- 3** Press AUX and the 1 on the NUMBER keypad at the same time (for AUX +1).
- 4** Using the NUMBER keypad, enter the three-number code for the device you've selected.
- 5** Press ENTER to save the code.
- 6** With the device turned on, point the remote at it and press POWER. It should turn off.
- 7** Repeat the steps for AUX+2, and AUX+3.



Programming your Zenith remote may allow you to use one remote to work up to 7 different products or devices.



Some devices may not work with your Zenith remote control.

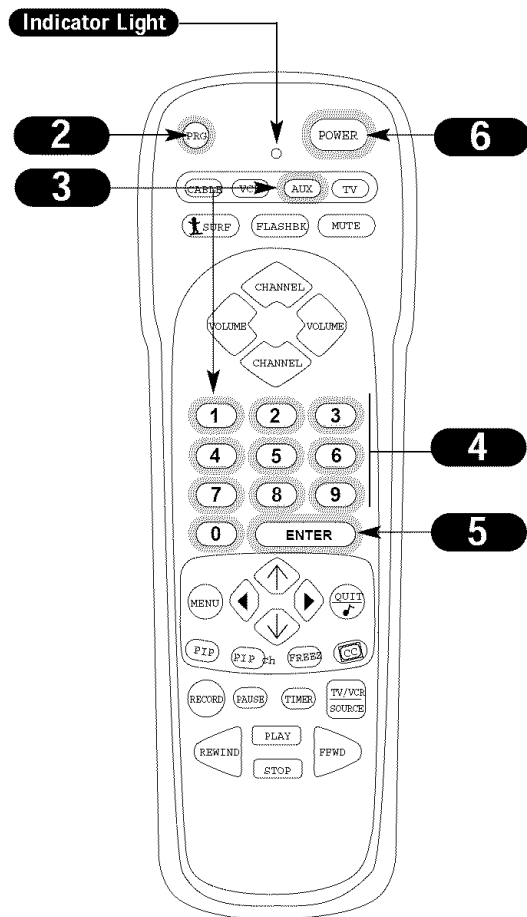

Mini glossary

AUX Auxiliary equipment. Can be any equipment which does not have a dedicated key on your remote like Cable or VCR. Typically a second VCR, stereo system, audio tape deck, etc.

Remote Control Auto Find

Use Auto Find to automatically search and try all possible brand codes

- 1 Turn on the device you want the remote to control.
- 2 Press and hold PRG until the indicator light turns on, then release PRG.
- 3 Press the key for the device you are trying to program (CABLE, VCR, AUX, TV).
- 4 Press 0-0-0 (zero-zero-zero), then press ENTER right away.
- 5 Aim the remote at the correct device and push the POWER key (The indicator light will turn off while the POWER key is pressed). Allow a second to pass, then push the POWER key again. Repeat until the device turns off.
- 6 Push ENTER to save the code (The indicator light will flash 3 times and then turn off).
- 7 Press POWER to turn the device back on.



You can quickly get out of Auto Find by pressing PRG.



If the indicator light stays on while you press Power instead of turning off, all the codes have been tried and your device can't be controlled.

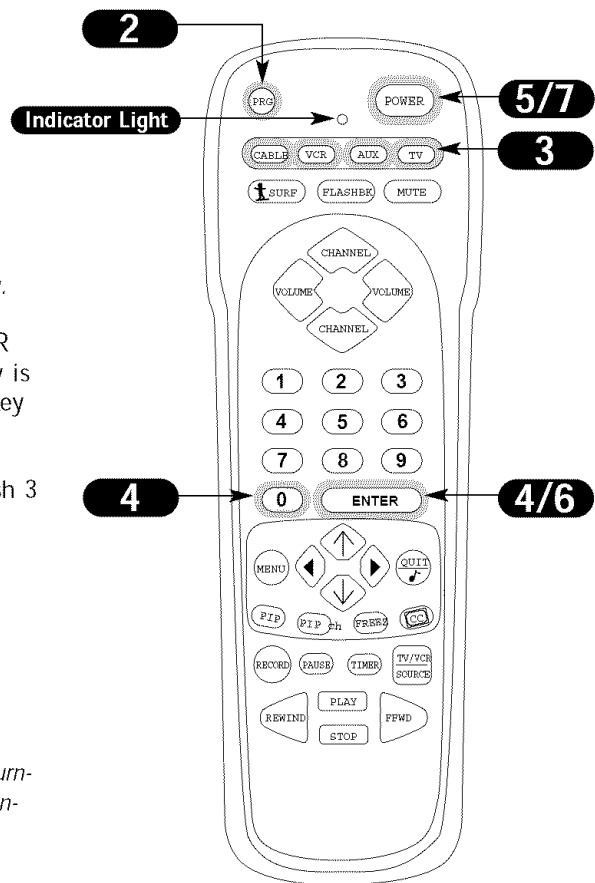

Mini glossary

AUTO FIND

Another way of finding a brand code for controlling auxiliary equipment such as a VCR, DVD player, etc. that is not available through the regular remote brand code programming method.

Programming Codes

Find the codes you need to program your remote. On this page: TVs, VCRs, and Cable Boxes

TVs

Admiral	121	Lodgent.	121	Signature 2000 . . .	121	Funai TV/VCR. . . .	154
Bell & Howell . . .	121	Logik	121	XR-1000	121	Goldstar TV/VCR. .	153 172
Citizen	121	Majestic	121	Zenith	101 121 149 152	Symphonic TV/VCR	154
Curtis Mathis . . .	121	Memorex	121	TV/VCR Combination Codes			
Daewoo	149	Montgomery Ward .	121	Adventura TV/VCR .	154	Zenith TV/VCR . . .	150 153 154 172
Elektra	121	Teknika	121	Daewoo TV/VCR . .	148		
Kurazi	121	Telerent.	121				

VCRs

Admiral	261	General Electric . .	216 220 266 282 701 702 725	MultiTech.	727	Samsung	220 230
Akai	292 717 718 719 720	Go Video	256 262 263 700	NEC	267 268 269 281 292 709 726	Sansui	289 292 709 726
Audio Dynamics . .	726	Goldstar	253	Orion	250	Sanyo	212 247 294
Bell & Howell . . .	247	Harmon Kardon . . .	296	Panasonic	245 251 259 713 714 715 716	Scott	243 290 729
Broksonic	221 250 255 729	Hitachi	257 270 273 292 705 706 707 708	Pentax	708 727	Sears	211 212 213 265 274
Candle	727	J.C. Penny	268 726	Philco	275	Sharp	261 730
Canon	704	Jensen	292	Pioneer	210 282 726	Signature 2000 . . .	216 219 249
Capeheart	728	JVC	224 225 258 268 292 299 726	Portland	246 727	Sony	232 723 724
Citizen	727	Kenwood	268 292 726 727	ProScan	216 260 266 282 725	Sylvania	275 297
Craig	212	Magnavox	275	Quasar	259 295	Tatung	268 292
Curtis Mathes . . .	259 266 725 727	Marantz	267 268 726 727	Radio Shack	213 265 730	Teac	268
Daewoo	244 246 248 254 703 729	Memorex	212 298	RCA	216 220 228 240 242 249 260 266 282 283 284 285 286 287 288 708 710 711 725	Teknika	272
Daytron	246	MGA	297 730	Realistic	212 213 265 730	Toshiba	213 274 290 297
DBX	726	Mitsubishi	276 277 278 279 280 296 297 730	Saisho	722	Vector Research . .	726 727
Electrochrome. . .	730	Montgomery Ward .	216 219 249 291 730	Salora	297	Victor	726
Emerson	203 221 243 250 293 721 722 729 730 731 732					Video Concepts . .	726 727
Fisher	211 212 213 247 265 274					XR - 1000	243
						Yamaha	726
						Zenith	201 224 225 229

Cable Boxes

Allegro	358 362		365 366		355	Teleview	326
Allegro A-B Switch	361	Jasco	325	Pioneer	315 343	Texscan	339 356 371
Archer	325	Jerrold	304 307 308 309 310 318 360 363	RCA	341	Tocom	317 318 346
Century	325	Kale Vision	335	Regency	329	Unika	325 348 362
Citizen	325	Macom	321	Samsung	326 335	Universal	325 358 362
Comtronic	326	Magnavox	327 334	Scientific Atlanta .	316 323 336 337 364	Vid Tech	340
Garrard	325	NSC	335 339 368 369 370	Signal	326	Video Way	349
Gemini	305 331 338	Oak	311 332 342	SL Marx	326	Viewstar	327 354 355 372
General Electric. .	367	Panasonic	313 320	Sprucer	313	Zenith HT-2000. . .	353
General Instrument	304 305 306 307 308 309 310 318	Philips	325 327 347 350 352 354	Standard Comp . . .	335	Zenith PM	374
Hamlin	302 303 345			Stargate	326 379		

Programming Codes

Find the codes you need to program your remote.

On this page: Cable, Satellite, CD Players, Tape Decks and Audio Tuners and Amplifiers.

Satellite Receivers

Alphastar 516	Hughes Network . . 514	RCA 510 517	Toshiba 509 512
Chaparral 501 502	JVC 518	Realistic 506	Uniden 522
Cheyenne 502	Macom 314	Sierra I 502	United 344
Dishnet 515	Magnavox 521	Sierra II 502	Zenith Drake 312 330
Drake 503	Phillips 521	Sierra III 502	Zenith Satellite . . 328 351 378 500
General Electric . . 510 517	PrimeStar 513	Sony 511	
General Instrument 504 505	ProScan 510 517	STS1 507	
Hitachi 519 520	RCA DSS 373	STS3 508	

DVD Players

JVC 965	Pioneer 963	Toshiba 961
Mitsubishi 964	Sony 962	Zenith 960

Audio CD Players

ADC 940	JVC 949 954	Panasonic 431 432 945	Sony 420 443 444 445 934
ADO 939	Kenwood 441 931 948	Phillips 421 433 434	Soundesign 461 498 901 902
Aiwa 938	Luxman 930	Pioneer 431 435 944	Sylvania 433
Akai 937	Magnavox 421 422 433 434	Quasar 432	Teac 418 419
Denon 935	Marantz 929 947	Radio Shack 431 441	Technics 432
Dynatech 953	MCS 928	RCA 437 943	Toshiba 915
Emerson 952	Mitsubishi 927	Sanyo 438 439	Yamaha 414 941 942
Fisher 438 933 951	Nakamichi 925 926	Sears 936	Zenith 460 461 498 901 902
GE 932	Onkyo 923 924 946	Sharp 441 442	
Goldstar 460	Optimus 920 921 922	Sherwood 449	
Hitachi 950			

Audio Tape Decks

Sony 452

Audio Tuners/Amps

Citizen 914	Marantz 903 913	Pioneer 470 485 907	Soundesign 461 498 901 902
GE 916	Memorex 485	Proton 910	Toshiba 915
Goldstar 460 474	Nad 904	Quasar 912	Techniques 912
Hitachi 919	Nakamichi 493	RCA 909	Victor 908
JVC 908	Onkyo 471 906	Sharp 483 917 918	Zenith 460 461 498 901 902
Kenwood 484	Optimus 905	Sherwood 900	
Luxman 467	Panasonic 912	Sony 486 489 490 491 492	

Remote Key Functions By Mode

A complete list of key functions for your remote control

KEY NAME	TV Mode Zenith Code 101	VCR Mode Zenith Code 201	Cable Mode Zenith Code 353	AUX Mode Zenith Code 960
PRG	Program Mode Codes	Program Mode Codes	Program Mode Codes	Program Mode Codes
POWER	TV On/Off	VCR On/Off	Cable Box On/Off	AUX On/Off
CABLE	Selects Cable	Selects Cable	Selects Cable	Selects Cable
VCR	Selects VCR	Selects VCR	Selects VCR	Selects VCR
AUX	Selects AUX	Selects AUX	Selects AUX	Selects AUX
TV	Selects TV	Selects TV	Selects TV	Selects TV
Surf	Channel Preview	VCR SP/EP	Cable FC/Fav Ch	AUX Audio
FLASHBK	TV Flashback	VCR Flashback	Cable Flashback	AUX Return
MUTE	TV Mute	TV Mute	TV Mute	TV Mute
CHANNEL UP	TV Channel Up	VCR Channel Up	Cable Channel Up	AUX Skip >>
CHANNEL DOWN	TV Channel Down	VCR Channel Down	Cable Channel Down	AUX Skip <<
VOLUME (RIGHT)	TV Volume Up	TV Volume Up	TV Volume Up	TV Volume Up
VOLUME (LEFT)	TV Volume Down	TV Volume Down	TV Volume Down	TV Volume Down
1	TV Digit 1	VCR Digit 1	Cable Digit 1	AUX Digit 1
2	TV Digit 2	VCR Digit 2	Cable Digit 2	AUX Digit 2
3	TV Digit 3	VCR Digit 3	Cable Digit 3	AUX Digit 3
4	TV Digit 4	VCR Digit 4	Cable Digit 4	AUX Digit 4
5	TV Digit 5	VCR Digit 5	Cable Digit 5	AUX Digit 5
6	TV Digit 6	VCR Digit 6	Cable Digit 6	AUX Digit 6
7	TV Digit 7	VCR Digit 7	Cable Digit 7	AUX Digit 7
8	TV Digit 8	VCR Digit 8	Cable Digit 8	AUX Digit 8
9	TV Digit 9	VCR Digit 9	Cable Digit 9	AUX Digit 9
0	TV Digit 0	VCR Digit 0	Cable Digit 0	AUX Digit 0
ENTER	TV Enter	VCR Enter	Cable Enter	AUX Display
MENU	TV Menu	VCR Menu	Cable Menu	AUX Menu
UP ARROW	TV Select Up	VCR Select Up	Cable Up Arrow	AUX Up Arrow
DOWN ARROW	TV Select Down	VCR Select Down	Cable Down Arrow	AUX Down Arrow
LEFT ARROW	TV Adjust Left	VCR Adjust Left	Cable Left Arrow	AUX Title
RIGHT ARROW	TV Adjust Right	VCR Adjust Right	Cable Right Arrow	AUX Sub-Title
QUIT/(Note)	TV Surr Sound	VCR Quit	Cable Quit	AUX Resume
PIP	TV PIP	VCR+	Day Up	AUX Marker
PIP CH	TV PIP Channel Mode	VCR Eject Tape	Day Down	AUX Marker Search
FREEZ	TV PIP Freeze	VCR Commercial Skip	Cable Page Up	AUX Repeat-Chap
CC	TV Closed Captions	VCR Memory	Cable Page Down	AUX Repeat A-B
TIMER	TV Timer	VCR Timer	Cable Timer	AUX Program
TV/VCR/SOURCE	TV Sources	TV Tuner or VCR Tuner	Cable Info	AUX Open/Close
RECORD	VCR Record	VCR Record	Cable Buy	AUX Angle
PAUSE	VCR Pause	VCR Pause	Cable Guide	AUX Pause
REWIND	VCR Rewind	VCR Rewind	VCR Rewind	AUX Scan <<
PLAY	VCR Play	VCR Play	VCR Play	AUX Play
STOP	VCR Stop	VCR Stop	VCR Stop	AUX Stop/Eject
FFWD	VCR Fast Forward	VCR Fast Forward	VCR Fast Forward	AUX Scan >>

References: MBR3458CT, 124-233-06 and µP 221-1445-01



Some of the functions shown above may not be available on your equipment.

Maintenance

Caring for your Entertainment Machine

Early malfunctions can be prevented. Careful and regular cleaning can extend the amount of time you will have with your new Entertainment Machine. Be sure to turn the power off and pull out the plug before you begin any cleaning.

Screen Cleaning

1. Here's a great way to keep the dust off your screen for a while. Wet a soft cloth in a mixture of lukewarm water and a little fabric softener or dish washing detergent. Wring the cloth until it's almost dry, and then use it to wipe the screen.
2. Make sure the excess water is off the screen, and then let it air-dry before you turn on your Entertainment Machine.

Cabinet Cleaning

1. Use a soft cloth with a mild soap solution to wipe the cabinet.
2. Rinse the cloth and wipe the cabinet again.
3. Let the cabinet air-dry before turning your Entertainment Machine on.

Wood Cabinet

Use a quality wood cleaner and polish. This will protect the Entertainment Machine from dirt and dust, as well as keep the cabinet looking new.

Extended Absence



If you leave your Entertainment Machine dormant for a long time (such as a vacation), it's a good idea to unplug the power to protect against possible damage from lightning or power surges. If you use an off-air antenna, you may also want to disconnect it from the back of your TV before leaving.



If you unplug your Zenith Entertainment Machine, you may have to reset the clock using the EZ Clock menu described earlier. See page 21.

Trouble Shooting

Some quick and easy tips to fixing problems yourself

SYMPTOMS	SOLUTIONS
Snowy picture and poor sound.	<ul style="list-style-type: none">• Check your antenna connection or location.
Multiple images or 'ghost shadows.'	<ul style="list-style-type: none">• Check your antenna direction and/or location.• Make sure the wire from your antenna to your Entertainment Machine is properly connected.
Interference: Sharp lines across the screen and poor sound.	<p><i>The following may cause image problems or distortion: Electrical appliances, powerful lights, cars, trucks; computers or portable phones; medical equipment</i></p> <ul style="list-style-type: none">• If possible increase the distance between your Entertainment Machine and the offending appliance. Or shut one of them off.
Normal picture but no sound.	<ul style="list-style-type: none">• Check volume levels.• Make sure the TV is not muted.• Try another channel. The problem may be the broadcast, not your Entertainment Machine.• Are the Audio A/V cables properly installed?
No picture and poor sound.	<ul style="list-style-type: none">• Are you in TV or cable tuning mode, and should be in the other?• Make sure output channels on all A/V equipment are on the same channel (3 or 4).• Check that all connections are tight.
No picture and no sound.	<ul style="list-style-type: none">• Is the AC power cord plugged in?• Check that your AC power outlet works. (Test it by plugging in something else or try another plug.)• Make sure your brightness and audio controls are set properly.• Try another channel. The problem may be with the broadcast.
No color, but the sound is O.K.	<ul style="list-style-type: none">• Check the color control in the VIDEO menu.• Try another channel. The problem may be with the broadcast.
Picture has a big black box on it, but the sound is O.K.	<ul style="list-style-type: none">• Is Text model selected but no text is available on the broadcast?• The CC (closed caption) option may be in Text mode. Select OFF in the Captions menu (see page 22).
Picture has two horizontal black bars, one on top and one on bottom.	<ul style="list-style-type: none">• Your program is in letterbox. This means that the shape of your TV is a square, but the program is a rectangle. Think of the bars as empty space the program doesn't fill; not picture that's blocked out. Because this format is a direct representation of film as you see it in movies, you are actually seeing MORE of the program when you see those bars.
Remote control doesn't work.	<ul style="list-style-type: none">• Make sure the batteries are fresh and installed properly. Does indicator light work, is it nice and bright?• Is remote in TV mode? Press TV for TV mode.
Menu options can't be changed or selected.	<ul style="list-style-type: none">• Try unplugging your Entertainment Machine for a few minutes, then plug it back in. (Don't forget to reset the clock.)
No picture or sound when a non-cable source is selected.	<ul style="list-style-type: none">• Check to see if the source equipment has been turned on.• Make sure that the connections are secure on the back of your TV and on the source.

SYMPTOMS

SOLUTIONS

Weak or no Stereo Sound when using a stereo VCR.

- Check to see if all the connections are secure.
- Look in the AUDIO menu to see if all the settings are correct.

With no key presses, on-screen menus continue to appear.

- EZ Demo feature is operating. Turn EZ Demo off in the SPECIAL menu.

PIP Problems

PIP does not work.

- Is Parental Control set to block programming?

The PIP inset is black or lacks contrast when VIDEO is the PIP source.

- Check that all the wires are connected properly.
- PIP source turned on?

The PIP inset is "snow" when the source is Video.

- Look to see if the TV/VCR button on your VCR has the TV selected.

There is no picture in the PIP inset when using VIDEO for the PIP and Antenna/Cable for the main picture.

- Look to see if the TV/VCR button on your VCR has the TV selected.

Parental Control Problems

Can't tune to programs listed in TV guide.

- Is Block option not allowing programs to appear?
- Parental Control set to block rating?

Parental Control doesn't work.

- Has Block Time expired? Lock On/Off turned Off? No hours set?

Can't watch TV or VCR.

- Is Parental Control block on? Are Aux inputs blocked? Do you know the password to unblock Parental Control?

Programs with a rating of PG-13, R, NC-17, and X do not appear.

- Is Parental Control set to block programs with those ratings.

Can't view TV-PG program.

- Is TV-PG set to be blocked in Parental Control? Reset restrictions to PG-13, then TV-PG rated programs will appear.

TV turns itself off, or on by itself.

- Sleep Timer set to turn TV off.
- Is the On/Off Timer set to turn TV on and off at preset times?
- Power Failure?

Continued on next page

Some quick and easy tips to fixing problems yourself

SYMPTOMS

SOLUTIONS

Channel/Time Display does not disappear after a period of time.

- Display will not function properly if a selected source does not have any equipment connected to it.

EZ Help menu shows only two options.

- A Video source is the selected source. Main screen source has more EZ Help options.
-

A list of definitions for some of the words found in this operating guide

A/V CABLES	Audio and Video cables. Three cables bunched together—Right audio (red), Left audio (white), and Video (yellow). A/V cables are used for stereo playback of video-cassettes and for higher quality picture and sound from other A/V devices.	MONO SOUND	Mono (monaural) sound is one channel of sound. On more than one speaker, all the speakers play the same audio.
A/V DEVICE	Equipment that produces picture and sound (VCR, DVD, cable box, or television).	75-OHM RF CABLE	The wire that comes from an off air antenna or cable service provider. Each end looks like a hex shaped nut with a wire sticking through the middle, and it screws onto the large threaded jack on the back of your TV.
ADDED	Includes channels that you want to watch in addition to the channels found by EZ Program.	OUTPUT	Refers to the jack that sends a signal out of a VCR, DVD, or other A/V device.
AMPLIFIER	An external device that amplifies sound from a television, CD player, VCR, DVD, etc.	PIP	This is the most common way to refer to the Picture-in-Picture (PIP) feature.
ANTENNA	The physical receiver of television signals sent over the air. (A large metal piece of equipment does not always have to be visible for your home to be using an antenna.)	SECOND AUDIO PROGRAMMING/SAP	Second Audio Programming (SAP) is another, separate, audio channel available with some programming. Choosing 2nd Audio/SAP often refers to listening to audio in another language, such as Spanish or French.
CABLE	Cable Box operating mode on the remote.	SIGNAL	Picture and sound traveling through cable, or over the air, to your television screen.
CABLE SERVICE	Programming provided by a cable company.	SOURCE	The term for the equipment or connection that provides audio and video (picture and sound) to your Entertainment Machine. VCR, DVD players, or Cable Boxes are examples of sources.
CAPTIONS/TEXT	A form of subtitling that writes out the dialog for your program.	STEREO SOUND	Stereo (stereophonic) sound refers to audio that's divided into right and left sides or channels.
DELETED	Removes channels that you don't watch from the channels found by EZ Program.	SURF	Use the Surf feature to create a special list of your favorite channels. You can access the "Surf" channels by pushing SURF on the remote to put the TV into Surf channel tuning mode. Press Surf again to cancel Surf channel tuning mode.
ICON	A small picture on your screen representing a function or menu item.	TUNER	Device that picks up broadcast signals and turns them into picture and sound.
INPUT	Refers to the jack that receives a signal into the TV, VCR or other A/V device.		
JACK	A connection on the back of a TV, VCR, or other A/V device. This includes the RF jack that is threaded with a place for a small wire in the center, and the Audio/Video jacks that have a bigger opening and are color-coded.		
MODE	The equipment that the remote control is currently controlling (TV, VCR, Cable, etc.) is the remote's operating "mode."		

Your Zenith Direct-View TV Warranty

Direct-View Color TV Welcome to the Zenith family! We believe that you will be pleased with your new Zenith Entertainment Machine™. Please read this warranty carefully, it is a "LIMITED WARRANTY" as defined under Federal Law. This warranty gives you specific legal rights, and you may also have other rights that vary from state-to-state within the U.S.A.

ZENITH'S RESPONSIBILITY

- Service Labor** During a period of 90 days from effective warranty date, Zenith will provide service labor by a Zenith authorized service center when needed, as determined by the Zenith service center, as a result of manufacturing defects.
- Parts** New or remanufactured replacements for factory-defective parts will be supplied by a Zenith authorized service center for one year from effective warranty date (color picture tube — two years). Such replacement parts are warranted for the remaining portion of the original warranty period.
- Home Service** Warranty service for 21" diagonal (U.S.A.) or larger screen size models is provided in the home in most cases. (Some repairs may require the unit to be taken by the servicer to the repair facility and returned, at no additional charge.)
- Not Covered** This warranty covers manufacturing defects and does not cover installation, adjustment of customer controls in the home, installation or repair of home antenna systems, cable converters or cable company-supplied equipment; it also does not cover damage due to misuse, abuse, negligence, acts of God or other causes beyond the control of Zenith. Any alteration of the product voids this warranty in its entirety.

THIS WARRANTY IS IN LIEU OF ANY OTHER WARRANTY, EXPRESSED OR IMPLIED, INCLUDING WITHOUT LIMITATION, ANY WARRANTY OF MERCHANTABILITY OR FITNESS FOR A PARTICULAR PURPOSE, AND ZENITH SHALL NOT BE LIABLE FOR ANY CONSEQUENTIAL, INDIRECT, OR INCIDENTAL DAMAGES OF ANY KIND, INCLUDING LOST REVENUES OR PROFITS IN CONNECTION WITH THIS PRODUCT. SOME STATES DO NOT ALLOW LIMITATIONS ON HOW LONG AN IMPLIED WARRANTY LASTS OR THE EXCLUSION OR LIMITATION OF INCIDENTAL OR CONSEQUENTIAL DAMAGES, SO THE ABOVE LIMITATIONS OR EXCLUSIONS MAY NOT APPLY TO YOU.

OWNER'S RESPONSIBILITY

- Effective Warranty Date** Warranty begins on the date of original consumer purchase. For your convenience, keep the dealer's dated bill of sale or delivery ticket as evidence of the purchase date.
- Operating Guide** Read your Operating Guide carefully so that you will understand the operation of your set and how to adjust the customer controls.
- Carry-In Service** Models under 21" diagonal (U.S.A.) screen size must be taken to a Zenith authorized service center for warranty service and must be picked up by the owner.
- Antenna** Reception problems caused by inadequate home antenna or faulty antenna connections are the owner's responsibility.
- Important** Product Registration—Please fill out and mail your Product Registration Card. It is imperative that Zenith know how to reach you promptly if we should discover a safety problem that could affect you.
- Warranty Service** For warranty service information, contact any Zenith authorized service center. Parts and service labor that are Zenith's responsibility (see above) will be provided without charge. Other service is at the owner's expense. If you have any problem in obtaining satisfactory warranty service, call or write the Zenith Response Center. You must provide the model number, serial number and date of purchase or date of original installation. Before you ask for warranty service, read "Maintenance And Troubleshooting" in your operating guide. You might avoid a service call.

ZENITH ELECTRONICS CORPORATION
Zenith Response Center
2000 Millbrook Drive
Lincolnshire, IL 60069, USA
Phone 1-847-941-800
Mon-Fri, 7:00 a.m.- 8:00 p.m. CST
Sat, 8:00 a.m.-5:00 p.m. CST
www.zenith.com

ZENITH CONSUMER SERVICES

801 E. Roosevelt Rd.
Lombard, IL 60148
Telephone (630) 705-2830

Home & Carry-in Service
Television/VCR
Parts and Accessories
PTV/Camcorders

201 James Record Rd.
Building 4
Huntsville, AL 35824
Telephone (256) 774-4025

Service Hours:
M-F 8-6, Sat 9-2
Will accept UPS shipments



Be sure to send in the Product Registration Card. We will send you an application for the Protection Plan near the expiration of the two-year manufacturer's warranty on the picture tube. For additional information call (256) 774-4088.