

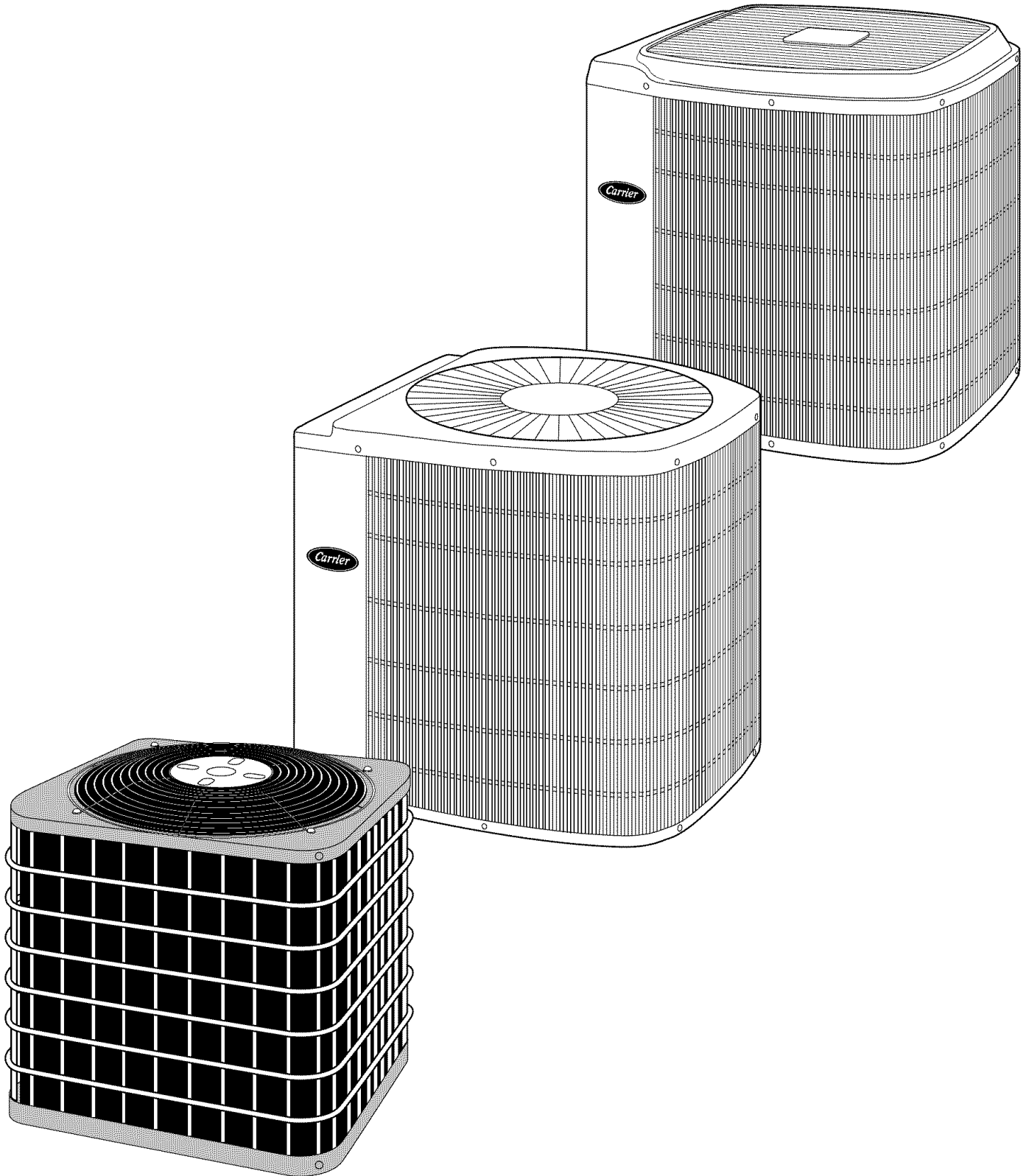

HEAT PUMP

A GUIDE TO OPERATING AND MAINTAINING YOUR RESIDENTIAL HEAT PUMP UNIT



NOTE TO INSTALLER: THIS MANUAL SHOULD BE LEFT WITH THE EQUIPMENT USER.

WELCOME TO EFFICIENT YEAR-ROUND COMFORT

Congratulations on your excellent choice and sound investment in year-round home comfort!

Your new heat pump represents both the latest in engineering development and the culmination of many years of experience from one of the most reputable manufacturers of comfort systems.

Your new unit is among the most energy-efficient and reliable heat pump products available today. To assure its dependability, spend just a few minutes with this booklet now. Learn about the operation of your heat pump, and the small amount of maintenance it takes to keep it operating at its peak efficiency.

With minimal care, your new heat pump will provide you and your family with year-round home comfort—both now and for years to come.

SAFETY CONSIDERATIONS

Recognize safety information. This is the safety-alert symbol . When you see this symbol on the unit and in instructions or manuals, be alert to the potential for personal injury.

Understand the signal words DANGER, WARNING, and CAUTION. These words are used with the safety-alert symbol. DANGER identifies the most serious hazards which **will** result in severe personal injury or death. WARNING signifies hazards which **could** result in personal injury or death. CAUTION is used to identify unsafe practices which **would** result in minor personal injury or product and property damage. NOTE is used to highlight suggestions that **will** result in enhanced installation, reliability, or operation.

WARNING

Improper installation, adjustment, alteration, service, maintenance, or use can cause explosion, fire, electrical shock, or other conditions which may cause personal injury or property damage. Consult a qualified installer, service agency, or your distributor or branch for information or assistance. The qualified installer or service agency must use factory-authorized kits or accessories when modifying this product.

WARNING

To prevent personal injury, death, or property damage, read and follow all instructions and warnings, including labels shipped with or attached to unit before operating your new heat pump.

YOUR COMFORT SYSTEM

Identifying Your System

Take the time to familiarize yourself with the type of system you have. This knowledge will be of use in understanding the basic operation of your new heat pump.

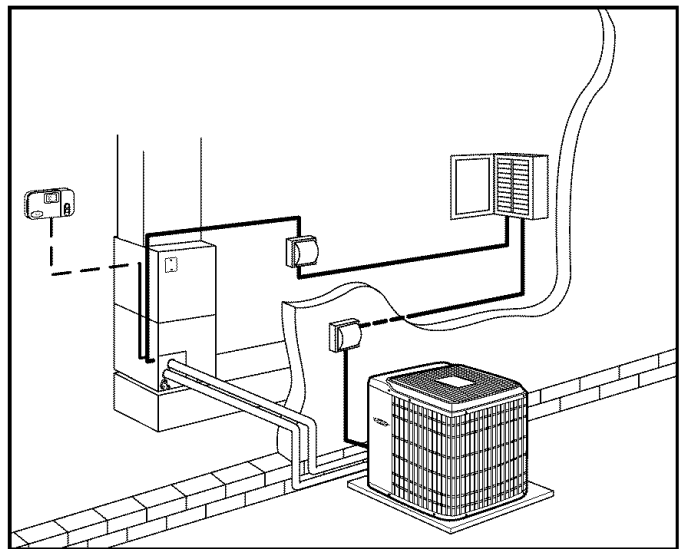

Fig.1—Typical Split-System Installation

The type of heat pump you have purchased is a split system. The split-system type has an indoor and an outdoor unit, each of which contains a coil. These units are interconnected by refrigerant tubes. (See Fig. 1.)

Each unit has a rating plate affixed to it which provides necessary information for specific identification of a unit. You should familiarize yourself with the product, model, and serial numbers listed on each rating plate. Record them for future reference on the last page of this booklet.

IMPORTANT FACTS

To better protect your investment and to eliminate unnecessary service calls, familiarize yourself with the following facts:

- Your heat pump system should never be operated without a clean air filter properly installed. Plan to inspect the filter periodically. A clogged air filter will increase operating costs and shorten the life of the unit.
- Supply-air and return-air registers should not be blocked. Drapes, furniture, and toys are some of the items commonly found obstructing registers. Restricted airflow lessens the unit's efficiency and life span.
- The outdoor unit must have unrestricted airflow. Do not cover the unit, lean anything against it, or stand on it. Do not allow grass clippings, leaves, or other debris to accumulate around or on top of the unit. Maintain a 12-in. minimum clearance between the outdoor unit and tall grass, vines, shrubs, etc.
- Your multipurpose indoor thermostat is the control center for your heat pump system. You should familiarize yourself with its proper operation. Attempting to control the system by other means—for instance, switching the electrical supply power ON and OFF—may cause damage to the unit. (See Fig. 2 and 3.)
- During heating, increasing the thermostat setting more than 2 degrees may cause the supplemental heaters to be turned on to satisfy the thermostat. Needless use of the supplementary heat reduces potential energy savings.
- You may find that you can maintain greater personal comfort by running the fan continuously. "Air pockets" can form due to the structure of the house, placement of registers, etc.

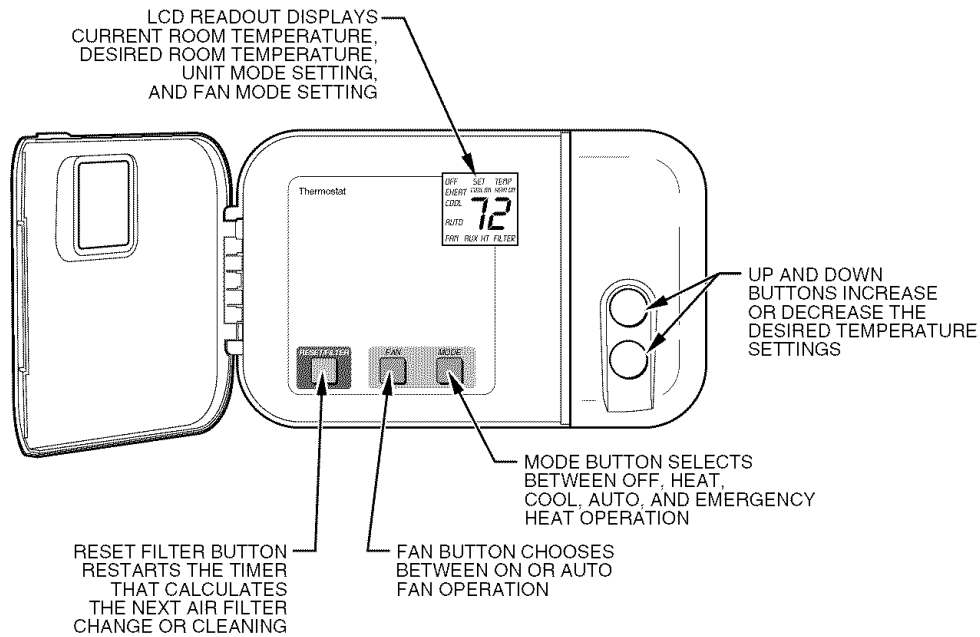

Fig. 2—Typical Carrier Non-Programmable Thermostat

These air pockets may be too cool or warm for your liking. Continuous fan operation minimizes any temperature differences. Also, systems equipped with electronic or mechanical air cleaners and/or humidifiers offer the added benefits of having the air continuously cleaned year-round and humidified during the winter season.

- A system equipped with a heat or energy recovery ventilator offers the advantage of exhausting stale air from the home and allowing fresh air in from the outdoors while minimizing heat loss.
- Your system may also be equipped with a zoning system which allows individual control over the temperatures of separate areas of your home.
- Your heat pump will remove humidity from your home during the cooling season.

After a few minutes of operation, you should be able to see water trickle from the condensate drain of the indoor cooling coil. Check this occasionally to be sure the drain system is not clogged. Of course, don't expect to see much drainage if you live in a very dry environment.

- During the heating cycle, air from your registers may seem cooler than you might first expect. This is because your heat pump delivers a constant flow of air at around 90°F to 105°F instead of in sudden bursts of hot air as with a conventional furnace. This air may feel cool because it is slightly less than your skin temperature. However, it is sufficiently warm to keep you comfortable.
- Ice or frost will tend to form on the outdoor coil during the winter heating operation. Your heat pump is designed to automatically

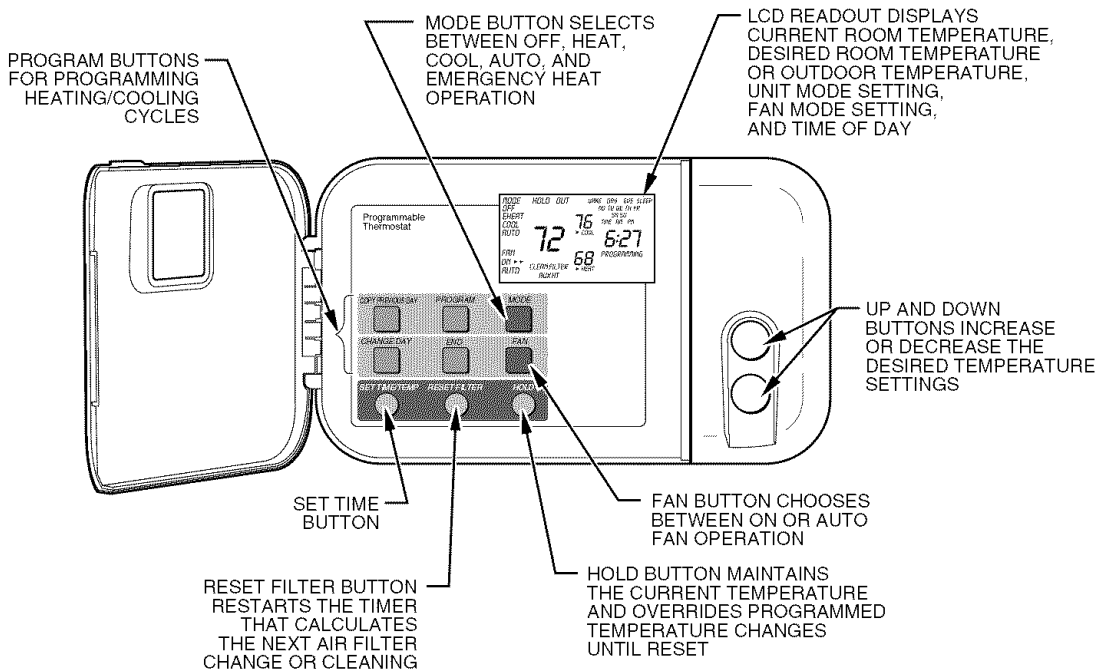

Fig. 3—Typical Carrier Programmable Thermostat

melt the ice. When in this defrost cycle, it is normal for steam or fog to rise from the outdoor unit. Do not be alarmed!

- Do not operate your unit in cooling mode when outdoor temperatures are below 55°F unless your unit was modified for low-ambient operation.
- Do not operate your unit in heating mode when outdoor temperatures are above 66°F unless you set your thermostat to emergency heat mode.

OPERATING YOUR HEAT PUMP

The operation of your heat pump system is controlled by the indoor thermostat. You simply adjust the thermostat and it maintains the indoor temperature at the level you select. Most thermostats for heat pump systems have 3 controls: a temperature control selector, a FAN control, and a SYSTEM or MODE control.

The temperature control selector is a dial, lever, or set of buttons that allows you to establish the temperature that you wish to maintain for your personal comfort. Some thermostats have 2 temperature control selectors: 1 for setting the temperature desired during cooling operation, and 1 for setting the temperature desired during heating operation. A typical setting for year-round comfort is 72°F.

The FAN control offers 2 options for controlling the blower: AUTO and ON. When set to AUTO, the blower runs only when the heat pump is operating. When set to ON, the blower runs continuously.

Typically, the SYSTEM or MODE control on your thermostat offers the following selections: COOL, OFF, HEAT, AUTO, and EMERGENCY HEAT. Some thermostats may have a separate switch for EMERGENCY HEAT. The heat pump will not operate when the SYSTEM OR MODE control is set to OFF. With the SYSTEM or MODE control set to COOL, your heat pump will provide cooling when the indoor temperature rises above the level you wish to maintain. With the SYSTEM or MODE control set to HEAT, your heat pump will provide warmth whenever the indoor temperature falls below the level that you have selected.

The AUTO selection found on some thermostats provides for automatic changeover between cooling and heating. With the SYSTEM or MODE control set to AUTO, cooling operation is activated when the indoor temperature rises above the thermostat cooling temperature setting, or heating operation is activated when the indoor temperature drops below the thermostat heating setting.

Depending on your typical winter heating needs, your home comfort system may include a supplementary heating source. The EMERGENCY HEAT setting (EHEAT) provides for convenient selection between the 2 heating appliances. Your heat pump will operate when the SYSTEM or MODE control is set to HEAT. With the SYSTEM or MODE control set to EHEAT, the heat pump will turn off and the supplementary heat source will be activated.

In certain geographic areas and in certain applications, supplemental heat is not required. Any questions regarding your application should be directed to your dealer.

Your thermostat may be PROGRAMMABLE or NON-PROGRAMMABLE. A NON-PROGRAMMABLE thermostat does not allow the temperature settings to be varied throughout the day or week without physically changing the settings. A PROGRAMMABLE thermostat allows various daily temperature changes to be preset. During the winter, for example, you may wish to “set back” the temperature of your home at night, then have the temperature return to normal prior to waking up. The home’s temperature can then be lowered again during the day when no one is at

home, but again be at peak comfort level when your family returns home. During the summer, the opposite changes might be programmed. When properly used, the programming can result in energy savings on your home’s heating and cooling.

COOLING MODE

When operating in cooling mode, your heat pump will run in cooling mode until the indoor temperature is lowered to the level you have selected. On extremely hot days, your heat pump will run for longer periods at a time and have shorter “off” periods than on moderate days.

The following are typical conditions that add extra heat and/or humidity to your home. Your heat pump will work longer to keep your home comfortable under these conditions:

- Entrance doors are frequently opened and closed,
- Laundry appliances are being operated,
- A shower is running,
- More than the usual number of people are present in the home,
- More than the normal number of electric lights are in use,
- Drapes are open on the sunny side of the home.

HEATING MODE

With the SYSTEM or MODE control of your indoor thermostat set to HEAT, your heat pump will run in heating mode until room temperature is raised to the level you have selected. Of course, your heat pump will have to operate for longer periods to maintain a comfortable environment on cooler days and nights than on moderate ones.

SUPPLEMENTAL HEAT

Your heat pump is your primary heating source. Your system may also be equipped with a supplemental heating source such as electric, gas, or oil. On cold days and nights, your system will automatically turn on the supplemental heat in order to maintain the level of comfort you have selected.

DEFROST MODE

When your heat pump is providing heat to your home and the outdoor temperature drops below 45°F, moisture may begin to freeze on the surface of the outdoor coil. If allowed to build up, this ice would impede airflow across the coil and reduce the amount of heat absorbed from the outside air. So, to maintain energy-efficient operation, your heat pump has an automatic defrost mode.

The defrost mode starts at a preset time interval of 90 minutes, although, it may be reset to either 30, 60, or 120 minutes. Defrost will start at the preset time only if the ice is sufficient to interfere with normal heating operation.

After the ice is melted from the outdoor coil, or after a maximum of 10 minutes in defrost mode, the unit automatically switches back to normal heating operation. The fan will resume normal operation after a 20-second delay.

Do not be alarmed if steam or fog appears at the outdoor unit during defrost mode. Water vapor from the melting ice may condense into a mist in the cold outside air.

During certain weather conditions such as heavy snow and freezing rain it is not uncommon for ice to build up on the outdoor unit grille. This is normal for these weather conditions. Do not attempt to remove the ice from the outdoor unit grille. This condition will not affect the proper function of the unit and will clear within a few days.

EMERGENCY HEAT MODE

The emergency heat (EHEAT) setting on your Carrier electronic thermostat can be used to turn off your heat pump and use only the supplemental heating source (if equipped). The Auxiliary Heat Indicator (AUX HT) will be displayed while your system is operating in EHEAT mode.

Emergency heat is not normally used. There may be situations, however, when it is necessary, such as when your heat pump requires servicing.

If the electricity to your heat pump has been off for more than 30 minutes, switch your thermostat to EHEAT mode before restarting your heat pump. Leave the system in EHEAT mode for an amount of time equal to the power outage. It is not necessary to exceed 12 hrs. If you cannot determine how long the power has been off, leave the system in EHEAT mode for 8 hrs.

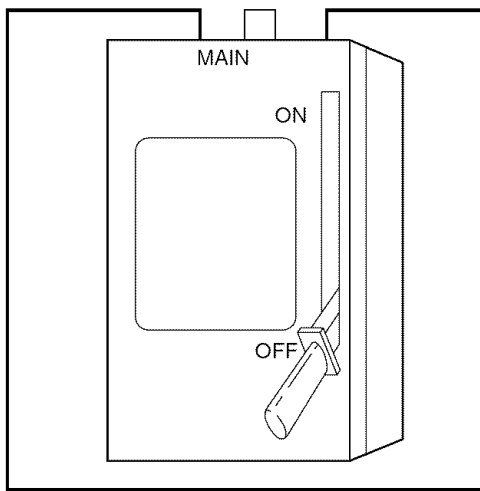

Fig. 4—Main Electrical Disconnect

PERFORMING ROUTINE MAINTENANCE

With the proper maintenance and care, your heat pump will operate economically and dependably. Maintenance can be accomplished easily by referring to the following directions. However, before performing maintenance, consider these important safety precautions:

⚠ WARNING

Disconnect all electrical power to the indoor air handler or furnace before removing access panels to perform any maintenance. Disconnect power to both the indoor and outdoor units. NOTE: There may be more than one electrical disconnect switch. Electrical shock can cause personal injury or death.

⚠ CAUTION

Although special care has been taken to minimize sharp edges in the construction of your unit, be extremely careful when handling parts or reaching into the unit. Failure to follow this caution could result in minor personal injury or product and property damage.

CHECK THE AIR FILTER

A dirty air filter will cause excessive strain on the compressor and blower motor. This can cause the components to over-heat and automatically shut down. In the worst case, the components will fail and need to be replaced. To avoid inefficient or failed operation of your unit, CHECK THE FILTER(S) EVERY 3 TO 4 WEEKS. Replace filter(s) when necessary, or clean the filter(s) if you have the reusable type.

Disposable filters should be replaced by similar, new filters of the same dimensions.

Reusable, permanent filters should be washed in a solution of cold water and mild detergent, then rinsed and thoroughly dried. THE FILTER MUST BE COMPLETELY DRY BEFORE BEING REINSTALLED. To avoid prolonged shutdown of your unit while a filter is drying, you should have an extra filter on hand. This allows you to rotate between the 2 with minimal downtime for your comfort system. Extra filters may be purchased from your dealer.

There are no filters in the outdoor unit of a split system. If your indoor unit is a gas or oil furnace, refer to your furnace User's Manual for filter location and procedures for replacement or cleaning.

If your system includes an indoor fan coil unit, the filter may be located in the unit where it connects with the return-air duct or plenum. (See Fig. 5.) Remove the filter cover plate by sliding latches toward center of plate. Lift filter to clear lower flange. Filter is spring-loaded and will "pop out." Reinstall filter, being certain to secure filter behind lower flange. When reinstalling cover plate, secure plate behind upper flange then slide tabs outward.

The indoor fan coil unit may be located in the attic. In this instance the filter may be located behind the return air grille. Access the filter by removing the return air grille.

If your system includes a high efficiency or electronic air cleaner, refer to air cleaner User's Manual for proper filter cleaning or replacement.

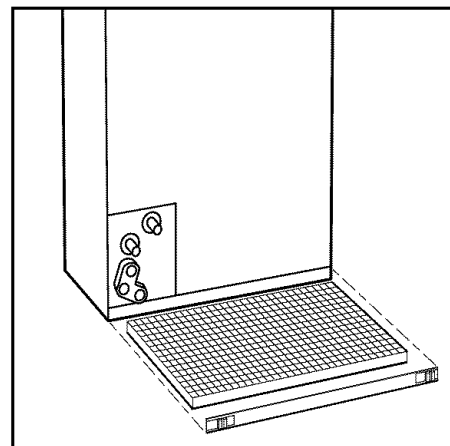

Fig. 5—Removing Filter from Fan Coil Unit

INDOOR COIL

If the split-system coil has only been operated with a clean filter in place, it should require minimal cleaning.

If coil cleaning is required, call your dealer for service. It may be necessary to clean the coil with a detergent solution and rinse it with water. This could require the removal of the coil. You should not attempt this yourself.

OUTDOOR COIL

If grass clippings, leaves, shrubbery, and debris are kept away from the outdoor unit, minimal care should be sufficient to keep the system functioning properly. For proper drainage, debris must be removed periodically from the base pan. However, if the outdoor coil becomes dirty, use a vacuum cleaner or shop vac with soft brush attachment to clean the exterior surface. Vacuum coil surface using an up and down motion. Be careful not to bend or damage fins.

If dirt is deep in the coil, contact your dealer for service. The outdoor fan motor may have to be disconnected and the top panel removed to gain access to the coil for thorough cleaning. Do not attempt this yourself.

OUTDOOR COIL—SEA COAST

If your unit is located near the ocean, special maintenance is required. Ocean mist/breeze carries salt, which is corrosive to most metals. Although your new unit is made out of galvanized metal and is protected by top-grade paint, you should take the precaution of additional maintenance which consists of periodically washing the unit. By washing all exposed surfaces and coil, you will be adding additional life to your unit. Please consult your installing contractor for proper intervals/procedures for your geographic area or service contact.

UNIT SUPPORT

Your split-system outdoor unit should be maintained at a level position. If its support should shift or settle so that the unit is no longer level, you should correct the condition. Relevel it promptly to assure water drains out of the unit. If you notice that water or ice collects beneath the unit, arrange for it to be drained away from the unit.

Heat pumps installed in snowbelt areas should be elevated with support feet or a snow stand.

BEFORE YOU REQUEST A “SERVICE CALL”

CHECK FOR THESE EASILY SOLVED PROBLEMS:

- Check the indoor and outdoor disconnect switches. Verify that circuit breakers are ON or that fuses have not blown.
- Check for sufficient airflow. Check the air filter(s) for any accumulations of dirt. Check for blocked return-air or supply-air registers. Be sure registers are open and unobstructed.
- Check the settings on your indoor thermostat. If you desire cooling, make sure that the temperature control selector is set below room temperature and the SYSTEM or MODE control

is set to COOL or AUTO. If you require warmth, make sure that the temperature control selector is set above room temperature and the SYSTEM or MODE control is set to HEAT or AUTO. The FAN control should be set to ON for continuous blower operation or AUTO if you wish blower to function only while your heat pump is operating.

If your comfort system still fails to operate, turn your system off and contact your servicing dealer for troubleshooting and repairs. Specify your apparent problem, and state the model and serial numbers of your equipment. (You should have them recorded on the last page of this booklet.) With this information, your dealer may be able to offer helpful suggestions over the phone or save valuable time through knowledgeable preparation for the service call.

REGULAR DEALER MAINTENANCE

In addition to the routine maintenance that you perform, your home comfort system should be inspected regularly by a properly trained service technician. The inspection (preferably twice each year, but at least once every year) should include the following:

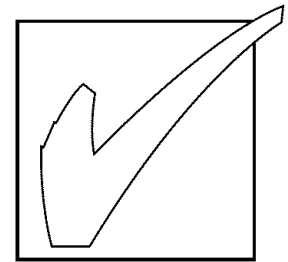

- Routine inspection of air filter(s). Replacement or cleaning as required.
- Inspection and cleaning of the blower wheel, housing, and motor as required.
- Inspection and, if required, cleaning of indoor and outdoor coils.
- Inspection of the indoor coil drain pan, plus the primary and secondary drain lines. If supplied, the auxiliary drain pan and line should be inspected at this time. Service should include cleaning if required.
- A check of all electrical wiring and connections.
- A check for secure physical connections of individual components within units.
- Operational check of the heat pump system to determine actual working condition. Necessary repair and/or adjustment should be performed at this time.
- Your servicing dealer may offer an economical service contract that covers seasonal inspections. Ask for further details.

FOR THE RECORD

Record the model, product, and serial numbers of your new equipment in the spaces provided. This information, along with the other ready-reference facts requested will be necessary should you ever require information or service.

INSTALLATION DATA

Date Installed _____
Dealer Name _____
Address _____
City _____
State _____ Zip _____
Telephone _____

SPLIT-SYSTEM

Outdoor Unit:
Product No. _____
Model No. _____
Serial No. _____

Indoor Unit or Coil:
Product No. _____
Model No. _____
Serial No. _____

MODULAR INDOOR UNIT, if Applicable:

Blower—Product No. _____
Model No. _____
Serial No. _____

Coil—Product No. _____
Model No. _____
Serial No. _____

Heater—Product No. _____
Model No. _____
Serial No. _____

ACCESSORIES

Product No. _____
Product No. _____
Product No. _____
Product No. _____
Product No. _____



HEATING & COOLING

TO OBTAIN INFORMATION ON PARTS: Consult your installing dealer or classified section of your local telephone directory under the "Heating Equipment" or "Air Conditioning Contractors & Systems" heading for dealer listing by brand name. Have available the Model No., Series Letter, & Serial No. of your equipment to ensure correct replacement part.

Carrier Corporation • Indianapolis, Indiana 46231

Manufacturer reserves the right to discontinue, or change at any time, specifications or designs without notice and without incurring obligations.