



# Electric Range

Use & Care Guide

# Estufa eléctrica

Guía para el Uso y Cuidado

Models, Modelos **790.9611\***, **9612\***, **9613\***

\* = color number, número de color

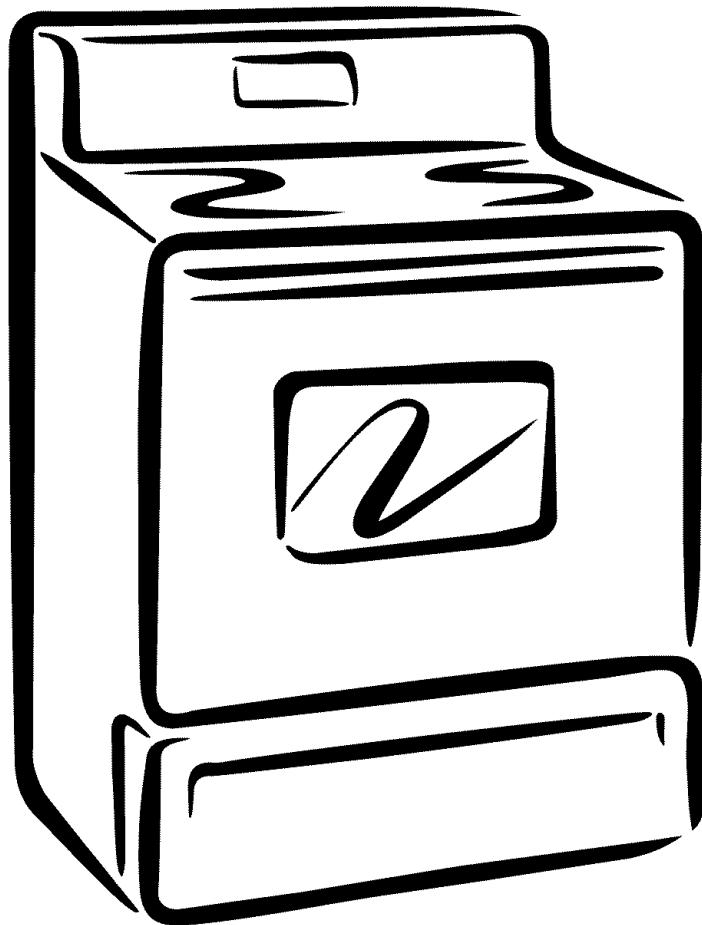

ENGLISH

ESPAÑOL

## Table of Contents

Free-Standing Range Warranty .....	2
Product Record .....	2
<b>IMPORTANT SAFETY INSTRUCTIONS</b> .....	3-4
Protection Agreements .....	5
Range Features .....	6
Before Setting Oven Controls .....	7-8
Setting Surface Controls .....	9-10
Surface Cooking .....	11
Oven Control Functions .....	12
Setting Oven Controls .....	13-17
Setting Warmer Drawer Controls .....	17-18
Select Self Cleaning .....	19-20
General Care & Cleaning .....	21-24
Adjusting Your Oven Temperature .....	24
Before You Make a Service Call .....	25-26
Sears Service .....	Back Page
Español .....	29-56

## Product Record

In this space below, record the date of purchase, model and serial number of your product. You will find the model and serial number printed on an identification plate. This serial plate is located on the right side of the oven front frame in the storage or warmer drawer compartment. **See bottom of this page** for the serial plate location.

Model No. 790.

Serial No. \_\_\_\_\_

Date of Purchase \_\_\_\_\_

Save these instructions and your sales receipt for future reference.

## Free-Standing Range Warranty

### FULL ONE YEAR WARRANTY ON ALL PARTS

For one year from the date of purchase, when installed and operated according to the Installation Instructions and Use & Care Guide, if any part of this range fails due to a defect in material or workmanship, Sears will repair or replace it, at our option, free of charge.

### ADDITIONAL FOUR-YEAR LIMITED WARRANTY ON RANGE PARTS

For the second through the fifth year from the date of purchase, when installed and operated according to the Installation Instructions and Use & Care Guide, Sears will supply the following range parts free of charge if they fail for the reasons listed below. Customer must pay labor cost of installation.

- Cooktop glass if it fails due to thermal shock
- Cooking elements if they are defective
- Rubber seal if it cracks between the cooktop glass and the porcelain edge.

#### What Sears will not cover:

- Failure of the product if it is abused, misused, or used for other than the intended purpose.
- Damage to the cooktop glass caused by the use of cleaners or utensils other than the recommended cleaning cream and tools.
- Damage to the cooktop glass caused by hardened spills of sugary materials (including starches from vegetables or pastas) or melted plastic that are not cleaned according to the directions in the Use & Care Guide.
- Repairs to parts or systems resulting from unauthorized modifications made to the appliance.

If this product is subjected to other than private residential use, all warranty coverage is effective for only 90 days.

**WARRANTY SERVICE IS AVAILABLE BY CONTACTING SEARS AT  
1-800-4-MY-HOME®.**

This warranty gives you specific legal rights, and you may also have other rights which vary from state to state.  
Sears, Roebuck and Co., Dept. 817WA, Hoffman Estates, IL 60179

## Serial Plate Location

You will find the model and serial number printed on the serial plate. The serial plate is located on the right side of the oven front frame in the storage or warmer drawer compartment.

Please see the illustration for exact location. Remember to record the serial number for future reference (See top of page under Product Record).

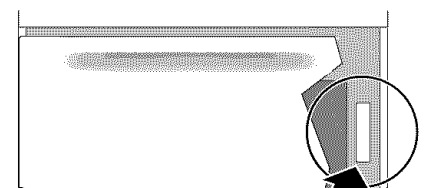

Serial plate location; Open the Warmer Drawer (some models) or storage drawer (some models).

# Important Safety Instructions

**Read all instructions before using this appliance. Save these instructions for future reference.**

This manual contains important safety symbols and instructions. Please pay attention to these symbols and follow all instructions given.

**⚠ WARNING** This symbol will help alert you to situations that may cause serious bodily harm, death or property damage.

**⚠ CAUTION** This symbol will help alert you to situations that may cause bodily injury or property damage.

- **Remove all tape and packaging before using the range.** Destroy the carton and plastic bags after unpacking the range. Never allow children to play with packaging material.
- **Proper Installation—Be sure your appliance is properly installed and grounded by a qualified technician in accordance with the National Electrical Code ANSI/NFPA No. 70 latest edition and local electrical code requirements.** Install only per installation instructions provided in the literature package for this range.  
Ask your dealer to recommend a qualified technician and an authorized repair service. Know how to disconnect the power to the range at the circuit breaker or fuse box in case of an emergency.
- **User servicing—Do not repair or replace any part of the appliance unless specifically recommended in the manuals.** All other servicing should be done only by a qualified technician. This may reduce the risk of personal injury and damage to the range.
- **Never modify or alter the construction of a range by removing leveling legs, panels, wire covers, anti-tip brackets/screws, or any other part of the product.**

## ⚠ WARNING

- All ranges can tip.
- Injury to persons could result.
- Install anti-tip device packed with range.
- See Installation Instructions.



**⚠ WARNING** To reduce the risk of tipping, the range must be secured by properly installed anti-tip bracket provided with the range. To check if the bracket is installed properly, visually check that rear leveling leg is inserted into and fully secured by the anti-tip bracket by removing lower panel or storage drawer. For models with a warmer drawer, grasp the top rear edge of the range and carefully attempt to tilt it forward. Refer to the installation instructions for proper anti-tip bracket installation.

**⚠ WARNING** Stepping, leaning or sitting on the doors or drawers of this range can result in serious injuries and also cause damage to the range. Do not allow children to climb or play around the range. The weight of a child on an open door may cause the range to tip, resulting in serious burns or other injury.

**⚠ CAUTION** Do not store items of interest to children in the cabinets above a range or on the backguard of a range. Children climbing on the range to reach items could be seriously injured.

**⚠ WARNING** Do not use the oven or warmer drawer (if equipped) for storage.

**⚠ WARNING** Never Use Your Appliance for Warming or Heating the Room.

- **Storage in or on Appliance—Flammable materials should not be stored in an oven, warmer drawer, near surface units or in the storage drawer.** This includes paper, plastic and cloth items, such as cookbooks, plasticware and towels, as well as flammable liquids. Do not store explosives, such as aerosol cans, on or near the range.
- **Do Not Leave Children Alone—Children should not be left alone or unattended in the area where appliance is in use.** They should never be allowed to sit or stand on any part of the appliance.
- **DO NOT TOUCH SURFACE UNITS, AREAS NEAR THESE UNITS, HEATING ELEMENTS OR INTERIOR SURFACES OF THE OVEN.** Both surface units and oven heating elements may be hot even though they are dark in color. Areas near surface units may become hot enough to cause burns. During and after use, do not touch, or let clothing or other flammable materials touch these areas until they have had sufficient time to cool. Among these areas are the cook top, surfaces facing the cook top, the oven vent openings and surfaces near these openings, oven door and window.
- **Wear Proper Apparel—Loose-fitting or hanging garments should never be worn while using the appliance.** Do not let clothing or other flammable materials contact hot surfaces.
- **Do Not Use Water or Flour on Grease Fires—Smother the fire with a pan lid, or use baking soda, a dry chemical or foam-type extinguisher.**
- **When heating fat or grease, watch it closely.** Fat or grease may catch fire if allowed to become too hot.
- **Use Only Dry Potholders - Moist or damp potholders on hot surfaces may result in burns from steam.** Do not let potholders touch hot heating elements. Do not use a towel or other bulky cloth instead of a potholder.
- **Do Not Heat Unopened Food Containers - Buildup of pressure may cause container to burst and result in injury.**
- **Remove the oven door from any unused range if it is to be stored or discarded.**

**IMPORTANT—Do not attempt to operate the range during a power failure.** If the power fails, always turn off the range. If the range is not turned off and the power resumes, the range will begin to operate again. Once the power resumes, reset the clock and oven function.

# Important Safety Instructions

## IMPORTANT INSTRUCTIONS FOR USING YOUR COOKTOP

- **Know which knob controls each surface heating unit.** Place a pan of food on the unit before turning it on, and turn the unit off before removing the pan.
- **Use Proper Pan Size**—This appliance is equipped with one or more surface units of different sizes. Select utensils having flat bottoms large enough to cover the surface unit heating element. The use of undersized utensils will expose a portion of the heating element to direct contact and may result in ignition of clothing. Proper relationship of utensil to element will also improve efficiency.
- **Utensil Handles Should Be Turned Inward and Not Extend Over Adjacent Surface Elements**—To reduce the risk of burns, ignition of flammable materials, and spillage due to unintentional contact with the utensil, the handle of the utensil should be positioned so that it is turned inward, and does not extend over adjacent surface units.
- **Never Leave Surface Elements Unattended at High Heat Settings**—Boilovers cause smoking and greasy spillovers that may ignite, or a pan that has boiled dry may melt.
- **Do Not Immerse or Soak Removable Heating Elements**—Heating elements should never be immersed in water. Heating elements clean themselves during normal operation.
- **Glazed Cooking Utensils**—Only certain types of glass, glass/ceramic, ceramic, earthenware, or other glazed utensils are suitable for cook top service without breaking due to the sudden change in temperature. Check the manufacturer's recommendations for cook top use.
- **When flaming foods under a ventilating hood, turn the fan on.**

## SELF CLEANING OVENS

- **Clean in the self-cleaning cycle only the parts listed in this Use & Care Manual.** Before self cleaning the oven, remove the broiler pan and any utensils or foods from the oven.
- **Do Not Use Oven Cleaners**—No commercial oven cleaner or oven liner protective coating of any kind should be used in or around any part of the oven.
- **Do Not Clean Door Gasket**—The door gasket is essential for a good seal. Care should be taken not to rub, damage or move the gasket.
- The health of some birds is extremely sensitive to the fumes given off during the self-cleaning cycle of any range. Move birds to another well-ventilated room.

## IMPORTANT INSTRUCTIONS FOR CLEANING YOUR RANGE

- **Clean the range regularly to keep all parts free of grease that could catch fire.** Pay particular attention to the area underneath each surface element. Do not allow grease to accumulate.
- **Kitchen cleaners and aerosols**—Always follow the manufacturer's recommended directions for use. Be aware that excess residue from cleaners and aerosols may ignite causing damage and injury.
- **Clean Ventilating Hoods Frequently**—Grease should not be allowed to accumulate on the hood or filter. Follow manufacturer's instructions for cleaning.

## FOR CERAMIC-GLASS COOK TOP MODELS

- **Do Not Cook on Broken Cook Top**—If cook top should break, cleaning solutions and spillovers may penetrate the broken cook top and create a risk of electric shock. Contact a qualified technician immediately.
- **Clean Cook Top with Caution**—If a wet sponge or cloth is used to wipe spills on a hot cooking area, be careful to avoid a steam burn. Some cleaners can produce noxious fumes if applied to a hot surface.

## IMPORTANT INSTRUCTIONS FOR USING YOUR OVEN

- **Use Care When Opening Oven Door or Warmer Drawer (if equipped)**—Stand to the side of the range when opening the door of a hot oven. Let hot air or steam escape before you remove or replace food in the oven.
- **Keep Oven Vent Ducts Unobstructed.** The oven vent is located under the left rear surface element if your model is equipped with coil elements. The oven vent is located below the backguard for models equipped with ceramic-glass cook tops. Touching the surfaces in this area when the oven is operating may cause severe burns. Also, do not place plastic or heat-sensitive items on or near the oven vent. These items could melt or ignite.
- **Placement of Oven Racks.** Always place oven racks in desired location while oven is cool. If rack must be moved while oven is hot use extreme caution. Use potholders and grasp the rack with both hands to reposition. Do not let potholders contact the hot heating elements in the oven. Remove all utensils from the rack before moving.
- **Do not use the broiler pan without its insert.** The broiler pan and its insert allow dripping fat to drain and be kept away from the high heat of the broiler.
- **Do not cover the broiler insert with aluminum foil. Exposed fat and grease could ignite.**
- **Protective Liners**—Do not use aluminum foil to line the oven bottom. Only use aluminum foil as recommended in this manual. Improper installation of these liners may result in risk of electric shock, or fire.

---

## Important Safety Notice

The California Safe Drinking Water and Toxic Enforcement Act requires the Governor of California to publish a list of substances known to the state to cause cancer, birth defects or other reproductive harm, and requires businesses to warn customers of potential exposure to such substances.

# PROTECTION AGREEMENTS

## In the U.S.A.

### Master Protection Agreements

*Congratulations on making a smart purchase. Your new Kenmore® product is designed and manufactured for years of dependable operation. But like all products, it may require preventive maintenance or repair from time to time. That's when having a Master Protection Agreement can save you money and aggravation.*

*Purchase a Master Protection Agreement now and protect yourself from unexpected hassle and expense.*

The Master Protection Agreement also helps extend the life of your new product. Here's what's included in the Agreement:

- ☑ **Expert service** by our 12,000 professional repair specialists
- ☑ **Unlimited service and no charge** for parts and labor on all covered repairs
- ☑ **"No-lemon" guarantee** – replacement of your covered product if four or more product failures occur within twelve months
- ☑ **Product replacement** if your covered product can't be fixed
- ☑ **Annual Preventive Maintenance Check** at your request – no extra charge
- ☑ **Fast help by phone** – phone support from a Sears technician on products requiring in-home repair, plus convenient repair scheduling
- ☑ **Power surge protection** against electrical damage due to power fluctuations
- ☑ **Rental reimbursement** if repair of your covered product takes longer than promised

Once you purchase the Agreement, a simple phone call is all that it takes for you to schedule service. You can call anytime day or night, or schedule a service appointment online.

Sears has over 12,000 professional repair specialists, who have access to over 4.5 million quality parts and accessories. That's the kind of professionalism you can count on to help prolong the life of your new purchase for years to come. Purchase your Master Protection Agreement today!

**Some limitations and exclusions apply. For prices and additional information call 1-800-827-6655.**

### Sears Installation Service

*For Sears professional installation of home appliances, garage door openers, water heaters, and other major home items, in the U.S.A. call 1-800-4-MY-HOME®*

## In Canada

### Maintenance Agreements

Your purchase has added value because you can depend on Sears HomeCentral® for service. With over 2400 Service Technicians and more than a million parts and accessories, we have the tools, parts, knowledge and skills to ensure our pledge: We Service What We Sell.

Your Kenmore® product is designed, manufactured and tested to provide years of dependable operation. But like all products, it may require service from time to time. The Sears Maintenance Agreement offers you an outstanding service program, affordably priced.

#### The Sears Maintenance Agreement:

- Is your way to buy tomorrow's service at today's price
- Eliminates repair bills resulting from normal wear and tear
- Provides phone support from a Sears technician on products requiring in-home repair
- Even if you don't need repairs, provides an annual Preventive Maintenance Check, at your request, to ensure that your product is in proper running condition.

**Some limitations apply. For more information about Sears Canada Maintenance Agreements, call 1-800-361-6665**

# Range Features

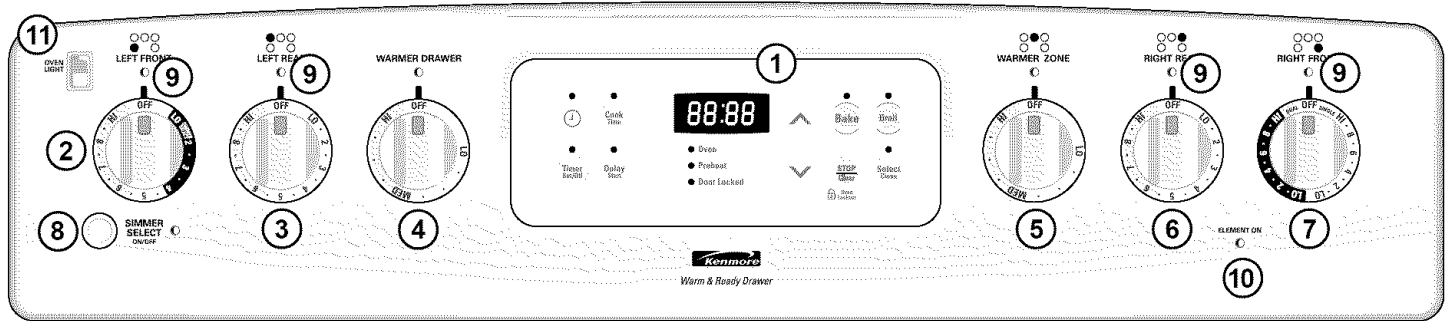

## Your Electric Range Features Include:

1. Electronic Oven Control with Kitchen Timer.
2. Simmer Select Element Control (some models) or Single Radiant Element Control (some models) or Single Radiant Power Boil Control (some models).
3. Single Radiant Element Control.
4. Warm & Ready Drawer Control & Indicator Light (some models).
5. Warm & Ready Zone & Surface Indicator Light (some models).
6. Single Radiant Element Control.
7. Single Radiant Element Control (some models) or Dual Element Radiant Control (some models).
8. Simmer Select Push Button & Indicator Light (some models).
9. HOT SURFACE Indicator Lights.
10. "ELEMENT ON" Indicator Light.
11. Oven Interior Light and Manual Oven Light Switch.
12. Automatic Oven Door Light Switch (some models).
13. Self-Cleaning Oven interior.
14. Self-Clean Door Latch.
15. Adjustable Oven Rack(s).
16. Large 1 piece Oven Door Handle.
17. Full width Oven Door with Window.
18. Warm & Ready Drawer (some models) or Storage Drawer with Drawer Handle.
19. Easy to clean upswept Cooktop.
20. Ceramic Smoothtop.
21. 6" Single Radiant Element(s).
22. 9" Single Radiant Element (some models).
23. 9" Single Radiant "Power Element" (some models).
24. 6-9" Dual Radiant Element (some models).
25. Warm & Ready Zone Radiant Element (some models).
26. Broil Pan.
27. Broil Pan Insert.
28. Leveling Legs and Anti-tip Bracket (included).

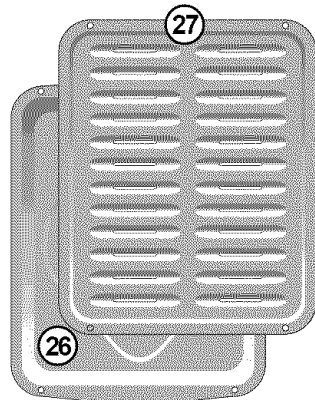
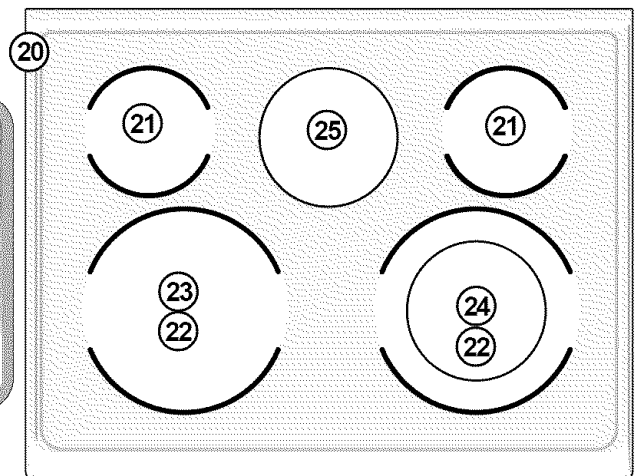
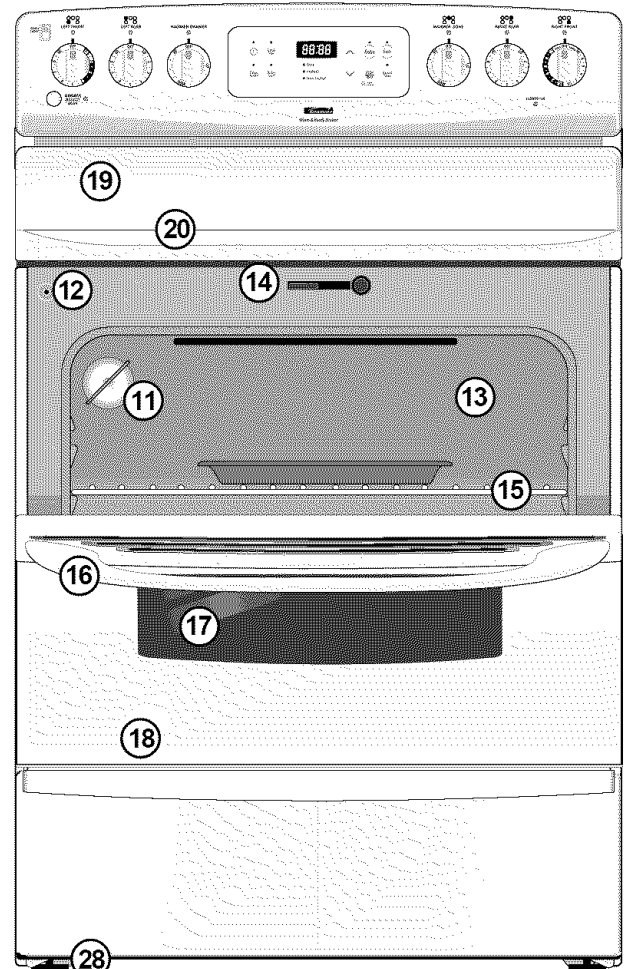

**NOTE:** The features of your range may vary according to model type & color.

# Before Setting Oven Controls

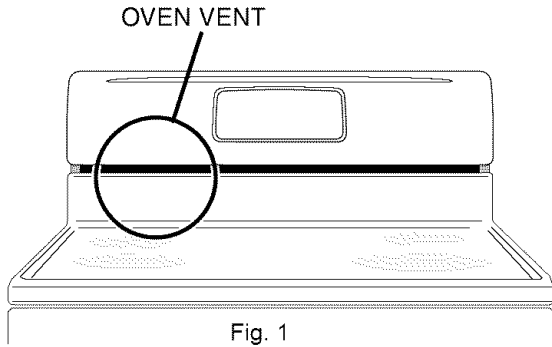

## Oven Vent Location

The oven vent is located **under the left side of the control panel** (See Fig. 1). When the oven is on, warm air passes through the vent. This venting is necessary for proper air circulation in the oven and good baking results. **DO NOT BLOCK OVEN VENT.**

## Removing & Replacing Oven Racks

**To remove**, pull the rack forward until it stops. Lift up front of rack and slide out. **To replace**, fit the rack onto the guides on the oven walls. Tilt the front of the rack upward and slide the rack back into place.

## Arranging Oven Racks

**ALWAYS ARRANGE OVEN RACKS WHEN THE OVEN IS COOL (PRIOR TO OPERATING THE OVEN).** Always use oven mitts when using the oven.

For models with a visible Bake Element (Refer to Fig. 2)

For models with a hidden Bake Element\* (Refer to Fig. 3)

### Recommended Rack Positions for Broiling, Baking & Roasting:

Food	Rack Position	Rack Position*
Broiling hamburgers & steaks	1	1
Broiling meats, chicken or fish	1, 2 or 3	1, 2, or 3
Cookies, cakes, pies, biscuits & Muffins	3 or 4	3 or 4
Frozen pies, angel food cake, yeast, bread, casseroles, small cuts of meat or poultry	5 or 6	6
Turkey, roast or ham	6	7

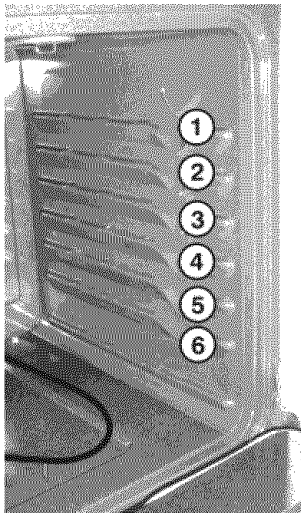

Oven with visible Bake Element - Fig. 2

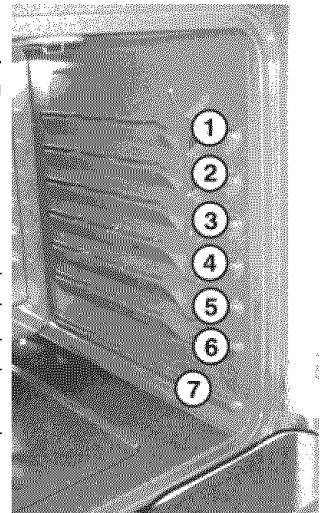

Oven with hidden Bake Element - Fig. 3\*

## Types of Oven Racks

Your range may be equipped with one or more of the oven rack types shown; **Flat Rack**, **Handle Rack** and **Offset Rack**. To maximize cooking space the Offset rack can be used in the lowest rack position to roast large cuts of meat and poultry.

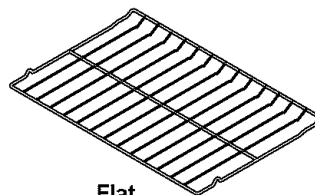

Flat Oven Rack

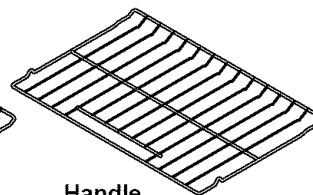

Handle Oven Rack

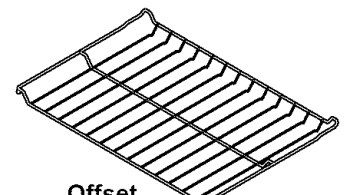

Offset Oven Rack

## Baking Layer Cakes with 1 or 2 Oven Racks

For best results when baking cakes using 2 oven racks, place cookware on rack positions 2 & 5 (for models with a visible bake element). For models with a hidden bake element place oven racks in positions 3 (Flat rack) & 6 with the Offset rack if equipped (Refer to Fig. 4).

For best results when using a single oven rack, place cookware on rack position 4 (for all models - Refer to Fig. 5).

## Air Circulation in the Oven

For best air circulation and baking results allow 2-4" (5-10 cm) around the cookware for proper air circulation and be sure pans and cookware do not touch each other, the oven door, sides or back of the oven cavity. The hot air must be able to circulate around the pans and cookware in the oven for even heat to reach around the food.



Fig. 4

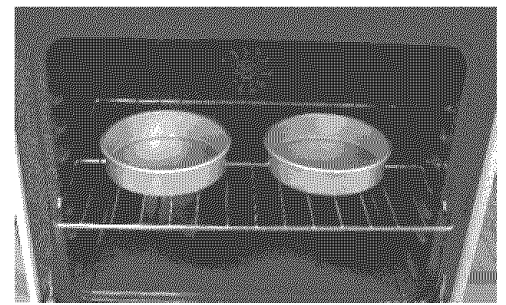

Fig. 5

# Before Setting Oven Controls (cont'd)

## About the Ceramic Glass Cooktop

The ceramic cooktop has radiant surface elements located below the surface of the glass. The design of the ceramic cooktop outlines the area of the surface element underneath. **Be sure** to match the pan size with the diameter of the element outline on the cooktop. Heat is transferred up through the surface of the cooktop to the cookware. Only flat-bottomed cookware should be used.

The type and size of cookware, the number of surface elements in use and their settings, are all factors that will affect the amount of heat that will spread to areas beyond the surface elements. The areas surrounding the elements may become **hot enough to cause burns**.

## About the Radiant Surface Elements

The element temperature rises gradually and evenly. As the temperature rises, the element will glow red. To maintain the selected setting, the element will cycle on and off. The heating element retains enough heat to provide a uniform and consistent heat during the off cycle.

For efficient cooking, turn off the element several minutes before cooking is complete. This will allow residual heat to complete the cooking process.

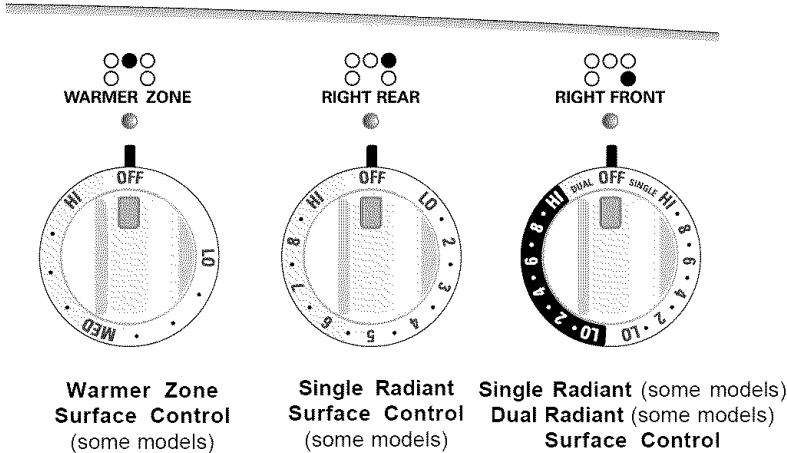

**NOTE:** Please read detailed instructions for ceramic glass cooktop cleaning in the **General Care & Cleaning** and **Before You Call** checklist sections of this Use & Care Guide.

**NOTE:** Radiant elements have a limiter that allows the element to cycle ON and OFF, even at the HI setting. This helps to prevent damage to the ceramic smooth top. Cycling at the HI setting is normal and will occur more often if the cookware is too small for the radiant element or if the cookware bottom is not flat.

## ELEMENT ON and Hot Surface Indicator Lights

Your range is equipped with two different types of radiant surface control indicator lights that will glow on your range—the **ELEMENT ON** indicator light and the **Hot Surface** indicator lights (See illustration at left).

The **ELEMENT ON** located on the control panel and will glow when a surface element is turned ON. A quick glance at this indicator light after cooking is an easy check to be sure ALL surface controls are turned OFF.

The **Hot Surface** indicator lights **located above each surface radiant control knob** will glow as the surface cooking area heats up and will **REMAIN ON** until the glass cooktop has cooled to a **MODERATE** level.

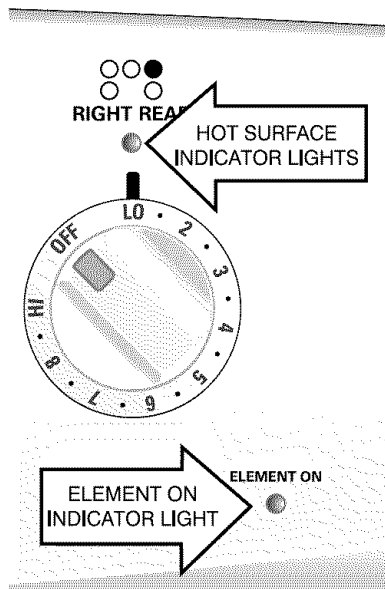



# Setting Surface Controls

## To Operate Single Radiant Surface Elements (all models)

### To Operate a Single Radiant Element:

1. Place correctly sized cookware on the radiant surface element.
2. Push in and turn the surface control knob in either direction to the desired setting (See Fig. 1). Start most cooking operations on a higher setting and then turn to a lower setting to finish cooking. The surface control knobs do not have to be set exactly on a particular mark. Use the marks as a guide and adjust the control knob as needed. Each surface element provides a constant amount of heat at each setting. A glowing red surface heating area extending beyond the bottom edge of the cookware indicates the cookware is **too small** for the surface heating area.
3. When cooking is complete, turn the surface element OFF before removing the cookware. Note: The **ELEMENT ON** indicator light will glow when one or more elements are turned ON. A quick glance at this indicator light when cooking is finished is an easy check to be sure all control knobs are turned OFF. The **Hot Surface** indicator light will continue to glow AFTER the control knob is turned to the "OFF" position and will glow until the heating surface area has cooled sufficiently.

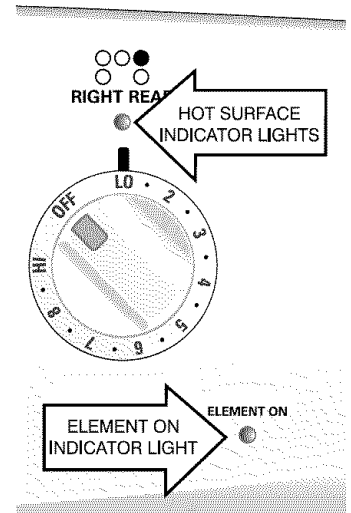

Fig. 1

## To Operate Simmer Select Surface Element (some models)

The left front element control may be used as a normal element or as a simmer element. The "Simmer Select" feature heats the element at a much lower temperature than when used as a normal surface element. You may switch between normal cooking and the Simmer Select feature at any time during the cooking process. When using the element control for normal cooking all of the settings on the control knob (LO to HI) function as normal.

### To Start Simmer Select:

1. Place correctly sized cookware on the radiant surface element.
2. Push in the Simmer button located below the left front control knob. The Simmer Select indicator light will glow and remain ON while simmering (See Fig. 2).
3. Turn the surface control knob to the desired simmer setting within the dark band on the control knob (LO to 4). Use the marks as a guide and adjust the control knob from LO to 4 as needed (see illustration below).
4. To return to normal cooking, push in and release the "Simmer Select" button and the indicator light will turn OFF. When cooking is complete, be sure to set the control knob to the OFF position.

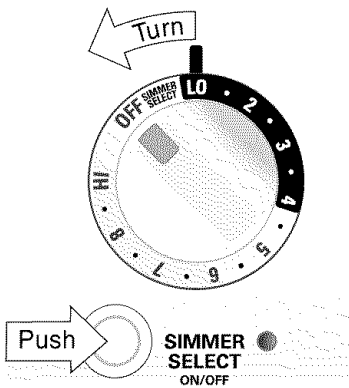

Simmer Select Surface Control shown in LO setting

Fig. 2

The suggested settings found in the table below are based on cooking in medium-weight aluminum pans with lids. Settings may vary when using other types of pans.

STANDARD SETTING FOR SURFACE ELEMENTS	
Setting	Type of Cooking
HIGH (HI - 9)	Start most foods, bring water to a boil, pan broiling
MEDIUM HIGH (7 - 8)	Continue a rapid boil, fry, deep fat fry
MEDIUM (5 - 6)	Maintain a slow boil, thicken sauces and gravies, steam vegetables
MEDIUM LOW (2 - 4)	Keep foods cooking, poach, stew
LOW (LO - 1)	Keep warm, melt, simmer
SIMMER SELECT SURFACE ELEMENT	
Max. Simmer (4)	Larger quantities of food, stews and soups
Min. Simmer (LO)	Smaller quantities of food, delicate foods, melting chocolate or butter

**CAUTION** Radiant surface elements may appear to have cooled after they have been turned off. **The glass surface may still be hot** and burns may occur if the glass surface is touched before it has cooled sufficiently.

**CAUTION** Do not place plastic items such as salt and pepper shakers, spoon holders or plastic wrappings on top of the range when it is in use. These items could melt or ignite. Potholders, towels or wooden spoons could catch fire if placed too close to the surface elements.

# Setting Surface Controls (cont'd)

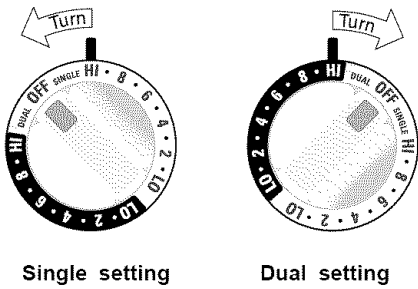

## To Operate Dual Radiant Surface Element (some models)

The right front control knob offers flexibility for different sized cookware with the Dual Radiant surface element. The inner element alone can be used for smaller or both the inner and outer in combination for larger cookware.

To operate the Dual Radiant surface element push in the control knob and turn counterclockwise to operate the small inner coil or turn clockwise to operate both the inner and outer portions of the element together (See Fig 1).

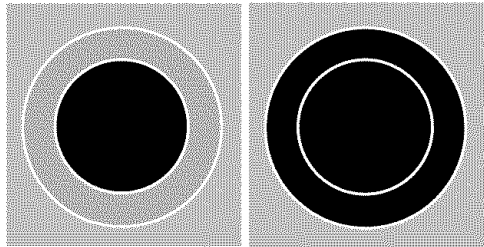

Dual Radiant heating areas on ceramic smooth top (shown in black)

Fig. 1

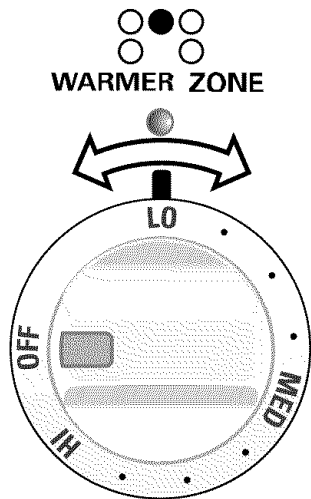

Fig. 2

### SINGLE AND DUAL RADIANT SURFACE ELEMENTS

Setting	Type of Cooking
HIGH (HI - 9)	Start most foods, bring water to a boil, pan broiling
MEDIUMHIGH (7 - 8)	Continue a rapid boil, fry, deep fat fry
MEDIUM (5 - 6)	Maintain a slow boil, thicken sauces and gravies or steam vegetables
MEDIUM LOW (2 - 4)	Keep foods cooking, poach, stew
LOW (LO - 1)	Keep warm, melt, simmer

**Note:** The size and type of utensil used, and the amount and type of food being cooked will influence the setting needed for best cooking results.

## Setting the Warmer (Warm & Ready™) Zone (some models)

The purpose of the Warmer Zone is to *keep hot cooked foods at serving temperature*. Always start with hot food. It is not recommended to heat cold food on the Warmer Zone.

All food placed on the Warmer Zone should be covered with a lid or aluminum foil to maintain quality. For best results, when warming pastries or breads, the cover should have an opening to allow moisture to escape. **Do not use plastic wrap to cover food. Plastic may melt onto the surface and be very difficult to clean.**

Use only dishware, utensils and cookware recommended for oven and cooktop use on the Warmer Zone.

**CAUTION** Unlike the surface elements, the Warmer Zone will not glow red when it is hot.

**CAUTION** Always use potholders or oven mitts when removing food from the warm zone as cookware and plates will be hot.

### Warmer Zone Recommended Food Settings Table

Food Item	Heating Level
Breads/Pastries	LO
Casseroles	LO
Dinner Plates with Food	LO
Eggs	LO
Gravies	LO
Meats	MED
Sauces	MED
Soups (cream)	MED
Stews	MED
Vegetables	MED
Fried Foods	HI
Hot Beverages	HI
Soups (liquid)	HI

## Setting the Warmer (Warm & Ready™) Zone Control

- To set the control turn the knob in either direction (See Fig 2). The temperatures are approximate, and are designated by HI, MED and LO. However, the control can be set at any position between HI and LO for different levels of heating.
- When ready to serve, turn the control to OFF. The Warmer Zone will remain warm until the **indicator light** goes OFF.

**Temperature Selection** - Refer to the chart at the side column for recommended heating levels. If a particular food is not listed, start with the medium level, and adjust as needed. Most foods can be kept at serving temperatures by using the medium level.

**Note:** Use the Warmer Zone to keep cooked foods hot such as; vegetables, gravies, casseroles, soups, stews, breads, pastries and oven-safe dinner plates.

# Surface Cooking

## Using Power Element (some models)

The "Power Element" feature uses a higher wattage surface radiant element which can bring food items to boil much quicker. The left front radiant element will be clearly marked if this feature is available on your range (See Fig. 1). If equipped with the "Power Element" feature, place the cookware to boil on the left front surface element and follow the instructions "To Operate a Single Radiant Element" in the **Settings Surface Controls** section.

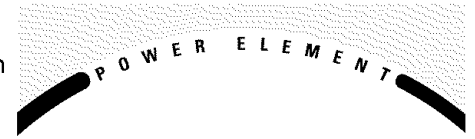

Fig. 1

## Using proper cookware

The size and type of cookware used will influence the setting needed for best cooking results. Cookware should have flat bottoms that make good contact with the entire surface heating element (See Fig. 2). Check for flatness by rotating a ruler across the bottom of the cookware (See Fig. 3).

## Cookware Material Types

The cookware material determines how evenly and quickly heat is transferred from the surface element to the pan bottom. The most popular materials available are:

**ALUMINUM** - Excellent heat conductor. Some types of food will cause it to darken (Anodized aluminum cookware resists staining & pitting). If aluminum pans slide across the ceramic cooktop, they may leave metal marks which will resemble scratches. Remove these marks immediately.

**COPPER** - Excellent heat conductor but discolors easily. May leave metal marks on ceramic glass (see Aluminum above).

**STAINLESS STEEL** - Slow heat conductor with uneven cooking results. Is durable, easy to clean and resists staining.

**CAST IRON** - A poor heat conductor however will retain heat very well. Cooks evenly once cooking temperature is reached. Not recommended for use on ceramic cooktops.

**PORCELAIN-ENAMEL on METAL** - Heating characteristics will vary depending on base material. Porcelain-enamel coating must be smooth to avoid scratching ceramic cooktops.

**GLASS** - Slow heat conductor. Not recommended for ceramic cooktop surfaces because it may scratch the glass.

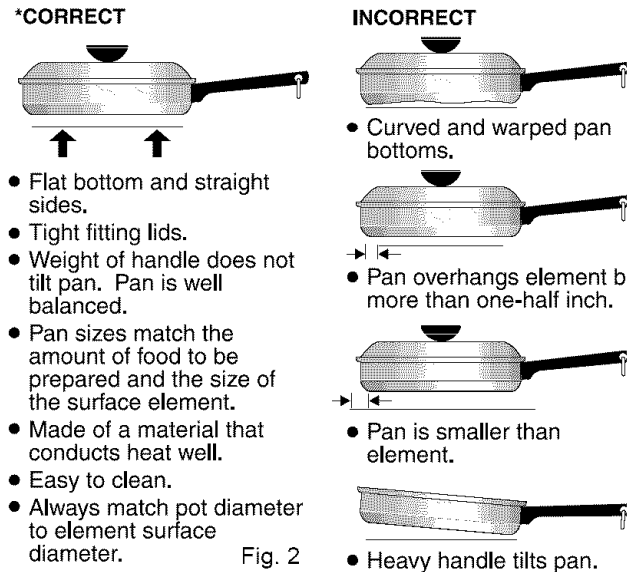

Be sure to follow the recommendations for using proper cookware as illustrated in Figs. 2 & 3. For more information about the ceramic cooktop see "Cooktop Cleaning & Maintenance" in the **General Care & Cleaning** section.

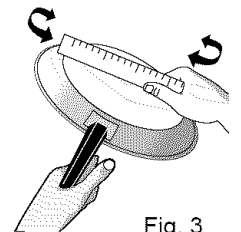
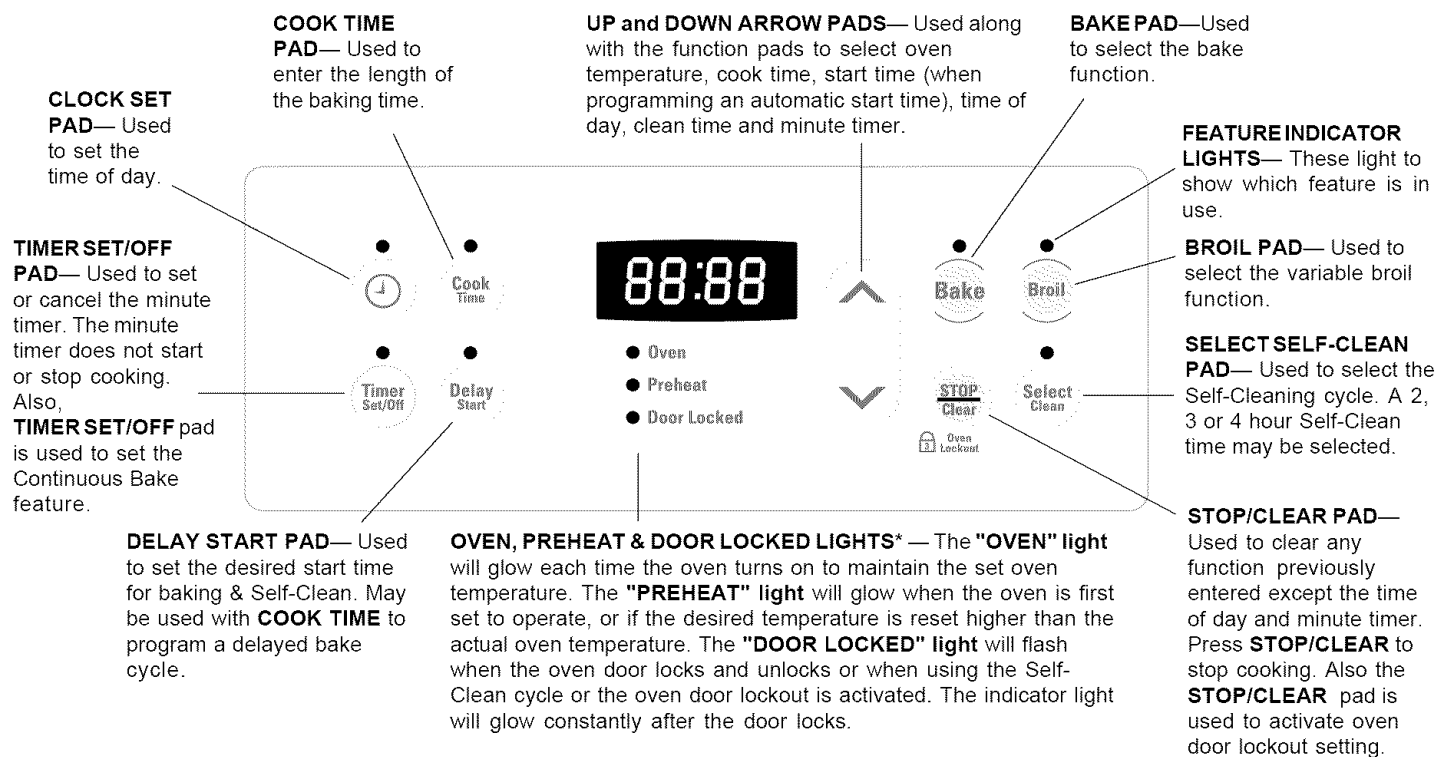

Fig. 3



# Oven Control Functions

**READ THE INSTRUCTIONS CAREFULLY BEFORE USING THE OVEN.** For satisfactory use of your oven, become familiar with the various pad functions of the oven as described below.



\*Note: The **OVEN** indicator light on the electronic display will turn ON and OFF when using the Bake feature and during preheat. This is normal and indicates that the oven is cycling to maintain the selected baking temperature. When the preheat indicator light turns OFF, your oven is ready.

## For a silent control panel





When choosing a function, a beep will be heard each time a pad is pressed. If desired, the control can be programmed for silent operation. Press and hold . After 7 seconds, the control will beep once. This will block the controls from sounding when a pad is pressed. To return the sound, press and hold  again for 7 seconds until the control beeps once.

**Note:** The control will return to the audible mode after a power outage.

## Temperature conversion

The electronic oven control is set to operate in °F (Fahrenheit) when shipped from the factory. The oven can be programmed for any temperature from 170°F to 550°F (77°C to 287°C).

**To change the temperature to °C (Celsius) or from °C to °F (control should not be in a Bake or Clean mode):**

1. Press . "— —" appears in the display.
2. Press and hold the  until "HI" appears in the display.
3. Press and hold  until °F or °C appears in the display.
4. Press the  or  to change °F to °C or °C to °F.
5. Press any control pad to return to normal operating mode.

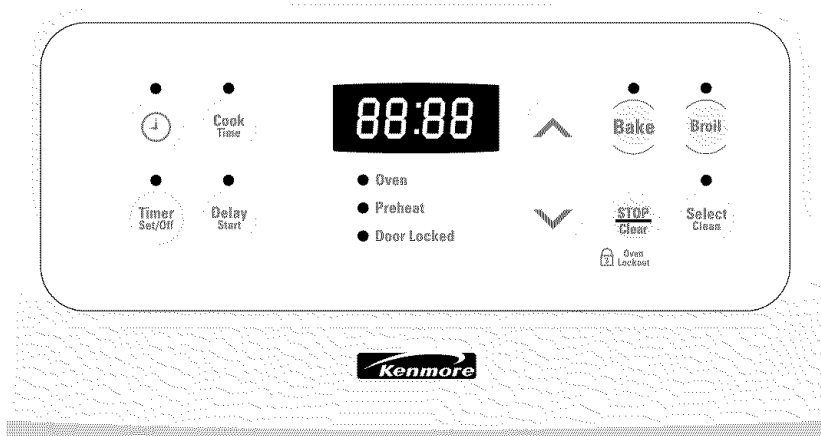

# Setting Oven Controls



**Note:** The time of day **must** first be set in order to operate the oven.





## To Set the Clock

When the range is first plugged in, or when the power supply to the range has been interrupted, the display will flash "12:00".

1. Press  once (do not hold pad down).
2. Within 5 seconds, press and hold the  or  until the correct time of day appears in the display.

**Note:** The clock cannot be changed during any timed bake or Self-Clean cycle.



## To Set the Minute Timer:

1. Press .
2. Press the  to increase the time in one minute increments. Press and hold the  to increase the time in 10 minute increments. The timer can be set for any amount of time from 1 minute to 11 hours and 59 minutes.  
**Note:** If the  pad is pressed first, the timer will advance to 11 hours and 59 minutes.
3. The display shows the timer countdown in minutes until 1 minute remains. Then the display will countdown in seconds.
4. When the set time has run out, the timer will beep 3 times. It will then continue to beep 3 times every 60 seconds until  is pressed.



**Note:** The indicator light located above the  pad will glow while the minute timer is active.

**Note:** The minute timer does not start or stop cooking. It serves as an extra timer in the kitchen that will beep when the set time has run out. The minute timer can be used alone or during any of the other oven functions. When the minute timer is in use with any other function, the minute timer will be shown in the display. To view other functions, press the pad for that function.

## To Change the Minute Timer while it is in use:

While the timer is active and shows in the display, press and hold the  or  to increase or decrease the time.

**To Cancel the Minute Timer before the set time has run out:** Press .









**Note:** To turn the **time of day** display **OFF** or **ON** in the display press  and hold for 15 seconds (the control will beep once) and then release. This feature does not remove the set time of day from the memory of the control. When the display is turned **OFF** the time of day will re-appear for a few seconds any time the  pad is touched.

## Setting Oven Controls (cont'd)



### To Set or Change the Temperature for Baking

The oven can be programmed to bake at any temperature from 170°F to 550°F (77°C to 287°C).

#### To Set the Controls for Baking:

1. Press . "— — —" appears in the display.
2. Within 5 seconds, press the  or . The display will show "350°F (177°C)." By pressing and holding the  or , the temperature can then be adjusted in 5°F increments (1°C if the control is set to display Celsius).
3. As soon as the  or  pad is released, the oven will begin heating to the selected temperature. When the displayed temperature reaches the desired baking temperature, the preheat indicator light will turn OFF and the control will beep 3 times.
4. To cancel baking, press .



#### To Change the Oven Temperature after Baking has Started:

1. Press  and make sure the bake temperature is displayed.
2. Press the  or  pad to increase or decrease the set temperature.

### To Set Control for Continuous Bake or 12 Hour Energy Saving

The oven control has a built-in 12 Hour Energy Saving feature that will shut off the oven if the control is left on for more than 11 hours and 59 minutes. The oven can be programmed to override this feature for continuous baking.



#### To set control for continuous baking:

1. Press and hold  down for 5 seconds until tone is heard, "— — hr" will appear in display for continuous cooking. The current time of day will return to the display.
2. To cancel the Continuous Bake function, press  and hold for 5 seconds until tone is heard. "12hr" will appear in display indicating that the control has returned to the 12 Hour Energy Saving feature.

### To Set Control for Oven Lockout

The control can be programmed to lock the oven door and lockout the oven control pads.



#### To set Control for Oven Lockout feature:

1. Press  and hold for 3 seconds. "Loc" will appear in display, the "Door Locked" indicator light will flash and the motor driven door lock will begin to close automatically. **DO NOT open oven door** while the indicator light is flashing. Allow about 15 seconds for the oven door to lock. Once the oven door is locked, the current time of day will appear in the display.
2. To cancel the Oven Lockout feature, press  and hold for 3 seconds. The control will unlock the oven door and resume normal operation.

**Note: If any control pad is pressed while in the Oven Lockout mode, "Loc" will appear in the display until the control pad is released.**









# Setting Oven Controls (cont'd)

## To Set the Timed Bake and Delay Start Features











The  **COOK TIME** and  **DELAY START** pads operate the features that will turn the oven ON and OFF at the times you select in advance. The oven can be programmed to start immediately and shut off automatically (Timed Bake) or to begin baking at a later time with a delayed start time (Delay Start).

**Note:** During Timed Bake the preheat indicator light will not function.

### To Program the Oven to Begin Baking Immediately and To Shut Off Automatically (Timed Bake):

1. Be sure that the clock shows the correct time of day.
2. Place the food in the oven.
3. Press . " — — — ° " appears in the display.
4. Within 5 seconds, press the  or . The display will show "350°F (177°C)." By holding the  or , the temperature can then be adjusted in 5°F increments (1°C if the control is set to display Celsius).
5. Press . "0:00" will flash in the display (HR:MIN).
6. Press the  or  until the desired baking time appears in the display.
7. The oven will turn ON and begin heating.



### To Program Oven for a Delayed Start Time and to Shut-Off Automatically (Delayed Start Bake):

1. Be sure that the clock shows the correct time of day.
2. Place the food in the oven.
3. Press . " — — — ° " appears in the display.
4. Within 5 seconds, press the  or . The display will show "350°F (177°C)." By holding the  or , the temperature can then be adjusted in 5°F increments (1°C if the control is set to display Celsius).
5. Press . "0:00" will flash in the display (HR:MIN).
6. Press the  or  until the desired baking time appears.
7. Press . The earliest possible start time will appear in the display.
8. Press the  or  until the desired start time appears in the display.
9. Once the controls are set, the control calculates the time when baking will stop in order to start at the time you have set.
10. The oven will turn ON at the delayed start time and begin heating.

### When the Set Bake Time Runs Out:

- a. "END" will appear in the display window and the oven will shut-off automatically.
- b. The control will beep 3 times every 60 seconds until  is pressed.







### To Change the Oven Temperature or Bake Time after Baking has Started:

1. Press the function pad you want to change.
2. Press the  or  to adjust the setting.

**CAUTION** Use caution with the Timed Bake and Delayed Start features. Foods that can easily spoil such as milk, eggs, fish, meat or poultry, should be chilled in the refrigerator first. Even when chilled, they should not stand in the oven for more than 1 hour before cooking begins, and should be removed promptly when cooking is completed.

# Setting Oven Controls (cont'd)

## To Set for Broiling:

1. Arrange the oven rack while oven is still cool. Position the rack as suggested in the **Broil Rack Position Table** below.
2. Press . "Broil" will appear in display.
3. Press and hold the  or  until the desired broil setting level appears in the display. Press the  for **HI** broil or the  for **LO** broil. Most foods may be broiled at the **HI** broil setting. Select the **LO** broil setting to avoid excess browning or drying of foods that should be cooked to the well-done stage.
4. **For optimum browning, preheat broil element for 3 - 4 minutes before adding food.**
5. Place the insert on the broil pan, then place the food on the insert (See Fig. 1). **DO NOT** use the broil pan without the insert or cover the insert with **aluminum foil**. The exposed fat could ignite.
6. Place the pan on the oven rack. **Open the oven door to the broil stop position** (See Fig 2).
7. Broil on one side until food is browned. Turn and broil food on 2nd side. **Note:** Always pull the oven rack out to the stop position before turning or removing the food.
8. When broiling is finished, press .

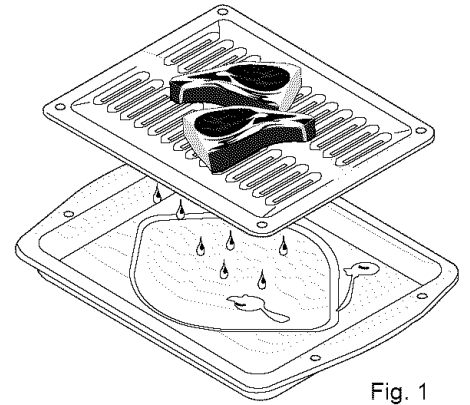

Fig. 1

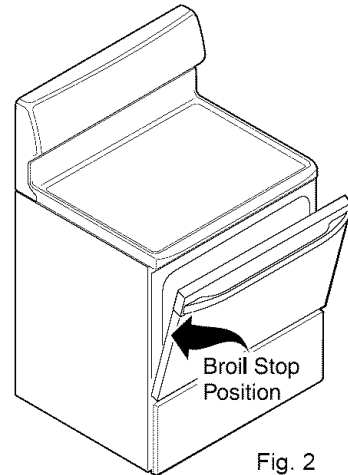

Fig. 2

### Broil Rack Position Table (Refer to Fig. 3)

Rack Position from Top	Food category
1st rack position	Medium-rare steaks & hamburgers
2nd rack position	Fish, medium steaks & pork chops
3rd rack position	Well-done foods such as chicken & lobster

Note: The broiler pan and the insert allows grease to drain and be kept away from the high heat of the broiler. **DO NOT** use the pan without the insert. **DO NOT** cover the insert with foil; the exposed grease could ignite.

**CAUTION** Should an oven fire occur, close the oven door and turn the oven OFF. If the fire continues, use a fire extinguisher. **DO NOT** put water or flour on the fire. Flour may be explosive.

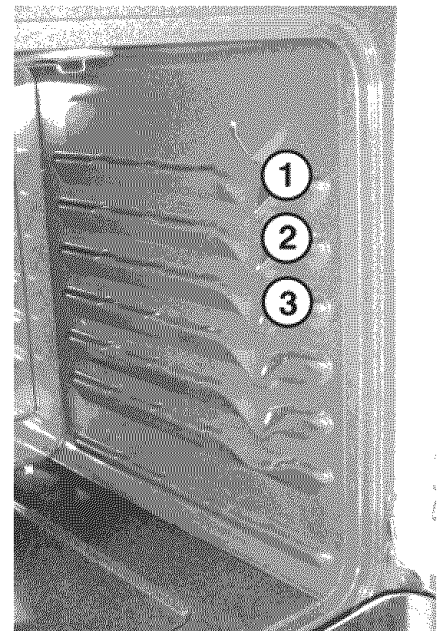

Fig. 3



# Setting Oven Controls (cont'd)

## To Operate the Oven Light

The interior oven light will automatically turn ON when the oven door is opened. Press the Oven Light Switch located on the upper left control panel to turn the interior oven light ON and OFF whenever the oven door is closed.

The interior oven light is located at the upper left rear wall of the oven interior and is covered with a glass shield held by a wire holder. The glass shield must be in place whenever the oven is in use. To change the interior oven light, see "Changing the Oven Light" in the **General Care & Cleaning** section.

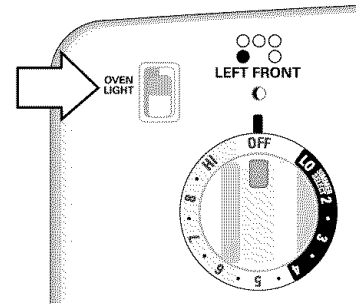

## Setting Warmer Drawer Controls

### Arranging Warmer Drawer (Warm & Ready™ Drawer) Rack Positions (some models)

Note: Use the warmer drawer to keep hot foods hot such as: vegetables, gravies, meats, casseroles, biscuits and rolls, pastries and heated dinner plates.

The rack can be used in 2 ways:

- In the **upright position** to allow low profile food items to be placed both under and on top of the rack (for example, rolls or biscuits on top of the rack and a casserole dish under - See Fig. 1).
- In the **downward position** to allow you to place light weight food items and empty dishware (for example, rolls or pastries and dinner plates - See Fig. 2).

The warmer drawer is equipped with a catch which may require extra force when opening and closing the drawer.

## To Operate the Warmer (Warm & Ready™) Drawer

Always start with hot food. It is not recommended to heat cold food in the warmer drawer.

All food placed in the warmer drawer should be covered with a lid or aluminum foil to maintain quality. **Do not use plastic wrap to cover food. Plastic may melt onto the drawer and be very difficult to clean.**

Use only dishes, utensils and cookware recommended for oven use in the warmer drawer.

**CAUTION** Always use pot holders or oven mitts when removing food from the warmer drawer as cookware and plates will be HOT.

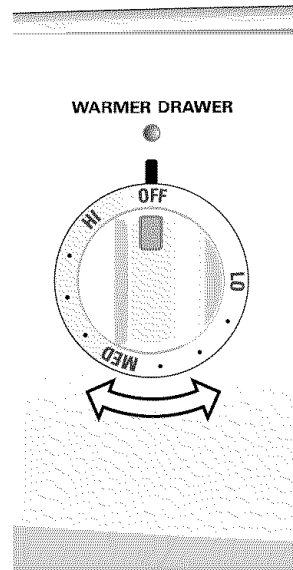
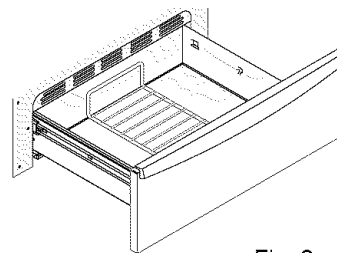
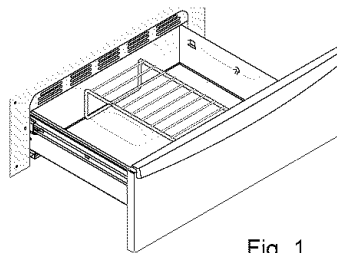

# Setting Warmer Drawer Controls (cont'd)

Warmer Drawer Recommended Food Settings Table	
Food Item	Setting
Bacon	HI
Hamburger Patties	HI
Poultry	HI
Pork Chops	HI
Fried Foods	HI
Pizza	HI
Gravies	MED
Casseroles	MED
Eggs	MED
Roasts (Beef, Pork, Lamb)	MED
Vegetables	MED
Biscuits	MED
Rolls, hard	MED
Pastries	MED
Rolls (soft)	LO
Empty Dinner Plates	LO

## To Set the Warmer (Warm & Ready™) Drawer Thermostat Control (some models)

The thermostat control is used to select the temperature of the warmer drawer. It is located on the control panel (See Fig. 3 on previous page). To set the thermostat, push in and turn the knob to the desired setting. The temperatures are approximate, and are designated by HI, MED and LO.

1. Turn the knob to select the desired temperature setting.
2. For best results, preheat the drawer before adding food. An empty drawer will preheat in approximately 15 minutes.
3. Turn the thermostat control to **OFF** after use.

## Warmer (Warm & Ready™) Drawer Temperature Selection (some models)

Refer to the table in the side column for recommended settings. If a particular food is not listed, start with the medium setting. If more crispness is desired, remove the lid or aluminum foil.

Most foods can be kept at serving temperatures by using the medium setting.

When a combination of foods are to be kept warm (for instance, a meat with 2 vegetables and rolls), use the high setting.

Refrain from opening the warmer drawer while in use to eliminate loss of heat from the drawer.

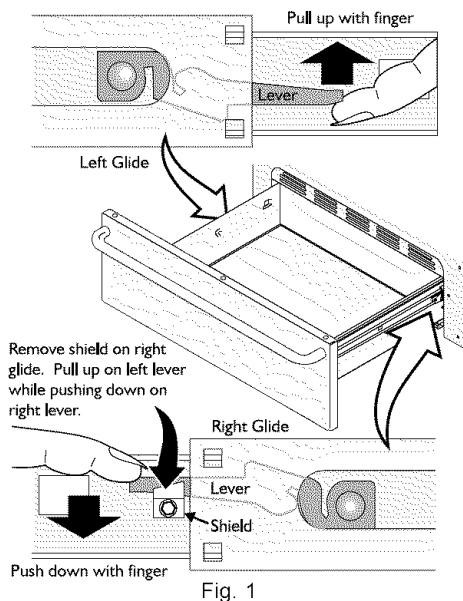

Fig. 1

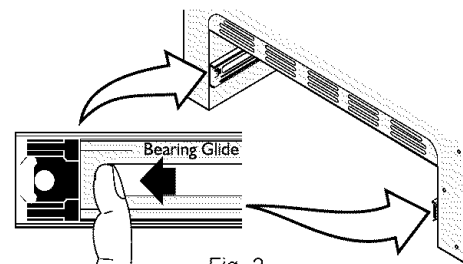

Fig. 2

**NOTE:** The warmer drawer will **NOT** operate while in the Self-Clean and "Oven Lockout" modes

## Warmer (Warm & Ready™) Drawer Indicator Light (some models)

The indicator light is located above the Warmer Drawer thermostat control. It turns on when the control is set, and stays on until the control is turned OFF. The warmer drawer is inoperable during the Self-Clean cycle. The indicator light will not come on during the Self-Clean cycle.

## To Remove and Replace Warmer (Warm & Ready™) Drawer (some models)

### To Remove Warmer Drawer:

1. **CAUTION** Turn power OFF before removing the warmer drawer.
2. Open the drawer to the fully opened position.
3. On the right glide you will find a shield attached with a hex-head screw (see figure 1). Using a 1/4" socket and ratchet remove the shield.
4. Locate glide lever on each side of drawer, pull up on the left glide lever and push down on the right glide lever.
5. Pull the drawer away from the range.

### To Replace Warmer Drawer:

1. Replace shield on the right glide of the drawer body.
2. **Pull the bearing glides to the front** of the chassis glide (see figure 2).
3. Align the glide on each side of the drawer with the glide slots on the range.
4. Push the drawer into the range until levers "click" (approximately 2"). Pull the drawer open again to seat bearing glides into position. **If you do not hear the levers "click" or the bearing glides do not feel seated remove the drawer and repeat steps 2-4.** This will minimize possible damage to the bearing glides.



**WARNING** Electrical Shock Hazard can occur and result in serious injury or death. Disconnect appliance from electric power before cleaning and servicing the warmer drawer.

# Self-Cleaning

**CAUTION** During the Self-Cleaning cycle, the outside of the range can become very hot to the touch. **DO NOT** leave small children unattended near the appliance.

**CAUTION** The health of some birds is extremely sensitive to the fumes given off during the Self-Cleaning cycle of any range. Move birds to another well-ventilated room.

**CAUTION DO NOT** line the oven walls, racks, bottom or any other part of the range with **aluminum foil**. Doing so will destroy heat distribution, produce poor baking results and cause permanent damage to the oven interior (aluminum foil will melt to the interior surface of the oven).

**CAUTION DO NOT** force the oven door open. This can damage the automatic door locking system. Use caution when opening the door after the Self-Cleaning cycle is completed. The oven may still be **VERY HOT**.

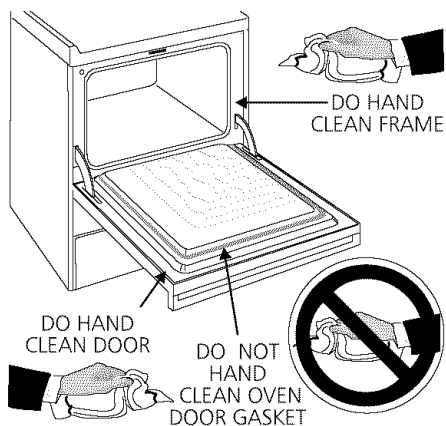

Note: See additional cleaning information for the oven door in the **General Care & Cleaning** section.

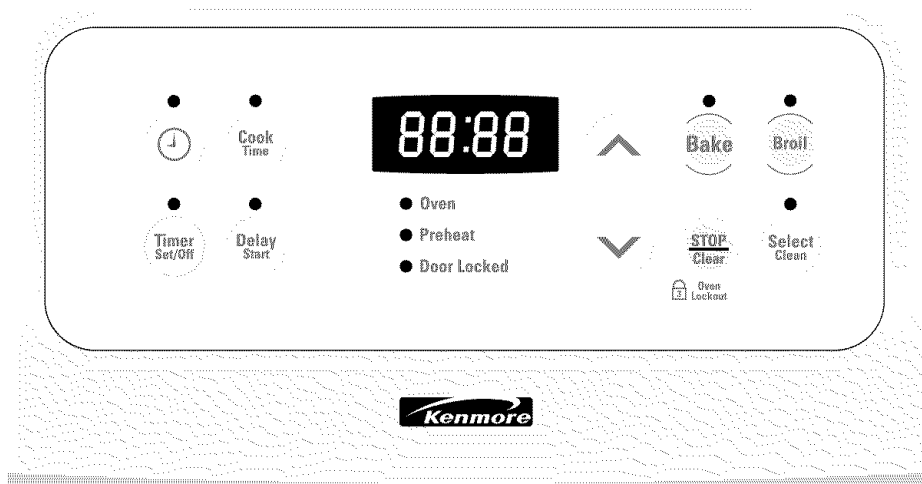
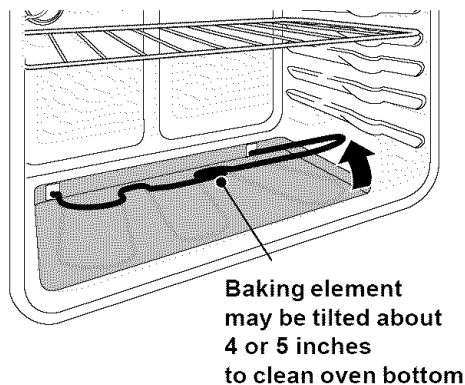

## Self-Cleaning Oven

A Self-Cleaning oven cleans itself with high temperatures (well above cooking temperatures) which eliminate soils completely or reduces them to a fine powdered ash you can wipe away with a damp cloth.

### Adhere to the following cleaning precautions:

- **DO NOT** use oven cleaners or oven protective coatings in or around any part of the Self-Cleaning oven.
- **DO NOT** clean the oven door gasket. The woven material of the oven door gasket is essential for a good seal. Care should be taken not to rub, damage or remove the gasket.
- **DO NOT** use any cleaning materials on the oven door gasket. Doing so could cause damage.
- **Remove the broiler pan and insert, all utensils and any aluminum foil. These items cannot withstand high cleaning temperatures.**
- Oven racks do not have to be removed. If they are not removed during the Self-Clean cycle their color will turn slightly blue and the finish will be dull. After the cycle is complete and the oven has cooled, rub the sides of the oven racks with wax paper or a cloth containing a small amount of salad oil (this will make the racks glide easier into the rack position).
- **Remove any excessive spillovers** in the oven cavity **before** starting the Self-Cleaning cycle. To clean, use hot, soapy water and a cloth. Large spillovers can cause heavy smoke or fire when subjected to high temperatures. **DO NOT** allow food spills with a high sugar or acid content (such as milk, tomatoes, sauerkraut, fruit juices or pie filling) to remain on the surface as they may leave a dull spot even after cleaning.
- Clean any soil from the oven frame, the door liner outside the oven door gasket and the small area at the front center of the oven bottom. These areas heat sufficiently to burn soil on. Clean with soap and water.

NOTE: Prior to setting the Self-Clean cycle, any spills remaining on the oven bottom should be removed.

Some models have an exposed Bake element in the lower oven cavity. On these models the bake element is designed to be tilted up using your hand from the front of the bake element (See illustration at left). This will allow easier access to the oven bottom for cleaning. Be careful not to raise the element more than 4 or 5 inches from the resting position.

**CAUTION** The oven bake and broil elements may appear to have cooled after they have been turned OFF. **The elements may still be hot** and burns may occur if these elements are touched before they have cooled sufficiently.







# Self-Cleaning (cont'd)

## Starting the Select Self-Clean Cycle or a Delayed Start Self-Clean Cycle

For satisfactory results, use a 2 hour Self-Clean cycle for **light soils** and a 3 hour cycle for **average** or a 4 hour cycle for **heavy soils**. **NOTE:** The kitchen area should be well ventilated using an open window, ventilation fan or exhaust hood during the 1st Self-Clean cycle. This will help eliminate the normal odors associated with the 1st Self-Clean cycle.

## To Set the Controls for a Self-Clean Cycle or a Delayed Start Self-Clean Cycle:

(**Note:** If you do not want to start a **Delayed** Self-Clean Cycle, skips steps 2 & 3.)

1. Be sure the clock shows the correct time of day.
2. Press . The ":" in the time of day will flash.
3. Press and hold the  pad to scroll to the time to start the delayed Self-Clean cycle. Release the pad when the desired time is displayed.
4. Press . "— — —" appears in the display.
5. Press the  or  once. "3:00" appears in the display for a 3 hour cycle. To change to a 2 hour cycle press .

"2:00" appears in the display or to select a 4 hour cycle press . "4:00" appears in the display.

As soon as the controls are set, the motor driven lock will begin to close automatically and the "LOCK" indicator light will flash. **DO NOT** open the oven door while the light is flashing (it takes about 15 seconds for the oven door to lock).

6. "CLn" will appear in the display during the Self-Clean cycle and the "LOCK" light will glow until the Self-Cleaning cycle is complete or cancelled and the oven temperature has cooled.

## When the Self-Clean Cycle is Completed:

1. The time of day or "End" will appear in the display window and the "Clean" and "LOCK" light will continue to glow.
2. Once the oven has cooled down for about 1 HOUR and the "LOCK" light has gone out, the oven door can be opened.
3. If "End" is in the display and the Select Clean indicator light remains ON, press . The time of day will appear in the display.

**NOTE:** When the oven is cool, wipe away any residue or powdered ash with a damp cloth or paper towel.

## Stopping or Interrupting a Select Self-Cleaning Cycle

If it becomes necessary to stop or interrupt a Self-Cleaning cycle:

1. Press .
2. Once the oven has cooled down for about 1 HOUR and the "LOCK" light has gone out, the oven door can be opened.
3. Restart the Self-Clean cycle once all conditions have been corrected.

**CAUTION** To avoid possible burns use care when opening the oven door after the Self-Cleaning cycle. Stand to the side of the oven when opening the door to allow hot air or steam to escape.

**CAUTION** **DO NOT** force the oven door open. This can damage the automatic door locking system. Use caution and avoid possible burns when opening the door after the Self-Cleaning cycle has completed. The oven may still be VERY HOT.

# General Care & Cleaning

Cleaning Table

Surfaces	How to Clean
Aluminum (Trim Pieces) & Vinyl	Use hot, soapy water and a cloth. Dry with a clean cloth.
Painted and Plastic Control Knobs, Body Parts, and Decorative Trim	<p>For general cleaning, use hot, soapy water and a cloth. For more difficult soils and built-up grease, apply a liquid detergent directly onto the soil. Leave on soil for 30 to 60 minutes. Rinse with a damp cloth and dry. <b>DO NOT</b> use abrasive cleaners on any of these materials; they can scratch. To remove control knobs, turn to the OFF position; grasp firmly and pull straight off the shaft. To replace knobs after cleaning, line up the flat sides of both the knob and the shaft; then push the knob into place.</p>
Stainless Steel, Chrome Control Panel, Decorative Trim	<p>Before cleaning the control panel, turn all controls to OFF and remove the control knobs. To remove, pull each knob straight off the shaft. Clean using hot, soapy water and a dishcloth. Rinse with a clean water using a dishcloth. Be sure to squeeze excess water from the cloth before wiping the panel; especially when wiping around the controls. Excess water in or around the controls may cause damage to the appliance. To replace knobs after cleaning, line up the flat sides of both the knob and the shaft; then push the knob into place.</p> <p>Clean <b>stainless steel</b> with hot, soapy water and a dishcloth. Rinse with clean water and a cloth. <b>Do not use cleaners with high concentrations of chlorides or chlorines.</b> Do not use harsh scrubbing cleaners. Only use kitchen cleaners that are especially made for cleaning stainless steel. Always be sure to rinse the cleaners from the surface as bluish stains may occur during heating that cannot be removed.</p>
Porcelain Enamel Broiler Pan and Insert, Door Liner, Body Parts, Warmer Drawer (some models)	Gentle scouring with a soapy scouring pad will remove most spots. Rinse with a 1:1 solution of clear water and ammonia. <i>If necessary</i> , cover difficult spots with an ammonia-soaked paper towel for 30 to 40 minutes. Rinse with clean water and a damp cloth, and then scrub with a soap-filled scouring pad. Rinse and wipe dry with a clean cloth. Remove all cleaners or the porcelain may become damaged during future heating. <b>DO NOT</b> use spray oven cleaners on the cooktop.
Oven Racks	<p>Oven racks may be removed or left in the oven during the Self-Clean cycle for cleaning. If removed, clean by using a mild, abrasive cleaner following manufacturer's instructions. Rinse with clean water and dry.</p> <p>If the racks are cleaned in the Self-Clean cycle, their color will turn slightly blue and the finish will be dull. After the Self-Clean cycle is complete, and the oven has cooled, rub the sides of the racks with wax paper or a cloth containing a small amount salad oil (this will make the racks glide easier into the rack positions).</p>
Oven door	<p>Use soap &amp; water to thoroughly clean the top, sides and front of the oven door. Rinse well. You may use a glass cleaner on the outside glass of the oven door. <b>DO NOT</b> immerse the door in water. <b>DO NOT spray or allow water or the glass cleaner to enter the door vents.</b> <b>DO NOT</b> use oven cleaners, cleaning powders or any harsh abrasive cleaning materials on the outside of the oven door.</p> <p><b>DO NOT</b> clean the oven door gasket. The oven door gasket is made of a woven material, on Self-Cleaning models, which is essential for a good seal. Care should be taken not to rub, damage or remove this gasket.</p>
Ceramic Cooktop	See Cooktop Cleaning and Maintenance in the <b>General Care &amp; Cleaning</b> section.

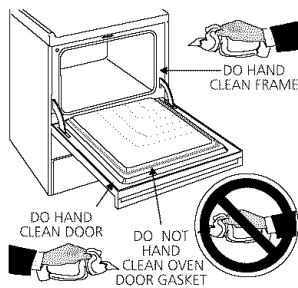
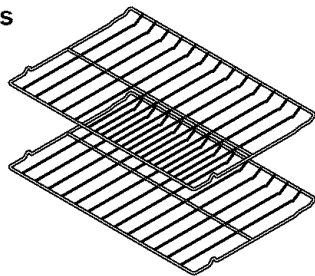

# General Care & Cleaning (cont'd)

## Cooktop Cleaning and Maintenance

**Consistent and proper cleaning is essential to maintaining your ceramic glass cooktop.**

Prior to using your cooktop for the first time, apply the recommended cooktop cleaning creme (visit [www.sears.com](http://www.sears.com) for replacement cleaner) to the ceramic surface. Buff with a non-abrasive cloth or pad. This will make cleaning easier when soiled from cooking. The special cooktop cleaning cream leaves a protective finish on the glass to help prevent scratches and abrasions.

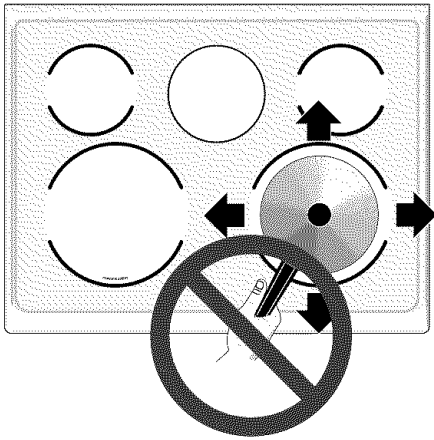

Sliding aluminum or copper clad bottom pans on the cooktop can cause metal markings on the cooktop surface. These marks should be removed **immediately** after the cooktop has cooled using the cooktop cleaning cream. Metal marks can become permanent if not removed prior to future use.

Cookware (cast iron, metal, ceramic or glass) with rough or dirty bottoms can mark or scratch the cooktop surface. **Do not slide anything metal or glass** across the cooktop. **Do not use cookware with dirt or dirt build up on bottom**; replace with clean cookware before using. **Do not** use your cooktop as a cutting board or work surface in the kitchen. **Do not** cook foods directly on the cooktop surface without a pan. **Do not** drop heavy or hard objects on the ceramic glass cooktop, they may cause it to crack.

**CAUTION** Before cleaning the cooktop, be sure the controls are turned to **OFF** and the cooktop is **COOL**.

**WARNING** **DO NOT** use a cooktop cleaner on a hot cooktop. The fumes can be hazardous to your health, and can chemically damage the ceramic-glass surface.

## Cleaning Recommendations for the Ceramic Glass Cooktop

### For light to moderate soil:

Apply a few drops of the cooktop cleaning creme directly to the cooktop. Use a paper towel or a 3M Scotch-Brite® Blue Multi-Purpose No Scratch Scrub Sponge to clean the entire cooktop surface. Make sure the cooktop is cleaned thoroughly, leaving no residue.

### For heavy, burned on soil:

Apply a few drops of cooktop cleaning creme directly to the soiled area. Rub the soiled area using a 3M Scotch-Brite® Blue Multi-Purpose No Scratch Scrub Sponge, applying pressure as needed. Do not use the sponge you use to clean the cooktop for any other purpose.

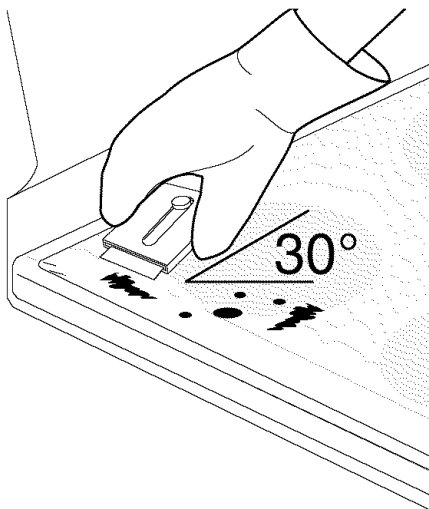

If soils remain, carefully scrape soils with a metal razor blade scraper, holding scraper at a 30 degree angle to the surface. Remove loosened soils with cooktop cleaning cream and buff surface clean.

**CAUTION** Damage to the ceramic glass cooktop may occur if you use any scrub pad other than a 3M Scotch-Brite® Blue Multi-Purpose No Scratch Scrub Sponge.

### Plastic or foods with a high sugar content:

These types of soils need be removed immediately if spilled or melted onto the ceramic cooktop surface. Permanent damage (such as pitting of the cooktop surface) may occur if not removed **immediately**. After turning the surface elements **OFF**, use a razor blade scraper or a metal spatula with a mitt and scrape the soil from the hot surface (as illustrated). Allow the cooktop to cool, and use the same method for heavy or burned on soils.

# General Care & Cleaning

## Cleaning Recommendations for Ceramic Glass Cooktops (cont'd)



Do not use the following on the ceramic glass cooktop:

- Do not use abrasive cleaners and scouring pads, such as metal and some nylon pads. They may scratch the cooktop, making it more difficult to clean.
- Do not use harsh cleaners, such as chlorine bleach, ammonia or oven cleaners, as they may etch or discolor the cooktop.
- Do not use dirty sponges, cloths or paper towels, as they can leave soil or lint on the cooktop which can burn and cause discoloration.

### Special Caution for Aluminum Use on the Ceramic Cooktop:

- **Aluminum Foil** - Use of aluminum foil on a hot cooktop will damage the ceramic cooktop. Do not use thin aluminum cooking utensils or allow aluminum foil to touch the ceramic cooktop under ANY circumstances.
- **Aluminum utensils** - The melting point of aluminum is much lower than that of other metals. Care must be taken when aluminum pots or pans are used on the cooktop. If allowed to boil dry, not only will the utensil be destroyed, but it may fuse to, break or mark the ceramic glass surface, permanently damaging the cooktop surface.

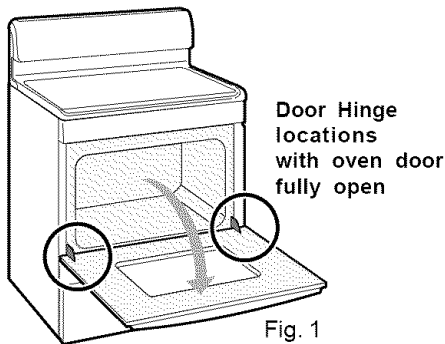

Fig. 1

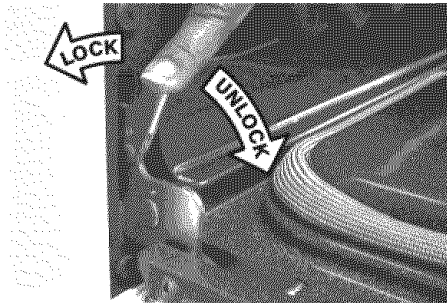

Fig. 2

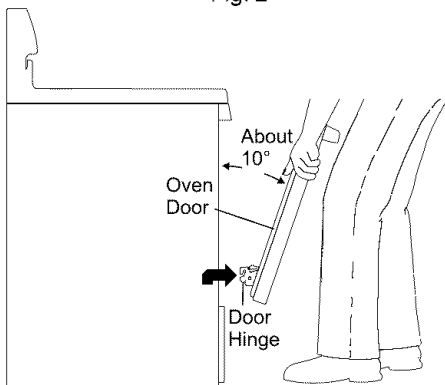

Fig. 3

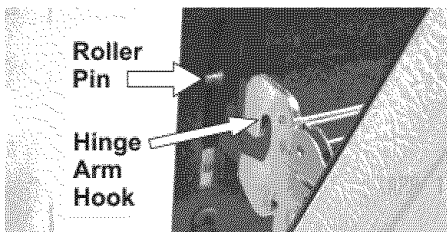

Fig. 4

## Removing and Replacing the Lift-Off Oven Door

**CAUTION** The door is heavy. For safe, temporary storage, lay the door flat with the inside of the door facing down.

### To Remove Oven Door:

1. Open oven door completely (horizontal with floor - See Fig. 1).
2. Pull the door hinge locks on both left and right door hinges down from the oven frame completely towards the oven door (See Fig. 2). A tool such as a small flat-blade screwdriver may be required.
3. Firmly grasp both sides of oven door along the door sides (Do not use the oven door handle - See Fig. 3).
4. Close the door to the broil stop position (the oven door will stop into this position just before fully closing).
5. With the oven door in the broil stop position, lift the oven door hinge arms over the roller pins located on each side of the oven frame (See Fig. 4).

### To Replace Oven Door:

1. Firmly grasp both sides of oven door along the door sides (Do not use the oven door handle - See Fig. 3).
2. Holding the oven door at the same angle as the removal position, seat the hook of the hinge arm over the roller pins located on each side of the oven door frame (See Fig. 4). The hook of the hinge arms must be fully seated onto the roller pins.
3. Fully open the oven door (horizontal with floor - See Fig. 1).
4. Push the door hinge locks up towards and into the oven frame on both left and right oven door hinges (See Fig. 2) to the locked position.
5. Close the oven door.

**Special Door Care Instructions** - Most oven doors contain glass that can break. Read the following recommendations:

1. Do not close the oven door until all the oven racks are fully in place.
2. Do not hit the glass with pots, pans, or any other object.
3. Scratching, hitting, jarring or stressing the glass may weaken its structure causing an increased risk of breakage at a later time.

# General Care & Cleaning

## Changing the Oven Light

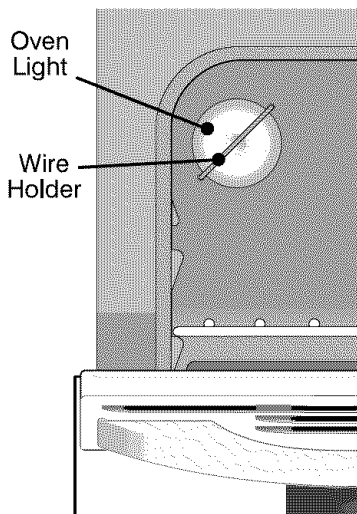

The oven light automatically turns ON when the door is opened. The oven light may also be manually operated by pressing the Oven Light switch located on the upper left control panel.

The oven light bulb is located at the rear of the oven and is covered with a glass shield held by a wire holder. The glass shield must be in place whenever the oven is in use.

### To replace the oven light bulb:

1. Turn electrical power off at the main source or unplug the range.
2. Press wire holder to one side to release the glass shield.
3. Replace bulb with a new 40 watt appliance bulb.
4. Replace glass shield over bulb and snap wire holder into place.
5. Turn power back on again at the main source (or plug the range back in).
6. The clock will then need to be reset. To reset, see **Setting the Clock and Minute Timer** in this Use & Care Guide.

**CAUTION** Be sure the range is unplugged and all parts are COOL before replacing oven light. Wear a leather-faced glove for protection against possible broken glass.

## Care and Cleaning of Stainless Steel (some models)

Some models are equipped with stainless steel exterior parts. Special care and cleaning are **required** for maintaining the appearance of stainless parts. Refer to the **Care & Cleaning** table for detailed cleaning instructions.

## Adjusting the Oven Temperature

Your oven control has been precisely set at the factory. This setting may differ from your previous oven however, so your recipe times may not give you the results you expect. If you think that the oven is cooking too hot or too cool for your recipe times, you can adjust the control so that the oven cooks hotter or cooler than the temperature displayed.

### To Adjust Oven Temperature:

1. Press **Bake**.
2. Set the temperature to 550°F (287°C) by pressing and holding the **▲**.
3. Within 2 seconds, press and hold **Bake** until the 2 digit display appears. Release **Bake**. The display now indicates the amount of degrees offset between the original factory temperature setting and the current temperature setting. If the oven control has the original factory calibration, the display will read "0."
4. The temperature can now be adjusted up or down 35°F (17°C), in 5°F steps by pressing and holding the **▲** or **▼**. Adjust until the desired amount of offset appears in the display. When lowering the oven temperature, a minus sign (-) will appear before the number to indicate that the oven will be cooler by the displayed amount of degrees.
5. When you have made the desired adjustment, press **STOP Clear** to go back to the time of day display.

**Note:** Oven temperature adjustments made will not change the Self-Cleaning feature temperature.



# Before You Call

## Solutions to Common Problems

**Before you call for service**, review this list. It may save you time and expense. The list includes common occurrences that are not the result of defective workmanship or materials in this appliance.

### OCCURRENCE

### POSSIBLE CAUSE/SOLUTION

Range is not level.

Poor installation. Place oven rack in center of oven. Place a level on the oven rack. Adjust leveling legs at base of range until the oven rack is level.

Be sure floor is level and is strong and stable enough to adequately support range.

If floor is sagging or sloping, contact a carpenter to correct the situation.

Kitchen cabinet alignment may make range appear unlevel. Be sure cabinets are square and have sufficient room for range clearance.

Cannot move appliance easily. Appliance must be accessible for service.

Cabinets not square or are built in too tightly. Contact builder or installer to make appliance accessible.

Carpet interferes with range. Provide sufficient space so range can be lifted over carpet.

Oven control beeps and displays any F code error (for example F11).

Electronic control has detected a fault condition. Press **STOP/CLEAR** to clear the display and stop beeping. Reprogram oven. If fault recurs, record fault number. Press **STOP/CLEAR** and call **1-800-4-MY-HOME®** for assistance (See back cover).

Surface element too hot or not hot enough.

Incorrect control setting. Make sure the correct control is on for the element to be used.

Surface element does not heat.

Lightweight or warped pans used. Use only flat, evenly balanced, medium or heavyweight cookware. Flat pans heat better than warped pans. Cookware materials and weight of the material affect heating. Heavy and medium-weight pans heat evenly. Because lightweight pans heat unevenly, foods may burn easily.

No power to the appliance. Check steps under "Entire Appliance Does Not Operate" in this **Before You Call** checklist.

Incorrect control setting. Make sure the correct control is set for the surface element to be used.

Entire appliance does not operate.

Make sure cord/plug is plugged correctly into outlet.

Service wiring is not complete. Call **1-800-4-MY-HOME®** for assistance (See back cover).

Power outage. Check house lights to be sure. Call your local electric company for service.

# Before You Call

## Solutions to Common Problems

<b>Oven light does not work.</b>	Replace or tighten bulb. See <b>Changing Oven Light</b> section in this Use & Care Guide.
<b>Oven smokes excessively during broiling.</b>	Control(s) not set properly. Follow instructions under <b>Setting Oven Controls</b> . Make sure oven door is opened to <b>broil stop position</b> . Meat too close to the element. Reposition the rack to provide proper clearance between the meat and the element. Preheat broil element for searing. Meat not properly prepared. Remove excess fat from meat. Cut remaining fatty edges to prevent curling, but do not cut into lean. Insert on broiler pan wrong side up and grease not draining. Always place grid on the broiler pan with ribs up and slots down to allow grease to drip into pan. Grease has built up on oven surfaces. Regular cleaning is necessary when broiling frequently. Old grease or food spatters cause excessive smoking.
<b>Poor baking results.</b>	Many factors affect baking results. Make sure the proper rack position is used. Center food in the oven and space pans to allow air to circulate. Allow the oven to preheat to the set temperature before placing food in the oven. Try adjusting the recipe's recommended temperature or baking time. If you feel the oven is too hot or cool, see <b>Adjusting Your Oven Temperature</b> in this Use & Care Guide.
<b>Self-Cleaning cycle does not work.</b>	Control(s) not set properly. Follow instructions under <b>Self-Cleaning</b> . Self-Cleaning cycle was interrupted. Follow steps under "Stopping or Interrupting a Self-Cleaning Cycle" under <b>Self-Cleaning</b> .
<b>Soil not completely removed after Self-Cleaning cycle.</b>	Failure to clean bottom, front top of oven, frame of oven or door area outside oven seal. These areas are not in the self-cleaning area, but get hot enough to burn on residue. Clean these areas before the self-cleaning cycle is started. Burned-on residue can be cleaned with a stiff nylon brush and water or a nylon scrubber. Be careful not to damage the oven gasket.
<b>Flames inside oven or smoking from vent.</b>	Excessive spillovers in oven. Set Self-Clean cycle for a longer cleaning time. Excessive spillovers in oven. This is normal, especially for high oven temperatures, pie spillovers or large amounts of grease on bottom of oven. Wipe up excessive spillovers before starting cycle. If flames or excessive smoke are present, stop the self-clean cycle and follow steps under "Stopping or Interrupting a Self-Cleaning Cycle" in the <b>Self-Cleaning</b> section.
<b>Scratches or abrasions on cooktop surface (Ceramic-Glass cooktop models only).</b>	Coarse particles such as salt or sand between cooktop and utensils can cause scratches. Be sure cooktop surface and bottoms of utensils are clean before usage. Small scratches do not affect cooking and will become less visible with time. Cleaning materials not recommended for ceramic-glass cooktop have been used. See "Cooktop Cleaning and Maintenance" in the <b>General Care &amp; Cleaning</b> section. Cookware with rough bottom has been used. Use smooth, flat-bottomed cookware.
<b>Metal marks (Ceramic-Glass cooktop models only).</b>	Sliding or scraping of metal utensils on cooktop surface. Do not slide metal utensils on cooktop surface. Use a ceramic-glass cooktop cleaning creme to remove the marks. See "Cooktop Cleaning and Maintenance" in the <b>General Care &amp; Cleaning</b> section.
<b>Brown streaks or specks (Ceramic-Glass cooktop models only).</b>	Boilovers are cooked onto surface. Use razor blade scraper to remove soil. See "Cooktop Cleaning and Maintenance" in the <b>General Care &amp; Cleaning</b> section.
<b>Areas of discoloration with metallic sheen (Ceramic-Glass cooktop models only).</b>	Mineral deposits from water and food. Remove using a ceramic-glass cooktop cleaning creme. Use cookware with clean, dry bottoms.



# Get it fixed, at your home or ours!

## Your Home

For repair – **in your home** – of **all** major brand appliances, lawn and garden equipment, or heating and cooling systems, **no matter who made it, no matter who sold it!**

For the replacement parts, accessories and owner's manuals that you need to do-it-yourself.

For Sears professional installation of home appliances and items like garage door openers and water heaters.

**1-800-4-MY-HOME® (1-800-469-4663)**

Call anytime, day or night (U.S.A. and Canada)

[www.sears.com](http://www.sears.com)    [www.sears.ca](http://www.sears.ca)

---

## Our Home

For repair of carry-in items like vacuums, lawn equipment, and electronics, call or go on-line for the location of your nearest **Sears Parts & Repair Center.**

**1-800-488-1222**

Call anytime, day or night (U.S.A. only)

[www.sears.com](http://www.sears.com)

---

To purchase a protection agreement (U.S.A.) or maintenance agreement (Canada) on a product serviced by Sears:

**1-800-827-6655** (U.S.A.)

**1-800-361-6665** (Canada)

---

Para pedir servicio de reparación a domicilio, y para ordenar piezas:

**1-888-SU-HOGAR<sup>SM</sup>**

(1-888-784-6427)

Au Canada pour service en français:

**1-800-LE-FOYER<sup>MC</sup>**

(1-800-533-6937)

[www.sears.ca](http://www.sears.ca)

# SEARS

® Registered Trademark / <sup>TM</sup> Trademark / <sup>SM</sup> Service Mark of Sears, Roebuck and Co.

® Marca Registrada / <sup>TM</sup> Marca de Fábrica / <sup>SM</sup> Marca de Servicio de Sears, Roebuck and Co.

<sup>MC</sup> Marque de commerce / <sup>MD</sup> Marque déposée de Sears, Roebuck and Co.

© Sears, Roebuck and Co.