

Over The Range Microwave Oven

Use & Care Guide

Model MMV5165AA



Important Safety Instructions..... 2-4



Features..... 5-6



Operating Instructions 7-20



Care and Cleaning 21-22



Cooking Utensils 23



Troubleshooting 24-25



Warranty 26

Guide d'utilisation et d'entretien 27

Guía de uso y cuidado..... 53

Keep instructions for future reference.
Be sure Use & Care Guide stays with oven.



Important Safety Instructions

Installer: Please leave this guide with this appliance.

Consumer: Please read and keep this Use & Care Guide for future reference.

Keep sales receipt and/or cancelled check as proof of purchase.

Model Number _____

Serial Number _____

Date of Purchase _____

In our continuing effort to improve the quality and performance of our appliances, it may be necessary to make changes to the appliance without revising this guide. If you have questions, write us (include your model number and phone number) or call:

Maytag ServicesSM
Attn: CAIR[®] Center
P.O. Box 2370
Cleveland, TN 37320-2370
1-800-688-9900 U.S.A
1-800-688-2002 Canada
1-800-688-2080
(U.S.A TTY for hearing or speech impaired)
(Mon.-Fri., 8 a.m.-8 p.m. Eastern Time)
Internet: <http://www.maytag.com>

What You Need to Know About Safety Instructions

Warning and Important Safety Instructions appearing in this Use & Care Guide are not meant to cover all possible conditions and situations that may occur. Common sense, caution, and care must be exercised when installing, maintaining, or operating microwave.

Always contact your dealer, distributor, service agent, or manufacturer about problems or conditions you do not understand.

Recognize Safety Symbols, Words, Labels

DANGER

DANGER – Immediate hazards which **WILL** result in severe personal injury or death.

WARNING

WARNING – Hazards or unsafe practices which **COULD** result in severe personal injury or death.

CAUTION

CAUTION – Hazards or unsafe practices which **COULD** result in minor personal injury.

CAUTION

To avoid personal injury or property damage, observe the following:

1. **DO NOT** deep fat fry in oven. Fat could overheat and be hazardous to handle.
2. **DO NOT** cook or reheat eggs in shell or with an unbroken yolk using microwave energy. Pressure may build up and erupt. Pierce yolk with fork or knife before cooking.
3. Pierce skin of potatoes, tomatoes, and similar foods before cooking with microwave energy. When skin is pierced, steam escapes evenly.
4. **DO NOT** operate oven without load or food in oven cavity.
5. Use only popcorn in packages designed and labeled for microwave use. Popping time varies depending on oven wattage. Do not continue to heat after popping has stopped. Popcorn will scorch or burn. Do not leave oven unattended.
6. **DO NOT** use regular cooking thermometers in oven. Most cooking thermometers contain mercury and may cause an electrical arc, malfunction, or damage to oven.
7. **DO NOT** use metal utensils in oven.
8. Never use paper, plastic, or other combustible materials that are not intended for cooking.
9. When cooking with paper, plastic, or other combustible materials, follow manufacturer's recommendations on product use.
10. **DO NOT** use paper towels which contain nylon or other synthetic fibers. Heated synthetics could melt and cause paper to ignite.
11. **DO NOT** heat sealed containers or plastic bags in oven. Food or liquid could expand quickly and cause container or bag to break. Pierce or open container or bag before cooking.
12. To avoid pacemaker malfunction, consult physician or pacemaker manufacturer about effects of microwave energy on pacemaker.



Important Safety Instructions

WARNING

To avoid risk of electrical shock or death, this oven must be grounded and plug must not be altered.

Grounding Instructions

Oven MUST be grounded. Grounding reduces risk of electric shock by providing an escape wire for the electric current if an electrical short occurs. This oven is equipped with a cord having a grounding wire with a grounding plug. The plug must be plugged into an outlet that is properly installed and grounded. See installation instructions.

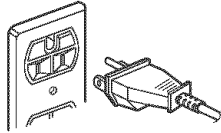

Consult a qualified electrician or servicer if grounding instructions are not completely understood, or if doubt exists as to whether the oven is properly grounded.

Do not use an extension cord. If the product power cord is too short, have a qualified electrician install a three-slot receptacle. This oven should be plugged into a separate 60 hertz circuit with the electrical rating as shown in specifications table. When the oven is on a circuit with other equipment, an increase in cooking times may be required and fuses can be blown.

Microwave operates on standard household current, 110-120V.

Federal Communications Commission Radio Frequency Interference Statement (U.S.A. Only)

This equipment generates and uses ISM frequency energy and if not installed and used properly, that is in strict accordance with the manufacturer's instructions, may cause interference to radio and television reception. It has been type tested and found to comply with limits for ISM Equipment pursuant to part 18 of FCC Rules, which are designed to provide reasonable protection against such interference in a residential installation.

However, there is no guarantee that interference will not occur in a particular installation. If this equipment does cause interference to radio or television reception, which can be determined by turning the equipment off and on, the user is encouraged to try to correct the interference by one or more of the following:

- Reorient the receiving antenna of the radio or television.
- Relocate the microwave oven with respect to the receiver.

- Move the microwave oven away from the receiver.
- Plug the microwave oven into a different outlet so that the microwave oven and the receiver are on different branch circuits.

The manufacturer is not responsible for any radio or television interference caused by **unauthorized modification** to this microwave oven. It is the responsibility of the user to correct such interference.

Precautions to Avoid Possible Exposure to Excessive Microwave Energy

- DO NOT** attempt to operate this oven with the door open since open door operation can result in harmful exposure to microwave energy. It is important not to defeat or tamper with the safety interlocks.
- DO NOT** place any object between the oven front face and the door to allow soil or cleaner residue to accumulate on sealing surfaces.
- DO NOT** operate the oven if it is damaged. It is particularly important that oven door close properly and that there is no damage to:
 1. door (bent),
 2. hinges and latches (broken or loosened),
 3. door seals and sealing surfaces.
- Oven should not be adjusted or repaired by anyone except properly qualified service personnel.

WARNING

Liquids such as water, coffee, or tea are able to be overheated beyond the boiling point without appearing to be boiling due to surface tension of the liquid. Visible bubbling or boiling when the container is removed from the microwave oven is not always present. **THIS COULD RESULT IN VERY HOT LIQUIDS SUDDENLY BOILING OVER WHEN A SPOON OR OTHER UTENSIL IS INSERTED INTO THE LIQUID.** To reduce the risk of injury to persons:

1. **DO NOT** overheat the liquid.
2. Stir the liquid both before and halfway through heating it.
3. **DO NOT** use straight-sided containers with narrow necks.
4. After heating, allow the container to stand in the microwave oven for a short time before removing the container.
5. Use extreme care when inserting a spoon or other utensil into the container.

SAVE THESE INSTRUCTIONS



Important Safety Instructions

⚠ WARNING

When using electrical appliances, basic safety precautions should be followed to reduce the risk of burns, electric shock, fire, or injury to persons or exposure to excessive microwave energy.

1. **READ** all instructions before using oven.
2. **READ AND FOLLOW** the specific "PRECAUTIONS TO AVOID POSSIBLE EXPOSURE TO EXCESSIVE MICROWAVE ENERGY" on page 3.
3. Install or locate this oven **ONLY** in accordance with the installation instructions in this manual.
4. Some products such as whole eggs and sealed containers – for example, closed glass jars – are able to explode and **SHOULD NOT** be **HEATED** in this oven.
5. Use this oven **ONLY** for its intended use as described in this manual. Do not use corrosive chemicals or vapors in this oven. This type of oven is specifically designed to heat, cook, or dry food. It is not designed for industrial or laboratory use.
6. As with any appliance, **CLOSE SUPERVISION** is necessary when used by **CHILDREN** or **INFIRM PERSONS**.
7. See door cleaning instructions in the Care and Cleaning section.
8. Baby food jars shall be open when heated and contents stirred or shaken before consumption, in order to avoid burns.
9. **DO NOT** use this oven for commercial purposes. It is made for household use only.
10. **DO NOT** heat baby bottles in oven.
11. **DO NOT** operate this oven if it has a damaged cord or plug, if it is not working properly, or if it has been damaged or dropped.
12. This oven, including power cord, must be serviced **ONLY** by qualified service personnel. Special tools are required to service oven. Contact nearest authorized service facility for examination, repair, or adjustment.
13. **DO NOT** cover or block filter or other openings on oven.
14. **DO NOT** store this oven outdoors. **DO NOT** use this product near water – for example, near a kitchen sink, in a wet basement, near a swimming pool or similar locations.
15. **DO NOT** immerse cord or plug in water.
16. Keep cord **AWAY** from **HEATED** surfaces.
17. **DO NOT** let cord hang over edge of table or counter.
18. Clean the ventilating hood frequently.
19. **DO NOT** allow grease to accumulate on the hood or filters.
20. Use care when cleaning the ventilating hood filters. Corrosive cleaning agents such as lye-based oven cleaners may damage the filters.
21. When flaming foods under the hood, turn the fan on.
22. Suitable for use above both gas and electric cooking equipment 36 inches or less wide.

⚠ CAUTION

To avoid risk of fire in the oven cavity:

- a. **DO NOT** overcook food. Carefully attend oven when paper, plastic, or other combustible materials are placed inside the oven to facilitate cooking.
- b. Remove wire twist-ties from paper or plastic bags before placing bag in oven.
- c. If materials inside the oven ignite, keep oven door **CLOSED**, turn oven off and disconnect the power cord, or shut off power at the fuse or circuit breaker panel.
- d. **DO NOT** use the cavity for storage. **DO NOT** leave paper products, cooking utensils, or food in the cavity when not in use.

SAVE THESE INSTRUCTIONS



Features

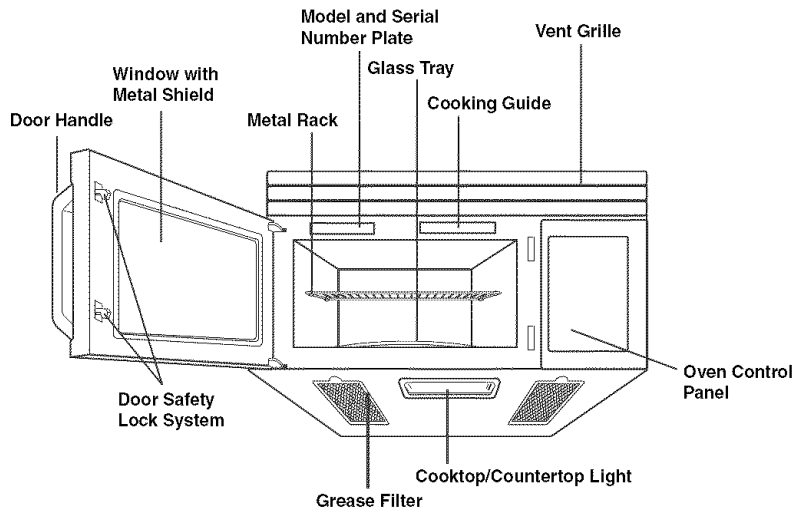

OVEN SPECIFICATIONS

Power Supply	120 VAC, 60 Hz
Input Power	1,560 W
Cooking Power	1,000 W (IEC 60705 Standard)
Frequency	2,450 MHz
Rated Current	13.3 A
Outer Dimensions (WxHxD)	29 ¹⁵ / ₁₆ " x 16 ⁷ / ₁₆ " x 15 ³ / ₈ "
Cavity Volume	1.6 Cu. Ft.
Net Weight	54 lbs.

MMV5165AA

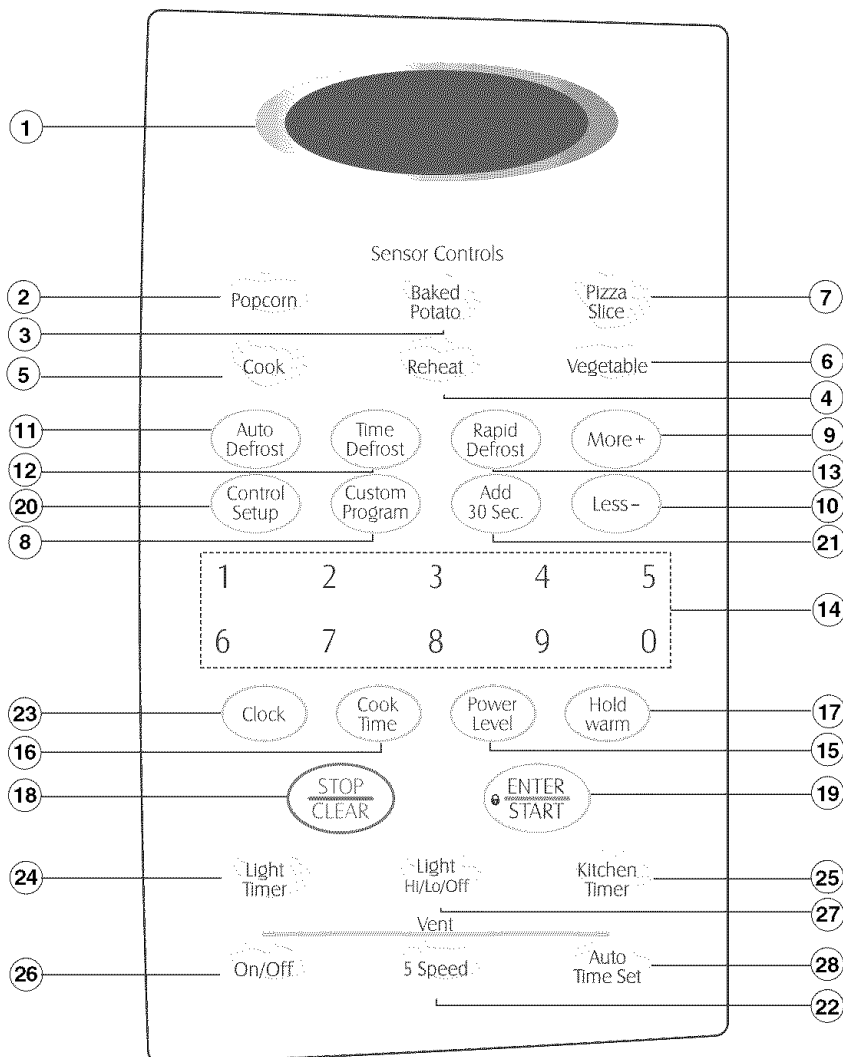

FEATURES

- DISPLAY:** The display includes a clock and indicators to tell you time of day, cooking time settings and cooking functions selected.
- POPCORN:** Touch this pad when popping popcorn in your microwave oven. The oven's sensor will tell the oven how long to cook depending on the amount of humidity it detects from the popcorn. See page 11 for more information.
- BAKED POTATO:** Touch this pad to cook potatoes. The oven's sensor will tell the oven how long to cook depending on the amount of humidity it detects from the potato. See page 12 for more information.
- REHEAT:** Touch this pad to reheat casserole, dinner plate, and soup/sauce. The oven's sensor will tell the oven how long to cook depending on the amount of humidity coming from the food. See page 12 for more information.



Features

5. **COOK:** Touch this pad to cook frozen entree, casserole, and rice. The oven's sensor will tell the oven how long to cook depending on the amount of humidity coming from the food. See page 12 for more information.
6. **VEGETABLE:** Touch this pad to cook vegetables. The oven's sensor will tell the oven how long to cook depending on the amount of humidity it detects from the vegetables. See page 12 for more information.
7. **PIZZA SLICE:** Touch this pad to reheat pizza. The oven's sensor will tell the oven how long to cook depending on the amount of humidity it detects. See page 11 for more information.
8. **CUSTOM PROGRAM:** Touch this pad to recall one cooking instruction previously programmed into memory. See page 9 for more information.
9. **MORE+:** Touch this pad to add ten seconds of cooking time each time you press it. See page 9 for more information.
10. **LESS-:** Touch this pad to subtract ten seconds of cooking time each time you press it. See page 9 for more information.
11. **AUTO DEFROST:** Meat, poultry, fish. Touch this pad to select food type and defrost food by weight. See page 14 for more information.
12. **TIME DEFROST:** Touch this pad to defrost most other frozen foods. See page 15 for more information.
13. **RAPID DEFROST:** This pad provides RAPID defrost for 1.0 pound of frozen food. See page 15 for more information.
14. **NUMBER:** Touch number pads to enter cooking time, power level, quantities, or weights.
15. **POWER LEVEL:** Touch this pad to select a cooking power level.
16. **COOK TIME:** Touch this pad to set a cooking time. See page 9 for more information.
17. **HOLD WARM:** Touch this pad to keep hot, cooked foods warm in your microwave oven for up to 99 minutes 99 seconds. See page 8 for more information.
18. **STOP/CLEAR:** Touch this pad to stop the oven or to clear all entries.
19. **ENTER/START:** Touch this pad to start a function. If you open the door after oven begins to cook, touch ENTER/START again.
20. **CONTROL SETUP:** Touch this pad to change the oven's default settings for sound, clock, display speed and defrost weight. See page 7 for more information.
21. **ADD 30 SEC.:** Touch this pad to set and start quickly at 100% power level. See page 8 for more information.
22. **VENT 5 SPEED:** Touch this pad to choose one of 5 fan speeds. See page 7 for more information.
23. **CLOCK:** Touch this pad to enter the time of day. See page 7 for more information.
24. **LIGHT TIMER:** Touch this pad to set the light timer. See page 8 for more information.
25. **KITCHEN TIMER:** Touch this pad to set the kitchen timer. See page 7 for more information.
26. **VENT ON/OFF:** Touch this pad to turn the fan on or off. See page 7 for more information.
27. **LIGHT HI/LO/OFF:** Touch this pad to turn on the cooktop/countertop light. See page 8 for more information.
28. **VENT AUTO TIME SET:** Touch this pad when setting ventilation time. (1, 3, 5, 10, 30 minutes.) See page 7 for more information.



Operating Instructions

LEARN ABOUT YOUR MICROWAVE OVEN

This section discusses the concepts behind microwave cooking and introduces you to the basics you need to know to operate your microwave oven. Please read this information before use.

CAUTION

- To avoid risk of personal injury or property damage, do not run oven empty.
- To avoid risk of personal injury or property damage, do not use stoneware, aluminum foil, metal utensils, or metal trimmed utensils in the oven.

CLOCK

When your microwave oven is first plugged in or after a power failure, the Display will show "PLEASE SET TIME OF DAY." If a time of day is not set, ":" will show on the Display until you touch "Clock".

Example: To set 8:00 AM.

1. Touch **CLOCK** pad. (Press once for AM, twice for PM)
2. Enter the time by using the number key pad.
3. Touch **ENTER/START** pad.



8 0 0



KITCHEN TIMER

You can use your microwave oven as a timer. Use the Timer for timing up to 99 minutes, 99 seconds.

Example: To set for 3 minutes.



1. Touch **KITCHEN TIMER** pad.
2. Enter the time by using the number key pad.
3. Touch **ENTER/START** pad. When the time is over, you will hear beeps and **END** will display.

CONTROL SETUP

You can change the default values for beep sound, clock, display speed and defrost weight.

See following chart for more information.

No.	Function	No.	Result
1	Beep ON/OFF control	1	Sound ON
		2	Sound OFF
2	Clock display control	1	Clock ON
		2	Clock OFF
3	Display	1	Slow speed
		2	Normal speed
		3	Fast speed
4	Defrost weight mode selected	1	Lbs.
		2	Kg.

Example: To change defrost weight mode (from Lbs. to Kg).



4

2

1. Touch **CONTROL SETUP** pad.
2. Touch number **4** pad.
3. Touch number **2** pad.

VENT FAN

The fan moves steam and other vapors from the cooking surface. There are five speeds.

Example for Level 4:



1. Touch **ON/OFF** pad. This shows the last level until you select the fan speed level.
2. Touch until level **4** appears in the display.

Touch **ON/OFF** pad to turn off fan when desired.

NOTES:

- If the temperature from the range or cooktop below the oven gets too hot, the exhaust fan in the vent hood will automatically turn on at the LEVEL 5 setting to protect the oven.
- It may stay on up to an hour to cool the oven. When this occurs, the ON/OFF button will not turn the fan off.

VENT AUTO TIME SET

Example: To set 30 minutes for level 4.



1. Touch **ON/OFF** pad.
2. Touch until level **4** appears in the display.
3. Touch **AUTO TIME SET** pad 5 times.



Operating Instructions

CHILD LOCK

You may lock the control panel to prevent the microwave from being accidentally started or used by children.

The Child Lock feature is also useful when cleaning the control panel. Child Lock prevents accidental programming when wiping the control panel.

Example: To set the child lock.



1. Touch **STOP/CLEAR** pad.
2. Touch and hold **ENTER/START** pad more than **4** seconds. **LOCKED** will appear in the display window with two beeps.



Example: To cancel the child lock.

1. Touch and hold **ENTER/START** pad more than **4** seconds. **LOCKED** will disappear and you hear two beeps.



LIGHT HI/LO/OFF

Touch **LIGHT HI/LO/OFF** pad once for bright light, twice for night light, or three times to turn the light off.



ADD 30 SEC.

A time-saving pad, this simplified control lets you quickly set and start microwave cooking without the need to touch the **ENTER/START** pad.

Example: To set **ADD 30 SEC.** for **2** minutes.

1. Touch **ADD 30 SEC.** pad 4 times. The oven begins cooking and display shows time counting down.



LIGHT TIMER

You can set the **LIGHT** to turn on and off automatically at any time. The light comes on at the same time every day until reset.

Example: Turn on **2:00 AM**, turn off **7:00 AM**.



2 0 0



7 0 0



1. Touch **LIGHT TIMER** pad. (Press once for AM, twice for PM.)
2. Enter the time you want the **LIGHT** to turn on.
3. Touch **LIGHT TIMER** pad again. (Press once for AM, twice for PM.)
4. Enter the time you want the **LIGHT** to turn off.
5. Touch **ENTER/START** pad.

NOTE:

- To reset the time to turn on and off the **LIGHT**, repeat steps 1 to 5.

Example: To cancel the **LIGHT TIMER**.



1. Touch **LIGHT TIMER** pad.
2. Touch **STOP/CLEAR** pad.

NOTE:

- If you want to cancel the **LIGHT TIMER** in operation, touch the  pad.

HOLD WARM

You can keep cooked food warm in your microwave oven for up to 99 minutes 99 seconds. You can use **HOLD WARM** by itself or to follow a cooking cycle automatically.



1. Touch **HOLD WARM** pad.



2. Touch **ENTER/START** pad.

NOTES:

- **HOLD WARM** operates for up to 99 minutes 99 seconds.
- **Food cooked covered** should be covered during **HOLD WARM**.
- **Pastry items** (pies, turnovers, etc.) should be uncovered during **HOLD WARM**.
- **Complete meals** kept warm on a dinner plate can be covered during **HOLD WARM**.

Food Type	Recommended Quantity
Liquid	1-2 cups
Dry	5-10 ozs.

To make **HOLD WARM** automatically follow another cycle:

- While you are programming the cooking instructions, touch **HOLD WARM** before touching **ENTER/START**.
- When the last cooking cycle is over, you will hear two beeps and "HOLD WARM" will appear in the oven display.
- You can set **HOLD WARM** to follow **AUTO DEFROST**, or multi-cycle cooking.



Operating Instructions

CUSTOM PROGRAM

CUSTOM PROGRAM lets you recall one cooking instruction previously placed in memory and begin cooking quickly.

Example: To cook for 2 minutes.



1. Touch **CUSTOM PROGRAM** pad.

2 0 0

2. Enter the cook time.



3. Touch **ENTER/START** pad.

Example: To recall the custom program.



1. Touch **CUSTOM PROGRAM** pad.

2. Touch **ENTER/START** pad.



When the cook time is over, you will hear four beeps and **END** will display.

MORE+/LESS-

By using the MORE+ or LESS- keys, all of the pre-programmed cook and time cook features can be adjusted to cook food for a longer or shorter time.

1. Pressing **MORE+** will add

10 seconds of cooking time each time you press it.



2. Pressing **LESS-**

will subtract 10 seconds of cooking time each time you press it.



COOKING AT HIGH POWER LEVELS

Example: To cook food for 8 minutes 30 seconds at 100% power.

8 3 0

1. Enter the cook time.



2. Touch **ENTER/START** pad.

When the cook time is over, you will hear four beeps and **END** will display.

COOKING AT LOWER POWER LEVELS

HIGH power cooking does not always give you the best results with foods that need slower cooking, such as roasts, baked goods, or custards. Your oven has 10 power settings in addition to HIGH.

Example: To cook food for 7 minutes 30 seconds at 70% power.

7 3 0

1. Enter the cook time.



2. Touch **POWER LEVEL** pad.

7

3. Enter the power level.



4. Touch **ENTER/START** pad.

When the cook time is over, you will hear four beeps and **END** will display.

See cooking guide for Power Levels, page 10.

COOKING WITH MORE THAN ONE COOK CYCLE

For best results, some recipes call for one Power Level for a certain length of time, and another Power Level for another length of time. Your oven can be set to change from one to another automatically, for up to three cycles if the first heating cycle is defrost.

Example: To cook food for 3 minutes at 100% power and then 70% power for 7 minutes 30 seconds.

3 0 0

1. Enter the first cook time.



2. Touch **COOK TIME** pad.

7 3 0

3. Enter the second cook time.



4. Touch **POWER LEVEL** pad.

7

5. Enter the power level.



6. Touch **ENTER/START** pad.

When the cook time is over, you will hear four beeps and **END** will display.



Operating Instructions

COOKING GUIDE FOR LOWER POWER LEVELS

The 10 power levels in addition to HIGH allow you to choose the best power level for the food you are cooking. Below are listed all the power levels, examples of foods best cooked at each level, and the amount of microwave power you are using.

POWER LEVEL	MICROWAVE OUTPUT	USE
10 High	100%	<ul style="list-style-type: none"> • Boil water. • Cook ground beef. • Make candy. • Cook fresh fruits and vegetables. • Cook fish and poultry. • Preheat browning dish. • Reheat beverages. • Bacon slices. Place utensil on metal oven rack.
9	90%	<ul style="list-style-type: none"> • Reheat meat slices quickly. • Saute onions, celery, and green pepper.
8	80%	<ul style="list-style-type: none"> • All reheating. • Cook scrambled eggs.
7	70%	<ul style="list-style-type: none"> • Cook breads and cereal products. • Cook cheese dishes, veal. • Cook cakes, muffins, brownies, cupcakes.
6	60%	<ul style="list-style-type: none"> • Cook pasta.
5	50%	<ul style="list-style-type: none"> • Cook meats, whole poultry. • Cook custard. • Cook whole chicken, turkey, spare ribs, rib roast, sirloin roast.
4	40%	<ul style="list-style-type: none"> • Cook less tender cuts of meat. • Reheat frozen convenience foods.
3	30%	<ul style="list-style-type: none"> • Thaw meat, poultry, and seafood. • Cook small quantities of food. • Finish cooking casserole, stew, and some sauces.
2	20%	<ul style="list-style-type: none"> • Soften butter and cream cheese. • Heat small amounts of food.
1	10%	<ul style="list-style-type: none"> • Soften ice cream. • Raise yeast dough.
0		<ul style="list-style-type: none"> • Standing time.



Operating Instructions

SENSOR OPERATING INSTRUCTIONS

Sensor Cook allows you to cook most of your favorite foods without selecting cooking times and power levels. The display will indicate SENSING during the initial sensing period. The oven automatically determines required cooking time for each food item. When the internal sensor detects a certain amount of humidity coming from the food, it will tell the oven how much longer to heat. The display will show the remaining heating time. For best results for cooking by Sensor, follow these recommendations:

1. Food cooked with the sensor system should be at normal storage temperature.
2. Glass Tray and outside of container should be dry to assure best cooking results.
3. Foods should always be covered loosely with microwavable plastic wrap, waxed paper, or a lid.
4. Do not open the door or touch the STOP/CLEAR pad during the sensing time. When sensing time is over, the oven beeps twice and the remaining cooking time will appear in the display window. At this time you can open the door to stir, turn, or rearrange the food.

SENSOR COOKING GUIDE

Appropriate containers and coverings help assure good Sensor cooking results.

1. Always use microwavable containers and cover them with lids or vented plastic wrap.
2. Never use tight-sealing plastic covers. They can prevent steam from escaping and cause food to overcook.

3. Match the amount to the size of the container. Fill containers at least half full for best results.
4. Be sure the outside of the cooking container and the inside of the microwave oven are dry before placing food in the oven. Beads of moisture turning into steam can mislead the sensor.

ADDING OR SUBTRACTING COOK TIME

By using the **MORE+** or **LESS-** pads all of the sensor cook and time cook settings can be adjusted to cook food for a longer or shorter time. Pressing **MORE+** will add 10 seconds of cooking time each time you press it. Pressing **LESS-** will subtract 10 seconds of cooking time each time you press it.

PIZZA SLICE

Reheating pizza with PIZZA SLICE lets you reheat one or several slices of pizza without selecting cooking times and power levels.

Example: To reheat 2 slices of pizza.



1. Touch **PIZZA SLICE** pad. When the cook time is over, you will hear four beeps and **END** will display.

- Recommended amounts: 1-3 slices, (about 3-5 ozs. each slice).

POPCORN

CAUTION

- **DO NOT** leave microwave oven unattended while popping corn.
- When popping commercially packaged popcorn, **remove the rack from the oven;** Do not place the bag of microwave popcorn on the rack or under the rack.

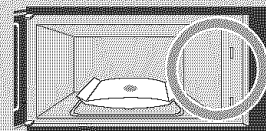
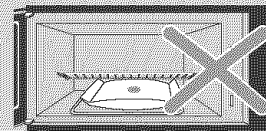
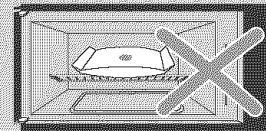

POPCORN lets you pop commercially packaged microwave popcorn. Pop only one package at a time. For best results, use fresh bags of popcorn.

Example: To pop popcorn.



1. Touch **POPCORN** pad. When the cook time is over, you will hear four beeps and **END** will display.

- Recommended amounts: 3.0-3.5 ozs.



Operating Instructions

BAKED POTATO

The BAKED POTATO pad lets you bake one or several potatoes without selecting cooking times and power levels.

NOTES:

- Before baking, pierce potato with fork several times.
- After baking, let stand for 5 minutes.

Example: To cook 2 potatoes.



1. Touch **BAKED POTATO** pad. When the cook time is over, you will hear four beeps and **END** will display.

- Recommended amounts: 1-4 potatoes (about 8-10 ozs. each).

VEGETABLE

VEGETABLE has preset cook powers for 3 food categories: **Fresh, Frozen, and Canned.**

Example: To cook Frozen Vegetable.



2

1. Touch **VEGETABLE** pad.
2. Choose food category.

Category	Touch Pad Number
Fresh	1
Frozen	2
Canned	3

When the cook time is over, you will hear four beeps and **END** will display.

NOTE:

- Place canned vegetables in a microwavable bowl or casserole. Cover with plastic wrap and vent. Let stand 5 minutes.
- Recommended amounts: 1-4 cups
- Recommend 1/4"-1/2" venting of cover.

COOK

Using COOK lets you heat common microwave-prepared foods without needing to program times and Cook Powers. COOK has preset Cook Power for 3 food categories: **Frozen Entree, Casserole, and Rice.**

Example: To cook Rice.



3

1. Touch **COOK** pad.
2. Choose food category.

Category	Touch Pad Number
Frozen Entree	1
Casserole	2
Rice	3

When the cook time is over, you will hear four beeps and **END** will display.

Recommended amounts:

Frozen Entree	10-21 ozs.
Casserole	1-4 cups
Rice	1/2-2 cups

NOTE:

- Use only long grain rice with sensor cook program. See page 20 to cook other types of rice.

REHEAT

REHEAT lets you heat foods without needing to program times and Cook Powers. REHEAT has preset Cook Powers for 3 categories: **Casserole, Dinner Plate, and Soup/Sauce.**

Example: To reheat Casserole.



3

1. Touch **REHEAT** pad.
2. Choose food category.

Category	Touch Pad Number
Dinner Plate	1
Soup/Sauce	2
Casserole	3

When the cook time is over, you will hear four beeps and **END** will display.

Recommended amounts:

Dinner Plate	1-2 servings
Soup/Sauce	1-4 cups
Casserole	1-4 cups



Operating Instructions

SENSOR COOK TABLE

CATEGORY		DIRECTIONS	AMOUNT
Potato		Pierce each potato with a fork and place on the oven tray around the edge, at least one inch apart.	1 - 4 medium approx. 8 -10 ozs. each
VEGETABLE	Fresh Vegetable	Prepare as desired, wash, and leave residual water on the vegetables. Place in an appropriately-sized microwave container, cover with plastic wrap and vent.	1 - 4 cups
	Frozen Vegetable	Remove from package, rinse off frost under running water. Place in an appropriately-sized microwave container, cover with plastic wrap and vent.	1 - 4 cups
	Canned Vegetable	Remove from the outer display can. Place in an appropriately sized microwave container, cover with plastic wrap and vent. After cooking, stir and allow to stand for 3 minutes.	1 - 4 cups
Casserole		Assemble the ingredients per the recipe in a 1-2 quart casserole. Cooking with plastic wrap and vent. After cooking, stir and allow to stand for 3 minutes	1 - 4 cups
Rice		Add twice the amount of water to the rice. Use a microwave container large enough to prevent water from boiling over dish. Cover with plastic wrap or lid.	½ - 2 cups
Frozen Entree		Remove from outer display package. Slit cover. If not in microwave-safe container, place on plate, cover with plastic wrap and vent.	10 - 21 ozs.

SENSOR REHEAT TABLE

CATEGORY		DIRECTIONS	AMOUNT
Pizza		This is a reheat function for leftover pizza. Place on paper towel on a microwave safe plate.	1 - 3 slices (3 - 5 ozs. each)
Dinner Plate		Place on a low plate. Cover with vented plastic wrap. Let stand 3 minutes.	1 - 2 servings
Soup/Sauce		Place in shallow microwavable casserole. Cover with vented plastic wrap. After cooking, stir and let stand 3 minutes.	1 - 4 cups
Casserole		Cover dish containing the casserole with plastic wrap and vent. After cooking, stir and allow to stand for 3 minutes.	1 - 4 cups



Operating Instructions

AUTO DEFROST

Three defrost choices are preset in the oven. The defrost feature provides you with the best defrosting method for frozen foods, because the oven automatically sets the defrosting times for each food item according to the weight you enter. For added convenience, the AUTO DEFROST includes a built-in tone mechanism that reminds you to check, turn over, separate, or rearrange the food during the defrost cycle. Three different defrosting options are provided.

1. **MEAT**
2. **POULTRY**
3. **FISH**

After touching AUTO DEFROST once, select the food category. Available weight ranges for Meat, Poultry and Fish are 0.1 to 6.0 lbs.

Example : To defrost 1.2 lbs of meat.



1

1 2



1. Touch **AUTO DEFROST** pad.
2. Choose food category.
3. Enter the weight.
4. Touch **ENTER/START** pad.

NOTES:

- After you touch ENTER/ START, the display counts down the defrost time. The oven will beep once during the Defrost cycle. At this time, open the door and turn, separate, or rearrange the food as needed. Remove any portions that have thawed then return frozen portions to the oven and touch ENTER/START to resume the defrost cycle.
- **The oven will not stop during the BEEP unless the door is opened.**

For best results:

- Remove fish, shellfish, meat, and poultry from its original closed paper or plastic package (wrapper). Otherwise, the wrap will hold steam and juice close to the foods, which can cause the outer surface of the foods to cook.
- Form the meat into the shape of a doughnut before freezing. When defrosting, scrape off thawed meat when the beep sounds and continue defrosting.
- Place foods in a shallow glass baking dish or on a microwave roasting rack to catch drippings.
- Foods should still be somewhat icy in the center when removed from the oven.

AUTO DEFROST TABLE

Category	Food
MEAT 0.1 to 6 lbs	BEEF Ground beef, Round steak, Cubes for stew, Tenderloin steak, Pot roast, Rib roast, Rump roast, Chuck roast, Hamburger patty. LAMB Chops (1-inch thick), Rolled roast. PORK Chops (1/2-inch thick), Hot dogs, Spareribs, Country-style ribs, Rolled roast, Sausage.
POULTRY 0.1 to 6 lbs	POULTRY Whole (under 4 lbs), Cut up, Breasts (boneless). CORNISH HENS Whole. TURKEY Breast (under 6 lbs).
FISH 0.1 to 6 lbs	FISH Fillets, Whole, Steaks. SHELLFISH Crab meat, Lobster tails, Shrimp, Scallops.

DEFROST TIPS

- When using AUTO DEFROST, the weight to be entered is the net weight in pounds and tenths of pounds (the weight of the food minus the container).
- Use AUTO DEFROST only for raw food. AUTO DEFROST gives best results when food to be thawed is a minimum of 0°F (taken directly from a true freezer). If food has been stored in a refrigerator-freezer that does not maintain a temperature of 5°F or below, always program a lower food weight (for a shorter defrosting time) to prevent cooking the food.
- If the food is stored outside the freezer for up to 20 minutes, enter a lower food weight.
- The shape of the package alters the defrosting time. Shallow rectangular packets defrost more quickly than a deep block.
- Separate pieces as they begin to defrost. Separated pieces defrost more easily.
- You can use small pieces of aluminum foil to shield foods like chicken wings, leg tips, and fish tails, but the foil must not touch the side of the oven. Foil causes arcing, which can damage the oven lining.
- Shield areas of food with small pieces of foil if they start to become warm.
- For better results, a preset standing time is included in the defrosting time.
- For best results, elevate food to be defrosted on a microwave safe roasting rack. This prevents the possibility of warm meat juices cooking food during defrost.





Operating Instructions

TIME DEFROST

This feature allows you to choose the time you want to defrost.

The Time Defrost Chart provides some basic guidelines for using Time Defrost.

Example: To defrost for 2 minutes.



1. Touch **TIME DEFROST** pad. 
2. Enter the defrosting time you want.
 2 0 0
3. Touch **ENTER/START** pad.  (Defrost starts)

When the defrost time is over, you will hear four beeps and **END** will display.

RAPID DEFROST

The RAPID DEFROST feature provides a rapid defrost for 1.0 pound frozen food. The oven automatically sets the defrosting time for ground beef.

Example: To defrost 1lb. ground beef.

1. Touch **RAPID DEFROST** pad. 
2. Touch **ENTER/START** pad. 

METAL RACK

CAUTION

- To avoid risk of property damage:
- Do not use rack to pop popcorn.
 - Rack must be on the four plastic supports when used.
 - Use the rack only when cooking food on rack position.
 - Do not cook with rack on floor of the oven.

The metal rack gives you extra space when cooking in more than one container at the same time.

To use rack:

1. Place rack securely in the four plastic supports.
 - Rack **MUST NOT** touch metal walls or back of microwave oven.
2. Place equal amounts of food both **ABOVE AND BELOW** rack.
 - Amount of food must be approximately the same to balance out cooking energy.

TIME DEFROST CHART

FOOD	TIME	SPECIAL INSTRUCTIONS
MEAT Bacon (1 lb.) Ground meat (1 lb.) Roasts Steaks, chops and cutlets	 2 - 4 minutes 4½ - 6 minutes 4½ - 6 minutes 4½ - 6 minutes per lb.	 Turn meat over at beep. Stand for 5 minutes after defrosting. Turn meat over at beep. Stand for 5 minutes after defrosting. Turn meat over at beep. Shield warm areas with foil. Stand for 5 to 10 minutes. Same as above.
POULTRY Chicken, broiler-fryer cut up (2½ to 3 lbs.) Chicken, whole (2 to 3 lbs.) Cornish hen	 13 - 16 minutes 15 - 18 minutes 5 - 7 minutes per lb.	 Turn meat over at beep. Shield warm areas with foil. Stand for 20 to 30 minutes. Cover with foil. Turn meat over at beep. Shield warm areas with foil. Stand for 20 to 30 minutes. Cover with foil. Turn meat over at beep. Shield warm areas with foil. Stand for 20 to 30 minutes. Cover with foil.
FISH & SEAFOOD Fillets (1 lb.) Shellfish, small pieces (1 lb.)	 4 - 5½ minutes 4 - 5 minutes	 Place block in casserole. Turn food over and break up after beep. Stand for 5 minutes.

NOTE:

- Defrost times are approximate and are intended as guidelines.



Operating Instructions

GETTING THE BEST COOKING RESULTS

To get the best results from your microwave oven, read and follow the guidelines below.

• **Storage Temperature:** Foods taken from the freezer or refrigerator take longer to cook than the same foods at room temperature.

The time for recipes in this book is based on the normal storage temperature of the food.

• **Size:** Small pieces of food cook faster than large ones, pieces similar in size and shape cook more evenly. For even cooking, reduce the power when cooking large pieces of food.

• **Natural Moisture:** Very moist foods cook more evenly because microwave energy is attracted to water molecules.

• **Stir** foods such as casseroles and vegetables from the outside to the center to distribute the heat evenly and speed cooking. Constant stirring is not necessary.

• **Turn over** foods like pork chops, baking potatoes, roasts, or whole cauliflower halfway through the cooking time to expose all sides equally to microwave energy.

• **Place** delicate areas of foods, such as asparagus tips, toward the center of the dish.

• **Arrange** unevenly shaped foods, such as chicken pieces or salmon steaks, with the thicker, meatier parts toward the outside of the dish.

• **Shield**, with **small** pieces of aluminum foil, parts of food that may cook quickly, such as wing tips and leg ends of poultry.

• **Let It Stand:** After you remove the food from the microwave, cover food with foil or casserole lid and let it stand to finish cooking in the center and avoid overcooking the outer edges. The length of standing time depends on the density and surface area of the food.

• **Wrapping in waxed paper or paper towel:** Sandwiches and many other foods containing prebaked bread should be wrapped prior to microwaving to prevent drying out.

FISH AND SHELLFISH

Cooking Fish and Shellfish: General Directions

- Prepare the fish for cooking.
 - Completely defrost the fish or shellfish.
 - Arrange unevenly shaped pieces with thicker parts toward the outside of the dish. Arrange shellfish in a single layer for even cooking.
 - The type of cover you use depends on how you cook. Poached fish needs a microwavable lid or vented plastic wrap.
 - Baked fish, coated fish, or fish in sauce needs to be covered lightly with waxed paper to keep the coating crisp and sauce from getting watery.
 - Always set the shortest cooking time. Fish is done when it turns opaque and the thickest part begins to flake. Shellfish is done when the shell turns from pink to red and the flesh is opaque and firm.
- The Fish and Shellfish Cooking Table below provides specific directions with Power Level and Cooking Time settings for most types of fish and shellfish.

FISH AND SHELLFISH COOKING TABLE

FISH	POWER LEVEL	COOKING TIME	DIRECTIONS
Fish fillets	HI	3½-4½ minutes	Arrange fish in a single layer with thickest portion toward outside edge of 1½ quart microwavable baking dish. Brush with melted butter and season, if desired. Cook covered with vented plastic wrap. Let stand covered 2 minutes. If you are cooking more than 1 lb. of fish, turn the fish halfway through cooking.
Fish steaks	HI	4½-5½ minutes	
Whole fish	7	4½-6 minutes	
Scallops	HI	3½-5 minutes	Arrange in a single layer. Prepare as directed above, except stir instead of turning the shellfish.
Shrimp, shelled	HI	3½-5 minutes	



Operating Instructions

APPETIZERS/SAUCES/ SOUPS

Cooking Appetizers: Tips and Techniques Recommended

- Crisp crackers, such as melba toast, shredded wheat, and crisp rye crackers are best for microwave use. Wait until party time to add the spreads. Place a paper towel under the crackers while they cook in the microwave oven to absorb extra moisture.
- Arrange individual appetizers in a circle for even cooking.
- Stir dips to distribute heat and shorten cooking time.

Cooking Sauces: Tips and Techniques

- Use a microwavable casserole or glass measuring cup that is at least 2 or 3 times the volume of the sauce.
- Sauces made with cornstarch thicken more rapidly than those made with flour.
- Cook sauces made with cornstarch or flour uncovered so you may stir them 2 or 3 times during cooking for a smooth consistency.
- To adapt a conventional sauce or gravy recipe, reduce the amount of liquid slightly.

Cooking Soups: Tips and Techniques

- Cook soups in a microwavable dish which holds double the volume of the recipe ingredients to prevent boil-over, especially if you use cream or milk in the soup.
- Generally, cover microwaved soups with VENTED plastic wrap or a microwavable lid.
- Cover foods to retain moisture. Uncover foods to retain crispness.
- Avoid overcooking by using the minimum suggested time. Add more time, if necessary, only after checking the food.

- Stirring occasionally will help blend flavors, distribute heat evenly, and may even shorten the cooking time.
- When converting a conventional soup recipe to cook in the microwave, reduce the liquid, salt, and strong seasonings.

Not Recommended

- Appetizers with a crisp coating or puff pastry are best done in a conventional oven with dry heat.
- Breaded products can be warmed in the microwave oven but will not come out crisp.

MEAT

Cooking Meat: General Directions

- Prepare the meat for cooking.
 - Defrost completely.
 - Trim off excess fat to avoid spattering.
 - Place the meat, fat side down, on a microwavable rack in a microwavable dish.
 - Use oven cooking bag for less tender cuts of meat.
 - Arrange the meat so that thicker portions are toward the outside of the dish.
 - Cover the meat with waxed paper to prevent spattering.

- Tend the meat as it cooks.
 - Drain juices as they accumulate to reduce spattering and keep from overcooking the bottom of the meat.
 - Shield thin or bony portions with strips of foil to prevent overcooking.

NOTE:

- Keep the foil **at least 1 inch** from the oven walls, and do not cover more than one-third of the meat with foil at any one time.

- Let the meat stand covered with foil 10-15 minutes after you remove it from the oven. The internal temperature of the meat may rise from 5-10° F during standing time.

The Meat Cooking Table on the next page provides detailed directions, Power Level, and Cooking Time settings for most cuts of meat.



Operating Instructions

MEAT COOKING TABLE

MEAT	POWER LEVEL	COOKING TIME	DIRECTIONS
BEEF Hamburgers, Fresh or defrosted (4 oz. each) 1 patty 2 patties 4 patties	HI	1-1½ minutes 1½-2 minutes 2½-3½ minutes	Form patties with depression in center of each. Place on microwavable roasting rack. Brush with browning agent, if desired. Cover with waxed paper. Turn over halfway through cooking. Let stand covered 1 minute.
Sirloin tip roast (3-4 lbs.)	5	8-10 minutes per pound RARE (135°F) 11-13 minutes per pound MEDIUM (155°F)	Place roast fat side down on microwavable roasting rack. Add desired seasonings and cover with waxed paper. Turn meat over halfway through cooking and shield if necessary. Remove roast from microwave oven when desired temperature is reached. Let stand covered with foil 15 minutes. (Temperature may rise about 10°F).
LAMB Lamb roast, rolled boneless (3-4 lbs.)	5	11-12 minutes per pound RARE (135°F) 12-13 minutes per pound MEDIUM (145°F) 13-14 minutes per pound WELL (155°F)	Place roast fat side down on microwavable roasting rack. Brush lamb with marinade or desired seasonings such as rosemary, thyme or marjoram. Cover with waxed paper. Turn roast over after 15 minutes, and again after 30 minutes. Shield if necessary. Remove roast from microwave when desired temperature is reached. Let stand covered with foil 15 minutes. (Temperature may rise about 10°F).
PORK Bacon slices 2 slices 4 slices 6 slices 10 slices	HI	1½-2 minutes 2-3 minutes 4-5 minutes 7-8 minutes	Place bacon slices on microwavable roasting rack. Cover with paper towels. Place microwavable roasting rack on the metal oven rack. After cooking, let stand 1 minute.
Chops (5-7 oz. each) 2 chops 4 chops	3	18-20 minutes per pound 15-17 minutes per pound	Place chops in microwavable baking dish. Add desired seasonings and cover with vented plastic wrap. Cook until no longer pink or until internal temperature reaches 170° F. Turn chops over halfway through cooking. Let stand covered 5 minutes. (Temperature may rise about 10°F).
Loin Roast, rolled, boneless (3½- 4½ lbs.)	3	25-27 minutes per pound	Place roast in cooking bag in microwavable dish. Add seasonings and browning agent if desired. Close bag loosely with microwavable closure or string. After cooking, let stand in bag 15 minutes. (Temperature may rise about 10°F.) Internal temperature of pork should reach 170°F before serving.
Sausage links, Fresh or Frozen, defrosted (1-2 oz. each) 2 links 4 links 6 links 10 links	HI	45-60 seconds 1-1½ minutes 1½-2 minutes 1¾-2 minutes	Pierce links and place on microwavable roasting rack. Cover with waxed paper or paper towel. Turn over halfway through cooking. After cooking, let stand covered 1 minute.



Operating Instructions

POULTRY

Cooking Poultry: General Directions

- Prepare the poultry for cooking.
- Defrost completely.
- Arrange poultry pieces with thicker pieces at the outside edge of the baking dish. When cooking legs, arrange them like the spokes of a wheel.
- Cover the baking dish with waxed paper to reduce spattering.
- Use a browning agent or cook with a sauce to give a browned appearance.

- Watch the poultry as it cooks.
- Drain and discard juices as they accumulate.
- Shield thin or bony pieces with small strips of aluminum foil to prevent overcooking. Keep foil at least 1 inch from the oven walls and other pieces of foil.
- Poultry is done when it is no longer pink and the juices run clear. When done, the temperature in the thigh meat should be 180-185°F.
- Let the poultry stand after cooking covered with foil for 10 minutes.

The Poultry Cooking Table below provides detailed directions, Power Level, and Cooking Time settings for most cuts and types of poultry.

POULTRY COOKING TABLE

POULTRY	POWER LEVEL	COOKING TIME	DIRECTIONS
Chicken pieces (2½-3 lbs.)	HI	4½-5½ minutes per pound	Before cooking, wash pieces and shake the water off. Place pieces in a single layer in a microwavable baking dish with thicker pieces to the outside. Brush with butter or browning agent and seasonings if desired. Cover with waxed paper. Cook until no longer pink and juices run clear. Let stand covered 5 minutes.
Chicken whole (3-3½ lbs.)	HI	12-13 minutes per pound	Before cooking, wash and shake off water. Place breast side down on a microwavable roasting rack. Brush with butter, or browning agent and seasoning if desired. Cover with waxed paper. Cook ⅓ of estimated time. Turn breast side up, brush with butter, or browning agent. Replace waxed paper. Cook ⅓ of estimated time again. Shield if necessary. Cook remaining ⅓ of estimated time or until no longer pink and juices run clear. Let stand covered with foil 10 minutes. (The temperature may rise about 10°F.) The temperature in the thigh should be 180°F-185°F when the poultry is done.
Cornish Hens whole (1-1½ lbs. each)	HI	6-7 minutes per pound	Before cooking, wash and shake the water off. Tie wings to body of hen and the legs to tail. Place hens breast side down on microwavable rack. Cover with waxed paper. Turn breast side up halfway through cooking. Shield bone ends of drumsticks with foil. Remove and discard drippings. Brush with butter or browning agent and seasonings if desired. Cook until no longer pink and juices run clear. Remove hens from microwave when they reach desired temperature. Let stand covered with foil 5 minutes. (Temperature may rise about 10°F). Temperature in breast should be 170°F before serving.



Operating Instructions

PASTA AND RICE

Microwave cooking and conventional cooking of pasta, rice, and cereal require about the same amount of time, but the microwave is a more convenient method because you can cook and serve in the same dish. There is no stirring needed and leftover pasta tastes just like fresh cooked when reheated in the microwave oven.

Cooking Pasta and Rice: Tips and Techniques

- If you are planning to use rice or pasta in a casserole, undercook it so it is still firm.
- Allow for standing time with rice, but not for pasta.
- The Pasta and Rice Cooking Tables below provide specific directions, with Power Level and cooking time settings for most common types of pasta and rice.

PASTA COOKING TABLE

PASTA	POWER LEVEL	COOKING TIME	DIRECTIONS
Spaghetti 4 cups water Add 8 ozs. spaghetti	HI 5	9-10 minutes 7½-8½ minutes	Combine hot tap water and salt, if desired. Use a 2-quart microwavable baking dish and cover with vented plastic wrap for spaghetti and lasagna noodles. Use microwavable lid or vented plastic wrap for macaroni and egg noodles. Cook as directed in chart or until water boils. Stir in pasta; cook covered as directed in chart or until tender. Drain in a colander.
Macaroni 3 cups water Add 2 cups macaroni	HI 5	6-7 minutes 5½-6½ minutes	
Lasagna noodles 4 cups water Add 8 ozs. lasagna noodles	HI 5	7-8 minutes 11-12½ minutes	
Egg noodles 6 cups water Add 4 cups noodles	HI 5	8-10 minutes 5½-6½ minutes	

RICE COOKING TABLE

RICE	POWER LEVEL	COOKING TIME	DIRECTIONS
Long grain 2¼ cups water Add 1 cup rice	HI 3	5-7 minutes 19 minutes	Combine hot tap water and salt, if desired, in 2 quart microwavable casserole. Cover with microwavable lid or vented plastic wrap. Cook as directed in chart or until water boils. Stir in rice and any seasonings. Cook covered as directed in chart or until water is absorbed and rice is tender. Let stand covered 5 to 10 minutes. Fluff with fork.
Brown 2½ cups water Add 1 cup rice	HI 3	4½-5½ minutes 28 minutes	
Long grain and wild rice mix 2½ cups water Add 6 oz. package	HI 3	4-5 minutes 24 minutes	
Quick cooking 1 cup water Add 1 cup rice	HI	2-3 minutes	

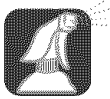

Care and Cleaning

CARE AND CLEANING

For best performance and safety, keep the oven clean inside and outside. Take special care to keep the inner door panel and the oven front frame free of food or grease build-up. **Never use rough powder or pads.** Wipe the microwave oven inside and out, including the hood bottom cover, with a soft cloth and a warm (not hot) mild detergent solution. Then rinse and wipe dry. Use a chrome cleaner and polish on chrome, metal and aluminum surfaces. Wipe spatters immediately with a wet paper towel, especially after cooking chicken or bacon. Clean your oven weekly or more often, if needed.

CLEANING THE GREASE FILTER

CAUTION

To avoid risk of personal injury or property damage, do not operate oven hood without filters in place.

The grease filter should be removed and cleaned often, at least once a month.

1. To remove grease filter, slide filter to the side. Pull filter downward and push to the other side. The filter will drop out.

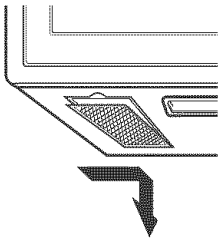

2. Soak grease filter in hot water and a mild detergent. Rinse well and shake to dry. **Do not use ammonia or place in a dishwasher. The aluminum will darken.**

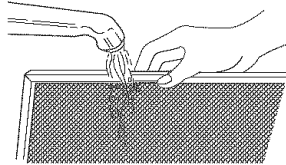

3. To reinstall the filter, slide it into the side slot, then push up and toward oven center to lock.

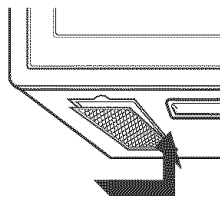

4. Push the right side lower part of the charcoal filter.

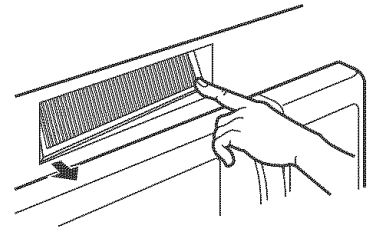

5. Remove old filter.

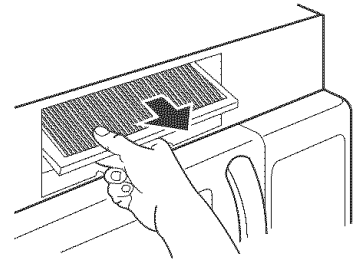

6. Slide a new charcoal filter into place. The filter should rest at the angle shown.

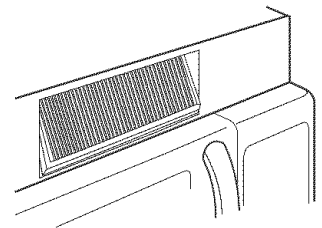

CHARCOAL FILTER REPLACEMENT

If your oven is vented inside, the charcoal filter should be replaced every 6 to 12 months, and more often if necessary. The charcoal filter cannot be cleaned. To order a new charcoal filter, contact the Parts Department at your nearest Authorized Service Center or call **1-800-688-9900** (inside U.S.A) or **1-800-688-2002** (Canada).

Order Charcoal Filter kit #: MVHRK5.

1. Unplug oven or turn off power at the main power supply.
2. Remove the two vent grille mounting screws. (2 outer screws)
3. Tip the grille forward, then lift it out.

7. Slide the bottom of the grille into place. Push the top until it snaps into place. Replace the mounting screws. Turn the power back on at the main power supply and set the clock.

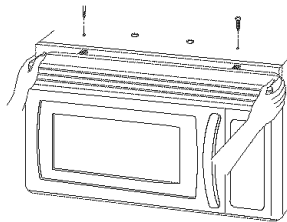



Care and Cleaning

COOKTOP/NIGHT LIGHT REPLACEMENT

CAUTION

To avoid personal injury or property damage, wear gloves when replacing light bulb.

1. Unplug the oven or turn off power at the main power supply.
2. Remove the bulb cover mounting screws.

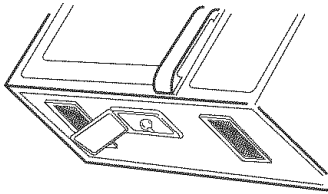

3. Replace bulb with 30 or 40 watt appliance bulb.
4. Replace bulb cover, and mounting screws.
5. Turn the power back on at the main power supply.

OVEN LIGHT REPLACEMENT

1. Unplug oven or turn off power at the main power supply.
2. Remove the vent cover mounting screws. (2 outer screws)
3. Tip the cover forward, then lift out to remove.

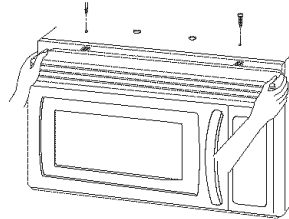

4. Push the hook.

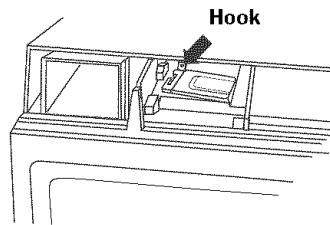

5. Lift up the bulb holder.

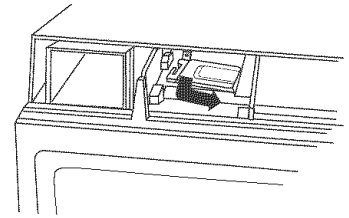

6. Replace bulb with a 30 or 40 watt appliance bulb.
7. Replace the bulb holder.
8. Slide the bottom of the vent cover into place. Push the top until it snaps into place. Replace the mounting screws. Turn the power back on at the main power supply.



Cooking Utensils

MICROWAVE UTENSIL GUIDE

USE	DO NOT USE
<p>OVENPROOF GLASS (treated for high intensity heat): Utility dishes, loaf dishes, pie plates, cake plates, liquid measuring cups, casseroles and bowls without metallic trim.</p> <p>CHINA: Bowls, cups, serving plates and platters without metallic trim.</p> <p>PLASTIC: Plastic wrap (as a cover) -- lay the plastic wrap loosely over the dish and press it to the sides. Vent plastic wrap by turning back one edge slightly to allow excess steam to escape. The dish should be deep enough so that the plastic wrap will not touch the food. As the food heats it may melt the plastic wrap wherever the wrap touches the food. Use plastic dishes, cups, semirigid freezer containers and plastic bags only for short cooking times. Use these with care because the plastic may soften from the heat of the food.</p> <p>PAPER: Paper towels, waxed paper, paper napkins, and paper plates with no metallic trim or design. Look for the manufacturer's label for use in the microwave oven.</p>	<p>METAL UTENSILS: Metal shields the food from microwave energy and produces uneven cooking. Also avoid metal skewers, thermometers or foil trays. Metal utensils can cause arcing, which can damage your microwave oven.</p> <p>METAL DECORATION: Metal-trimmed or metal-banded dinnerware, casserole dishes, etc. The metal trim interferes with normal cooking and may damage the oven.</p> <p>ALUMINUM FOIL: Avoid large sheets of aluminum foil because they hinder cooking and may cause harmful arcing. Use small pieces of foil to shield poultry legs and wings. Keep ALL aluminum foil at least 1 inch from the side walls and door of the oven.</p> <p>WOOD: Wooden bowls and boards will dry out and may split or crack when you use them in the microwave oven. Baskets react in the same way.</p> <p>TIGHTLY COVERED UTENSILS: Be sure to leave openings for steam to escape from covered utensils. Pierce plastic pouches of vegetables or other food items before cooking. Tightly closed pouches could explode.</p> <p>BROWN PAPER: Avoid using brown paper bags. They absorb too much heat and could burn.</p> <p>FLAWED OR CHIPPED UTENSILS: Any utensil that is cracked, flawed, or chipped may break in the oven.</p> <p>METAL TWIST TIES: Remove metal twist ties from plastic or paper bags. They become hot and could cause a fire.</p>



Troubleshooting

Check the following list to be sure a service call is necessary. Reviewing additional information on items to check may prevent an unneeded service call.

PROBLEM	POSSIBLE CAUSES
If nothing on the oven operates	<ul style="list-style-type: none">• check for a blown circuit fuse or a tripped main circuit breaker.• check if oven is properly connected to electric circuit in house.• check that controls are set properly.
If the oven interior light does not work	<ul style="list-style-type: none">• the light bulb is loose or defective.
If oven will not cook	<ul style="list-style-type: none">• check that control panel was programmed correctly.• check that door is firmly closed.• check that Enter/Start pad was touched.• check that timer wasn't started instead of a cooking function.
If oven takes longer than normal to cook or cooks too rapidly	<ul style="list-style-type: none">• be sure the Power Level is programmed properly.
If the time of day clock does not always keep correct time	<ul style="list-style-type: none">• check that the power cord is fully inserted into the outlet receptacle.• be sure the oven is the only appliance on the electrical circuit.
If food cooks unevenly	<ul style="list-style-type: none">• be sure food is evenly shaped.• be sure food is completely defrosted before cooking.• check placement of aluminum foil strips used to prevent overcooking.
If food is undercooked	<ul style="list-style-type: none">• check recipe to be sure all directions (amount, time, and power levels) were correctly followed.• be sure microwave oven is on a separate circuit.• be sure food is completely defrosted before cooking.
If food is overcooked	<ul style="list-style-type: none">• check recipe to be sure all directions (amount, power level, time, size of dish) were followed.
If arcing (sparks) occur	<ul style="list-style-type: none">• be sure microwavable dishes were used.• be sure wire twist ties were not used.• be sure oven was not operated when empty.• make sure metal rack (if used) is properly installed on 4 supports.
If the display shows a time counting down but the oven is not cooking	<ul style="list-style-type: none">• check that door is firmly closed.• check that timer was not started instead of a cooking function.
Vent fan starts automatically	<ul style="list-style-type: none">• if the temperature gets too hot around the microwave oven, the fan in the vent hood will automatically turn on to cool the oven. It may stay on up to an hour to cool the oven.



Troubleshooting

WARNING

To avoid electrical shock which can cause severe personal injury or death, do not remove outer case at any time, only an authorized servicer should remove outer case.

QUESTIONS AND ANSWERS

QUESTION	ANSWER
Can I use a rack in my microwave oven so that I may reheat or cook in two rack positions at a time?	Only use the rack that is supplied with your microwave oven. Use of any other rack can result in poor cooking performance and/or arcing and may damage your oven.
Can I use either metal or aluminum pans in my microwave oven?	Usable metal includes aluminum foil for shielding (use small, flat pieces). Never allow metal to touch walls or door.
Sometimes the door of my microwave oven appears wavy. Is this normal?	This appearance is normal and does not affect the operation of your oven.
What are the humming noises I hear when my microwave oven is operating?	This is the sound of the transformer when the magnetron tube cycles on and off.
Why does the dish become hot when I microwave food in it?	As the food becomes hot it will conduct the heat to the dish. Use hot pads to remove food after cooking. Dish may not be microwave safe.
What does standing time mean?	Standing time means that food should be taken out of the oven and covered for additional time after cooking. This process allows the cooking to finish, saves energy, and frees the oven for other purposes.
Can I pop popcorn in my microwave oven? How do I get the best results?	Yes. Pop packaged microwave popcorn following manufacturer's guidelines or use the preprogrammed Popcorn pad. Do not use regular paper bags. Use the listening test by stopping the oven as soon as the popping slows to a pop every one or two seconds. Do not try to repop unpopped kernels. You can also use special microwave poppers. When using a popper, be sure to follow manufacturer's directions. Do not pop popcorn in glass utensils.
Why does steam come out of the air exhaust vent?	Steam is normally produced during cooking. The microwave oven has been designed to vent this steam out the vent.



Warranty

Full One Year

Maytag will repair or replace, including related labor, any part which proves defective as to workmanship or materials.

Limited Warranty

After one year from the date of original retail purchase, Maytag will provide a free part, as listed below, to replace any part that fails due to a defect in materials or workmanship. The owner will be responsible for paying all other costs including mileage, transportation, trip and diagnostic charges, if required.

Second through Fifth Year

Maytag will provide replacement magnetron, touch pad and microprocessor, part and labor, which proves defective as to workmanship or materials.

Limited Parts Warranty Outside the United States and Canada

For one (1) year from the date of original retail purchase, any part which fails in normal home use will be repaired or replaced free of charge for the part itself, with the owner paying all other costs, including labor, mileage, transportation, trip and diagnostic charges, if required.

Canadian Residents

This warranty covers only those appliances installed in Canada that have been listed with Canadian Standards Association unless the appliances are brought into Canada due to transfer or residence from the United States to Canada.

What is not covered by these warranties

- Replacement of household fuses, resetting of circuit breakers, or correction to household wiring or plumbing.
- Normal product maintenance and cleaning, including light bulbs.
- Products with original serial numbers removed, altered, or not readily determined.
- Products purchased for commercial, industrial, rental, or leased use.
- Products located outside of the United States or Canada.
- Premium service charges, if the servicer is requested to perform service in addition to normal service or outside normal service hours or area.
- Adjustments after the first year.
- Repairs resulting from the following:
 - Improper installation, exhaust system, or maintenance.
 - Any modification, alteration, or adjustment not authorized by the manufacturer.
 - Accident, misuse, abuse, fire, flood, or acts of nature.
 - Connections to improper electrical current, voltage supply, or gas supply.
 - Use of improper pans, containers, or accessories that cause damage to the product.
- Travel.

If you need service

- Call the dealer from whom your appliance was purchased or call Maytag ServicesSM, Maytag Customer Assistance at **1-800-688-9900**, USA and **1-800-688-2002**, Canada to locate an authorized servicer.
- Be sure to retain proof of purchase to verify warranty status. Refer to WARRANTY for further information on owner's responsibilities for warranty service.
- If the dealer or service company cannot resolve the problem, write to Maytag ServicesSM, Attn: CAIR[®] Center, P.O. Box 2370, Cleveland, TN 37320-2370, or call **1-800-688-9900** USA and **1-800-688-2002** Canada. U.S. customers using TTY for deaf, hearing impaired or speech impaired, call **1-800-688-2080**.

NOTE:

- When writing or calling about a service problem, please include the following information:
 - a. Your name, address and telephone number;
 - b. Model number and serial number;
 - c. Name and address of your dealer or servicer;
 - d. A clear description of the problem you are having;
 - e. Proof of purchase (sales receipt).

- User's guides, service manuals and parts information are available from Maytag ServicesSM, Maytag Customer Assistance.

IN NO EVENT SHALL MAYTAG BE LIABLE FOR INCIDENTAL OR CONSEQUENTIAL DAMAGES.

This warranty gives you specific legal rights, and you may have others which vary from state to state. For example, some states do not allow the exclusion or limitation of incidental or consequential damages, so this exclusion may not apply to you.