

Owner's Manual

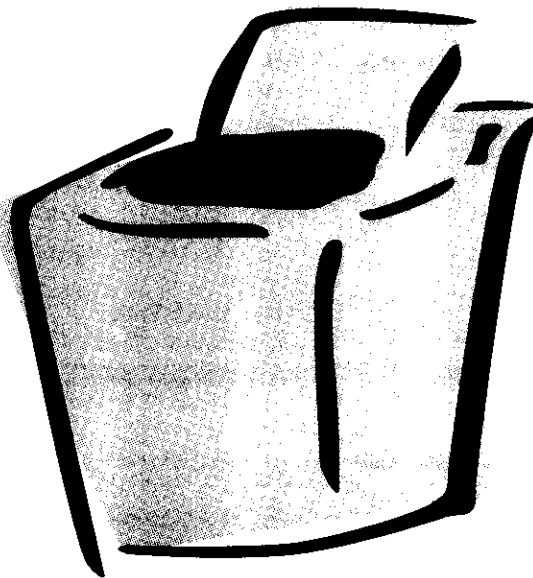

Top Loading Washer

Keep instructions for future reference. Be sure manual stays with washer.

Contents	
Important Safety Information	3
Starting the Wash	4
Cycles	6
Dispensers	7
Features, Hints, and Care	8
Moving and Storage	9
Trouble Shooting	10
Warranty	12

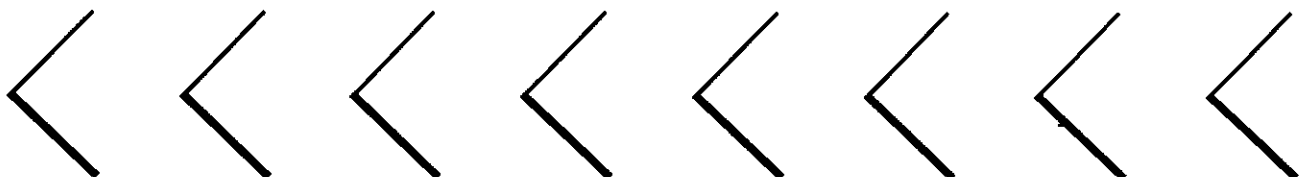

Thank you for buying an Amana washer!

Please take the time to complete the registration card and return promptly. If registration card is missing, call Amana Consumer Affairs Department. When contacting Amana, provide product information from serial plate found on lower right hand corner of inner lid:

Model Number _____
Manufacturing (P) Number _____
Serial Number (S/N) _____
Purchase Date _____
Dealer Name _____
Dealer Address _____
Dealer Phone _____

Keep this manual and your sales receipt together in a safe place for future reference or if warranty service is required.

For answers to questions or to locate an authorized servicer, call 1-800-NAT-LSVC (1-800-628-5782) inside USA or 319-622-5511 outside USA. Warranty service must be performed by an authorized servicer. Amana Appliances also recommends contacting an authorized servicer if service is required after warranty expires.

Asure™ Extended Service Plan

Amana Appliances offers long-term service protection for this new washer. Asure™ Extended Service Plan, covering functional parts, labor, and travel charges, is specially designed to supplement a strong warranty. Call 1-800-528-2682 for information.

Parts and Accessories

Purchase replacement parts and additional accessories by phone. To order accessories for your Amana product, call 1-800-843-0304 inside USA or 319-622-5511 outside USA.

Save Time and Money

If something seems unusual, please check "Trouble Shooting" section, which is designed to help you solve problems before calling service. If you have a question, write or call us (include model number and phone number) at:

Consumer Affairs Department Amana Appliances
2800 - 220th Trail
Amana, Iowa 52204
Ph# 1-800-843-0304

For more information on this and other Amana products, visit our Web site

www.amana.com

or

call Consumer Affairs Department at

1-800-843-0304

What You Need to Know about Safety Instructions

Warning and Important Safety Instructions appearing in this manual are not meant to cover all possible conditions and situations that may occur. Common sense, caution, and care must be exercised when installing, maintaining, or operating washer. Always contact your dealer, distributor, service agent, or manufacturer about problems or conditions you do not understand.

Recognize Safety Symbols, Words, Labels



DANGER—Immediate hazards which **WILL** result in severe personal injury or death.



WARNING—Hazards or unsafe practices which **COULD** result in severe personal injury or death.



CAUTION—Hazards or unsafe practices which **COULD** result in minor personal injury or product or property damage.

Important Safety Information



WARNING

To reduce risk of fire, electric shock, serious injury, or death when using your washer, follow these basic precautions:

1. Read all instructions before using washer.
2. Be sure washer is properly grounded.
3. Do not wash articles that have been cleaned in, washed in, soaked in, or spotted with gasoline, dry-cleaning solvents, or other flammable or explosive substances. Vapors could ignite or explode.
4. Do not add gasoline, dry-cleaning solvents, or other flammable or explosive substances to wash water. Vapors could ignite or explode.
5. Do not store or use gasoline or other flammable vapors and liquids near this or any other appliance.
6. Do not allow children to play on or in washer. Close supervision of children is necessary when washer is used near children, a safety rule for all appliances.
7. Before washer is removed from service or discarded, remove door to washing compartment.
8. Do not reach into washer if wash tub is moving.
9. Do not install or store washer where it will be exposed to water and/or weather.
10. Do not tamper with washer controls.
11. Do not repair or replace any part of washer or attempt any service, unless specifically recommended in user-maintenance instructions or in published user-repair instructions that you understand and have skills to carry out.
12. To reduce risk of electric shock or fire, do not use extension cords or adapters to connect washer to electrical power source.
13. Use your washer only for its intended purpose: non-commercial clothes washing.
14. Always disconnect washer from electrical supply before attempting any service. Disconnect power cord by grasping the plug, not the cord.
15. Install washer according to Installation Instructions. All connections for water, drain, electrical power, and grounding must comply with local codes and be made by licensed personnel when required.
16. To reduce risk of fire, do not use washer to launder clothes which have traces of any flammable substance, such as vegetable oil, cooking oil, machine oil, flammable chemicals, thinner, etc., or anything containing wax or chemicals, such as mops and cleaning cloths. Flammable substances may cause fabric to catch fire by itself.
17. Use only fabric softeners or products to eliminate static that are appropriate for automatic washers.
18. Keep your washer in good condition. Bumping or dropping washer can damage safety features. If damage occurs, have washer checked by qualified service technician.
19. Replace worn power cords and/or loose plugs.
20. Loading door must be closed whenever washer is agitating or spinning. Do not bypass loading door switch by permitting washer to operate with loading door open.
21. Always read and follow manufacturer's instructions on packages of laundry and cleaning aids. Heed all warnings or precautions. To reduce risk of poisoning or chemical burns, keep products away from children at all times, preferably, in a locked cabinet.
22. Never operate washer with guards and/or panels removed.
23. Do not operate washer with missing or broken parts.
24. Do not bypass safety devices.

Save These Instructions

Starting the Wash

If These Controls are Different from Yours

These controls are intended to show the variety of features that are available in the product line. If your washer does not have all the options that are shown, it is not a mistake. The information provided applies to several of the models in the product line.

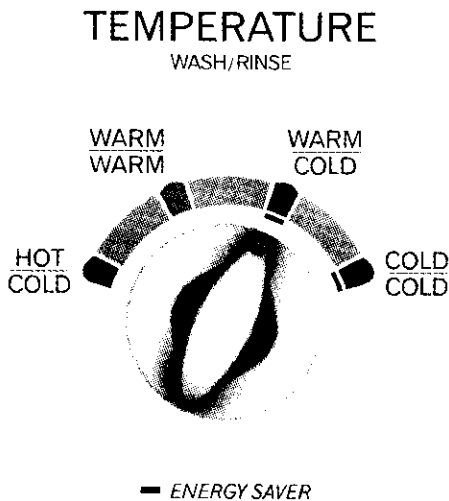

1. Prepare clothes for washing

For best wash results:

- Remove items from pockets and cuffs
- Close zippers and fasteners; mend rips and tears
- Sort items into separate loads
- Pre-treat stains and heavily soiled areas

2. Select WASH/RINSE temperature

Always follow garment manufacturer's care labels for each fabric. See chart below.

WASH / RINSE	TYPE OF CLOTHING
Hot/Cold	Sturdy whites and colorfast items; work clothes, soiled items, and cloth diapers
Warm/Warm Available on some models	Delicate or colorfast items
Warm/Cold –	Moderately soiled permanent press, silks, woolens, nylon, acrylic Rinsing of some items
Cold/Cold –	Non-colorfast items Extra-delicate clothing Rinsing of most items

NOTE: Energy Saver settings, marked with a dash (–), show temperature settings that use the least energy.

LOAD SIZE WATER LEVEL

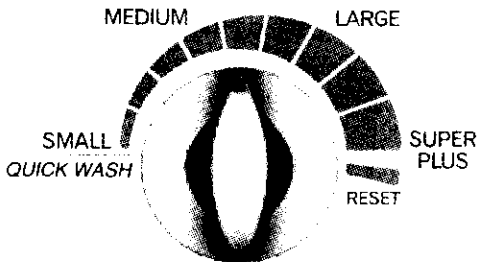

3. Select LOAD SIZE / WATER LEVEL

Variable control allows you to select the most appropriate setting for each wash load. Do not fill above top row of holes in tub with clothes. Use Water Level chart below to determine setting.

IMPORTANT: Do not hold knob at RESET for extended periods or washer flooding may result.

LOAD SIZE	WATER LEVEL
Super Plus	Max. Fill
Large	3/4 – Full
Medium	1/2 – 3/4 Full
Small QUICK WASH	1/2 Full

If you change your mind and the LOAD SIZE SETTING

If the tub is filling and you decide to change the LOAD SIZE SETTING, you must turn the knob to RESET before changing the load size. The tub can overflow if you do not turn to RESET first.

Starting the Wash (cont'd)

4. Select WASH/SPIN speed

Select wash/spin speed most appropriate to type of fabric in wash load. See chart below.

WASH/SPIN SPEED	LOAD TYPE
Regular/Fast	Sturdy fabrics needing maximum water extraction
Regular/Slow	Sturdy fabrics needing slower spin speed to reduce wrinkling
Gentle/Fast	Heavy loads of delicate fabrics needing fast spin for better water extraction
Gentle/Slow	Delicate fabrics needing slower spin to protect fabric and clothing

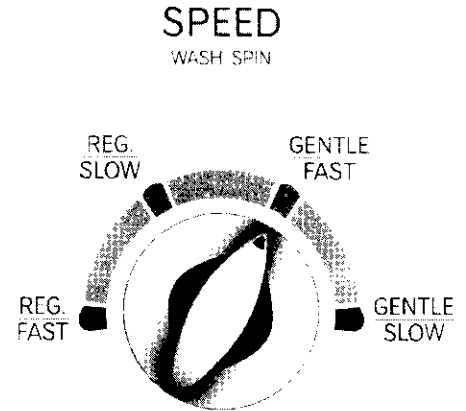

5. Select wash cycle and time

Push timer knob in and turn to desired cycle and wash time. Timer knob can be turned in either direction. Wash cycle and time selection depends upon type of fabric and amount of soil. For best results when cleaning heavily soiled items, use longer wash time, up to 15 minute maximum. Lightly soiled items require less wash time. See "Cycles" section for more information.

6. Select EXTRA RINSE, if desired

EXTRA RINSE is useful for people with detergent sensitive skin. It provides a second rinse to more completely remove laundry additives, suds, and perfumes in REGULAR, PERMANENT PRESS/KNITS, and DELICATE cycles. To select, set switch to ON. Set switch to OFF if not desired. EXTRA RINSE adds 10–15 minutes to total cycle time.

EXTRA RINSE



EXTRA SPIN (some models) should be used when washing heavier items, like towels, that retain water. The extra spin extracts additional water from the clothing and shortens drying times. To select, set switch to ON. Set switch to OFF if not desired. EXTRA SPIN adds approximately 3 minutes to your total wash time.

7. Pull OUT timer knob to start

Water fill begins. Stop washer by pushing knob in.

Measure and add detergent to washtub

Use only detergent recommended for top-loading washers.

Add clothing to water in washtub

- Clothes should fill wash tub but should not be packed. Loosely fill tub with clothes no higher than top row of holes. Items must move freely through wash/rinse water.
- Bulky fabrics may need more water added after agitation begins. Turn Load Size knob to RESET and back to desired setting.

Close washer lid

Washer will not operate when lid is open.

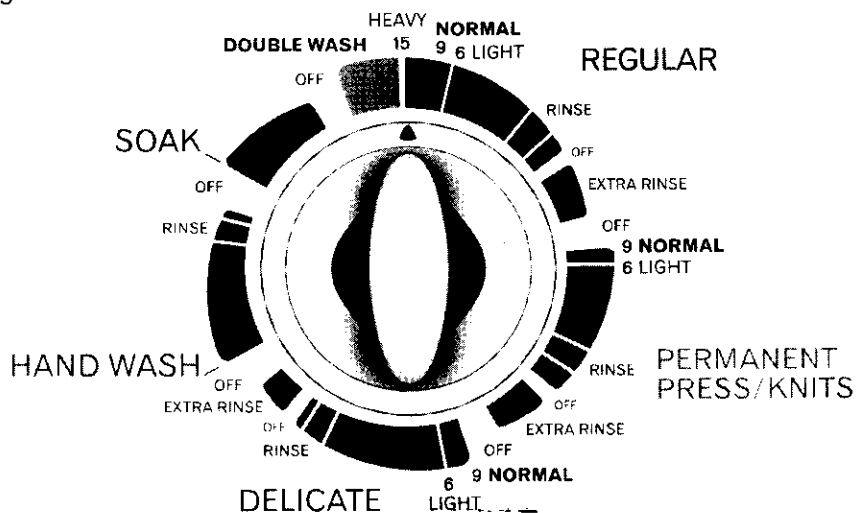

PULL KNOB TO START · PUSH TO STOP

Cycles

If These Controls are Different from Yours

These controls are intended to show the variety of features that are available in the product line. If your washer does not have all the options that are shown, it is not a mistake. The information provided applies to several of the models in the product line.

What do the little numbers mean?

Numbers next to cycle setting shows the approximate total agitation time. The total wash time includes periods of soaking and is longer than the agitation time.

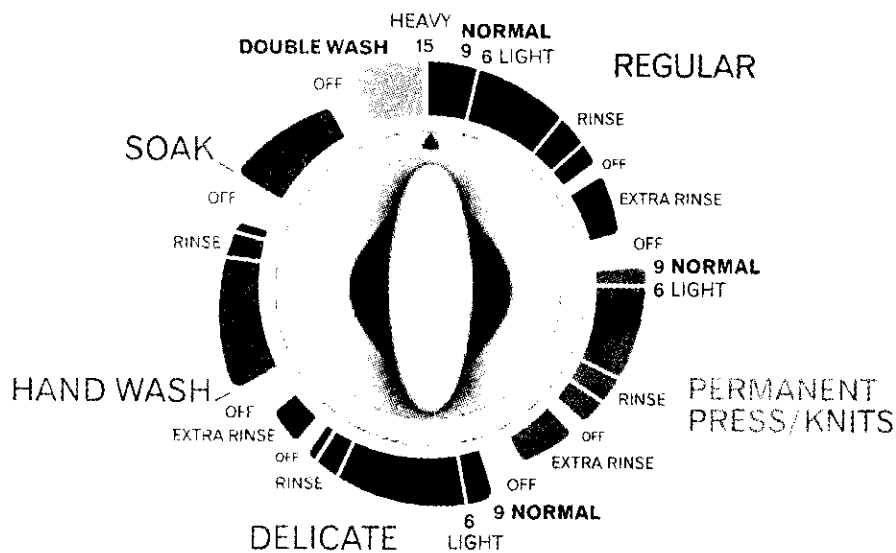

PULL KNOB TO START · PUSH TO STOP

QUICK WASH (SOME MODELS)

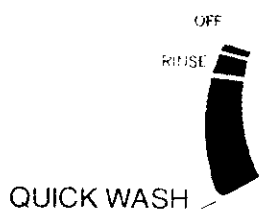

Use for a small load of lightly soiled items that needs to be washed quickly. QUICK WASH has a shortened cycle with a light period of agitation. It then automatically sets to a fast spin speed to help shorten drying times. The total cycle time is approximately 15-20 minutes.

SOAK (SOME MODELS)

Use for heavily soiled or stained items. Washtub fills with water, pauses approximately 12 minutes for soaking, and spins water out to complete cycle.

HAND WASH (SOME MODELS)

Use for fine fabrics normally washed by hand. To protect fragile fabrics, washer speed automatically runs at Gentle/Slow, regardless of position of speed selector switch.

REGULAR

Use for sturdy items, like play or work clothes, towels, T-shirts, etc.

DOUBLE WASH

DOUBLE WASH automatically advances into the REGULAR wash cycle. Use to wash heavily soiled clothes twice with detergent in each cycle.

To deliver extra detergent,

- LIQUID DETERGENT: place in fabric softener dispenser for use in second wash. *DO NOT use dispenser for fabric softener.*
- POWDER DETERGENT: place extra detergent in tub for use in first wash; recommend approximately 1½ times normal amount.

PERMANENT PRESS/KNITS

Use for clothes that recommend a permanent press cycle and other synthetics.

DELICATE

Use to wash delicate items often washed by hand. Even with small loads, full tub of water is recommended so items can move freely for more complete cleaning. More water also helps reduce fabric wear and wrinkling. To protect delicate fabrics, washer speed automatically runs at Gentle/Slow, regardless of position of speed selector switch.

Dispensers

Bleach Dispenser

Bleach dispenser is located in left front corner under loading door.

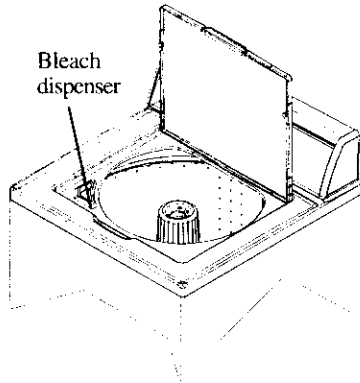

Use only liquid bleach in dispenser. To use powdered bleach, add to wash tub with detergent.

Carefully pour recommended amount of bleach into dispenser during first washer fill. See table.

Be careful not to spill undiluted bleach. It is a strong chemical and can damage cabinet finishes and some fabrics if not properly diluted. Follow bleach manufacturer's label for proper use.

LOAD SIZE	BLEACH (Max Amt.)
SUPER PLUS	1 cup
LARGE	1 cup
MEDIUM	3/4 cup
SMALL	1/2 cup

Fabric Softener Dispenser

Fabric softener dispenser is located on top of agitator. Dispenser automatically releases liquid fabric softener at proper time during rinse cycle.

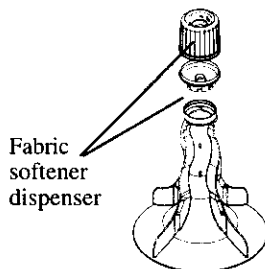

Fabric Softener Use Tips

- Liquid fabric softeners are dispensed during final rinse. Do not combine with bleach, bluing, starch, detergents, soaps, or packaged water conditioners during rinse.
- Do not use fabric softener in dispenser during DOUBLE WASH cycle.
- Do not mix powdered detergent with liquid softener in dispenser or softener will become gummy.

To use dispenser, follow these steps:

1. Pour liquid fabric softener into dispenser, using amount recommended on package.
2. Add water up to fill level, but do not exceed tip of fill arrow indicator. **FABRIC SOFTENER MUST BE DILUTED FOR USE.**
 - Do not stop washer during first spin or dispenser will empty too soon.
 - Never pour fabric softener directly onto clothes or spots and stains may result. To remove softener stains, soak in soapy solution of Sard™ Wonder Soap or Ivory™ soap, or rub stain with bar of Sard™ or Ivory™ soap and wash garment as usual.
 - For best softener performance, set water level to medium or higher.
3. **Clean softener dispenser after each use.** Remove dispenser housing from agitator by squeezing lower part of dispenser and pulling up on housing while tilting slightly to expose dispenser cup. Rinse dispenser housing and cup in hot soapy water.

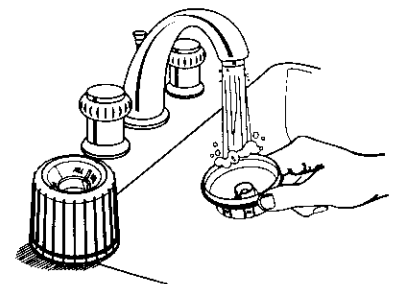

Clean funnel shape in top of agitator and inside of agitator. Use small brush on hole and slots in two funnel rings for thorough cleaning.

After cleaning, re-install dispenser cup. Push dispenser housing directly down onto top of agitator until firmly snapped together.

To prevent build-up, fill dispenser with clean water in wash cycles when not using softener.

Features, Hints, and Care

Follow the Colors

Your washer control panel is color coordinated for your convenience. When you set your wash controls, notice which colors are the same. They will help guide you through setting the controls.

Need more Time? Reset the Timer Knob.

Although wash cycles are automatic, timer may be reset to lengthen, shorten, or repeat a portion of a cycle. To set or reset timer, push in timer knob to stop washer. Hold in timer knob firmly while slowly turning it to desired setting. Pull out timer knob to start washer.

Stops and Starts

Wash action consists of periods of agitation, with pauses or periods of soaking. For best results, do not turn timer through pauses, which are normal part of wash cycles.

Cleaner Clothes

Water temperature affects how clean clothes become. If your clothes are not as clean as you would like, check your water heater temperature. You may need to turn your water temperature up to 140°F. Also, check that your water hoses are hooked up correctly. If they are switched you might be getting cold water in your warm and hot cycles.

Hard water does not remove soil as well as soft water. Check with your local water company to see if you have hard water. If you have hard water, try softening it with a packaged conditioner or use a little more detergent.

Risers

Risers or air cushions may be installed if pipes knock or pound when flow of water stops. Risers are more efficient when installed as close as possible to water supply faucets.

Lint Filter

Amana's self cleaning lint filter works throughout the wash cycle to constantly remove lint and other residue from the water. Located between the outer and inner tub, the lint filter removes lint as water passes from the bottom of the outer tub back to the inner tub. As water passes from the outer tub to the inner tub, water is forced through the bottom of the lint filter. The filter traps lint under the filter until the spin cycle begins. During the spin cycle centrifugal force removes the lint by pulling it off the bottom of the filter and washing it down the drain.

Motor Overload Protector

Internal overload protector automatically stops motor in event of overload. Overload protector resets in approximately 3 minutes and motor automatically restarts. If overload protector stops motor again, stop using washer and call service technician. Loading wash tub too full may result in motor overload.

Automatic Balance System

Your new washer will automatically adjust to unbalanced loads without shutting down or interrupting the cycle. The cycle will automatically complete at the fastest spin speed possible.

In a severe out-of-balance condition, clothes may contain excessive moisture. If this should happen, simply redistribute the clothes, and reset the control to the spin mark after the rinse setting in the regular cycle.



Spin mark

Safety Lid Switch

The washer will not spin when the lid is open for any reason. This is for your personal safety. If the lid is opened mid-cycle, operation will automatically start when lid is closed.

General Washer Care

- Use only damp or sudsy cloth for cleaning control panel. Some cleaning product sprays may harm control panel finish or may damage interior of hood.
- Wipe washer cabinet as needed. If detergent, bleach, or other washing products are spilled on cabinet, wipe immediately. Some products will cause permanent damage if spilled on cabinet.
- Top of washer should not be used for removing garment stains. Some stain removers, such as rust remover, may damage cabinet finish.
- Do not use scouring pads or abrasive cleansers.
- Do not lay sharp or rough objects on or against washer. Finish could be damaged.
- Remove pins, buckles, or other sharp objects from clothes to prevent scratching interior parts.
- Leave lid open after use to allow inside of washer to dry, and to help prevent musty odors from developing.
- Do not allow small children to play on or around washer.
- Do not move washer without reinstalling shipping brace (Part #39365) and shipping plug (Part #38149). See *Moving Washer to New Location* section.

Moving and Storage

Cold Storage and Non-Use Periods

WARNING

Explosive hydrogen gas may be produced in a hot water system that has not been used for two weeks or more. Before using washer, if hot water system has not been used for such a period, turn on all hot water faucets and let water flow for several minutes to release accumulated hydrogen gas. Hydrogen gas is flammable: Do not smoke or use an open flame when flushing water lines.

Cold Weather Care

If washer is delivered when outside temperature is below freezing or if washer is stored in unheated room or area during cold months, **do not operate until washer has warmed to room temperature. Do not install or operate washer where temperatures will drop below freezing.**

Cold Weather Storage

If washer must be stored in seasonal home or storage building, use one of the following storage methods.

METHOD 1

1. Turn off water supply faucets and disconnect hoses. Drain water from both hoses.
2. Add one gallon of non-toxic RV antifreeze (available from hardware or recreational vehicle dealers) to washer tub.
3. Push in cycle selector knob and turn to SPIN.
4. Pull knob out and let washer spin for 1–2 minutes to drain water. Some antifreeze will also be lost. (If you have a septic system, contact antifreeze manufacturer and make sure it will not harm system.)
5. Push in cycle selector knob to stop washer. Dry inner wash tub, disconnect electrical plug, and close washer lid. If moving washer, disconnect drain hose. Move and store washer **ONLY** in upright position. To remove antifreeze after storage, run washer through a complete cycle using ½ cup of detergent. **DO NOT ADD CLOTHES TO CYCLE.**

METHOD 2

1. Push in cycle selector knob and turn to SPIN. Run through complete spin cycle to remove excess water.
2. When spin cycle is complete, push in cycle selector knob to stop washer.
3. Turn off water supply faucets and disconnect hoses. Drain water from both hoses.
4. Dry inner wash tub, disconnect electrical plug, and close washer lid. If moving washer, disconnect drain hose. Move and store washer **ONLY** in upright position.
5. It is normal for some water to remain inside pump. To prevent damage to washer and pump if remaining water freezes, allow washer to warm to 24 to 48 hours after removing from storage, so water can thaw before use.

Vacations and Extended Non-Use

IMPORTANT: To avoid possible property damage from flooding, turn off water supply to washer during extended periods of non-use.

To prevent mold or mildew, leave lid open so moisture inside machine can evaporate.

When closing your home for extended periods, have service technician drain washer to avoid stagnant water.

Unplug cord from electrical outlet.

Disconnect hoses from faucets.

Moving Washer to New Location

Replace shipping plug under motor and shipping brace in tub. Refer to *Installation Instructions* for proper procedures whenever washer is moved. See illustration.

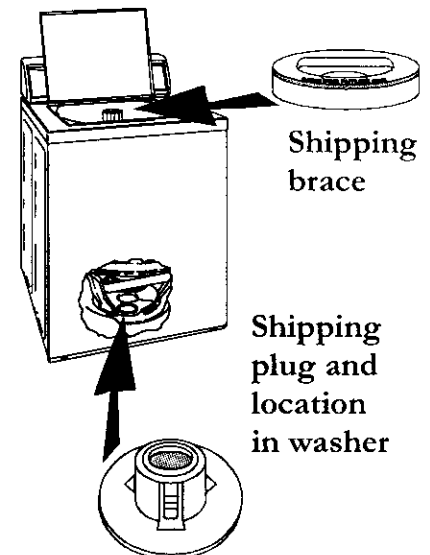

Tilt washer back slightly and slide shipping plug into position under washer



Trouble Shooting

You may save time and money by checking items below before calling for service. List includes common concerns that are not the result of defective workmanship or materials. If your question is not explained below, contact Amana Consumer Affairs Department at **800-843-0304**.

TOPIC POSSIBLE CAUSE SOLUTION

NOISE

Gear sounds or a low hum	Normal mechanical sounds in commercial-quality washer	Normal operation.
Rattling and clanking noise	Loose objects, such as coins or pins, in tub or pump	Stop washer and check tub. Remove loose objects. If noise continues after washer is restarted, objects may be in pump: call your authorized servicer.
	Belt buckles, metal fasteners hitting wash tub	Close zippers, buttons, and fasteners. Clothing with buckles must be turned inside out.
Squealing sound or hot rubber odor	Overloaded wash tub	Do not overload washer. Stop washer and reduce size of load.
Thumping sound	Heavy wash loads; unbalanced loads	Usually normal, but unbalanced loads should be redistributed. Stop washer and rearrange load.
Vibrating noise	Washer not resting firmly on floor	Make sure floor is strong enough for washer. Adjust leveling legs so washer rests firmly on floor. See <i>Installation Instructions</i> for leveling details.
	Wash load distributed unevenly in tub	Stop washer and rearrange load.
	Shipping plug not removed during installation	See <i>Installation Instructions</i> for details on removing shipping plug.
Water splashing or slapping noise	Spray rinse	Normal operation. Washer sprays water inside tub while running at high speed during rinse and spin.
Whistling or whirling noise	Drum spinning without cloths	Normal operation. Holes in the tub can cause this sound.

OPERATION

Washer does not start	Electrical power cord may not be plugged in, or connection may be loose	Make sure plug from power cord fits tightly into wall outlet.
	Fuse blown, circuit breaker tripped, or power outage occurred	Replace fuse or reset circuit breaker. Do NOT increase fuse capacity. Call qualified electrician to correct circuit overload problem. Call local utility company to correct power outage.
	Water supply faucets not turned on	Turn on water supply faucets.
	Timer knob/cycle selector set incorrectly	Move indicator slightly clockwise. Pull out on timer knob.
	Motor overheated	Internal overload protector automatically stops motor in event of overload. Protector resets in approximately 3 minutes and motor automatically restarts. If overload protector stops motor again, quit using washer and call service technician. Do not overload washer. Largest dry load level should not be higher than bottom of fabric softener dispenser or top of agitator.
Washer won't spin	Lid partially open	Close lid completely.
Residue left in tub	Heavily soiled items	Wipe tub with non-abrasive household cleaner and rinse. Before washing, shake or brush excess dirt and sand from items.

Trouble Shooting (cont'd)

TOPIC	POSSIBLE CAUSE	SOLUTION
WATER 		
	Wash load too wet after spin	<p>Overloaded wash tub Do not overload washer.</p> <p>Unbalanced load Rearrange load to allow proper spin.</p> <p>Kinked drain hose Straighten drain hose.</p>
Water enters slowly or does not enter washer	Inadequate main water supply	Check water pressure at another faucet in house. Wait for water supply and pressure to increase.
	Water supply faucets partly closed	Fully open hot and cold water supply faucets.
	Water being used elsewhere in house	Water pressure must be at least 20 psi (138 kPa). Avoid running water elsewhere when washer is filling.
	Clogged water inlet filters	Disconnect water fill hoses from faucet. Clean and reposition screen filters. Reconnect water fill hoses.
	Kinked water inlet hoses	Straighten hoses.
Water level does not cover clothes	Incorrect water level/load size selection	Select higher water level/load size. Add water by turning selector to RESET and back to larger load size.
	Overloaded wash tub	Do not overload washer. Largest dry load level should not be higher than bottom of fabric softener dispenser or top of agitator.
Warm or hot water not hot enough	Water heater temperature set too low; water heater too far from washer	Use candy/meat thermometer to measure hot water temperature at nearby faucet. Water temperature should be at least 140°F (60°C). Adjust water heater as necessary.
	Hot water being used elsewhere in house	Avoid using hot water elsewhere before or during washer use, or there may not be enough hot water for proper cleaning. If problem continues, enlarge capacity of hot water system, or use for only one application at a time.
Water drains slowly or does not drain	Drain hose kinked or clogged	Clean and straighten drain hose.
Water leaks	Loose fill hose connections	Check and tighten all hose/faucet connections. Install rubber sealing washers provided.
	Clogged drain pipes	Unclog drain pipes. Call plumber if necessary.
	Changed water levels during fill	Always use RESET on water level switch when changing water level. Do not hold switch at RESET; return switch to desired load size.
	Oversudsing	Use less detergent.
Incorrect wash and rinse temperatures	Hot and cold water hoses connected to wrong supply faucets	Check hose connections. Connect hot water hose to hot water faucet; connect cold water hose to cold water faucet.
Water enters washer, but tub does not fill	Incorrect standpipe height for drain hose	Recommended standpipe height is 36" (91.44 cm); for low standpipes, install Siphon Break Kit (part #562P3). See <i>Installation Instructions</i> for details.

Amana Washer Warranty

Full ONE Year Warranty

For one (1) year from the date of original retail purchase, Amana will repair or replace any part that fails due to a defect in materials or workmanship.

Limited Warranty

After one year from the date of original retail purchase, Amana will provide a free part, as listed below, to replace any part that fails due to a defect in materials or workmanship. The owner will be responsible for paying all other costs including labor, mileage, and transportation.

Second through Third Year

Amana will provide any part.

Third through Fifth Year

Amana will provide the drive motor or timer.

Third through Tenth Year

Amana will provide the transmission assembly and seal kit.

Amana will provide the outer tub assembly.

Amana will provide the cabinet assembly should the part rust through.

Amana will provide the outer wash tub should the part fail to contain water.

Lifetime

Amana will provide the inner wash basket.

What is not covered by these warranties

- Replacement of household fuses, resetting of circuit breakers, or correction to household wiring or plumbing.
- Products with original serial numbers removed, altered, or not readily determined.
- Products purchased for commercial, industrial, rental, or leased use.
- Products located outside of the United States or Canada.
- Premium service charges, if the servicer is requested to perform service in addition to normal service or outside normal service hours or area.
- Adjustments after the first year.
- Damage to clothing.

Repairs resulting from the following:

- Improper installation or maintenance.
- Any modification, alteration, or adjustment not authorized by Amana.
- Accident, misuse, abuse, fire, flood, or acts of nature.
- Connections to improper electrical current, voltage, or supply.

To Receive Warranty Service

Service must be performed by an authorized Amana service representative. To schedule service, contact the Amana dealer where you purchased your appliance or contact Amana Appliances Factory Service.

Amana Appliances Factory Service

1-800-628-5782 inside USA

For more information,

Amana Appliances Consumer Services

Amana Appliances

2800 220th Trail

Amana, Iowa 52204

1-800-843-0304 inside USA

(319) 622-5511 worldwide

When contacting Amana Appliances please include the following information:

- Your name, address, and telephone number.
- Model number and serial number of your appliance (found on inside of lid in the bottom right corner).
- The name and address of your dealer and the date of purchase.
- A clear description of the problem.
- Proof of purchase (sales receipt).

IN NO EVENT SHALL AMANA BE LIABLE FOR INCIDENTAL OR CONSEQUENTIAL DAMAGES.

This warranty gives you specific legal rights, and you may have others which vary from state to state. For example, some states do not allow the exclusion or limitation of incidental or consequential damages, so this exclusion may not apply to you.

Amana Appliances Online • <http://www.amana.com>