

TOSHIBA



PORTABLE DVD PLAYER **SD-P1400**

OWNER'S MANUAL



Introduction

Basic playback

Advanced
playback

Function setup

Connections

Others

SAFETY PRECAUTIONS

CAUTION: This equipment employs a Laser System.
To ensure proper use of this product, please read this owner's manual carefully and retain for future reference. Should the unit require maintenance, contact an authorized service location - see service procedure.

Use of controls or adjustments or performance of procedures other than those specified herein may result in hazardous radiation exposure.

To prevent direct exposure to laser beam, do not try to open the enclosure.
Visible and invisible laser radiation when open and interlocks defeated.
DO NOT STARE INTO BEAM.



FCC NOTICE "Declaration of Conformity Information"

This equipment has been tested and found to comply with the limits for a Class B digital device, pursuant to part 15 of the FCC Rules. These limits are designed to provide reasonable protection against harmful interference in a residential installation.

This equipment generates, uses and can radiate radio frequency energy and, if not installed and used in accordance with the instructions, may cause harmful interference to radio communications.

However, there is no guarantee that interference will not occur in a particular installation.

If this equipment does cause harmful interference to radio or television reception, which can be determined by turning the equipment off and on, the user is encouraged to try to correct the interference by one or more of the following measures:

- Reorient or relocate the receiving antenna.
- Increase the separation between the equipment and receiver.
- Connect the equipment into an outlet on a circuit different from that to which the receiver is connected.
- Consult the dealer or an experienced radio/TV technician for help.

WARNING: Only peripherals complying with the FCC class B limits may be attached to this equipment. Operation with non-compliant peripherals or peripherals not recommended by Toshiba is likely to result in interference to radio and TV reception.
Changes or modifications made to this equipment, not expressly approved by Toshiba, or parties authorized by Toshiba, could void the user's authority to operate the equipment.

This device complies with part 15 of the FCC Rules. Operation is subject to the following two conditions:

- (1) This device may not cause harmful interference, and
- (2) this device must accept any interference received, including interference that may cause undesired operation.

CAUTION: These servicing instructions are for use by qualified service personnel only. To reduce the risk of electric shock do not perform any servicing other than that contained in the operating instructions unless you are qualified to do so.

WARNING: Handling the cord on this product or cords associated with accessories sold with this product, will expose you to lead, a chemical known to the State of California to cause birth defects or other reproductive harm. ***Wash hands after handling.***

This product contains mercury. Disposal of mercury may be regulated due to environmental considerations. For disposal or recycling information, please contact your local authorities or the Electronic Industries Alliance: www.eiae.org.

In the spaces provided below, record the Model and Serial No. located on the bottom of your DVD player.



Model No. _____

Serial No. _____

Retain this information for future reference.

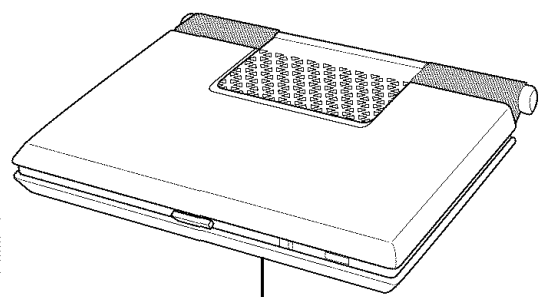
Location of the required label



TOSHIBA		PORTABLE DVD PLAYER		MODEL NO. SD-P1400	
DC 12V  3A		PRODUCT IS CERTIFIED BY THE MANUFACTURER TO COMPLY WITH DHHS RULE 21 CFR SUBCHAPTER J APPLICABLE AT THE DATE OF MANUFACTURE.			
 Tested To Comply With FCC Standards FOR HOME OR OFFICE USE		MANUFACTURED			
		SERIAL NO.			
TOSHIBA CORPORATION			MADE IN CHINA		
1-1, SHIBAURA 1-CHOME, MINATO-KU, TOKYO 105-8001, JAPAN			FABRIQUE EN CHINE		
THIS CLASS B DIGITAL APPARATUS COMPLIES WITH CANADIAN ICE-003. CET APPAREIL NUMÉRIQUE DE LA CLASSE B EST CONFORME À LA NORME NMB-003 DU CANADA.					

IMPORTANT SAFETY INSTRUCTIONS

CAUTION: PLEASE READ AND OBSERVE ALL WARNINGS AND INSTRUCTIONS GIVEN IN THIS OWNER'S MANUAL AND THOSE MARKED ON THE UNIT. RETAIN THIS BOOKLET FOR FUTURE REFERENCE.

This set has been designed and manufactured to assure personal safety. Improper use can result in electric shock or fire hazard. The safeguards incorporated in this unit will protect you if you observe the following procedures for installation, use and servicing. This unit is fully transistorized and does not contain any parts that can be repaired by the user.

DO NOT REMOVE THE CABINET COVER, OR YOU MAY BE EXPOSED TO DANGEROUS VOLTAGE. REFER SERVICING TO QUALIFIED SERVICE PERSONNEL ONLY.

1. Read these instructions.
2. Keep these instructions.
3. Heed all warnings.
4. Follow all instructions.
5. Do not use this apparatus near water.
6. Clean only with dry cloth.
7. Do not install near any heat sources such as radiators, heat registers, stoves, or other apparatus (including amplifiers) that produce heat.
8. Protect the power cord from being walked on or pinched particularly at plugs, convenience receptacles, and the point where they exit from the apparatus.
9. Only use attachments/accessories specified by the manufacturer.
10. Unplug this apparatus during lightning storms or when unused for long periods of time. However, while it is thundering or lightning, do not touch the apparatus and any connected cable and/or equipment. This will prevent you from receiving the electric shock by an electric surge.
11. Refer all servicing to qualified service personnel. Servicing is required when the apparatus has been damaged in any way, such as power-supply cord or plug is damaged, liquid has been spilled or objects have fallen into the apparatus, the apparatus has been exposed to rain or moisture, does not operate normally, or has been dropped.

ADDITIONAL SAFETY INSTRUCTIONS

12. When you use headphones, keep the volume at a moderate level. If you use the headphones continuously with high volume sound, it may cause hearing damaged.
13. Do not overload wall outlets; extension cords, or integral convenience receptacles as this can result in a risk of fire or electric shock.
14. Apparatus shall not be exposed to dripping or splashing and no objects filled with liquids, such as vases, shall be placed on the apparatus and/or around it.
15. Be careful not to catch your fingers in the disc holder when closing the lid. It may cause personal injury.
16. Do not put a vessel containing liquid such as a vase, or a metal object on the apparatus. If liquid or a foreign metal object is let into the apparatus, it may cause fires or electric shock.
17. Do not use a cracked, deformed, or repaired disc. These discs are easily broken and may cause serious personal injury and apparatus malfunction.
18. Do not touch a spinning disc. When you open the disc holder, the disc may have not stopped spinning. Touching a spinning disc may cause personal injury or damage to the product.
19. Do not rest the product on your lap or other parts of body, as it may become heated. Even low temperature may cause inflaming or blistering, if touched for a prolonged period.
20. Use the supplied AC adapter to operate the product. Substitute devices not specified by the manufacturer may result in fire or product malfunction. Do not cover the AC adapter with a blanket or place it near heating or on electric carpet when it is in use.

21. When you use this product in an airplane, follow the instructions of the airline. Disregarding them may cause harmful interference to radio communication.
22. Do not look close the pick-up lens or stare into laser beam. Doing so may cause damage to eyesight.
23. Do not use this product while walking or driving. Neglecting this may cause a traffic accident.
24. Should the LCD monitor be broken and liquid leaks out, do not inhale or swallow it. Doing so may cause poisoning.
If you have got it into your mouth, wash it out and consult your doctor. If your hands or clothes have touched it, wipe them with alcohol and a cleaning cloth and then wash them well.
25. Battery Pack
- Never throw the battery pack into a fire, as that could cause the battery pack to explode. Never heat the battery pack, as that could cause leakage of alkaline solution or other electrolytic substance.
 - Never disassemble the battery pack, as that could cause leakage of alkaline solution or other electrolytic substance.
 - Never short-circuit the battery pack by either accidentally or intentionally bringing the terminals in contact with another metal object. This could cause personal injury or a fire, and could also damage the battery pack.
 - Never drive a nail into the battery pack. Never strike the battery pack with a hammer. Never step or tread on the battery pack.
 - If you ever detect the emission of an extraordinary odor, excessive heat, discoloration, or deformation of the battery pack, remove it from the player after confirming safety and discontinue use of it. Take the battery pack to an authorized Toshiba service provider.
 - Keep the battery pack away from heat or fire, if you detect the emission of an extraordinary odor or leakage of alkaline solution or other electrolytic substance.
- Never dispose of used battery packs with other ordinary solid wastes, since they contain toxic substances. Always dispose of used battery packs in accordance with community regulations that apply to the disposal of batteries. Cover the metal terminals with insulating tape, in order to prevent accidental short-circuiting.
 - Always confirm that the battery pack is compatible with your player, before attaching the battery pack to the player.
 - Never expose the terminals of the battery pack to any other metal object. Wrap the battery or place it in a protective plastic bag, whenever transporting it.
 - Always confirm that the temperature is between 5 and 35°C (41°F and 95°F) before you charge the battery. Leakage, excessive heat, or deterioration of the battery pack may occur if this warning is not heeded.
 - Never immerse the battery pack in any liquid.
 - Never expose the battery pack to direct sunlight. Never store or use the battery pack in a locked and unventilated vehicle. (where excessive internal temperatures may be encountered.)
 - Always keep the battery pack out of reach of infants or small children.
 - Never shock the battery pack by dropping or throwing it.
 - If the liquid contained within the battery pack leaks, use a large amount of water and immediately wash off any liquid which may accidentally contact any part of the body. Remove any liquid that has contacted your clothing by washing it immediately with a detergent.
 - Always confirm that a "click" sound has resulted, when attaching the battery pack to the player. This sound confirms that the battery pack has been properly attached.
26. Coin-shaped Battery
- Keep coin-shaped batteries out of children's reach. Be careful not to ingest internally, especially by children, as doing so may cause poisoning.
 - Do not load a battery into the remote control with the wrong side out.

IMPORTANT SAFETY INSTRUCTIONS

- c) Do not charge, heat, open, or short-circuit the batteries. Do not throw the batteries into a fire.
 - d) Do not leave a dead or exhausted battery in the remote control.
 - e) If you do not use the remote control for a long period of time, remove the battery to avoid possible damage from battery corrosion.
27. After unpacking coin-shaped batteries, store them in poly bags, etc. separately one by one when unused. If you leave them unwrapped, they may be *short-circuited by contact with metal objects*, resulting in battery leakage, heat or bursting. This may cause burns or injury.
The batteries must be completely discharged when they are deposited in collection containers for old batteries. If a charge remains, countermeasures to prevent short circuits must be taken.
28. To reduce the risk of fire or electric shock, do not expose this apparatus to rain or moisture.
29. Following mark means "CAUTION - RISK OF FIRE - DO NOT OPEN".



- e) When handling, using or storing the adapter power cord NEVER:
 - Place or locate near any apparatus that produces heat.
 - Disassemble, splice or extend the cord.
 - Pull, force or place any heavy objects on the cord.
 - Bend, twist or bind the cord.
 - f) Keep away from the driving device (such as brake pedal, etc.) and the moving equipment (such as a seat rail, car windows, door, etc.).
 - g) NEVER disassemble or alter this adapter in any manner.
 - h) ALWAYS use caution when touching the adapter, cigarette lighter socket or power port. The adapter, lighter socket and power port may become heated after prolonged use.
 - i) ALWAYS remove the adapter from the cigarette lighter socket or power port when not in use.
 - j) Do not charge the battery pack which is attached to the apparatus by the adapter. Doing so may cause smoke, fire or electrical shock to human body. Whenever you use the adapter, be sure to remove the battery pack from the apparatus to prevent it from being charged by the adapter.
 - k) Some cars may not have a compatible socket. NEVER modify this adapter to fit an incompatible cigarette lighter socket and/or power port. NEVER modify an incompatible cigarette lighter socket and/or power port to accept this adapter.
Failure to observe the above warnings could cause smoke, fire, burns and/or electric shock.
 - l) ALWAYS locate the apparatus on a level and secure surface. If placed on an uneven, shaky, unsecured or unstable surface, apparatus may fall.
Failure to observe the above warning could result in the apparatus striking a person.
 - m) When using the adapter, insert the plug of the adapter into the cigarette lighter socket or power port fully.
The incomplete insertion will cause smoke or fire.
 - n) Do not touch the adapter with wet hands. Do not liquid over the adapter.
30. Vehicle adapter and operation in a car
- a) NEVER operate the apparatus or view a DVD Video while operating an automobile or other vehicle. Note: doing so is illegal in many jurisdictions.
NEVER place a apparatus within the eyesight of a driver while he/she is driving an automobile/vehicle. Note: an apparatus located in the front seating section of a vehicle is illegal in many jurisdictions.
Failure to observe the above instructions could result in the driver's inattention to and/or distraction from road hazards.
 - b) NEVER place an apparatus in a location where it could interfere with the proper deployment and/or performance of an air bag. Failure to observe this instruction could result in the prevention of an air bag to properly and/or effectively deploy.
 - c) Do not use a vehicle adapter other than the model supplied, to power the apparatus. Do not use the supplied vehicle adapter to power an apparatus other than this apparatus. Neglecting these may cause smoke, fire or electrical shock to human body.
 - d) This adapter is intended for exclusive use in automobiles/vehicles with a DC 12V negative ground electrical system.

Notes on handling

- Do not shock the LCD monitor. It may cause unit damage and malfunction.
- Do not use the player in a place subject to vibration. Neglecting this may cause malfunction of the player or damage to the disc.
- Do not leave the player in a vehicle. Rise or drop in temperature may result in malfunction of the player.
- When transporting the player, the original shipping carton and packing materials come in handy. For maximum protection, repack the unit as it was originally packaged at the factory.
- Do not use volatile liquids, such as insect spray, near the player. Do not leave rubber or plastic products in contact with the player for a long time. They will leave marks on the finish.
- The player may become warm after a long period of use. This is not a malfunction.
- When the player is not in use, be sure to remove the disc and turn off the power.
- If you do not use the player for a long period, the unit may not function properly in the future. Turn on and use the player occasionally.

Notes on locating

- When you place this player near a TV, radio, or VCR, the playback picture may become poor and the sound may be distorted. In this case, move the player away from the TV, radio, or VCR.

Notes on cleaning

- Use a soft, dry cloth for cleaning. For stubborn dirt, soak the cloth in a weak detergent solution, wring well and wipe. Use a dry cloth to wipe it dry. Do not use any type of solvent, such as thinner and benzene, as they may damage the surface of the player. If you use a chemical saturated cloth to clean the unit, follow that product's instructions.
- When cleaning the LCD monitor, use a soft, dry cloth.

To obtain a clear picture

The player is a high technology, precision device. If the optical pick-up lens and disc drive parts are dirty or worn down, the picture quality becomes poor. To obtain a clear picture, we recommend regular inspection and maintenance (cleaning or parts replacement) every 1,000 hours of use depending on the operating environment. For details, contact your nearest dealer.

Notes on moisture condensation

Moisture condensation damages the player. Please read the following carefully.

Moisture condensation occurs, for example, when you pour a cold drink into a glass on a warm day. Drops of water form on the outside of the glass. In the same way, moisture may condense on the optical pick-up lens inside this unit, one of the most crucial internal parts of the player.

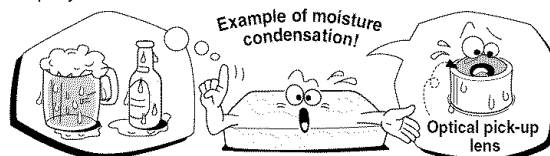

■ **Moisture condensation occurs during the following cases.**

- When you transport the player directly from a cold place to a warm place.
- When you use the player in a room where you just turned on the heater, or a place where the cold air from the air conditioner directly hits the unit.
- In summer, when you use the player in a hot and humid place just after you move the unit from an air conditioned room.
- When you use the player in a humid place.

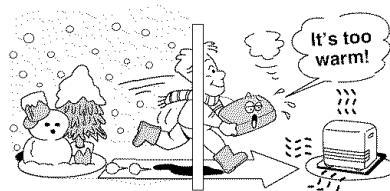

■ **Do not use the player when moisture condensation may occur.**

If you use the player in such a situation, it may damage discs and internal parts. Remove the disc, connect the AC adapter, turn on the player, and leave it for two or three hours. After two or three hours, the player will have warmed up and evaporated any moisture.

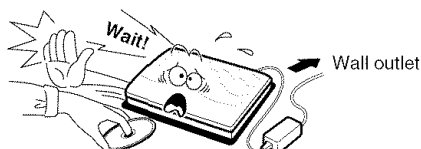

Notes and Information

Structure of disc contents

Normally, DVD video discs are divided into titles, and the titles are sub-divided into chapters. VIDEO CDs/audio CDs are divided into tracks.

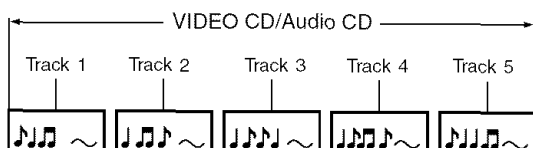
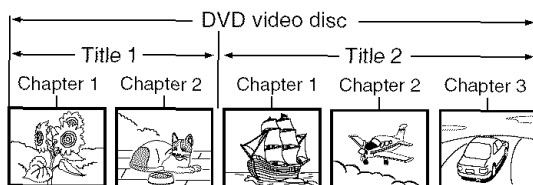

Each title, chapter, or track is assigned a number, which is called "title number", "chapter number" or "track number" respectively. There may be discs that do not have these numbers.

On handling discs

- Do not touch the playback side of the disc.

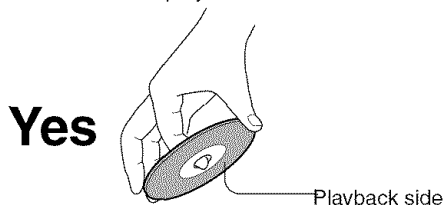

- Do not attach paper or tape to discs.



On cleaning discs

- Fingerprints and dust on the disc may cause picture and sound deterioration. Wipe the disc from the center outwards with a soft cloth. Always keep the disc clean.



- If you cannot wipe off the dust with a soft cloth, wipe the disc lightly with a slightly moistened soft cloth and finish with a dry cloth.
- Do not use any type of solvent such as thinner, benzene, commercially available cleaners or antistatic spray for vinyl LPs. It may damage the disc.

On storing discs

- Do not store discs in a place subject to direct sunlight or near heat sources.
- Do not store discs in places subject to moisture and dust such as a bathroom or near a humidifier.
- Store discs vertically in a case. Stacking or placing objects on discs outside of their case may cause warping.

Notes on copyright



It is forbidden by law to copy, broadcast, show, broadcast on cable, play in public, and rent copyrighted material without permission.

DVD video discs are copy protected, and any recordings made from these discs will be distorted.



This product incorporates copyright protection technology that is protected by method claims of certain U.S. patents and other intellectual property rights owned by Macrovision Corporation and other rights owners. Use of this copyright protection technology must be authorized by Macrovision Corporation, and is intended for home and other limited viewing uses only unless otherwise authorized by Macrovision Corporation. Reverse engineering or disassembly is prohibited.

About this owner's manual

This owner's manual explains the basic instructions of this player. Some DVD video discs are produced in a manner that allows specific or limited operation during playback. As such, the player may not respond to all operating commands. This is not a defect in the player. Refer to instruction notes of discs.

“” may appear on the screen during operation. A “” means that the operation is not permitted by the player or the disc.

Notes on region numbers

The region number of this player is 1. Region numbers, corresponding to specific geographical playback area, are printed on your DVD video disc. If you do not find  or , disc playback will not be allowed by the player. (In this case, the player will display a message on-screen.)

On VIDEO CDs

This player supports VIDEO CDs equipped with the PBC (Version 2.0) function. (PBC is an abbreviation for Playback Control.)

You can enjoy two playback variations depending on types of discs.

- VIDEO CD not equipped with PBC function (Version 1.1)
Sound and movie can be played on this player in the same way as an audio CD.
- VIDEO CD equipped with PBC function (Version 2.0)

In addition to operation of a VIDEO CD not equipped with the PBC function, you can enjoy playback of interactive software with search function by using the menu displayed on the screen (Menu Playback). Some functions described in this owner's manual may not work with all discs.

Playable discs

This player can play the following discs.

	Disc Mark	Contents	Disc Size
DVD video discs		Video (moving pictures) + Audio	12 cm
			8 cm
VIDEO CDs		Video (moving pictures) + Audio	12 cm
			8 cm
Audio CDs		Audio	12 cm
			8 cm (CD single)
<p>The following discs are also available.</p> <ul style="list-style-type: none"> ● DVD-R discs of DVD video format ● CD-R/CD-RW discs of CD-DA or VIDEO CD format <p>Some of these discs may be incompatible.</p>			

- You cannot play discs other than those listed above.
- You cannot play discs of DVD-RAM or non-standardized discs, etc., even if they may be labeled as above.
- This player uses the NTSC color system.

Because of problems and errors that can occur during the creation of DVD software and/or the manufacture of DVD discs, Toshiba America Consumer Products, L.L.C. and Toshiba of Canada, Ltd. cannot guarantee that this player will play every feature of every DVD bearing the DVD logo. As one of the creators of DVD technology, Toshiba DVD players are manufactured to the highest standards of quality and, as a result, such incompatibilities are very rare. If you happen to experience and difficulty playing a DVD on a Toshiba DVD player, please feel free to call our Contact listed in “How to Obtain Service” .

Notes and Information (continued)

Exemptions

- Toshiba Corporation is not liable for any damage caused by fire, natural disaster (such as thunder, earthquake), acts by third parties, accidents, owner's intentional or unintentional misuse, or uses in other improper conditions.
- Toshiba Corporation is not liable for incidental damages (such as profit loss or interruption in business, etc.) caused by use or inability to use of this player.
- Toshiba Corporation is not liable for any damage caused by neglect of the instructions described in the owner's manual.
- Toshiba Corporation is not liable for any damage caused by misuse or malfunction through joint use of this player and connected equipment or software.

On disposal

This product contains mercury. Disposal of this material may be regulated due to environmental considerations. For disposal or recycling information, please contact your local government or the Consumer Electronics Association.

Table of Contents

Introduction

● SAFETY PRECAUTIONS	2
● IMPORTANT SAFETY INSTRUCTIONS ...	4
● Precautions	7
● Notes and Information	8
Notes on region numbers	9
● Table of Contents	11
● Identification of Controls	12
Main unit	12
Side view	13
Rear view	13
Remote control	14
Loading the remote control battery	15
Operating with the remote control	15
● Power Connection	16

Basic playback

● Playing a Disc	18
Basic playback	18
● Variable Speed Playback	22
Playing in fast reverse or fast forward directions	22
Playing frame by frame	22
Playing in slow-motion	23
Resuming playback from the stopped location ..	23
● Locating a Specific Title, Chapter, or Track	24
Locating a title using the top menu	24
Locating a desired section by entering its corresponding number	25
Locating a specific chapter or track	26
● Playing MP3/WMA Files	27
Playing MP3/WMA files	27
● Viewing JPEG Files	28
Viewing JPEG Files	28

Advanced playback

● Directly Accessing a Specific Location ...	32
Entering the time counter of the desired location ...	32
● Repeat Play	33
Repeating a title, chapter, or track	33
Repeating a specific segment	33
● Playing in a Favorite Order	34
Setting titles, chapters, or tracks in a favorite order	34
● Playing in Random Order	35
Playing, chapters or tracks in random order ...	35

● Zooming a Picture	36
Zooming a picture	36
● Selecting the Sound Enhancement (E.A.M.*) ..	37
Selecting the sound enhancement	37
● Selecting a Camera Angle	38
Changing the camera angle	38
● Selecting Subtitles	39
Selecting a subtitle language	39
● Selecting a Language	40
Selecting a playback audio setting	40
● Operating in the On-screen Display Mode ..	42
On-Screen Display Operation	42
● Adjusting the Picture	44
Adjusting the picture	44

Function setup

● Customizing the Function Settings	46
Setting procedure	46
Setting details	48

Connections

● Connecting to a TV or audio system	54
Connecting to a TV	54
Connecting to an audio system	55
● Connecting to Headphones	56
● Connecting to Audio Equipment	57
Connecting to an amplifier equipped with a Dolby Digital decoder	58
Connecting to an amplifier equipped with Dolby Surround Pro Logic	58
Connecting to an amplifier equipped with a DTS decoder	59
Connecting to an amplifier equipped with an MPEG2 audio decoder	59
Connecting to an amplifier equipped with a digital audio input	60
● Using the Battery Pack	61
● Using the automobile/vehicle adapter or power port	63

Others

● Before Calling Service Personnel	66
● Specifications	68
● LIMITED WARRANTY PORTABLE DVD PLAYER	69

Identification of Controls

See the page in for details.

Main unit

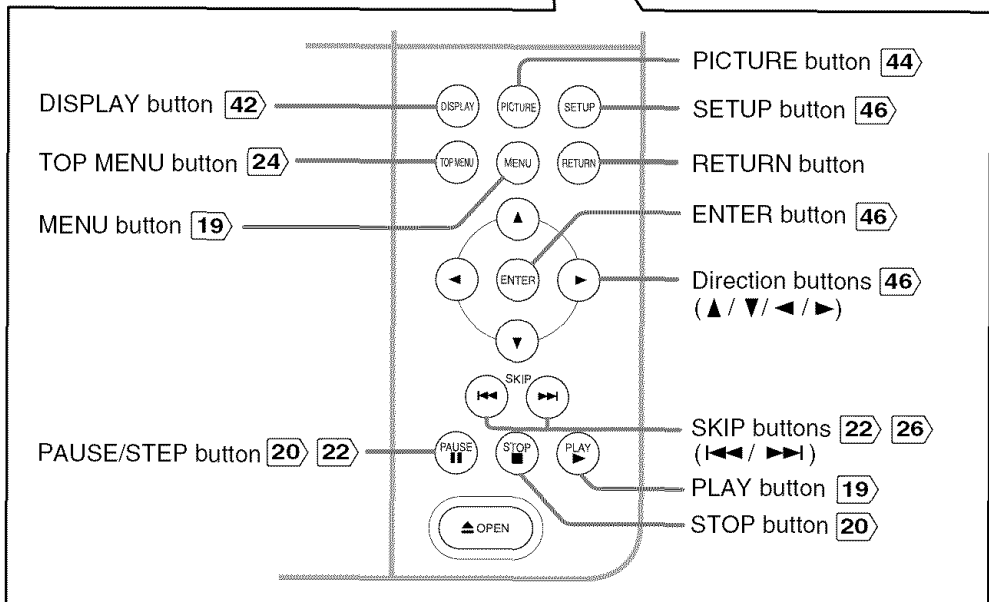
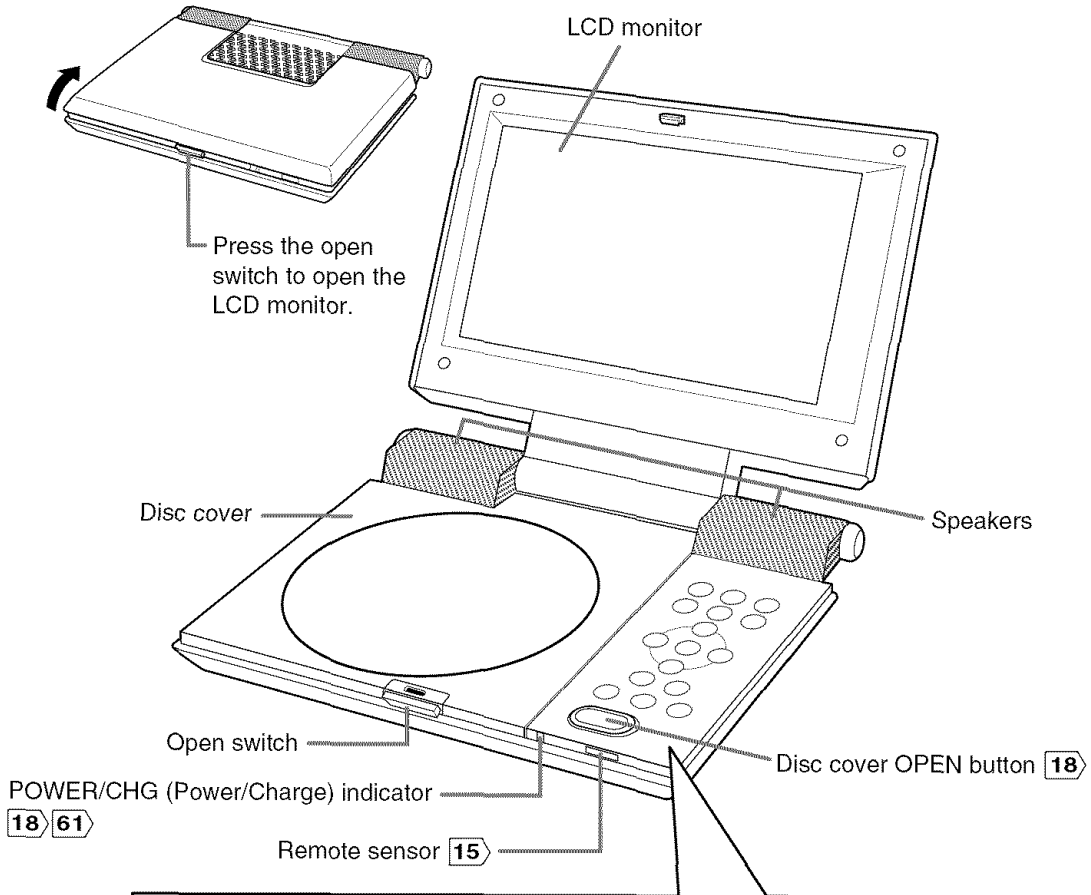

Side view

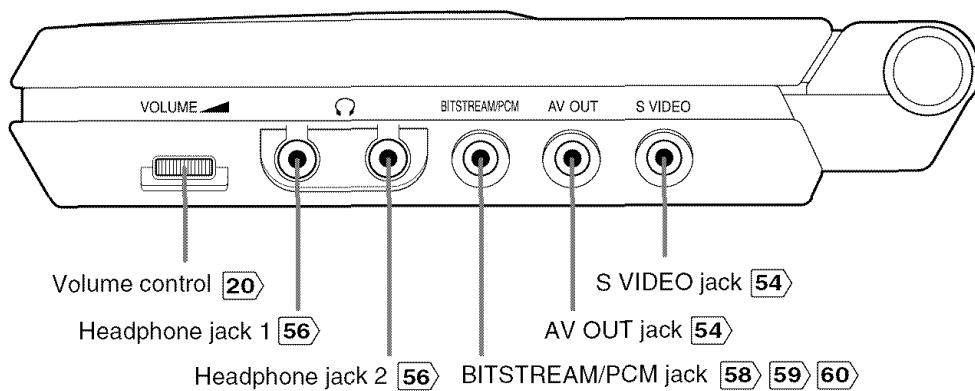
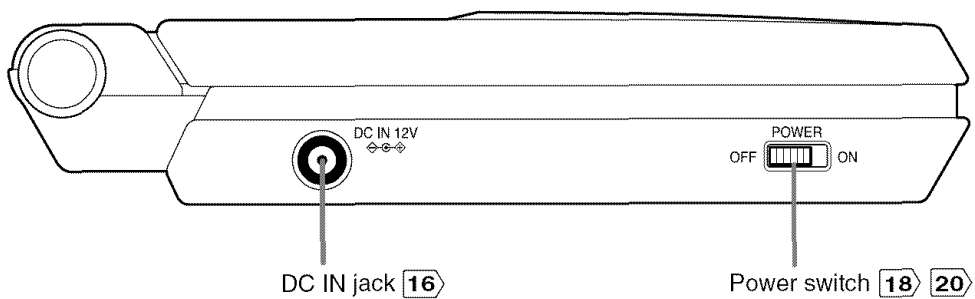

Rear view

LCD/AV OUT SELECT switch **54**

- Normally place it in the "LCD" position.

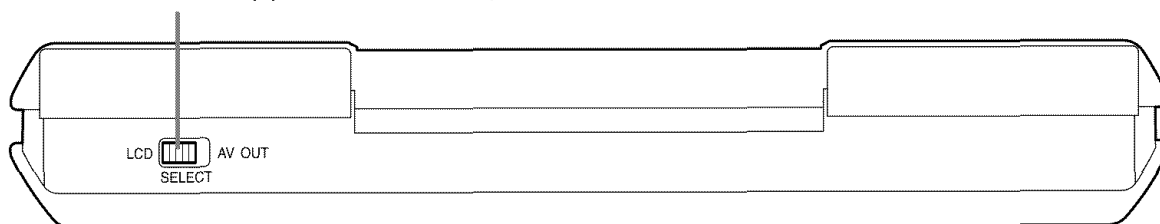

Identification of Controls (continued)

The instructions in this manual describe the functions of the remote control. See the page in  for details.

Remote control

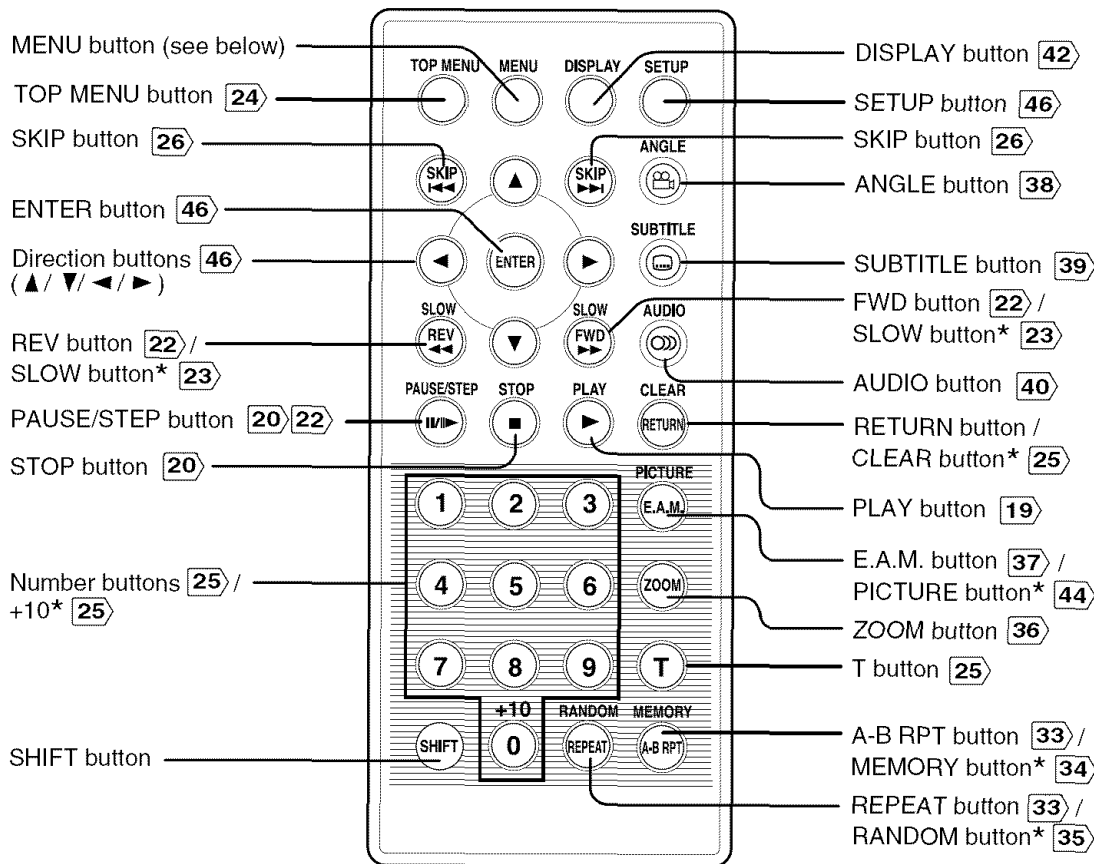

" * " buttons

Operate these buttons while simultaneously pressing the SHIFT button.

MENU button

Use the MENU button to display the menu included on many DVD video discs. To operate a menu, follow the instructions in "Locating a title using the top menu." **24**

Loading the remote control battery

- 1** While pushing the holder in direction ①, simultaneously slide it out in direction ②.

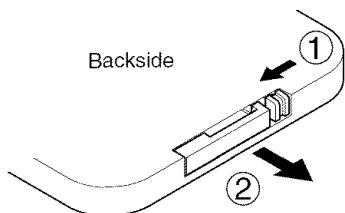

- 2** Place a coin-shaped battery (CR2025) with the ⊕ side up on the holder.

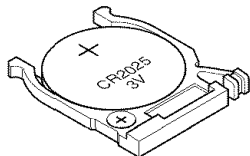

Keep the holder horizontal so that the battery does not fall through.

- 3** Push the holder back into its receptacle.

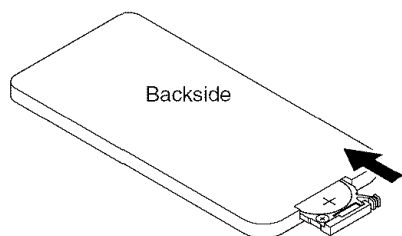

Notes on coin-shaped batteries

- If the remote control does not function correctly or if the operating range becomes reduced, replace the battery with new one.
- See [6] for safety use of coin-shaped batteries.
- Inserting a battery other than the specified one or an object may damage the remote control.

Operating with the remote control

- Point the remote control at the remote sensor on the player and press the buttons.

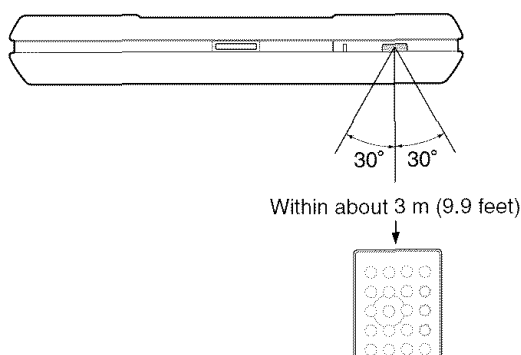

Distance: About 3 m (9.9 feet) from the front of the remote sensor

Angle: About 30° in each direction of the front of the remote sensor

- * Do not expose the remote sensor of the player to a strong light source such as direct sunlight or other illumination. If you do so, you may not be able to operate the player via the remote control.

Notes on the remote control

- Aim the remote control at the remote sensor of the player.
- Do not drop or give the remote control a shock.
- Do not leave the remote control near an extremely hot or humid place.
- Do not spill water or put anything wet on the remote control.
- Do not disassemble the remote control.

Power Connection

Connect the supplied AC adapter to power the player.
 For mobile use, the battery pack (supplied) is also available.
 When using the battery pack, follow the instructions on page [61](#).

Caution

- Do not connect the power plug to a power outlet other than that indicated on the label, as this can result in a risk of fire or electric shock.
- Do not connect or disconnect the power plug with wet hands. Doing so may cause electric shock.
- Do not use an AC adapter other than one specified, as it can cause a fire or damage to the player.
- When the AC adapter is in use, its temperature may increase. However, it is not a malfunction. Make sure that the power cord is disconnected and the temperature decreases before carrying it.

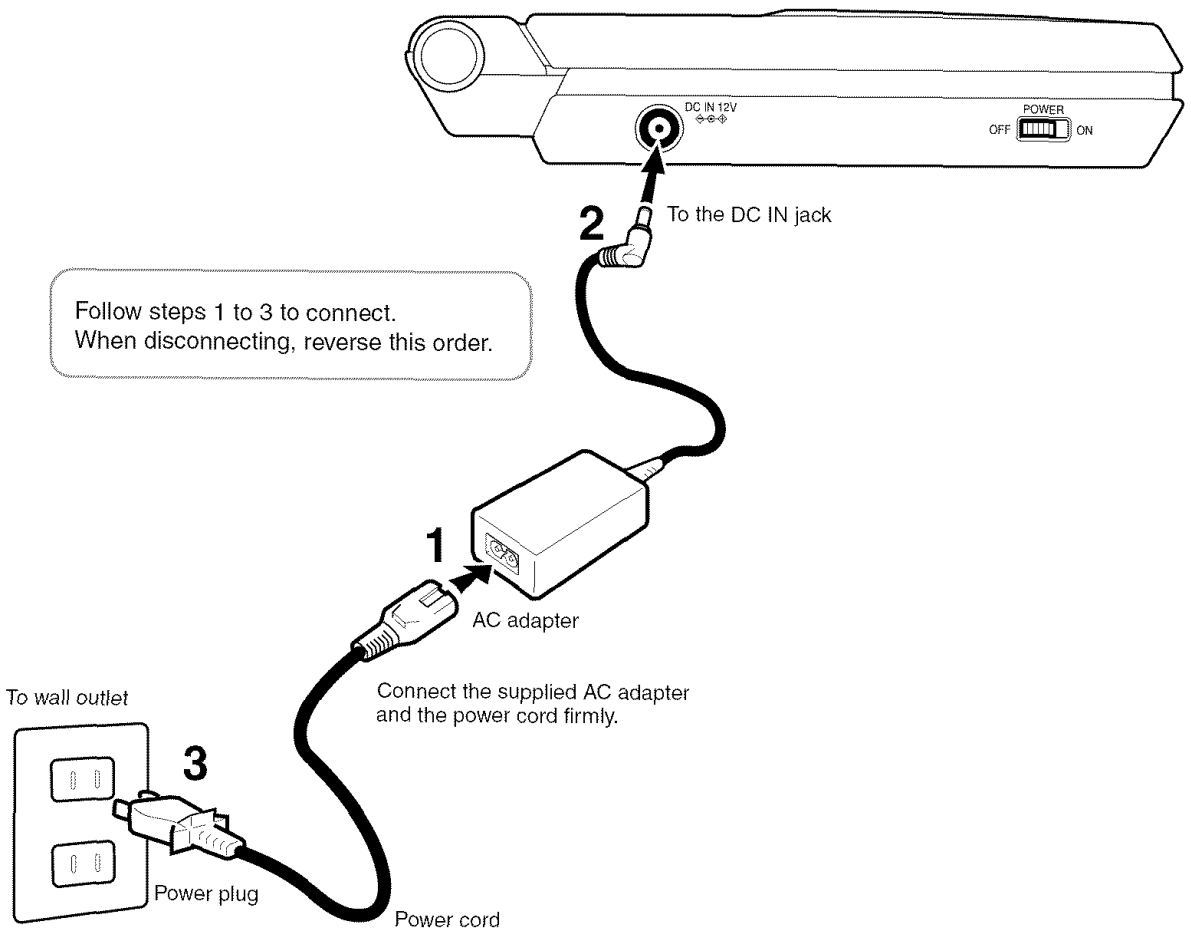

Basic playback

Begin your operation.



- **Playing a Disc**
- **Variable Speed Playback**
- **Locating a Specific Title, Chapter, or Track**
- **Playing MP3/WMA Files**
- **Viewing JPEG Files**

About this manual

- The numbers indicated by lines on the illustrations correspond to the associated steps of the operation.
- Aside from the section "Playing a Disc", explanations of operations only include illustrations of the *corresponding buttons on the remote control*. The buttons sharing the same name on the main unit can also be used in an identical manner.

Playing a Disc

This section shows you the basics on how to play a disc.

 indicates a reference page of this manual.
See the page in  for details.





CAUTION

- Keep your fingers clear of the disc as it is spinning. Neglecting to may cause serious personal injury.
- Be careful not to catch your fingers in the disc holder.
- Do not use a cracked, deformed, or repaired disc.
- Do not tilt, shake or move the main unit while playing. It may damage the disc.



Basic playback

Preparations

- Connect the AC adapter  or the battery pack  to the player.
- When you want to view a disc on a connected TV or monitor, turn on the equipment and select the video input connected to the player.
- When you want to enjoy the sound of discs from an audio system, turn the audio system on and select the input connected to the player.
- If you use the supplied remote control, make sure that batteries are loaded in it. 
- If you use the headphones, see "Connecting to Headphones". 
- Press the open switch to open the LCD monitor.

Press the open switch to open the LCD monitor.

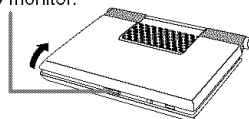

Do not forcibly open the LCD monitor to avoid damaging this panel.

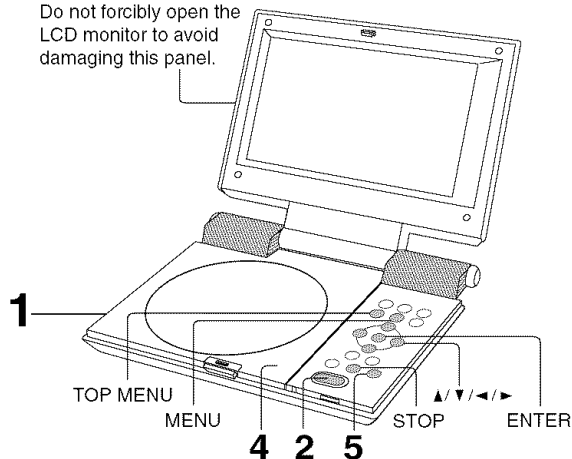

1 Turn on the power.

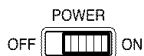

Slide the power switch to "ON".

The player turns on and the POWER/CHG indicator on the player illuminates in green.

2 Open the disc cover.

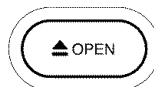

Press OPEN on the main unit. The disc cover opens.

The disc cover will not open over a certain range. Do not force the cover open further, as it may cause damage to the player.

3 Set a disc.

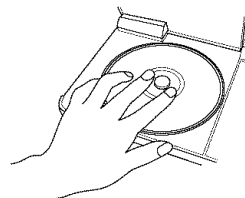

Place a disc with the playback side down, and push gently on the center of the disc to affix it to the spindle.

4 Close the disc cover.

Press CLOSE on the right corner.

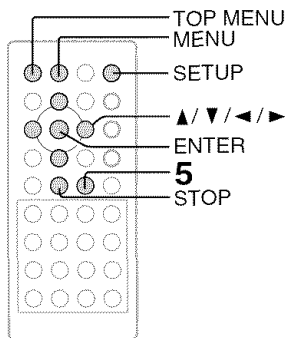

■ **To obtain a higher quality picture (When connected to a TV)**

Occasionally, some picture noise not usually visible during a normal broadcast may appear on the TV screen while playing a DVD video disc because the high resolution pictures on these discs include a lot of information. While the amount of noise depends on the TV you use with this player, you should generally reduce the sharpness adjustment on the connected TV when viewing DVD video discs.

■ **About**

The icons on the heading bar show the playable discs relevant to the function described under each heading.

: DVD video discs.

: VIDEO CDs.

: Audio CDs.

5 Start playback.

Press **PLAY**.



If you select a DVD video disc that contains a top menu, or select a PBC (Playback Control)-featured VIDEO CD () , a menu may appear. See "Locating a title using the top menu".

- You may need to press the TOP MENU or MENU button to display the disc menu (depending on the actual DVD video disc.)

■ **To change an on-screen language.**

1 Press **SETUP**.



The following on-screen display appears.

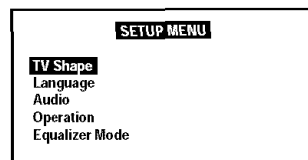

2 Press **▲ / ▼** to select "Language", then press **ENTER**.

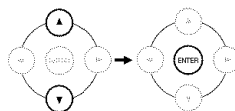

3 Press **▲ / ▼** to select "On-screen", then press **▶**.

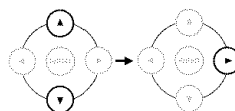

4 Select a language using **▲ / ▼**, then press **ENTER**.

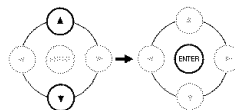

5 Press **SETUP**.



The on-screen display disappears.

■ **To start playback in the stop mode.**

Press **PLAY**.



Notes

- Do not put an unplayable disc or any objects other than discs in the disc holder.
- In many instances, a menu screen will appear after playback of a movie is completed. Prolonged display of an on-screen menu may damage your television set, permanently etching that image onto its screen. To avoid this, be sure to press the STOP button once the movie is completed.

CAUTION

Never operate the player in a moving vehicle. Vibration may prevent proper playback of the player or cause damage to the disc.

Playing a Disc (continued)

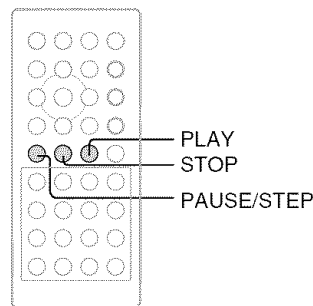

Basic playback (continued)

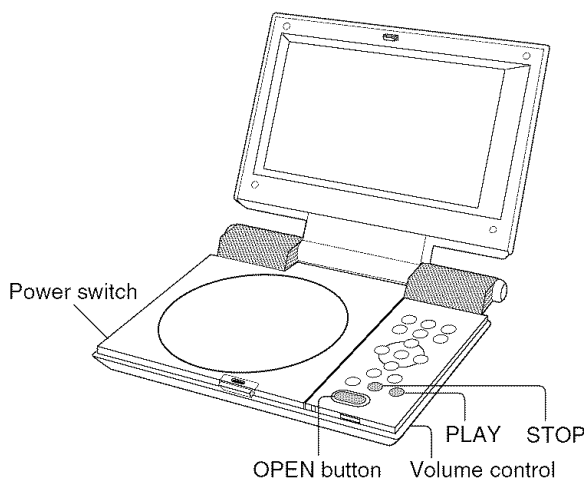

■ To adjust the volume of the speakers or the connected headphones

Turn volume control.

VOLUME  Right : Increase volume.
Left : Decrease volume.



■ To pause playback (still mode)

Press **PAUSE/STEP** during playback.



To resume normal playback, press **PLAY**.

- Sound is muted during still mode.

PAUSE/STEP



■ To stop playback

Press **STOP**.



The player memorizes the location where playback is stopped. To clear the memory, press the STOP button once again. **23**



■ To turn off the power

Slide the power switch to "OFF".



■ To remove the disc

Press the OPEN button on the main unit to open the disc cover.



Remove the disc from under the rim while gently pressing down on its center.
Close the disc cover after removing the disc.

CAUTION

Do not touch the spindle immediately after prolonged play, as it may have become hot.
Be careful in loading/removing a disc.

■ About the screen saver

If you pause a picture of a DVD video disc and leave it still for approximately 20 minutes, the screen saver of the player automatically appears (when "Screen Saver" is set to "On" **[51]**). To turn off the screen saver, press any button on the main unit or remote control.

■ Automatic LCD Off function

If the player is stopped or the screen saver is engaged for approximately 20 minutes, the LCD power automatically turned off. To turn on the LCD monitor, press any button on the main unit or remote control.

■ About the LCD

- The color LCD is manufactured using extremely high precision technology, but even so may include certain pixels that do not operate properly (that do not light, that remain lit constantly, etc.). We do our best to keep the number of these defective pixels to a minimum, but please understand that they cannot be completely eliminated even with the most advanced manufacturing technologies available today.
- The fluorescent tube which illuminates the panel from the inside will deteriorate with use. (The standard life length is about 10,000 hours of continuous use at normal temperature. This is referential information only and is not warranted.) When the LCD becomes dim, flickers, or does not illuminate, contact your dealer for replacement.
- The brightness of the LCD monitor differs slightly depending on the viewing angles. Adjust the LCD monitor angle to obtain the best viewing. (The recommended viewing angle is 90 degrees to the monitor.)

Variable Speed Playback

You can play discs at various speeds, and resume playback from the location where you stopped playback.

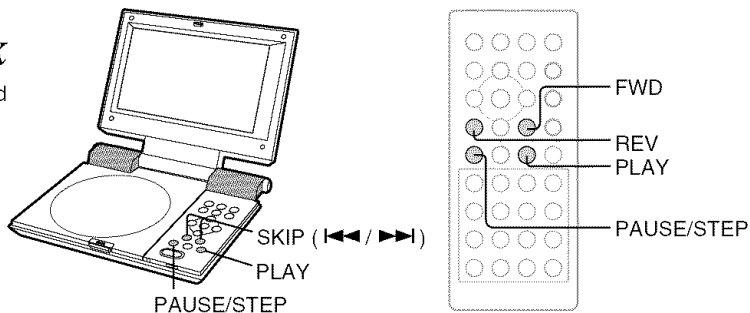

Playing in fast reverse or fast forward directions

Press **REV** or **FWD** on the remote control during playback.



REV: Fast reverse playback
FWD: Fast forward playback



Each time you press the REV or FWD button, the playback speed changes.

Press and hold **SKIP (I<</>I>>I)** on the main unit during playback.



Fast forward playback

Fast reverse playback

During the fast forward or fast reverse playback, you can vary the speed by holding down the button.

To resume normal playback

Press **PLAY**.



Notes

- The player mutes sound and omits subtitles during reverse and forward scan of DVD video discs.
- The playback speed may differ depending on the disc.



Playing frame by frame

Press **PAUSE/STEP** during still playback.



Each time you press the PAUSE/STEP button, the picture advances one frame.

To resume normal playback

Press **PLAY**.



Note

The sound is muted during frame by frame playback.

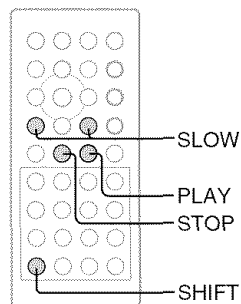
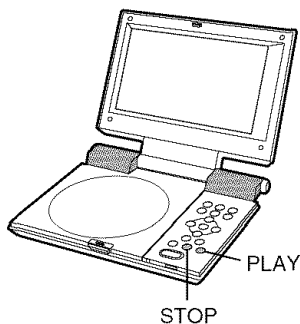

DVD-V **VCD** **CD** **Playing in slow-motion**

Press SLOW while pressing SHIFT during playback.

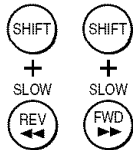

Each time you press the SLOW ►► button, the slow-motion speed changes.

If you press the SLOW ◄◄ button during playback, you can view the picture in reverse slow-motion. (Only when using a DVD video disc.)

Each time you press the SLOW ◄◄ button, the slow-motion speed changes.

To resume normal playback

Press **PLAY**.



Notes

- The sound is muted during slow-motion playback.
- The playback speed may differ depending on the disc.

DVD-V **VCD** **CD** **Resuming playback from the stopped location**

1 Press STOP at the location where you want to interrupt playback.



The player memorizes the location where playback is stopped.

2 Press PLAY.



The player resumes playback from the location where you stopped playback.

2 Press PLAY.



- DVD-V** Playback starts from the beginning of the titles.
- VCD** Playback starts from the beginning of the disc.
- CD** Playback starts from the beginning of the disc.

- If you want to return to the beginning of a DVD video disc, turn the power off and on by sliding the power switch to the ON position, and then start playback.

Notes

- The player's memory is also cleared when:
 - you use a PBC-featured VIDEO CD while "PBC" is set to "On" (51).
- There may be a difference in the location where playback resumes depending on the disc.

To start playback from the beginning regardless of the location where you stopped playback

1 Press STOP twice.



The player's memory is cleared.

Locating a Specific Title, Chapter, or Track

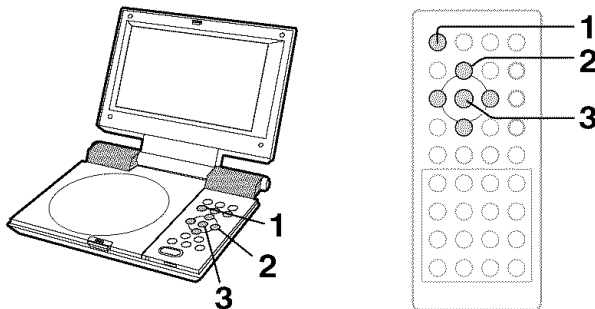

Normally, DVD video discs are divided into titles, and the titles are sub-divided into chapters. Contents of VIDEO CDs and audio CDs are divided into tracks. You can quickly locate any specific title, chapter, or track.

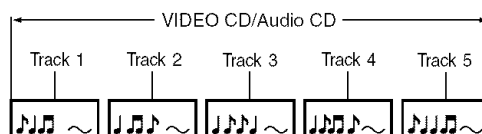
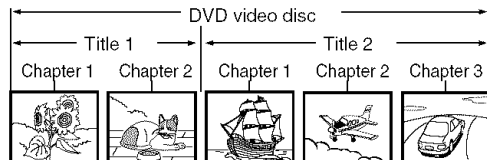

Locating a title using the top menu

1 Press TOP MENU.

TOP MENU The top menu appears.
e.g.

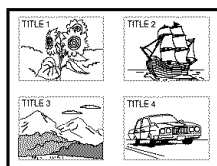

2 Press ▲/▼/◀/▶ to select the title you want.

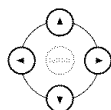

If the titles in the top menu are assigned a number, you can directly locate a specific title by pressing its designated number with the number buttons.

3 Press ENTER.

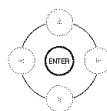

Playback starts from chapter 1 of the selected title.

Notes

- The instructions above describe basic procedures which may vary depending on the contents of the DVD video disc. If different instructions appear on the screen, follow those instructions.
- If you display the top menu during playback and press the TOP MENU button again without selecting any title, the player may resume playback from the point where you first pressed the TOP MENU button (depending on the actual DVD video disc.)
- This method of locating a title is available only on a disc that contains a top menu.
- Instruction notes of discs may refer to the button that displays the top menu as TITLE button.

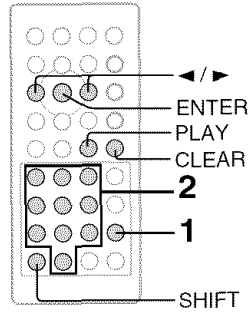

DVD-V **VCD** **CD** **Locating a desired section by entering its corresponding number**

1 Press T several times.

The display changes each time this button is pressed. If you want to locate a title, chapter or track, display "Title," "Chapter," or "Track" respectively. You can also enter the time counter of the desired location. **32**



e.g. **DVD-V**

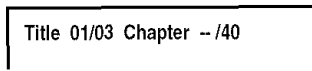

e.g. **VCD** **CD**

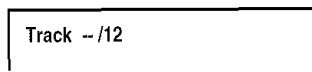

Notes

- Pressing the CLEAR button while pressing the SHIFT button resets the numbers.
- This location display will disappear in a few seconds if no further operation is made.
- This method of locating a title is available only on a disc that contains title numbers.
- You can also use an on-screen display to change a title, chapter or track. **42**

2 Press the number buttons to enter a number of the section.

e.g. To enter 25

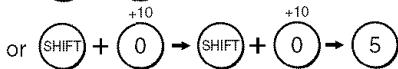
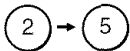

Playback starts from the selected section. With a DVD video disc, you can use **◀/▶** to select either title or chapter for entry.

3 Press PLAY or ENTER.



Playback starts from the selected section.

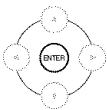

Locating a Specific Title, Chapter, or Track (continued)

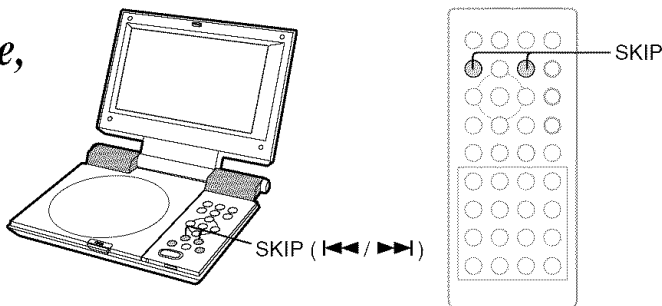

Locating a specific chapter or track

Press SKIP (I<<</>>>I) repeatedly to locate the chapter or track you want.

Playback starts from the selected chapter or track.



To locate succeeding chapters or tracks.



Playback starts from the beginning of the current chapter or track.
When you press twice, playback starts from the beginning of the preceding chapter or track.

Playing MP3/WMA Files

You can play MP3/WMA files on this player.

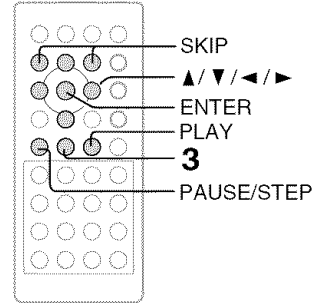

Playing MP3/WMA files

■ Playable files

MP3/WMA disc compatibility with this player is limited as follows:

- Playable discs: CD-ROM, CD-R, CD-RW
- Sampling Frequency: 32 kHz, 44.1 kHz, 48 kHz
- Bit rate: WMA: 48 kbps - 192 kbps(CBR)
MP3: 32 kbps - 320 kbps (CBR)
- CD physical format: Mode 1
- File system: ISO9660, UDF without interleave
- File name: File names are limited to eight characters or less and must incorporate "MP3" or "WMA" extension.
e.g. "*****.MP3", "*****.WMA"
File names cannot contain special characters such as "?!><+*}{[@];\./,." etc.
Less than 50 bytes
- Total number of files: Less than 650
- WMA codec version: V2, V7, V8, V9 (Stereo sound only)

1 Set a CD that contains MP3/WMA files and close the disc cover.

A menu appears.

2 Press ▲/▼/◀/▶ to select a file name you want to play.

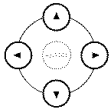

3 Press PLAY or ENTER.



Playback starts.

Notes

- Some discs may not permit this operation.
- WMA tracks copy-protected cannot be played.
- The BITSTREAM/PCM jack outputs MP3/WMA sounds in the linear PCM format regardless of the current "Audio Out Select" selection. [49](#)
- If you stop playback by pressing the STOP button, and then press the PLAY button, playback will start from the beginning of the track.
- The SKIP, REPEAT and RANDOM functions are also available.

This player requires discs/recordings to meet certain technical standards in order to achieve optimal playback quality. Pre-recorded DVDs are automatically set to these standards. There are many different types of recordable disc formats (including CD-R containing MP3/WMA files). Given the fact that technology in this area is still maturing, Toshiba cannot guarantee that all genre of recordable discs will produce optimal playback quality. The technical criteria set out in this owner's manual are meant as a guide only.

Customers should also note that permission is required in order to download MP3 files and music from the internet. Toshiba has no right to grant such permission. Permission should always be sought from the copyright owner.

■ To stop the playback

Press STOP.



■ To pause playback

Press PAUSE/STEP during playback.

PAUSE/STEP



To resume normal playback, press the PLAY button.

Microsoft, Windows Media, and the Windows Logo are trademarks or registered trademarks of Microsoft Corporation in both the United States and other countries.



Viewing JPEG Files

You can play JPEG files that have been recorded on a CD-R on this player.

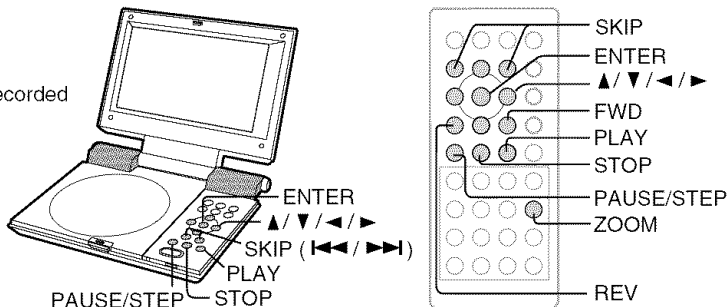

Viewing JPEG Files

■ Preparation

Prepare a disc that contains JPEG files you want to view 30.

1 Set a disc contains JPEG files and close the disc cover.

A menu appears.
If you insert a KODAK Picture CD, automatically starts the slide show. With a KODAK Picture CD, the menu is not displayed. (See the next page.)

e.g.

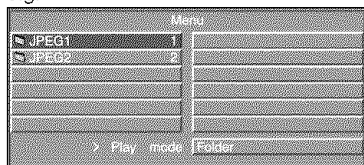

2 Press ▲ / ▼ to select a folder, then press ENTER.

e.g.

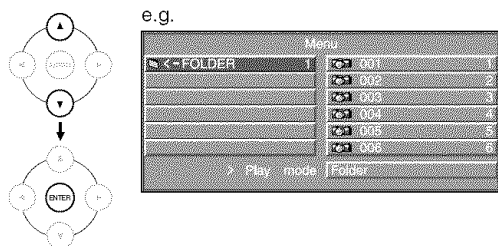

3 Press ►, then select a file by pressing ▲ / ▼.

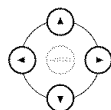

4 Press PLAY or ENTER.



A slide show begins from the selected picture. Upon reaching the end, it will be back to the top menu.

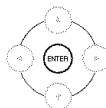

■ To stop the slide show

Press **STOP**.



Thumbnail mode (9-picture display) will be entered.

■ To pause the slide show

Press **PAUSE/STEP** during playback.



To resume the slide show, press the **PLAY** button.

■ To switch pictures

Press **SKIP** (◀◀/▶▶) during playback.



◀◀: Switch to the previous picture

▶▶: Switch to the next picture



Notes

- You may not be able to load a JPEG file exceeding 2MB.
- If you press the MENU button when no menu is displayed, a menu is displayed.

■ To rotate a picture

Press ▲/▼/◀/▶ during playback.

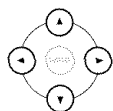

- ▲ : A picture is vertically reversed.
- ▼ : A picture is horizontally reversed.
- ◀ : Rotate counterclockwise (by 90°).
- ▶ : Rotate clockwise (by 90°).

■ To zoom in a picture

1 Press **ZOOM** during playback.



You will enter the zoom mode.

2 Press **FWD** or **REV**.



FWD: Magnification
REV: Image reduction



Each time you press the FWD or REV button, the magnification level changes.

If you press ▲/▼/◀/▶ in the zoom in mode, the zoom point will be shifted.
Pressing the ZOOM button again exits the zoom mode.

■ To play in random order or repeatedly

1 Press ▶ to move highlight to play mode position on the menu.

e.g.

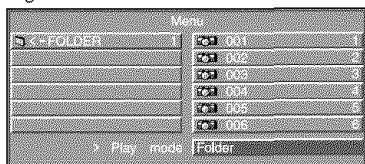

2 Press ▲/▼ to change the play mode.

- Random : Plays the files in the selected folder in random order.
- Repeat Folder : Plays the files in the selected folder repeatedly.
- Repeat File : Plays a selected file repeatedly.

3 Press ▶.

4 Press ▲/▼ to select the file, then press **PLAY** or **ENTER**.

■ Thumbnail mode

e.g.

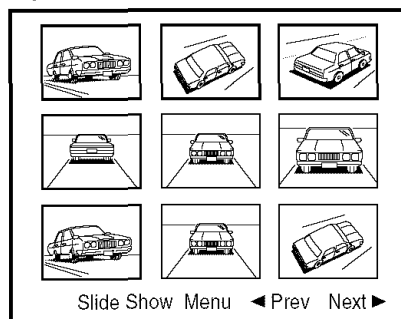

Press **PLAY**.

A slide show begins from the selected picture.
A picture is selected by pressing ▲/▼/◀/▶.

Select [Slide Show] and press **ENTER** or **PLAY**.
A slide show will begin again.

Select [Menu] and press **ENTER** or **PLAY**.
A list of functions keys (buttons) at the time of JPEG files playback will be displayed.

Select [◀ Prev] and press **ENTER** or **PLAY**.
The previous nine pictures will be displayed.

Select [Next ▶] and press **ENTER** or **PLAY**.
The next nine pictures will be displayed.

Press **STOP**.

The menu mode will be entered.

■ To play a Kodak Picture CD

Insert a Kodak Picture CD.
Automatically starts the slide show.

Upon reaching the end, it will enter the thumbnail mode.
Pressing the STOP button will enter the thumbnail mode.

Viewing JPEG Files (continued)

JPEG files compatibility

Discs and pixels whose compatibility with this player has been confirmed by TOSHIBA are as follows.

Kodak Picture CD

JPEG disc compatibility with this player is limited as follows:

- Playable discs: CD-ROM, CD-R, CD-RW
- File system: ISO9660, UDF without interleave
- File name: File names are limited to eight characters or less and must incorporate "JPG" extension.
e.g. "*****.JPG"
File names cannot contain special characters such as "?!><+*}{ [@] ; \ / . , " etc.
- File size: Less than 10M bytes
- File format: BASELINE, PROGRESSIVE
- Resolution: Baseline JPG: 3072x2048
Progressive JPG: width *(height + 128) < 3300000
Files with size < 20M bytes are tested.

Advanced playback

Customizing the performance of your player.

- **Directly Accessing a Specific Location**
- **Repeat Play**
- **Playing in a Favorite Order**
- **Playing in Random Order**
- **Zooming a Picture**
- **Selecting the Sound Enhancement (E.A.M.)**
- **Selecting a Camera Angle**
- **Selecting Subtitles**
- **Selecting a Language**
- **Operating in the On-screen Display Mode**
- **Adjusting the Picture**

Directly Accessing a Specific Location

You can access a specific location by entering its corresponding time (hours, minutes, seconds).

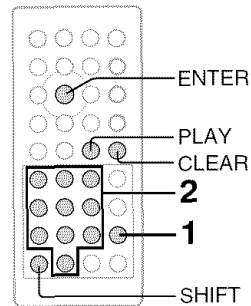

DVD-V VCD CD Entering the time counter of the desired location

1 Press T several times.

The display changes each time this button is pressed. With DVD video disc, press this button until "Time" is displayed. With Video CD/audio CD, press this button until "Disc goto" or "Track goto" is displayed.



e.g. DVD-V

Title 01/03 Time --:--:--

Chapter 01/40 Time --:--:--

e.g. VCD CD

Disc goto :-:--:--

Track goto :-:--:--

Notes

- Pressing the CLEAR button while pressing the SHIFT button resets the numbers.
- This location display will disappear in a few seconds if no further operation is made.
- Some discs may not respond to this process.
- Some scenes may not be located precisely as you specified.

2 Press the number buttons to enter the time.

e.g.



Title 01/03 Time 1:25:30

Playback starts from the desired location.

3 Press PLAY or ENTER.

Playback starts from the selected section.

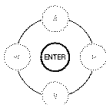

Repeat Play

You can play a specific title, chapter, track, or segment repeatedly. (Title repeat, chapter/track repeat, A-B repeat)

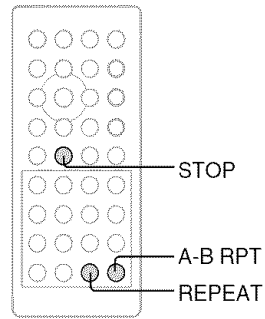
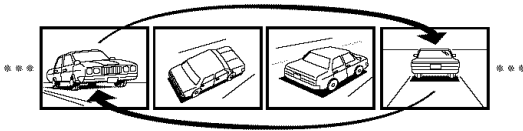

DVD-V VCD CD Repeating a title, chapter, or track

Press REPEAT.

RANDOM



Each time you press the REPEAT button, the repeat mode changes as follows.

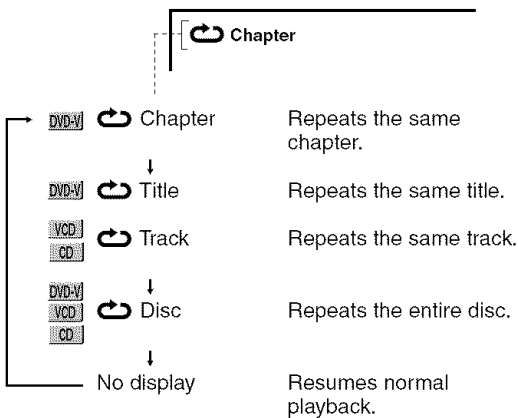

To resume normal playback

Press **REPEAT** repeatedly until the repeat icon disappear.

RANDOM



You can also use **STOP** to exit repeat playback.

Notes

- Some discs may not permit repeat operation.
- You can also use an on-screen display to perform a repeat playback. [42](#)

DVD-V VCD CD Repeating a specific segment

1 Press A-B RPT at the beginning of the segment (point A) you want to play repeatedly.

MEMORY



2 Press A-B RPT again at the end of the segment (point B).

MEMORY



The player automatically returns to point A and starts repeat playback of the selected segment (A-B).



To resume normal playback

Press **A-B RPT** again.

MEMORY



You can also use **STOP** to exit A-B repeat function.

Notes

- Some discs may not permit A-B repeat operation.
- You can specify a segment only within the current title or track.
- You cannot set the A-B repeat function for a segment that includes multiple camera angles [38](#).
- There may be a slight difference between point A and the location where playback actually resumes depending on the disc.

Playing in a Favorite Order

You can combine your favorite titles, chapters, or tracks and play them in the order you determine. You can program up to 20 selections into the memory. (Memory playback)

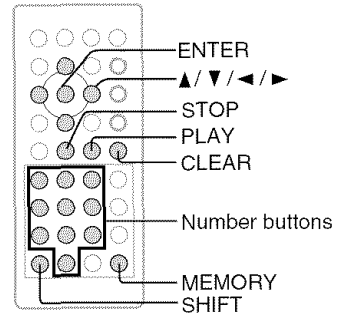

DVD-V VCD CD Setting titles, chapters, or tracks in a favorite order

1 Press MEMORY while pressing SHIFT during stop.

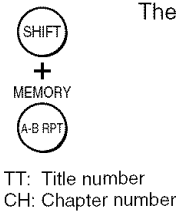

The programming display appears.

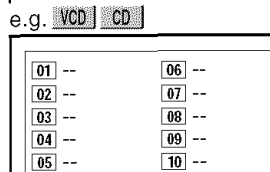
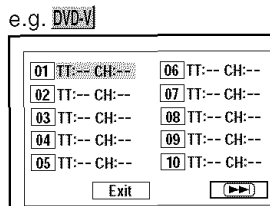

2 Enter the number in the order wish to playback, then press ENTER.

Pressing the ENTER button causes the highlight to move to the next item.

Pressing [Next] will allow you to access the next programming display.

3 Select "Start" using ▼ and press ENTER or PLAY.

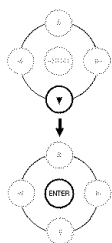

The player starts memory playback.

■ To change the programmed selections

- 1 While the display appears on the screen, press ▲/▼/◀/▶ to move the highlighted bar to the item you want to change.
- 2 Change the selection following the instructions in step 2.

■ To cancel the programmed selections

- 1 While the display appears on the screen, press ▲/▼/◀/▶ to move the highlighted bar to the item you want to cancel.
- 2 Press CLEAR while pressing SHIFT.

■ To resume normal playback from memory playback

- 1 Press MEMORY while pressing SHIFT to display the programming display.
- 2 Since "Stop" is selected, press ENTER.

You can also exit memory playback by pressing STOP.

Notes

- Pressing the CLEAR button while pressing the SHIFT button resets the numbers.
- Some discs may not permit memory playback operation.
- When the display appears on the screen, either selecting "Exit" and pressing the ENTER button or pressing the MEMORY button while holding down the SHIFT button causes the display to be disappeared.
- The programmed selections will be cleared when you turn off the player.

Playing in Random Order

You can play chapters or tracks in random order.
(Random playback)

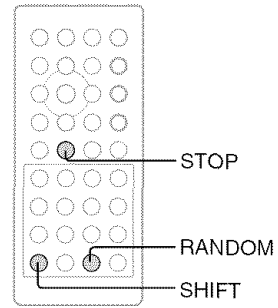

DVD-V VCD CD Playing chapters or tracks in random order

Press RANDOM while pressing SHIFT.

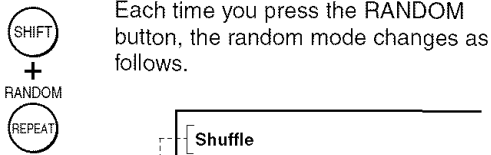

Each time you press the RANDOM button, the random mode changes as follows.

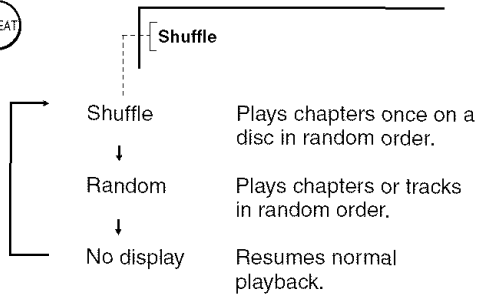

If you press the RANDOM button during playback, the player automatically starts random playback after finishing the current chapter or track.

To resume normal playback

Press **RANDOM** while pressing **SHIFT** repeatedly until the random display disappear.

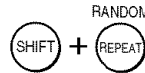

You can also exit random playback by pressing **STOP**.

Note

Some discs may not permit random playback operation.

Zooming a Picture

You can magnify areas within a picture.

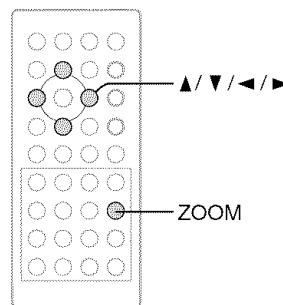
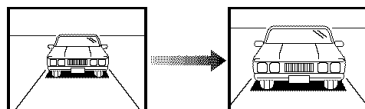

DVD-VCD CD Zooming a picture

1 During normal, slow, still, fast reverse or fast forward playback, press ZOOM.



The player enters the zoom playback mode, and the zoom icon appears.

e.g.

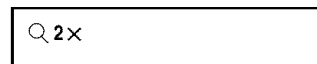

2 Select the zoom point and magnification level.

Magnification level

You can select from the following.

- Magnification
- Image reduction
- Normal playback



Press the **ZOOM** button repeatedly.

Zoom point

To shift:

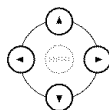

Press **▲ / ▼ / ◀ / ▶** in the zoom in mode.

To exit zoom playback

Press **ZOOM** repeatedly until the zoom icon disappears.



You can also use **STOP** to exit zoom playback.

Notes

- Some discs may not respond to zoom feature.
- During some scenes, the buttons may not work as described.
- Zooming does not work on characters selected on menus.

Selecting the Sound Enhancement (E.A.M.*)

You can easily select a preferred audio enhancement.

*E.A.M.: Enhanced Audio Mode

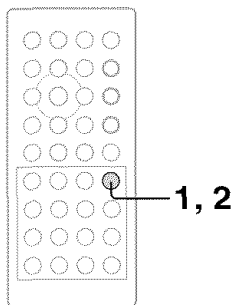

DVD-V VCD CD Selecting the sound enhancement

1 Press E.A.M.



The sound enhancement menu appears.

E.A.M. : Normal

2 Select the sound enhancement by pressing E.A.M.



Each time you press the button, the sound enhancement changes.

Normal: Normal sound.

3D: To obtain expansive virtual surround sound effects from just two speakers.

3D (Headphone):

To obtain expansive virtual surround sound effects when using headphone.

Dialog: To control critical center channel information to make dialogue more intelligible (only when playing a DVD video disc recorded on the Dolby Digital recording system).

- To use this enhancement on sounds output from the BITSTREAM/PCM jack, be sure to set "Audio Out Select" to "PCM." **49**

Notes

- Actual effects to sounds may vary depending on the speaker system. Make the selection to your preference.
- Actual effects to sounds may vary depending on the disc.
- When the player is connected to an amplifier equipped with Dolby Surround Pro Logic, select "Normal". Otherwise, Dolby Surround Pro Logic may function differently than usual.

Selecting a Camera Angle

If a scene was recorded with multiple angles, you can easily change the camera angle of the scene you are viewing.

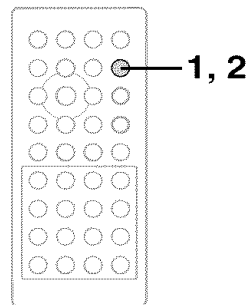
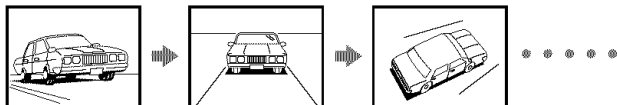

DVD-V
VCD C0

Changing the camera angle

1 Press ANGLE while playing a scene recorded with multiple angles.



While playing a scene recorded with multiple angles, the angle icon (📷) appears on the screen. Press the ANGLE button while the angle icon is displayed.

e.g.

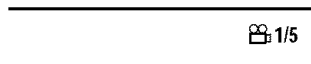

2 Selecting the camera angle by pressing ANGLE.



Each time you press the ANGLE button, the camera angle changes.

Notes

- After selecting angle, it will take a few moments to change the camera angle of the scene you are viewing.
- If you pause a picture immediately after changing a camera angle, the resumed playback picture may not display the new camera angle.
- You can also use an on-screen display to change a camera angle. [42](#)

Selecting Subtitles

You can display subtitles on the screen and select a subtitle language from those included on the DVD video disc.

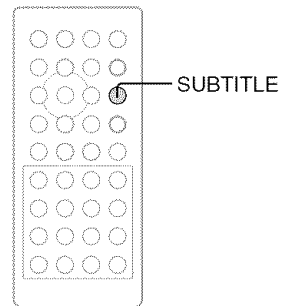
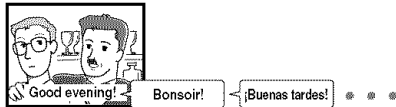

DVD-V VCD CD Selecting a subtitle language

1 Press SUBTITLE during playback.



The current subtitle setting is displayed.

e.g.

Subtitle 01/02 : English

2 Press SUBTITLE while the subtitle setting is displayed on the screen.



Each time you press the SUBTITLE button, the subtitle languages included on the DVD video disc change.

■ To turn subtitles on or off

Press SUBTITLE several times during playback until "Turn off subtitles" is displayed.



Notes

- Some DVD video discs display subtitles automatically, and you cannot turn them off even if you set the subtitle function to off.
- Some DVD video discs will allow you to make subtitle selections and turn subtitles on or off only via the disc menu.
- You can also use an on-screen display to change a subtitle. [42](#)

Notes

- When you select a subtitle language which is not included on the disc, the player plays a prior language programmed on the disc.
- During some scenes, the subtitles may not appear immediately after you change the subtitle language.

Selecting a Language

You can select a preferred language and sound recording system from those included on the disc.

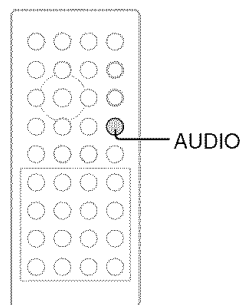
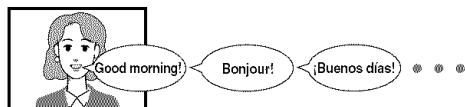

DVD-V
VCD

Selecting a playback audio setting

1 Press AUDIO during playback.



The current audio setting is displayed.

e.g.

Audio 1/3 : Dolby D 3/2.1 Channels English

2 Press AUDIO while the audio setting is displayed on the screen.



Each time you press the AUDIO button, the audio settings included on the DVD video disc change.

■ Selecting sound channels of VIDEO CDs

During playback, press **AUDIO** repeatedly to select the sound channel.



Notes

- Some discs allow you to change audio selections only via the disc menu. If this is the case, press the MENU button and choose the appropriate language from the selections on the disc menu.
- If you select a sound track which is not included on the disc, the player plays a prior sound track programmed on the disc.
- You can also use an on-screen display to change audio settings. [42](#)

■ Output sound conversion table (sampling frequency/quantization bit)

Discs	Sound recording system	Audio selection from the menu [46] / [49] and outputs					
		"Bitstream"		"Analog 2ch"		"PCM"	
		BITSTREAM/PCM jack	Speakers/AV OUT jack/Headphone jacks	BITSTREAM/PCM jack	Speakers/AV OUT jack/Headphone jacks	BITSTREAM/PCM jack	Speakers/AV OUT jack/Headphone jacks
DVD video discs	Dolby Digital	Bitstream	48 kHz/20 bit	Bitstream	48 kHz/20 bit	48 kHz/20 bit	48 kHz/20 bit
	Linear PCM	48 kHz/16 bit	48 kHz/16 bit	48 kHz/16 bit	48 kHz/16 bit	48 kHz/16 bit	48 kHz/16 bit
		48 kHz/20 bit	48 kHz/20 bit	48 kHz/20 bit	48 kHz/20 bit	48 kHz/20 bit	48 kHz/20 bit
		48 kHz/24 bit	48 kHz/24 bit	48 kHz/24 bit	48 kHz/24 bit	48 kHz/24 bit	48 kHz/24 bit
		96 kHz/16 bit	96 kHz/16 bit	96 kHz/16 bit	–	96 kHz/16 bit	96 kHz/16 bit
		96 kHz/20 bit	96 kHz/20 bit	96 kHz/20 bit	–	96 kHz/20 bit	96 kHz/20 bit
	96 kHz/24 bit	96 kHz/24 bit	96 kHz/24 bit	–	96 kHz/24 bit	96 kHz/24 bit	
	DTS	Bitstream	–	Bitstream	–	–	–
MPEG1, MPEG2	Bitstream	48 kHz/16 bit	Bitstream	48 kHz/16 bit	48 kHz/16 bit	48 kHz/16 bit	
VIDEO CDs	MPEG1	44.1 kHz/16 bit	44.1 kHz/16 bit	44.1 kHz/16 bit	44.1 kHz/16 bit	44.1 kHz/16 bit	
Audio CDs	Linear PCM 44.1 kHz/16 bit	44.1 kHz/16 bit	44.1 kHz/16 bit	44.1 kHz/16 bit	44.1 kHz/16 bit	44.1 kHz/16 bit	
	DTS	Bitstream	(Noise)	Bitstream	(Noise)	Bitstream	(Noise)

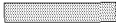
 : 3D sound enhancement can function.
(Signals are depressed by down sampling process.)

- Signals of 88.2kHz or higher from the BITSTREAM/PCM jack are down converted to 44.1 kHz or 48 kHz when:
 - "3D" is selected. **[37]**
 - a copyright protected disc is played.
- Quantization will be limited to 16 bits in a copyright protected disc.

Operating in the On-screen Display Mode

When you turn on the on-screen display, you can view information on operational status and access features and settings.

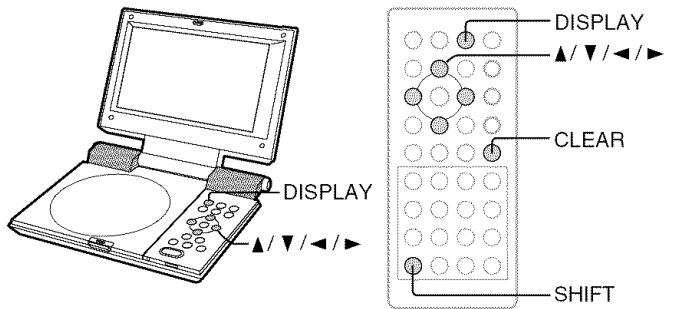

DVD-V VCD CD On-Screen Display Operation

1 Press DISPLAY during playback.



The following display appears.

e.g.

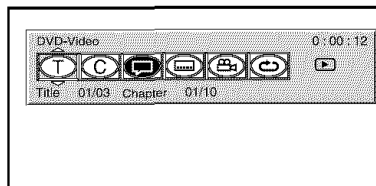

2 Press ◀/▶ to select item.

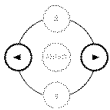

3 Change the selection by ▲/▼.

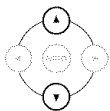

■ When playing a DVD video disc

e.g.

Current title number Current chapter number Elapsed time of the current title

Note

Some discs may not be compatible with a set of these operations.

■ To turn off the display

Press **DISPLAY** or **CLEAR** while pressing **SHIFT**.

Note

Doing nothing for approx. 10 seconds will eliminate the display.

■ When playing a VIDEO CD or audio CD

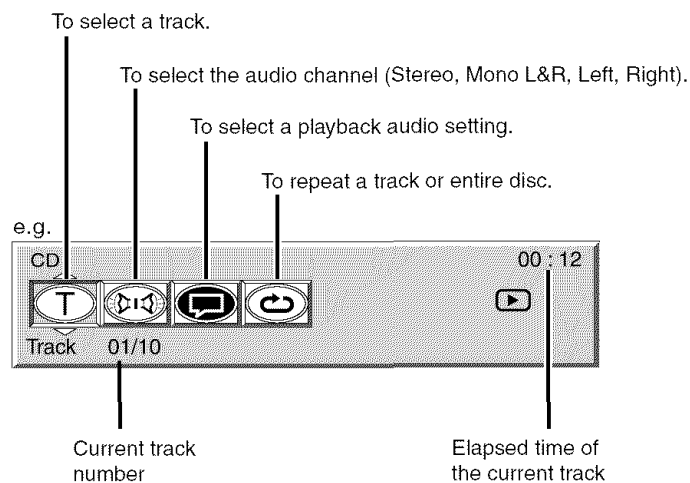

Note

Some discs may not be compatible with a set of these operations.

Adjusting the Picture

You can easily select a preferred picture.

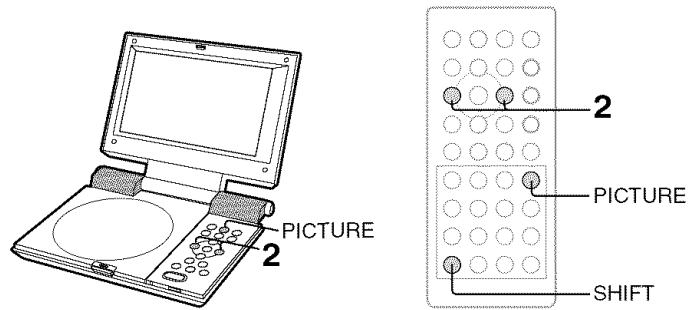

DVD-V VCD CD Adjusting the picture

1 Press **PICTURE** while pressing **SHIFT**. Alternatively press **PICTURE** on the main unit.



The picture setting display appears.

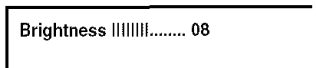

Each time you press the button, the setup items changes as follows.



- Brightness
- ↓
- Color
- ↓
- Screen
- ↓
- No display

2 Press **◀/▶** to adjust the value.

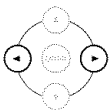

- Brightness : 0 (Darker) to 16 (Brighter)
- Color : 0 (Paler) to 16 (Deeper)
- Screen :
 - Enhanced
 - ↓
 - Normal

Function setup

You can change the default settings to *customize* performance to your preference.

- **Customizing the Function Settings**

Customizing the Function Settings

You can change the default settings to customize performance to your preference.

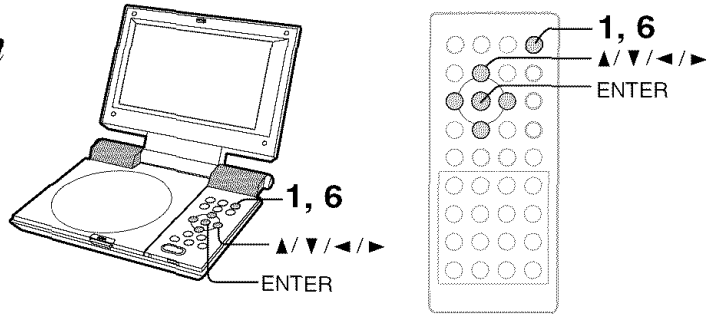

DVD-V
VCD CD

Setting procedure

1 Press SETUP during stop.



The following on-screen display appears.

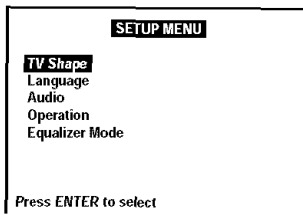

2 Press ▲/▼ to select the setting you want to change, then press ENTER.

(See the next page.)

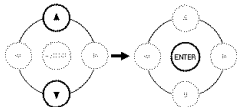

e.g.

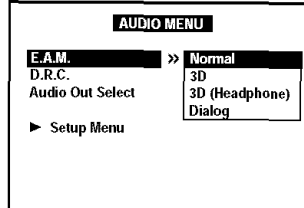

3 Press ▲/▼ to select the setting you want to change, then press ►.

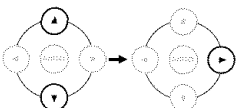

e.g.

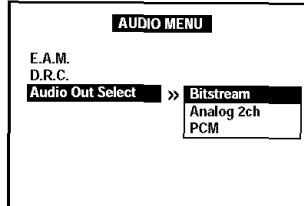

4 Change the selection by ▲/▼, by referring to the corresponding pages 47, then press ENTER.

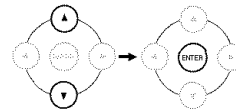

e.g.

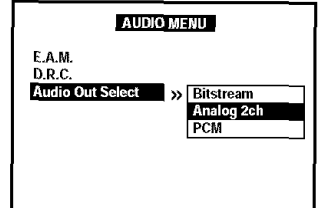

5 Press ◀, then repeat steps 3 and 4 to change other settings.

To return to the first menu for the SETUP, press ▼ to select "Setup Menu" and press ENTER.



























6 Press SETUP.



The on-screen display disappears.

Note

The SETUP button is functional even during the playback or during the stop time (STOP button pressed once) for resuming the playback. Some operations, however, are not accessible. In this case, press the STOP button twice to disable the playback to be resumed for further setup.

	Setting		Details	Page
TV Shape	TV Shape		To select a picture size according to the aspect ratio of your TV.	48
Language	On-screen	  	To select a preferred language for on-screen displays.	48
	Audio		To select a preferred language for the sound track.	48
	Subtitle		To select a preferred language for subtitles.	48
	Disc Menu		To select a preferred language for disc menus.	48
Audio	E.A.M.	  	You can easily switch to a preferred audio enhancement.	49
	D.R.C.		To turn on or off a function that makes faint sounds easier to hear even if you lower the volume during late hours playback.	49
	Audio Out Select	  	To select an output sound format corresponding to your system connection.	49
Operation	Parental		To turn the parental lock function on or off.	50
	PBC		To use the menu screen when playing a PBC-controllable VIDEO CD.	51
	Screen Saver		To turn the screen saver on or off.	51
	Menu Style	  	You can change setup menu configuration.	51
	Default	  	To restore all settings to the factory set.	51
Equalizer Mode	EQ Mode	  	You can select a preferred equalizer mode.	51

Customizing the Function Settings (continued)

Setting details

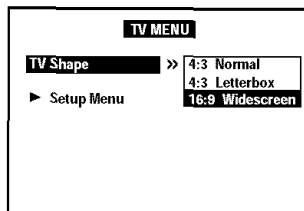

TV Shape DVD-V

4:3 Normal: Select when a standard 4:3 TV is connected. Displays pictures cropped to fill your TV screen. Either or both sides of the picture are cut off.



4:3 Letterbox: Select when a standard 4:3 TV is connected. Displays theatrical images with masking bars above and below the picture. When playing a source of 16:9 picture size.



16:9 Widescreen: Select when a 16:9 wide TV is connected. Use this setting when using the player's LCD monitor.

Notes

- The displayable picture size is preset on the DVD video disc. Therefore, the playback picture of some DVD video discs may not conform to the picture size you select.
- When you play DVD video discs recorded in the 4:3 picture size only, the playback picture always appears in the 4:3 picture size regardless of the TV shape setting.
- If you select "16:9 Widescreen" and you own a 4:3 TV set, the DVD playback picture will be horizontally distorted during playback. Images will appear to be horizontally compressed. Always be sure that your TV shape conforms to the actual TV in use.

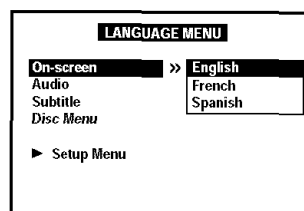

On-Screen DVD-V | VCD | CD

English: To view on-screen displays in English.
 French: To view on-screen displays in French.
 Spanish: To view on-screen displays in Spanish.

Audio DVD-V

English: To play sound tracks in English.
 French: To play sound tracks in French.
 Spanish: To play sound tracks in Spanish.

Note

Some DVD video discs may be played in a different language than you selected. A prior language may be programmed on the disc.

Subtitle DVD-V

English: To display subtitles in English.
 French: To display subtitles in French.
 Spanish: To display subtitles in Spanish.

Notes

- Some DVD video discs may be set to display subtitles in a different language than you selected. A prior subtitle language may be programmed on the disc.
- Some DVD video discs allow you to change subtitle selections only via the disc menu. If this is the case, press the MENU button and choose the appropriate subtitle language from the selection on the disc menu.

Disc Menu DVD-V

English: To display disc menus in English.
 French: To display disc menus in French.
 Spanish: To display disc menus in Spanish.

Note

Some DVD video discs may not include your pre-selected language. In this case, the player automatically displays disc menus consistent with the disc's initial language setting.

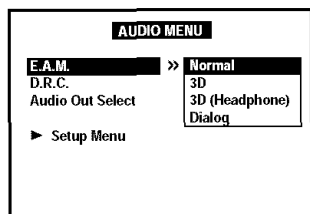

E.A.M. DVD-V | VCD | CD

You can obtain expansive virtual surround sound effects from just two speakers.

Normal: Normal sound.

3D: To obtain expansive virtual surround sound effects from just two speakers.

3D (Headphone): To obtain expansive virtual surround sound effects when using headphone.

Dialog: To control critical center channel information to make dialogue more intelligible (only when playing a DVD video disc recorded on the Dolby Digital recording system).

- To use this enhancement on sounds output from the BITSTREAM/PCM jack, be sure to set "Audio Out Select" to "PCM."

Note

Pressing the E.A.M. button on the remote control also allows you to achieve the same setup. [37](#)

D.R.C. DVD-V

Turn on or off a function that makes faint sounds easier to hear even if you lower the volume during late hours playback.

D.R.C. = Dynamic Range Control

ON : Dynamic range is reduced.

OFF: Full dynamic range is maintained.

Notes

- This function works only during playback of Dolby Digital recorded discs.
- The level of Dynamic Range Reduction may differ depending on the DVD disc.

Audio Out Select DVD-V | VCD | CD

Select the output sound format corresponding to your system connection.

For details of sound recording systems, see [41](#).

Bitstream: Select when connected to an amplifier equipped with a Dolby Digital, DTS, MPEG1 or MPEG2 decoder. [58](#) [59](#)
The player outputs digital audio information in the bitstream format when you play a DVD video disc recorded in the Dolby Digital, DTS, MPEG1 or MPEG2 recording system.

Analog 2ch: Select when connected to a TV, or Dolby Pro Logic or stereo system via the analog audio jacks. [54](#) [58](#)

PCM: Select when connected to a 2 channel digital stereo amplifier. [60](#)
The player outputs sounds in the PCM 2ch format when you play a DVD video disc recorded on the Dolby Digital, MPEG1 or MPEG2 recording system.

Customizing the Function Settings (continued)

Setting details

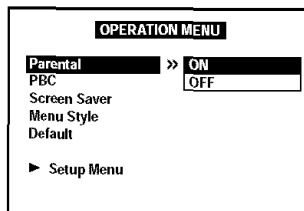

Parental DVD-V

DVD video discs equipped with the parental lock function are rated according to their content. The contents allowed by a parental lock level and the way a DVD video disc can be controlled may vary from disc to disc. For example, if the disc allowed you could edit out violent scenes unsuitable for children and replace them with more suitable scenes, or lock out playback of the disc altogether.

- DVD video discs may or may not respond to the parental lock settings. This is not a defect in the player. Make sure this function works with your DVD video discs.

ON : To activate the parental lock feature or change the settings.

After pressing the ENTER button, follow steps 1) - 4) below.

OFF : The parental lock feature does not function. After pressing the ENTER button, follow step 1) below.

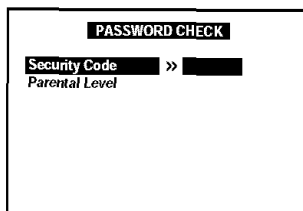

1) Press the number buttons to create a personal 5-digit security code.

2) Press ▲ / ▼ to select the parental lock level, then press the ENTER button.

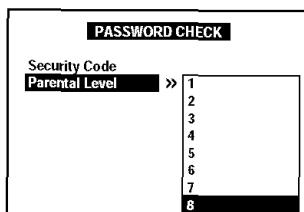

3) Press ◀.

4) Press ▼ to select "Operation", then press the ENTER button.

You cannot play DVD video discs rated higher than the level you selected unless you cancel the parental lock function.

For example, when you select level 7, discs rated higher than level 7 are locked out and cannot be played.

The parental lock level is equivalent to the following USA movie ratings.

Level 7: NC-17

Level 6: R

Level 4: PG 13

Level 3: PG

Level 1: G

The parental lock levels for other countries/areas than U.S. are included for future use. Check the appropriate parental lock level when you buy a DVD video disc equipped with the parental lock feature in the future.

■ To change the parental lock level

Follow steps 1) - 4).

■ To change your 5-digit security code

1) After selecting "ON" or "OFF," press the 9 button five times.

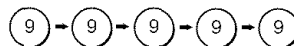

The 5-digit security code is cleared.

2) Press the number buttons to create a new 5-digit security code.

PBC [VCD]

ON : To use the menu when playing a PBC-featured VIDEO CD.

OFF: When playing a VIDEO CD without using the menu.

Screen Saver [DVD-V] [VCD]

ON : The screen saver operates.

OFF: The screen saver is disengaged.

Menu Style [DVD-V] [VCD] [CD]

You can change setup menu configuration.

Type1 : Setup menu is displayed in type1 configuration.

Type2 : Setup menu is displayed in type2 configuration.

Default [DVD-V] [VCD] [CD]

Reset : To restore settings to the factory set.

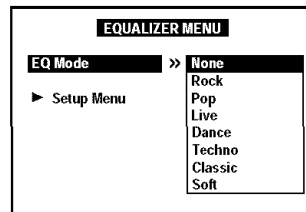
**EQ Mode** [DVD-V] [VCD] [CD]

You can select a preferred equalizer mode.

None : Equalizer is not used.

Rock : Equalizer mode for Rock.

Pop : Equalizer mode for Pop.

Live : Equalizer mode for Live.

Dance : Equalizer mode for Dance.

Techno : Equalizer mode for Techno.

Classic : Equalizer mode for Classic.

Soft : Equalizer mode for Soft.

Connections

You can connect the player to a TV or audio system. Also, you can connect a battery pack to power the player.

- **Connecting to a TV or audio system**
- **Connecting to Headphones**
- **Connecting to Audio Equipment**
- **Using the Battery Pack**
- **Using the automobile/vehicle adapter or power port**

Connecting to a TV or audio system

Connect the player to your TV or audio system.

For details of output sound, see **41**.

Connecting to a TV

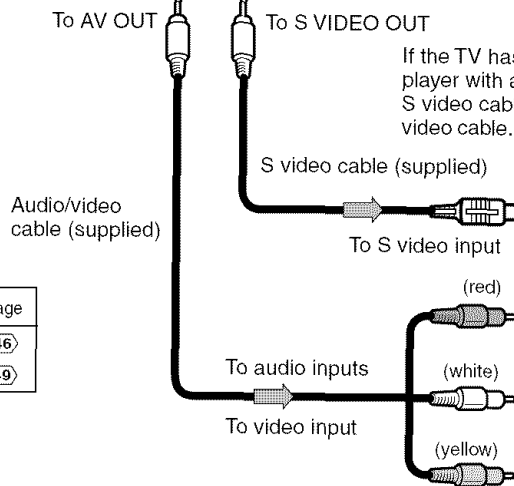
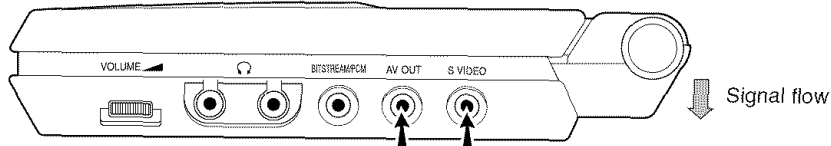

If the TV has an S video input, connect the player with an S video cable. When using an S video cable, do not connect the yellow video cable.

TV or monitor with audio/video inputs

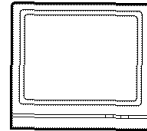

• Make the following setting.

On-screen display	Select:	Page
"Audio Out Select"	"Analog 2ch"	46 49

Notes

- Refer to the owner's manual of the connected TV as well.
- When you connect the player to your TV, be sure to turn off the power and unplug both units from the wall outlet before making any connections.
- Connect the player directly to your TV. If you connect the player to a VCR, TV/VCR combination or video selector, the playback picture may be distorted as DVD video discs are copy protected.

Selecting a monitor to view

Rear view

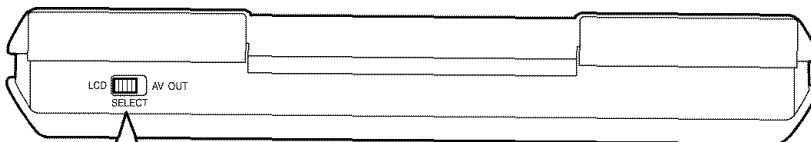

Slide the SELECT switch.



AV OUT: To use a connected TV or monitor.

LCD: To use the LCD of this player.

Note

If you switch the monitor using the SELECT switch during playback, a theme image momentarily appears, then the playback resumes. Depending on the disc or the contents, playback may start from another scene.

Connecting to an audio system

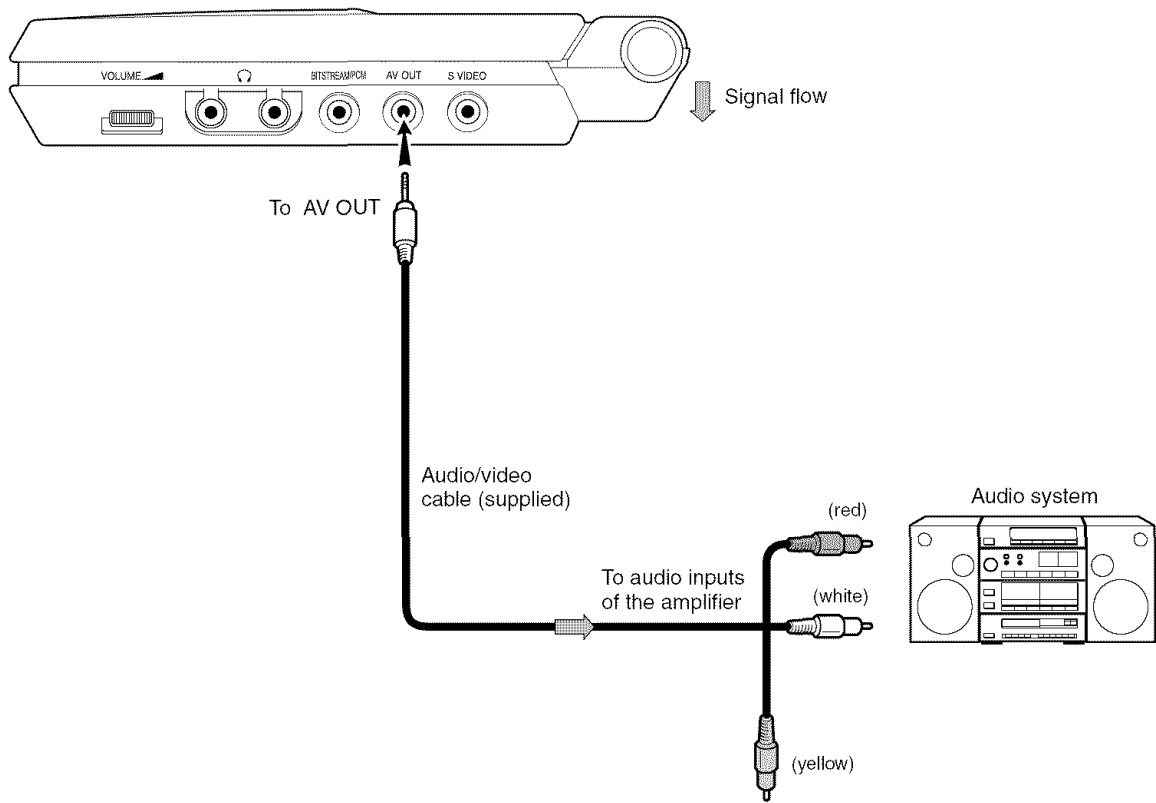

When the AV OUT or BITSTREAM/PCM jacks are connected to the audio input terminals of an audio system, sounds of discs can be heard on the connected audio system. For instructions on connections to audio systems, see also page [57](#).

- Make the following setting.

On-screen display	Select:	Page
"Audio Out Select"	"Analog 2ch"	46
		49

Notes

- Refer to the owner's manual of the connected equipment as well.
- When you connect the player to other equipment, be sure to turn off the power and unplug all of the equipment from the wall outlet before making any connections.
- If you place the player near a tuner or radio, the radio broadcast sound might be distorted. In this case, place the player away from the tuner and radio.
- The output sound of the player has a wide dynamic range. Be sure to adjust the receiver's volume to a moderate listening level. Otherwise, the speakers may be damaged by a sudden high volume sound.
- Turn off the amplifier before you connect or disconnect the player's power cord. If you leave the amplifier power on, the speakers may be damaged.

Connecting to Headphones

You can listen to movies and music privately by connecting headphones.

Caution

When you use headphones, keep the volume at a moderate level. If you use the headphones continuously with high volume sound, it may cause hearing damage.

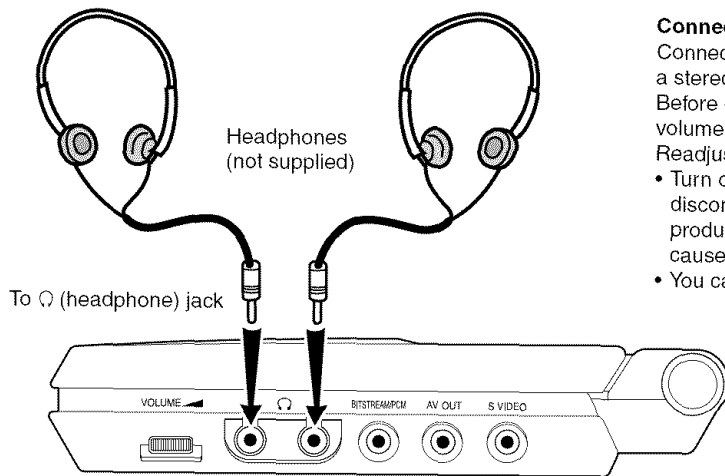

Connecting headphones

Connect headphones to the headphone jack using a stereo mini plug.

Before connecting, temporarily turn down the volume with the headphone volume control.





Readjust to your preference when playback starts.

- Turn off the player before you connect or disconnect the headphone cable. Possible shakes produced by plug connecting/disconnecting may cause damage to the disc.
- You can connect up to 2 headphones.

Connecting to Audio Equipment

You can enjoy high quality dynamic sounds by connecting the player to audio equipment.

- For connection to your TV, see “Connecting to a TV” [54](#).
- For details of output sound, see [41](#).
- This section uses the following reference marks.

-  : Front speaker
-  : Rear speaker
-  : Sub woofer
-  : Center speaker
-  : Signal flow

Notes

- DO NOT connect the BITSTREAM/PCM (DIGITAL) AUDIO OUT jack of the player to the AC-3 RF input of a Dolby Digital Receiver. This input on your A/V Receiver is reserved for Laserdisc use only and is incompatible with the BITSTREAM/PCM (DIGITAL) AUDIO OUT jack of the player.
- Connect the BITSTREAM/PCM (DIGITAL) AUDIO OUT jack of the player to the “DIGITAL (OPTICAL)” or “DIGITAL (COAXIAL)” input of a Receiver or Processor.
- Refer to the owner’s manual of the connected equipment as well.
- When you connect the player to other equipment, be sure to turn off the power and unplug all of the equipment from the wall outlet before making any connections.
- The output sound of the player has a wide dynamic range. Be sure to adjust the receiver’s volume to a moderate listening level. Otherwise, the speakers may be damaged by a sudden high volume sound.
- Turn off the amplifier before you connect or disconnect the player’s power cord. If you leave the amplifier power on, the speakers may be damaged.

Warning

- When you are connecting (via the BITSTREAM/PCM (DIGITAL) AUDIO OUT jack) an AV decoder that does not have Dolby Digital, Digital Theater Systems (DTS) or MPEG2 decoding function, be sure to set “Audio Out Select” to “PCM” from the on-screen displays [46](#) [49](#). Otherwise, high volume sound may damage your hearing as well as the speakers.
- When playing DTS-encoded discs (audio CDs), excessive noise may be output from the analog audio output jacks. To avoid possible damage to the audio system, you should take proper precautions when the analog audio output jacks of the player are connected to an amplification system. To enjoy DTS Digital Surround™ playback, an external 5.1 channel DTS Digital Surround™ decoder system must be connected to the BITSTREAM/PCM (DIGITAL) AUDIO OUT jack of the player.

Connecting to Audio Equipment (continued)

Connecting to an amplifier equipped with a Dolby Digital decoder

Dolby Digital

Dolby Digital is the surround sound technology used in theaters showing the latest movies, and is now available to reproduce this realistic effect in the home. You can enjoy motion picture and live concert DVD video discs with this dynamic realistic sound by connecting the player to a 6 channel amplifier equipped with a Dolby Digital decoder or Dolby Digital processor. If you have a Dolby Surround Pro Logic decoder, you will obtain the full benefit of Pro Logic from the same DVD movies that provide full 5.1-channel Dolby Digital soundtracks, as well as from titles with the Dolby Surround mark.

Manufactured under license from Dolby Laboratories. "Dolby", "Pro Logic", and the double-D symbol are trademarks of Dolby Laboratories.

- Use DVD video discs encoded via the Dolby Digital recording system.
- Make the following setting.

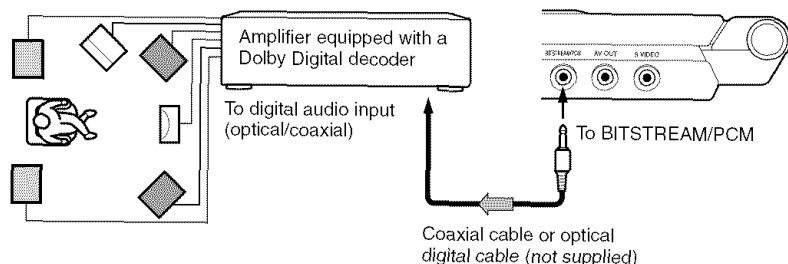

On-screen display	Select:	Page
"Audio Out Select"	"Bitstream"	46 49
Recording system	Dolby Digital	41

Connecting to an amplifier equipped with Dolby Surround Pro Logic

Dolby Surround Pro Logic

You can enjoy the dynamic realistic sound of Dolby Surround Pro Logic by connecting an amplifier and speaker system (right and left front speakers, a center speaker, and one or two rear speakers).

• With an amplifier equipped with Dolby Digital

Connect the equipment the same way as described in "Connecting to an amplifier equipped with a Dolby Digital decoder." Refer to that amplifier's owner's manual and set the amplifier so you can enjoy Dolby Surround Pro Logic sound.

• With an amplifier not equipped with Dolby Digital

Connect the equipment as follows.

- Make the following setting.

On-screen display	Select:	Page
"Audio Out Select"	"Analog 2ch"	46 49

Be sure to set "Audio Out Select" to "Analog 2ch" when you enjoy sounds of Dolby Surround Pro Logic using this connection.

* Connect one or two rear speakers. The output sound from the rear speakers will be *monaural* even if you connect two rear speakers.

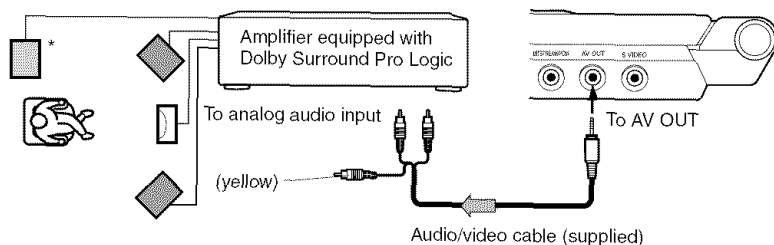

Connecting to an amplifier equipped with a DTS decoder

Digital Theater Systems (DTS)

DTS is a high quality surround technology used in theaters and now available for home use, on DVD video discs or audio CDs.

If you have a DTS decoder or processor, you can obtain the full benefit of 5.1 channel DTS encoded sound tracks on DVD video discs or audio CDs.

"DTS" and "DTS Digital Surround" are trademarks of Digital Theater Systems, Inc.

- Use DVD video discs or audio CDs encoded via the DTS recording system.
- Make the following setting.

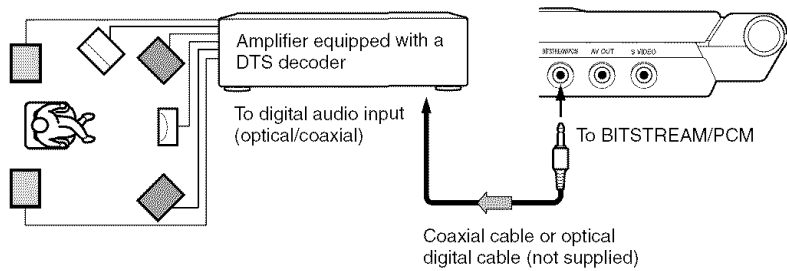

On-screen display	Select:	Page
"Audio Out Select"	"Bitstream"	46 49
Recording system	DTS	41

Connecting to an amplifier equipped with an MPEG2 audio decoder

MPEG2 sound

You can enjoy motion picture and live concert DVD video discs with dynamic realistic sound by connecting an amplifier equipped with an MPEG2 audio decoder or MPEG2 audio processor.

- Use DVD video discs encoded via the MPEG2 recording system.
- Make the following setting.

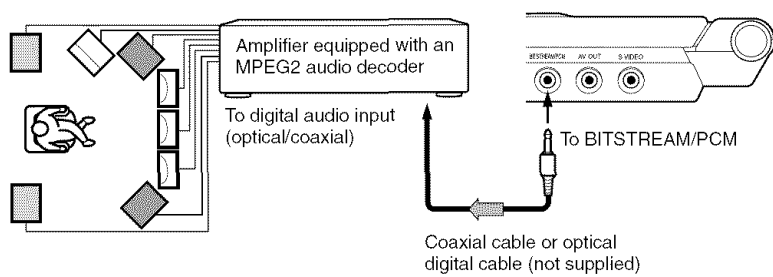

On-screen display	Select:	Page
"Audio Out Select"	"Bitstream"	46 49
Recording system	MPEG2	41

Connecting to Audio Equipment (continued)

Connecting to an amplifier equipped with a digital audio input

2 channel digital stereo

You can enjoy the dynamic sound of 2 channel digital stereo by connecting an amplifier equipped with a digital audio input and speaker system (right and left front speakers).

- Make the following setting.

On-screen display	Select:	Page
"Audio Out Select"	"PCM"	46
		49

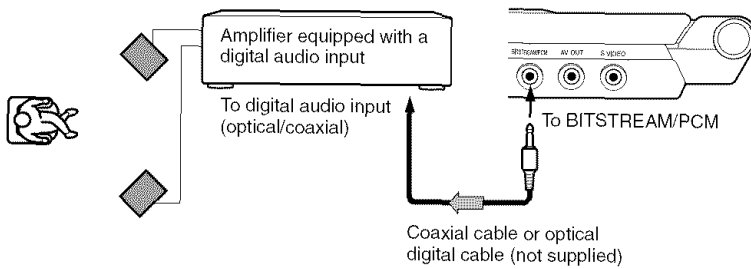

Using the Battery Pack

Warning

- Do not use a battery pack other than one specified as it can result in a fire or damage to the unit.
- Do not heat, open, or short-circuit the battery pack. Do not throw the battery pack into a fire. Doing so may cause an explosion or a fire.
- Attach the battery pack properly following the explanation below. Make sure that the battery pack is attached firmly to the player when using it. Otherwise, the battery pack may become detached and cause personal injury.

Charge it before using.

■ Attaching the battery pack

First disconnect the AC adapter and the power cord from the player, then attach the battery pack.

- 1 Turn the player off.
- 2 Turn the player upside down.
- 3 Remove the connector cover on the bottom of the player.

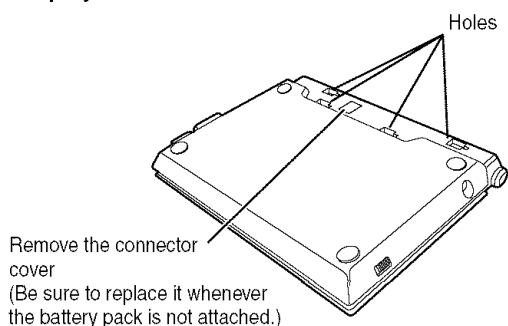

- 4 Turn the battery pack over and insert four catches into the player's corresponding holes. Then, slide the battery pack in the direction of the arrow ② until a "click" is heard.

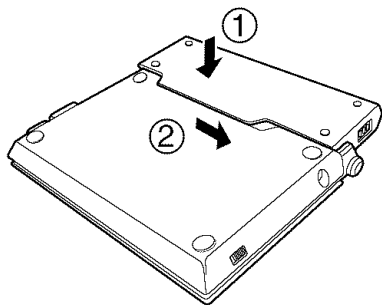

Notes

- Remove the battery pack from the player after being used.
- Attaching the battery pack disables the LCD/AV OUT SELECT switch. Before attaching the battery pack, confirm the setting of the switch.

■ Charging the battery pack

1 Turn the player off.

The battery pack will be charged only when the POWER to the player is turned OFF.

2 Attach the battery pack to the player.

3 Connect the specified AC adapter and the power cord to the player. 16

Charging starts, and the POWER/CHG indicator illuminates in orange.

When the charging is completed, the POWER/CHG indicator turns off.

Notes

- While the charge is in progress, do not disconnect the AC adapter and the power cord until the POWER/CHG indicator turns off.
- The attached battery pack may get warm when you are charging it or operating the player. This is not a defect.
- The battery indicator is shown in the upper left corner of the screen when the power in the battery pack is running low.
- Charge the battery pack with a surrounding temperature of +10°C to +30°C.

■ Charging time of a battery pack

Approximately 4 hours

The battery pack can be charged only when the DVD player is switched OFF. Charging time depends on environmental conditions.

■ Continuous playback time while using the battery pack

Up to approximately 3 hours

(Conditions: 25°C, output from the speakers, new battery pack in use.)

- Continuous playback time may vary depending on battery pack status, operational status and environment conditions.
- Low temperature will shorten the playback time.

Using the Battery Pack (continued)

■ Detaching the battery pack

- 1 Turn the player off.
- 2 Disconnect the AC adapter and the power cord from the player.
- 3 Turn the player upside down.
- 4 Slide the battery pack's lock switch in the direction of the arrow ①, then slide the battery pack in the direction of the arrow ② to remove it.

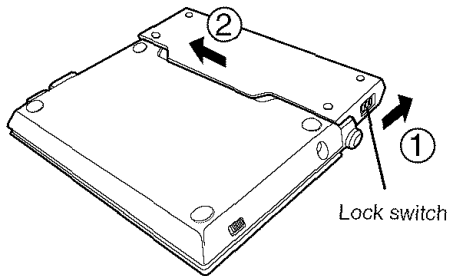

- 5 Replace the connector cover on the bottom of the player.

Note

Do not detach the battery pack while the POWER/CHG indicator illuminates in green or orange.

■ About battery pack life

Battery pack has a duration life. When the playback time becomes remarkably shorter, even if the battery pack is fully charged, change to a new battery pack (SD-PBP14).

Using the automobile/vehicle adapter or power port

For use of the DVD player in a car, this adapter can power the DVD player from the cigarette lighter socket.

Warning

- NEVER operate the DVD player or view a DVD Video while operating an automobile or other vehicle. Note: doing so is illegal in many jurisdictions.
NEVER place a DVD player within the eyesight of a driver while he/she is driving an automobile/vehicle. Note: A DVD player located in the front seating section of a vehicle is illegal in many jurisdictions.
Failure to observe the above instructions could result in the driver's inattention to and/or distraction from road hazards.
- NEVER place a DVD player in a location where it could interfere with the proper deployment and/or performance of an air bag.
Failure to observe this instruction could result in the prevention of an air bag to properly and/or effectively deploy.
- Do not use an adapter other than the model supplied, to power the player. Do not use the supplied vehicle adapter to power an apparatus other than this player. Neglecting these may cause smoke, fire or electrical shock to human body.
- This adapter is intended for exclusive use in automobiles/vehicles with a DC 12V negative ground electrical system. NEVER use this adapter with a DC 24V configured automobile/vehicle.
Consult your vehicle owner's manual before using this adapter.
- ALWAYS use caution when touching the adapter, cigarette lighter socket or power port. The adapter, lighter socket and power port may become heated after prolonged use.
- Do not charge the battery pack which is attached to the DVD player by the adapter. Doing so may cause smoke, fire or electrical shock to human body. Whenever you use the adapter, be sure to remove the battery pack from the DVD player to prevent it being charged by the adapter.
- Do not touch the adapter with wet hands. Do not liquid over the adapter.

Notes

- Never operate the player in a moving vehicle.
Vibration may prevent proper playback of the player or cause damage to the disc.
- Do not leave the adapter in an unoccupied vehicle to avoid exposing it to unusually high ambient temperatures.
- Remove the adapter power plug from the cigarette lighter socket or power port before turning the engine off.
- When the DVD player is not in use be sure to remove the adapter power plug from the cigarette lighter socket or power port and the pin plug from the DVD player.
- Do not force the adapter into an incompatible lighter socket or power port.
- Avoid dropping the adapter or placing heavy objects on it.
- Do not pull the adapter power cord when removing it from a socket or power port.
Always grasp and pull the body.
Failure to do so could cause damage to and malfunction of the adapter.
- Do not operate the DVD player using the adapter for a prolonged period with the car engine off. The car battery may be too exhausted to turn the engine on.
- Depending on the vehicle model or the location of the cigarette lighter socket, this adapter may not be applied.

■ Instructions for Use

- 1 Turn off the DVD player.
- 2 Insert the pin plug of the adapter into the DC IN 12V jack of the DVD player.

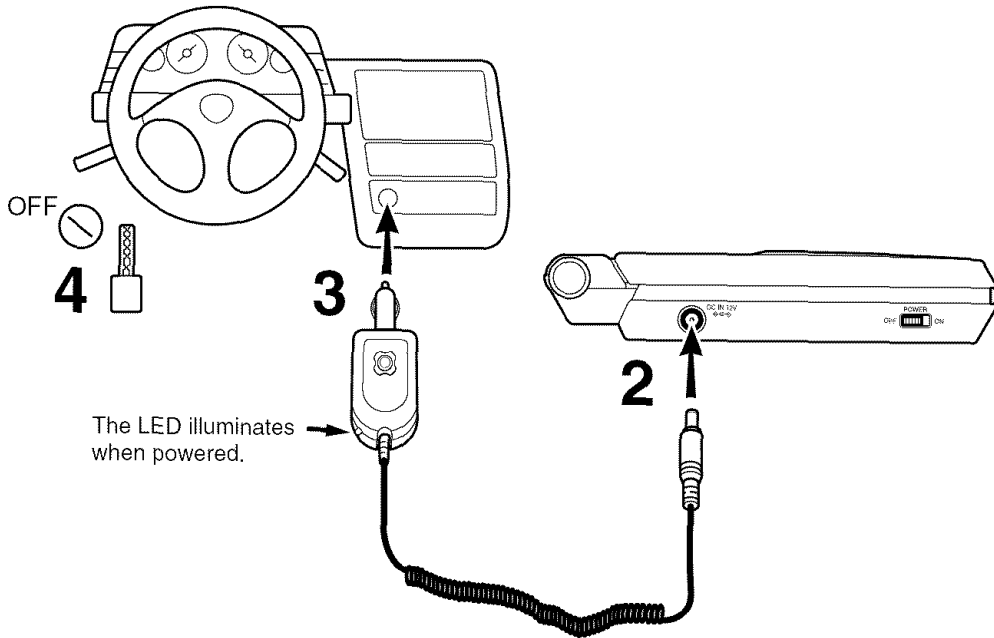

- 3 Insert the plug of the adapter into the cigarette lighter socket or power port fully.
- 4 Turn on the vehicle engine so that the cigarette lighter socket or power port is powered. In some vehicles the cigarette lighter socket or power port is powered even when the vehicle's engine is not running. It is important that the vehicle owner's manual be consulted.
- 5 When disconnecting the DVD player, first remove the adapter pin plug from the DVD player and then the power plug from the cigarette lighter socket or power port.

Specification

Operating temperature:	5 – 35°C
Operating humidity:	30 – 80%
Storage temperature:	-10 – 60°C
Storage humidity:	20 – 80%

Others

- Before Calling Service Personnel
- Specifications
- LIMITED WARRANTY
PORTABLE DVD PLAYER

Before Calling Service Personnel

Check the following guide for the possible cause of a problem before contacting service.

Symptoms and correction

Symptom	Cause	Correction	Page
No power.	• The AC adapter or power plug is disconnected.	• Connect the AC adapter or power plug securely.	16
	• The battery pack has been removed.	• Install the battery pack.	61
	• Battery empty.	• Re-charge the battery.	61
The LCD turned off by itself.	• The automatic LCD off function turned the LCD off.	• Press any button.	21
No picture. (Other than built-in LCD monitor)	• The connected TV is not set to receive DVD signal output.	• Select the appropriate video input mode on the TV so the picture from the player appears on the TV screen.	18
No sound.	• The equipment connected via the audio/video cable is not set to receive DVD signal output.	• Select the correct input mode of the audio receiver so you can listen to the sound from the player.	54 , 55
	• The volume is too low.	• Adjust the volume by turning the volume control.	20
	• The audio receiver or TV is turned off.	• Turn on the equipment connected with the audio/video cable.	54 – 60
	• The setting of output sound format is incorrect.	• Select the proper audio setting.	40, 46 49
The playback picture has occasional distortion.	• The disc is dirty.	• Eject the disc and clean it.	8
	• Player is in fast forward or fast reverse mode.	• Sometimes a small amount of picture distortion may appear. This is not a malfunction.	–
	• The main unit was moved or given a shock.	• Vibrating or shaking the unit during playback may produce distortion. This is not a malfunction. If not restored to usual status, stop playback and start again.	–
	• The disc is not set firmly.	• Remove the disc and set it again.	18
Brightness is unstable or noises are present in the playback pictures. (Other than built-in LCD monitor)	• The effect of copy protection.	• Connect the player directly to the TV. Avoid connecting the player to a VCR or TV/VCR combination.	54
The player does not start playback.	• No disc is inserted.	• Insert a disc.	18
	• An unplayable disc is inserted.	• Insert a playable disc. (Check the disc type, color system and region number.)	9
	• The disc is inserted upside down.	• Insert the disc with the playback side down.	18
	• The disc is not inserted securely.	• Insert the disc securely in the disc holder.	18
	• The disc is dirty.	• Clean the disc.	8
	• The parental lock function is set.	• Cancel the parental lock function or change the parental lock level.	50
Playback does not follow the course of the disc's program.	• It is in the repeat playback mode, memory playback, etc.	• These operations may prevent a proper progression of the contents.	–
Buttons do not work.	• Power supply fluctuations or other abnormalities such as static electricity may interrupt correct operation.	• Turn the power on or off with the POWER switch. Or disconnect the power plug and insert it into the wall outlet again.	–

Symptom	Cause	Correction	Page
The remote control does not work properly.	• The remote control is not pointed at the remote sensor of the player.	• Point the remote control at the remote sensor of the player.	15
	• The remote control is too far from the player.	• Operate the remote control within about 3 m.	15
	• The batteries in the remote control are exhausted.	• Replace the batteries with new ones.	15
	• The player's remote sensor is exposed to a strong light source such as direct sunlight or other illumination.	• Avoid the player from being exposed to a strong light source.	15

Specifications
Player / Connectors / Liquid crystal display / Supplied accessories
Player

Power supply	DC 12 V (Rated current : 3 A (Maximum: during battery pack charging)) 120 V AC, 60 Hz (with the supplied AC adapter)
Mass	830 g
External dimensions	200 × 33 × 160 mm (W/H/D)
Signal system	Standard NTSC
Laser	Semiconductor laser, wavelength 650 nm / 795 nm
Frequency range	DVD linear sound : 48 kHz sampling 4 Hz to 22 kHz 96 kHz sampling 4 Hz to 44 kHz
Operating conditions	Temperature: 5 °C to 35 °C, Operation status: Horizontal

Connectors

Video output (AV OUT)	1.0 V (p-p), 75 Ω, negative sync., Ø3.5mm mini jack × 1
Audio output (AV OUT)	2.0 V (rms), 100 Ω, Ø3.5mm mini jack × 1
S video output (S VIDEO)	(Y) 1.0 V (p-p), 75 Ω, negative sync., Ø3.5mm mini jack × 1 (C) 0.286 V (p-p), 75 Ω
Audio output (BITSTREAM/PCM)	Optical/coaxial connector (Ø3.5mm) × 1
Headphone terminal	Ø3.5mm stereo mini jack × 2

Liquid crystal display

Panel size	7 inches
Projection system	TN color transmission
Driving system	Amorphous silicon TFT active matrix
Resolution	480 (H) × 234 (V) pixels (effective pixel rate : more than 99.99%)

Supplied accessories

Audio/video cable	1
Remote control	1
Coin-shaped battery (CR2025)	1
AC adapter (ADP-36CH A)	1
Power cord	1
Battery pack	1
S video cable	1
Vehicle adapter	1

- Designs and specifications are subject to change without notice.

LIMITED WARRANTY PORTABLE DVD PLAYER

Toshiba America Consumer Products, L.L.C. ("TACP") and Toshiba Canada Limited ("TCL") make the following limited warranties. These limited warranties extend to original consumer purchaser or any person receiving this set as a gift from the original consumer purchaser and to no other purchaser or transferee.

Limited Ninety (90) Day Warranty

TACP/TCL warrant this product against defects in materials or workmanship for a period of ninety (90) days after the date of original retail purchase. During this period, TACP/TCL will repair a defective product or part, without charge to you. You must deliver the entire product to a TACP/TCL Authorized Service Station. You are responsible for all transportation and insurance charges for the unit to and from the Authorized Service Station.

Limited One (1) Year Warranty

TACP/TCL further warrant the parts in this product against defects in materials or workmanship for a period of one (1) year after the date of original retail purchase. During this period, TACP/TCL will repair or replace a defective part, without charge to you, except that if a defective part is replaced after ninety (90) days from the date of the original retail purchase you pay labor charges involved in the replacement. You must also deliver the entire product to a TACP/TCL Authorized Service Station. You are responsible for all transportation and insurance charges for the unit to and from the Authorized Service Station.

Rental Units

The warranty for rental units begin with the first rental or thirty (30) days from the date of shipment to the rental firm, whichever comes first.

Commercial Units

Products sold and used for commercial use have a limited ninety (90) day warranty for all parts and labor.

Owner's Manual

You should read the owner's manual thoroughly before operating this product. You should complete and mail the enclosed Demographic card within ten (10) days after you, or the person who has given you this product as a gift, purchased this product. This is one way to enable TACP/TCL to provide you with better customer service and improved products. Failure to return the card will not affect your rights under this warranty.

Your Responsibility

The above warranties are subject to the following conditions:

- (1) You must retain your bill of sale or provide other proof of purchase.
- (2) You must notify a TACP/TCL Authorized Service Station within thirty (30) days after you discover a defective product or part.
- (3) All warranty servicing of this product must be made by a TACP/TCL Authorized Service Station.
- (4) U.S.A. warranties are effective only if the product is purchased and operated in the Continental U.S.A. or Puerto Rico.
- (5) Labor service charges for set installation. Set up, adjustment of customer controls and installation or repair of antenna systems are not covered by this warranty. Reception problems caused by inadequate antenna systems are your responsibility.
- (6) Warranties extend only to defects in materials or workmanship as limited above and do not extend to any product or parts which have been lost or discarded by you or to damage to products or parts caused by misuse, accident, damage caused by Acts of God, such as lighting or fluctuations in electric power, improper installation, improper maintenance or use in violation of instructions furnished by us; or to units which have been altered or modified without authorization of TACP/TCL or to damage to products or part thereof which have had the serial number removed, altered, defaced or rendered illegible.
- (7) Physically damaged DVD Units are not acceptable for repair or exchange whether in or out of warranty and will be returned as received.

LIMITED WARRANTY PORTABLE DVD PLAYER (Continued)

How to Obtain Service

- (1) Refer to the troubleshooting guide in your owner's manual. This checklist may solve your problem or check our web site at WWW.TOSHIBA.COM/TACP.
- (2) Products shipped to the Service Station must be insured and safely and securely packed, preferably in the original shipping carton, and a letter explaining the defect and also a copy of the bill of sale or other proof of purchase must be enclosed.

In United States contact:

Toshiba America Consumer Products L.L.C.

(800)-631-3811

In Canada contact:

Consumer Electronics Group

191 McNabb St

Markham, Ontario L3R 8H2

(905)-470-5400

Consumer Electronics Group

22171 Fraserwood Way

Richmond, B.C. V6W 1J5

(604)-303-2500

Toshiba of Canada Limited

18050 Trans Canada Highway

Kirkland, Quebec

H9J 4A1

(514)-390-7766

All warranties implied by state law, including the implied warranties of merchantability and fitness for a particular purpose, are expressly limited to the duration of the limited warranties set forth above. With the exception of any warranties implied by state law as hereby limited, the foregoing warranty is exclusive and in lieu of all other warranties, guarantees, agreements and similar obligations of manufacturer or seller with respect to the repair or replacement of any parts. In no event shall TACP be liable for consequential or incidental damages.

No person, agent, distributor, dealer or company is authorized to change, modify or extend the terms of these warranties in any manner whatsoever. The time within which an action must be commenced to enforce any obligation of TACP arising under the warranty or under any statute, or law of the United States or any state thereof, is hereby limited to ninety (90) days from the date you discover or should have discovered the defect. This limitation does not apply to implied warranties arising under state law.

This warranty gives you specific legal rights and you may also have other rights, which may vary from state to state. Some states do not allow limitation on how long an implied warranty lasts, when an action may be brought, or the exclusion or limitation of incidental or consequential damages, so the above provisions may not apply to you.

ATTENTION CANADIAN CONSUMERS: (Toshiba Canada "TCL")

Canadian consumers are requested to complete the special Canadian "Warranty Registration Form" enclosed, and forward this completed form with a copy of bill of sale to TOSHIBA OF CANADA to "Register and Validate" their warranty. Product must be purchased from an Authorized Canadian Dealer.

IMPORTANT: PACKING AND SHIPPING INSTRUCTION

When you send the product to a Service Station, you must use the original carton box and packing material, then insert the original carton box containing the unit into another carton, using more packing material.

Products purchased in the U.S.A. and used in Canada are not covered by these warranties.

Products purchased in Canada and used in the U.S.A. are not covered by these warranties.

TOSHIBA

Printed in China