

 telescope

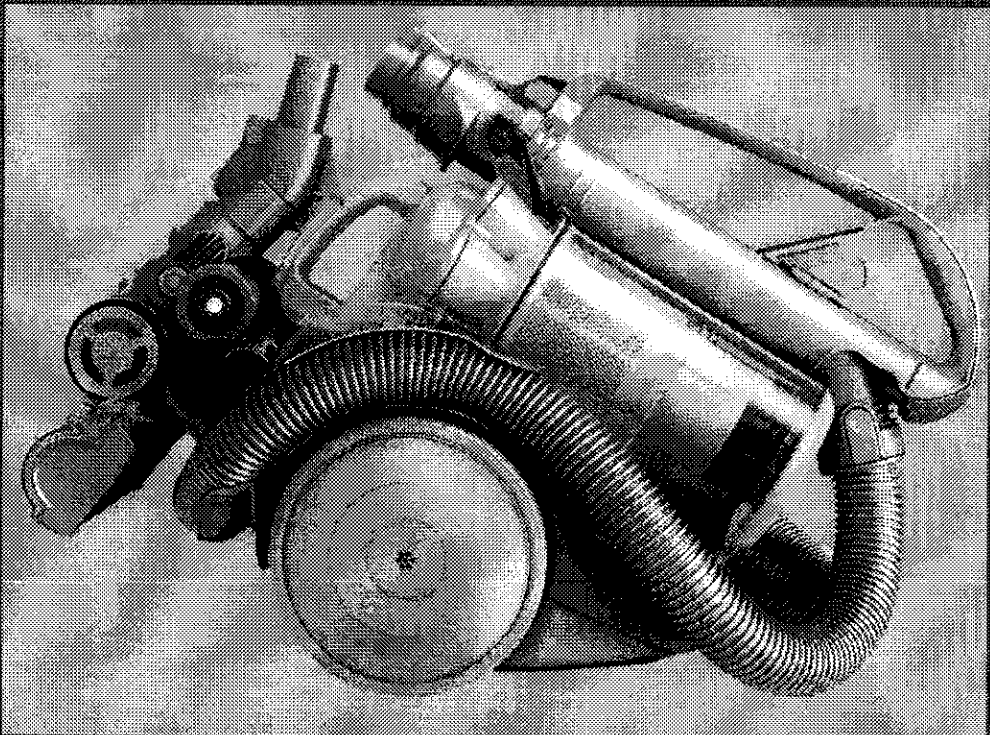

Owner's manual
Please read this guide carefully
before using your DC11.

Important safety instructions

Important safety instructions



Important safety instructions

IMPORTANT SAFETY INSTRUCTIONS

READ ALL INSTRUCTIONS BEFORE USING THIS VACUUM CLEANER

When using an electrical appliance, basic precautions should always be followed, including the following:

WARNING

TO REDUCE THE RISK OF FIRE, ELECTRIC SHOCK OR INJURY:

- 1 Do not leave plugged in. Unplug from electrical outlet when not in use and before servicing.
- 2 Do not use outdoors or on wet surfaces or to vacuum water or other liquids – electric shock and personal injury could occur.
- 3 Do not allow to be used as a toy. Close attention is necessary when used by or near children.
- 4 You are responsible for making sure that your vacuum cleaner is not used by anyone unable to operate it properly.
- 5 Use only as described in this manual. Use only with Dyson recommended or approved attachments and accessories.
- 6 Check to ensure your electricity supply corresponds to that shown on the rating plate, which can be found on the base of the machine between the wheels. The machine must only be used as rated.
- 7 Do not use with a damaged cord or plug. If the machine is not functioning properly, has been dropped, damaged, left outdoors, or immersed in liquid, contact the Dyson Helpline on 1-866-693-9766.
- 8 Do not pull or carry by the cord, do not use the cord as a handle, do not close a door on the cord or pull the cord around sharp edges or corners. Do not run the machine over the cord. Keep the cord away from heated surfaces and open flames.
- 9 Do not unplug by pulling on the cord. To unplug, grasp the plug, not the cord.
- 10 Hold plug when rewinding onto cord reel. Do not allow plug to whip when rewinding.
- 11 Do not handle the plug or machine with wet hands.
- 12 Do not use the machine without the clear bin™ and the filters in place.
- 13 Do not put any objects into openings in the machine. Do not use with any opening blocked; keep free of dust, lint, hair and anything that may reduce air flow.
- 14 Keep hair, loose clothing, fingers, and all parts of body away from openings in the machine and moving parts such as the brushbar.
- 15 Do not use the machine to pick up sharp hard objects, small toys, pins, paper clips etc. They may damage the machine.
- 16 The use of an extension cord is not recommended.
- 17 Store the machine indoors. Put the machine away after use to prevent tripping accidents, with the cord coiled safely.
- 18 Turn off all controls before unplugging.
- 19 Take extra care when cleaning on stairs; always work with the machine at the bottom of the stairs. Do not put on chairs, tables etc, keep on the floor.
- 20 Do not pick up anything that is burning or smoking, such as cigarettes, matches, or hot ashes.
- 21 Do not use to pick up flammable or combustible liquids, such as gasoline, or use in areas where they may be present.
- 22 When vacuuming, certain carpets may generate small static charges in the clear bin™ or wand. These are not associated with the electricity supply. To minimize any effect from this, do not put your hand or insert any object into the clear bin™ unless you have first emptied it and rinsed it out with cold water.
- 23 Use only identical replacement parts.
- 24 Do not carry out any maintenance or repair work other than that shown in this manual or advised by the Helpline.

Important safety instructions

Important safety instructions

SAVE THESE INSTRUCTIONS

THIS APPLIANCE IS INTENDED FOR HOUSEHOLD USE ONLY

2 **Dyson Helpline** contact us on **1-866-693-9766**

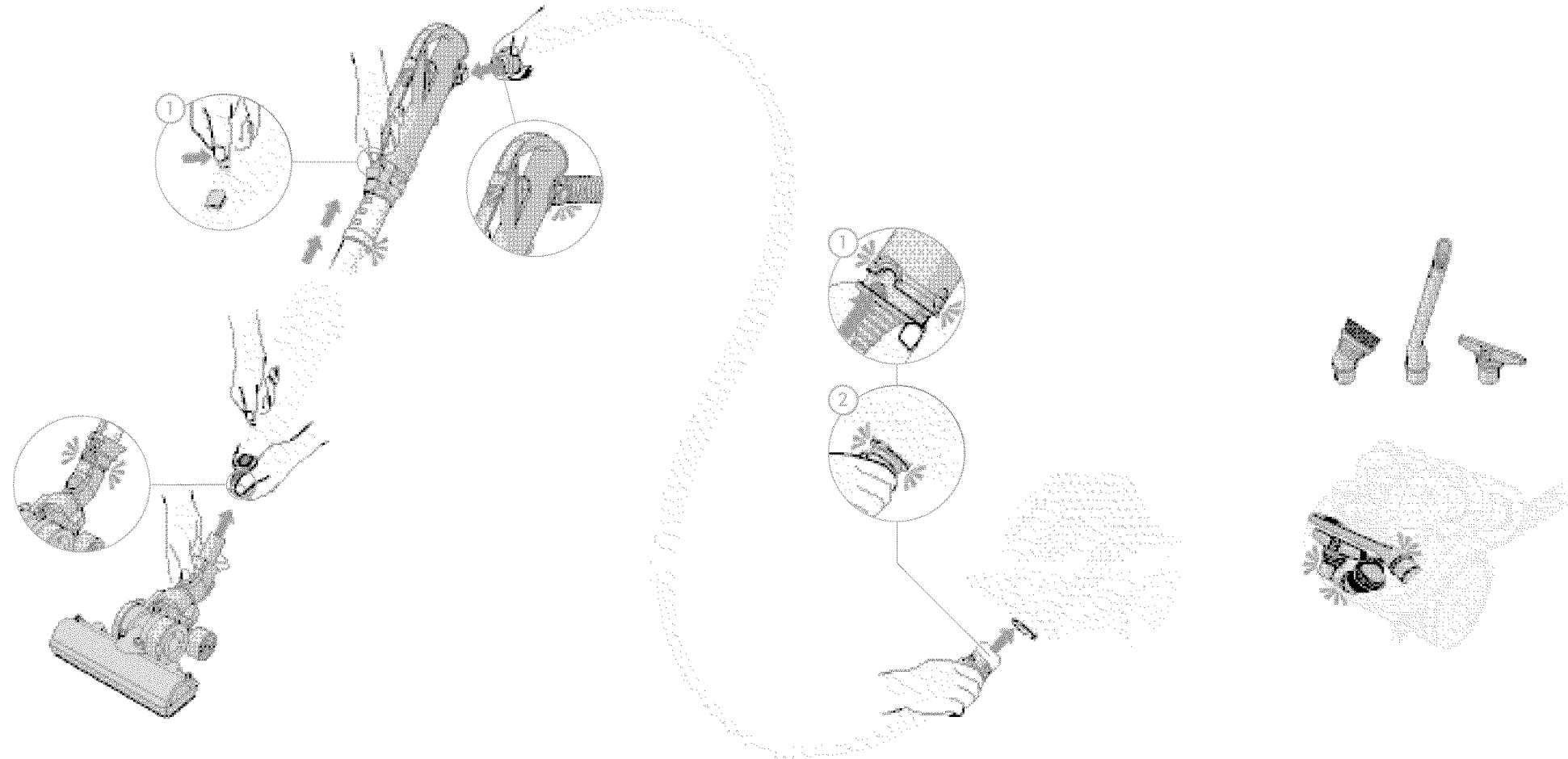

Assembling your DC11

This machine was inspected and packaged carefully before being shipped from the factory.

If you need assistance to assemble or operate it, please call the Dyson Helpline on 1-866-693-9766.

Clip the floor tool into the wand.
Press catch **1** to release wand and extend it fully until the wand cuffs click.

Clip the hose into the wand.

1 Align the cuff and pins. **2** Clip the hose into the machine.

Click the tools onto the machine.

Assembling your DC11

Important safety instructions

Important safety instructions

Storing your DC11

Important safety instructions

Important safety instructions

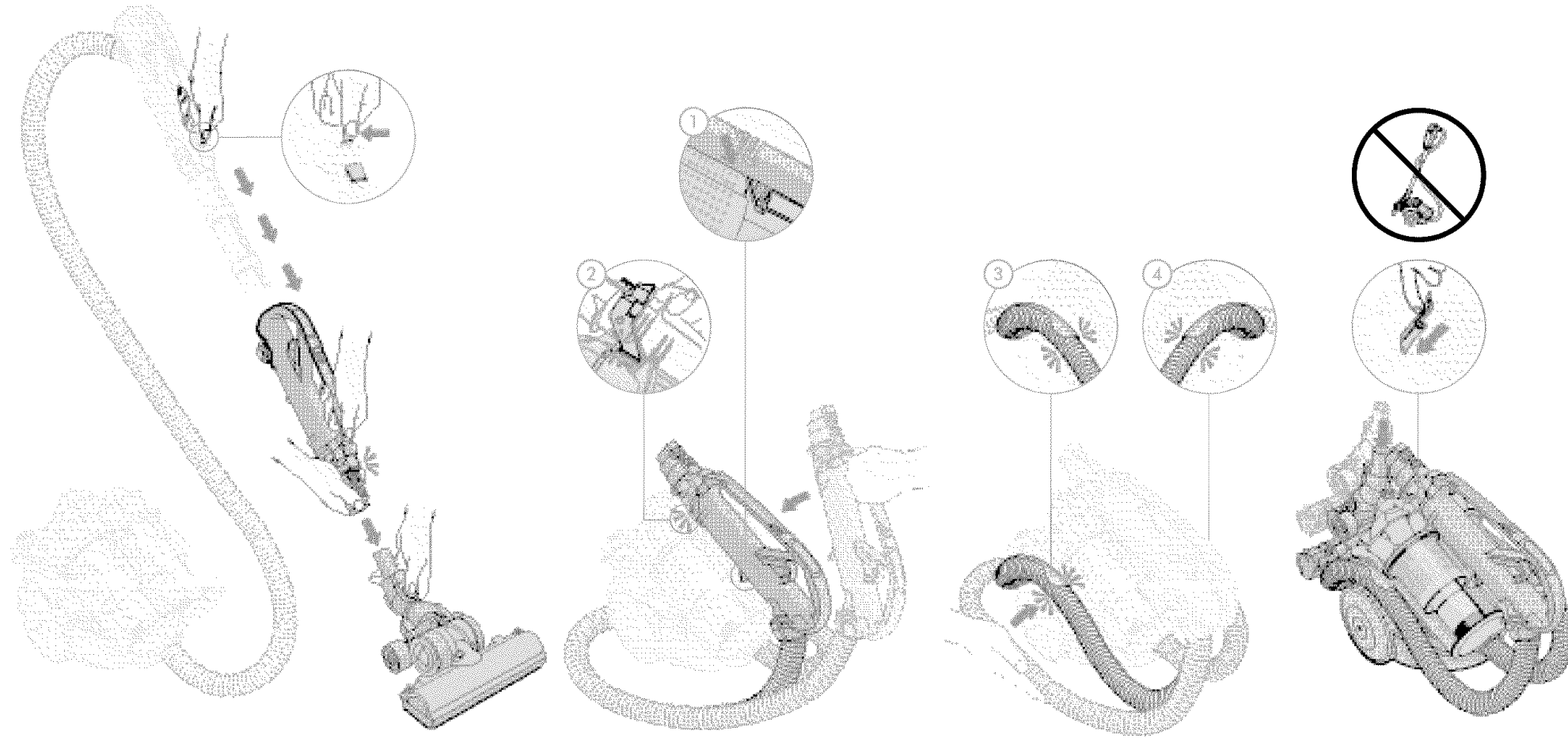

Storing your DC11

Remove the floor tool from the wand. Compact the wand.

To attach the wand to the machine, clip catch 1 between bins then press catch 2 to click it into place.

Loop the hose around the machine. Clip the hose into sides 3 and 4.

Slide the floor tool into the parking yoke. Please do not park the wand in an upright position, as it's not designed for this.

⚠ WARNING

- To reduce the risk of electric shock and personal injury, this appliance has a polarized plug (one blade wider than the other). This plug will fit in a polarized outlet only one way. If the plug does not fit fully in the outlet, reverse the plug. If it still does not fit, contact a qualified electrician to install the proper outlet. Do not force the plug into the outlet. Do not alter the plug in any way.

⚠ CAUTION

- Keep hair, loose clothing, fingers, and all parts of the body away from openings and moving parts.

Please note:

- The machine is intended for domestic use only.
Fine dust such as plaster dust or flour should only be vacuumed in small amounts.

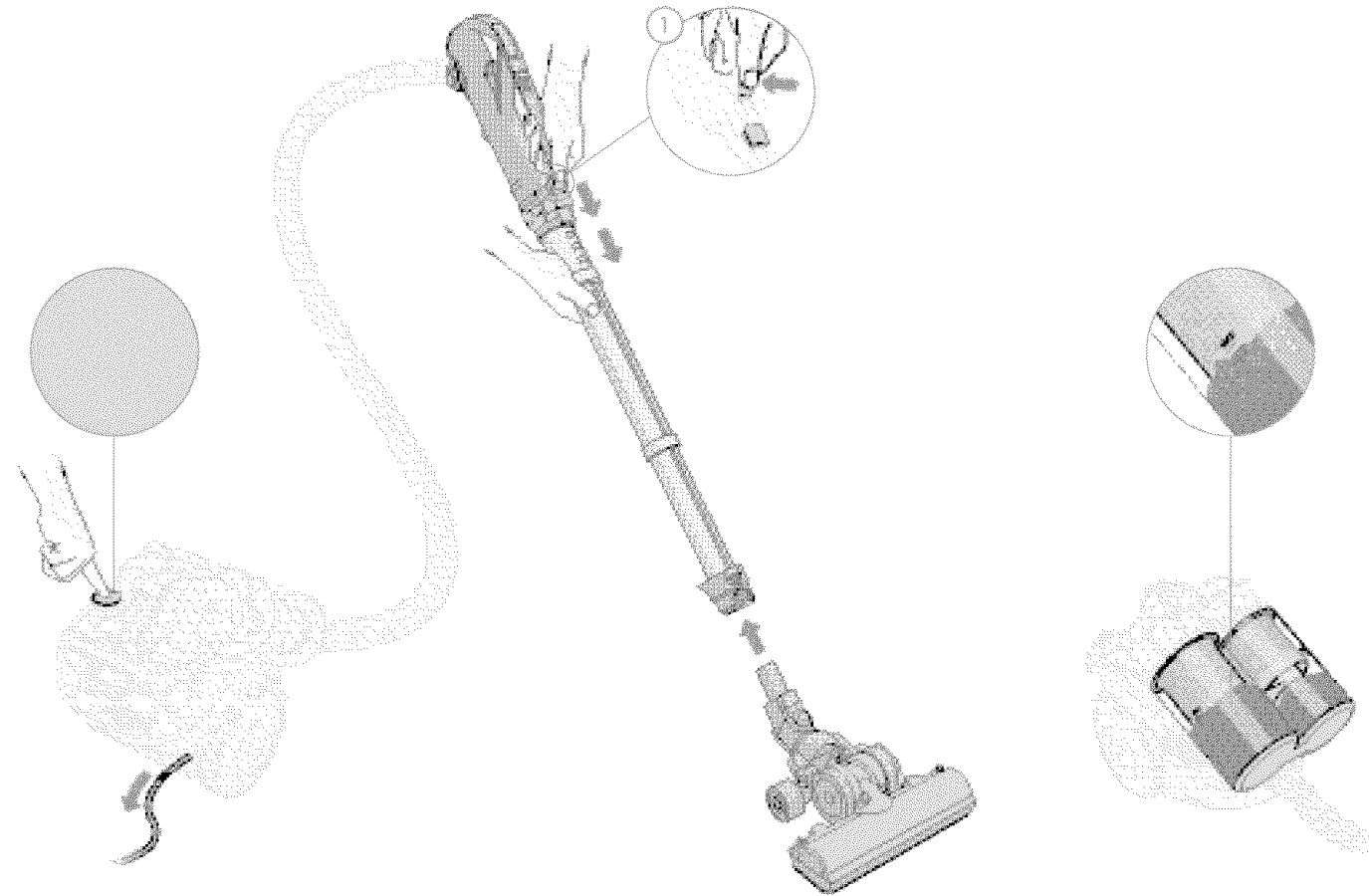

Using your DC11

Extend the cable fully up to the red tape. Press the on/off button to start or stop the machine.

To adjust the wand length, press catch 1 to slide the handle in or out. Extend wand fully before use.

The floor tools fit into the end of the wand, the wand handle or the hose.

Empty the clear bins™ as soon as either one reaches the max mark (see page 9).

Using your DC11

Important safety instructions

Important safety instructions

Using your DC11

Important safety instructions

Important safety instructions

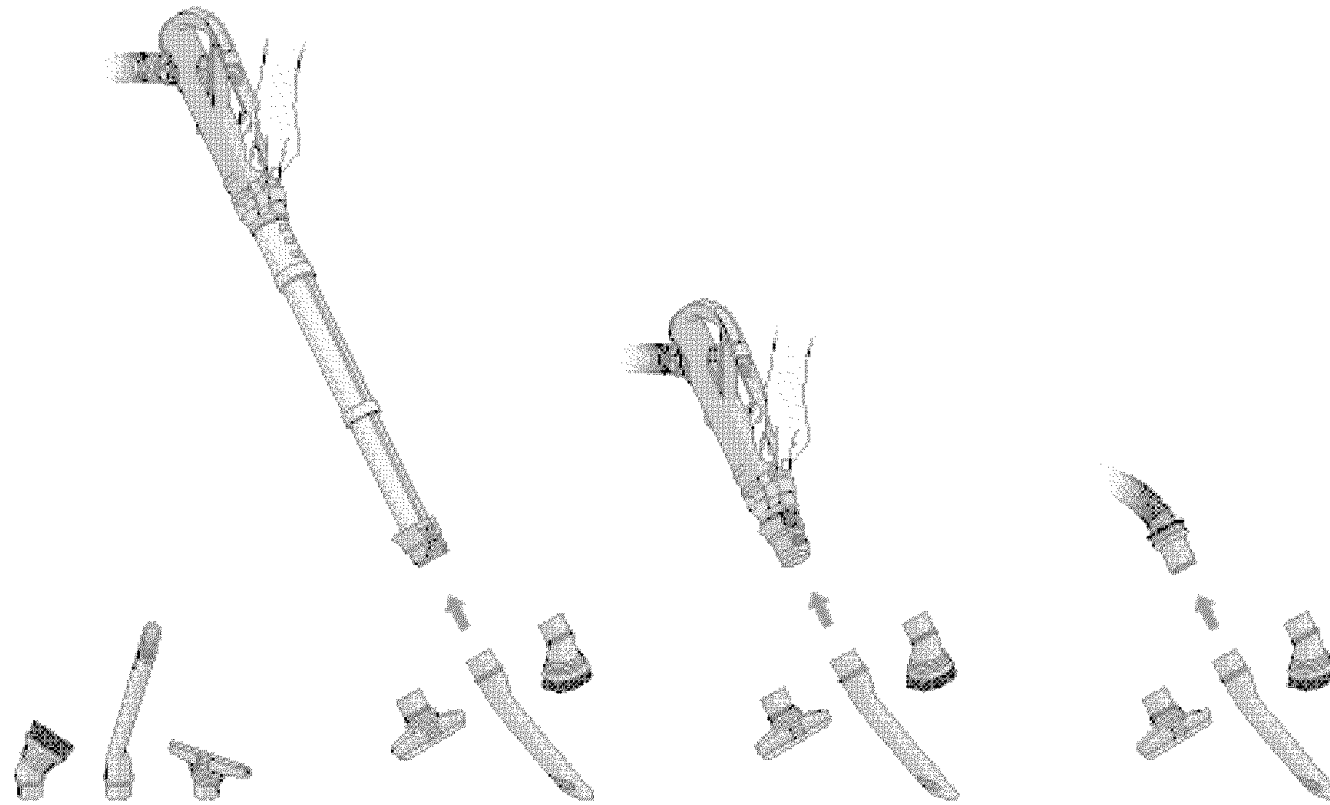

The tools clean upholstery, curtains and stairs.

The tools fit the wand, wand handle and hose.

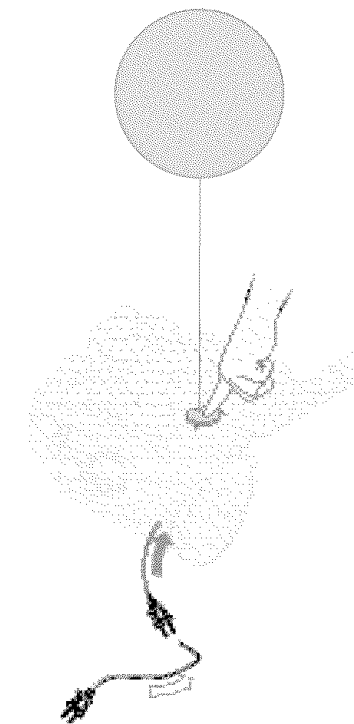

Hold the cable rewind button down to rewind the cable.

⚠ CAUTION

- Hold plug when rewinding onto cord reel. Do not allow plug to whip when rewinding.

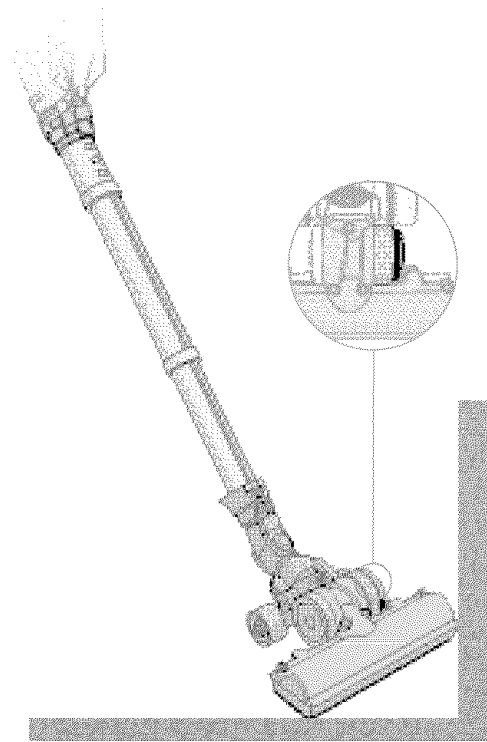

all floors turbine head

Using your tools

All floors Turbine head

When you start the machine the Turbine head is already in carpet mode.

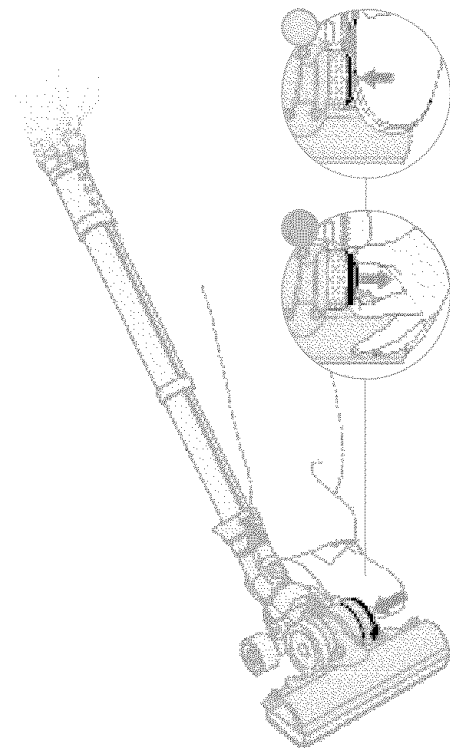

bare floor tool

Optional Bare floor tool
Cleans bare floors gently.

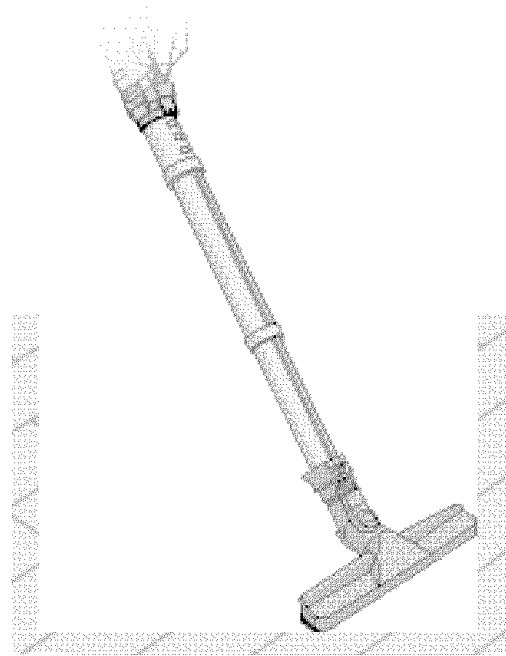

mini turbobrush

Optional Mini turbobrush
Cleans hair from confined spaces such as the car.

Using your tools

Important safety instructions

Important safety instructions

Carrying your DC11

Important safety instructions

Important safety instructions

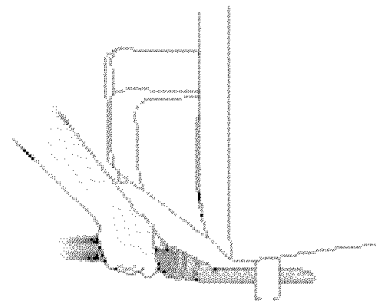

Crevice tool
Reaches into nooks and crannies.

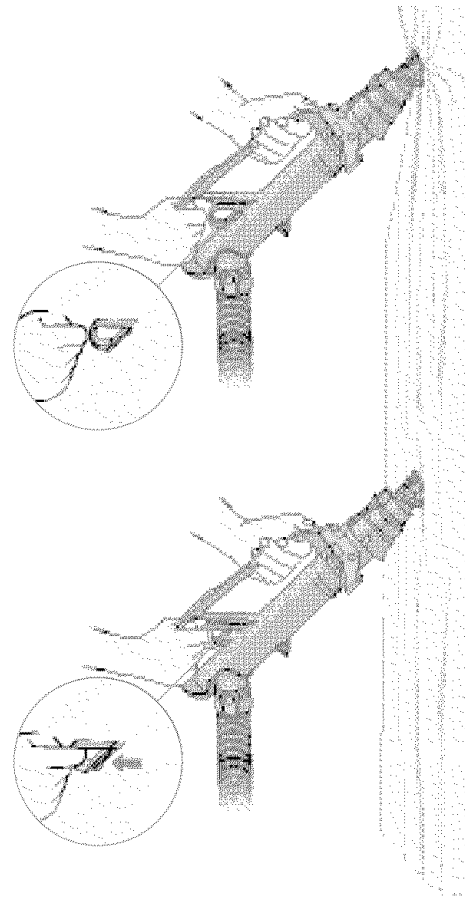

For loose fabrics pull the trigger and hold it to reduce suction.

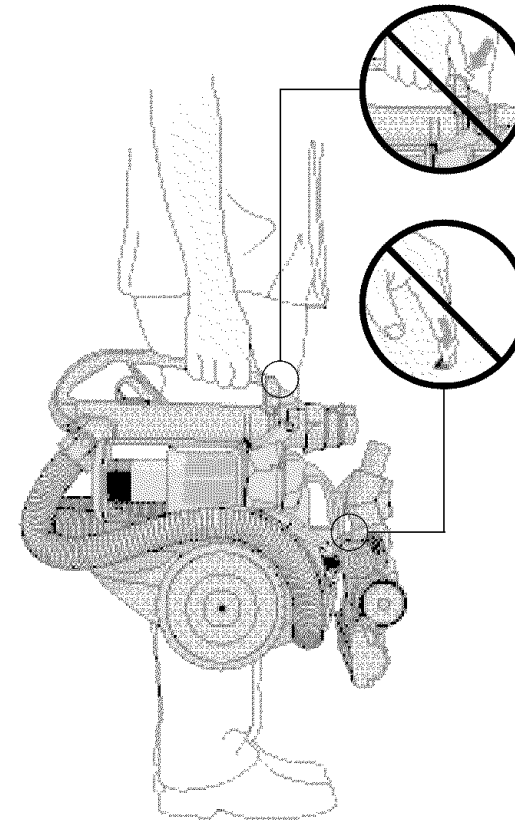

Carrying your DC11

For your safety do not press the cyclone release catch when carrying your machine.

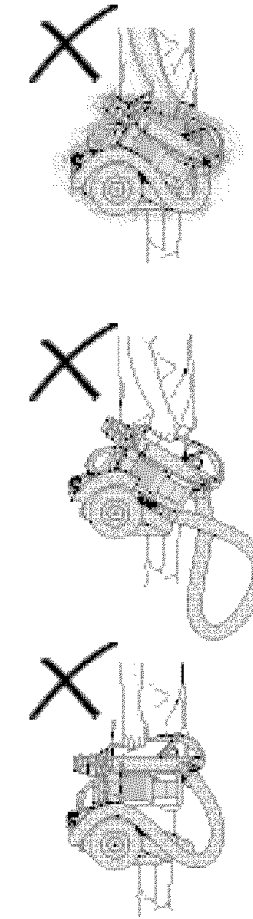

CAUTION

- Do not shake the machine when carrying.
- Ensure the cyclone pack and wand handle are firmly secured to the base.
- Ensure the hose has clicked into place on both sides.

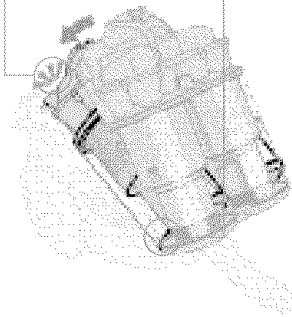
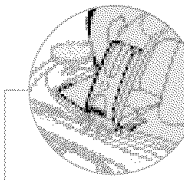
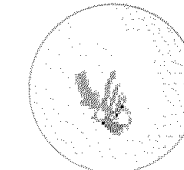
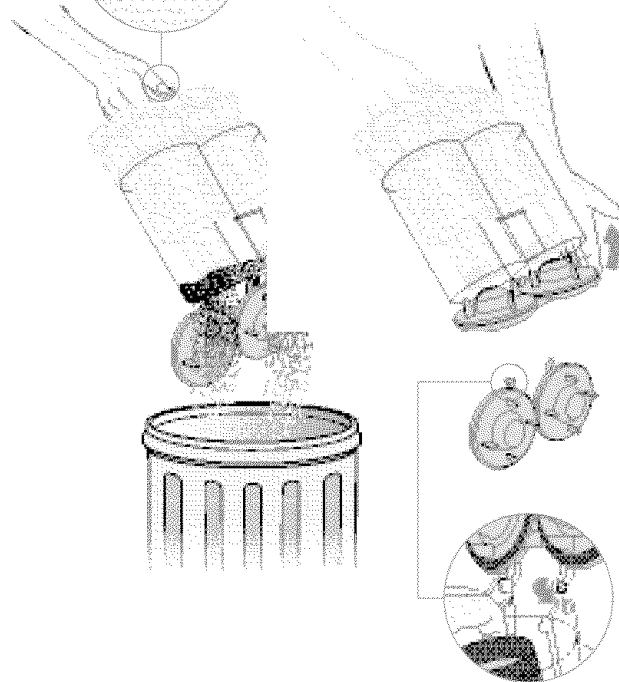
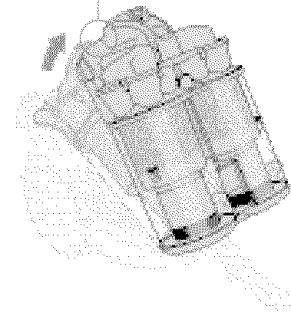
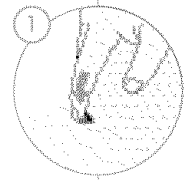
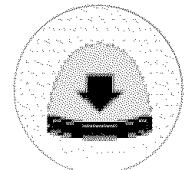
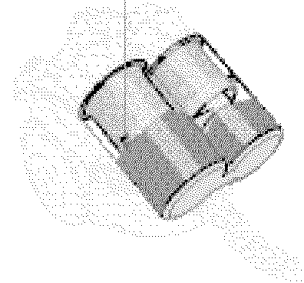
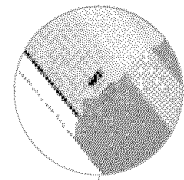
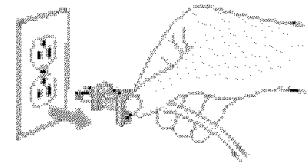

Emptying your DC11

⚠ CAUTION

- Disconnect the machine from the electrical outlet before emptying the bin. Failure to do so could result in electric shock or personal injury.
- Do not use the machine without the clear bins™ in place.

Empty the clear bins™ as soon as either one reaches the max mark.

Press the red catch 1 to release the cyclone pack.

Press catch 2 to empty the bins. Close the bin base securely.

To re-assemble the bin bases, squeeze the hinges at the back.

Replace the cyclone pack firmly onto the machine.

Emptying your DC11

Important safety instructions

Important safety instructions

Emptying your DC11

Important safety instructions

Important safety instructions

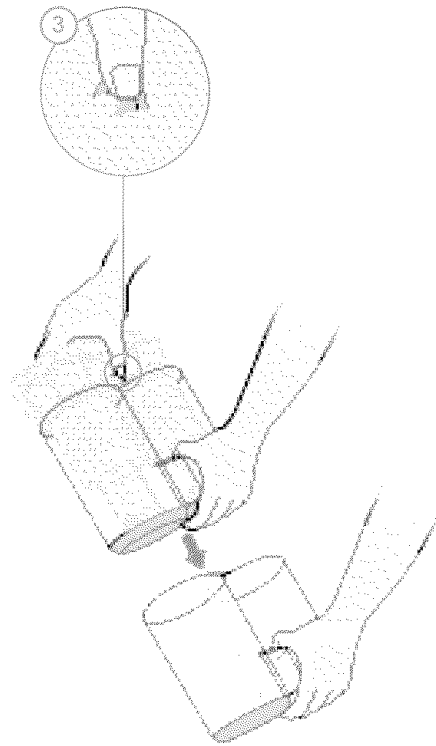

Press catch 3 to remove the bins.

When necessary

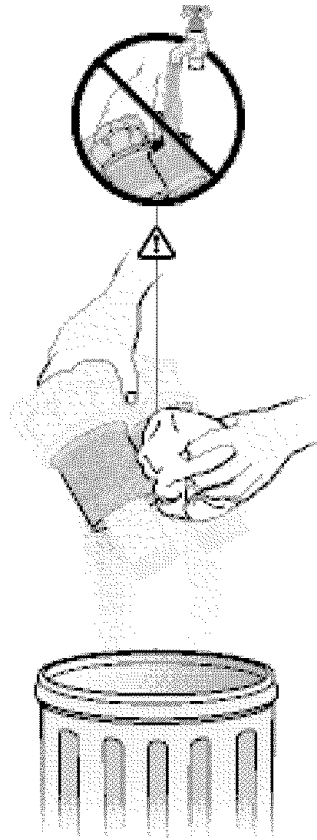

CAUTION

- Do not rinse the cyclones in water. Brush the fine dust off the shroud.

Optional

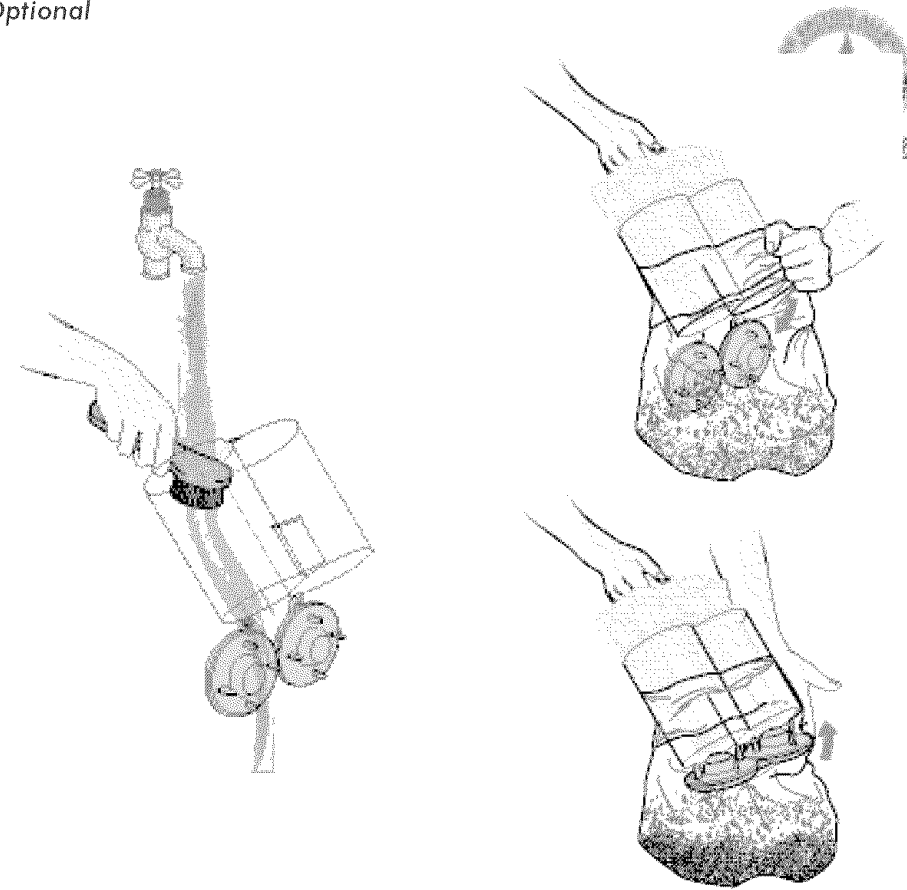

Bins must be completely dry before refitting them.

CAUTION

- Do not use detergents, polishes or freshening products.
- Do not immerse any other part of the machine in water.

Recommended for allergy sufferers.

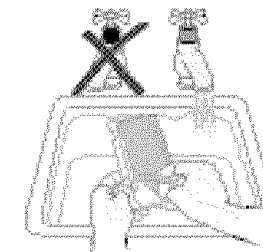
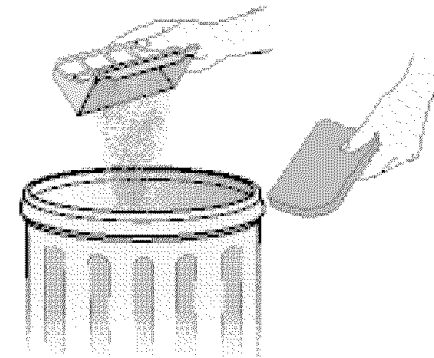
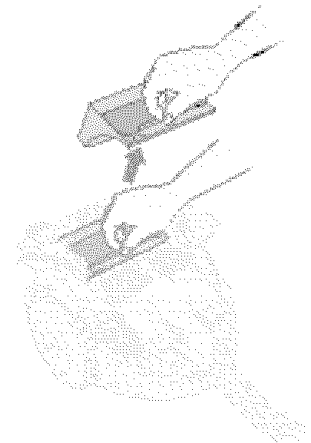
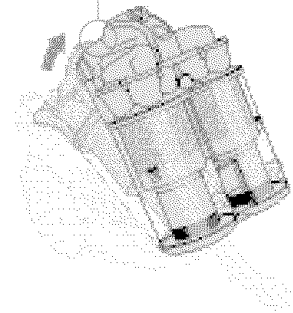
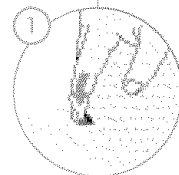
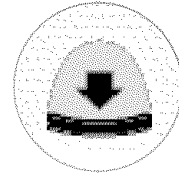
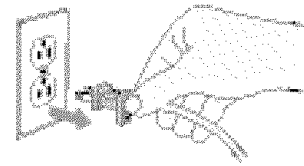

Cleaning the lifetime filter

⚠ CAUTION

- Disconnect the machine from the electrical outlet before removing the filter. Failure to do so could result in electric shock or personal injury.

Wash filter at least every 6 months. When vacuuming fine dust, the filter may require more frequent washing. Press catch 1 to release cyclone pack.

Lift the plastic filter case out of the machine.

Separate the foam layer and filter case and shake both over the dustbin.

Wash the filter and case in cold water only.

⚠ CAUTION

- Rinse in cold water only.
- Do not use detergent.
- Do not put in a washing machine or dishwasher.

Cleaning the lifetime filter

Important safety instructions

Important safety instructions

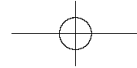

Cleaning the lifetime filter

4

Important safety instructions

Important safety instructions

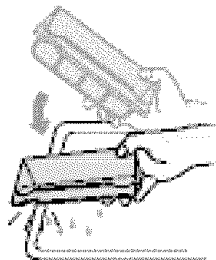
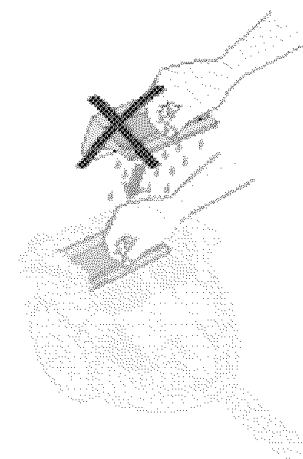
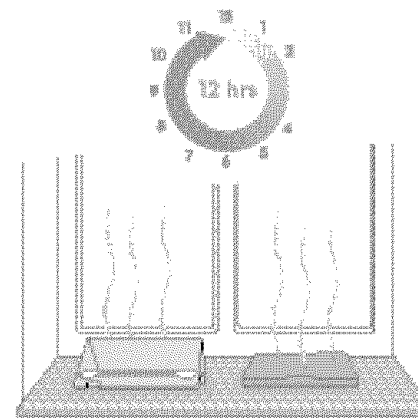
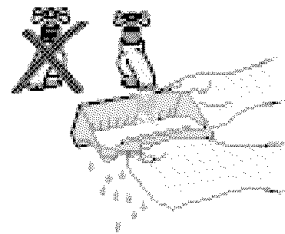
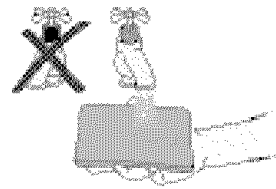

Wash the filter until the water runs clear and squeeze it to remove excess water.

Wash the case until the water runs clear and tap it dry to remove excess water.

Dry the filter and case for at least 12 hours.

⚠ CAUTION

- Do not dry in an oven or microwave.
- Do not dry in a clothes dryer.
- Do not dry near an open flame.

The filter and case must be completely dry before refitting.

⚠ CAUTION

- Do not use the machine without the filter in place.

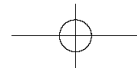

⚠ CAUTION

- Disconnect the machine from the electrical outlet before starting to look for blockages.

Please note:

- Should any part of the machine become blocked, the motor may overheat and stop due to the thermal cut-off being triggered. Disconnect from the electrical outlet and let the machine cool down for at least 30 minutes before clearing the blockage.
- Clearing blockages is not covered by your machine's limited warranty.

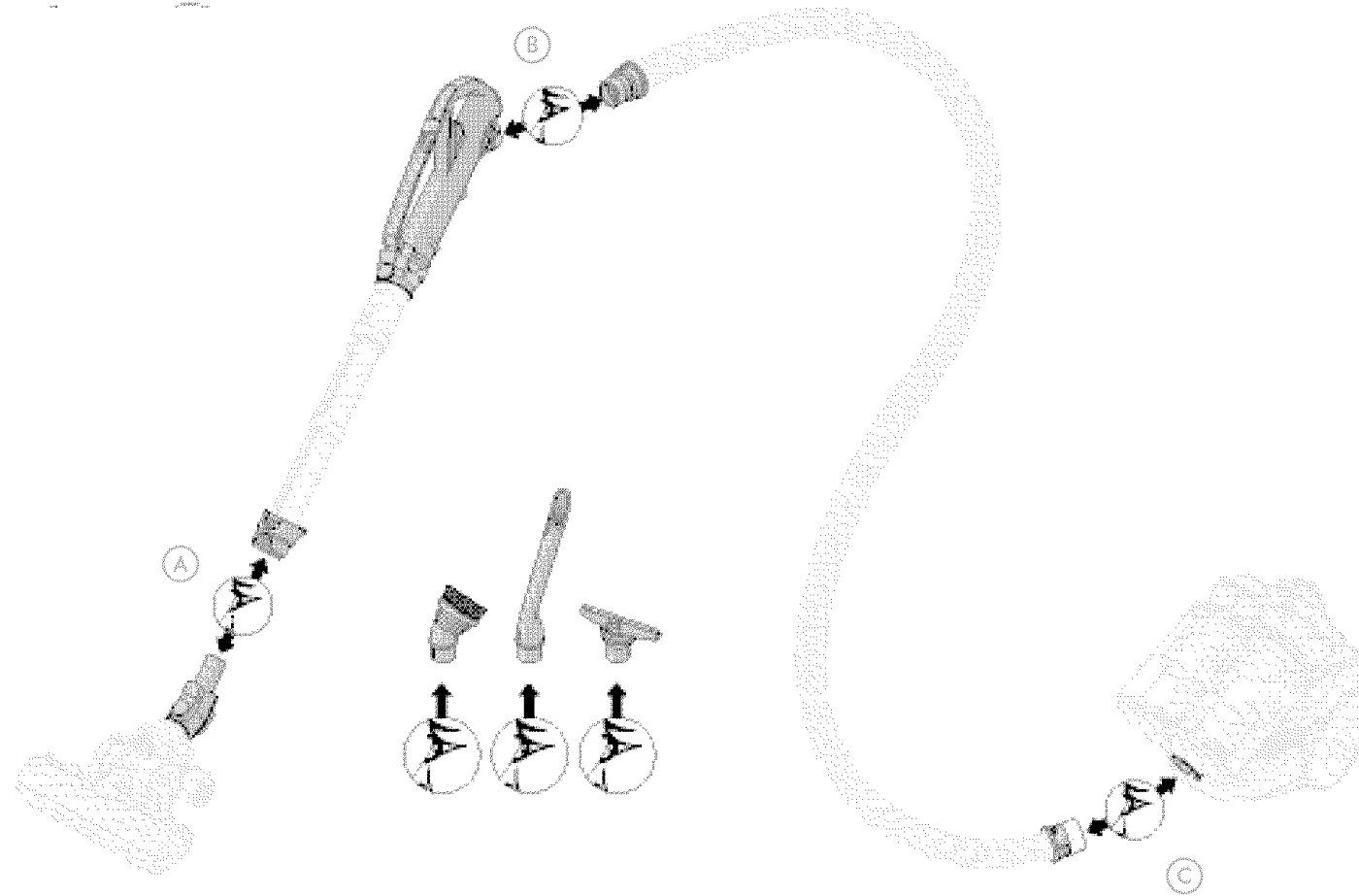

Blockages

Check **A** and **B** to ensure nothing is obstructing the ducts.

⚠ CAUTION

- Don't use sharp objects when clearing blockages.

Check the accessory tools.

Check **C** where the hose joins the machine.

⚠ CAUTION

- Make sure all parts have been replaced securely before using your machine.

Blockages

Important safety instructions

Important safety instructions

Blockages

Important safety instructions

Important safety instructions

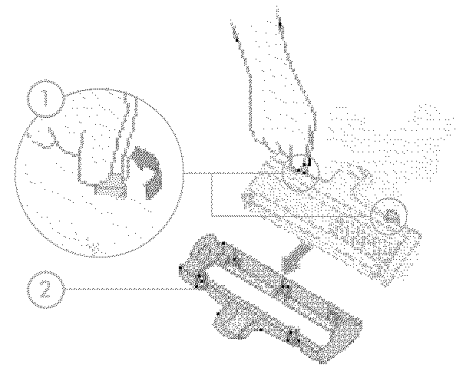

All floors Turbine head

1 Release the catches. 2 Remove the soleplate.

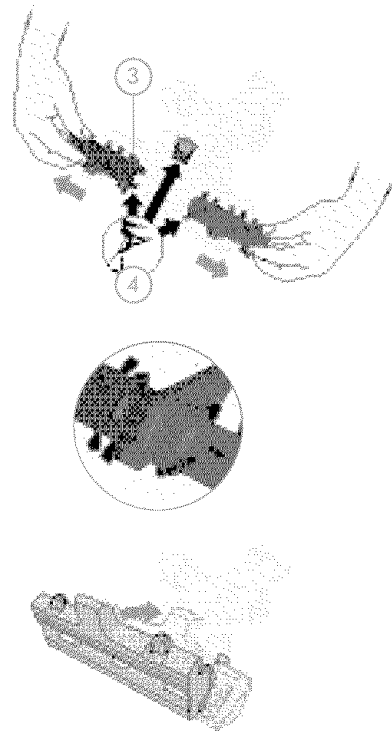

3 Remove the brushbar and clear away thread and hair. 4 Check the duct for blockages.

To re-assemble, align the arrows on each brushbar in the same direction, click and fasten the soleplate into place.

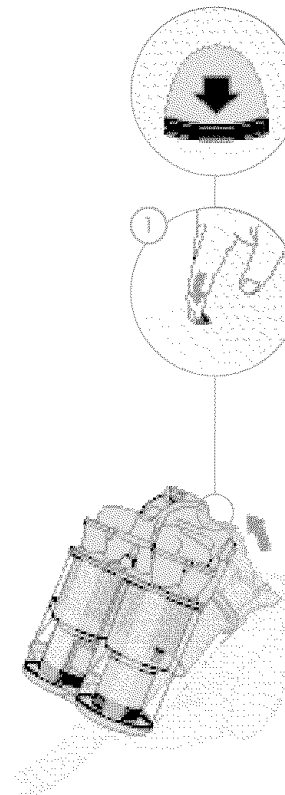

Press catch 1 to release cyclone pack.

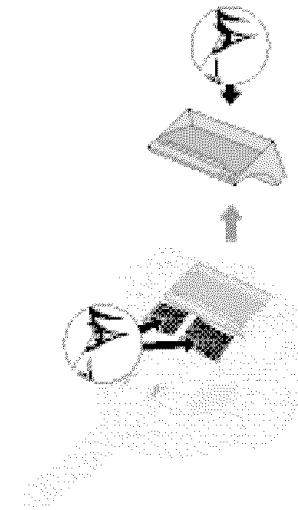

Check whether the filter and case need washing. Check the air inlets.

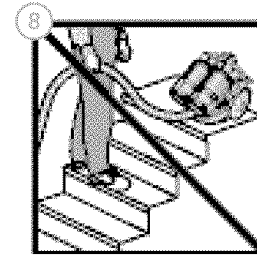
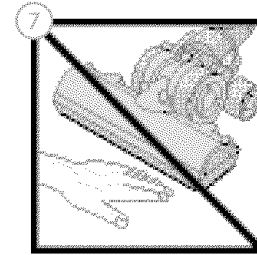
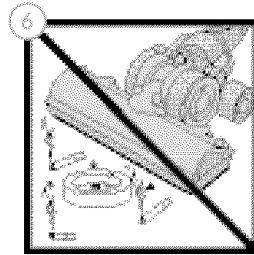
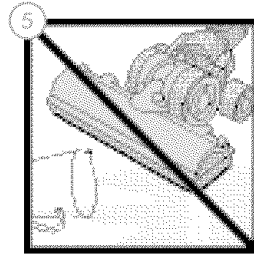
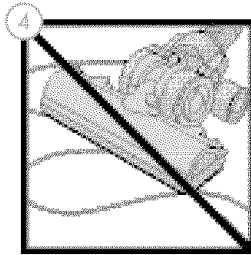
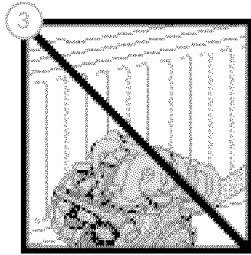
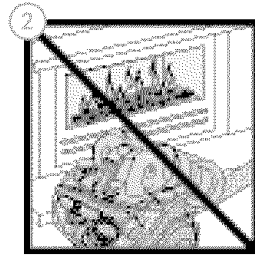
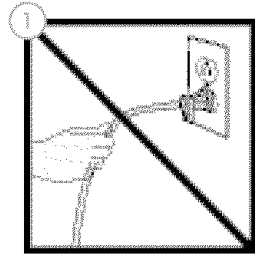

Important safety instructions

- 1 Do not pull the cable.
- 2 Do not use near open flames.

- 3 Do not leave near heat sources.
- 4 Do not run over the cable.

- 5 Do not pick up water or liquids.
- 6 Do not pick up burning objects.

- 7 Do not put your hands near the brushbar in use.

CAUTION

- 8 To avoid personal injury and to prevent the machine from falling when cleaning stairs, always place it at the bottom of the stairs.

Important safety instructions

Important safety instructions

Important safety instructions

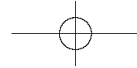

Warranty and customer care

Household 2 year limited warranty Domestic use

Your Dyson vacuum cleaner is warranted against original defects in material and workmanship for a period of two years from date of purchase, when used only for private household purposes and in accordance with the Owner's Manual. This warranty provides, at no cost to you, all labor and parts to place your vacuum cleaner in proper operating condition during the warranty period.

For further details of the warranty including limitations and exclusions, and to register your purchase, please refer to the product registration form found in your instruction pack.

Dyson customer care

If you have a question about your Dyson vacuum cleaner, call the Dyson Helpline on **1-866-693-9766** with your serial number and details of where/when you bought the cleaner. The serial number can be found on the base of your machine between the wheels.

Most queries can be solved over the phone by one of our Helpline staff.

If your cleaner needs service, call the Dyson Helpline we will discuss with you the options available for service. If your machine is under warranty, your machine will be repaired at no cost to yourself. To reach the Dyson Helpline call on **1-866-693-9766**, or visit Dyson online at www.dyson.com.

Important safety instructions

Important safety instructions

This product is protected by the following intellectual property rights:

Patent/Patent Application numbers:

CA 1,241,809; US 4,573,236; US 6,526,623; CA 2,313,177; US 09/555,953; CA 2,315,078; US 6,289,553; CA 2,325,953; US 6,425,931; US 6,461,508; CA 2,351,552; US 6,572,078; CA 2,346,382; US 6,519,807; US 6,442,791; CA 2,400,404; US 10/220,039; PCT/GB02/00613; US10/363,918; PCT/GB02/00320; PCT/GB02/00609; PCT/GB02/00318; PCT/GB02/01378; PCT/GB02/00298; PCT/GB02/00358; PCT/GB02/00301

Registered Design/Application numbers:

CA 97,332; USD 475,820; CA 86192; US D427,737

Please note: Small details may vary from those shown.

16 **Dyson Helpline** contact us on **1-866-693-9766**

