

DLPTV

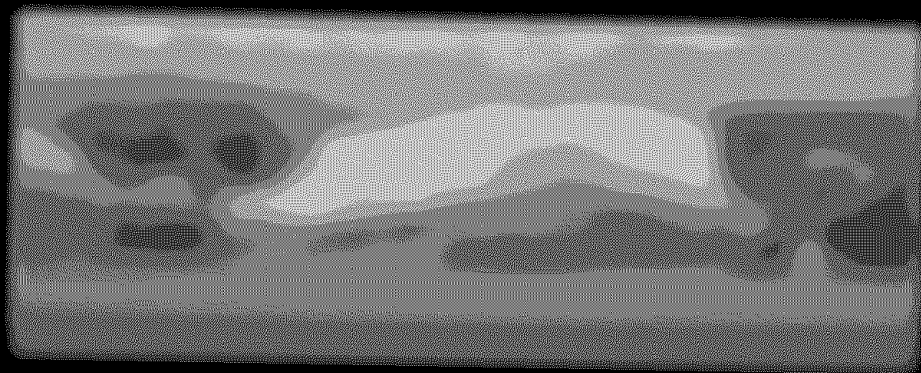
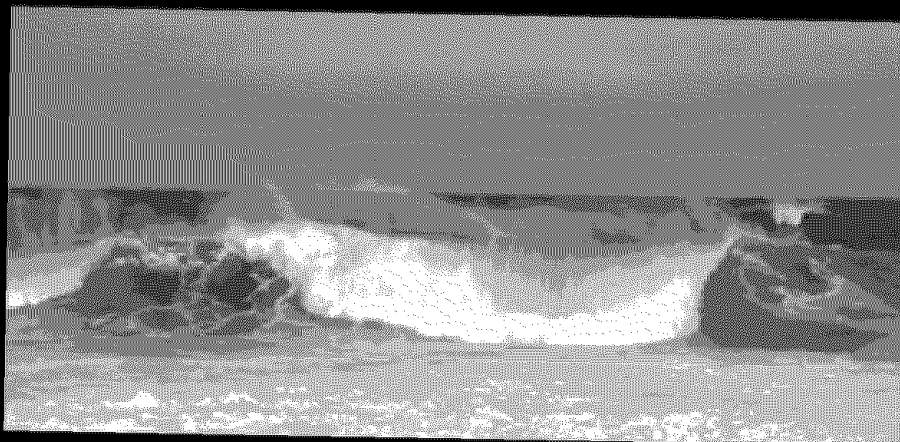

I N S T R U C T I O N M A N U A L

HL-P4663W/HL-P5063W/HL-P5080W/HL-P5100W

Table of Contents

Your New Wide TV	6
Replacing the Lamp	6
List of Features	8
Accessories	8
Side Panel Buttons	9
Side Panel Jacks	9
Front Panel LED Indicators	10
Rear Panel Jacks	11
Remote Control	12
Installing Batteries in the Remote Control	13
Connections	16
Connecting VHF and UHF Antennas	16
Antennas with 300-ohm Flat Twin Leads	16
Antennas with 75-ohm Round Leads	16
Separate VHF and UHF Antennas	17
Connecting Cable TV and VCR	18
Cable without a Cable Box	18
Cable with a Cable Box that Descrambles All Channels	18
Connecting a Cable Converter Box	19
Connecting a Cable Converter Box and a VCR	19
Connecting a Camcorder	20
Connecting a DVD Player	21
Connecting to Y,PB,PR	21
Connecting to Audio and Video Jacks	21
Connecting a DTV Set-Top Box	22
Connecting to Y,PB,PR	22
Connecting to DVI (Digital Visual Interface)	22
Connecting to R,G,B	23
Connecting to HDMI (High Definition Multimedia Interface)	23
Operation	26
Turning the TV On and Off	26
Viewing the Menus and On-Screen Displays	26
Selecting the Menu Language	27
Selecting the Antenna Input	27
Memorizing the Channels	28
Adding and Erasing Channels	29
Changing Channels	30
Selecting Your Favorite Channels	31
Scanning the Channels	32
Labeling the Channels	33
Picture Control	34
Sound Control	36
Setting the Clock	38
Setting the Timers	39
Viewing an External Signal Source	41
Assigning Names to External Input Mode	42
Freezing the Current Picture	43
Remote Control VCR/DVD Buttons	43

Special Features	46
Customizing Your Remote Control	46
Remote Control Codes	47
Fine Tuning Channels	48
LNA (Low Noise Amplifier)	49
Selecting the Color Tone	50
Changing the Picture Size	51
Digital Noise Reduction	52
DNle™ (Digital Natural Image engine) DNle™	53
Setting the MCC (My Color Control) Mode	54
Setting the Film Mode	56
Viewing Picture-In-Picture	57
Activating the PIP	57
Selecting an External Source	58
Swapping the Sub Picture and Main Picture	59
Changing the Size of the Sub Picture	60
Changing the Location of the Sub Picture	61
Changing the Channel of the Sub Picture	62
Selecting the Sound Source	63
Setting the SRS TSXT	64
Choosing a Multi-Channel Sound (MTS) track	65
Auto Volume	66
Enjoying the Sound of External Speakers	67
Using the V-Chip (USA)	68
Viewing Closed Caption Information	74
Setting the Blue Screen Mode	76
Setting The On/Off Melody	77
Using the Color Weakness Enhancement Feature	78
PC Display	80
Using Your TV as a Computer (PC) Display	80
How to Connect Your PC to the TV	80
Setting up Your PC Software (Based on Windows 98)	81
Display Modes	82
Adjusting the Picture Quality	83
Changing the Picture Position	84
Adjusting the Picture Quality and Position Automatically	85
Initializing the Picture Settings	86
Changing the Picture Size (PC Mode)	87
Appendix	90
Troubleshooting	90
Cleaning and Maintaining Your TV	91
Using Your TV in Another Country	91
Specifications	91



Your New Wide TV

Replacing the Lamp

- **Why do I need to replace the lamp?**

The lamp used in a projection TV has a limited lifespan. For the best screen quality it needs to be replaced periodically. After replacing the lamp, the screen quality will be bright and clear as new.

- **When do I need to replace it?**

It should be replaced when the screen becomes darker, less clear or when all three LEDs on the front (Timer, Lamp, & Temp.) are flashing.

- **Check before lamp replacement**

1. The lamp must be the same code number and type.
2. The lamp type is indicated on the right side of the TV. It is also indicated on the lamp case.
3. After checking the code number for the lamp, give the code number to the store where you purchased the TV or to a Samsung Service center.

- **Caution**

1. Replace with the correct code numbered lamp to avoid damage to the TV.
2. Turn the power off and wait for 30 minutes before replacing the lamp as it will be hot.
3. Do not touch the glass part of the lamp with your bare hands nor insert any foreign object inside the cover as it may cause poor screen quality, electric shock or fire.
4. Do not place the old lamp near flammable objects or within the reach of children.

- For replacement, you will need a 5.91 Inches-long Phillips screwdriver and a pair of gloves.

- 1 Unplug TV, then use a screwdriver to remove the screw.

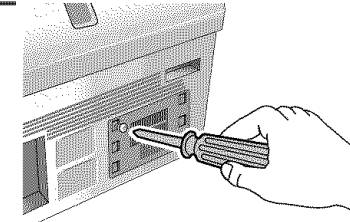

- 2 Remove the Lamp cover.

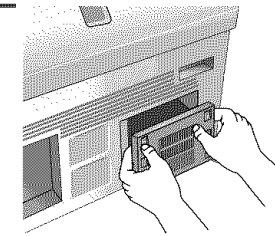

- 3 Remove the screws securing the Lamp by using a screwdriver.

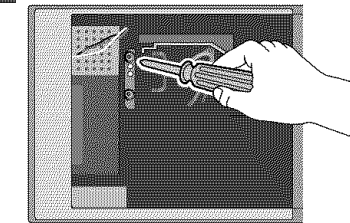

- 4 Separate the Lamp from the engine by holding the handle and pulling it out.

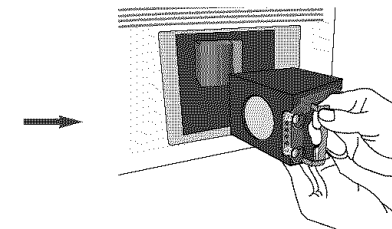
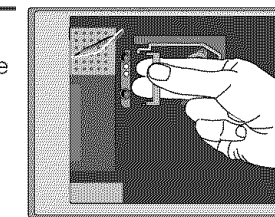

- 5 To reinstall the Lamp, follow these steps in reverse order.

NOTES

- Be sure the replacement Lamp is the same type.
- After replacing the lamp, align the lamp cover with the groove and secure the screw.
- The TV will not turn on if the lamp cover is not correctly closed (as this will activate the protective circuit).

Your New Wide TV

List of Features

Your TV was designed and engineered using the latest technology. It is a full-featured, high-performance unit that exceeds industry standards. In addition, it has these special features:

- Easy-to-operate remote control
- Easy-to-use on-screen menu system you can access from the side panel or remote control
- Automatic timer to turn the TV on and off at any time you choose
- Adjustable picture and sound settings and the ability to memorize your favorite settings
- Automatic channel tuning for up to 181 channels
- A special filter to reduce or eliminate reception problems
- Fine tuning control for the sharpest picture possible
- A built-in multi-channel sound decoder for stereo and bilingual listening
- Built-in, dual channel speakers
- A special sleep timer
- Picture-in-Picture capability that lets you watch two channels at once
- Widescreen TV with adjustable image size
- Life-like clear images provided by DNle technology
- MCC (My Color Control) Mode for corresponding with your color style
- Color weakness Mode

Accessories

Once you have unpacked your TV, check to make sure that you have all the parts shown here. If any piece is missing or broken, call your dealer.

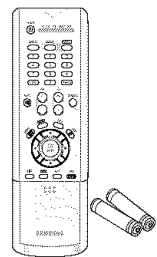

**Remote Control
(BP59-00048B)/
AAA Batteries
(4301-000103)**

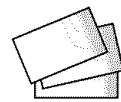

**Warranty Cards (2)/
Registration Card (1)**

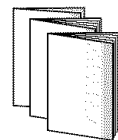

**Instruction Manual/
Safety Guide Manual/
Quick Guide Manual**

Side Panel Buttons

The buttons on the right side panel control your TV's basic features, including the on-screen menu system. To use the more advanced features, you must use the remote control.

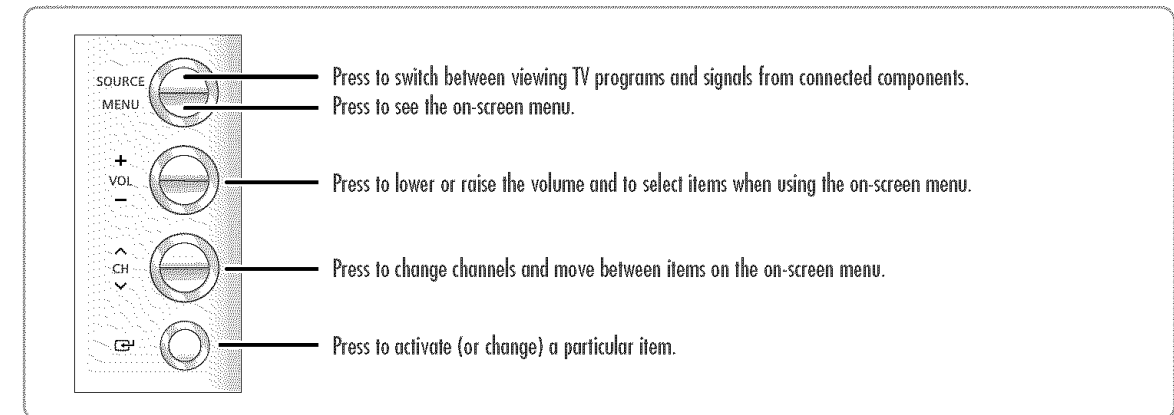

Side Panel Jacks

Use the right side panel jacks to connect a component that is used only occasionally (a camcorder or video game, for example).

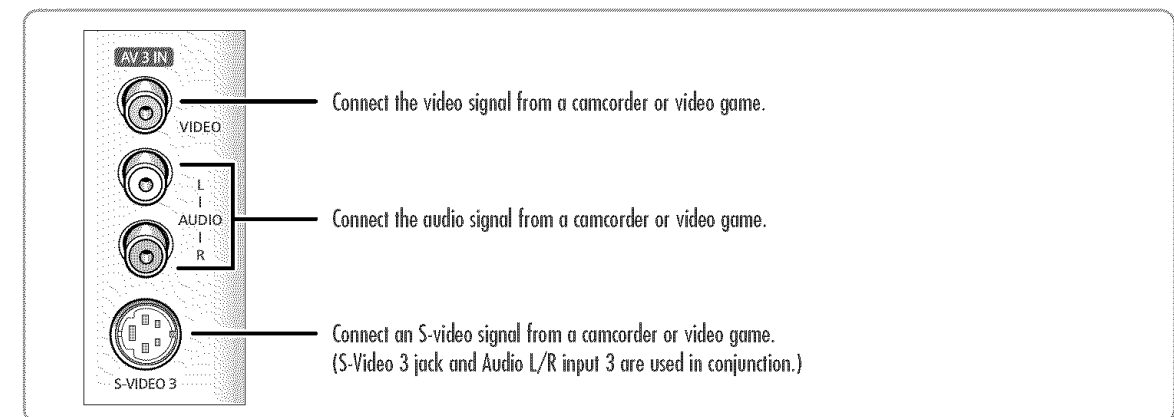

Your New Wide TV

Front Panel LED Indicators

The three lights on the front panel indicate the status of your TV.

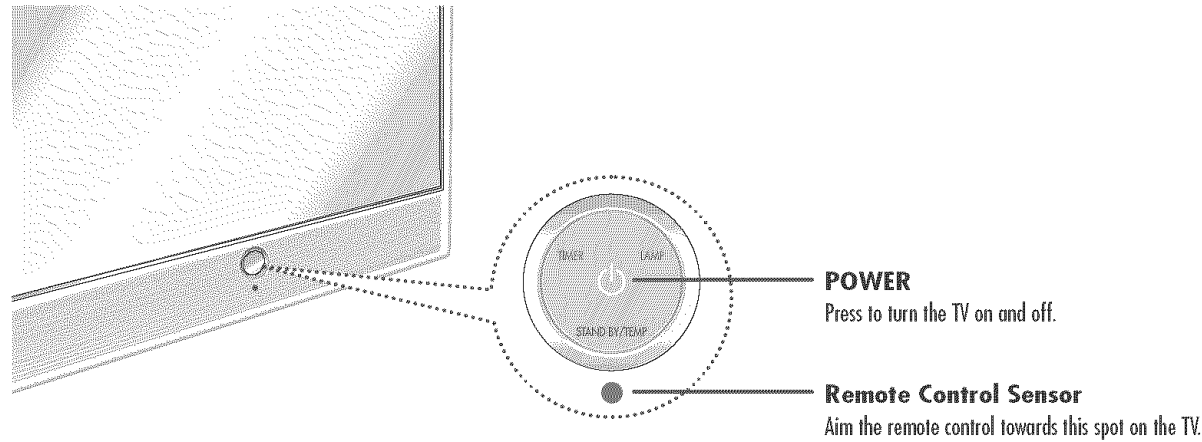

- : Light is On
- ◐ : Light is Blinking
- : Light is Off

TIMER	LAMP	STAND BY/TEMP	Indication
○	○	●	Standby state.
○	◐	○	The picture will automatically appear in about 15 seconds.
●	◐	○	Auto Timer ON/OFF has been set and the set will automatically be turned on in about 25 seconds.
◐	○	◐	A cooling fan inside the set is not operating normally.
○	◐	◐	Lamp cover on rear of the set is not properly shut.
○	○	◐	Check if the ventilation hole on the rear of the set is blocked, because if the inner temperature is too high, the power will shut off.
◐	◐	◐	Lamp may be defective. Please contact a certified technician.

- It takes about 30 seconds for the TV to warm up, so normal brightness may not appear immediately.
- The TV has a fan to keep the inside lamp from overheating. You'll occasionally hear it working.

Rear Panel Jacks

Use the rear panel jacks to connect components such as a VCR. You can connect different components such as VCRs, Set-Top Box and a DVD player etc., because there are two sets of video input jacks and three set of component video input jacks on the rear panel of your TV. For more information, please see "Connections".

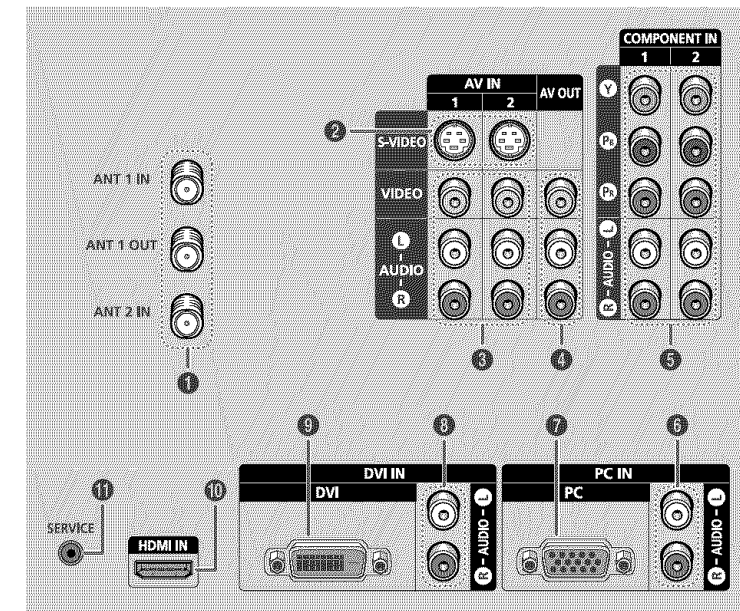

- 1 ANTENNA terminals**
Two independent cables or antennas can be connected to these terminals. Use "ANT 1 IN" and "ANT 2 IN" terminals to receive a signal from VHF/UHF antennas or your cable system. Use the "ANT 1 OUT" terminal to send the signal being received by the "ANT 1 IN" terminal out to another component (such as a Cable Set-Top Box). The PIP channel can be received only when a signal source is connected to "ANT 1 IN".
- 2 S-VIDEO INPUT jacks**
Connects an S-Video signal from an S-VHS VCR or DVD player.
- 3 VIDEO/AUDIO INPUT jacks (VCR1, VCR2)**
Connect video/audio signals from external sources, such as a VCR or DVD players.
- 4 VIDEO/AUDIO OUTPUT jacks**
Sends a video signal from the TV to an external source, such as a VCR. Note: It is available only in RF, Video and S-Video modes.
- 5 Component 1, 2 jacks (Y, Pb, Pr, L, R)**
Use these jacks to connect the component video/audio signals from a DVD player or a set top box when using the component video input jacks.
- 6 PC AUDIO INPUT jacks**
Connect these to the audio output jacks on your PC.
- 7 PC VIDEO INPUT jack**
Connect these to the video output jack on your PC.
- 8 DVI (Digital Video Interface) AUDIO INPUT jacks**
Connect to the digital audio output jacks for device with DVI output.
- 9 DVI (Digital Video Interface) VIDEO INPUT jack**
Connect to the digital video output jack for device with DVI output.
- 10 HDMI (High Definition Multimedia Interface) VIDEO/AUDIO INPUT jack**
Connect to the HDMI jack for device with HDMI output.
- 11 SERVICE**
This jack is for repair and software upgrades.

Your New Wide TV

Remote Control

You can use the remote control up to about 23 feet from the TV. When using the remote control, always point it directly at the TV. You can also use your remote control to operate your Set-Top box, VCR, Cable box or DVD player. See pages 46~47 for details.

1. POWER

Turns the TV on and off.

2. S.MODE

Adjust the TV sound by selecting one of the preset factory settings (or select your personal, customized sound settings.)

3. P.MODE

Adjust the TV picture by selecting one of the preset factory settings (or select your personal, customized picture settings.)

4. +100

Press to select cable channels over 100 on TV.

5. VOL +, VOL -

Press to increase or decrease the volume.

6. MUTE

Press to mute the TV sound.

7. FAV.CH (Favorite Channel)

Press to switch between your favorite channels.

8. MENU

Displays the main on-screen menu.

9. STILL

Press to stop the action during a particular scene. Press again to resume normal video.

10. P.SIZE

Press to change the picture size.

11. MODE

Selects a target device to be controlled by the Samsung remote control (i.e., TV, STB, VCR, CABLE, or DVD).

12. PRE-CH

Tunes to the previous channel.

13. TV/VIDEO

Press to display all of the available video sources (i.e., TV, Set-Top box, VCR, DVD, DTV, PC).

14. CH ^, CH v

Press to change channels.

15. INFO

Press to display information on the TV screen.

16. EXIT

Press to exit the menu.

17. ▲, ▼, ◀, ▶, ENTER

Press to select highlight up, down, left, or right. While using the on-screen menus, press the ENTER to activate (or change) a particular item.

18. MTS (Multichannel Television Stereo)

Press to choose Stereo, Mono or SAP (Secondary Audio Program).

19. SRS

Activates TruSurround.

20. ADD/DEL

Press to add or erase channels in the TV's memory. Use the ADD/DEL button to memorize and erase the fine tuning after fine tuning channels.

21. SLEEP

Press to select a preset time interval for automatic shutoff.

22. PIP (Picture In Picture)

Activates PIP.

23. SET

Used during set up of this remote control, so that it will work compatibly with other devices (Set-Top box, VCR, Cable box, DVD, etc.)

24. DNle (Digital Natural Image engine)

Activates DNle.

25. PIP Controls

SIZE; Press to select the size of PIP window.
SWAP; Press to exchange the video signal that is currently displayed on the main screen with the signal in the PIP window.
CH ^/v; Press to display the available channels in sequence. (These buttons change channels in the PIP window only.)

26. VCR/DVD Controls

Controls VCR or DVD functions: Rewind, Stop, Play/Pause, Fast Forward.

27. RESET

If your remote control is not functioning properly, take out the batteries and press the reset button for about 2-3 seconds. Re-insert the batteries and try using the remote control again.

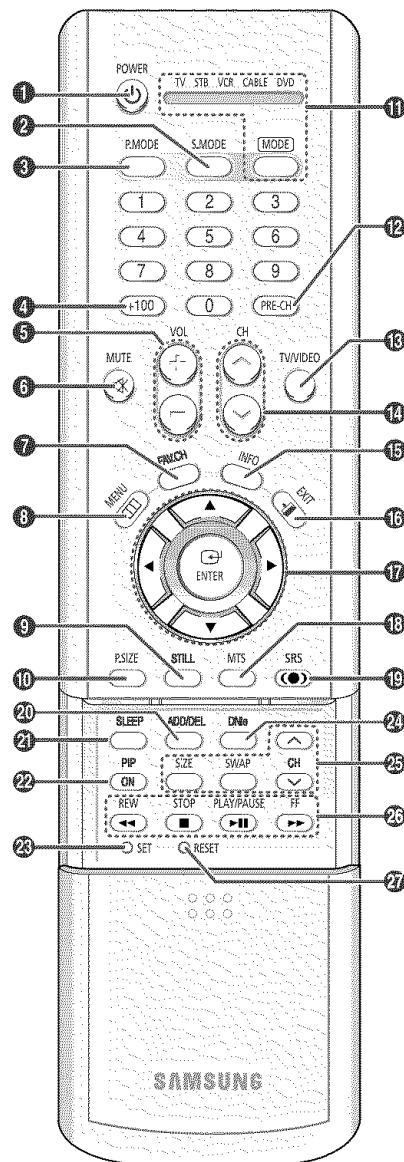

Installing Batteries in the Remote Control

With normal use, the batteries in the remote control should last about a year. If you notice a performance degradation while using the remote, the batteries may need to be replaced. Make sure you replace both batteries and do not mix old and new batteries in the remote control. If you won't be using the remote control for a long time, remove the batteries and store them in a cool dry place.

1 Slide the back cover all the way out to open the battery compartment of the remote control.

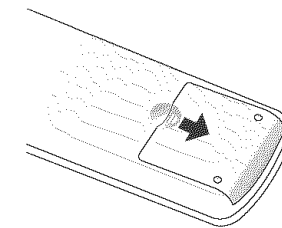

2 Install two AAA size batteries. Make sure to match the "+" and "-" ends of the batteries with the diagram inside the compartment.

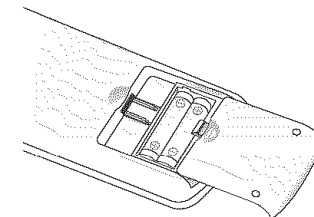

3 Slide the cover back into place.

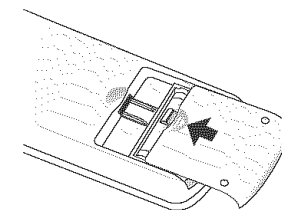



Connections

Connecting VHF and UHF Antennas

If you do not have a cable system, you will need to connect an antenna to your TV.

Antennas with 300-ohm Flat Twin Leads

If your antenna looks like this:  it has 300-ohm flat twin leads.

- 1 Place the wires from the twin leads under the screws on the 300-75 ohm adaptor (not supplied). Use a screwdriver to tighten the screws.

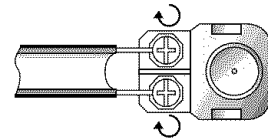

- 2 Plug the adapter into the "ANT 1 IN" terminal on the rear panel.

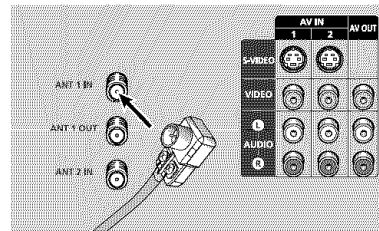

Antennas with 75-ohm Round Leads

If your antenna looks like this:  it is an antenna with 75-ohm round leads.

- 1 Plug the antenna lead into the "ANT 1 IN" terminal on the rear panel.

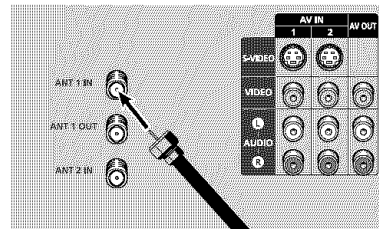

Separate VHF and UHF Antennas

If you have two separate antennas for your TV (one VHF and one UHF), you must combine the two antenna signals before connecting the antennas to the TV. This procedure requires an optional combiner-adaptor (available at most electronics shops).

- 1 Connect both antenna leads to the combiner.

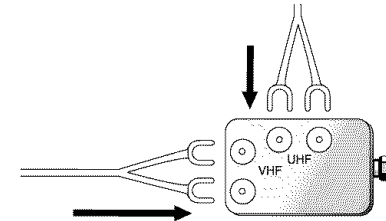

- 2 Plug the combiner into the "ANT 1 IN" terminal on the rear panel.

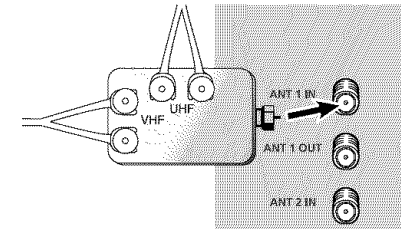

Connections

Connecting Cable TV and VCR

You can connect different cable systems to your TV, including cable without a cable box, and cable with a cable box that descrambles some or all channels.

Cable without a Cable Box

If you want to connect cable, and you do not need to use a cable box:

- 1 Plug the incoming cable into the "ANT 1 IN" terminal on the rear panel.

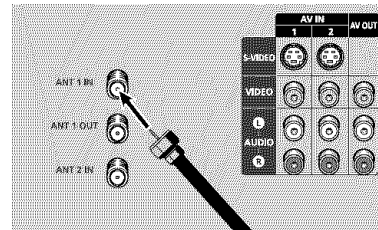

Cable with a Cable Box that Descrambles All Channels

- 1 Find the cable that is connected to the ANTENNA OUT terminal on your cable box. This terminal might be labeled "ANT OUT", "VHF OUT" or simply, "OUT".

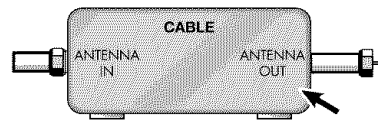

- 2 Connect the other end of this cable to the "ANT 1 IN" terminal on the rear panel.

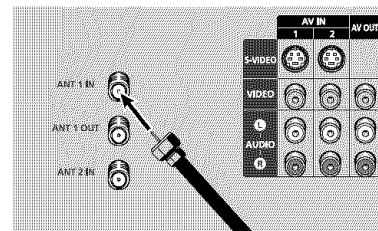

Connecting a Cable Converter Box

This connection allows you to watch cable and premium channels. You should keep your TV selected to "ANT 1 IN" so that you can use the TV features. When viewing premium channels, select "ANT 2 IN" and tune the TV to channel 3 or 4 (whichever channel is vacant in your area), then use the converter box to change channels. You will need two coaxial cables.

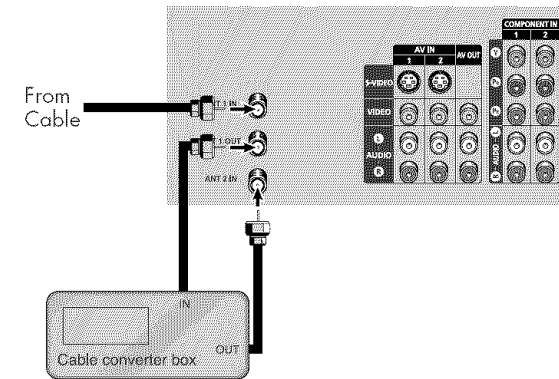

NOTES

- When you use a converter box with your TV, there may be features that you can not program using the remote control, such as programming your favorite channels and blocking channels.
- The output from "ANT 1 OUT" is available when select "Ant.2" in the "Antenna" channel menu.

Connecting a Cable Converter Box and a VCR

This connection allows you to watch and record basic and premium cable channels, as well as watch videotapes. You should keep your TV selected to "ANT 1 IN" so that you can use the TV's features. When viewing premium channels or recording with the VCR, select "ANT 2 IN" (whichever channel is vacant in your area), then use the converter box to change channels.

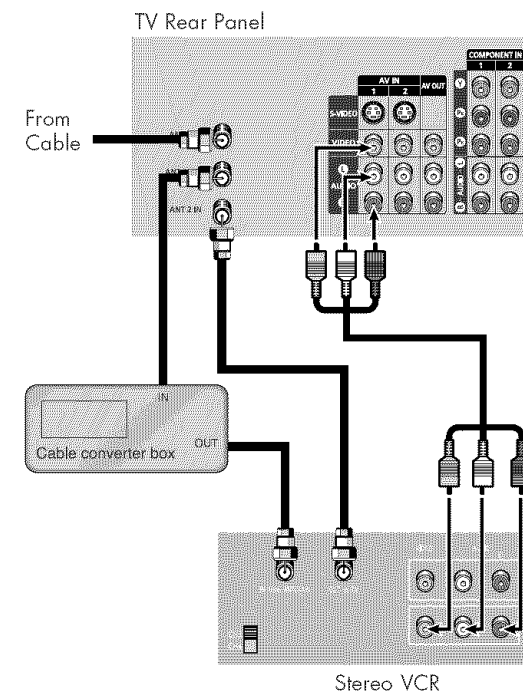

Caution: If you want to record one channel while watching another channel, a splitter (not included) must be added between the cable and "ANT 1 IN". One output of the splitter goes to "ANT 1 OUT" and the second output is connected to IN on the cable converter box.

If you have a mono VCR, connect L/Mono to VCR Audio OUT using only one audio cable.

If you have a S-VHS VCR, use the S-video connections and remove the video cable. Do not connect the video cable and the S-video cable to video1 simultaneously.

When you use a converter box with your TV there may be features that you can not program using the remote control, such as programming your favorite channels and blocking channels.

Connections

Connecting a Camcorder

The side panel jacks on your TV make it easy to connect a camcorder to your TV. You can use your camcorder to view tapes without using a VCR.

- 1 Locate the A/V output jacks on the camcorder. They are usually found on the side or back of the camcorder.
- 2 Connect a set of audio cables between the AUDIO IN jacks on the TV and the AUDIO OUT jacks on the camcorder. If you have mono camcorder, connect L(mono) to camcorder audio out using only one audio cable.
- 3 Connect a video cable between the VIDEO IN (or S-VIDEO IN) jack on the TV and the VIDEO OUT jack on the camcorder. The audio-video cables shown here are usually included with a Camcorder. (If not, check your local electronics store.) If your camcorder is stereo, you need to connect a set of two cables.

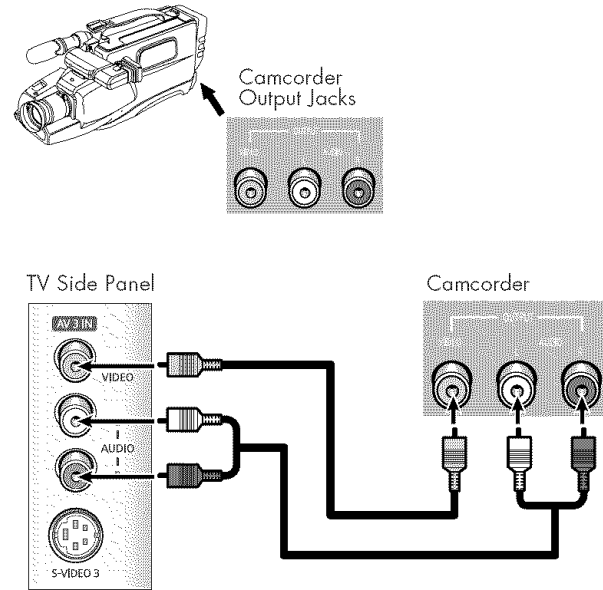

Connecting a DVD Player

The rear panel jacks on your TV make it easy to connect a DVD player to your TV.

Connecting to Y,PB,PR

- 1 Connect a set of audio cables between the COMPONENT (1 or 2) AUDIO (L,R) IN jacks on the TV and the AUDIO OUT jacks on the DVD player.
- 2 To enable Component video viewing, connect a set of video cables between the COMPONENT (1 or 2) VIDEO (Y, PB, PR) IN jacks on the TV and VIDEO (Y/Pb/Pr or Y/Cb/Cr) OUT jacks on the DVD player.

Note: For an explanation of Component video, see your DVD player's owner's manual.

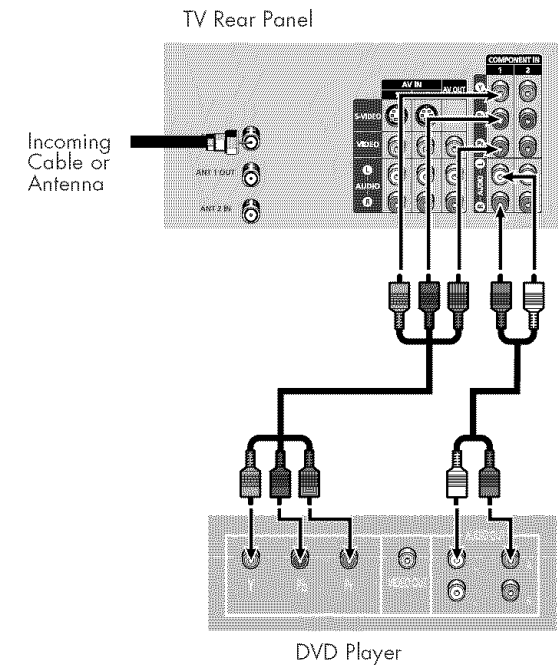

Connecting to audio and video jacks

- 1 Connect a set of audio cables between the AUDIO IN (1 or 2) jacks on the TV and the AUDIO OUT jacks on the DVD player.
- 2 Connect a video cable between the VIDEO IN (1 or 2) jack on the TV and the VIDEO OUT jack on the DVD player.

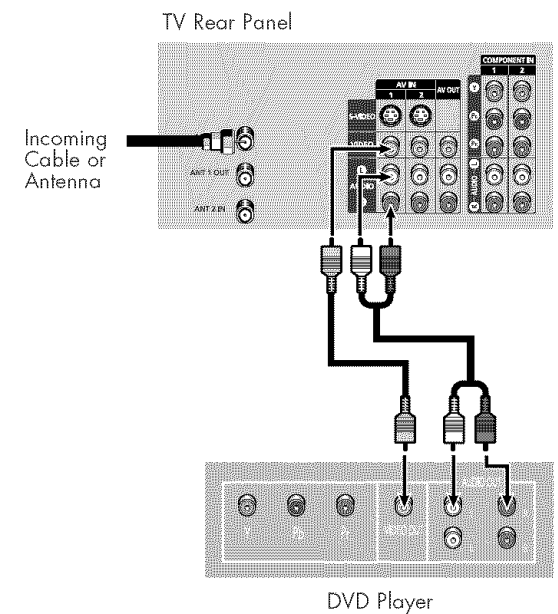

Connections

Connecting a DTV Set-Top Box

Connecting to Y,Pb,Pr

- 1 Connect a set of audio cables between the COMPONENT (1 or 2) AUDIO (L,R) IN jacks on the TV and the AUDIO OUT jacks on the Set-Top Box.
- 2 Connect a set of video cables between the COMPONENT (1 or 2) VIDEO (Y, Pb, Pr) IN jacks on the TV and VIDEO (Y/Pb/Pr or Y/Cb/Cr) OUT jacks on the Set-Top Box.
Note: For an explanation of Component video, see your Set Top Box owner's manual.

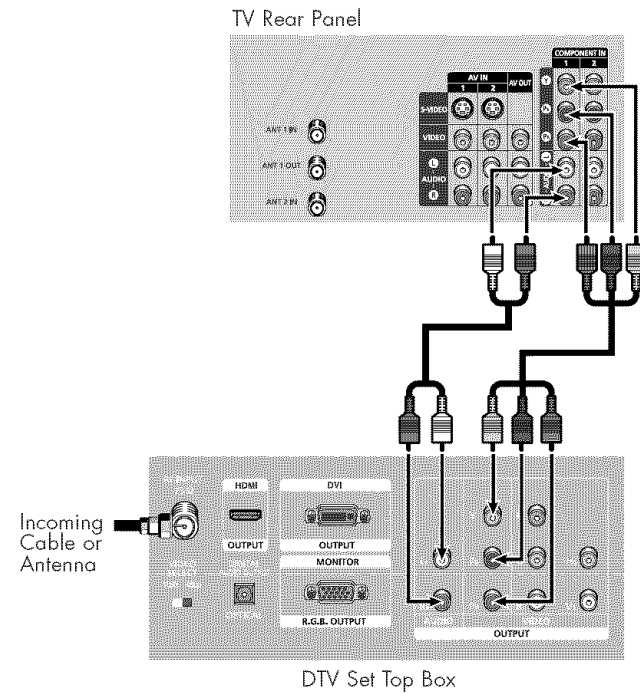

Connecting to R,G,B

- 1 Connect a set of audio cables between the PC AUDIO (L,R) IN jacks on the TV and the AUDIO OUT jacks on the Set-Top Box.
- 2 Connect a video cable between the PC IN jack on the TV and the R.G.B OUT jack on the Set-Top Box.

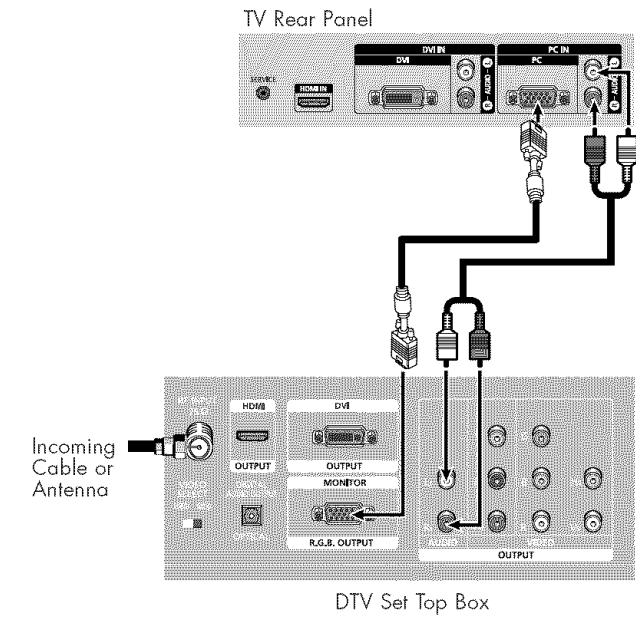

Connecting to DVI (Digital Visual Interface)

- 1 Connect a set of audio cables between the DVI AUDIO (L,R) IN jacks on the TV and the AUDIO OUT jacks on the Set-Top Box.
- 2 Connect a video cable between the DVI IN jack on the TV and the DVI OUT jack on the Set-Top Box.

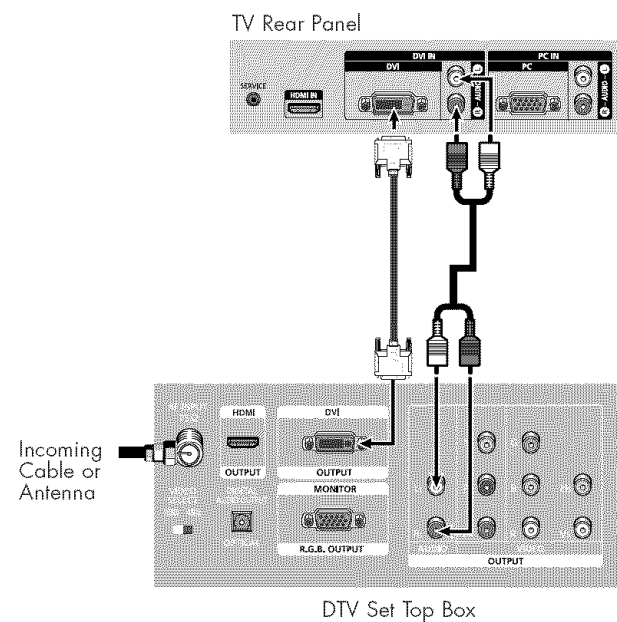

Connecting to HDMI (High Definition Multimedia Interface)

- 1 Connect a HDMI cable between the HDMI IN jack on the TV and the HDMI OUT jack on the Set-Top Box.

NOTE

- Please check if the power of HDMI source is on, in case that you fail to select HDMI from the "Source List" even after you connected the cable of HDMI source (DTV Set-Top Box, DVD, etc.) to TV.

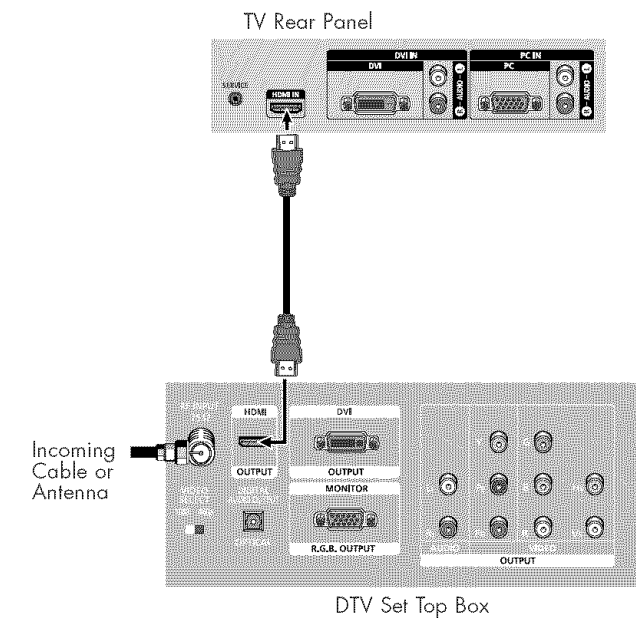



Operation

Turning the TV On and Off

Press the POWER button on the remote control.
You can also use the POWER button on the front panel.

Viewing the Menus and On-Screen Displays

The on-screen menu system allows you to control the settings of your TV. Access the on-screen menu system by pressing the MENU button on the remote control. Once the on-screen menu appears, use the ▲/▼/◀/▶/ENTER on your remote control to select menu items and make adjustments. You can also view the on-screen menu system and make some adjustments using the TV's side panel buttons.

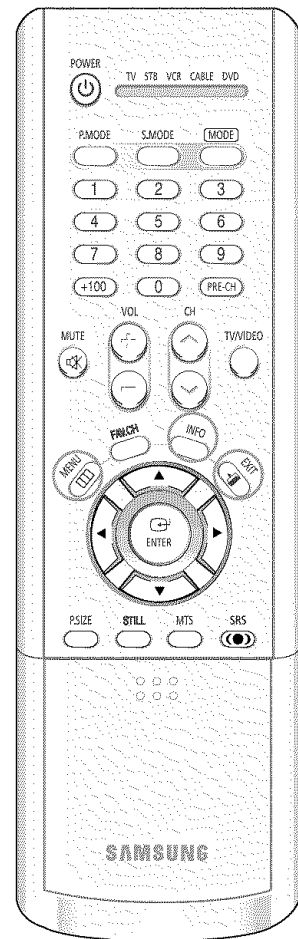

Viewing the Menus

1 Press the MENU button.
The main menu is displayed.
There are five menu groups: "Input", "Picture", "Sound", "Channel" and "Setup".



2 Press the ▲ or ▼ button to select to an item you want in the menu.
Press the ◀, ▶ or ENTER button to display, change, or use the selected items.
Use the ENTER button to enter items in the menu.

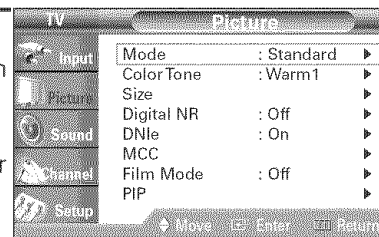

3 Press the EXIT button to exit.

Viewing the Display

Press the INFO button on the remote control.
The TV displays the current channel, the status of certain picture and sound settings and the current time.

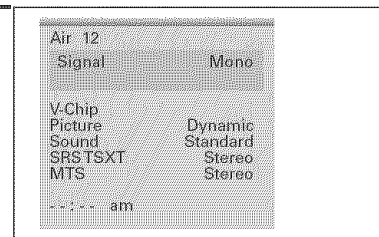

Selecting the Menu Language

Choose a language for the on-screen menus: English, Spanish or French.

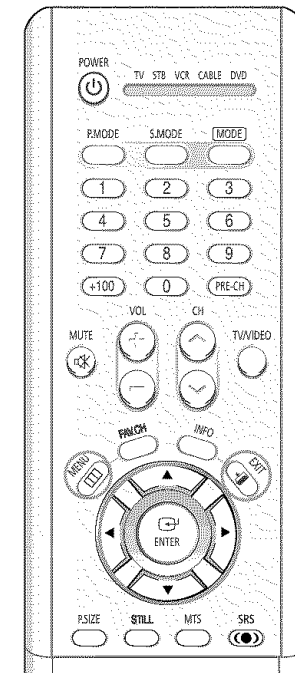

1 Press the MENU button.
Press the ▲ or ▼ button to select "Setup", then press the ENTER button.

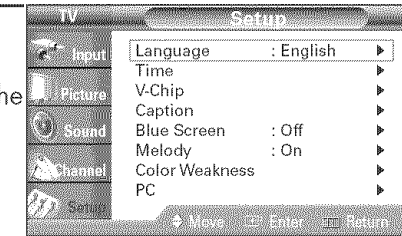

2 Press the ENTER button to select "Language".
Press the ▲ or ▼ button to select the appropriate language, then press ENTER button.

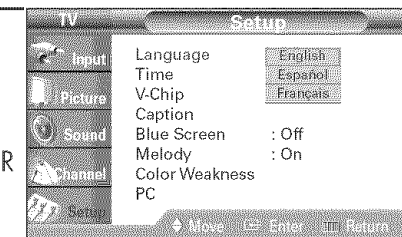

Press the EXIT button to exit.

Selecting the Antenna Input

You can connect to two different signal sources by choosing the antenna input (1 or 2).

1 Press the MENU button.
Press the ▲ or ▼ button to select "Channel", then press the ENTER button.

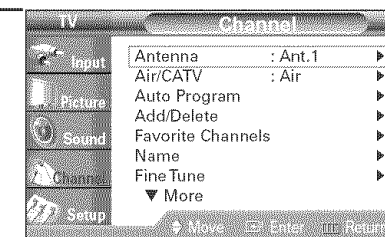

2 Press the ENTER button to select "Antenna".
Press the ▲ or ▼ button to select "Ant.1" or "Ant.2", then press ENTER button.

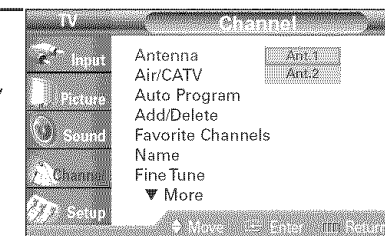

Press the EXIT button to exit.

Operation

Memorizing the Channels

Your TV can memorize and store all of the available channels for both "off-air" (antenna) and cable channels. After the available channels are memorized, use the CH \wedge and CH \vee buttons to scan through the channels. This eliminates the need to change channels by entering the channel digits. There are three steps for memorizing channels: selecting a broadcast source, memorizing the channels (automatic) and adding/deleting channels (manual).

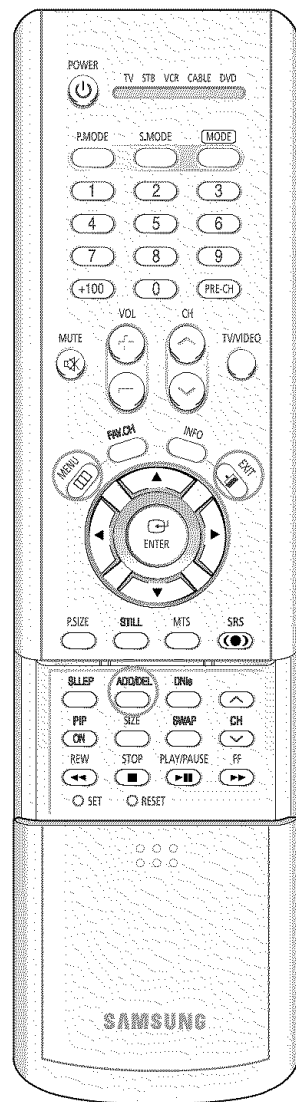

Selecting the Video Signal Source

Before your TV can begin memorizing the available channels, you must specify the type of signal source that is connected to the TV (i.e., an antenna or a cable system).

1 Press the MENU button. Press the \blacktriangle or \blacktriangledown button to select "Channel", then press the ENTER button.

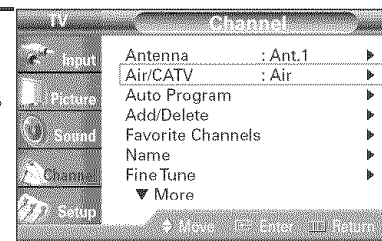

2 Press the \blacktriangle or \blacktriangledown button to select "Air/CATV", then press the ENTER button. If you are connected to an antenna, press the \blacktriangle or \blacktriangledown button to select "Air". If you connected cable, press the \blacktriangle or \blacktriangledown button to select the type of cable system: "STD", "HRC" or "IRC".

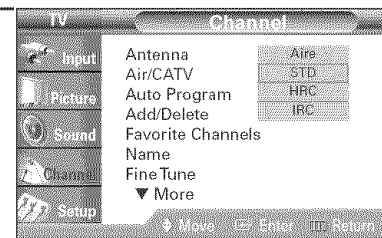

Press the EXIT button to exit.

NOTES

- "STD", "HRC" and "IRC" identify various types of cable TV systems. Contact your local cable company to identify the type of cable system that exists in your particular area. At this point the signal source has been selected. Proceed to "Storing Channels in Memory".
- Subscription cable services require service-specific requirement for viewing.

Storing Channels in Memory (Automatic Method)

First, select the correct signal source ("Air", "STD", "HRC" or "IRC") as described on the previous page.

1 Press the MENU button. Press the \blacktriangle or \blacktriangledown button to select "Channel", then press the ENTER button.

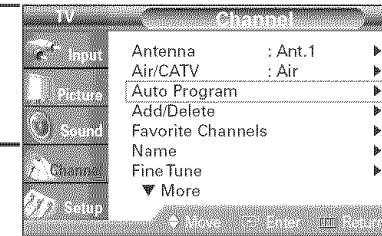

2 Press the \blacktriangle or \blacktriangledown button to select "Auto Program", then press the ENTER button. Press the ENTER button to start the auto program.

The TV begins memorizing all of the available stations. Press the ENTER button at any time to interrupt the memorization process.

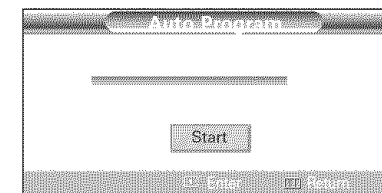

Press the EXIT button to exit.

Adding and Erasing Channels

You can add channels that were not memorized or delete unwanted channels from memory.

1 Press the MENU button. Press the \blacktriangle or \blacktriangledown button to select "Channel", then press the ENTER button.

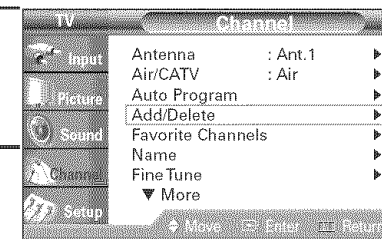

2 Press the \blacktriangle or \blacktriangledown button to select "Add/Delete", then press the ENTER button.

Repeatedly pressing the ENTER button will alternate between add channel and delete channel.

Press the CH \wedge or CH \vee button (or number buttons) to switch to the appropriate channel, then repeat above.

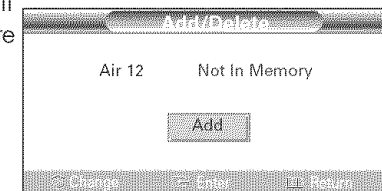

Press the EXIT button to exit.

Alternate method

Simply press the ADD/DEL button on the remote control to add or delete channels.

Operation

Changing Channels

You can change channels on your TV by using the CH \wedge and CH \vee buttons, or by direct selection using the number buttons. You can use the number buttons to tune to any channel (even one that has been erased or has not been memorized).

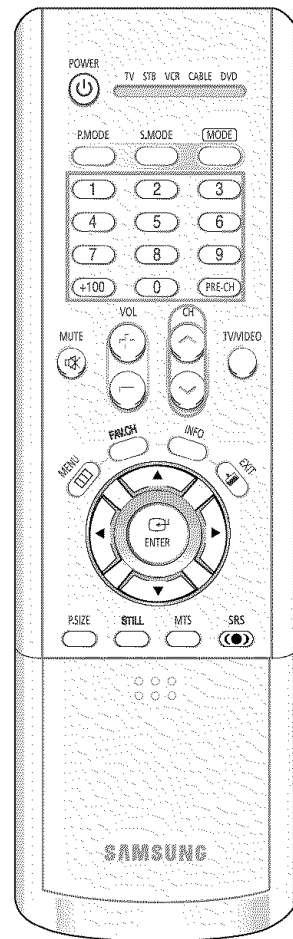

Using the Channel Buttons

Press the CH \wedge or CH \vee button to change channels. When you press the CH \wedge or CH \vee button, the TV changes channels in sequence. You will see all the channels that the TV has memorized. (The TV must have memorized at least three channels.) You will not see channels that were either erased or not memorized.

Using the Number Buttons

Press the number buttons to go directly to a channel. When you use the number buttons, you can directly select channels that were either erased or not memorized.

For example, to select channel "27", press the "2", then "7". The TV will change channels when you press the second number.

To change to single-digit channels (0-9) faster, press the "0" before the single digit. (For channel "4", press the "0", then "4".)

To select a channel over 100, press the +100 button. (For channel "122", press the +100 button, then "2", then "2".)

Using the Previous Channel

Press the PRE-CH button. The TV changes to the last channel you were watching.

Selecting Your Favorite Channels

You can store your favorite channels for each available input source (such as TV and CATV). This allows you to quickly and easily find frequently watched channels by pressing the FAV.CH button on the remote control.

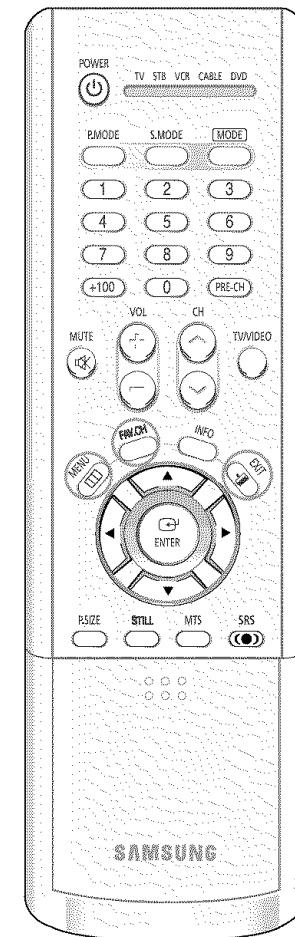

To Store Your Favorite Channels:

- 1 Press the MENU button. Press the \blacktriangle or \blacktriangledown button to select "Channel", then press the ENTER button.

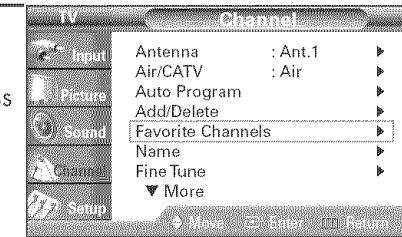

- 2 Press the \blacktriangle or \blacktriangledown button to select "Favorite Channels", then press the ENTER button. Press the \blacktriangle or \blacktriangledown button to select a channel, then press the ENTER button. Press the ENTER button again to deselect the selected channel.

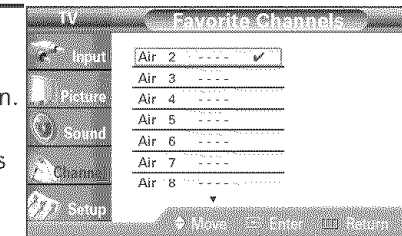

Press the EXIT button to exit.

To View Your Favorite Channels:

Press the FAV.CH button repeatedly to jump from one favorite channel to another.

NOTE

- Only memorized channels can be set as Favorite channels.

Operation

Scanning the Channels

The TV automatically scan all of the channels it has memorized.

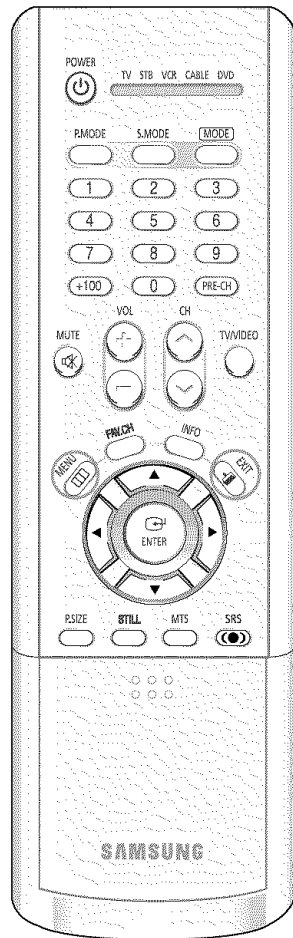

1 Press the MENU button. Press the ▲ or ▼ button to select "Channel", then press the ENTER button.

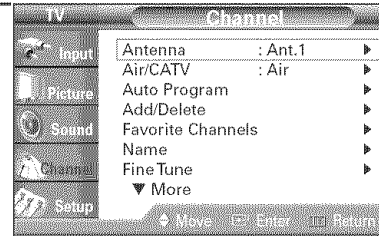

2 Press the ▲ or ▼ button to select "Scan", then press the ENTER button. The TV scans all of the channels memorized.

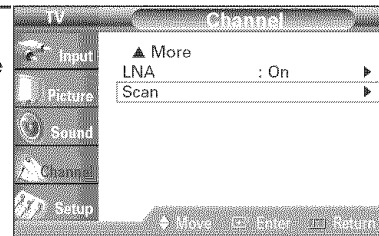

Press the EXIT button to exit.



NOTE

- When the "ANT 2 IN" mode is selected, the channel scan function works on the main picture only.

Labeling the Channels

Use this feature to assign an easy-to-remember label to any channel (i.e., "CBS", "ESPN", "PBS2", "CNN1", etc.) A label consists of five fields, where each field is a letter, a number or a blank. When the INFO button is pressed, the channel label will appear next to the channel number.

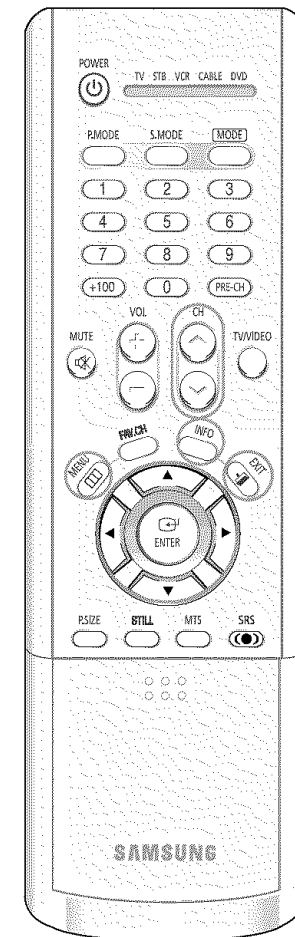

1 Press the CH▲ or CH▼ button to tune to the channel that will be labeled.

2 Press the MENU button. Press the ▲ or ▼ button to select "Channel", then press the ENTER button. Press the ▲ or ▼ button to select "Name", then press the ENTER button.

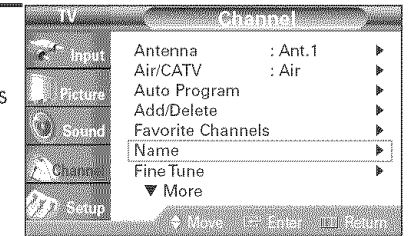

3 Press the ▲/▼/◀/▶ button to move to the channel to be assigned to a new name, then press the ENTER button. Press the ▲ or ▼ button to select a letter, a number or a blank. (Results in this sequence: A...Z, *, blank, 0...9, -).

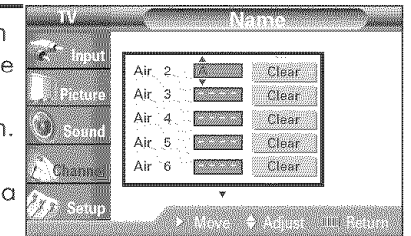

4 Press the ▶ button to switch to the next field, which will be selected. Select a second letter or digit pressing ▲ or ▼ button, as above.

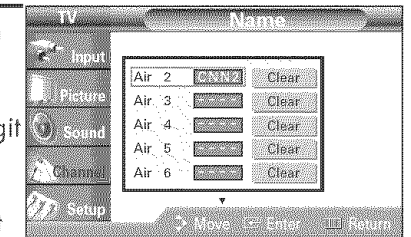

Repeat the process to select the last two digits. When you have finished, press the ENTER button. To erase the assigned new name, select "Clear" by pressing the ▲/▼/◀/▶ button, then press the ENTER button.

Press the EXIT button to exit.

NOTE

- If you add or delete the TV channel, the labeled channels list will also be added or deleted.

Operation

Picture Control

You can use the on-screen menus to change the "Contrast", "Brightness", "Sharpness", "Color" and "Tint" according to personal preference. (Alternatively, you can use one of the automatic settings. See next page.)

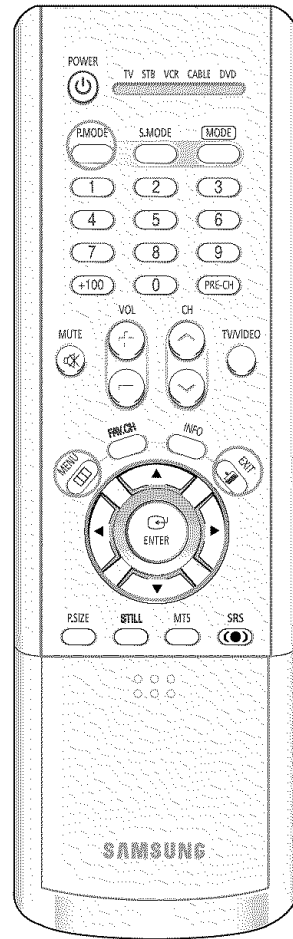

Customizing the Picture

1 Press the MENU button. Press the ▲ or ▼ button to select "Picture", then press the ENTER button.

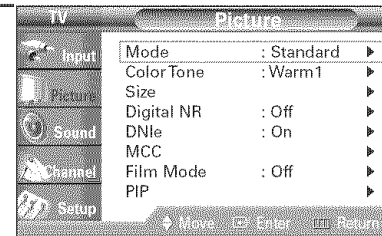

2 Press the ENTER button to select "Mode".

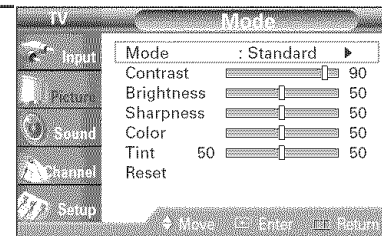

3 Press the ▲ or ▼ button to select a particular item, then press the ENTER button.

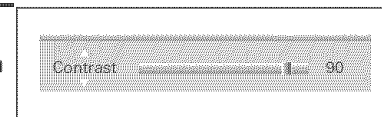

Press the ◀ or ▶ button to increase or decrease the value of a particular item.

Resetting the Picture Settings to the Factory Defaults

You can return to the factory default picture settings.

4 Press the MENU button to display the "Mode" menu. Press the ▲ or ▼ button to select "Reset", then press the ENTER button. The previously adjusted picture settings will be reset to the factory defaults.

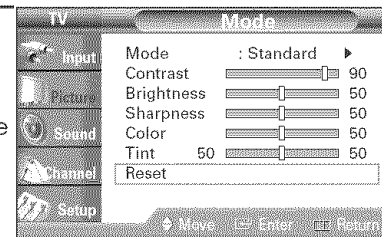

NOTE

- "Tint" doesn't operate in PC, DVI, HDMI or 480p-Component or higher modes.

Using Automatic Picture Settings

Your TV has automatic picture settings ("Dynamic", "Standard" and "Cinema") that are preset at the factory. You can activate either "Dynamic", "Standard" or "Cinema" by pressing the P.MODE button (or by making a selection from the menu). Or, you can select "Custom" which automatically recalls your personalized picture settings.

1 Press the MENU button. Press the ▲ or ▼ button to select "Picture", then press the ENTER button.

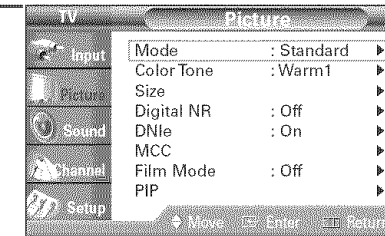

2 Press the ENTER button to select "Mode".

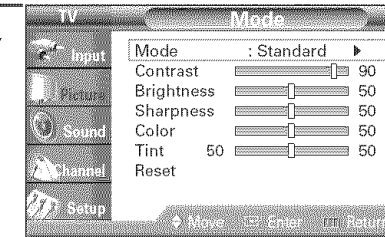

3 Press the ENTER button again to select "Mode". Press the ▲ or ▼ button to select a particular item, then press the ENTER button.

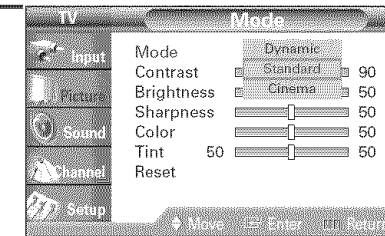

Press the EXIT button to exit.

Alternate method

Press the P.MODE button on the remote control repeatedly to select one of the standard picture settings.

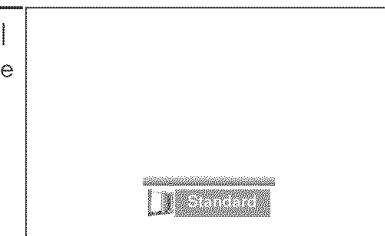

- Choose "Dynamic" for viewing the TV during the day or when there is a bright light in the room.
- Choose "Standard" for the standard factory settings.
- Choose "Cinema" when viewing a movie.

Operation

Sound Control

You can control and customize the sound levels and settings of the TV with the remote control.

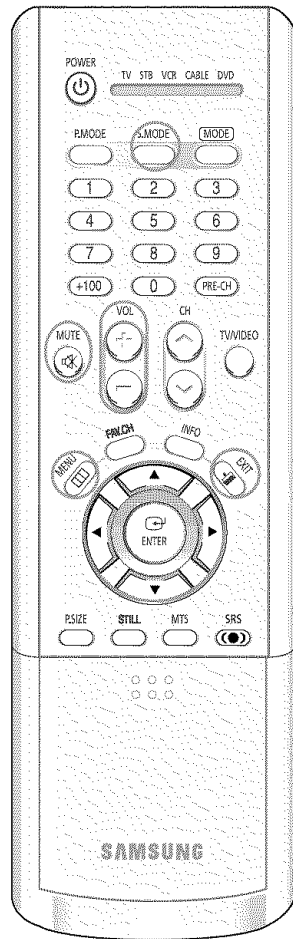

Adjusting the Volume

Press the VOL+ or VOL- buttons to increase or decrease the volume.

Using the MUTE Button

At any time, you can temporarily cut off the sound. Press the MUTE button on the remote control. The message "Mute" is displayed and the sound cuts off.



To turn mute off press the MUTE button again or, press either the VOL+ or VOL- button.

Customizing the Sound

The sound settings can be adjusted to suit your personal preference. (Alternatively, you can use one of the automatic settings. See next page.)

1 Press the MENU button. Press the ▲ or ▼ button to select "Sound", then press the ENTER button.

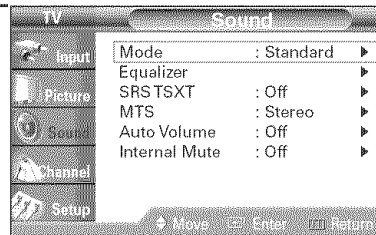

2 Press the ▲ or ▼ button to select "Equalizer", then press the ENTER button.

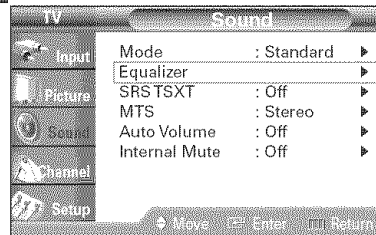

Continued...

3 Press the ◀ or ▶ button to select a particular item to be changed. Press the ▲ or ▼ button to increase or decrease the value of a particular item.

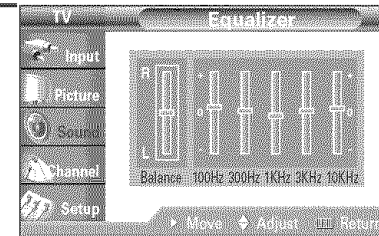

Press the EXIT button to exit.

Using Automatic Sound Settings

Your TV has automatic sound settings ("Standard", "Music", "Movie" and "Speech") that are preset at the factory. You can activate these sound settings by pressing the S.MODE button (or by making a selection from the menu), or you can select "Custom", which automatically recalls your personalized sound settings.

1 Press the MENU button. Press the ▲ or ▼ button to select "Sound", then press the ENTER button.

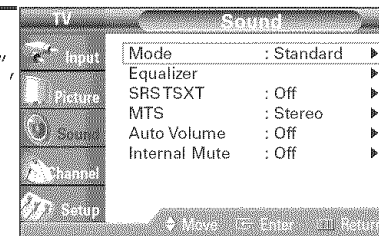

2 Press the ENTER button to select "Mode". Press the ▲ or ▼ button to select a particular item, then press the ENTER button.

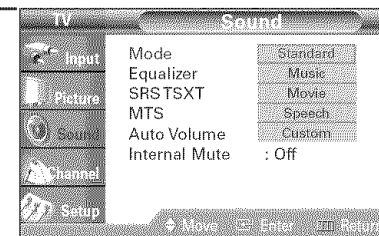

Press the EXIT button to exit.

Alternate method

Press the S.MODE button on the remote control repeatedly to select one of the standard sound settings.

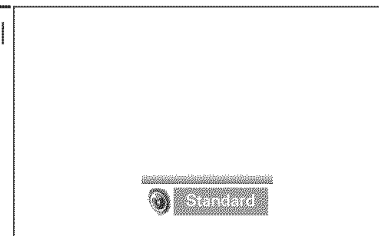

- Choose "Standard" for the standard factory settings.
- Choose "Music" when watching music videos or concerts.
- Choose "Movie" when watching movies.
- Choose "Speech" when watching a show that is mostly dialogue (i.e., news).
- Choose "Custom" to recall your personalized settings.

Operation

Setting the Clock

Setting the clock is necessary in order to use the various timer features of the TV. Also, you can check the time while watching the TV. (Just press the INFO button.)

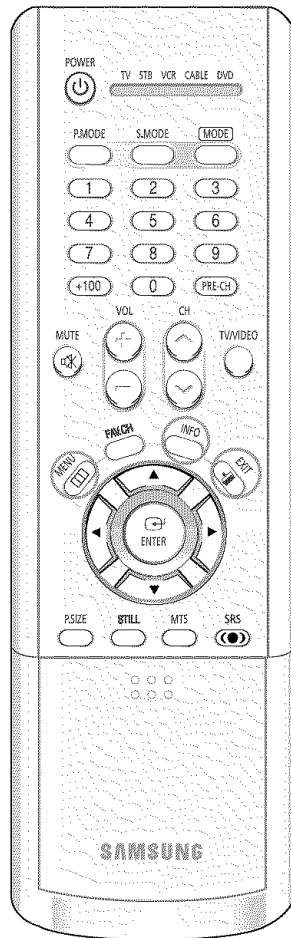

1 Press the MENU button. Press the ▲ or ▼ button to select "Setup", then press the ENTER button. Press the ▲ or ▼ button to select "Time", then press the ENTER button.

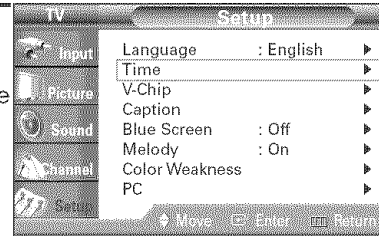

2 Press the ENTER button to select "Clock Set".

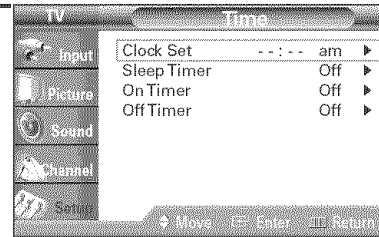

3 Press the ◀ or ▶ button to move to "Hour", "Min" or "am/pm". Set the clock you want by pressing the ▲ or ▼ button, then press the ENTER button. Press the EXIT button to exit.

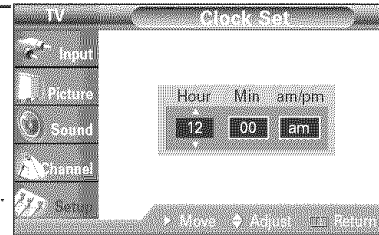

NOTE

- The current time will appear every time you press the INFO button.

Absent Power Off

When you set the timer "On", your television will eventually be turned off, if you do not operate any controls during the 3 hours after the TV is turned on by timer. This function is available only the timer "On" mode and will prevent a leakage accident or overheating, caused by your TV left on for a long time due to the timer "On" (when you are away on holiday, for example).

Setting the Timers

This TV can be set to turn on or off automatically at specific times that you choose. Before using the timers, you must set the TV's clock, as described previously.

Setting the On/Off Timer

1 Press the MENU button. Press the ▲ or ▼ button to select "Setup", then press the ENTER button.

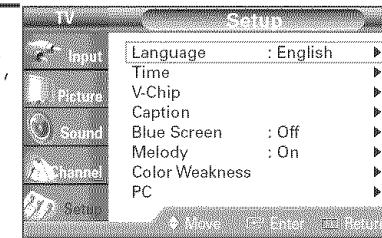

2 Press the ▲ or ▼ button to select "Time", then press the ENTER button. Press the ▲ or ▼ button to select "On Timer", then press the ENTER button.

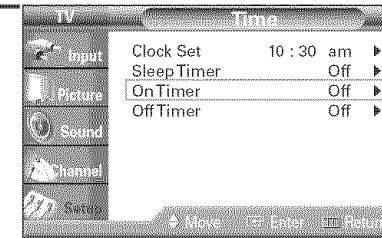

3 Press the ▲ or ▼ button to adjust "Hour", then press the ▶ button to move to the next step. Set other items using the same method as above. When finished, press the MENU button to return.

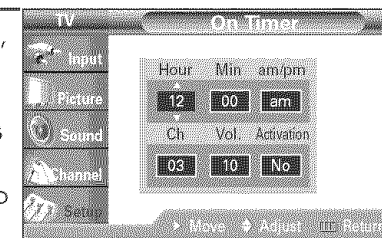

4 Press the ▲ or ▼ button to select "Off Timer", then press the ENTER button.

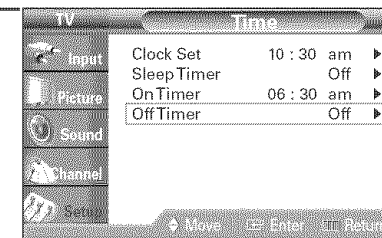

5 Press the ▲ or ▼ button to adjust "Hour", then press the ▶ button to move to the next step. Set other items using the same method as above.

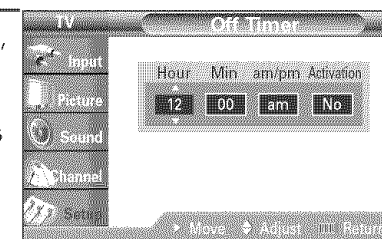

Press the EXIT button to exit.

Operation

Setting the Sleep Timer

The sleep timer automatically shuts off the TV after a preset time (from 30 to 180 minutes).

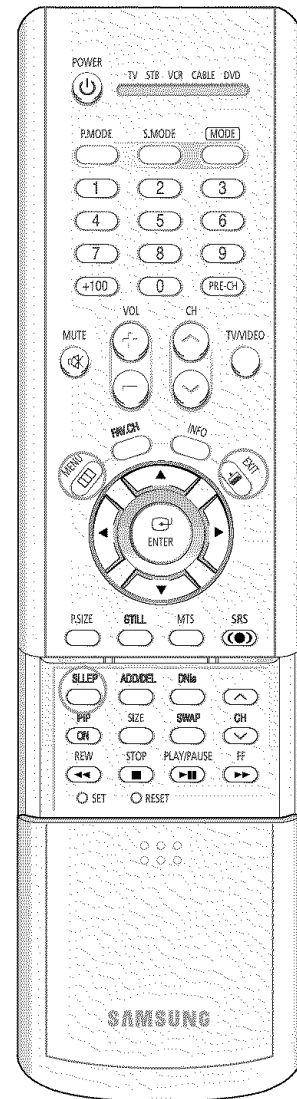

1 Press the MENU button. Press the ▲ or ▼ button to select "Setup", then press the ENTER button.

2 Press the ▲ or ▼ button to select "Time", then press the ENTER button. Press the ▲ or ▼ button to select "Sleep Timer", then press the ENTER button.

3 Press the ▲ or ▼ button to select the preset time you want, then press the ENTER button. Press the EXIT button to exit.

Alternate method

Press the SLEEP button on the remote control repeatedly until the appropriate time interval appears (any of the preset values from "30 Min." to "180 Min.").

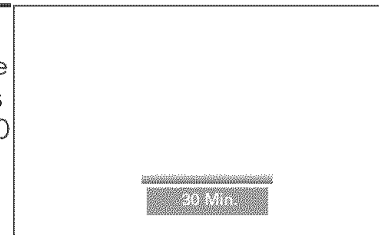

NOTE

- If no signal is received for 15 minutes, the TV will be automatically turned off.

Viewing an External Signal Source

Use the remote control to switch between viewing signals from connected equipment, such as VCR, DVD, Set-Top box and the TV source (broadcast or cable).

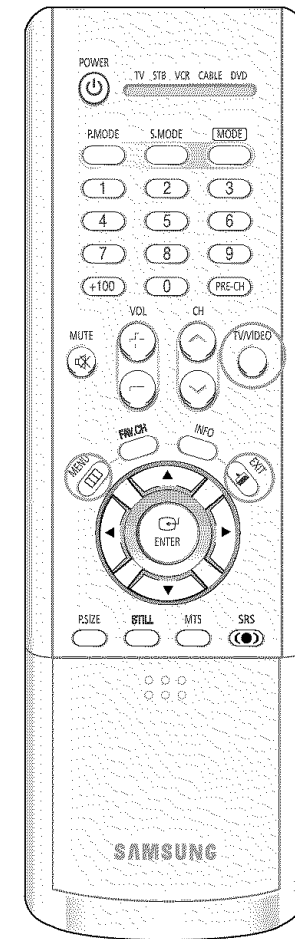

Setting the Signal Source

1 Press the MENU button. Press the ENTER button to select "Input".

2 Press the ENTER button to select "Source List". Press the ▲ or ▼ button to select a signal source, then press the ENTER button. Press the EXIT button to exit.

Alternate method

Press the TV/VIDEO button on the remote control repeatedly to select an external signal source.

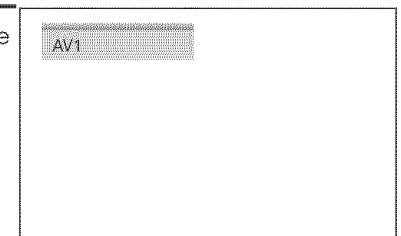

NOTE

- When you connect equipment to the TV, you can choose between the following sets of jacks: "AV1", "AV2", "S-Video1", "S-Video2", "Component1", "Component2", "PC", "DVI" or "HDMI" on the TV's rear panel, and "AV3" or "S-Video3" on the TV's side panel.

Operation

Assigning Names to External Input Mode

This feature enables you to name the input source you have connected.

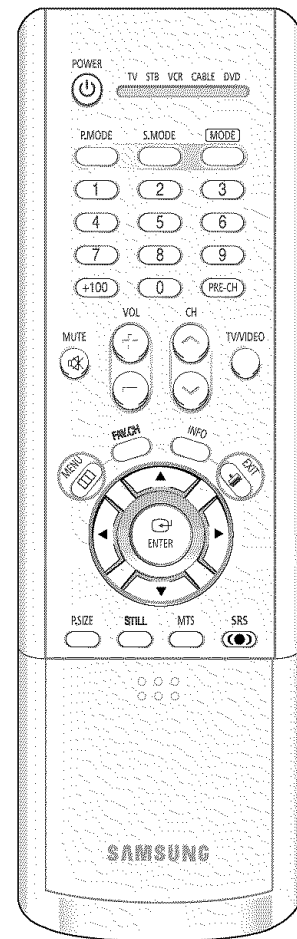

1 Press the MENU button. Press the ENTER button to select "Input".

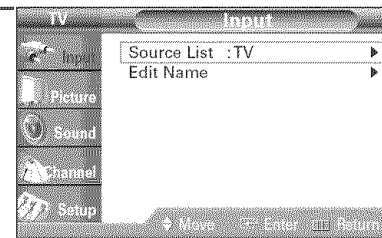

2 Press the ▲ or ▼ button to select "Edit Name", then press the ENTER button.

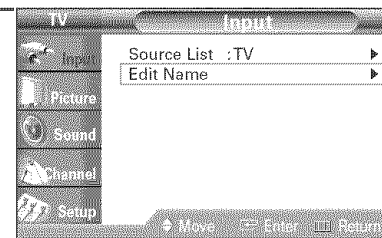

3 Press the ▲ or ▼ button to select a signal source, then press the ENTER button. Press the ▲ or ▼ button to select an external device, then press the ENTER button.

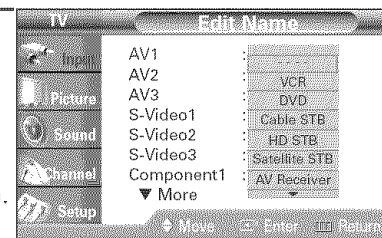

Press the EXIT button to exit.

Freezing the Current Picture

You can freeze the picture when watching a television programme simply by pressing the STILL button. To return to normal viewing, press it again.

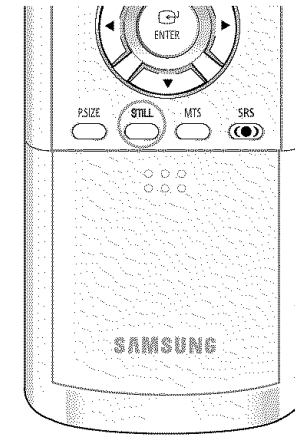

NOTE

- In the PIP mode, the main and sub pictures are stilled at the same time.

Remote Control VCR/DVD Buttons

Slide the cover of the remote control up to access buttons that can control the tape functions of a connected VCR or DVD, including Rewind, Stop, Play/Pause and Fast Forward.

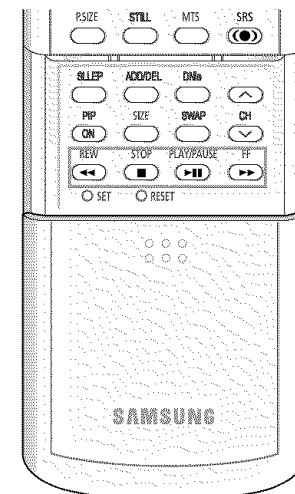

Slide the cover of your remote control unit for access to the tape function controls. Press the appropriate buttons to control your VCR or DVD.



Special Features

Customizing Your Remote Control

Your TV comes equipped with a universal remote control. In addition to controlling the TV, the universal remote control can also operate a VCR, Cable box, DVD and Set-Top Box made by Samsung (even if your VCR, Cable box and DVD are made by manufacturers other than Samsung).

NOTE

- The remote control might not be compatible with all VCRs, DVD players and Cable boxes.

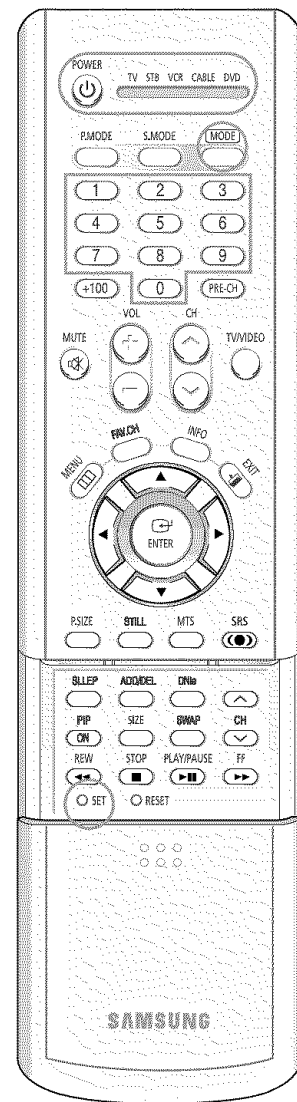

Setting Up Your Remote Control to Operate Your VCR (Cable box or DVD player)

- Turn off your VCR (Cable box or DVD player).
- Press the MODE button to switch the remote control to the VCR (CABLE or DVD) mode.
The remote control has five modes: TV, STB, VCR, CABLE and DVD.
- On your Samsung remote control, press the SET button.
- Enter 3 digits of the VCR (Cable box or DVD player) code listed on next page for your brand of VCR (Cable box or DVD player).
Make sure you enter 3 digits of the code, even if the first digit is a "0". (If more than one code listed, try the first one.)
- Press the POWER button. Your VCR (Cable box or DVD player) should turn on. If your VCR (Cable box or DVD player) turns on, your remote control is now set correctly.
If your VCR (Cable box or DVD player) does not turn on, repeat steps 2, 3, and 4, but try one of the other codes listed for the brand of your particular VCR (Cable box or DVD player).
- Once your remote control is set up, press the MODE button any time you want to use the remote to operate your VCR (Cable box or DVD player).

NOTES

- When your remote is in the TV mode, the VCR (or DVD player) control buttons (REW, STOP, PLAY/PAUSE and FF) will still operate your VCR (or DVD player).
- When your remote control is in the STB, VCR, CABLE or DVD mode, the volume buttons still control your TV's volume.

Remote Control Codes

VCR Codes

Admiral	015,088	Hitachi	014,024,044,045	Quasar	017,053
Aiwa	024	Instant Replay	017	Radio Shack	011,015,017,018,021,024,028,036,052,062
Akai	026,031,032	JC Penny	011,014,016,017,023,025,039,044,060,062	RCA	009,014,016,017,037,044,046,063,078
Audio Dynamics	022,025	JCL	011,017,023,025,039,055	Realistic	011,015,017,018,021,024,028,036,052,062
Bell & Howell	011	Kenwood	011,023,025,039,055	Samsung	000,016,022,031,041,051
Broksonic	019	KLH	082	Sansui	025
Candle	016,018,022,054,055,061	LG(Goldstar)	001,002,007,018,023,055,069	Sonyo	011,021
Canon	017,062	Lloyd	024	Scott	022,050,058,077
Citizen	016,018,022,054,055,061	Lagik	040	Sears	011,014,018,021,027,028,044,052,057
Colortyme	023	LXI	024	Sharp	015,036,048,054
Craig	016,021	Magnavox	017,038,062,065	Shintom	026,035,040,064
Curtis Mathes	009,016,017,023,024,055,062,073,076	Marantz	011,017,023,025,038,039,055,070	Signature	024
Daewoo	003,004,005,006,007,008,022,054,085	MTC	016,024	Sony	026,035,047
DB	023,025	Multitech	016,024,040,041	Sylvania	017,024,038,062,065
Dimensia	009	NEC	011,023,025,039,055,070,073	Symphonic	024
Dynatech	024	Optimus	015	Tandy	011,024
Electrohome	036	Panasonic	017,062,084,086	Tatung	039
Emerson	017,018,019,022,024,029,032,036,043,050,051,056,058,066,071,074,076,077,079	Pentax	014,044	Teac	024,039,078
Fisher	011,021,027,028,052,057,067	Pentax Research+	055	Technics	017
Funai	024	Philco	017,038,062,065	Teknika	017,018,024,030
General Electric	009,016,017,041,062	Philips	017,038	TAMK	076
Go Video	016	Pioneer	014,025,042,059	Toshiba	014,022,028,057,058
Harman Kardon	023	Portland	053,054,061	Toshiko	018
		PROSCAN	009	Totevision	016,018
		Quartz	011		

Cable Box Codes

Anvision	015,016	Magnavox	015,016,027,029,034,036,037,040,041,048,049	Signature	054
Cable Star	015,016	Nawoo	001	Sprucer	035
DaeHan	005	NSC	017	Starcom	054
DeaRyung	003	Oak	024,046	Stargate2000	066
DongKuk	004	Osk Sigma	024	Sylvania	019,067
Eagle	015,016	Panasonic	011,035,047,069	TaePyungYang	002
Eastern International	020	Philips	015,016,027,029,034,036,037,040,041,048,049	Texscan	019,067
General Instrument	054	Pioneer	026,028,052	Tocom	025,029,057,058,063
GI	012,013,023,031,032,033,038,044,075,076,077	Randtek	015,016	Unika	039,040,049
Hamlin	011,012,020,021,042,056	RCA	008,035,074	Universal	059,060
Hitachi	045,051,054	Regal	011,020,021	Viewstar	015,016,027,029,034,036,037,040,041,048,049
Jerrold	012,013,023,031,032,033,038,044,054,070,073	Regency	010,041	Warner Amex	052
LG(Goldstar)	006	Saewoo	007	Zenith	022,050,065,069
Maccom	045,051	Samsung	000,011,030,052,071,072		

DVD Codes

Curtis Mathes	009	Philips	007	Sharp	005
JVC	003	PROSCAN	008	Sony	004
LG(Goldstar)	001	RCA	008	Toshiba	002
Panasonic	006	Samsung	000		

Special Features

Fine Tuning Channels

The Fine Tuning function lets you manually adjust the TV's tuner if you have difficulty tuning channels.

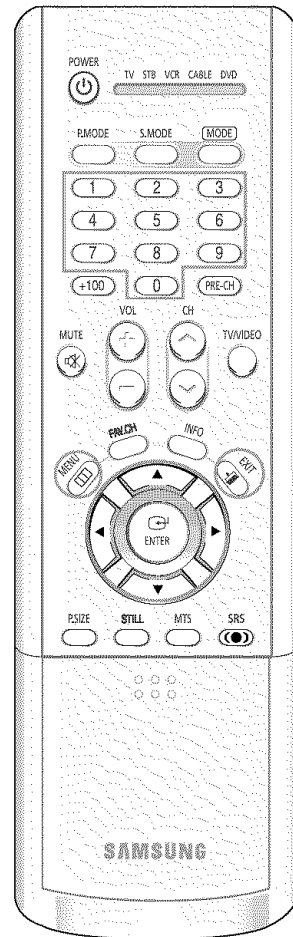

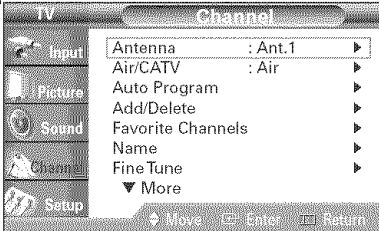
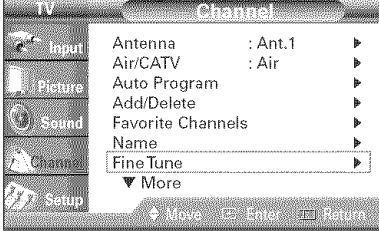
- Using the number buttons on the remote control, select the channel you want to fine tune.
- Press the MENU button. Press the ▲ or ▼ button to select "Channel", then press the ENTER button.
 
- Press the ▲ or ▼ button to select "Fine Tune", then press the ENTER button.
 
- Press the ◀ or ▶ button to adjust the fine tuning.

To store the fine tuning setting in the TV's memory, press the ENTER button. The symbol "*" is displayed.

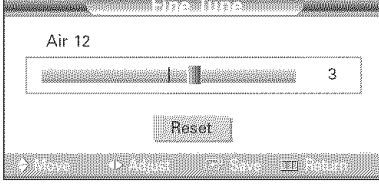

To reset the fine tuning to "0", select "Reset" by pressing the ▲ or ▼ button, then press the ENTER button.

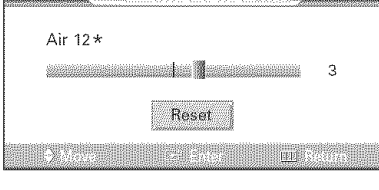

Press the EXIT button to exit.

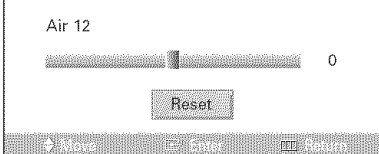

LNA (Low Noise Amplifier)

When a weak broadcast signal causes unclear noisy picture the "LNA" feature improves the picture quality by setting to "On". If you experience noise on a certain channel, set the "LNA" to "On" or "Off" for this channel, to obtain the optimum picture.

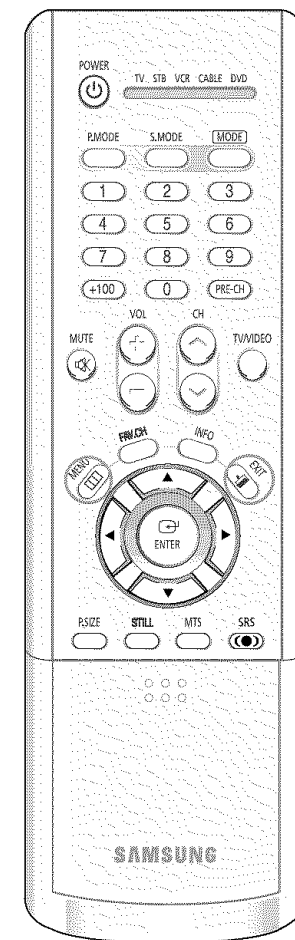

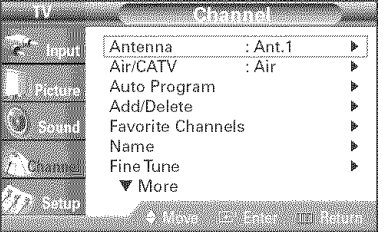
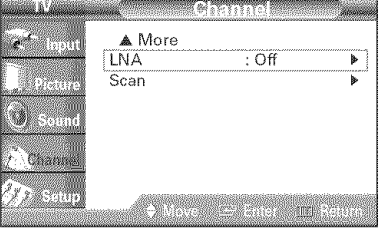
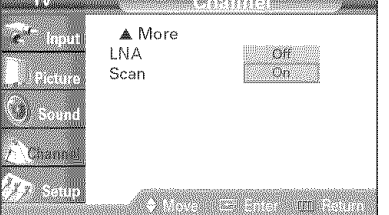
- Press the MENU button. Press the ▲ or ▼ button to select "Channel", then press the ENTER button.
 
- Press the ▲ or ▼ button to select "LNA", then press the ENTER button.
 
- Press the ▲ or ▼ button to select "On" or "Off", then press the ENTER button. Press the EXIT button to exit.
 

NOTE
 • This function works in "ANT 1 IN" mode only (not available in "ANT 2 IN" mode).

Special Features

Selecting the Color Tone

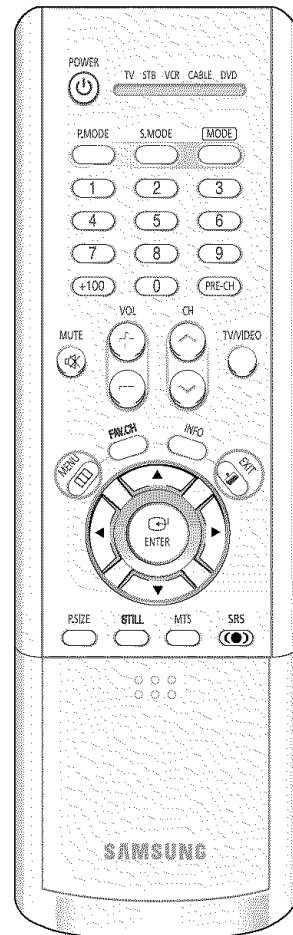

1 Press the MENU button. Press the ▲ or ▼ button to select "Picture", then press the ENTER button.

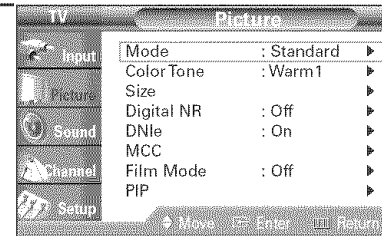

2 Press the ▲ or ▼ button to select "Color Tone", then press the ENTER button.

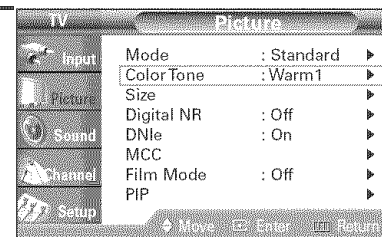

3 Press the ▲ or ▼ button to select "Cool2", "Cool1", "Normal", "Warm1" or "Warm2", then press the ENTER button.

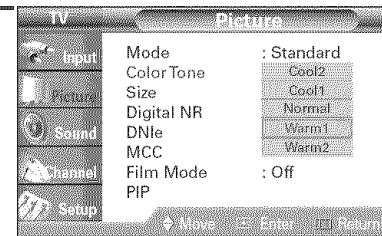

Press the EXIT button to exit.

NOTE

- Not available in the "Cinema" picture mode.

Changing the Picture Size

You can select the picture size which best corresponds to your viewing requirements.

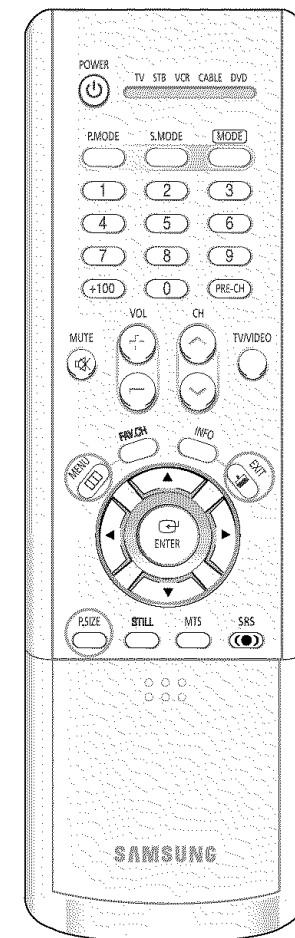

1 Press the MENU button. Press the ▲ or ▼ button to select "Picture", then press the ENTER button. Press the ▲ or ▼ button to select "Size", then press the ENTER button.

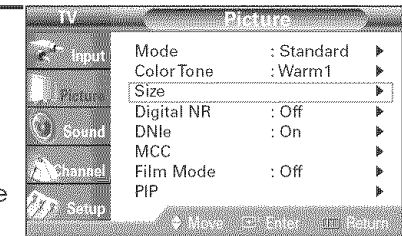

2 Press the ◀ or ▶ button to select the screen format you want, then press the ENTER button.

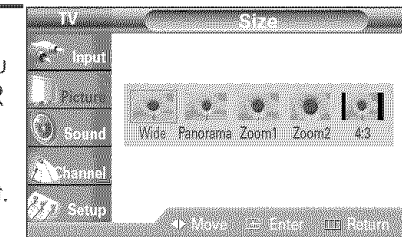

Press the EXIT button to exit.

Alternate method

Press the P.SIZE button on the remote control repeatedly to select one of the picture size settings.

- "Wide": Sets the picture to 16:9 wide mode.
- "Panorama": Use this mode for the wide aspect ratio of a panoramic picture.
- "Zoom1": Magnifies the size of the picture on screen. You can also move the picture on screen using the scroll function. Press the ▲ or ▼ button to scroll the picture.
- "Zoom2": Magnifies the size of the picture more than "Zoom1". You can also move the picture on screen using the scroll function. Press the ▲ or ▼ button to scroll the picture.
- "4:3": Sets the picture to 4:3 normal mode. This is a standard TV screen size.

NOTES

- You can select only Wide, 4:3 screen size in the Component(480p, 720p, 1080i) Mode.
- With PIP On, the screen automatically becomes wide in the Antenna, AV (1~3), S-Video (1~3) or Component (480i) mode. With PIP Off, it returns to original screen size.
- The picture size can't be changed when the "PIP" is active in the TV or AV mode.

Special Features

Digital Noise Reduction

If the broadcast signal received by your TV is weak, you can activate the Digital Noise Reduction feature to help reduce any static and ghosting that may appear on the screen.

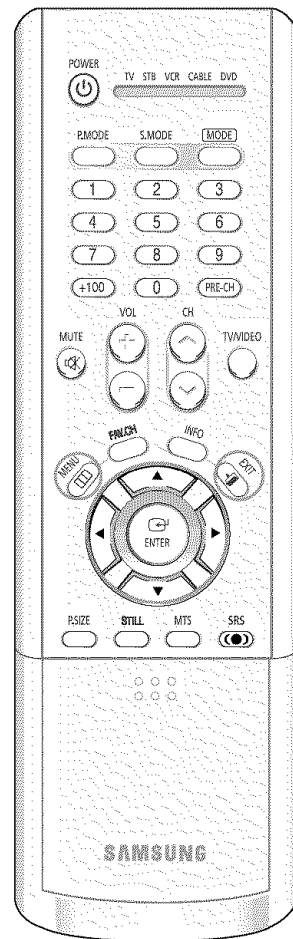

1 Press the MENU button. Press the ▲ or ▼ button to select "Picture", then press the ENTER button.

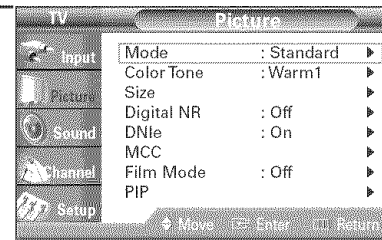

2 Press the ▲ or ▼ button to select "Digital NR", then press the ENTER button.

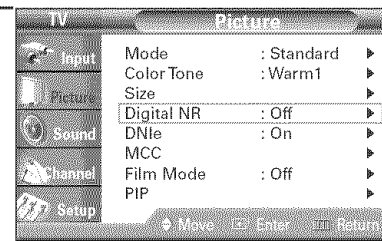

3 Press the ▲ or ▼ button to select "Off" or "On", then press the ENTER button.
Press the EXIT button to exit.

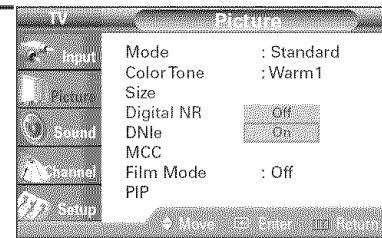

DNle™ (Digital Natural Image engine) **DNle™**

This feature brings you more detailed image with 3D noise reduction, detail enhancement, contrast enhancement and white enhancement. New image compensation Algorithm presents brighter, clearer, much detailed image. DNle™ technology will fit every signals into your eyes.

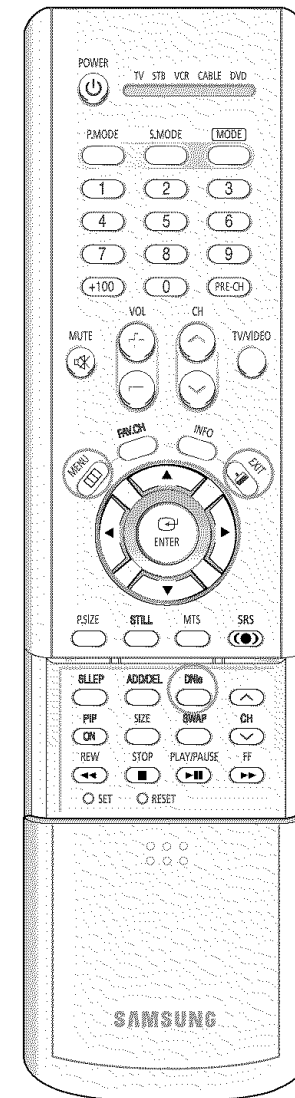

1 Press the MENU button. Press the ▲ or ▼ button to select "Picture", then press the ENTER button.

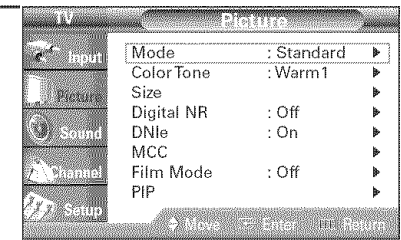

2 Press the ▲ or ▼ button to select "DNle", then press the ENTER button.

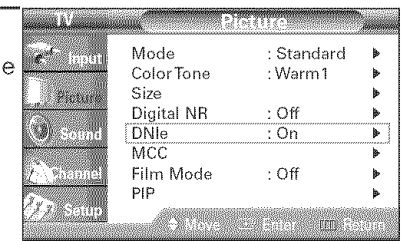

3 Press the ▲ or ▼ button to select "Off", "Demo" or "On", then press the ENTER button.
Press the EXIT button to exit.

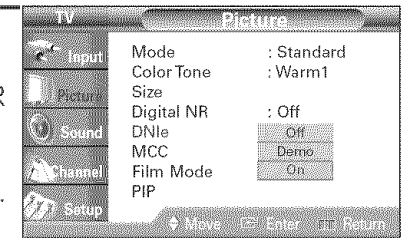

Alternate method

Press the DNle button on the remote control repeatedly to select one of the settings.

- On: Switches on the DNle mode.
- Off: Switches off the DNle mode.
- Demo: The screen before applying DNle appears on the right and the screen after applying DNle appears on the left.

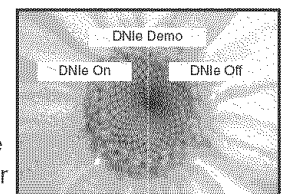

Special Features

Setting the MCC (My Color Control) Mode

MCC allows users to adjust colors according to their preferences, by adjusting skin, sky, and grass tones using the predefined settings ("Turkish Blue", "Emerald Green", "Indian Pink", "Standard", "Custom") without affecting other colors on the screen.

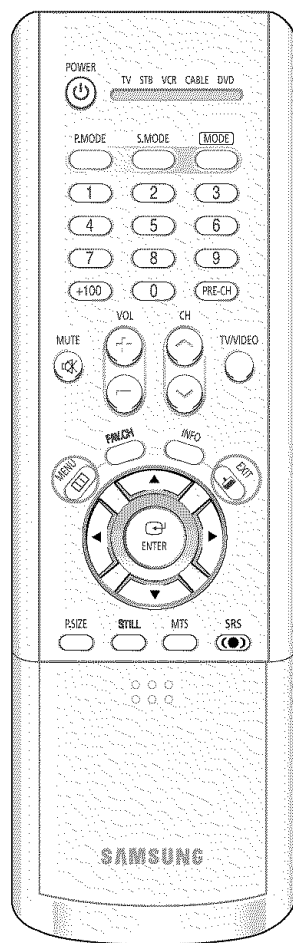

Using the Easy Control Menu

1 Press the MENU button. Press the ▲ or ▼ button to select "Picture", then press the ENTER button.

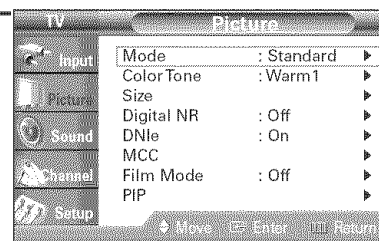

2 Press the ▲ or ▼ button to select "MCC", then press the ENTER button.

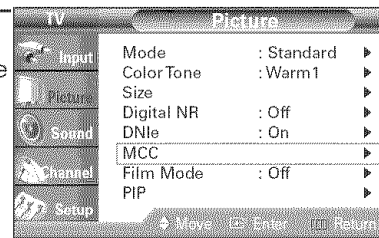

3 Press the ENTER button to select "Easy Control". Press the ◀ or ▶ button to select one of the picture settings you want. The original picture (before adjustment) is shown on the left side, while the selected mode is shown on the right side.

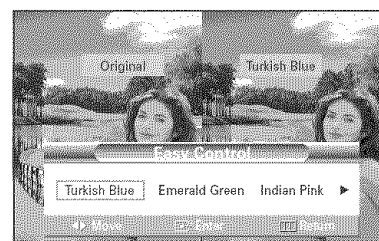
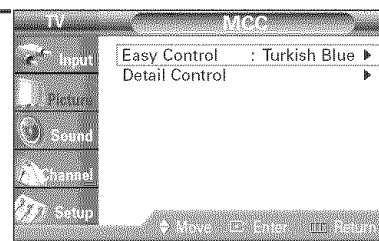

Press the ENTER button to accept the selected mode.

Press the EXIT button to exit.

NOTE

• Changing the settings in the "Detail Control" menu (see next page) will automatically set the MCC mode to "Custom".

- "Turkish Blue": Emphasizing Clear Blues. Feel the clear sun shine on the blue Mediterranean sea.
- "Emerald Green": Emphasizing Mild Greens. Feel the translucent, romantic turquoise sea.
- "Indian Pink": Emphasizing Warm Skin Colors.
- "Standard": Standard Picture

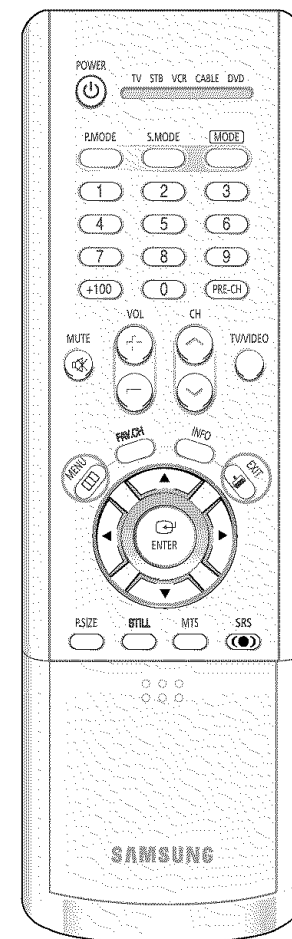

Custom Settings

1 Press the MENU button. Press the ▲ or ▼ button to select "Picture", then press the ENTER button. Press the ▲ or ▼ button to select "MCC", then press the ENTER button.

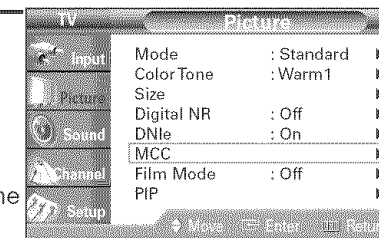

2 Press the ▲ or ▼ button to select "Detail Control", then press the ENTER button.

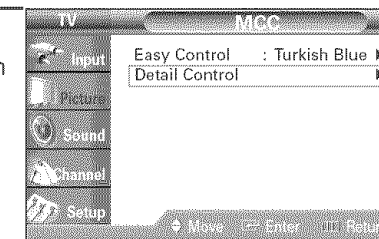

3 Press the ▲ or ▼ button to select one of the MCC color you want, then press the ENTER button. There are three MCC colors: "Skin Tone", "Green Grass" and "Blue Sky".

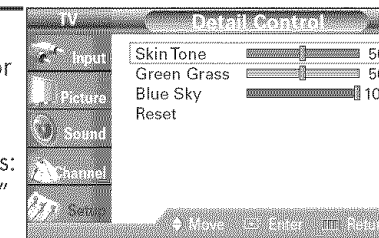

Press the ◀ or ▶ button to adjust the value of a color selected. Changing the adjustment value will refresh the adjusted screen.

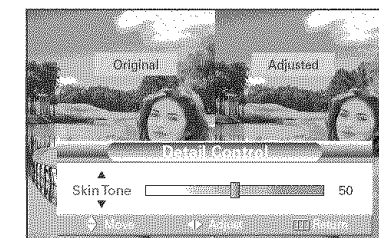

Resetting the MCC Colors to the Factory Defaults

You can return to the factory default settings for MCC colors.

4 Press the MENU button to display the "Detail Control" menu. Press the ▲ or ▼ button to select "Reset", then press the ENTER button. The previously adjusted MCC Colors will be reset to the factory defaults.

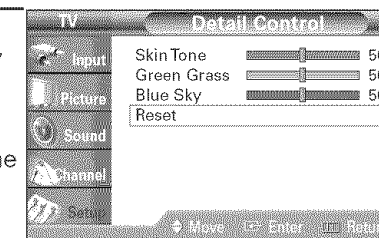

Special Features

Setting the Film Mode

You can automatically sense and process film signals from all sources and adjust the picture for optimum quality.

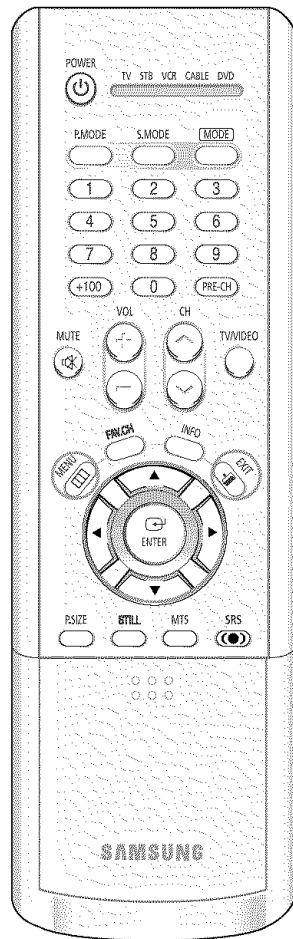

1 Press the MENU button. Press the ▲ or ▼ button to select "Picture", then press the ENTER button.

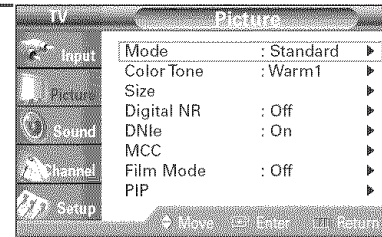

2 Press the ▲ or ▼ button to select "Film Mode", then press the ENTER button.

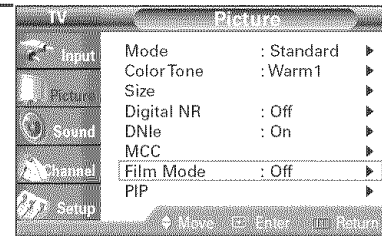

3 Press the ▲ or ▼ button to select "Off" or "On", then press the ENTER button. Press the EXIT button to exit.

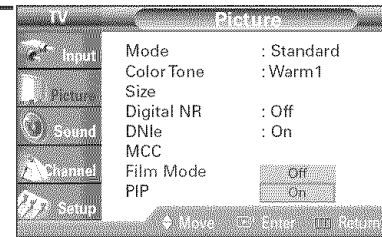

NOTE

- Film mode is supported in 480i only.

Viewing Picture-In-Picture

One of the most best features of your TV is the Picture-In-Picture (PIP) feature. The advanced PIP system allows you to watch two different pictures at once, even if you don't have a VCR connected to your TV.

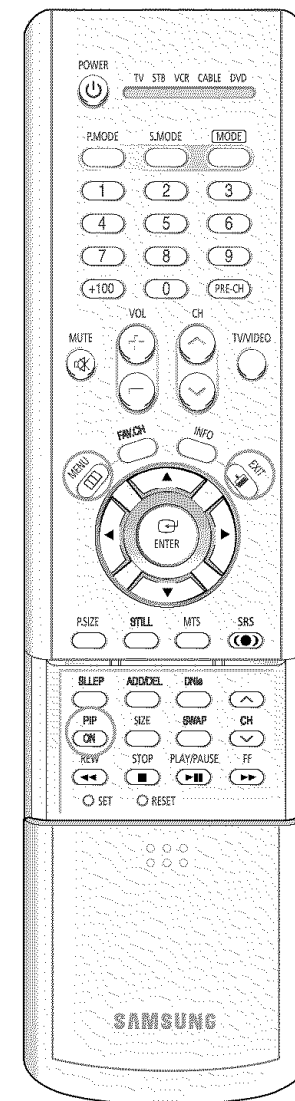

Activating the PIP

1 Press the MENU button. Press the ▲ or ▼ button to select "Picture", then press the ENTER button.

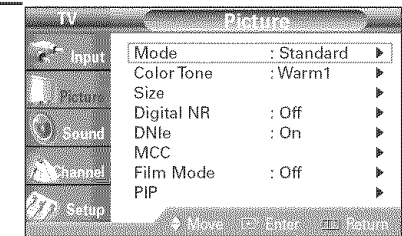

2 Press the ▲ or ▼ button to select "PIP", then press the ENTER button.

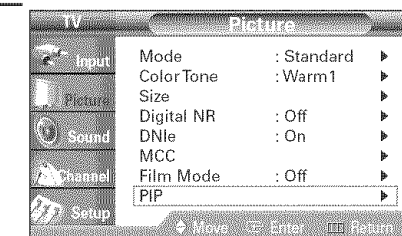

3 Press the ENTER button to select "PIP". Press the ▲ or ▼ button to select "On", then press the ENTER button. The sub picture appears in the corner of the screen.

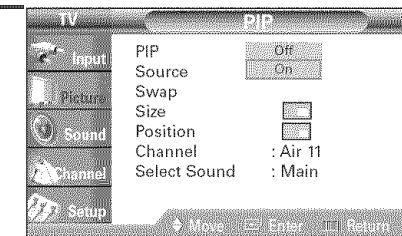

Press the EXIT button to exit.

Alternate method

Press the PIP button on the remote control repeatedly to activate or deactivate the PIP.

NOTES

- This feature doesn't function when the "V-Chip" or "Caption" is active.
- This feature doesn't operate in the HDMI mode.
- If you turn the TV off while watching and turn it on again, then the mode will return to normal video.

Special Features

Selecting an External Source

You can use PIP to view a signal from an external source, such as a VCR.

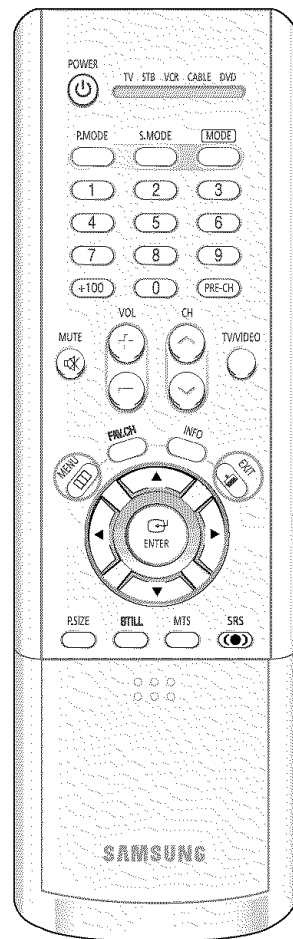

1 Press the MENU button. Press the ▲ or ▼ button to select "Picture", then press the ENTER button.

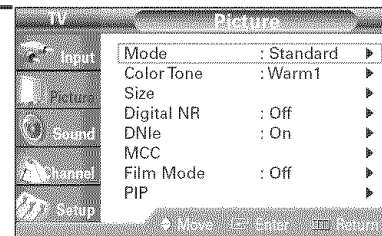

2 Press the ▲ or ▼ button to select "PIP", then press the ENTER button.

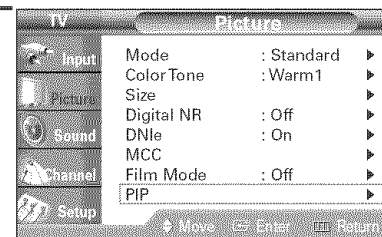

3 Press the ▲ or ▼ button to select "Source", then press the ENTER button. If you have not connected any equipment to the TV's input jacks, the signal from these inputs will not appear.

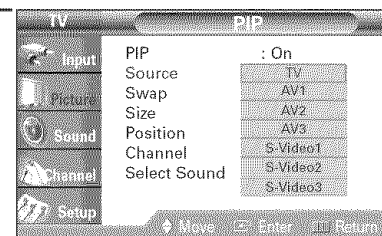

Press the ▲ or ▼ button to select an external signal, then press the ENTER button.

Press the EXIT button to exit.

NOTES

- The sub picture doesn't support "ANT 2 IN", "Component1", "Component2", "PC", "DVI" and "HDMI".
- For more information about external signals, see "Viewing an External Signal Source" (See page 41). If you select "TV", the sub picture is the same as the main picture.

Swapping the Sub Picture and Main Picture

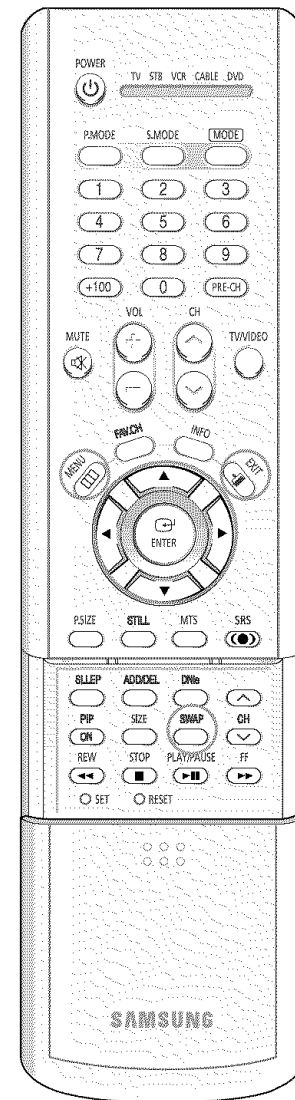

1 Press the MENU button. Press the ▲ or ▼ button to select "Picture", then press the ENTER button.

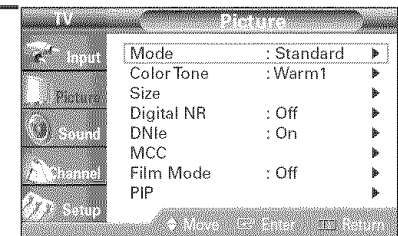

2 Press the ▲ or ▼ button to select "PIP", then press the ENTER button.

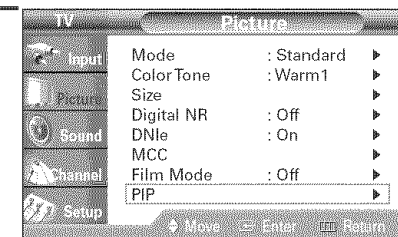

3 Press the ▲ or ▼ button to select "Swap", then press the ENTER button. The sub picture appears in the main picture, and vice versa.

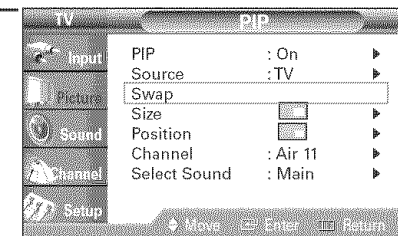

Press the EXIT button to exit.

NOTE

- The swapping doesn't support "ANT 2 IN", "Component1", "Component2", "PC", "DVI" and "HDMI".

Special Features

Changing the Size of the Sub Picture

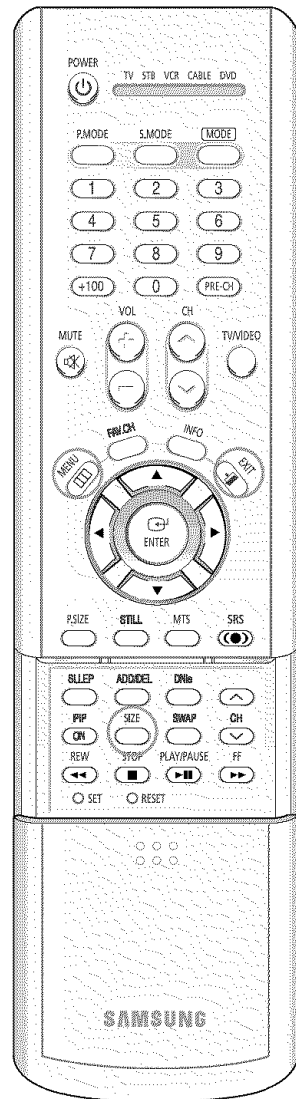

1 Press the MENU button. Press the ▲ or ▼ button to select "Picture", then press the ENTER button.

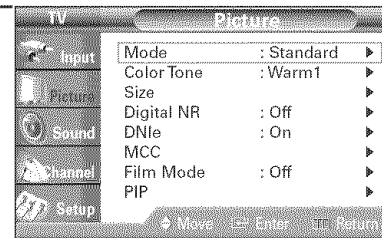

2 Press the ▲ or ▼ button to select "PIP", then press the ENTER button.

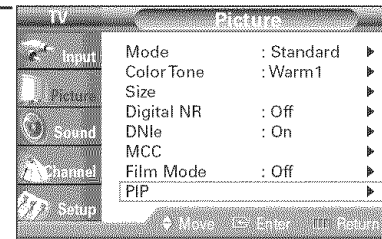

3 Press the ▲ or ▼ button to select "Size", then press the ENTER button.

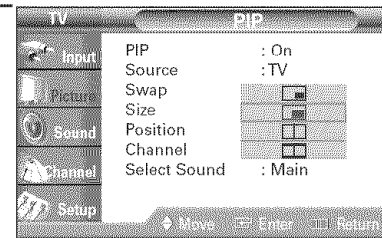

Press the ▲ or ▼ button to select a size you want, then press the ENTER button.

Press the EXIT button to exit.

Alternate method

Press the SIZE button on the remote control repeatedly to select one of the settings.

Changing the Location of the Sub Picture

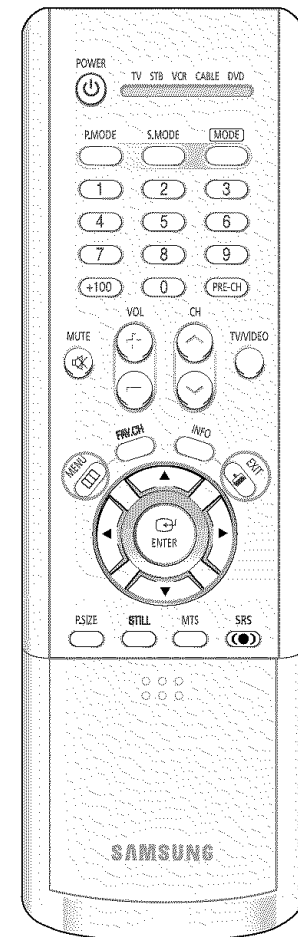

1 Press the MENU button. Press the ▲ or ▼ button to select "Picture", then press the ENTER button.

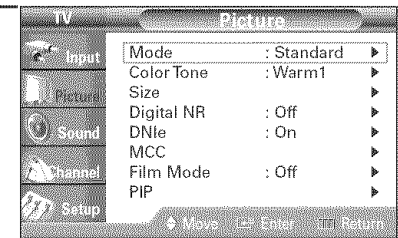

2 Press the ▲ or ▼ button to select "PIP", then press the ENTER button.

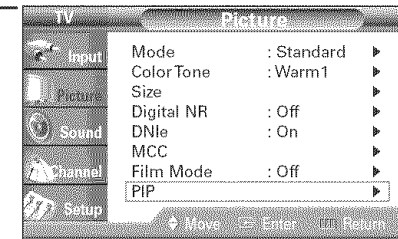

3 Press the ▲ or ▼ button to select "Position", then press the ENTER button.

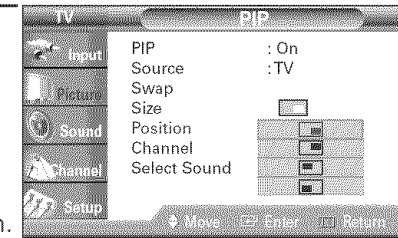

Press the ▲ or ▼ button to select a position you want, then press the ENTER button.

Press the EXIT button to exit.

Special Features

Changing the Channel of the Sub Picture

After you set the signal source (antenna or cable) of sub picture, it is easy to change channels.

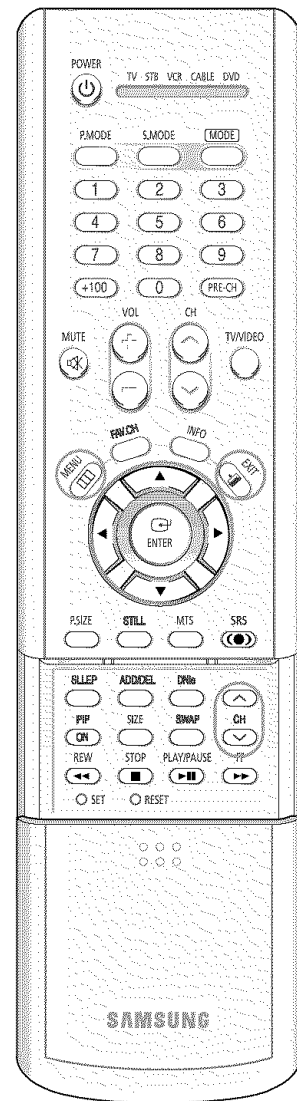

1 Press the MENU button. Press the ▲ or ▼ button to select "Picture", then press the ENTER button.

2 Press the ▲ or ▼ button to select "PIP", then press the ENTER button.

3 Press the ▲ or ▼ button to select "Channel", then press the ENTER button.

Press the ▲ or ▼ button to select a channel you want, then press the ENTER button.

Press the EXIT button to exit.

Alternate method

Press the CH▲ or CH▼ button on the remote control to change channels of sub picture during PIP on.

NOTE

- The channels of sub picture are not available when antenna is set to "ANT 2 IN". It links to "ANT 1 IN".

Selecting the Sound Source

You can use this feature to hear sound from the main or sub picture.

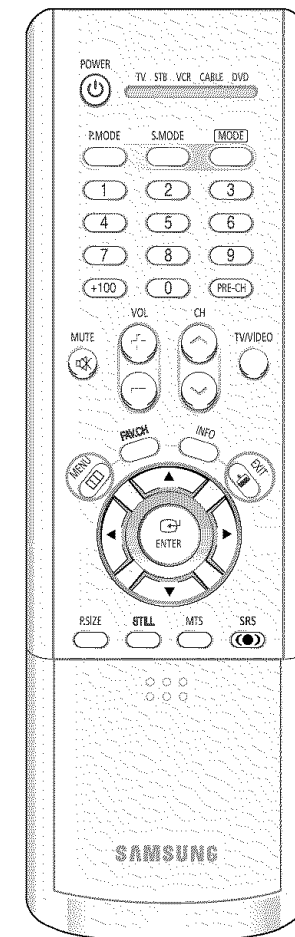

1 Press the MENU button. Press the ▲ or ▼ button to select "Picture", then press the ENTER button.

2 Press the ▲ or ▼ button to select "PIP", then press the ENTER button.

3 Press the ▲ or ▼ button to select "Select Sound", then press the ENTER button.

Press the ▲ or ▼ button to select "Main" or "Sub", then press the ENTER button. "Main" is for the main TV picture audio, and "Sub" is for the sub picture (PIP) audio.

Press the EXIT button to exit.

Special Features

Setting the SRS TSXT

TruSurround XT is a patented SRS technology that solves the problem of playing 5.1 multichannel content over two speakers. Trusurround delivers a compelling, virtual surround sound experience through any two-speaker playback system, including internal television speakers. It is fully compatible with all multichannel formats.

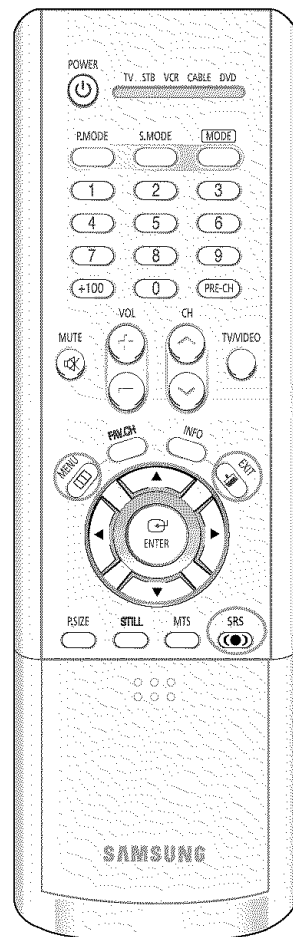

1 Press the MENU button. Press the ▲ or ▼ button to select "Sound", then press the ENTER button.

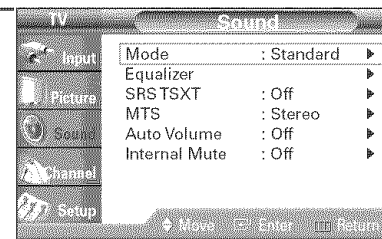

2 Press the ▲ or ▼ button to select "SRS TSXT", then press the ENTER button.

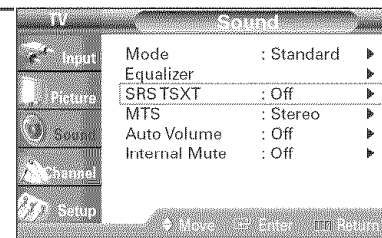

3 Press the ▲ or ▼ button to select "Off", "3D Mono" or "Stereo", then press the ENTER button.

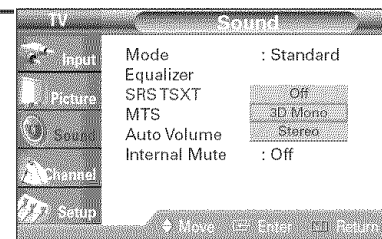

Press the EXIT button to exit.

Alternate method

Press the SRS TSXT button on the remote control repeatedly to select one of the settings.

Choosing a Multi-Channel Sound (MTS) track

Depending on the particular program being broadcast, you can listen to "Mono", "Stereo" or "SAP (Separate Audio Program)". "SAP" audio is usually a foreign-language translation. Sometimes "SAP" has unrelated information like news or weather.

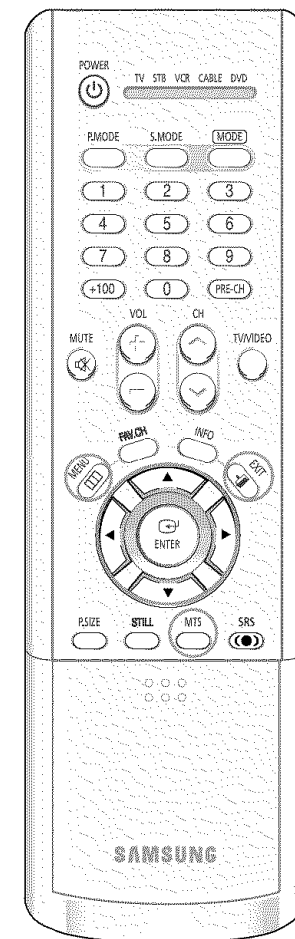

1 Press the MENU button. Press the ▲ or ▼ button to select "Sound", then press the ENTER button.

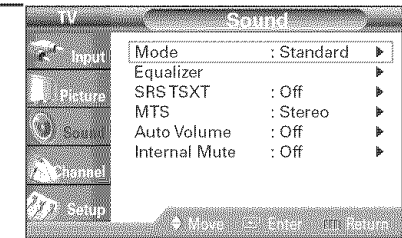

2 Press the ▲ or ▼ button to select "MTS", then press the ENTER button.

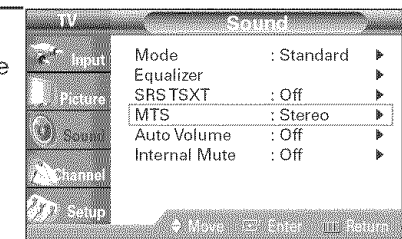

3 Press the ▲ or ▼ button to select "Mono", "Stereo" or "SAP", then press the ENTER button.

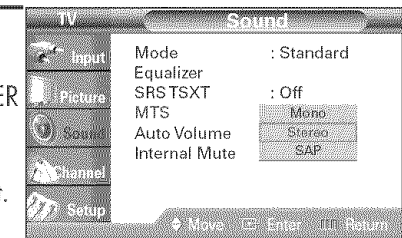

Press the EXIT button to exit.

Alternate method

Press the MTS button on the remote control repeatedly to select one of the settings.

- Choose "Mono" for channels that are broadcasting in mono, or if you are having difficulty receiving a stereo signal.
- Choose "Stereo" for channels that are broadcasting in stereo.
- Choose "SAP" to listen to the Separate Audio Program, which is usually a foreign-language translation.

Special Features

Auto Volume

Each broadcasting station has its own signal conditions, and it is inconvenient to adjust the volume every time the channel is changed. "Auto Volume" automatically adjusts the volume of the desired channel by lowering the sound output when the modulation signal is high or by raising the sound output when the modulation signal is low.

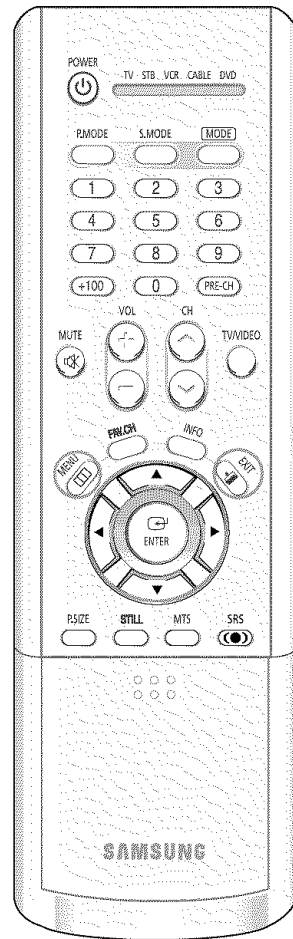

- 1 Press the MENU button. Press the ▲ or ▼ button to select "Sound", then press the ENTER button.

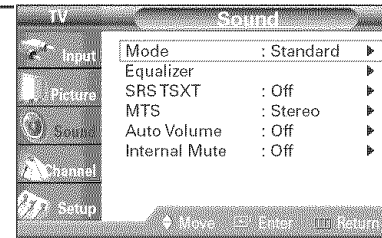

- 2 Press the ▲ or ▼ button to select "Auto Volume", then press the ENTER button.

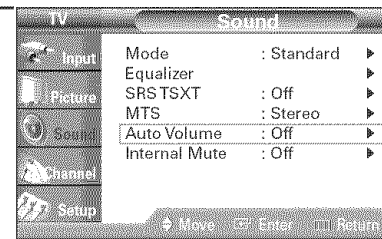

- 3 Press the ▲ or ▼ button to select "Off" or "On", then press the ENTER button.
Press the EXIT button to exit.

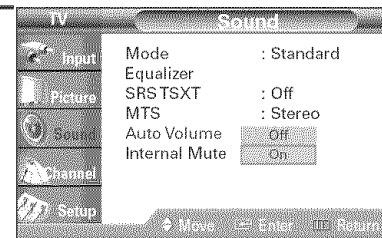

Enjoying the Sound of External Speakers

When using external device such as Home Theater Systems, external speaker, or external Audio Amplifier set "Internal Mute" to "On" to produce sound which is consistent with what the picture shows.

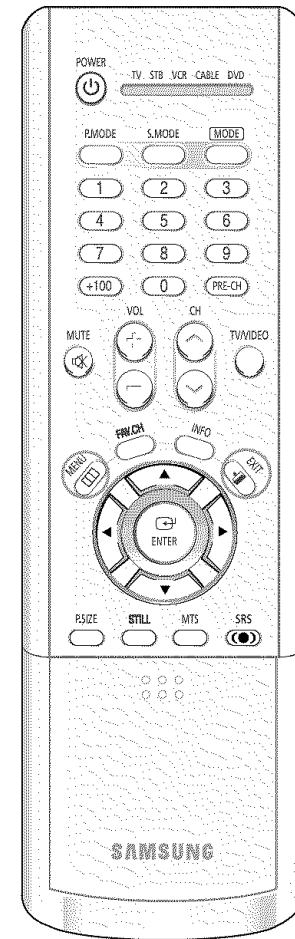

- 1 Press the MENU button. Press the ▲ or ▼ button to select "Sound", then press the ENTER button.

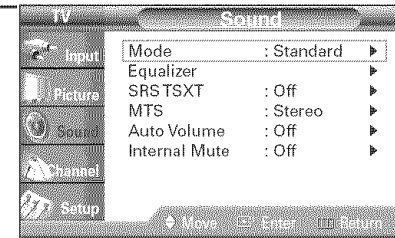

- 2 Press the ▲ or ▼ button to select "Internal Mute", then press the ENTER button.

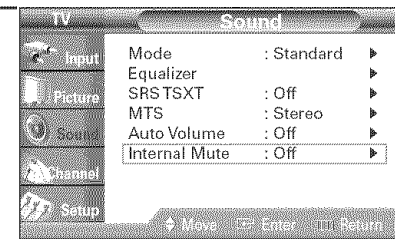

- 3 Press the ▲ or ▼ button to select "Off" or "On", then press the ENTER button.
Press the EXIT button to exit.

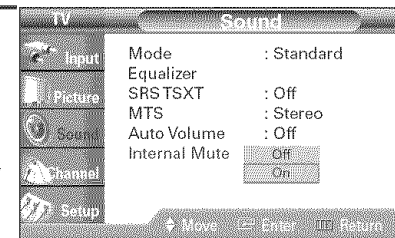

Special Features

Using the V-Chip (USA)

Access to channels and programs is controlled by a password (i.e., a 4-digit secret code that is defined by the user). The on-screen menu will instruct you to assign a password (and you can change it later, if necessary).

NOTE

- The V-Chip doesn't function when the PIP is active.

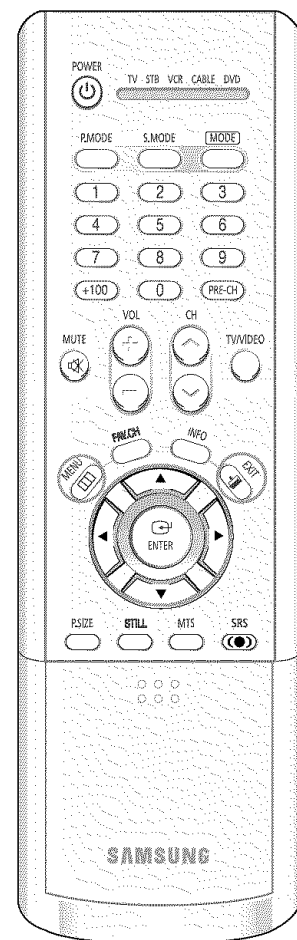

How to Change Your Password

- 1 Press the MENU button. Press the ▲ or ▼ button to select "Setup", then press the ENTER button. Press the ▲ or ▼ button to select "V-Chip", then press the ENTER button.

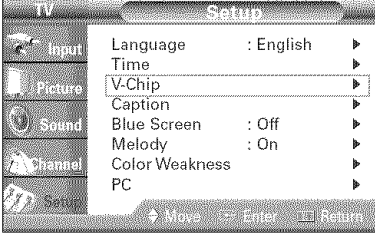
- 2 Press the number buttons to enter your current 4-digit pin number. (The default pin number for a new TV set is "0000".) The "V-Chip" menu is displayed.

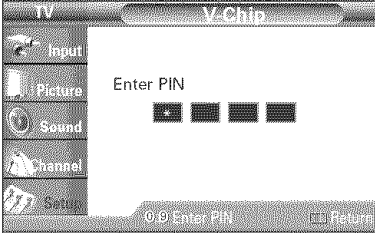
- 3 Press the ▲ or ▼ button to select "Change PIN", then press the ENTER button.

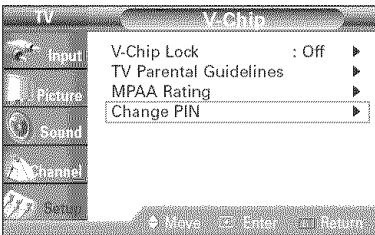
- 4 Press the number buttons to enter your new 4-digit pin number.

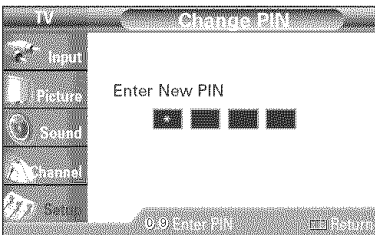

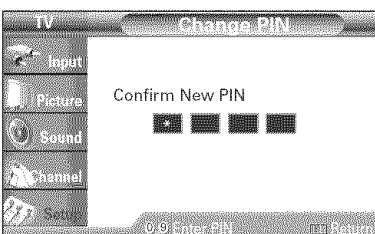
- 5 Re-enter your new pin number to confirm. Press the EXIT button to exit.



NOTE

- If you forget the pin number, press the remote control buttons in the following sequence, which resets the pin to 0-0-0-0: POWER (Off), MUTE, 8, 2, 4, POWER (On).

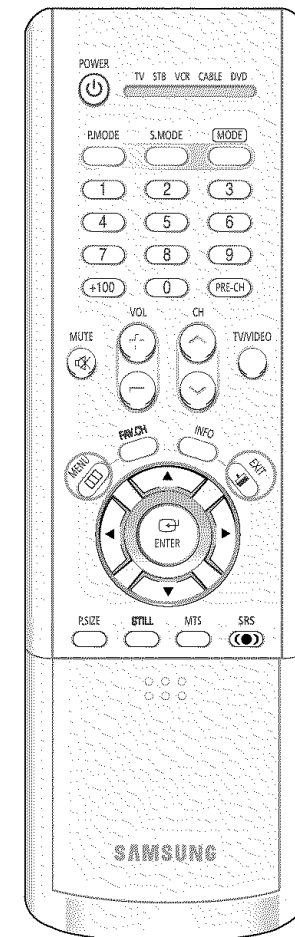
How to Enable/Disable the Rating Controls

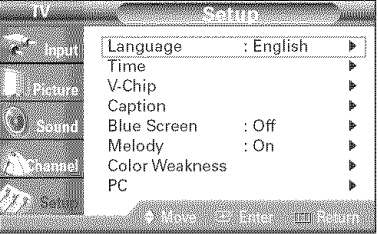

- 1 Press the MENU button. Press the ▲ or ▼ button to select "Setup", then press the ENTER button.

- 2 Press the ▲ or ▼ button to select "V-Chip", then press the ENTER button.

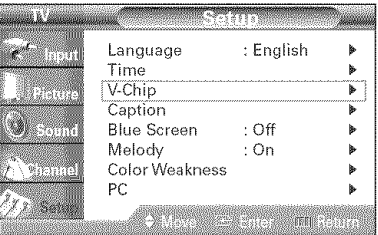
- 3 Press the number buttons to enter your current 4-digit pin number. (The default pin number for a new TV set is "0000".) The "V-Chip" menu is displayed.

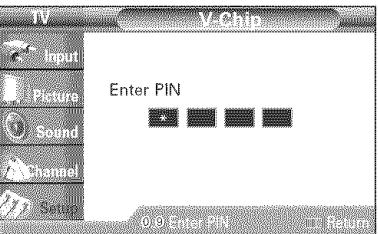
- 4 Press the ENTER button to select "V-Chip Lock".

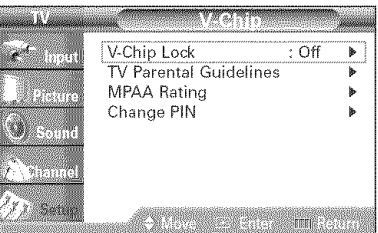

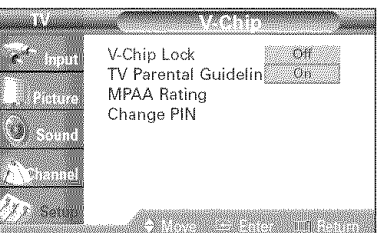
- 5 Press the ▲ or ▼ button to select "On", then press the ENTER button. Press the EXIT button to exit.



Special Features

How to Set up Restrictions Using the "TV Parental Guidelines"

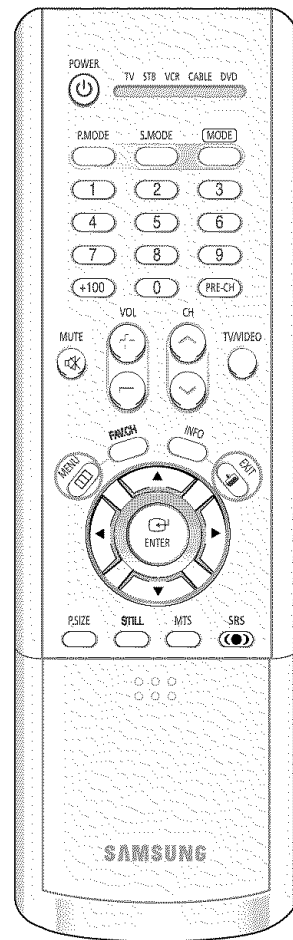
The parental restrictions can be set up using either of two methods: The "TV Parental Guidelines" or "MPAA Rating".



- 1** Press the MENU button. Press the ▲ or ▼ button to select "Setup", then press the ENTER button.
- 2** Press the ▲ or ▼ button to select "V-Chip", then press the ENTER button.
- 3** Press the number buttons to enter your current 4-digit pin number. (The default pin number for a new TV set is "0000".) The "V-Chip" menu is displayed.
- 4** Press the ▲ or ▼ button to select "TV Parental Guidelines", then press the ENTER button.

- 5** You can independently lock the TV ratings. The locked TV (FCC) ratings are indicated by the symbol "🔒". Press the ▲/▼/◀/▶ buttons and the ENTER button to activate the appropriate restrictions for TV (FCC) rating system.
- TV-Y : Young children
 TV-Y7 : Children 7 and over
 TV-G : General audience
 TV-PG : Parent Guidance
 TV-14 : Viewers 14 and over
 TV-MA : Mature Audience
- Press the EXIT button to exit.

NOTES

- These categories consist of two separate groups: "TV-Y" and "TV-Y7" (young children through age 7), and "TV-G" through "TV-MA" (everybody else).
- The restrictions for these two groups work independently: If a household includes very young children as well as young adults, the TV parental guidelines must be set up separately for each age group. (See page 73.)

Special Features

How to Set up Restrictions Using the "MPAA Rating"

The Movie rating system uses the "MPAA" (Motion Picture Association of America) system, and its main application is for movies. When the rating controls is on, the TV will automatically block any programs that are coded with objectionable ratings (either "MPAA Rating" or "TV Parental Guidelines").

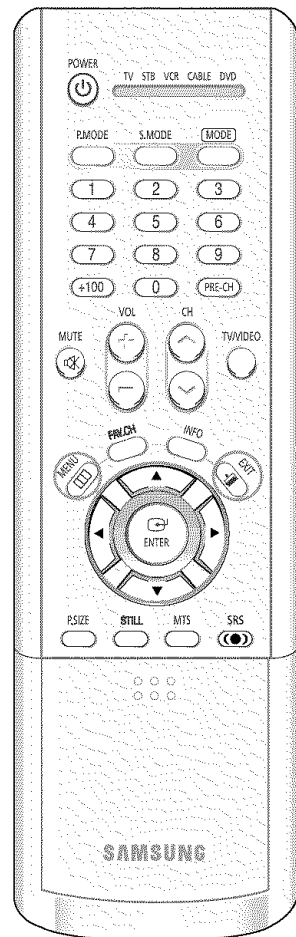

- 1** Press the MENU button. Press the ▲ or ▼ button to select "Setup", then press the ENTER button.
- 2** Press the ▲ or ▼ button to select "V-Chip", then press the ENTER button.
- 3** Press the number buttons to enter your current 4-digit pin number. (The default pin number for a new TV set is "0000".) The "V-Chip" menu is displayed.
- 4** Press the ▲ or ▼ button to select "MPAA Rating", then press the ENTER button.
- 5** You can independently lock the movie ratings. The locked movie ratings are indicated by the symbol "L". Press the ▲/▼/ENTER button to activate the appropriate restrictions for movie rating system.

Press the EXIT button.

Important Notes About Parental Locks

Explanation of the MPAA and TV (FCC) Rating Systems:

TV (FCC) Age-Based Ratings

TV-MA

Mature audiences only. This program may contain mature themes, profane language, graphic violence and explicit sexual content.

TV-14

Parents strongly cautioned. This program may contain sophisticated themes, sexual content, strong language and more intense violence.

TV-PG

Parental guidance suggested. The program may contain infrequent coarse language, limited violence, some suggestive sexual dialogue and situations.

TV-G

General audience. It contains little or no violence, no strong language, and little or no sexual dialogue or situations.

TV-Y7

Directed to older children. Themes and elements in this program may include mild physical or comedic violence, or may frighten children under the age of seven.

TV-Y

All children. The themes and elements in this program are specifically designed for a very young audience, including children from ages two – six.

TV (FCC) Content Category

- V** Violence.
- S** Sexual content.
- L** Offensive language.
- D** Dialogue sexual innuendo.
- FV** Fantasy or cartoon violence.

MPAA Rating System (Movies)

- G** General audience. No restriction.
- PG** Children under 13 should be accompanied by an adult.
- PG-13** Parental guidance suggested. Children under 13 should be accompanied by an adult.
- R** Restricted. Viewers should be 17 or older.
- NC-17** Not classified. Viewers should be 17 or older.
- X** Adults only.
- NR** Not rated.

- TV (FCC) ratings : The particular rating that you have selected will be locked (and indicated as a red "L" on a blue background). Also, all of the age-based ratings will be locked within the particular group (i.e., "group 1" or "group 2"). Suppose that the TV-G rating and all of its contents (V, S, L, and D) are locked. In that case, more restrictive ratings (TV-PG, TV-14, and TV-MA) and all of their contents (V, S, L, and D) are automatically locked as well.
- MPAA ratings : The particular rating that you have selected will be locked. In addition, more restrictive ratings will be locked as well.
- Neither TV (FCC) ratings nor MPAA ratings apply to news programs.

Special Features

Viewing Closed Caption Information

Your TV decodes and displays the closed captions information that is broadcast along with some television shows. These captions are usually subtitles for the hearing impaired or translations into other languages. All VCRs record the closed caption signal from television programs, so pre-recorded video tapes can also deliver closed-caption information. Check for the closed caption symbol (CC) on the tape's package or your TV program-schedule.

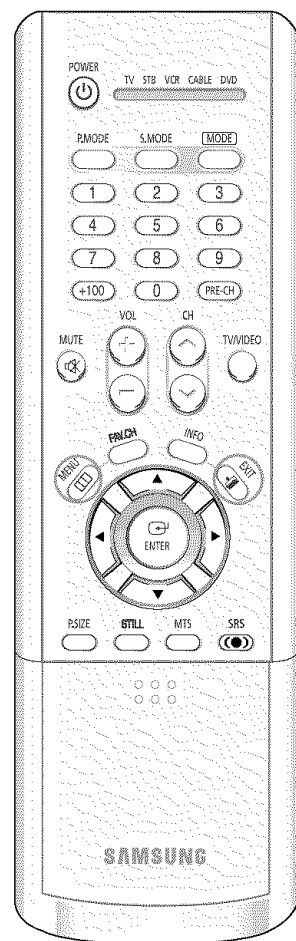

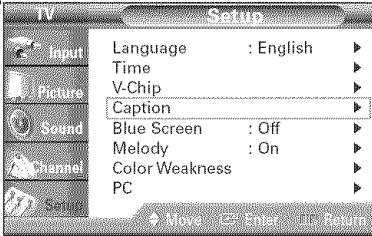
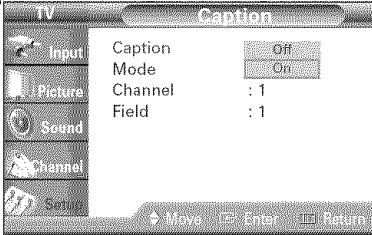
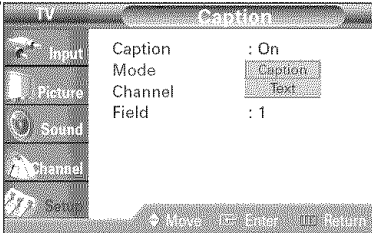
- 1 Press the MENU button. Press the ▲ or ▼ button to select "Setup", then press the ENTER button. Press the ▲ or ▼ button to select "Caption", then press the ENTER button.
 
- 2 Press the ENTER button to select "Caption". Press the ▲ or ▼ button to select "On", then press the ENTER button.
 
- 3 Press the ▲ or ▼ button to select "Mode", then press the ENTER button. Press the ▲ or ▼ button to select "Caption" or "Text", then press the ENTER button.
 

- In "Caption" mode, caption appears at the bottom of the screen, and they usually cover only a small portion of the picture.
- In "Text" mode, information unrelated to the program, such as news or weather, is displayed. Text often covers a large portion of the screen.

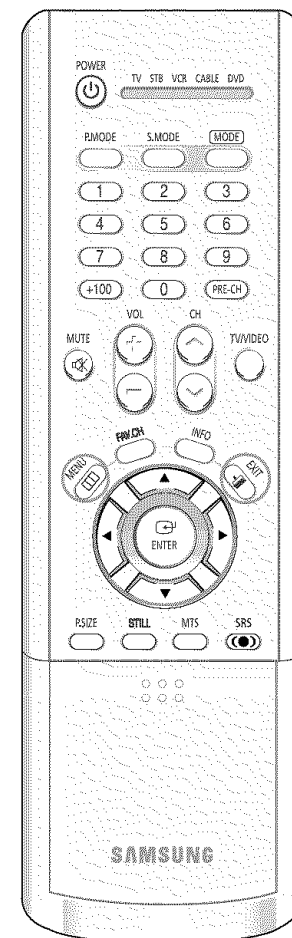

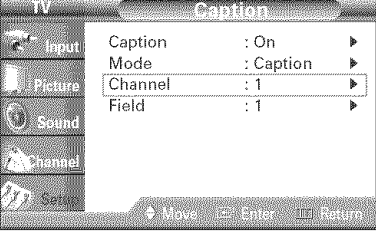
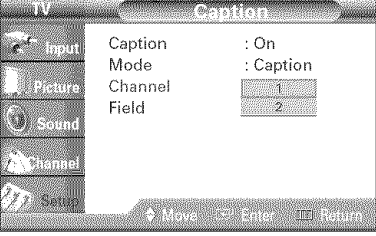
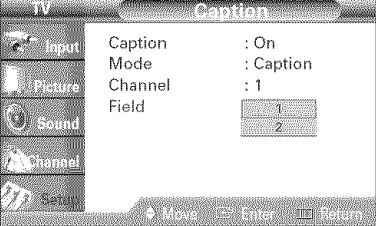
- 4 Depending on the particular broadcast, it might be necessary to make changes to "Channel" and "Field". Press the ▲ or ▼ button to select "Channel", then press the ENTER button.
 
- 5 Press the ▲ or ▼ button to select "1" or "2", then press the ENTER button.
 
- 6 Press the ▲ or ▼ button to select "Field", then press the ENTER button. Press the ▲ or ▼ button to select "1" or "2", then press the ENTER button.
 

- Different channels and fields display different information: "Field 2" carries additional information that supplements the information in "Field 1". (For example, "Channel 1" may have subtitles in English, while "Channel 2" has subtitles in Spanish.)

NOTES

- The Caption function doesn't operate when the PIP is active.
- Misspellings and unusual characters sometimes occur during closed caption transmissions, especially those of live events. There may be a small delay before captions appear when you change channels. These are not malfunctions of the TV.

Special Features

Setting the Blue Screen Mode

If no signal is being received or the signal is very weak, a blue screen automatically replaces the noisy picture background. If you wish to continue viewing the poor picture, you must set the "Blue Screen" mode to "Off".

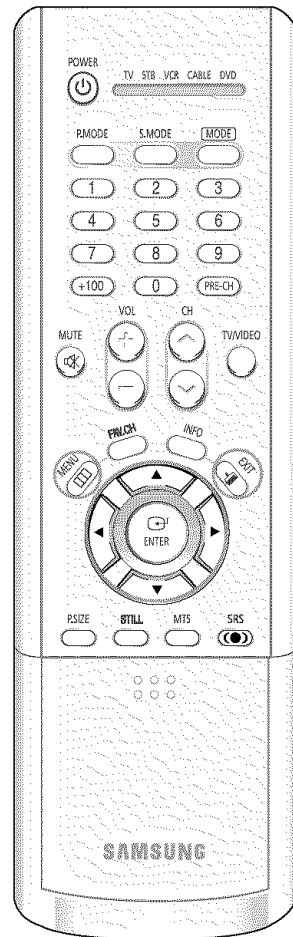

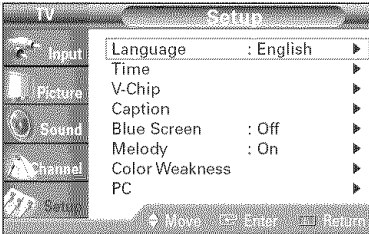
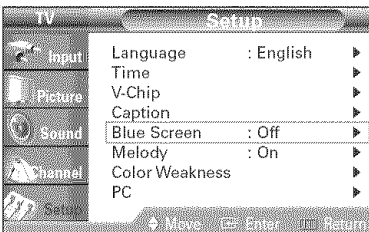
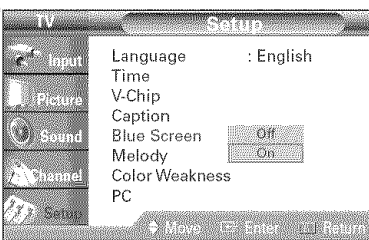
- 1 Press the MENU button. Press the ▲ or ▼ button to select "Setup", then press the ENTER button.
 
- 2 Press the ▲ or ▼ button to select "Blue Screen", then press the ENTER button.
 
- 3 Press the ▲ or ▼ button to select "On" or "Off", then press the ENTER button. Press the EXIT button to exit.
 

Setting The On/Off Melody

A melody sound can be set to come on when the TV is powered On or Off.

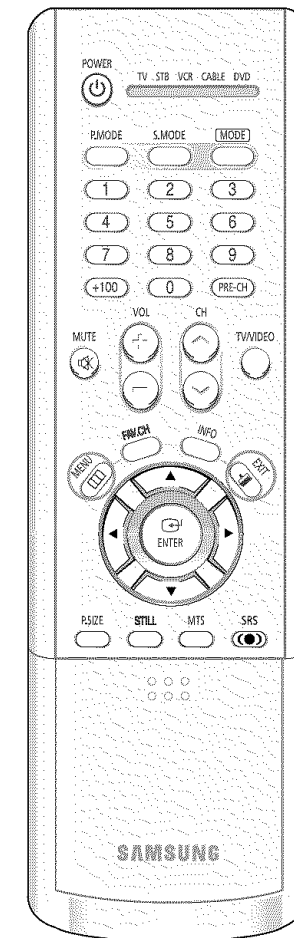

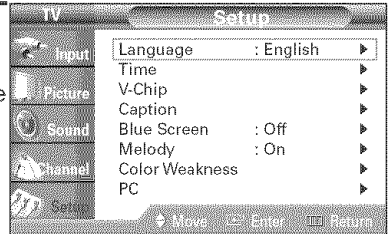
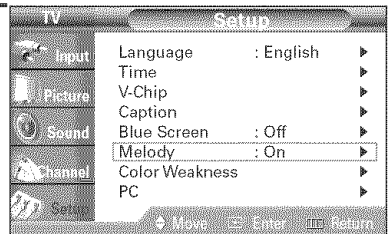
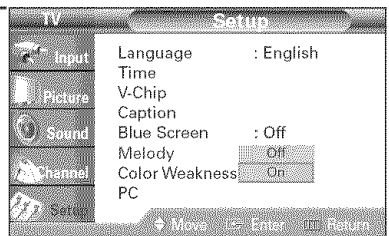
- 1 Press the MENU button. Press the ▲ or ▼ button to select "Setup", then press the ENTER button.
 
- 2 Press the ▲ or ▼ button to select "Melody", then press the ENTER button.
 
- 3 Press the ▲ or ▼ button to select "On", then press the ENTER button. Press the EXIT button to exit the menu.
 

Special Features

Using the Color Weakness Enhancement Feature

This feature adjusts the Red, Blue or Green color to enhance the picture according to the user's particular color weakness.

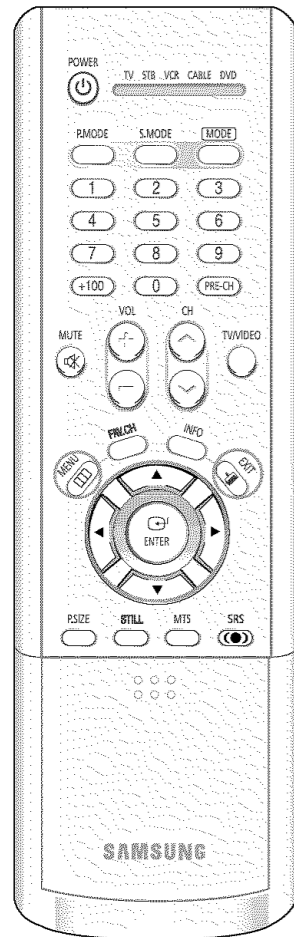

- 1 Press the MENU button.
Press the ▲ or ▼ button to select "Setup", then press the ENTER button.

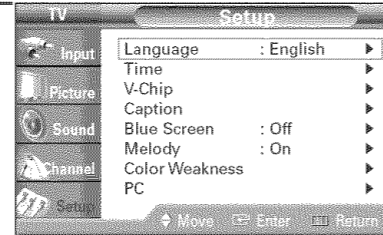

- 2 Press the ▲ or ▼ button to select "Color Weakness", then press the ENTER button.

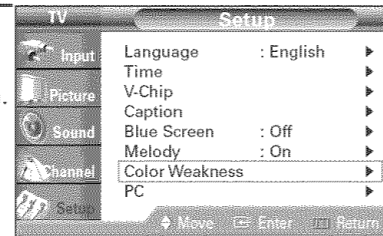

- 3 Press the ENTER button to select "Color Weakness".
Press the ▲ or ▼ button to select "On", then press the ENTER button.

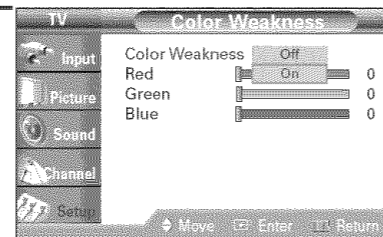

- 4 Press the ▲ or ▼ button to select a color to be adjusted, then press the ENTER button.

Press the ◀ or ▶ button to adjust the value of a color selected.

Press the EXIT button to exit.

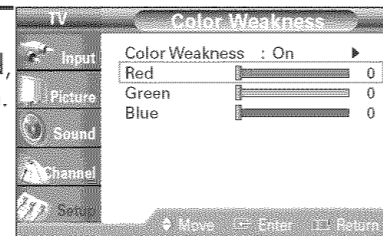

PC Display

PC Display

Using Your TV as a Computer (PC) Display

How to Connect Your PC to the TV

This figure shows the Standard Connector-jack panel. The actual configuration on your TV may be different, depending on the model.

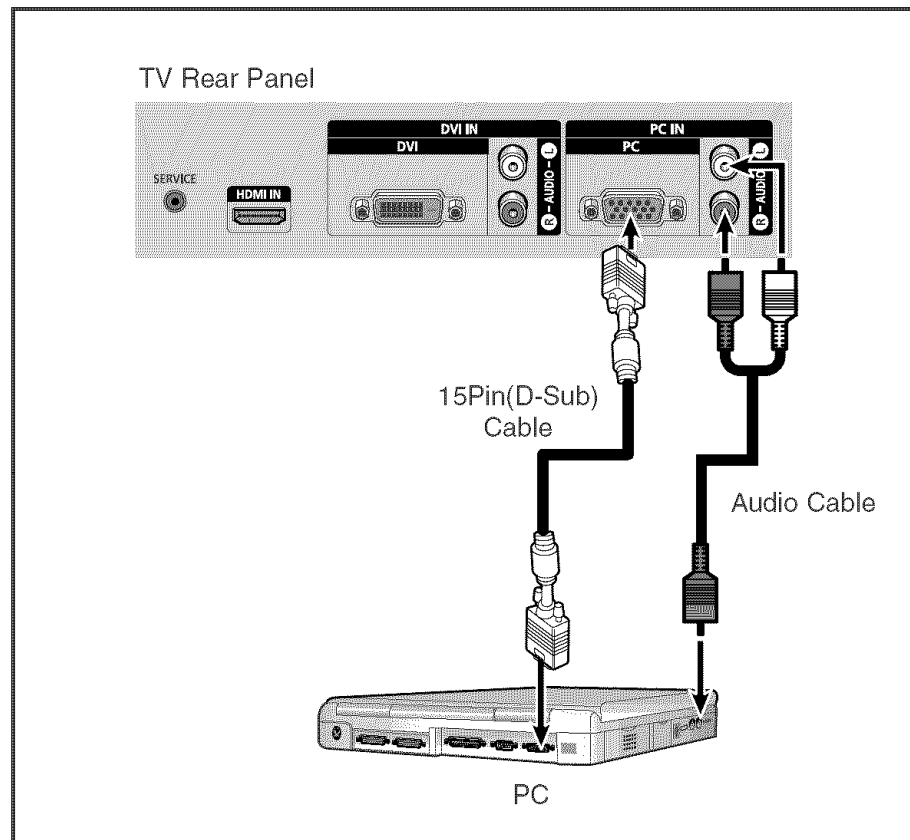

NOTE

- The "SERVICE" jack is for repairs and software upgrades.

Setting up Your PC Software (Based on Windows 98)

The Windows display-settings for a typical computer are shown below. The actual screens on your PC will probably be different, depending upon your particular version of Windows and your particular video card. However, even if your actual screens look different, the same basic setup information will apply in almost all cases. (If not, contact your computer manufacturer or Samsung Dealer.)

First, click on "Settings" on the Windows start menu.

While "Settings" is highlighted, move the cursor so that "control panel" is highlighted.



When the control panel screen appears, click on "Display" and a display dialog-box will appear.

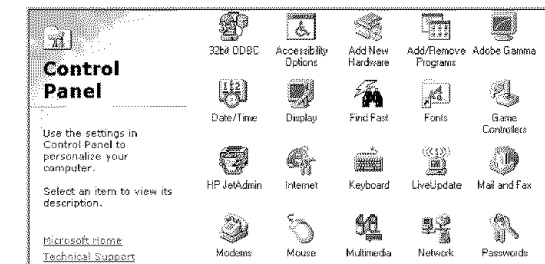

Navigate to the "Settings" tab on the display dialog box.

The two key variables that apply to the TV-PC interface are "resolution" and "colors". The correct settings for these two variables are:

- * Screen area (sometimes called "resolution"): 1024 x 768 pixels
- * Colors: "24-bit" color (might also be expressed as "16 million colors").

If a vertical-frequency option exists on your display settings dialog box, the correct value is "60" or "60 Hz". Otherwise, just click "OK" and exit the dialog box.

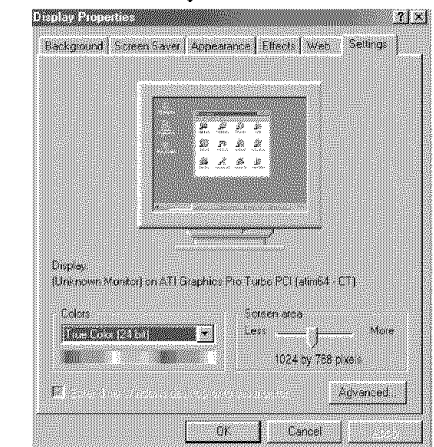

continued...

PC Display

Display Modes

Mode	Resolution	Horizontal Frequency [KHz]	Vertical Frequency [Hz]	Pixel Clock [MHz]	Sync Polarity (H/V)
VGA	640 x 350	31.47	70.00	25.175	+/-
		31.47	70.00	28.322	-/-
	720 x 400	37.93	85.00	35.5	-/+
		31.47	60.00	25.175	-/+
		35.00	66.70	30.24	-/-
		37.86	72.80	31.50	-/-
		37.50	75.00	31.50	-/-
43.27	85.00	36.00	-/-		
SVGA	800 x 600	35.16	56.30	36.00	+/-
		37.88	60.30	40.00	+/-
		48.08	72.20	50.00	+/+
		46.87	75.00	49.50	+/+
		53.67	85.10	56.25	+/+
XGA	1024 x 768	49.73	74.60	57.284	-/+
		48.36	60.00	65.00	-/-
		56.40	70.10	75.00	-/-
DTV	1920 x 1080i	60.02	75.00	78.75	+/-
		33.75	60	74.25	X
		45.00	60	74.25	X
	720 x 483p	31.47	60	27	X

NOTE

- Both screen position and size will vary, depending on the type of PC monitor and its resolution. The table above shows all of the display modes that are supported:
 - * The interlace mode is not supported.
 - * The TV will operate abnormally if a non-standard video format is selected.

NOTES

- When this TV is used as a PC display, 32-bit color is supported (over 16 million colors).
- Your PC display screen might appear different, depending on the manufacturer (and depending on your particular version of Windows). Check your PC instruction book for information about connecting your PC to a TV display-monitor.
- Same modes as PC are supported for the signal input to the DVI jack. Only a separate sync signal is supported.

Adjusting the Picture Quality

The purpose of picture quality adjustment is to remove or reduce picture noise. If the noise is not removed by fine tuning alone, then do the frequency adjustments to the utmost and fine tune again. After the noise has been reduced, re-adjust the picture so that it is aligned on the center of screen.

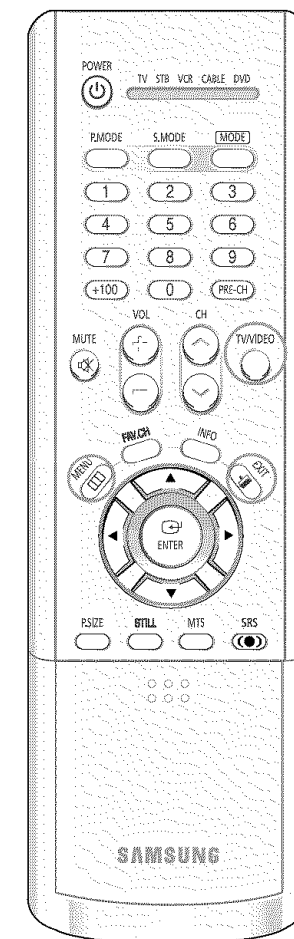

1 Press the TV/VIDEO button to select "PC".

2 Press the MENU button. Press the ▲ or ▼ button to select "Setup", then press the ENTER button.

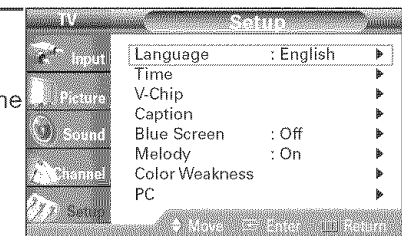

3 Press the ▲ or ▼ button to select "PC", then press the ENTER button.

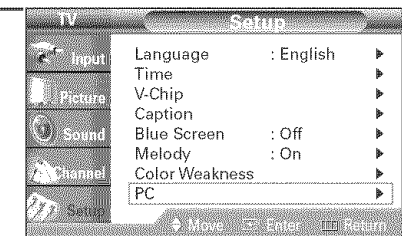

4 Press the ▲ or ▼ button to select "Coarse" or "Fine", then press the ENTER button.

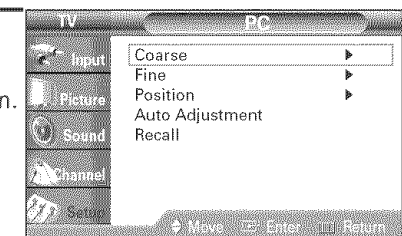

5 Pressing the ◀ or ▶ button to remove the picture noise.

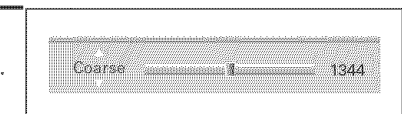

Press the EXIT button to exit.

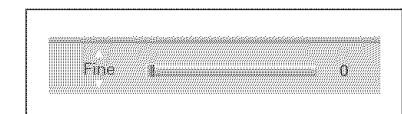

NOTE

- This feature may change the width of the image. If necessary, adjust the position to center.

PC Display

Changing the Picture Position

After connecting the TV to your PC, adjust the position of picture if it is not well-aligned.

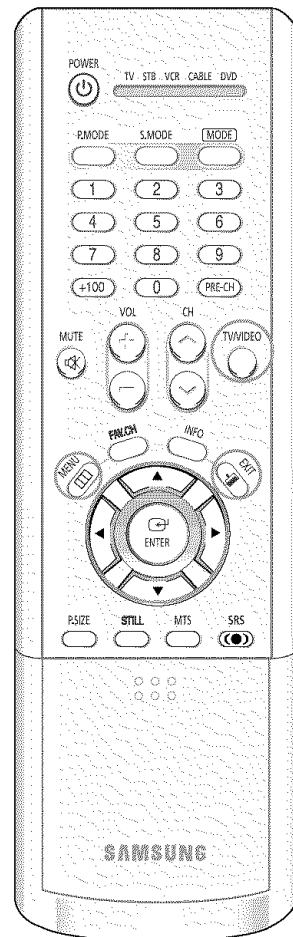

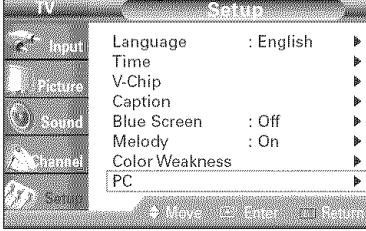
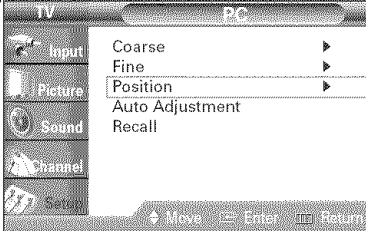
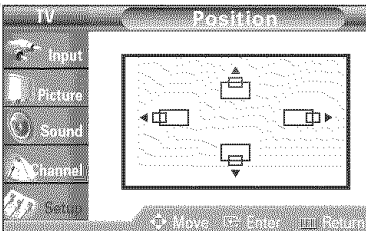
- 1 Press the TV/VIDEO button to select "PC".
- 2 Press the MENU button. Press the ▲ or ▼ button to select "Setup", then press the ENTER button.
 
- 3 Press the ▲ or ▼ button to select "PC", then press the ENTER button.
 
- 4 Press the ▲ or ▼ button to select "Position", then press the ENTER button.
 
- 5 Adjust the position of picture by pressing the ▲/▼/◀/▶ button. Press the EXIT button to exit.
 

NOTE

- If a PC signal is input to "DVI" or "HDMI", you can't adjust the quality and position of picture.

Adjusting the Picture Quality and Position Automatically

This feature allows the TV to self-adjust to the incoming video signal. The values of fine, coarse and position are adjusted automatically.

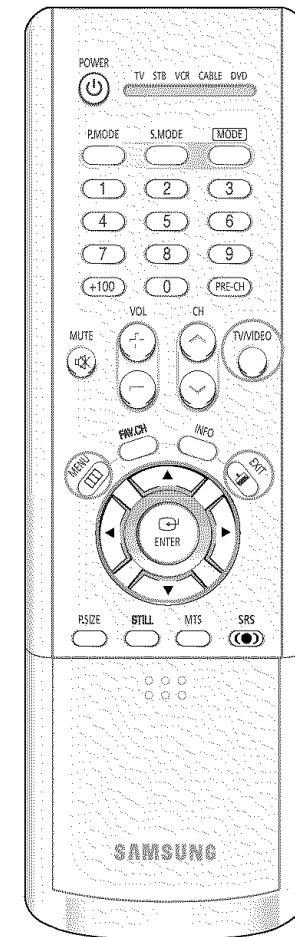

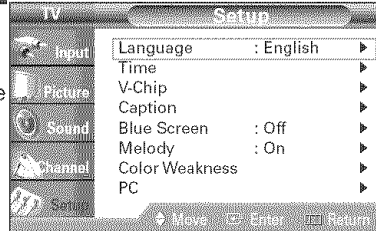
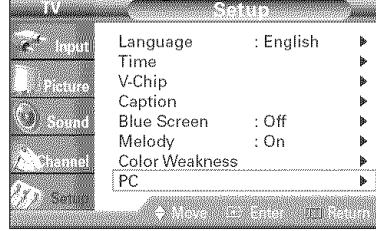
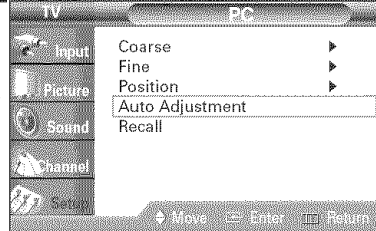
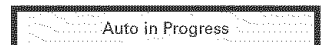
- 1 Press the TV/VIDEO button to select "PC".
 - 2 Press the MENU button. Press the ▲ or ▼ button to select "Setup", then press the ENTER button.
 
 - 3 Press the ▲ or ▼ button to select "PC", then press the ENTER button.
 
 - 4 Press the ▲ or ▼ button to select "Auto Adjustment", then press the ENTER button. The picture quality and position are automatically adjusted, and the picture returns to original view about a few seconds later.
 
- Press the EXIT button to exit.
- 

PC Display

Initializing the Picture Settings

You can replace all picture settings with the factory default values.

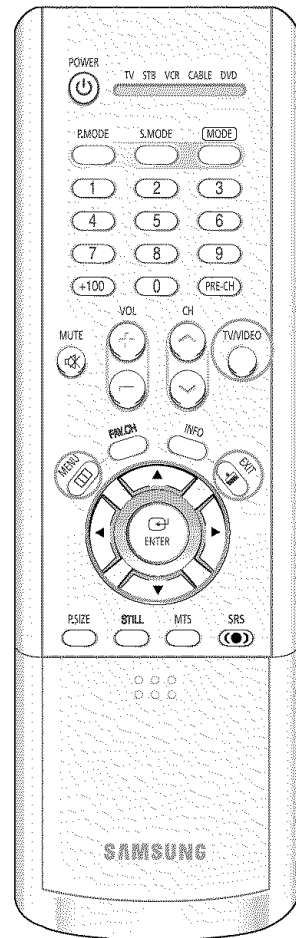

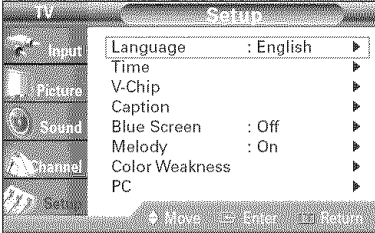
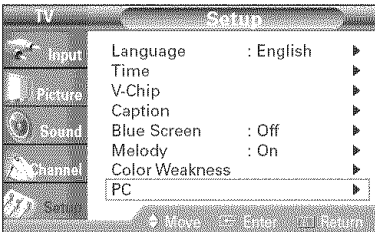
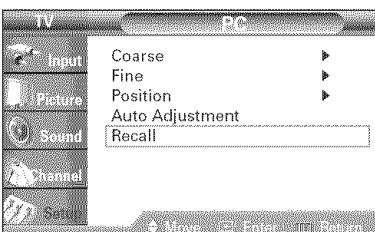
- 1 Press the TV/VIDEO button to select "PC".
- 2 Press the MENU button. Press the ▲ or ▼ button to select "Setup", then press the ENTER button.
 
- 3 Press the ▲ or ▼ button to select "PC", then press the ENTER button.
 
- 4 Press the ▲ or ▼ button to select "Recall", then press the ENTER button. The picture settings are replaced with the factory default values. Press the EXIT button to exit.
 

Changing the Picture Size (PC Mode)

You can select the picture size which best corresponds to your viewing requirements.

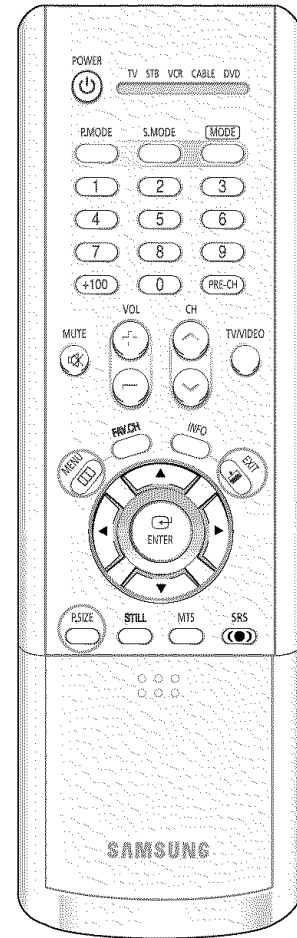

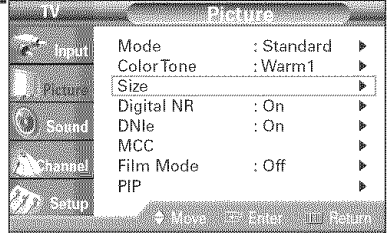
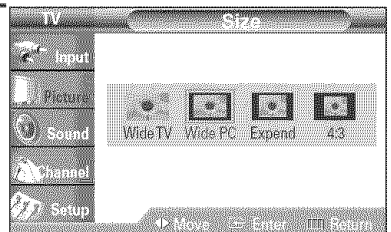
- 1 Press the TV/VIDEO button to select "PC".
- 2 Press the MENU button. Press the ▲ or ▼ button to select "Picture", then press the ENTER button. Press the ▲ or ▼ button to select "Size", then press the ENTER button.
 
- 3 Press the ◀ or ▶ button to select the screen format you want, then press the ENTER button. Press the EXIT button to exit.
 

Alternate method

Press the P.SIZE button on the remote control repeatedly to select one of the picture size settings.

- "Wide TV": Scales the picture to the size of the TV screen regardless of the aspect ratio of the input source.
- "Wide PC": Scales the picture to 92% of the screen regardless of the aspect ratio of the input source.
- "Expand": Scales the picture to the aspect ratio of the input source.
- "4:3": Displays the picture as it is without changing the aspect ratio of input source.

Source (PC/DVI)	Picture Size
1920 x 1080i	Wide TV → 4:3
1280 x 720	Wide TV → Wide PC → Expand → 4:3
1024 x 768	Wide TV → Wide PC → Expand
720 x 483 (480p)	Wide TV → 4:3
Others	Wide TV → Wide PC → Expand → 4:3

NOTES

- The "Wide PC" and "Expand" modes are recommended for the PC mode.
- In VGA (640x480) and SVGA (800x600) modes, the "Wide" and "4:3" modes are available.
- In XGA (1024x768) mode, the "Wide" mode is available.



Appendix

Troubleshooting

If the TV seems to have a problem, first try this list of possible problems and solutions. If none of these troubleshooting tips apply, then call your nearest service center.

Problem	Possible Solution
Poor picture quality.	Try another channel. Adjust the antenna. Check all wire connections.
Poor sound quality.	Try another channel. Adjust the antenna. Make sure the MUTE button is off.
No picture or sound.	Try another channel. Press the TV/VIDEO button. Make sure the TV is plugged in. Check the antenna connections.
No color, wrong colors or tints.	Make sure the program is broadcasted in color. Adjust the picture settings.
Picture rolls vertically.	Adjust the antenna. Check all wire connections. If you are using a VCR, check the tracking.
The TV operates erratically.	Unplug the TV for 30 seconds, then try operating it again.
Your remote control does not operate your TV.	Press the MODE button to put your remote control into TV mode. Make sure the remote has batteries.
The TV won't switch on.	Make sure the wall outlet is working. Make sure the remote has batteries.

- The display panel used for the DLP Projection TV is composed of many tiny pixels. These, pixels may occasionally appear on the screen.

Cleaning and Maintaining Your TV

With proper care, your TV will give you many years of service. Please follow these guidelines to get the maximum performance from your TV.

Placement

- Do not put the TV near extremely hot, cold, humid or dusty places.
- Do not place the TV near appliances with electric motors that create magnetic fields, such as vacuum cleaners.
- Keep the ventilation openings clear; do not place the TV on a soft surface, such as cloth or paper.
- Place the TV in a vertical position only.

Liquids

- Do not handle liquids near or on the TV. Liquids that spill into it can cause serious damage.

Cabinet

- Never open the cabinet or touch the parts inside.
- Wipe your TV with a clean, dry cloth. Never use water, cleaning fluids, wax, or chemicals.
- Do not put heavy objects on top of the cabinet.
- This DLP Projection TV projects the image onto a large screen by applying an optical system. If you place the TV set face down, it might cause a problem because dirt, or some other contaminant may become attached to the inside of the TV set.

Temperature

- If your TV is suddenly moved from a cold to a warm place, unplug the power cord, and allow at least two hours for moisture that may have formed inside the unit to dry completely.

Using Your TV in Another Country

If you plan to take your TV with you to a foreign country, please be aware of the different television systems that are in use around the world. A TV designed for one system may not work properly with another system due to differences in the TV channel frequencies.

Specifications

Model	HLP4663W	HLP5063W	HLP5663W	HLP6163W
Voltage	AC 120V	AC 120V	AC 120V	AC 120V
Frequency of Operation	60Hz	60Hz	60Hz	60Hz
Power Consumption	200 watts	200 watts	200 watts	200 watts
Dimension (W x D x H)	1094 x 339 x 814 mm 43.07 x 13.35 x 32.05 inches	1182 x 359 x 870 mm 46.54 x 14.13 x 34.25 inches	1330 x 396 x 962.5 mm 52.36 x 15.59 x 37.89 inches	1446 x 424 x 1034.5 mm 56.93 x 16.69 x 40.73 inches
Weight	31.5 Kg / 69.44 lbs	35 Kg / 77.16 lbs	41.5 Kg / 91.49 lbs	45 Kg / 99.21 lbs

1-800-SAMSUNG (1-800-726-7864)

**Samsung Electronics America
Service Division**

400 Valley Road, Suite 201
Mount Arlington, NJ 07856
www.samsungusa.com

**Samsung Electronics Canada Inc.
Samsung Customer Care**