

LCD Color TV

Operating Instructions

Before operating the unit, please read this manual thoroughly and retain it for future reference.

Owner's Record

The model and serial numbers are located at the rear of the TV and on the carton (white label). Record these numbers in the spaces provided below. Refer to them whenever you call upon your Sony dealer regarding this product.

Model No. _____

Serial No. _____

LCD
WEGA



KLV-21SG2

WARNING

To reduce the risk of fire or shock hazard, do not expose the TV to rain or moisture.

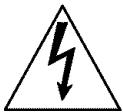
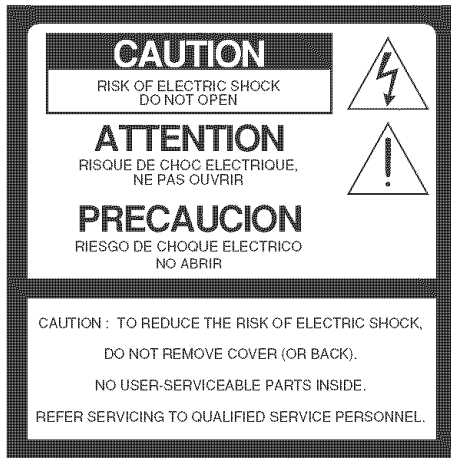

This symbol is intended to alert the user to the presence of uninsulated “dangerous voltage” within the product’s enclosure that may be of sufficient magnitude to constitute a risk of electric shock to persons.



This symbol is intended to alert the user to the presence of important operating and maintenance (servicing) instructions in the literature accompanying the appliance.

CAUTION

TO PREVENT ELECTRIC SHOCK, MATCH WIDE BLADE OF PLUG TO WIDE SLOT, FULLY INSERT.

CAUTION

The following SONY appliance is only for use with the following WALL-MOUNT BRACKET. Use with other WALL-MOUNT BRACKET is capable of resulting in instability causing possible injury.

SONY APPLIANCE MODEL NO.
KLV-21SG2

WALL-MOUNT BRACKET MODEL NO.
SU-W210

SONY Corp.

Note on Caption Vision

This television receiver provides display of television closed captioning in accordance with §15.119 of the FCC rules.

Note to CATV system installer

This note is provided to call the CATV system installer’s attention to Article 820-40 of the NEC that provides guidelines for proper grounding and, in particular, specifies that the cable ground shall be connected to the grounding system of the building, as close to the point of cable entry as practical.

Use of this television receiver for other than private viewing of programs broadcast on UHF, VHF, transmitted by cable companies or satellite for the use of the general public may require authorization from the broadcaster/cable company and/or program owner.

NOTIFICATION

This equipment has been tested and found to comply with the limits for a Class B digital device pursuant to Part 15 of the FCC Rules. These limits are designed to provide reasonable protection against harmful interference in a residential installation. This equipment generates, uses, and can radiate radio frequency energy and, if not installed and used in accordance with the instructions, may cause harmful interference with radio communications. However, there is no guarantee that interference will not occur in a particular installation. If this equipment does cause harmful interference to radio or television reception, which can be determined by turning the equipment off and on, the user is encouraged to try to correct the interference by one or more of the following measures:

- Reorient or relocate the receiving antennas.
 - Increase the separation between the equipment and receiver.
 - Connect the equipment into an outlet on a circuit different from that to which the receiver is connected.
 - Consult the dealer or an experienced radio/TV technician for help.
- You are cautioned that any changes or modifications not expressly approved in this manual could void your warranty and your authority to operate this equipment.

Safety

- Operate the TV only on 120 V AC.
- The plug is designed, for safety purposes, to fit into the wall outlet only one way. If you are unable to insert the plug fully into the outlet, contact your dealer.
- If any liquid or solid object should fall inside the cabinet, unplug the TV immediately and have it checked by qualified service personnel before operating it further.
- If you will not be using the TV for several days, disconnect the power by pulling the plug itself. Never pull on the cord.

Installing

- To prevent internal heat buildup, do not block the ventilation openings.
- Do not install the TV in a hot or humid place, or in a place subject to excessive dust or mechanical vibration.

- “Memory Stick” and  are trademarks of Sony Corporation.
- “Memory Stick PRO” and **MEMORY STICK PRO** are trademarks of Sony Corporation.
- “Memory Stick Duo” and **MEMORY STICK DUO** are trademarks of Sony Corporation.
- Wega, Caption Vision, CineMotion are registered trademarks of Sony Corporation.

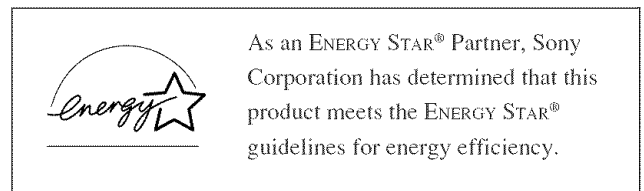

- ENERGY STAR® is a U.S. registered mark.
- WOW, SRS and  symbol are trademarks of SRS Labs, Inc.
- WOW technology is incorporated under license from SRS Labs, Inc.

Important Safety Instructions

- 1 Read these instructions.
- 2 Keep these instructions.
- 3 Heed all warnings.
- 4 Follow all instructions.
- 5 Do not use this apparatus near water.
- 6 Clean only with dry cloth.
- 7 Do not block any ventilation openings. Install in accordance with the manufacturer's instructions.
- 8 Do not install near any heat sources such as radiators, heat registers, stoves, or other apparatus (including amplifiers) that produce heat.
- 9 Do not defeat the safety purpose of the polarized or grounding-type plug. A polarized plug has two blades with one wider than the other. A grounding-type plug has two blades and a third grounding prong. The wide blade or the third prong are provided for your safety. If the provided plug does not fit into your outlet, consult an electrician for replacement of the obsolete outlet.
- 10 Protect the power cord from being walked on or pinched particularly at plugs, convenience receptacles, and the point where they exit from the apparatus.
- 11 Only use attachments/accessories specified by the manufacturer.
- 12 Use only with the cart, stand, tripod, bracket, or table specified by the manufacturer, or sold with the apparatus. When a cart is used, use caution when moving the cart/apparatus combination to avoid injury from tip-over.
- 13 Unplug this apparatus during lightning storms or when unused for long periods of time.
- 14 Refer all servicing to qualified service personnel. Servicing is required when the apparatus has been damaged in any way, such as power-supply cord or plug is damaged, liquid has been spilled or objects have fallen into the apparatus, the apparatus has been exposed to rain or moisture, does not operate normally, or has been dropped.



Handling the LCD screen

- Do not leave the LCD screen facing the sun as it can damage the LCD screen. Take care when you place the TV by a window.
- Do not push on or scratch the LCD screen. Do not place a heavy object on the LCD screen. This may cause the screen to lose uniformity or cause LCD panel malfunctions.
- If the TV is used in a cold place, a smear may appear on the screen. This is not a malfunction. The screen returns to normal as the temperature rises to a normal operating level.
- If a still picture is displayed for a long time, a ghosting may occur for a while. The ghosting will eventually disappear.
- The LCD panel becomes warm during operation. This is not a malfunction.

Note on the LCD (Liquid Crystal Display)

Please note that the LCD screen is made with high-precision technology. However, black points or bright points of light (red, blue, or green) may appear constantly on the LCD screen, and irregular colored stripes or brightness may appear on the LCD screen. This is not a malfunction. (Effective dots: more than 99.99%)

Handling of Broken Glass and Liquid Crystal Leakage

If the LCD panel gets damaged, crystalline liquid leakage may occur, or scattered broken glass may result. Do not touch broken glass or crystalline liquid (which is toxic), with bare hands as cuts or poisoning/skin irritation may occur. Also, do not let glass fragments or leaked crystalline liquid get into your eyes or mouth. Should either contact your eyes or mouth, rinse the contacted area thoroughly with water and consult your doctor.

Fluorescent Lamp

This TV uses a special fluorescent lamp as its light source. If the screen image becomes dark, flickers or does not appear, the fluorescent lamp has run down and should be replaced. For replacement, consult qualified service personnel.

Disposal of the TV

- Do not dispose of the TV with general household waste.
- The LCD contains a small amount of liquid crystal and mercury. The fluorescent lamp used in this TV also contains mercury. Follow your local ordinances and regulations for disposal.

For Customers in the United States

This product contains mercury. Disposal of this product may be regulated if sold in the United States. For disposal or recycling information, please contact your local authorities or the Electronics Industries Alliance (<http://www.eiae.org>).

Table of Contents

Installing and Connecting the TV

Unpacking	6
Inserting Batteries into the Remote Control	6
Identifying Front and Rear Connectors ...	7
Basic Connections (Connecting Cable TV or an Antenna).....	8
Connector types	8
Connecting directly to cable or an antenna	8
Cable box connections	8
Connecting the Power Cord	9
Bundling Cords and Cables	10
Attaching the Rear Cover	11
Removing the rear cover	11
Adjusting the Viewing Angle of the TV	11
Carrying the TV	11
Connecting a VCR and Cable TV	12
Connecting a Satellite Receiver	13
Connecting a Satellite Receiver with a VCR	14
Connecting an Audio Receiver	15
Connecting a DVD Player with Component Video Connectors	16
Connecting a DVD Player with A/V Connectors	17
Connecting a Digital TV Receiver	18
Connecting a Digital Satellite Receiver	19
Setting the Channels	20
Selecting the On-screen Menu Language	22

Watching the TV

Watching the TV	23
Watching with closed caption	24
Selecting the Picture Mode	24
Selecting the Effect Mode	25
Using the 16:9 Enhanced Feature	26
Using the Freeze Function	27
Setting the Video Inputs	28
Using the Video Label Feature	29
Operating Optional Equipment with Your TV Remote Control	30
Programming the remote control	30
Operating optional equipment	32
Using Favorite Channels	33
Setting your favorite channels	33
Watching favorite channels	34
Using the Channel Label Feature	34

Using Advanced Features

Using the Menu	36
Adjusting the Picture Quality	37
Adjusting the Sound Quality	39
Selecting Stereo or Bilingual Programs	40
Selecting stereo or bilingual programs using the menu	41
Using the Parental Control Feature	41
Activating the Parental Control feature	42
Selecting a Custom Rating	44
What the Ratings Mean	46
Ratings in the U.S.A.	46
Ratings in Canada	48
Turning Off the TV Automatically	50

“Memory Stick”

About the “Memory Stick”	52
Features of the Memory Stick Home	54
Inserting and Removing a “Memory Stick”	56
Inserting a “Memory Stick”	56
Removing a “Memory Stick”	56
Displaying the Memory Stick Home	57
Displaying the Memory Stick Home	57
The Memory Stick Home – A one-stop list for all of your digital photos and movies	58
Playing “Slide Show”	59
Viewing Photos	60
Viewing digital photos at full-screen size	60
Rotating and viewing your digital photos	61
Playing Movies (“Movie Player”)	62
Protecting/Deleting the Files	63
Protecting digital photos or movies ..	63
Deleting digital photos or movies	65
About the Memory Stick Home Menu	
Options	66
Selecting a folder and viewing digital photos or movies	67
Sorting image files	68
Selectively displaying digital photos or movies	69
Caution icons and messages	70

Additional Information

Troubleshooting	72
Self-diagnosis function	72
Trouble symptoms and remedies	72
Specifications	75
Index to Parts and Controls	76
TV Front panel	76
Remote control buttons	77
Index	78

Installing and Connecting the TV

Unpacking

When you unpack this unit, make sure it includes the following:

Remote control (1) and size AA batteries (2)

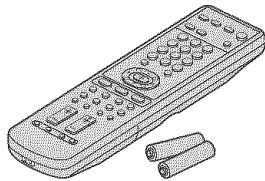

AC power cord (1)

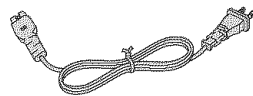

75-ohm coaxial cable (1)

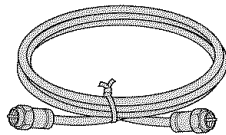

Rear cover (1)

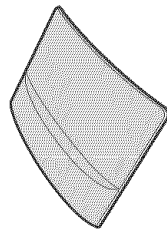

Operating Instructions
Warranty Card
Product Registration

Inserting Batteries into the Remote Control

Insert two size AA batteries (supplied) by matching the + and – on the batteries to the diagram inside the remote control's battery compartment.

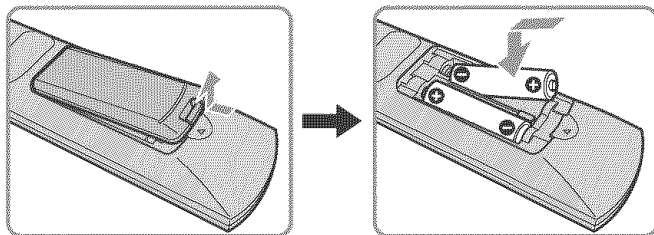

Notes

- Remove the batteries to avoid damage from possible battery leakage whenever you anticipate that the remote control will not be used for an extended period.
- Handle the remote control with care. Avoid dropping it, getting it wet, or placing it in direct sunlight, near a heater or where the humidity is high.
- The supplied remote control can be programmed to operate most video equipment (see "Operating Optional Equipment with Your TV Remote Control" on page 30).

Identifying Front and Rear Connectors

TV front panel

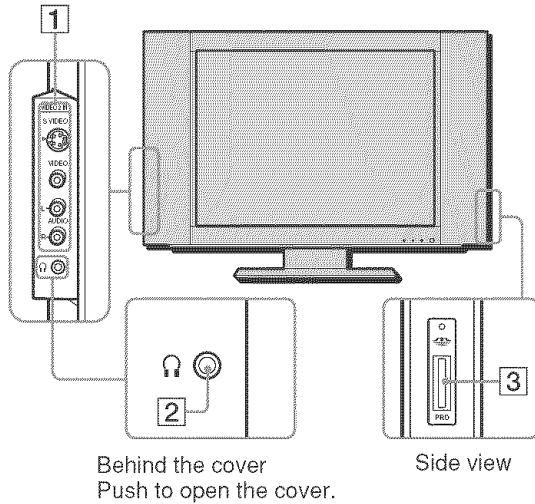

- 1 VIDEO 2 IN (pages 12 - 14, 17)**
Connects to the output jacks of your VCR or other video equipment.
- 2 Headphones jack**
Connects to your headphones.
If your headphones do not match the jack, use a suitable plug adaptor (not supplied).
- 3 Memory Stick slot (page 56)**

Rear of TV

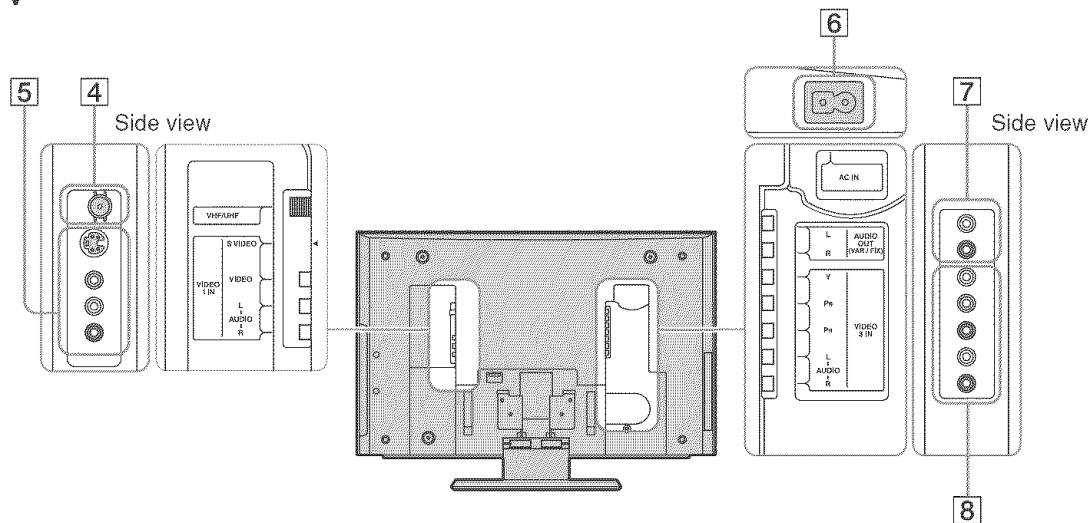

- 4 VHF/UHF (pages 8, 12 - 14)**
Connects to your VHF/UHF antenna or cable.
- 5 VIDEO 1 IN (pages 12 - 14, 17)**
Connects to the output jacks of your VCR or other video equipment.
- 6 AC IN (page 9)**
Connects the supplied AC power cord.
- 7 AUDIO OUT (page 15)**
Connects to the input jacks of your audio equipment.
Audio output through the AUDIO OUT jacks is available only when the TV's speaker is off (see page 15).
- 8 VIDEO 3 IN**
Y, P_B, P_R input jacks (pages 16, 18, 19)
Connects to the component video connectors (Y/C_B/C_R, Y/B-Y/R-Y, or Y/P_B/P_R) of your DVD player or other video equipment such as a Digital Satellite Receiver and Digital TV Receiver.
AUDIO (L/R) input jacks (pages 16, 18, 19)
Connects to the audio output jacks of your DVD player or other video equipment such as a Digital Satellite Receiver and Digital TV Receiver.

Basic Connections (Connecting Cable TV or an Antenna)

Connector types

You may find it necessary to use some of the following connector types during set up.

Supplied 75-ohm coaxial cable

Screw-on type



S VIDEO cable

High quality video cable for enhanced picture quality



AUDIO/VIDEO cable



- VIDEO - Yellow
- AUDIO (Left) - White
- AUDIO (Right) - Red

Some DVD players are equipped with the following three video connectors:

- Y - Green
- P_B (C_B, C_b or B-Y) - Blue
- P_R (C_R, C_r or R-Y) - Red

Connecting directly to cable or an antenna

VHF only or VHF/UHF or cable

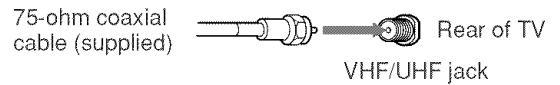

Note

It is strongly recommended to connect the antenna using a 75-ohm coaxial cable to get optimum picture quality. A 300-ohm twin lead cable can be easily affected by radio noise and the like, resulting in signal deterioration. If you use a 300-ohm twin lead cable, keep it away as far as possible from the TV.

Cable box connections

Use this hookup if:

- You subscribe to a cable TV system that uses scrambled or encoded signals requiring a cable box to view all channels, and
- You do not intend to hook up any other audio or video equipment to your TV.

- 1** Connect the coaxial connector from your cable service to the cable box's IN jack.
- 2** Using the supplied 75-ohm coaxial cable, connect the cable box's OUT jack to the TV's VHF/UHF jack.

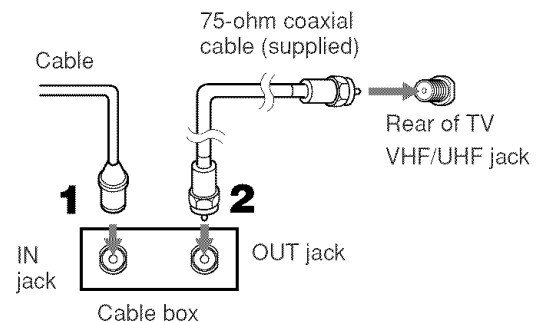

Also, set "Cable" to "On" in the  (Channel) menu (see page 20).

Tips

- The supplied remote control can be programmed to operate your cable box (see "Programming the remote control" on page 30).
- To change channels using the cable box, set your TV to channel 3 or 4 depending on the cable box channel output.
- If you will be controlling all channel selection through your cable box, consider using the Channel Fix feature to set your TV to channel 3 or 4 (see page 21).

Connecting the Power Cord

Complete other connections prior to connecting the power cord.

- 1** Connect the power cord to the AC IN connector of the TV.
- 2** Connect the other plug of the power cord to a wall outlet.

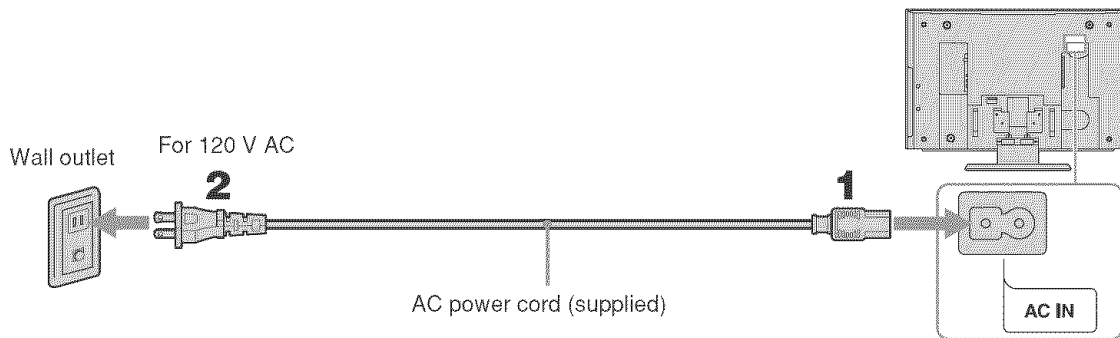

Bundling Cords and Cables

You can organize the cables in the back of the TV.

- 1 Bundle the cables and secure them with the clips on both sides of the TV.

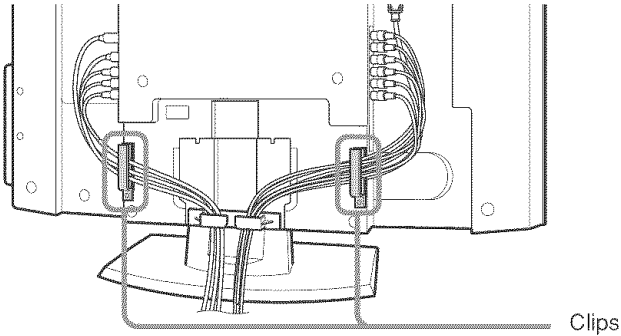

Notes

- It may not be possible to fasten with clips if cables are too thick.
- If all the cables cannot be stored inside, you may leave some of them hanging down on both sides of the TV.

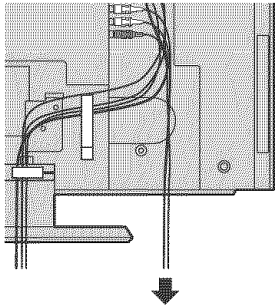

- 2 Gather the cables from both sides together and secure them with the clip at the bottom.

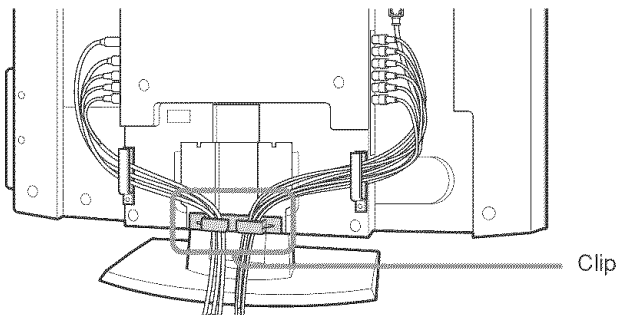

Note

It may not be possible to fasten with clips if cables are too thick.

- 3 Attach the supplied rear cover, as needed.
See "Attaching the Rear Cover" on page 11.

Note

If the cables are not neatly stored, you may not be able to attach the rear cover.

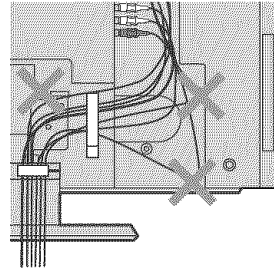

Attaching the Rear Cover

Hold the rear cover as illustrated below, fitting the four pegs on the rear cover into the corresponding holes on the TV, then push the rear cover back onto the TV.

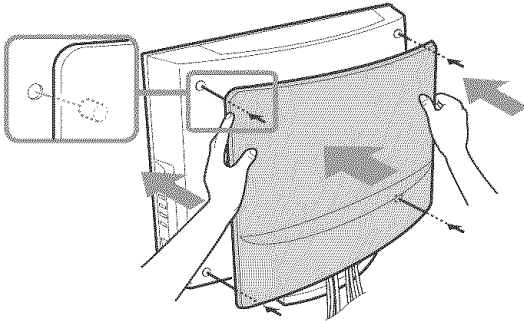

Removing the rear cover

- 1 Hold the lower right (or left) corner of the rear cover as illustrated below and pull it towards you. Do the same to the remaining left (or right) corner.

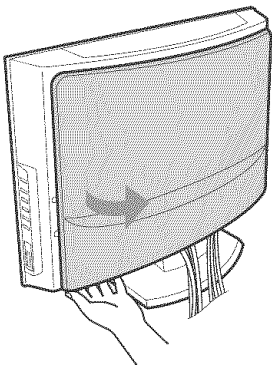

- 2 Hold the rear cover with both hands as illustrated and pull it towards you.

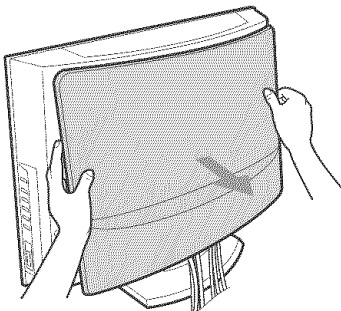

Adjusting the Viewing Angle of the TV

You can adjust the angle to avoid the reflection of light and get a better view of the TV.

Note

When adjusting the angle, steady the base of the stand with your hand to prevent the TV from becoming separated from the stand. Be careful not to get your fingers caught between the TV and the stand.

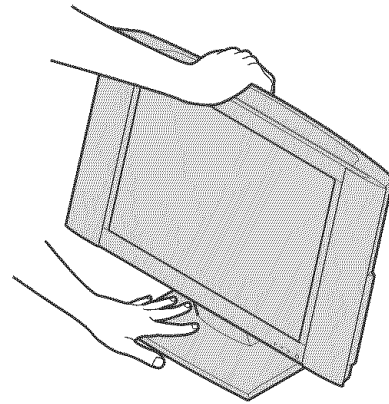

Backward direction

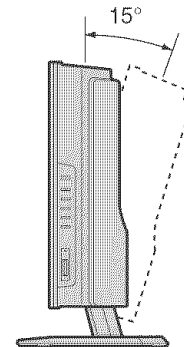

Carrying the TV

When carrying the TV, hold it as shown in the diagram below. Do not hold only by the rear cover. As the rear cover is designed to come off, doing so may cause you to drop the TV, resulting in damage to the TV or cause injury.



Connecting a VCR and Cable TV

Use this hookup if:

- You subscribe to a cable TV system that does not require a cable box.

Disconnect all power sources before making any connections.

- 1 Connect the CATV cable to the VCR's IN jack.
- 2 Using the supplied 75-ohm coaxial cable, connect the VCR's OUT jack to the TV's VHF/UHF jack.
- 3 Using AUDIO and S VIDEO cables, connect the VCR's AUDIO and S VIDEO OUT jacks to the TV's AUDIO and S VIDEO IN jacks.

Tip

- If your VCR is not equipped with S VIDEO, use a VIDEO cable (yellow) instead of the S VIDEO cable.

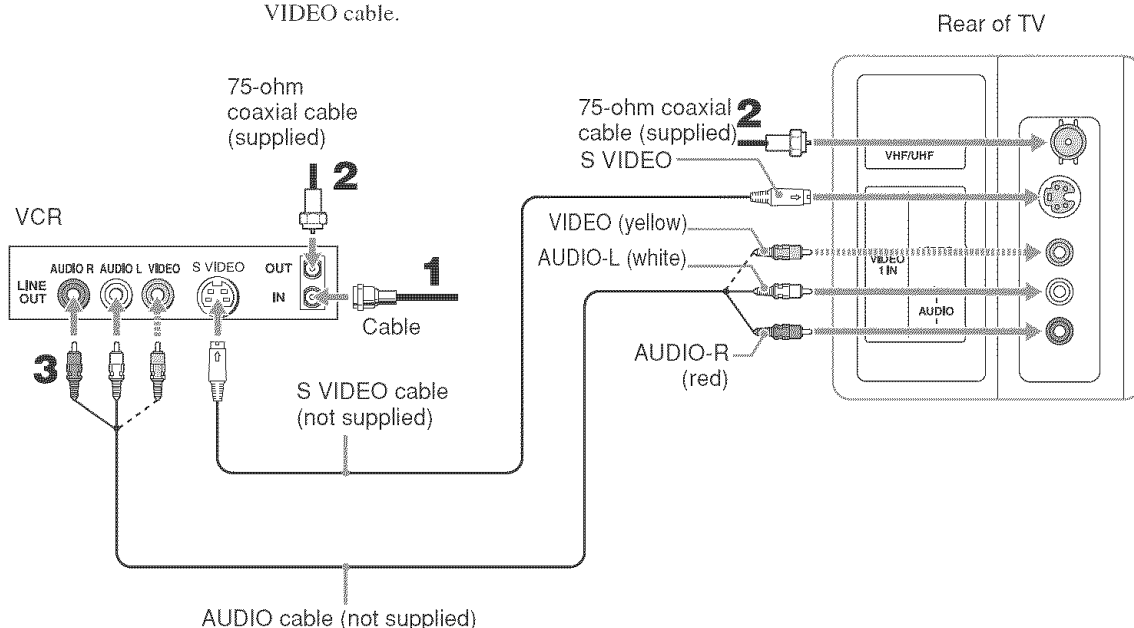

Note







When you connect video equipment to both the VIDEO and the S VIDEO input jacks, make sure "Auto YC" in the  (Setup) menu is set to "On" to view the S VIDEO input (see below).



Tip

- You can also use the VIDEO 2 IN jacks located on the left side of the TV to connect your VCR.

When connecting both VIDEO IN and S VIDEO IN

Using the menu, you can select the jack from which the TV receives the input signal. You can set it for each video input (VIDEO 1 IN and VIDEO 2 IN) separately. The TV is factory set to receive S VIDEO input signals.

- 1 Press TV/VIDEO repeatedly until the desired video input appears.
- 2 Press MENU.
- 3 Press  to select  (Setup), then press .
- 4 Press  to select "Auto YC," then press .
- 5 To watch the pictures input from the S VIDEO input jack: Press  to select "On," then press .

To watch the pictures input from the VIDEO input jack:
Press  to select "Off," then press .

- 6 Press MENU to exit the menu screen.

Connecting a Satellite Receiver

Disconnect all power sources before making any connections.

- 1** Connect the satellite antenna cable to the satellite receiver's SATELLITE IN jack.
- 2** Using AUDIO and S VIDEO cables, connect the satellite receiver's AUDIO and S VIDEO OUT jacks to the TV's AUDIO and S VIDEO IN jacks.

Tip

- If your satellite receiver is not equipped with S VIDEO, use a VIDEO cable (yellow) instead of the S VIDEO cable.

- 3** Connect the supplied 75-ohm coaxial cable from your cable or antenna to the TV's VHF/UHF jack.

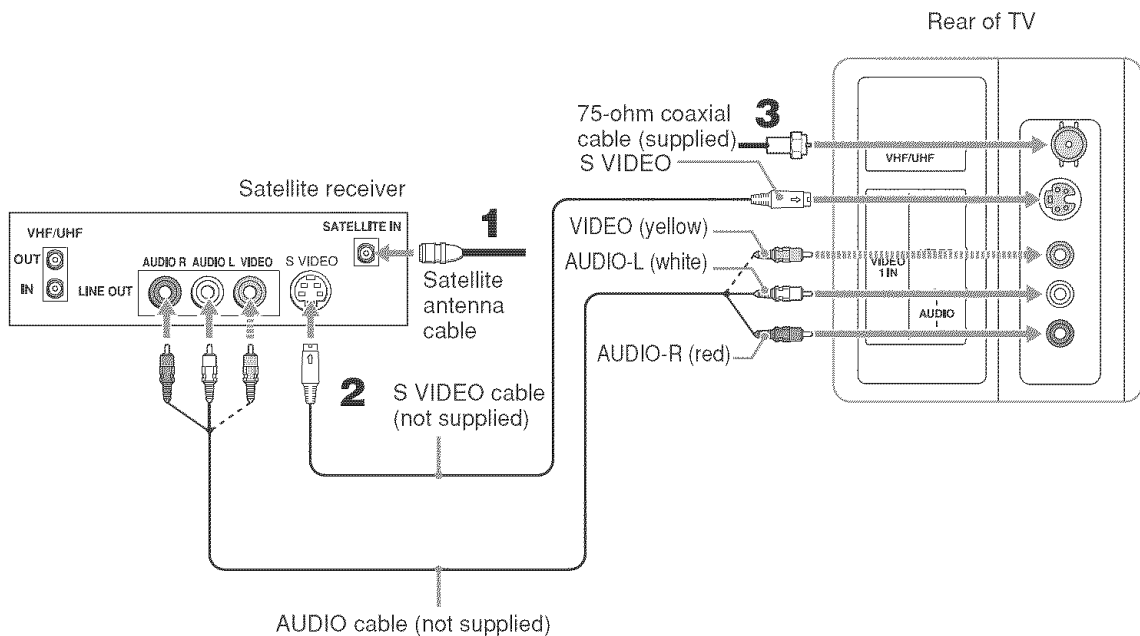

Note

When you connect video equipment to both the VIDEO and the S VIDEO input jacks, make sure "Auto YC" in the  (Setup) menu is set to "On" to view the S VIDEO input (see page 12).

Tips

- You can also use the VIDEO 2 IN jacks located on the left side of the TV to connect your satellite receiver.
- Use TV/VIDEO on the remote control to select VIDEO 1 IN (or VIDEO 2 IN if you use the VIDEO 2 IN jacks for this hookup) to watch satellite TV or to watch a tape on the VCR (your VCR must be turned on).

Connecting a Satellite Receiver with a VCR

Disconnect all power sources before making any connections.

- 1** Connect the satellite antenna cable to the satellite receiver's SATELLITE IN jack.
- 2** Connect the CATV cable to the VCR's VHF/UHF IN jack.
- 3** Using the supplied 75-ohm coaxial cable, connect the VCR's OUT jack to the TV's VHF/UHF jack.
- 4** Using AUDIO and S VIDEO cables, connect the satellite receiver's AUDIO and S VIDEO OUT jacks to the VCR's AUDIO and S VIDEO IN jacks.

Tip

- If your VCR or satellite receiver is not equipped with S VIDEO, use a VIDEO cable (yellow) instead of the S VIDEO cable.

- 5** Using AUDIO and S VIDEO cables, connect the VCR's AUDIO and S VIDEO OUT jacks to the TV's AUDIO and S VIDEO IN jacks.

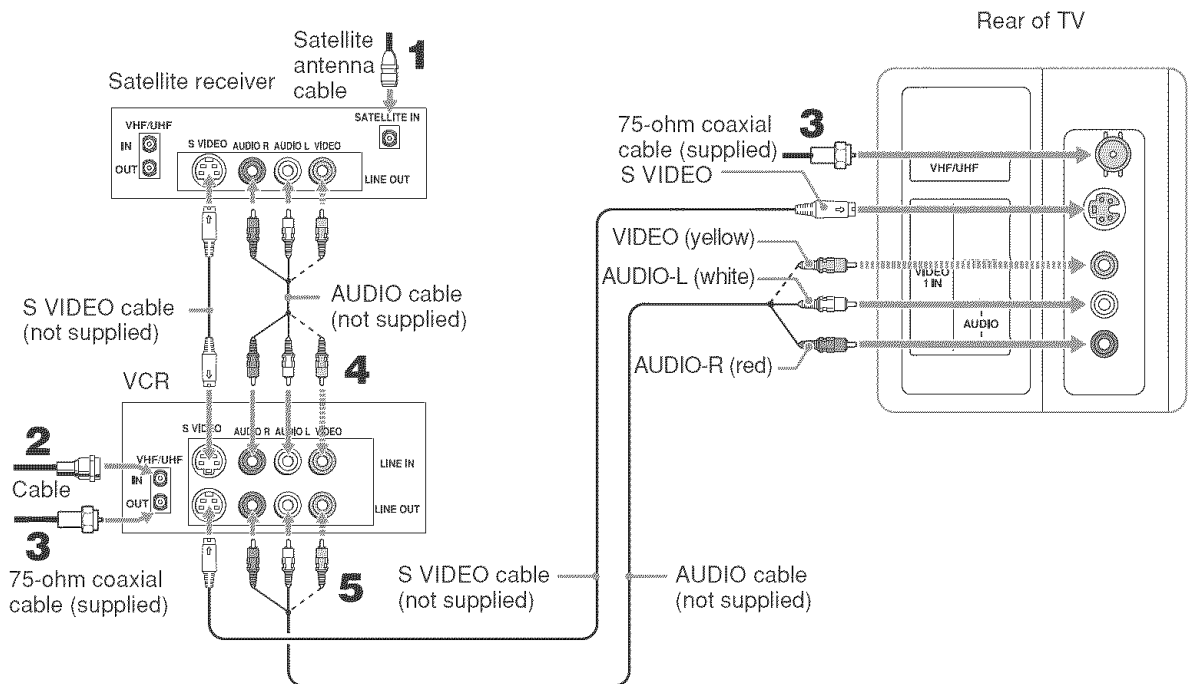

Note

When you connect video equipment to both the VIDEO and the S VIDEO input jacks, make sure "Auto YC" in the  (Setup) menu is set to "On" to view the S VIDEO input (see page 12).

Tips

- You can also use the VIDEO 2 IN jacks located on the left side of the TV to connect your VCR.
- Be sure your VCR's video input is set correctly. Consult your VCR's operating manual for instructions.
- Use TV/VIDEO on the remote control to select VIDEO 1 IN (or VIDEO 2 IN if you use the VIDEO 2 IN jacks for this hookup) to watch satellite TV or to watch a tape on the VCR (your VCR must be turned on).

Connecting an Audio Receiver

Disconnect all power sources before making any connections.

Using an AUDIO cable, connect the TV's AUDIO OUT jacks to the audio receiver's AUDIO IN jacks.

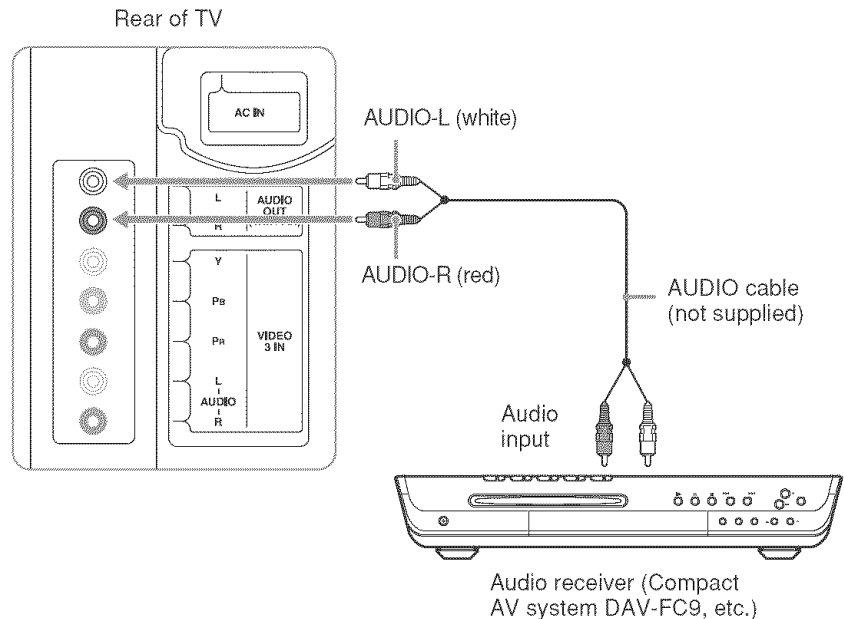

When using your audio system speakers

Set "Speaker" in the  (Audio) menu to "Off." The TV's sound is not output from the AUDIO OUT jacks when "Speaker" is set to "On."

You can still control the volume output from your audio system using the TV's remote control (see "Programming the remote control" on page 30), by setting "Audio Out" in the  (Audio) menu to "Variable."

If you want to adjust the volume through your audio system, set "Audio Out" to "Fixed."

Notes

- The video signal is not output through the AUDIO OUT jacks.
- When "Audio Out" in the  (Audio) menu is set to "Variable," "Speaker" is to "Off," check if the speaker volume is moderate before switching "Speaker" from "Off" to "On." Otherwise, the speaker volume may be too loud.

Connecting a DVD Player with Component Video Connectors

This is the preferred hookup to use if:

- Your DVD player has component (Y, P_B, P_R) jacks.

Disconnect all power sources before making any connections.

- 1** Using a component video cable, connect the DVD player's Y, P_B and P_R jacks to the Y, P_B and P_R jacks on the TV. Use the VIDEO 3 IN connections.

Tip

The Y, P_B and P_R jacks on your DVD player are sometimes labeled as Y, C_B and C_R, or Y, B-Y and R-Y. If so, connect the cables to the matching colors.

- 2** Using an AUDIO cable, connect the DVD player's AUDIO OUT jacks to the TV's AUDIO IN jacks.

Note

The Y, P_B and P_R jacks do not provide audio, so audio cables must be connected to provide sound.

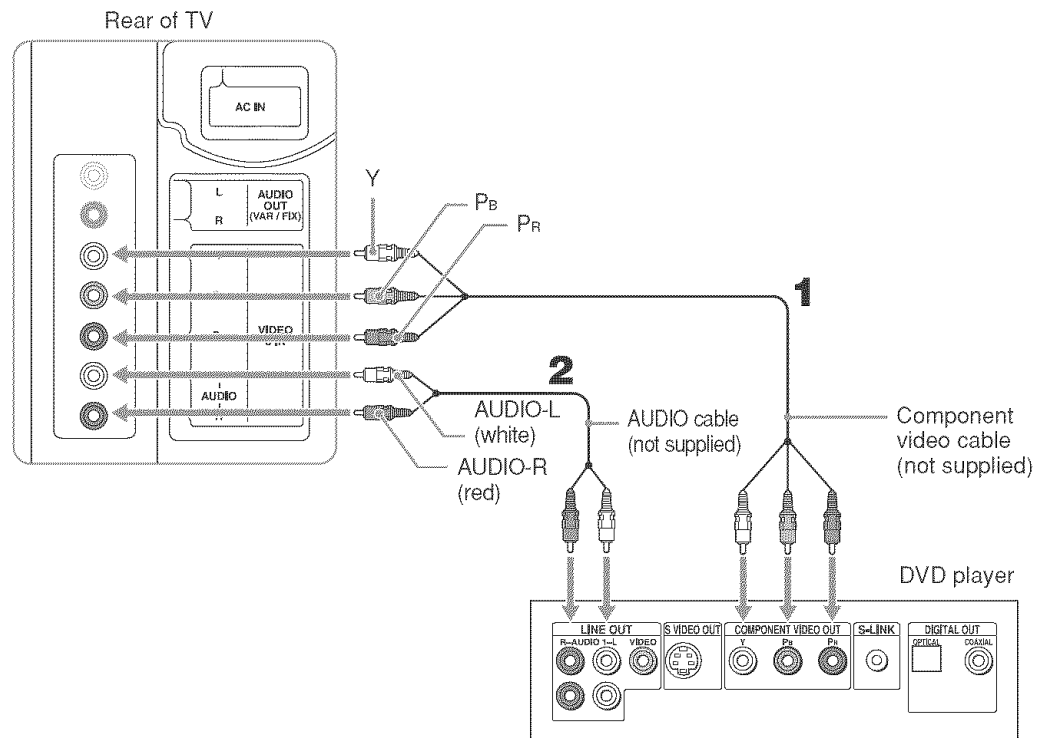

Tip

- To take advantage of the Wide Screen Modes, set the aspect ratio of the output signal to 16:9 on your DVD player. For details, refer to the operating instructions supplied with your DVD player.

Connecting a DVD Player with A/V Connectors

Use this hookup if:

- Your DVD player does not have component (Y, P_B, P_R) jacks.

Tip

If your DVD player has component video output connectors, for best picture quality, use the connection described on page 16.

Disconnect all power sources before making any connections.

- 1** Using an AUDIO cable, connect the DVD player's AUDIO OUT jacks to the TV's AUDIO IN jacks.
- 2** Using an S VIDEO cable, connect the DVD player's S VIDEO OUT jack to the TV's S VIDEO IN jack.

Tip

- If your VCR or satellite receiver is not equipped with S VIDEO, use a VIDEO cable (yellow) instead of the S VIDEO cable.

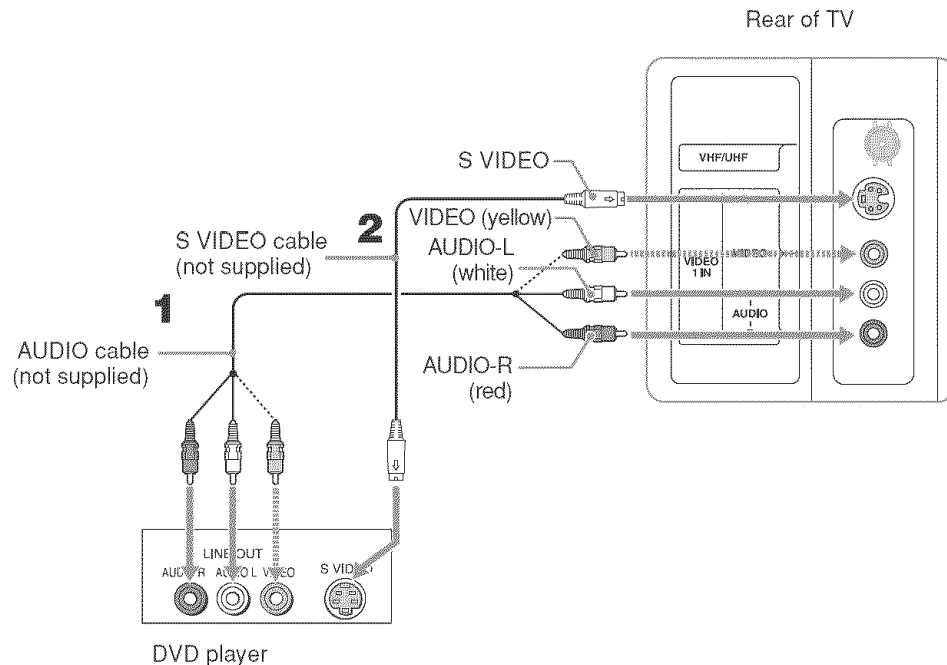

Note

When you connect video equipment to both the VIDEO and the S VIDEO input jacks, make sure "Auto YC" in the  (Setup) menu is set to "On" to view the S VIDEO input (see page 12).

Tips

- You can also use the VIDEO 2 IN jacks located on the left side of the TV to connect your DVD player.
- To take advantage of the Wide Screen Modes, set the aspect ratio of the output signal to 16:9 on your DVD player. For details, refer to the operating instructions supplied with your DVD player.
- Use TV/VIDEO on the remote control to switch to the DVD player input.

Connecting a Digital TV Receiver

Disconnect all power sources before making any connections.

- 1 Using a component video cable, connect the Digital TV receiver's Y, P_B and P_R jacks to the Y, P_B and P_R jacks on the TV. Use the VIDEO 3 IN connections.

Note

Component video (Y, P_B, P_R) connection is necessary to view 480p, 720p, and 1080i formats. Note that this TV displays all format types of picture in a resolution of 1,024 dots × 768 lines.

- 2 Using an AUDIO cable, connect the Digital TV receiver's AUDIO OUT jacks to the TV's AUDIO IN jacks.

Note

The Y, P_B and P_R jacks do not provide audio, so audio cables must be connected to provide sound.

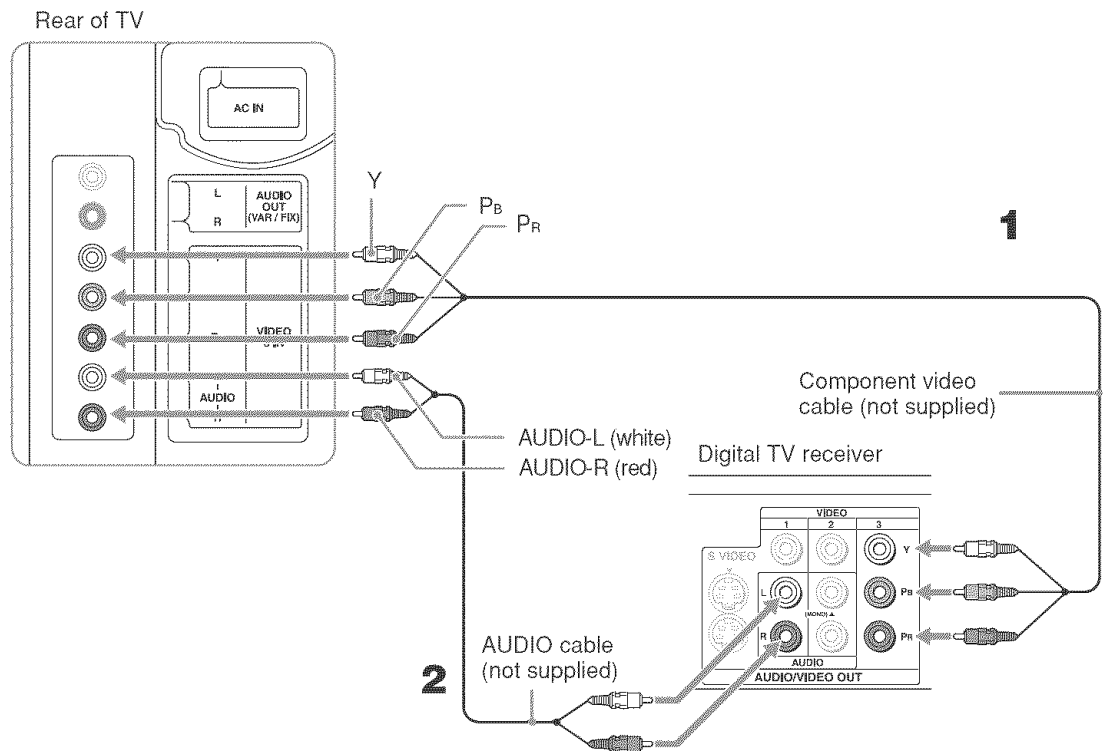

Connecting a Digital Satellite Receiver

Disconnect all power sources before making any connections.

- 1 Using a component video cable, connect the Digital Satellite Receiver's Y, P_B and P_R jacks to the Y, P_B and P_R jacks on the TV. Use the VIDEO 3 IN connections.

Note

Component video (Y, P_B, P_R) connection is necessary to view 480p, 720p, and 1080i formats. Note that this TV displays all format types of picture in a resolution of 1,024 dots × 768 lines.

- 2 Using an AUDIO cable, connect the Digital Satellite Receiver's AUDIO OUT jacks to the TV's AUDIO IN jacks.

Note

The Y, P_B and P_R jacks do not provide audio, so audio cables must be connected to provide sound.

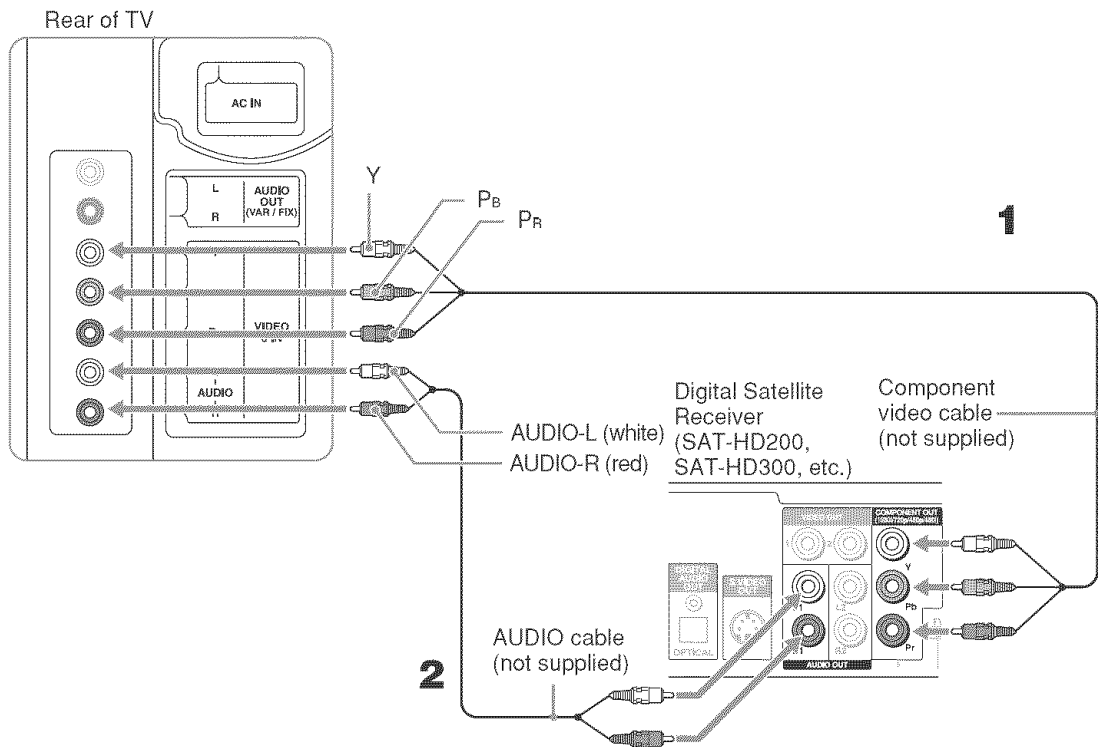

Setting the Channels

After you finish connecting your TV, you can run Auto Program to set up your channels. The Auto Setup menu appears when you turn your TV on for the first time after installing it. To skip channels, see page 21.

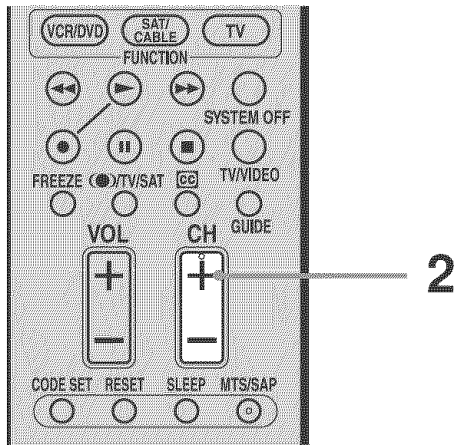
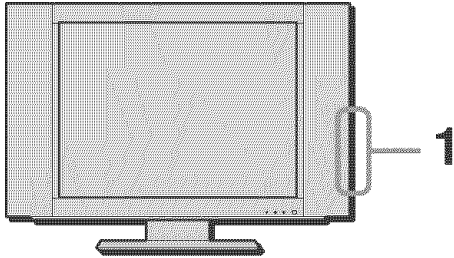

1 Press I (power) on the TV.

The Auto Setup menu automatically appears on the screen when you turn on the TV for the first time.

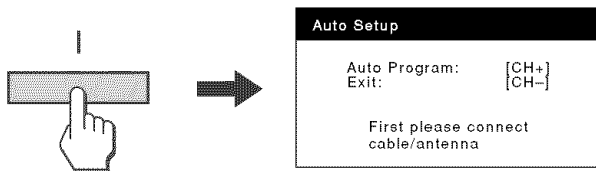

2 Press CH+ on the remote control or on the side panel of your TV to perform Auto Program.

When all the receivable channels are stored, the “Channel Skip/Add” menu appears.

Auto Program is set to scan cable TV channels by default. To watch VHF/UHF channels with an antenna, see “To watch VHF/UHF channels with an antenna” below.

To perform Auto Program again

- 1 Press MENU.
- 2 Press \uparrow/\downarrow to select  (Channel), then press \oplus .
- 3 Press \uparrow/\downarrow to select “Auto Program,” then press \oplus .
- 4 Press “OK.”

“Auto Program” appears and the TV starts scanning and presetting channels automatically. When all the receivable channels are stored, the “Channel Skip/Add” menu appears. Using this menu, you can start skipping unwanted channels (see “To skip channels” on page 21).

- 5 Press MENU to exit the menu screen.

To cancel Auto Program

While “Auto Program” is displayed in step 3, press MENU on the remote control.

Note

To watch cable TV channels, you have to subscribe to a cable TV company. Note that cable TV cannot be received in some areas. This TV receives 1-125 cable TV channels. For details on cable TV subscription, consult your nearest cable TV company.

To watch VHF/UHF channels with an antenna

- 1 Press MENU.
- 2 Press \uparrow/\downarrow to select  (Channel), then press \oplus .
- 3 Press \uparrow/\downarrow to select “Cable,” then press \oplus .
- 4 Press \uparrow/\downarrow to select “Off,” then press \oplus .
- 5 Perform steps 3 - 5 in “To perform Auto Program again” above.

Note

You cannot receive and set the cable TV channels and VHF/UHF channels at the same time.

Tip

When you have a cable box or satellite receiver connected, the Channel Fix feature is useful. For details, see page 21.

To skip channels

You can skip unnecessary channels when selecting channels using the CH +/- buttons.

- 1 Press MENU.
- 2 Press \uparrow/\downarrow to select  (Channel), then press \oplus .
- 3 Press \uparrow/\downarrow to select "Channel Skip/Add," then press \oplus .

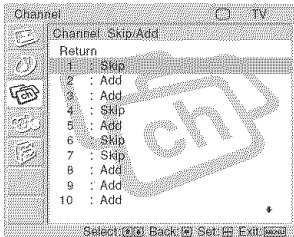

- 4 Press \uparrow/\downarrow to select the channel you want to skip, then press \oplus .

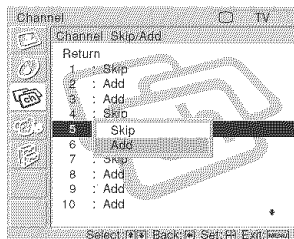

Example: Select this to skip channel 5.

Tip

To scroll through the list, press and hold \uparrow/\downarrow .

- 5 Press \uparrow/\downarrow to select "Skip," then press \oplus .

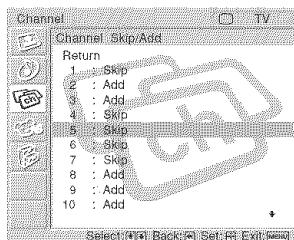

If you want to re-enter the skipped channel, select "Add."

- 6 Press MENU to exit the menu screen.

To lock in a TV channel

If you have connected a cable box or satellite receiver to your TV, and do not intend to connect any other audio or video equipment, it is recommended that you lock in a TV channel. Doing so will ensure no accidental channel switch when using your TV.

- 1 Press MENU.
- 2 Press \uparrow/\downarrow to select  (Channel), then press \oplus .
- 3 Press \uparrow/\downarrow to select "Channel Fix," then press \oplus .

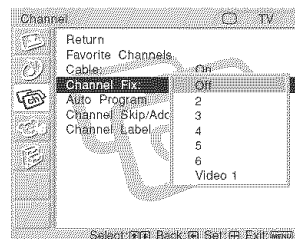

- 4 Press \uparrow/\downarrow to select the channel you want to set, then press \oplus .

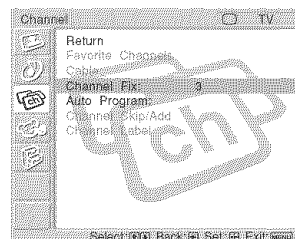

Option	Description
2-6	Select one of these channels if you have connected the equipment to the VHF/UHF jack.
Video 1	Select this if you have connected the equipment to the VIDEO 1 IN jacks.
Off	Select this to turn off the Channel Fix feature.

- 5 Press MENU to exit the menu screen.

Notes

- When you lock in a TV channel, the Favorite Channel feature cannot be used.
- When you lock in a TV channel, you cannot select "Channel Skip/Add" in the menu. To use it, set "Channel Fix" to "Off."

Selecting the On-screen Menu Language

You can select the language to be displayed in all menus.

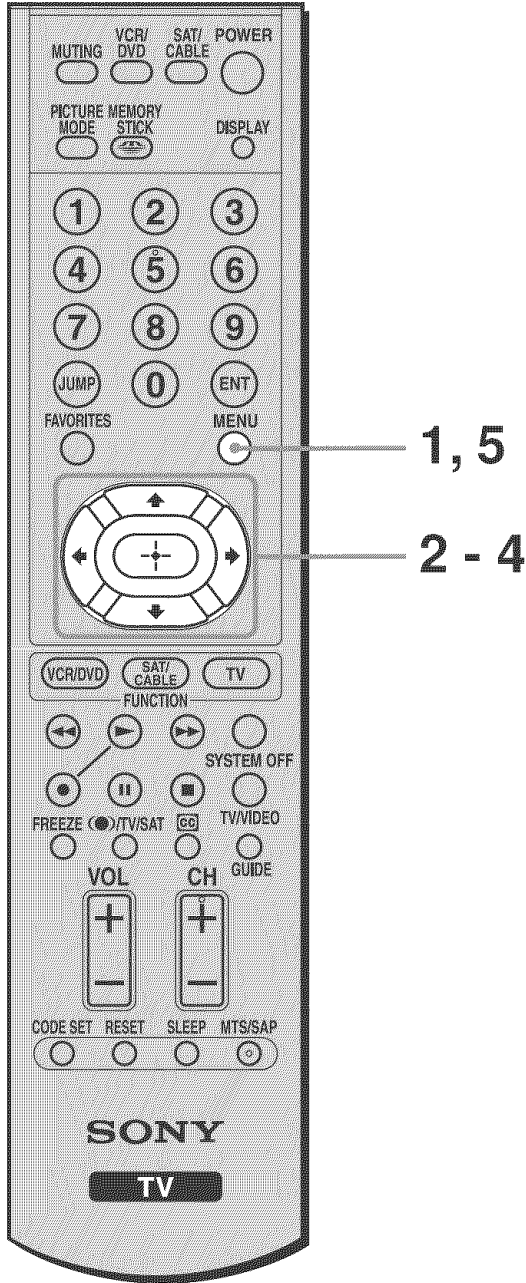

1 Press MENU.

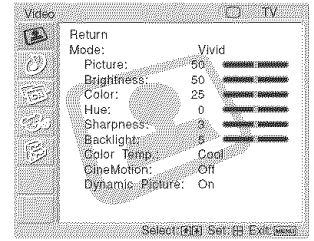
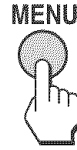

2 Press \uparrow/\downarrow to select  (Setup), then press \oplus .

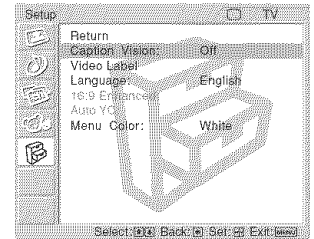
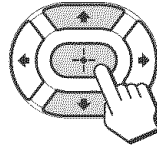

3 Press \uparrow/\downarrow to select "Language," then press \oplus .

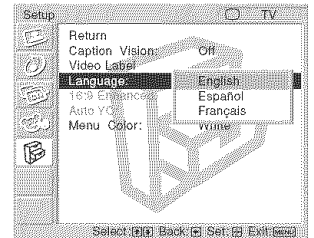
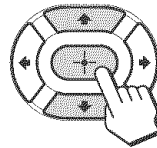

4 Press \uparrow/\downarrow to select your preferred language, then press \oplus .

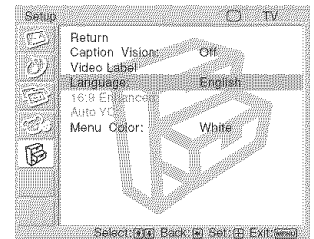
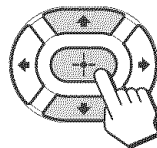

5 Press MENU to exit the menu screen.

Watching the TV

Watching the TV

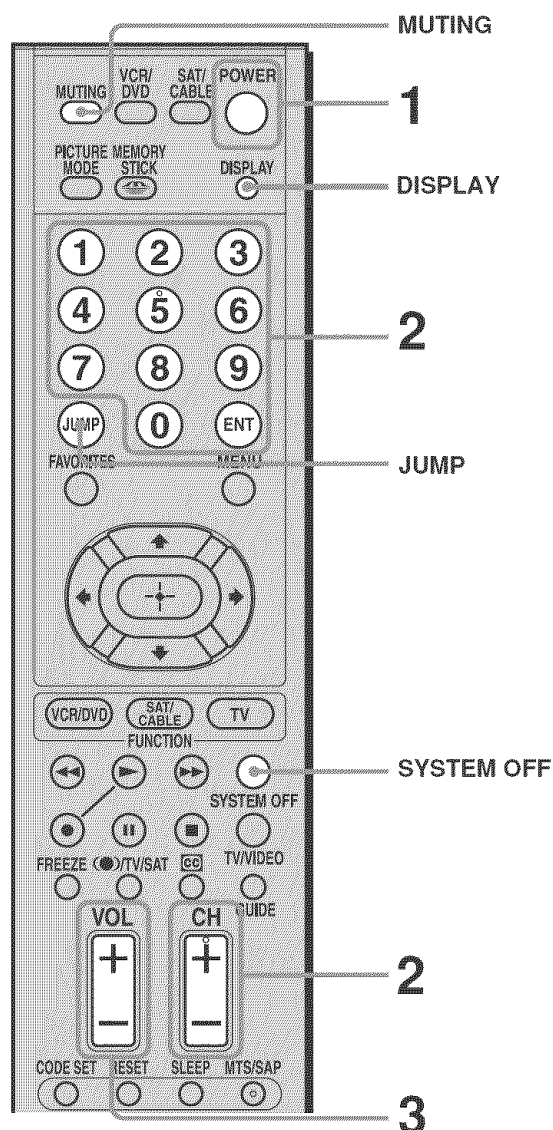
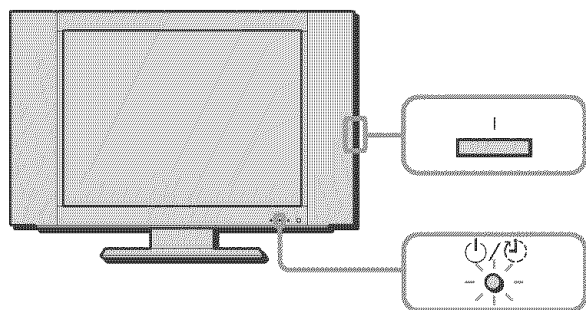

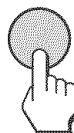

- 1 Press POWER on the remote control.

POWER



Tip

When the  (Standby/Sleep) indicator goes off, press  (power) on the TV.

- 2 Select the desired channel using the 0-9 and ENT (enter) buttons.

Press 0-9 to select a channel. The channel changes after 2 seconds. Press ENT (enter) to select immediately.

Use the CH +/- buttons to scan through the channels.

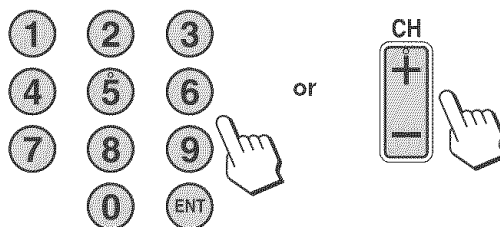

Tip

When you press and hold CH + or -, the channel number will change rapidly.

- 3 Adjust the volume using the VOL +/- buttons.

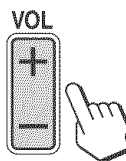

Other button operations

Press	To
MUTING	Mute the sound. Press it again or press VOL + to restore sound.
SYSTEM OFF	Turn off the TV and all other Sony equipment.
DISPLAY	Display the current channel number. When the channel display is turned on, the current channel number remains displayed. Press it again to turn the display off.
JUMP	Jump back and forth between two channels. The TV alternates between the current channel and the last channel selected using the 0-9 buttons.

Tip

You can adjust the volume by referring to the value beside the volume indicator (on screen).

Watching with closed caption

You can display Caption Vision if the broadcaster offers this service.

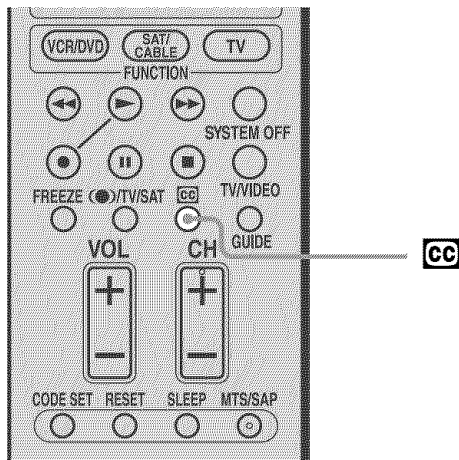

Press **CC** repeatedly until the desired Caption Vision appears.

Each time you press the button, Caption Vision changes as follows:

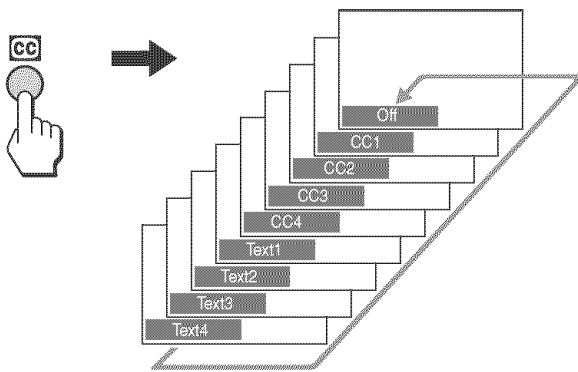

Select	To
Off	Turn off Caption Vision.
CC1, CC2, CC3, CC4	Display a printed version of the dialogue or sound effects of a program. (The mode should be set to CC1 for most programs.)
Text1, Text2, Text3, Text4	Display network/station information presented using either half or the whole screen.

Tip

You can also select Caption Vision on the menu screen. Select "Caption Vision" in the  (Setup) menu, then select the desired type of Caption Vision.

Selecting the Picture Mode

You can select one of three different Picture Modes that best suits the program you are watching. Furthermore, you can adjust the picture quality for each Picture Mode (see pages 37, 38). You can set a different Picture Mode for each video input that can be selected using the TV/VIDEO button, and store it in memory.

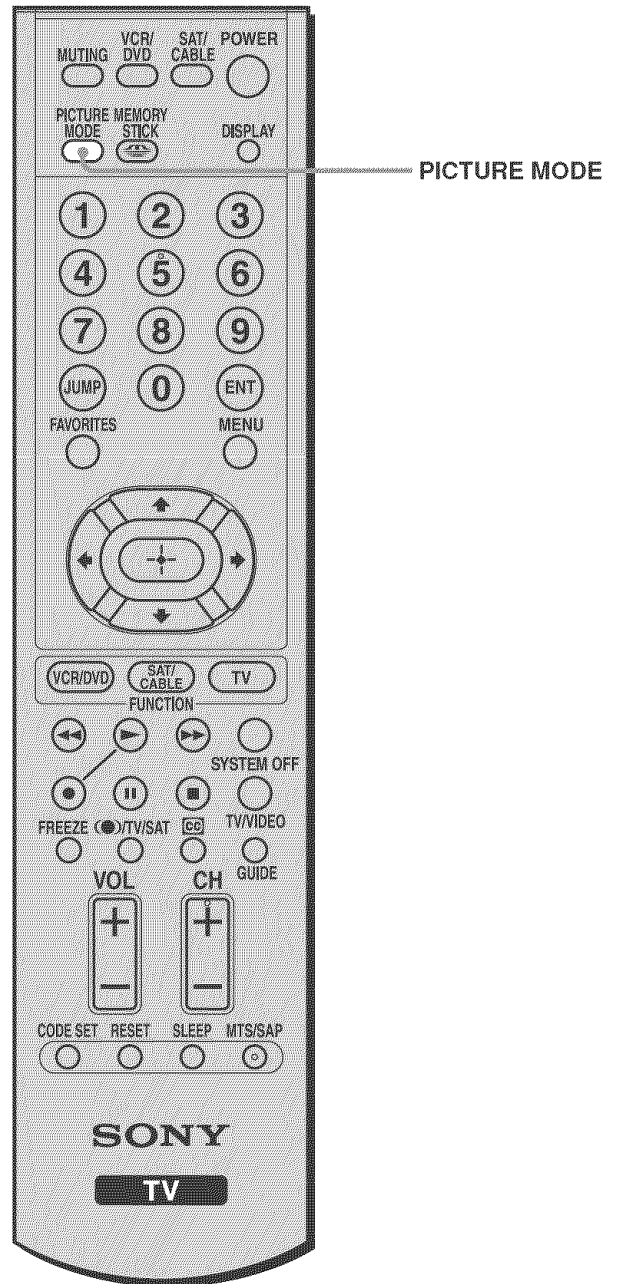

Press PICTURE MODE repeatedly until the desired mode appears.

Each time you press the button, the Picture Mode changes as follows:

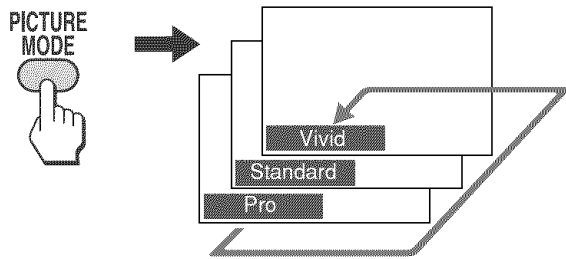

Picture Mode	Description
Vivid	Select for enhanced picture contrast and sharpness.
Standard	Select to display a picture with contrast to suit your room's lighting conditions. This mode is recommended for normal viewing conditions.
Pro	Select for professional monitor-like appearance.

Tip

You can adjust the picture quality options, such as "Picture," "Brightness," and "Color," for each Picture Mode (see pages 37, 38).

Selecting the Effect Mode

"SRS WOW"* creates a panoramic stereo audio image by producing deep and rich bass tones and clear treble tones, enabling you to enjoy powerful sounds effects like those in a movie theater.

You can set the Effect mode for each video input that can be selected using the TV/VIDEO button, and store it in memory.

* "SRS WOW" increases the sound quality of a diverse range of audio sources dramatically based on proprietary state-of-the-art technologies from SRS Labs, Inc.

WOW, SRS and (●) symbol are trademarks of SRS Labs, Inc.

WOW technology is incorporated under license from SRS Labs, Inc.

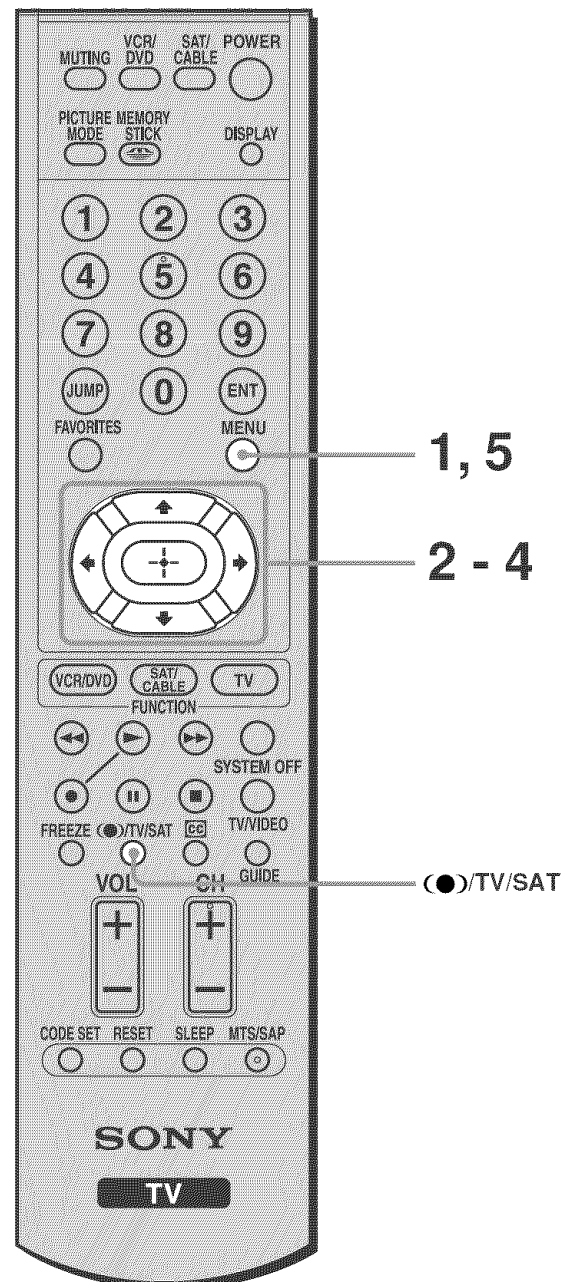

Notes

- You cannot select the Effect mode if “Speaker” in the  (Audio) menu is set to “Off.”
- The Effect mode is valid only on the TV’s speakers. So you cannot enjoy sound effects of SRS WOW when you listen to a program through the AUDIO OUT jacks or on headphones.
- SRS WOW may be restricted in the effects it produces when you listen to a program in monaural.

Tip

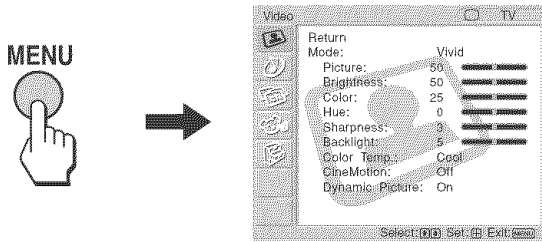

You can adjust other sound quality options. For details, see “Adjusting the Sound Quality” on page 39.

1 Press MENU.



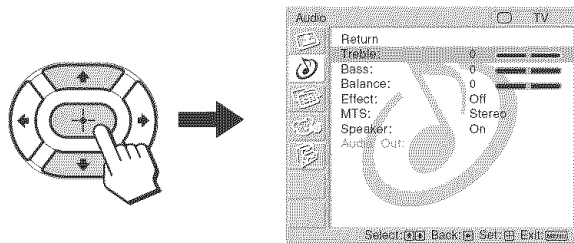

2 Press  to select  (Audio), then press .

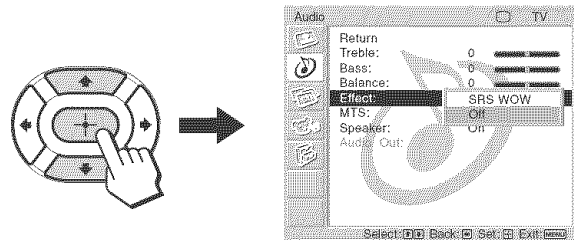

3 Press  to select “Effect,” then press .



4 Press  to select “SRS WOW,” then press .

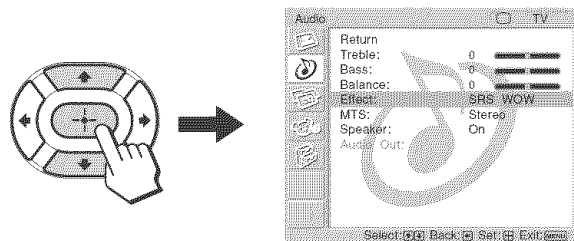

5 Press MENU to exit the menu screen.

Tip

Pressing the /TV/SAT button also lets you select “SRS WOW” and “Off.”

Using the 16:9 Enhanced Feature

The 16:9 Enhanced feature provides enhanced picture resolution, which allows you to watch widescreen pictures that have been stretched in the vertical direction, such as certain DVD titles, at their original 16:9 aspect ratio.

Note

The 16:9 Enhanced feature is available only when the TV is set to Video 1, Video 2 or Video 3, which you can do by pressing the TV/VIDEO button (see page 28).

Tip

The “aspect ratio” is the ratio of width to height of the screen. 16:9 is also referred to as widescreen format.

Original Picture

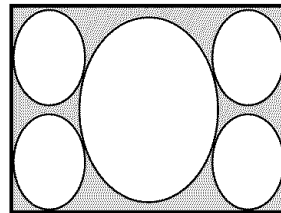

16:9 Enhanced Picture

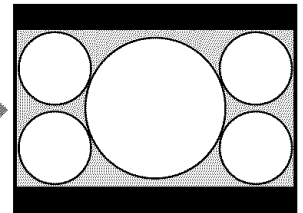

- Wide screen video camera or DVD picture
- DTV 16:9 aspect ratio picture

Compressed vertically and displayed on the screen at its original 16:9 aspect ratio.

However, black bands appear at the top and bottom of the picture.

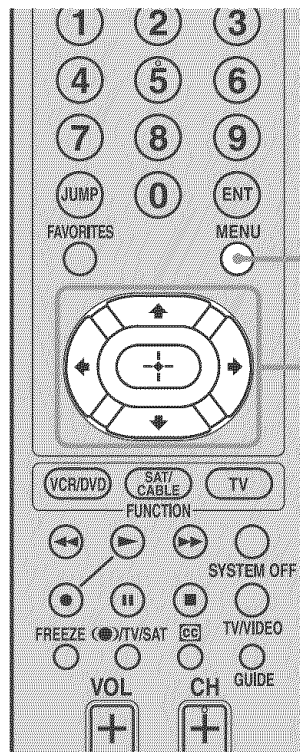

1 Press MENU.

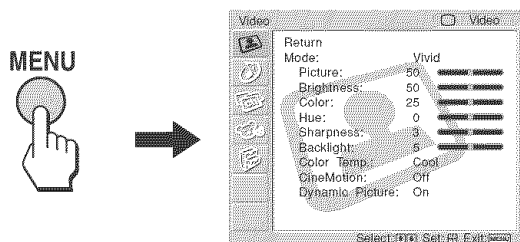

2 Press \uparrow/\downarrow to select  (Setup), then press \oplus .

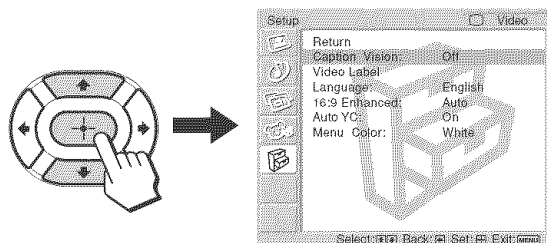

3 Press \uparrow/\downarrow to select "16:9 Enhanced," then press \oplus .

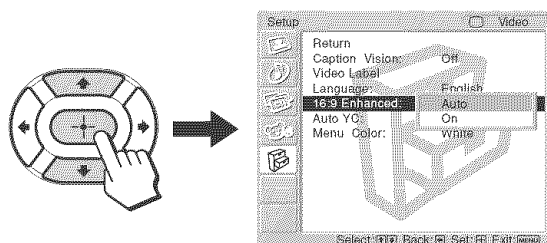

4 Press \uparrow/\downarrow to select "Auto," then press \oplus .

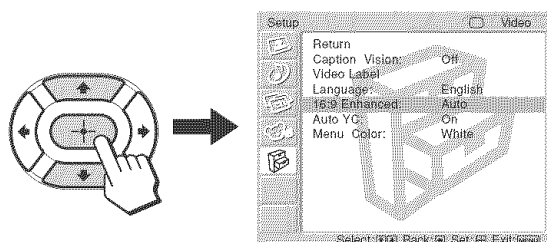

Option	Description
On	Activates the 16:9 Enhanced feature. This setting returns to "Auto" automatically when you change the video input.
Auto	Activates the 16:9 Enhanced feature automatically when a 16:9 aspect ratio signal is received.

Tips

- If the TV does not automatically detect the 16:9 aspect ratio signal when "16:9 Enhanced" is set to "Auto," select "On" to turn on the 16:9 Enhanced feature.
- To use the 16:9 Enhanced feature with widescreen DVDs, set the aspect ratio of the output signal to 16:9 on your DVD player.

5 Press MENU to exit the menu screen.

Using the Freeze Function

You can use this feature to write down information such as phone numbers, recipes, etc.

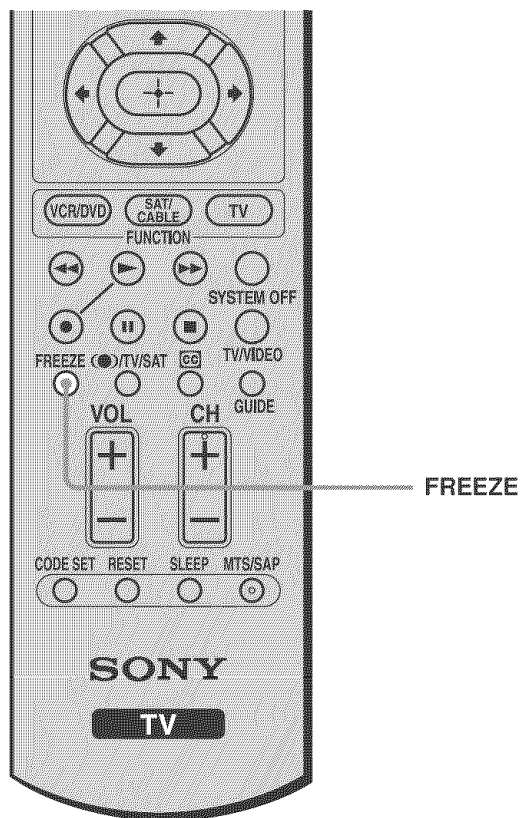

When the program information you want to capture is displayed, press FREEZE.

The picture freezes. Press FREEZE again, and the frozen picture is released, and the picture begins to move again.

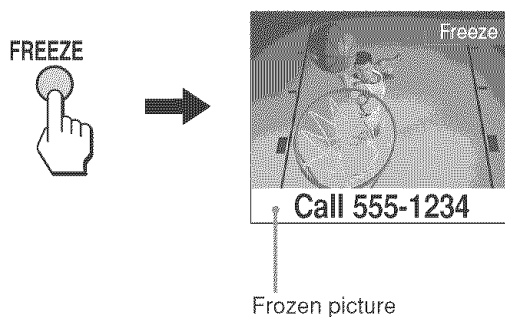

Tip

While the picture is frozen, the sound continues to be output normally.

Setting the Video Inputs

You can enjoy images (and sound) from optional video equipment connected to this unit by selecting the appropriate input. For details on connection, see pages 8 through 19.

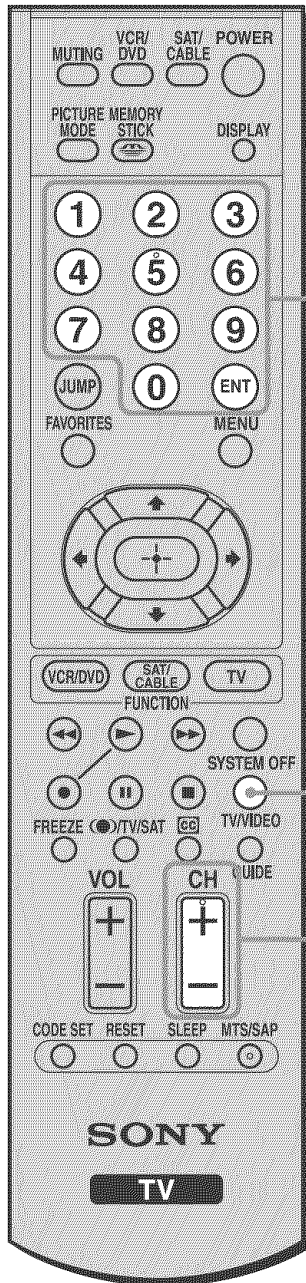

0-9 and ENT (enter) buttons

1

CH +/-

1 Press TV/VIDEO repeatedly until the desired video input appears.

Each time you press TV/VIDEO, the input changes as follows:

Select	Display indication
• TV	TV
• VIDEO 1 IN	↓ Video 1
• VIDEO 2 IN	↓ Video 2
• VIDEO 3 IN	↓ Video 3*

* The type of picture signal (480i, 480p, 720p, or 1080i) appears under "Video 3."

Tips

- You can also select the inputs by using the TV/VIDEO button on the TV.
- When you have preset a label for each video input using "Video Label" in the  (Setup) menu, the label will be displayed (see page 29).

2 Operate the selected optional equipment.

For details, see "Operating Optional Equipment with Your TV Remote Control" on page 30, or refer to the instructions supplied with each equipment.

To return to watch the TV

Press any of 0-9 and ENT (enter) or CH +/-.

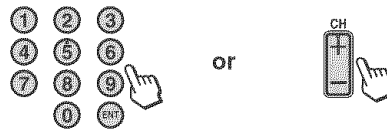

Using the Video Label Feature

You can make settings for each video input by choosing the label displayed on the screen.

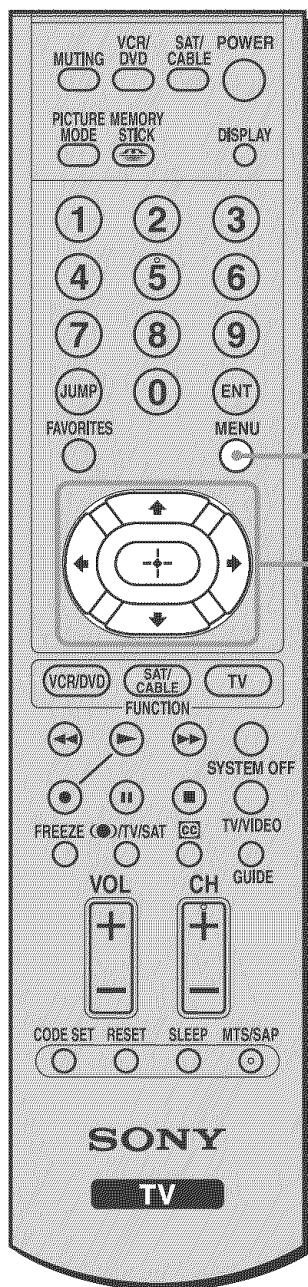

1, 7

2 - 6

1 Press MENU.

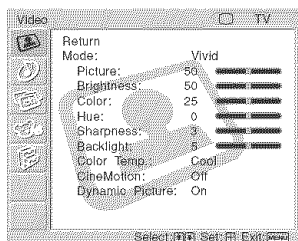

2 Press \uparrow/\downarrow to select  (Setup), then press \odot .

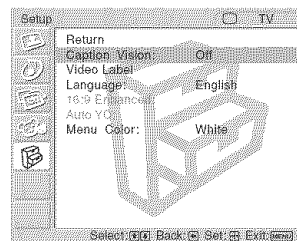
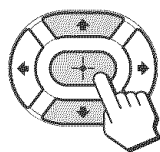

3 Press \uparrow/\downarrow to select "Video Label," then press \odot .

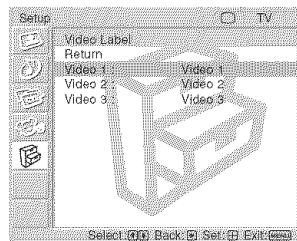
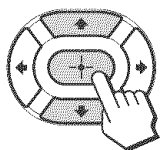

4 Press \uparrow/\downarrow to select the video input (Video 1-3) you want to assign a label, then press \odot .

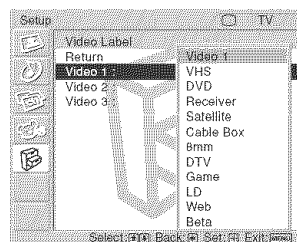
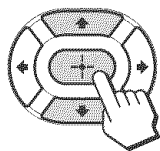

5 Press \uparrow/\downarrow to select the label, then press \odot .

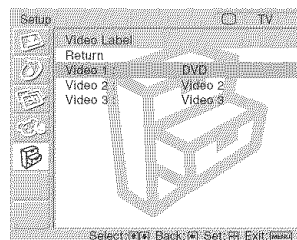
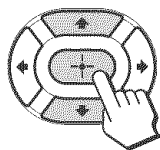

6 Repeat steps 4 and 5 to assign labels to more video inputs.

You can select from the following labels for each input.

Video 1, 2	VHS, DVD, Receiver, Satellite, Cable Box, 8mm, DTV, Game, LD, Web, Beta
Video 3	DVD, Satellite, Cable Box, DTV, HD

7 Press MENU to exit the menu screen.

Operating Optional Equipment with Your TV Remote Control

Programming the remote control

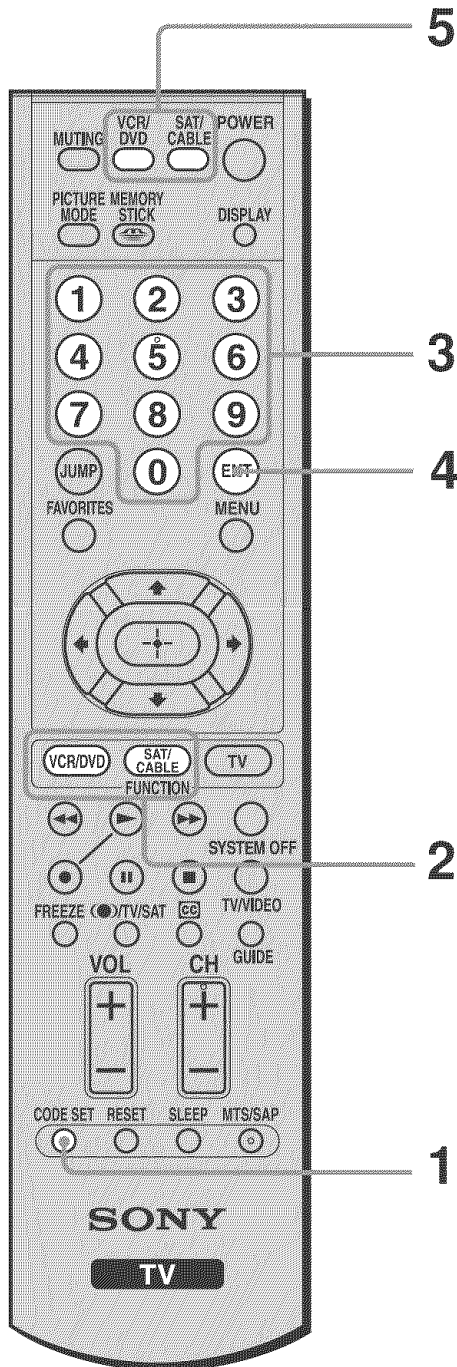

The remote control is preset to operate Sony video equipment.

Sony equipment	Programmable code number
Beta, ED Beta VCRs	303
8mm VCR	302
VHS VCR	301
DV VCR	348
DVD player	751

If you have video equipment other than Sony video equipment that you want to control with the TV's remote control, use the following procedures to program the remote control.

Note

The equipment must have infrared (IR) remote capability in order to be used with this remote control.

From the "Manufacturer's codes" listed on page 31, select the three-digit code number for the manufacturer's code of your equipment. If more than one code number is listed, try entering them one by one until you come to the correct code for your equipment. Use the code number to complete the following procedure.

- 1 Press CODE SET.
- 2 Press the function button you want to program.
 - To program a cable box or a satellite receiver**
Press SAT/CABLE (FUNCTION).
 - To program video equipment**
Press VCR/DVD (FUNCTION).
- 3 Enter the three-digit manufacturer's code number using the 0-9 buttons.
- 4 Press ENT (enter).
- 5 To check if the code number works, aim the TV's remote control at the equipment and press VCR/DVD and/or SAT/CABLE (POWER) that corresponds with that equipment. If it responds, the programming is completed. If not, try using the other codes listed for that manufacturer.

Tips

- If you enter a new code number, the code number you previously entered at that setting is erased.
- In some rare cases, you may not be able to operate your equipment with the Sony remote control. In this case, use the equipment's own remote control unit.

Manufacturer's codes**VCRs**

Manufacturer	Code
Sony	301
Admiral (M. Ward)	327
Aiwa *	338, 344
Audio Dynamic	314, 337
Broksonic	319, 317
Canon	309, 308
Citizen	332
Craig	302, 332
Criterion	315
Curtis Mathes	304, 338, 309
Daewoo	341, 312, 309
DBX	314, 336, 337
Dimensia	304
Emerson	319, 320, 316, 317, 318, 341
Fisher	330, 335
Funai	338
General Electric	329, 304, 309
Go Video	322, 339, 340
Goldstar	332
Hitachi	306, 304, 305, 338
Instant Replay	309, 308
JC Penney	309, 305, 304, 330, 314, 336, 337
JVC	314, 336, 337, 345, 346, 347
Kenwood	314, 336, 332, 337
LXI (Sears)	332, 305, 330, 335, 338
LG	332
Magnavox	308, 309, 310
Marantz	314, 336, 337
Marta	332
Memorex	309, 335
Minolta	305, 304
Mitsubishi/MGA	323, 324, 325, 326
Multitech	325, 338, 321
NEC	314, 336, 337
Olympic	309, 308
Optimus	327
Panasonic	308, 309, 306, 307

Manufacturer	Code
Pentax	305, 304
Philco	308, 309
Philips	308, 309, 310
Pioneer	308
Quasar	308, 309, 306
RCA/PROSCAN	304, 305, 308, 309, 311, 312, 313, 310, 329
Realistic	309, 330, 328, 335, 324, 338
Sansui	314
Samsung	322, 313, 321
Sanyo	330, 335
Scott	312, 313, 321, 335, 323, 324, 325, 326
Sharp	327, 328
Shintom	315
Signature 2000 (M. Ward)	338, 327
SV2000	338
Sylvania	308, 309, 338, 310
Symphonic	338
Tashiro	332
Tatung	314, 336, 337
Teac	314, 336, 338, 337
Technics	309, 308
Toshiba	312, 311
Wards	327, 328, 335, 331, 332
Yamaha	314, 330, 336, 337
Zenith	331

* If an Aiwa VCR does not work even though you enter the code for Aiwa, enter the code for Sony instead.

DVD Players

Manufacturer	Code
Sony	751
Panasonic	753
Pioneer	752
RCA	755
Toshiba	754

Cable Boxes

Manufacturer	Code
Sony	230
Hamlin/Regal	222, 223, 224, 225, 226
Jerrold/G. I.	201, 202, 203, 204, 205, 206, 207, 208, 218
Oak	227, 228, 229
Panasonic	219, 220, 221
Pioneer	214, 215
Scientific Atlanta	209, 210, 211
Tocom	216, 217
Zenith	212, 213

Satellite Receivers

Manufacturer	Code
Sony	801
General Electric	802
Hitachi	805
Hughes	804
Panasonic	803
RCA/PROSCAN	802, 808
Toshiba	806, 807

(Continued)

Operating optional equipment

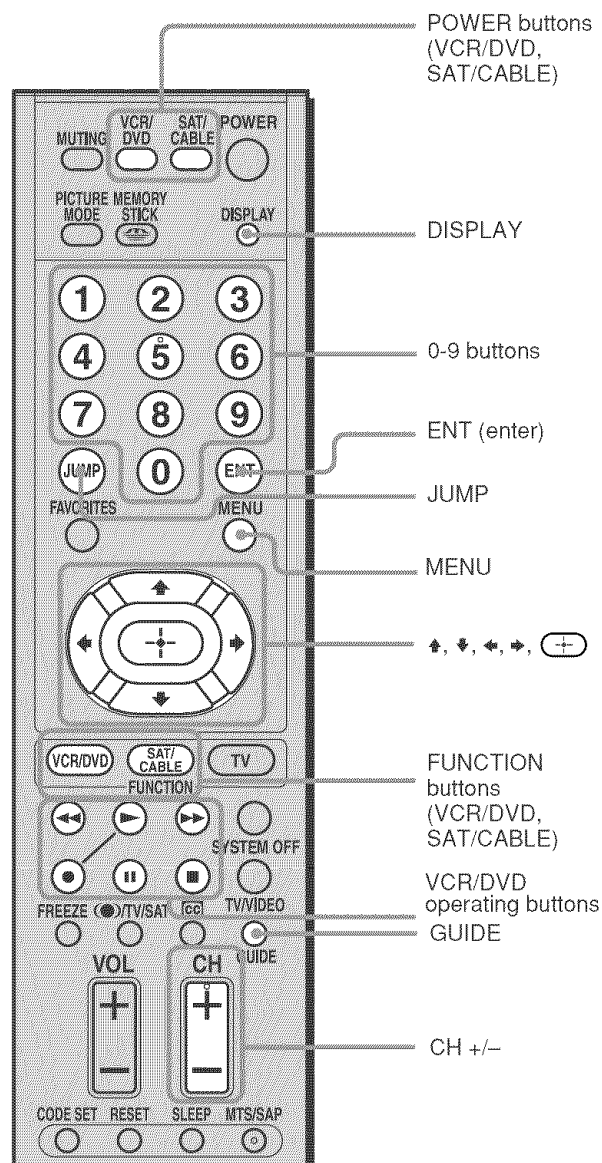

Operating a VCR

To	Press
Turn on/off	VCR/DVD (POWER)
Control a VCR	VCR/DVD (FUNCTION)
Change channels	CH +/-
Record	▶ and ● simultaneously
Play	▶
Stop	■
Fast forward	▶▶
Rewind	◀◀
Pause	(press again to resume normal playback)
Search the picture forward or backward	▶▶ or ◀◀ during playback (release to resume normal playback)

Operating a DVD player

To	Press
Turn on/off	VCR/DVD (POWER)
Control a DVD player	VCR/DVD (FUNCTION)
Play	▶
Stop	■
Pause	(press again to resume normal playback)
Step through different tracks of an audio disc	▶▶ to step forward or ◀◀ to step backward
Step through different chapters of a video disc	CH + to step forward or CH - to step backward
Select a track directly	0-9 buttons
Display the menu (Setup)	MENU
Operate the DVD menu	↑, ↓, ←, →, (+)

Operating a cable box

To	Press
Turn on/off	SAT/CABLE (POWER)
Control a cable box	SAT/CABLE (FUNCTION)
Select a channel	0-9 buttons, ENT (enter)
Change channels	CH +/-
Go to the previous channel	JUMP

Operating a satellite receiver

To	Press
Turn on/off	SAT/CABLE (POWER)
Control a satellite receiver	SAT/CABLE (FUNCTION)
Select a channel	0-9 buttons, ENT (enter)
Change channels	CH +/-
Go to the previous channel	JUMP
Display the channel number	DISPLAY
Display the DBS guide	GUIDE
Display the DBS menu	MENU
Move the highlight (cursor)	↑, ↓, ←, →
Select the item	(+)

Using Favorite Channels

You can select programs from a list of favorite channels that you preset.

Setting your favorite channels

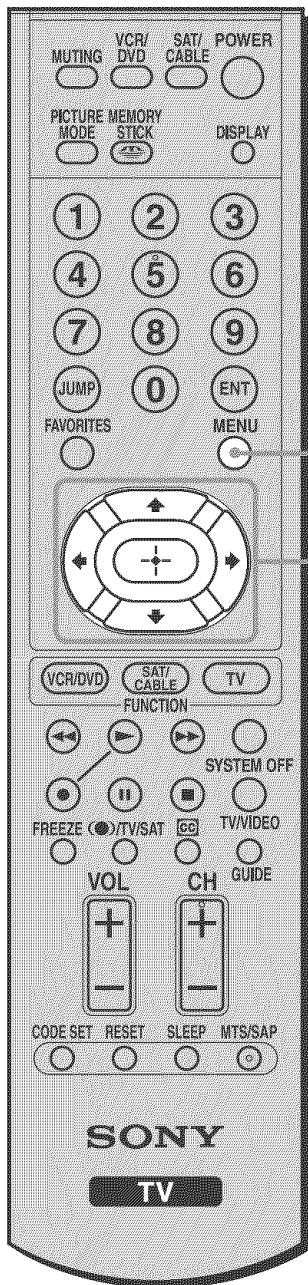

1 Press MENU.

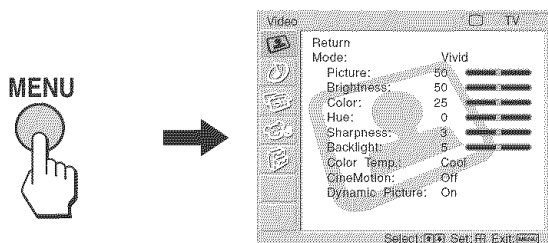

2 Press / to select (Channel), then press .

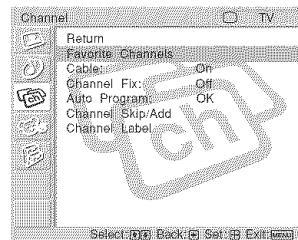
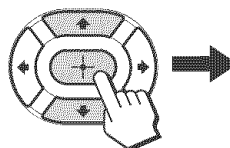

3 Press / to select "Favorite Channels," then press .

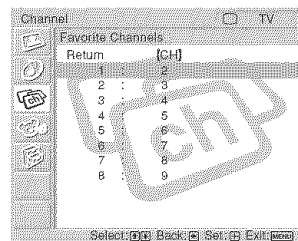
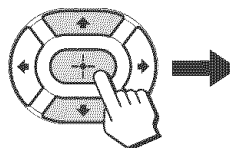

Tip

If you cannot select "Favorite Channels," change the input to TV by pressing the TV/VIDEO button.

4 Press / to select the position you want to change, then press .

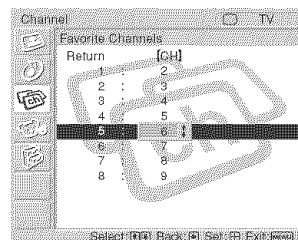
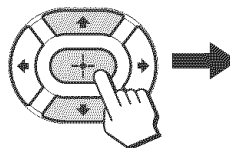

5 Press / to scroll through the channels until you find the desired channel, then press .

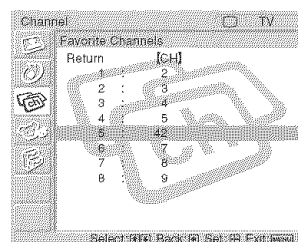
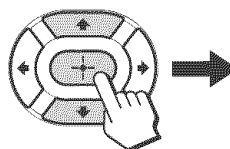

6 Repeat steps 4 and 5 to program other favorite channels.

7 Press MENU to exit the menu screen.

(Continued)

Watching favorite channels

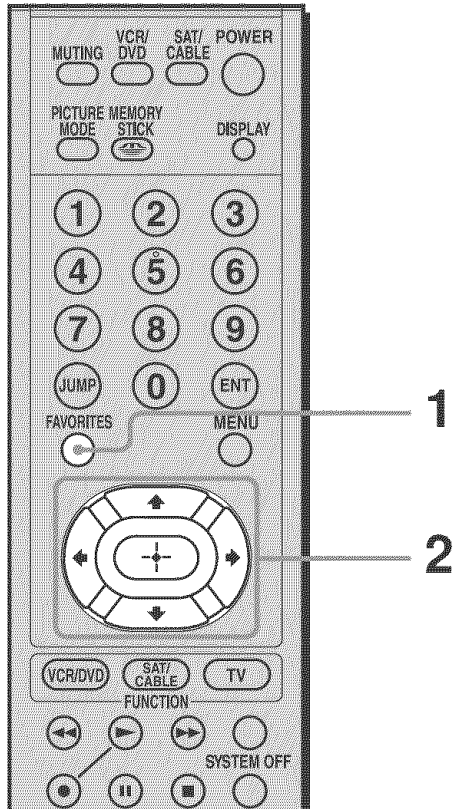

1 Press FAVORITES.

The Favorite Channels list appears.

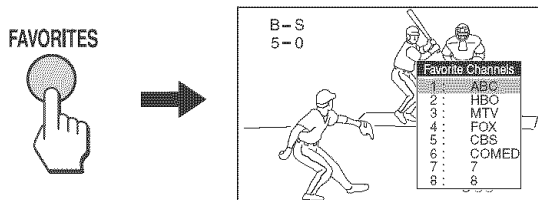

2 Press \uparrow/\downarrow to select the desired channel, then press \oplus .

The selected channel will be displayed.

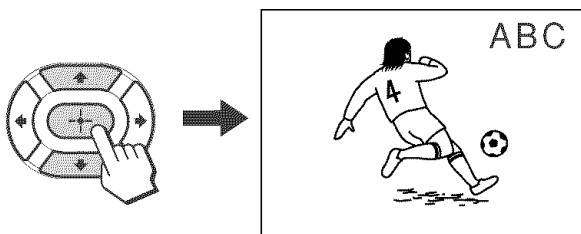

Tip

If you make an optional label using “Channel Label” in the  (Channel) menu, that label will be displayed on the screen.

Using the Channel Label Feature

If you have set an optional label for the channel display or for Favorite Channels, you can have that label displayed on the screen.

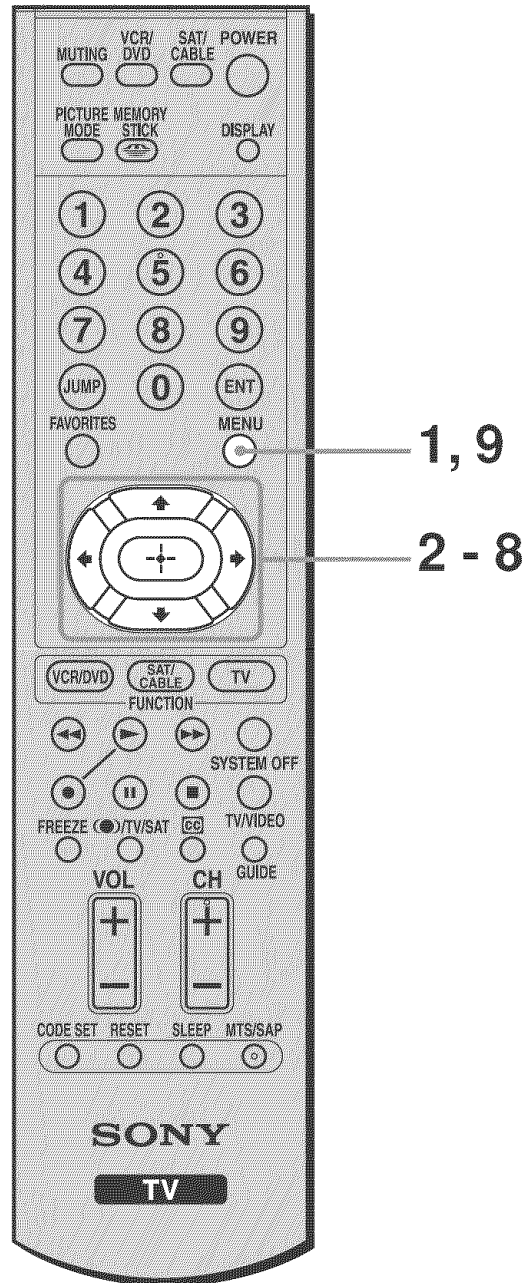

1 Press MENU.

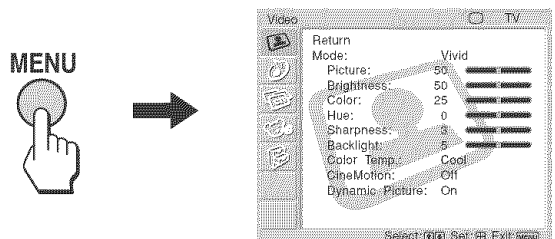

- 2** Press $\blacktriangle/\blacktriangledown$ to select  (Channel), then press .

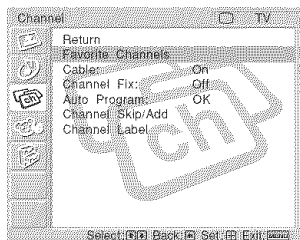
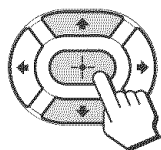

- 3** Press $\blacktriangle/\blacktriangledown$ to select "Channel Label," then press .

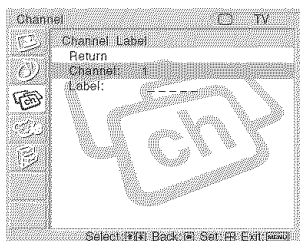
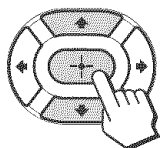

- 4** Press $\blacktriangle/\blacktriangledown$ to select "Channel," then press .

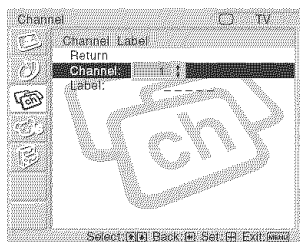
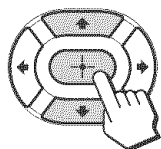

- 5** Press $\blacktriangle/\blacktriangledown$ to scroll through the channel numbers you want to assign a label, then press .

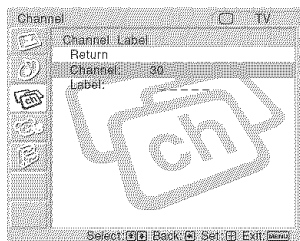
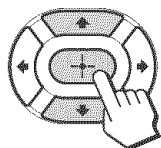

- 6** Press $\blacktriangle/\blacktriangledown$ to select "Label," then press .

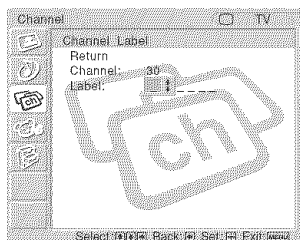
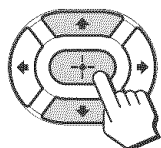

- 7** Press $\blacktriangle/\blacktriangledown$ to scroll through the label characters (A-Z, 0-9, etc.), then press .

You can add up to 5 characters to the label.

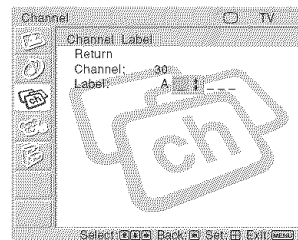
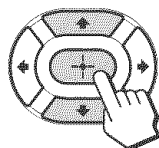

- 8** Repeat steps 4 - 7 to assign labels to more channels.

- 9** Press MENU to exit the menu screen.

Using Advanced Features

Using the Menu

Most of advanced settings and adjustments are performed using the menu screen. Basic operations to navigate through menus are described below.

- Items which appear in yellow are selected.
- You cannot select items which appear in pale color.

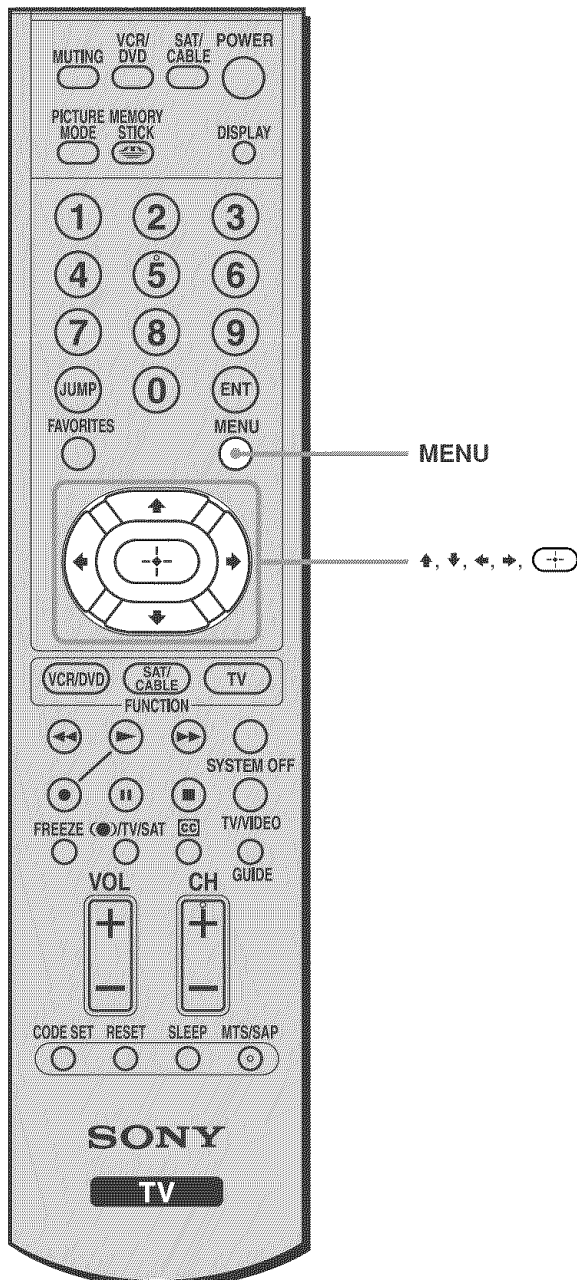

To open the menu screen and select the option

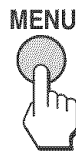

Menu category Menu option

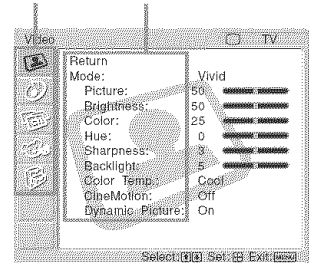

Press MENU to open the menu screen.

Press \uparrow/\downarrow to select the desired category, then press \leftarrow .

To exit the menu screen, press MENU again.

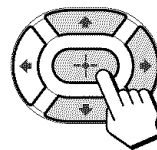

Press \uparrow/\downarrow to select the option, then press \rightarrow or \leftarrow .
(The \rightarrow button cannot be used on some menus.)

Setting option

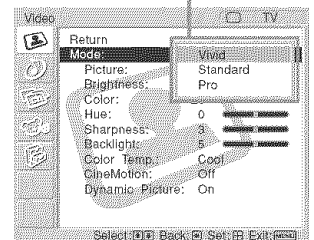

(Example: when selecting "Mode" in the  (Video) menu)

To adjust the setting

Maximize the setting value

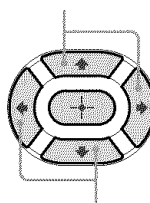

Minimize the setting value

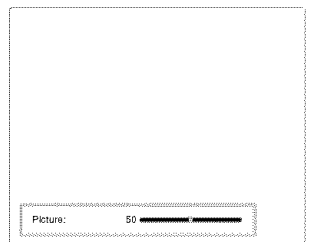

(Example: when selecting "Picture" in the  (Video) menu)

To change the menu color

You can choose the menu color from two types by selecting "Menu Color" in the  (Setup) menu, then selecting "White" or "Black."

Adjusting the Picture Quality

You can adjust the picture quality for each Picture Mode (“Vivid,” “Standard,” or “Pro”).

You can adjust the picture quality differently for each video input which can be selected using the TV/VIDEO button, and store it in memory.

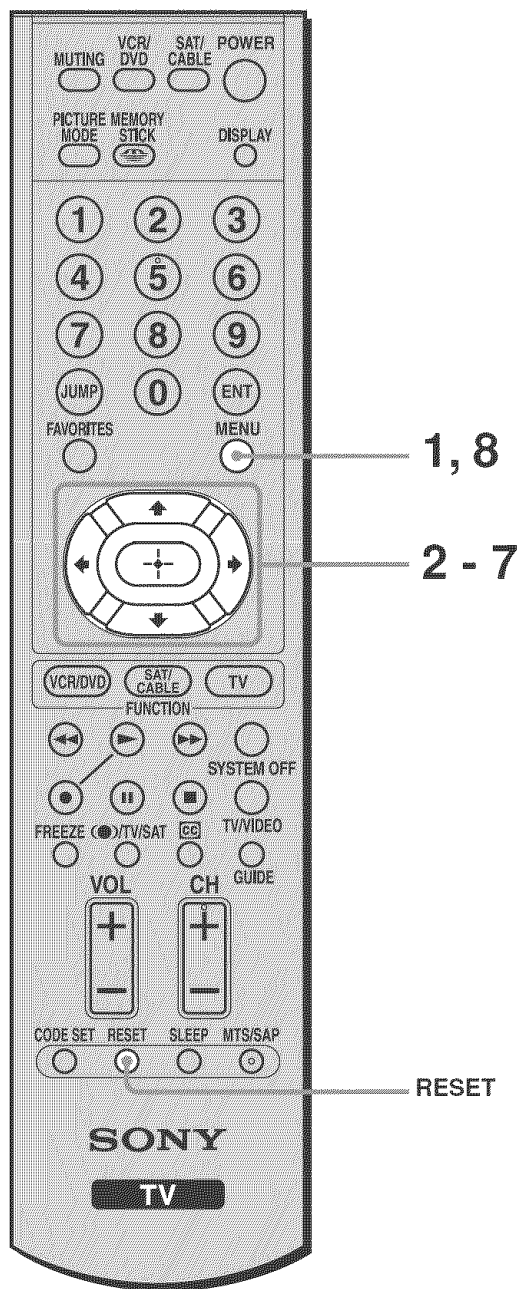

1 Press MENU.

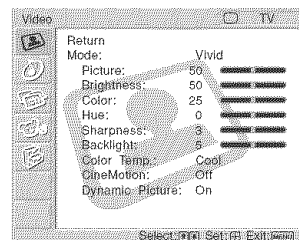
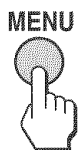

2 Press \uparrow/\downarrow to select (Video), then press \oplus .

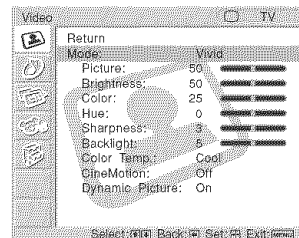
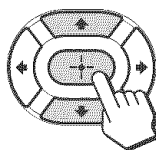

3 Press \uparrow/\downarrow to select “Mode,” then press \oplus .

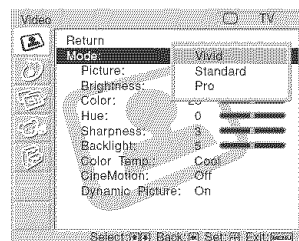
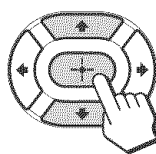

4 Press \uparrow/\downarrow to select the Picture Mode you want to adjust, then press \oplus .

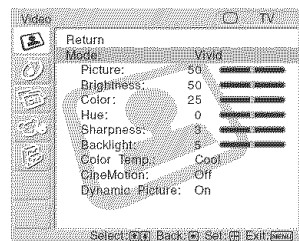
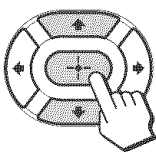

5 Press \uparrow/\downarrow to select “Picture,” then press \oplus .

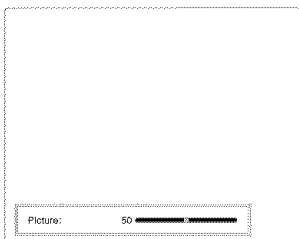
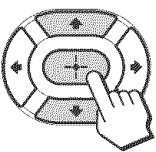

(Continued)

- 6 Press $\uparrow/\downarrow/\leftarrow/\rightarrow$ to make the desired adjustment, then press \ominus .

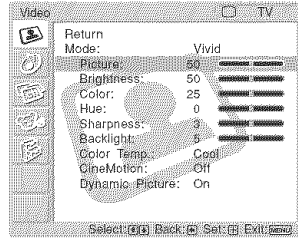
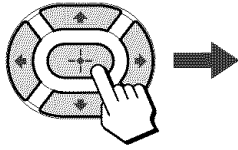

Adjustable options

Option	Press \downarrow/\leftarrow	Press \uparrow/\rightarrow
Picture	To reduce picture contrast.	To enhance picture contrast.
Brightness	To darken the picture.	To brighten the picture.
Color	To decrease color intensity.	To increase color intensity.
Hue*	To decrease the green tones.	To increase the green tones.
Sharpness**	To soften the picture.	To sharpen the picture.
Backlight	To darken the screen.	To brighten the screen.

- * The adjustment is not available for the followings:
- 480i, 480p, 1080i and 720p signals input to VIDEO 3 IN
 - Digital photos and movies recorded on “Memory Stick”

- ** The adjustment is not available for the digital photos and movies recorded on “Memory Stick.”

Tip

You can adjust each option by referring to the value beside each option indicator.

Selective options

Option	Description	Setting
Color Temp. (Color Temperature)	Select to give bright colors a red tint.	Cool/ Neutral/ Warm
CineMotion*	Select to provide an optimized display by automatically detecting film content. Moving pictures will become clearer and more natural. When the superimposed text on the film content appears corrupted, set “CineMotion” to “Off.”	On/Off
Dynamic Picture*	Select to enhance the picture contrast.	On/Off

- * The adjustment is not available for the digital photos and movies recorded on “Memory Stick.”

- 7 Repeat steps 5 and 6 to adjust other options.

- 8 Press MENU to exit the menu screen.

To reset to the factory settings

Press RESET while the menu is on the screen and the cursor is located on the right side of any menu item.

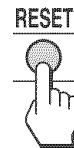

Adjusting the Sound Quality

You can adjust the sound quality differently for each video input which can be selected using the TV/VIDEO button and  (“Memory Stick”) button, and store it in memory.

For details on the Effect mode, see pages 25 and 26.

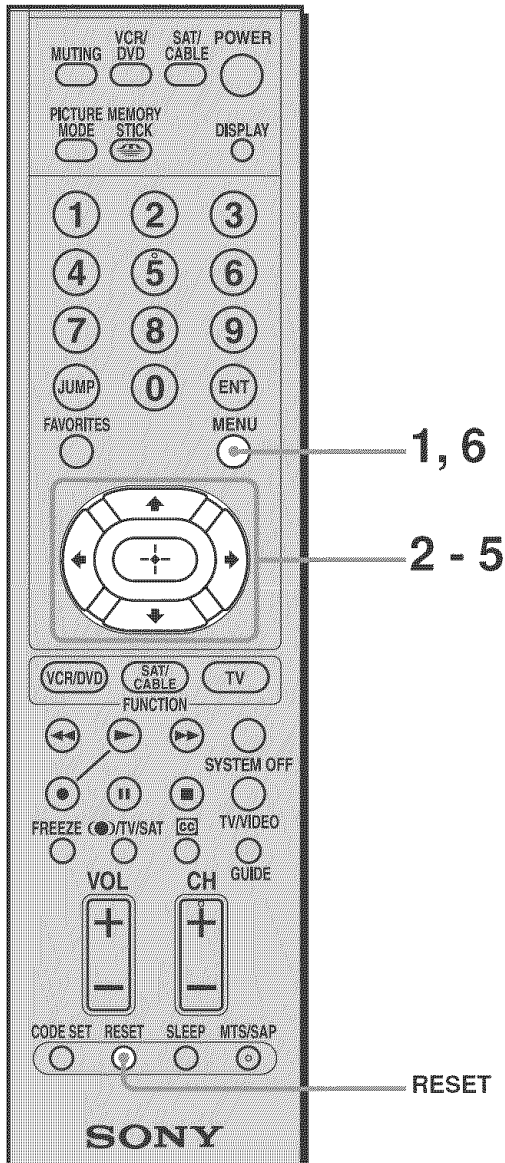

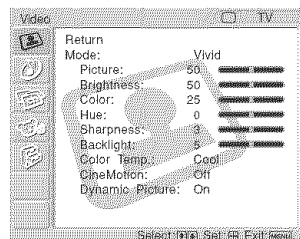

1 Press MENU.



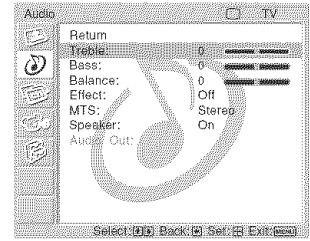
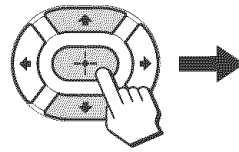

2 Press  to select  (Audio), then press .



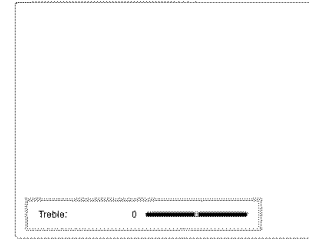
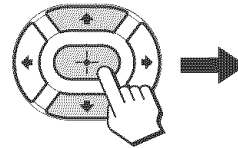

3 Press  to select the option you want to adjust, then press .

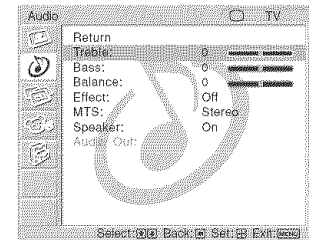
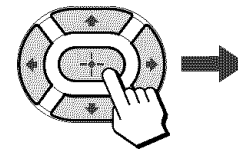

4 Press  to make the desired adjustment, then press .



Option	Press 	Press 
Treble*	To decrease higher-pitched sounds.	To increase higher-pitched sounds.
Bass*	To decrease lower-pitched sounds.	To increase lower-pitched sounds.
Balance*	To emphasize the left speaker.	To emphasize the right speaker.
Effect**	See page 25.	

* To adjust any of these options, set “Speaker” in the  (Audio) menu to “On,” or “Audio Out” to “Variable” first.

** To adjust the option, set “Speaker” in the  (Audio) menu to “On” first.

Tip

You can adjust each option by referring to the value beside each option indicator.

(Continued)

- 5 Repeat steps 3 and 4 to adjust other options.
- 6 Press MENU to exit the menu screen.

To reset to the factory settings

Press RESET while the menu is on the screen and the cursor is located on the right side of any menu item.

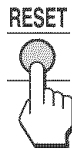

Note

Resetting the unit to the factory settings resets only “Treble,” “Bass” and “Balance.”

Selecting Stereo or Bilingual Programs

You can enjoy stereo, bilingual and mono programs.

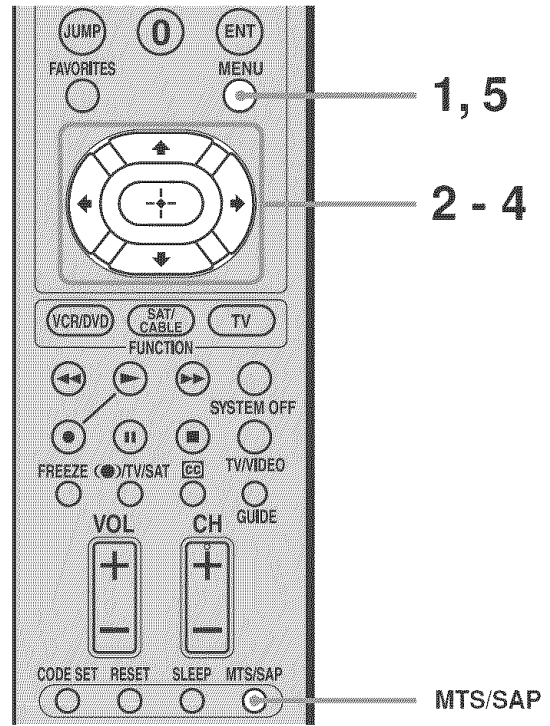

Press MTS/SAP repeatedly until the desired sound indication appears.

Each time you press the button, the sound indication changes as follows:

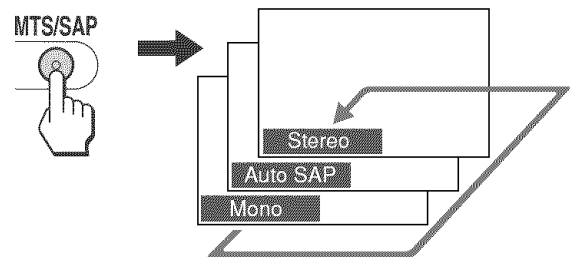

Sound indication*	Description
Stereo	Select for stereo reception when viewing a program broadcast in stereo.
Auto SAP	Select to automatically switch the TV to second audio programs when a signal is received. (If no SAP signal is present, the TV remains in Stereo mode.)
Mono	Select for mono reception. (Use to reduce noise during weak stereo broadcasts.)

* This is available only for TV broadcasting.

Selecting stereo or bilingual programs using the menu

- 1 Press MENU.

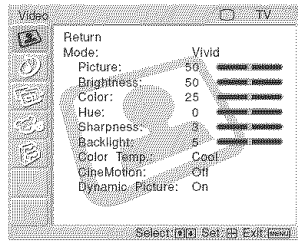
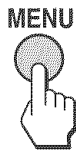

- 2 Press \uparrow/\downarrow to select , then press .

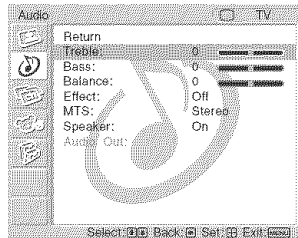
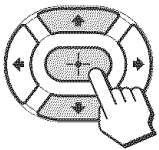

- 3 Press \uparrow/\downarrow to select "MTS," then press .

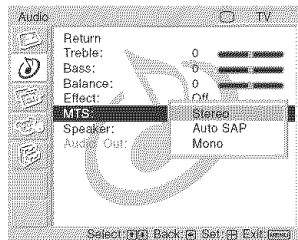
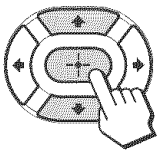

- 4 Press \uparrow/\downarrow to select the desired reception, then press .

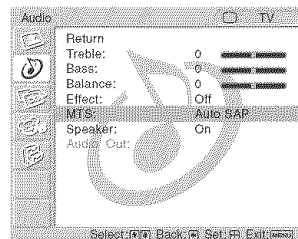
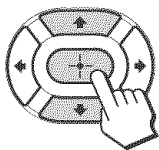

- 5 Press MENU to exit the menu screen.

Using the Parental Control Feature

The TV programs and movies shown on TV are given a rating signal based on the following rating systems.

In U.S.A.: U.S. Television Parental Guidelines to rate television programs (U.S. TV ratings), and Motion Picture Association of America (MPAA) Guidelines to rate movies including those shown on TV (movie ratings).

In Canada: Canadian English Language ratings to rate television programs in English, and Canadian French Language ratings to rate those in French.

To block programs you feel unsuitable for your children, you need to set the TV for the desired rating systems. Sony's predetermined ratings are also available. See page 46 for a description of the ratings.

The TV's Parental Control feature functions by receiving the rating signal from your local broadcasting station or cable service provider.

(Continued)

Activating the Parental Control feature

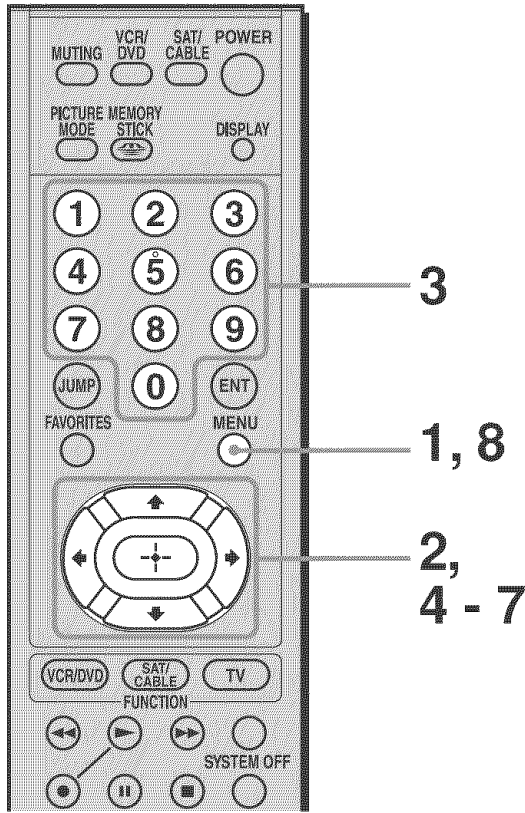

3 Enter a four-digit password using the 0-9 buttons.

The Parent menu options appear.

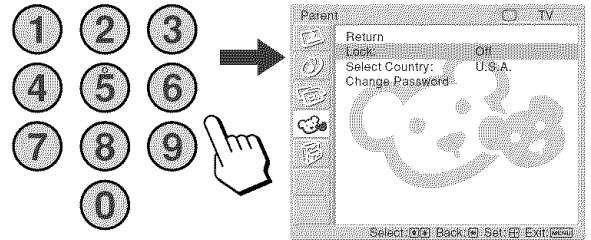

If you access the Parent menu for the first time, you are requested to enter the password again for confirmation.

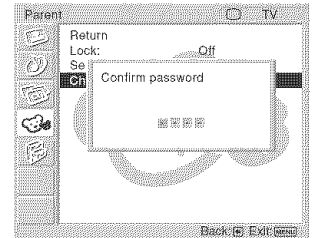

Note

Do not enter "4357" corresponding to "HELP" on a phone number pad (see page 43).

Tips

- You need to enter the password here for any further access into the Parent menu. If you lose your password, see "Tip" on page 43.
- If you want to change the password, see page 43.

1 Press MENU.

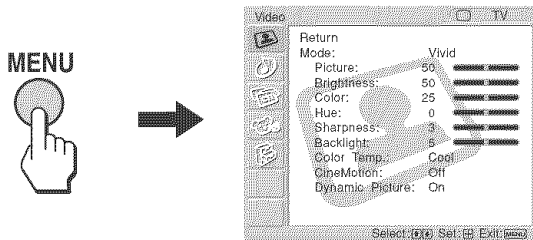

2 Press \uparrow/\downarrow to select (Parent), then press \oplus .

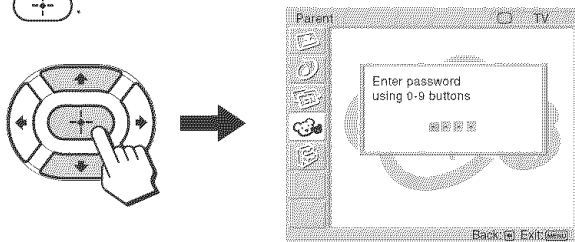

4 Press \uparrow/\downarrow to select "Select Country," then press \oplus .

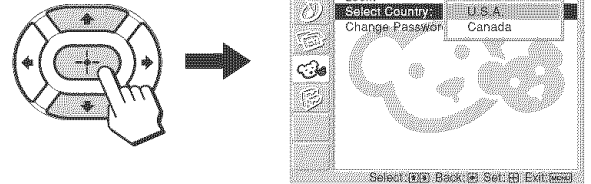

5 Press \uparrow/\downarrow to select your country/region (U.S.A. or Canada), then press \oplus .

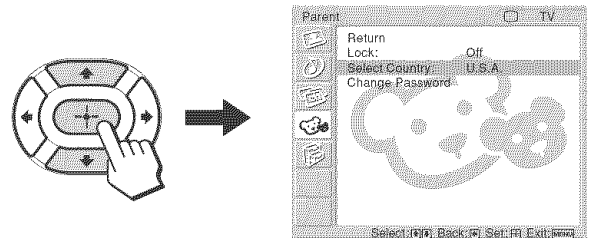

- 6 Press \uparrow/\downarrow to select “Lock,” then press \odot .

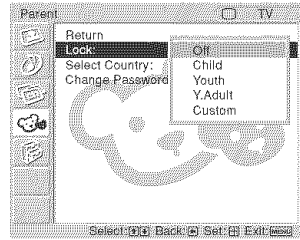
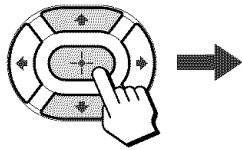

- 7 Press \uparrow/\downarrow to select a desired rating, then press \odot .

If you select “Child,” “Youth,” or “Y.Adult” (Young Adult), the Parental Control is activated automatically.

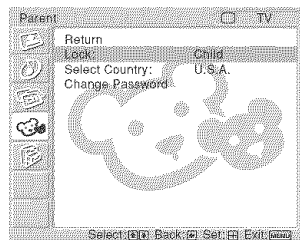
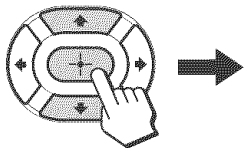

Tip

If you are not familiar with the Parental Guideline rating system, you should select “Child,” “Youth,” or “Y.Adult” to help simplify the rating selection. To set more restrictive ratings, select “Custom” (see “Selecting a Custom Rating” on page 44).

- 8 Press MENU to exit the menu screen.

To view blocked programs

You can view blocked programs by entering the password.

- 1 Press ENT (enter) when tuned to a blocked program.
- 2 Enter your password using the 0-9 buttons.

The Parental Control feature will be canceled temporarily until you turn the TV off.

To deactivate the Parental Control feature

Set “Lock” to “Off” in the \odot (Parent) menu.

To change the password

- 1 Press MENU.
- 2 Press \uparrow/\downarrow to select \odot (Parent), then press \odot .
- 3 Enter your four-digit password using the 0-9 buttons.
The Parent menu options appear.
- 4 Press \uparrow/\downarrow to select “Change Password,” then press \odot .
- 5 Enter a new four-digit password using the 0-9 buttons.
- 6 Enter the password set in step 5 again to confirm.
- 7 Press MENU to exit the menu screen.

Tip

If you have forgotten your password, enter the master password “4357” (corresponding to “HELP” on a phone number pad) in step 3. You can then store a new password.

Notes

- If you entered “4357” as your password for the first time, you cannot store a new password (see step 3 of “Activating the Parental Control feature” on page 42).
- When you select a Parental Control program and the \odot indication is displayed on the screen, you cannot view that program even if you enter “4357” (see “To view blocked programs” on page 43).

(Continued)

Selecting a Custom Rating

If you want to select the ratings to be blocked from “Custom” once you have activated the Parental Control feature (page 42), follow the procedure below.

For a detailed description of each rating, see “What the Ratings Mean” on page 46.

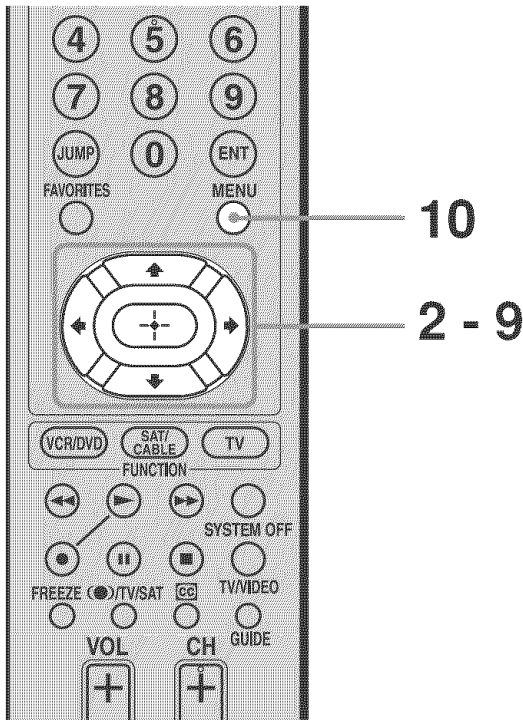

1 Perform steps 1 to 6 in “Activating the Parental Control feature” on page 42 to display the Lock options.

2 Press \uparrow/\downarrow to select “Custom,” then press \oplus .

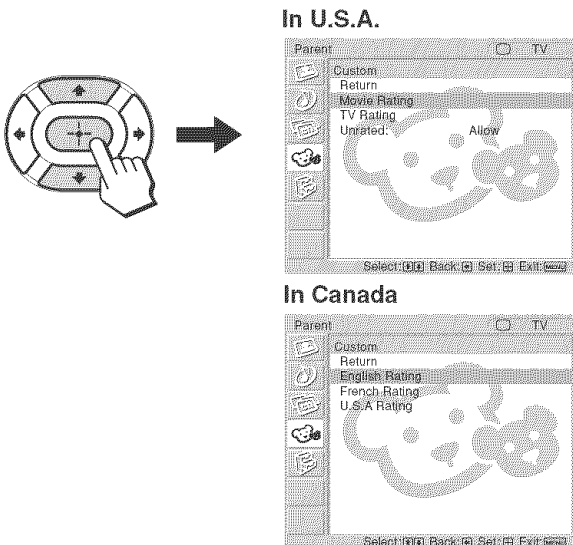

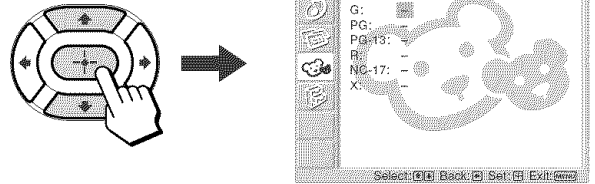

To select a rating in Canada, go to step 6.

3 Press \uparrow/\downarrow to select “Movie Rating,” then press \oplus .



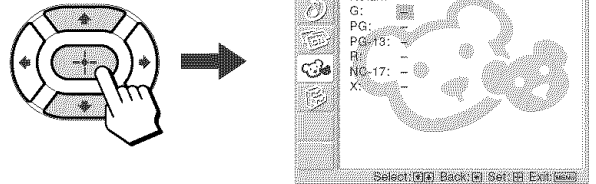

4 Press \uparrow/\downarrow to select the rating to be blocked, then press \oplus .

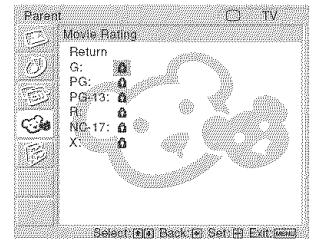

The  indication automatically appears beside the selected rating and all ratings below it, indicating that the programs that match the ratings will be blocked.



To unlock a rating, select , then press \oplus . The  indication changes into “—” and all ratings above it are unlocked.

5 Press \leftarrow to return to the “Custom” menu.

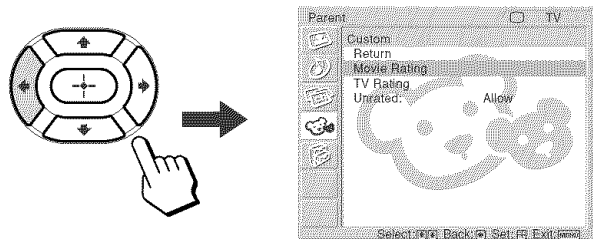

- 6** To select a TV rating in U.S.A.:
Press \uparrow/\downarrow to select “TV Rating,” then press \oplus .

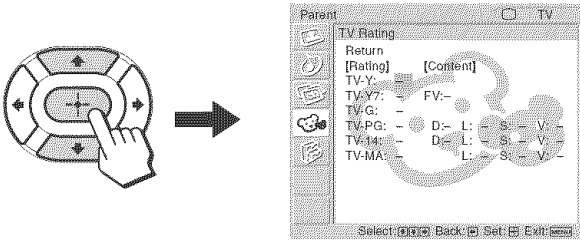

To select a TV rating in Canada:

- Press \uparrow/\downarrow to select “English Rating,” “French Rating,” or “U.S.A. Rating,” then press \oplus .

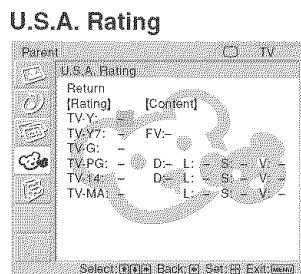
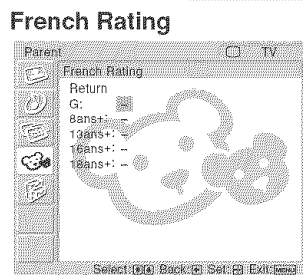
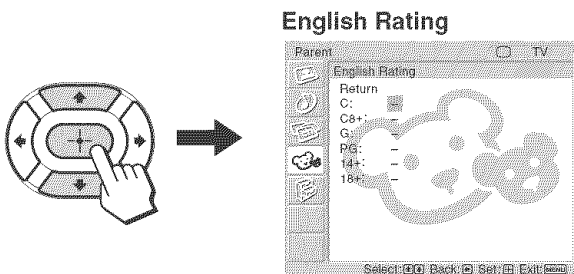

- 7** Press \uparrow/\downarrow to select the TV rating to be blocked, then press \oplus .

The \mathfrak{L} indication automatically appears beside the selected rating and all ratings below it, indicating that the programs that match the ratings will be blocked.

Example: TV rating in U.S.A.

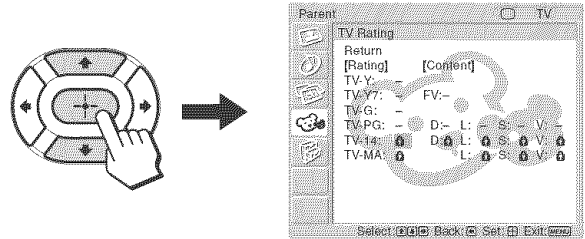

- To unlock a rating, select \mathfrak{L} , then press \oplus .

The \mathfrak{L} indication changes into “-” and all ratings above it are unlocked. Some U.S. TV ratings have additional content ratings called “extenders.”

The extenders are defined as follows:
D (sexually suggestive Dialog), FV (Fantasy Violence), L (coarse Language), S (Sexual situations) and V (Violence).

By setting the extenders, you can define additional viewing limits.

For more details on extenders, see page 48.

All of the extenders included in the selected ratings will be blocked. If you want to allow any of them to be viewed, go to step 8. Otherwise, go to step 10.

- 8** Press \leftarrow/\rightarrow to select the extender to be viewed, then press \oplus .

“-” appears beside the selected extender, indicating that the programs that match the extender can be viewed.

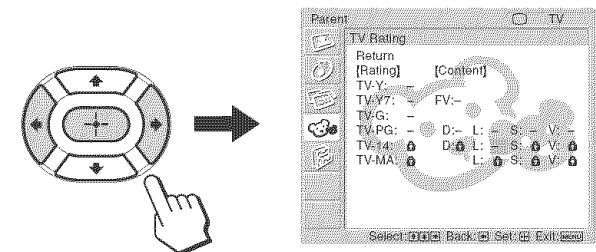

To relock the canceled extender, select \mathfrak{L} .

The \mathfrak{L} indication appears to show that the programs that match the extender will be blocked again.

(Continued)

9 Repeat step 8 for other extenders.

All programs that match the ratings you select and higher, except for the extenders that were canceled, will be blocked.

10 Press MENU to exit the menu screen.**To block programs or movies broadcast without a rating**

Unrated option allows you to block programs or movies that are broadcast without a rating.

The unrated option is available only when you have selected U.S.A. as your country/region.

- 1** Perform steps 1 and 2 of “Selecting a Custom Rating” on page 44.
- 2** Press $\blacktriangle/\blacktriangledown$ to select “Unrated,” then press \oplus .
- 3** Press $\blacktriangle/\blacktriangledown$ to select “Block,” then press \oplus .

Option	Description
Allow	Allows programs and movies that are broadcast without a rating.
Block	Blocks all programs and movies that are broadcast without a rating.

4 Press MENU to exit the menu screen.**Note**

If you choose to block unrated TV programs, be aware that the following types of programs may be blocked: programs broadcast from another country/region, emergency broadcasts, political programs, sports, news, public service announcements, religious programs, and weather.

What the Ratings Mean

Ratings in the U.S.A.

Sony’s predetermined ratings

These are original ratings that Sony has predetermined according to the viewer’s age. Each rating allows for viewing of certain programs, as follows:

Option	Description
Child	Suitable for children under the age of 7. Viewable U.S. movie ratings: G, NR, and N/A Viewable U.S. TV ratings: TV-Y, TV-G, and TV-NR
Youth	Suitable for children aged 7 and older. Viewable U.S. movie ratings: G, PG, NR, and N/A Viewable U.S. TV ratings: TV-Y, TV-Y7, TV-G, TV-PG, and TV-NR
Y.Adult (Young Adult)	Suitable for children aged 13 and older. Viewable U.S. movie ratings: G, PG, PG-13, NR, and N/A Viewable U.S. TV ratings: TV-Y, TV-Y7, TV-G, TV-PG, TV-14, and TV-NR

For descriptions of Child, Youth, and Y.Adult (Young Adult) ratings, see the following custom rating options.

U.S. movie ratings

U.S. movie ratings are for movies (including those shown on TV) rated according to the Motion Picture Association of America (MPAA) Guidelines.

Option	Description
G (General Audiences — All Ages Admitted)	In G-rated films, no strong words are used, the violence is at a minimum, nudity and sex scenes are not present, nor is there any drug use.
PG (Parental Guidance Suggested — Some Material May Not Be Suitable For Children)	This is a film which may need to be monitored first by parents.
PG-13 (Parents Strongly Cautioned — Some Material May Be Inappropriate For Children Under 13)	Parents are alerted to be very careful about the attendance of their under-teenage children when viewing.
R (Restricted — Under 17 Requires Accompanying Parent Or Adult Guardian)	This film includes hard language, tough violence, nudity, drug abuse or other elements of concern.
NC-17 or X (No One 17 And Under Admitted)	This is a film that most parents would consider not suitable for children aged 17 and under. There may be violence, sex, abhorrent behavior, drug abuse or other elements of concern.

U.S. TV ratings

U.S. TV ratings are for TV programs rated according to the U.S. Television Parental Guidelines.

Option	Description
TV-Y (All Children)	This program is designed for young children aged 2 - 6 and is appropriate for all children.
TV-Y7 (Directed to Older Children)	This program is designed for children aged 7 and older. Themes and elements in this program may include mild fantasy violence or slapstick violence, or may frighten children under the age of 7.
TV-G (General Audience)	Most parents would find this program suitable for all ages. It contains little or no violence, no strong language and little or no sexual dialog or situations.
TV-PG (Parental Guidance Suggested)	This program contains some material that parents may find unsuitable for younger children.
TV-14 (Parents Strongly Cautioned)	This program contains some material that many parents would find unsuitable for children under the age of 14.
TV-MA (Mature Audience Only)	This program is specifically designed to be viewed by adults and therefore may be unsuitable for children under the age of 17.

(Continued)

About the extenders of U.S. TV ratings

TV-Y7, TV-PG, TV-14 and TV-MA ratings have additional content ratings called “extenders” to define additional viewing limits. The extenders are defined as follows:

Option	Description
FV (Fantasy Violence)	Programs containing cartoon violence occurring in TV-Y7 programs only.
D (sexually suggestive Dialog)	Programs containing suggestive dialog, or sexual innuendo.
L (coarse Language)	Programs containing coarse language.
S (Sexual situations)	Programs containing sexual content.
V (Violence)	Programs containing violence. There may be some profanity, violence or brief nudity in these programs.

Ratings in Canada

Sony’s predetermined ratings

These are original ratings that Sony has predetermined according to the viewer’s age. Each rating allows you to view the certain programs, as follows:

Option	Description
Child	Suitable for children under the age of 8. Viewable Canadian English Language ratings: C and G Viewable Canadian French Language ratings: G Viewable U.S. TV ratings: TV-Y, TV-G, and TV-NR
Youth	Suitable for children aged 8 and older. Viewable Canadian English Language ratings: C, G, C8+, and PG Viewable Canadian French Language ratings: G and 8 ans+ Viewable U.S. TV ratings: TV-Y, TV-Y7, TV-G, TV-PG, and TV-NR
Y.Adult (Young Adult)	Suitable for children aged 14 and older. Viewable Canadian English Language ratings: C, G, C8+, PG, and 14+ Viewable Canadian French Language ratings: G, 8 ans+, and 13 ans+ Viewable U.S. TV ratings: TV-Y, TV-Y7, TV-G, TV-PG, TV-14, and TV-NR

For descriptions of Child, Youth, and Y.Adult (Young Adult) ratings, see the following custom rating options.

Canadian English Language ratings

The Canadian English Language ratings are for TV programs in English broadcast in Canada.

Option	Description
C (Programming intended for children under the age of 8)	There will be no realistic scenes of violence or no offensive language, nudity or sexual content. Careful attention is paid to themes, which could threaten children's sense of security and well-being.
C8+ (Programming generally considered acceptable for children aged 8 and older to watch on their own)	Violence will not be portrayed as the preferred, acceptable, or only way to resolve conflict; or children will not be encouraged to imitate dangerous acts which they may see on television. There will be no profanity, nudity or sexual content.
G (General Audience)	Will contain very little violence, either physical or verbal or emotional. There may be some inoffensive slang, no profanity and no nudity.
PG (Parental Guidance)	Programming intended for a general audience but which may not be suitable for younger children. Parents may consider some content inappropriate for unsupervised viewing by children aged 8 - 13.
14+ (Programming contains themes or content which may not be suitable for viewers under the age of 14)	Parents are strongly cautioned to exercise discretion in permitting viewing by pre-teens and early teens.
18+ (Adult)	May contain violence integral to the development of the plot, character or theme, intended for adult audiences. May contain graphic language and explicit portrayals of nudity and/or sex.

Canadian French Language ratings

The Canadian French Language ratings are for TV programs in French broadcast in Canada.

Option	Description
G (General)	Programming intended for audience of all ages. Contains no violence, or the violence it contains is minimal or is depicted appropriately with humor or caricature or in an unrealistic manner.
8 ans+ (8+ General — Not recommended for young children)	Programming intended for a broad audience but contains light or occasional violence that could disturb young children. Viewing with an adult is recommended for young children (under the age of 8).
13 ans+ (Programming may not be suitable for children under the age of 13)	Viewing with an adult is strongly recommended for children under the age of 13.
16 ans+ (Programming is not suitable for children under the age of 16)	Contains frequent scenes of violence or intense violence.
18 ans+ (Programming restricted to adults)	Contains constant violence or scenes of extreme violence.

Turning Off the TV Automatically

You can set the TV to turn off automatically after a predetermined period of time (15, 30, 45, 60, or 90 minutes).

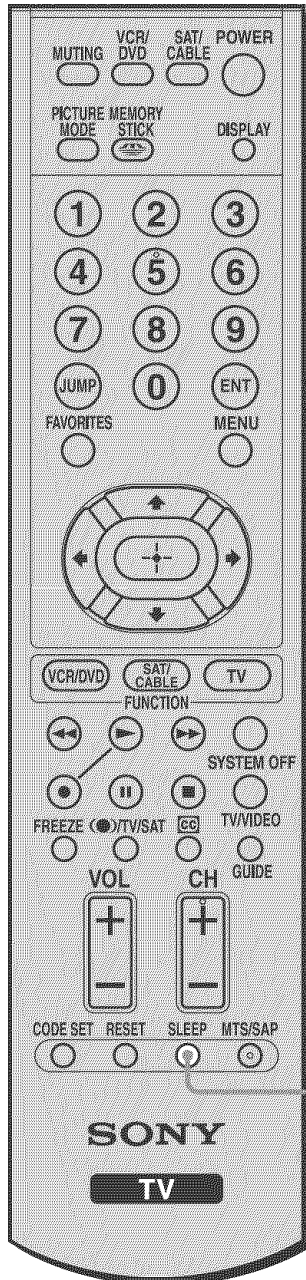

Press SLEEP repeatedly until the desired period of time appears.

Each time you press the button, the period of time changes as follows:

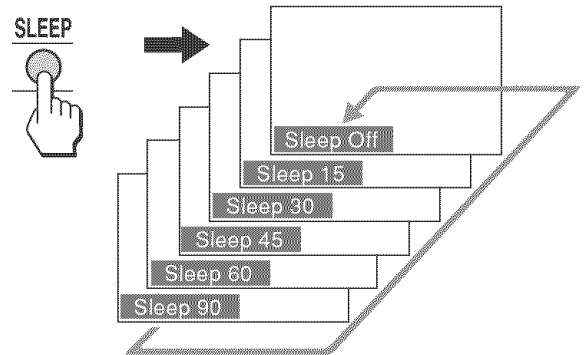

While the Sleep timer is activated, the  (Standby/Sleep) indicator on the TV lights up in red.

To cancel the Sleep timer

Press SLEEP repeatedly until “Sleep Off” appears.

Tips

- If you turn the TV off, and then turn it on again, the Sleep timer returns to “Off.”
- “TV will turn off soon” appears one minute before the TV shuts off. This message may not appear if you perform any operation with the menu opened.

“Memory Stick”

About the “Memory Stick”

What is a “Memory Stick”?

A “Memory Stick” is a compact, portable and versatile Integrated Circuit recording medium with a data storage capacity that exceeds that of a floppy disk. A “Memory Stick” is specially designed for exchanging and sharing digital data among “Memory Stick” compatible products. Because it is removable, the “Memory Stick” can also be used for external data storage.

“Memory Stick” media are available in two sizes: a standard size and a compact “Memory Stick Duo” size. Once attached to a Memory Stick Duo adapter, the “Memory Stick Duo” is physically the same size as a standard “Memory Stick” and thus can be used with products compliant with the standard “Memory Stick.”

Tip

The “Memory Stick” feature allows you to view digital images that are stored on “Memory Stick” media on your TV screen.

Picture viewer

This TV’s “Memory Stick” picture viewer can display digital photo (JPEG) and movie (MPEG1) files stored on a “Memory Stick.” You can also run a Slide Show of those images, and customize the features of the Slide Show by selecting automatic or manual Slide Show.

Digital Camera Mode

This TV’s Digital Camera Mode can display only images using the JPEG or MPEG1 formats, recorded on a DCF-compliant digital camera.

Supported image types

Recorded images must meet the following specifications:

- Digital photos (JPEG files): JPEG* compression format and DCF** compliant folder and file names.
- Movies (MPEG1 files) must be recorded on a Sony digital camera and use one of the following MPEG1*** compression formats: MPEG MOVIE, MPEG MOVIE AD, MPEG MOVIE EX, MPEG MOVIE HQ, MPEG MOVIE CV, MPEG MOVIE HQX, MPEG1 (corresponding to VIDEO CD) for VAIO Giga Pocket

- * JPEG is a standard technology format for compressing a still image (extension .jpg). JPEG stands for “Joint Photographic Experts Group,” which is the organization that implemented this format.
- ** DCF stands for “Design rules for Camera File systems,” which has specifications established by the Japan Electronics and Information Technology Industries Association (JEITA).
- *** MPEG is a format for compressing a moving image (extension .mpg).

Unsupported image types

- Digital photos stored in TIFF or any other non-JPEG compression format
- Digital photos recorded using products that are not DCF-compliant, including the following Sony products
 - Digital still cameras DSC-D700, DSC-D770
 - Digital video cameras DCR-TRV900/DSR-PD100A
- The following digital photos stored in JPEG compression format
 - Images that were processed on a PC
 - Images in folders that were modified or renamed on a PC
 - Images stored in a “Memory Stick” that was formatted on a PC
 - Images less than 16 dots wide or high
 - Images more than 4,096 dots wide or high

Notes on use

- We recommend that you back up important data on the hard disk of your PC. Sony cannot be responsible for any lost or damaged data.
- Use of some pre-recorded image data except for personal use may be an infringement of copyright.
- The “Memory Stick” application software may be modified or changed by Sony without prior notice.

Notes on "Memory Stick Duo"

- To use a "Memory Stick Duo" with this unit, attach it to the Memory Stick Duo adapter before inserting it into the unit.
- Make sure that you attach the "Memory Stick Duo" to the adapter correctly.
- Make sure that you insert the Memory Stick Duo adapter correctly, otherwise the unit may be damaged.
- Do not insert the Memory Stick Duo adapter without a "Memory Stick Duo" attached. Doing so may result in malfunction of the unit.

On handling the "Memory Stick"

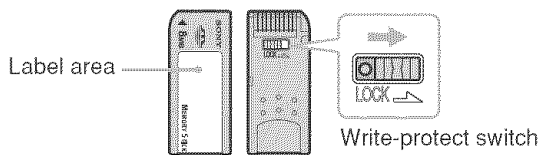

- You cannot record or erase images when the write-protect switch on the "Memory Stick" is set to LOCK.
- Image data may be damaged in the following cases:
 - If you remove the "Memory Stick," or turn the power off while the access lamp is lit or flashing.
 - If you use the "Memory Stick" near magnets or magnetic fields, such as speakers.
 - If you unplug the AC power cord while the access lamp is lit or flashing.
- Avoid touching the terminal of "Memory Stick" media or coming in contact with a metal object.
- Do not drop, bend, or submit "Memory Stick" media to external shock.
- Do not disassemble or modify "Memory Stick" media.
- Avoid getting liquid on "Memory Stick" media.
- Apply labels only within the designated label area.
- To avoid permanent damage to digital photo or movie, do not use or store "Memory Stick" media in a location subject to:
 - High temperature (such as near a heater or inside a hot car)
 - High humidity
 - Direct sunlight
 - Corrosive substances
 - Magnetic fields
 - Excessive dust
 - Static electricity or electric noise
 - Electric surges

- Store and carry "Memory Stick" media in its original case to ensure protection of stored data.
- Save a backup or stored data.

On formatting the "Memory Stick"

The "Memory Stick" is shipped with an exclusive standard format. A "Memory Stick" formatted by a computer does not have a guaranteed compatibility with this TV.

When the access lamp is lit or flashing

When the access lamp is lit or flashing, the "Memory Stick" is reading or writing data. In this case, do not shake or strike the TV, turn the power off, or eject the "Memory Stick," otherwise the image data may be damaged.

Features of the Memory Stick Home

You can view files on a "Memory Stick" recorded and saved by a digital camera or a digital video camera recorder using this TV.

Insert the "Memory Stick" into the TV, and you can perform the following operations using the remote control.

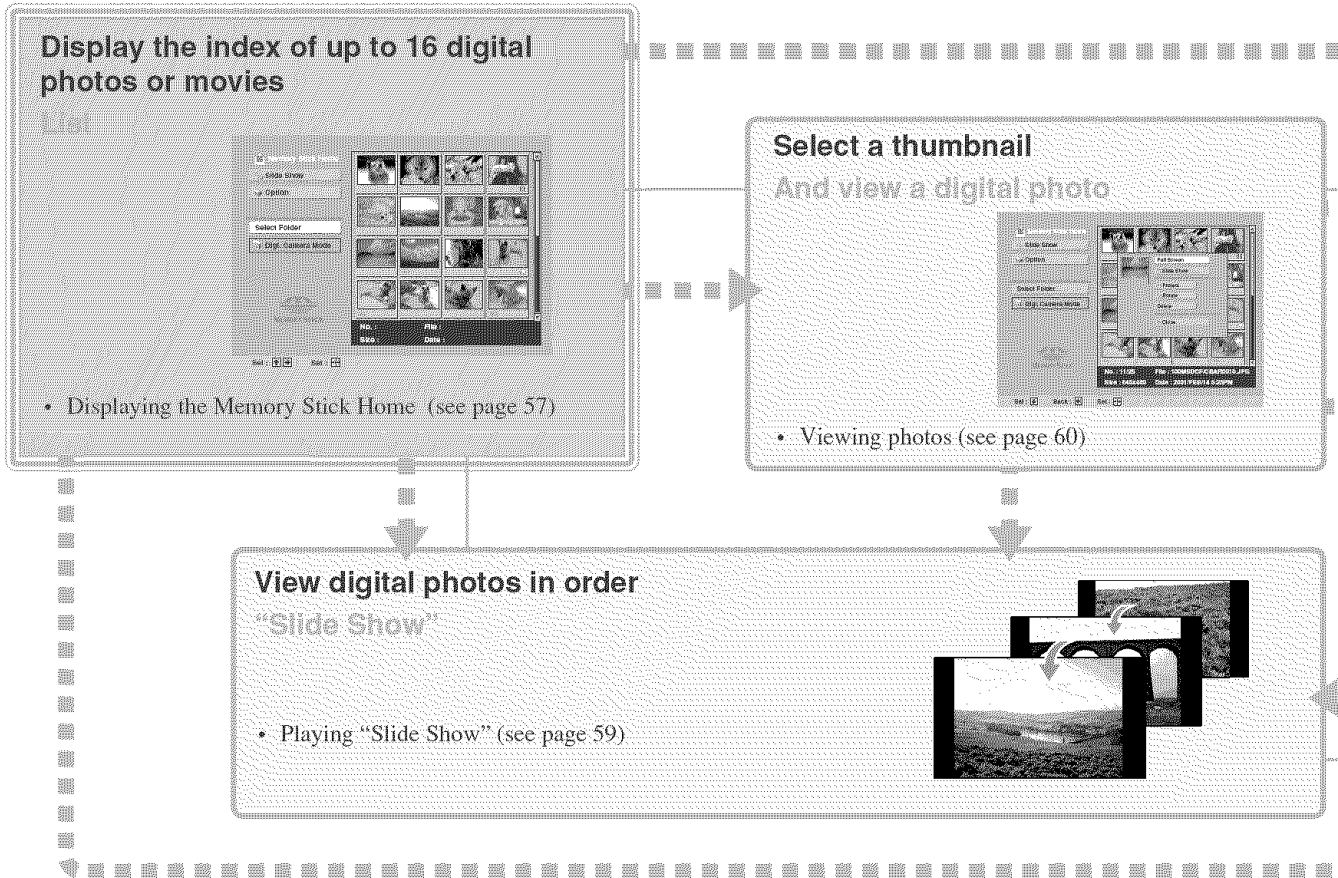

Avoid accidental erasure of your favorite digital photos and movies

"Protect"

- Protect your digital photos and movies (see page 63)
- Protect full screen digital photos (see page 64)
- Protect full screen "Movie Player" movies (see page 64)

Delete unwanted digital photos and movies

"Delete"

- Delete digital photos or movies (see page 65)
- Delete full screen digital photos (see page 65)
- Delete full screen "Movie Player" movies (see page 65)

Check the remaining storage capacity of a "Memory Stick"

Just look at the indicator

- Check the status of the "Memory Stick" (see page 66)

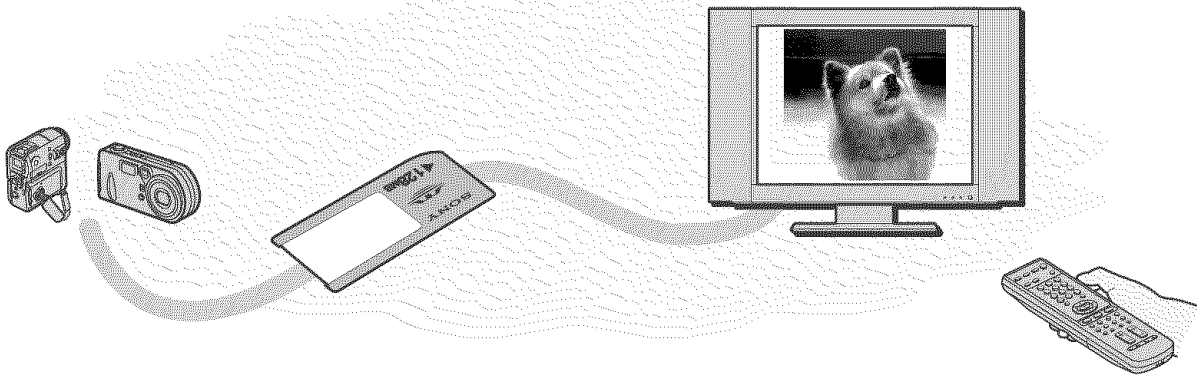

Rotate and view at a different angle

- You can rotate your digital photos shot sideways (see page 61)

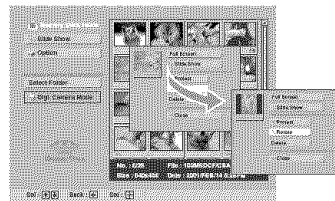

Expand and watch digital photos and movies using the full television screen



- You can view digital photos "Full Screen" (see page 60)
- You can watch movies "Full Screen" (see page 63)

Watch movies "Movie Player"

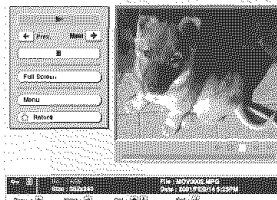

- Playing Movies ("Movie Player") (see page 62)

With "Digi. Camera Mode" set to "Off" (see page 67), you can;

View digital photos and movies organized into albums and stored in folders on a PC

"Select Folder"

- Select a folder (see page 67)

Change the order of your images

"Sort"

- Sort your images (see page 68)

Choose just what you want to see, digital photos only or movies only

"Filter"

- Selectively display either digital photos or movies (see page 69)

Inserting and Removing a “Memory Stick”

Inserting a “Memory Stick”

Insert the “Memory Stick” into the Memory Stick slot with the ◀ mark facing forward as illustrated below until it clicks. The “Memory Stick” access lamp flashes, then goes out.

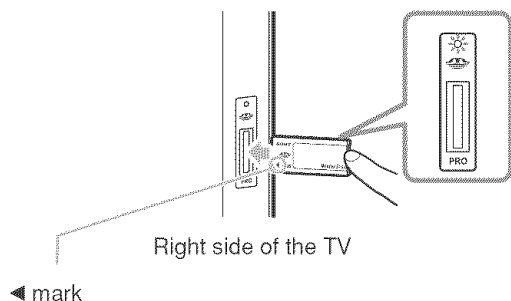

Notes

- Be sure to insert the “Memory Stick” correctly. If the “Memory Stick” is forced in the wrong way, the “Memory Stick” or the slot may be damaged.
- Insert only a “Memory Stick” into the Memory Stick slot. Attempting to insert other objects into the slot may damage the TV.
- To use a “Memory Stick Duo,” be sure to attach it to the Memory Stick Duo adapter before inserting it into the Memory Stick slot. Inserting a Memory Stick Duo adapter without a “Memory Stick Duo” may damage the Memory Stick slot.

Removing a “Memory Stick”

- 1 Check that the “Memory Stick” access lamp is off, then push the “Memory Stick” gently into the Memory Stick slot and then release it. The “Memory Stick” is ejected.

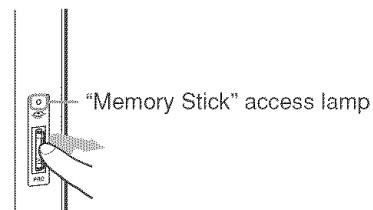

Right side of the TV

Tip

The  (“Memory Stick”) indicator on the front panel of the TV works in the same manner as the “Memory Stick” access lamp does.

- 2 Pull the “Memory Stick” completely out of the Memory Stick slot.

Notes

- Do not turn the power off while the “Memory Stick” access lamp is lit or flashing in red. If you do so, the image data in “Memory Stick” may be damaged.
- When removing the “Memory Stick,” do not attempt to just pull it from the Memory Stick slot. If you do so, the “Memory Stick” or the slot may be damaged.
- There is a mechanism inside the Memory Stick slot to prevent the “Memory Stick” from popping out. This may prevent the “Memory Stick” from coming out smoothly. If this happens, do not pull the “Memory Stick” out forcibly. Pull it out straight towards you. Otherwise, the “Memory Stick” may be damaged.
- To protect small children from injury from “Memory Stick,” remove any “Memory Stick” from the TV’s Memory Stick slot and store it in a safe location when it is not in use.

Displaying the Memory Stick Home

The Memory Stick Home feature allows you to display an index of thumbnail images that are on the "Memory Stick." You can select an image from those to display on the full screen, play back a movie, or run a "Slide Show."

Displaying the Memory Stick Home

The default setting for "Digi. Camera Mode" is "On."

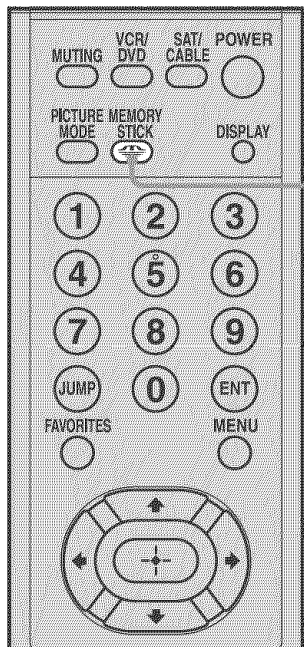

2
 ("Memory Stick") button

1 Insert a "Memory Stick" that contains the images you want to view.

2 Press ("Memory Stick") on the remote control.
 The Memory Stick Home appears on the screen.

Index of thumbnail images contained in the selected folder

Press /// to select an image. The selected image is highlighted in yellow.

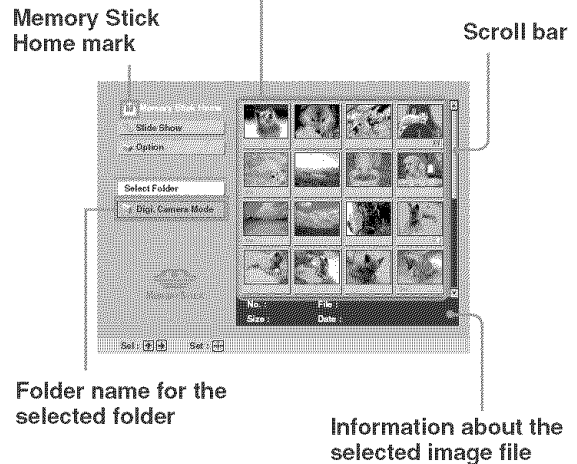

Tip
 To close the Memory Stick Home, press ("Memory Stick") again.

(Continued)

The Memory Stick Home – A one-stop list for all of your digital photos and movies

For details on the menu operations for each button, see the explanations provided below.

Cursor (indicates the currently selected file)
A yellow frame is displayed, and you can move it around using $\blacktriangle/\blacktriangledown/\blacktriangleleft/\blacktriangleright$ on the remote control.

"Slide Show" button
Displays digital photos and movies in the order they are stored on the "Memory Stick."

"Option" button
Displays file sort or "Memory Stick" information.

"Select Folder" button
Allows you to select a folder or to set "Digi. Camera Mode" to "ON" or "OFF."

Displayed when "Digi. Camera Mode" is set to "ON." When it is set to "OFF," the name of the folder that is selected is displayed.

Information bar
Provides information on the digital photo or movie currently selected by the cursor.

No.: Order/Total number of images
Size: Resolution

File: File name and file type
Date: Recorded date

Marks indicated in the lower part of an image





Icon	File status
	Moving image icon Indicates that this file is a movie file.
	Protected file icon Indicates that protection (Protect) has been set for this image.
	Related file icon (displayed only when "Digi. Camera Mode" is set to "On") Indicates that more files (same in the last 4 figures of their file names) are hidden.*

* The file indicated with Related file icon is automatically selected. The selection depends on the file format (JPEG → MPEG → other file formats, in the order of priority.)

Note

When you delete a file showing the Related file icon, the related file(s) will be deleted as well.

Playing "Slide Show"

- 1 Insert a "Memory Stick" that contains the images you want to view.
Be sure to insert the "Memory Stick" correctly (see page 56).
- 2 Press  ("Memory Stick") on the remote control.
The Memory Stick Home appears on the screen.
- 3 Press \uparrow/\downarrow to select "Select Folder," then press .
The Select Folder menu appears.
- 4 Press \rightarrow to select the list of contents, then press \uparrow/\downarrow to select a folder that you want to view, then press .
An index of thumbnail images in the selected folder appears.
- 5 Press \uparrow/\downarrow to select "Slide Show," then press .
The index menu for "Slide Show" appears. You can select any of the following options. Press \uparrow/\downarrow to select the option, then press .

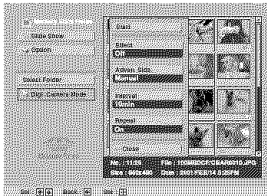

- Effect:** Sets the slide advancement.
Select one from "Wipe," "Blinds" and more.
- Advan. Slids.:** Sets "Slide Show" to run automatically ("Auto") or manually ("Manual").
- Interval:** Selects the period for which one image is displayed from "1sec," "5sec," "10sec," "20sec," "30sec," "40sec," "50sec," "1min," "2min," "3min," "5min," or "10min."
- Repeat:** Select "On" to repeat "Slide Show." After the last digital photo or movie has been displayed, the "Slide Show" starts again from its first digital photo or movie follows.

Notes

- The time is approximate.
- When "Advan. Slids." is set to "Manual," the "Interval" is not available.

- 6 Press \uparrow/\downarrow to select "Start," and then .

If you select "Auto" in the "Advan. Slids.," "Slide Show" runs automatically. When the "Slide Show" comes to its end, another "Slide Show" starts automatically.

If you select "Manual," "Slide Show" would not run automatically. When "Slide Show" ends, press \leftarrow/\rightarrow to select a digital photo or movie from which the next "Slide Show" starts.



To stop "Slide Show"

If you want to stop "Slide Show," do the following to return to the Memory Stick Home.

If you have set "Advan. Slids." to "Auto"

Press .

If you have set "Advan. Slids." to "Manual"

Press  to display the index menu for "Slide Show," then press \uparrow/\downarrow to select "Return," then press .

Viewing Photos

Viewing digital photos at full-screen size

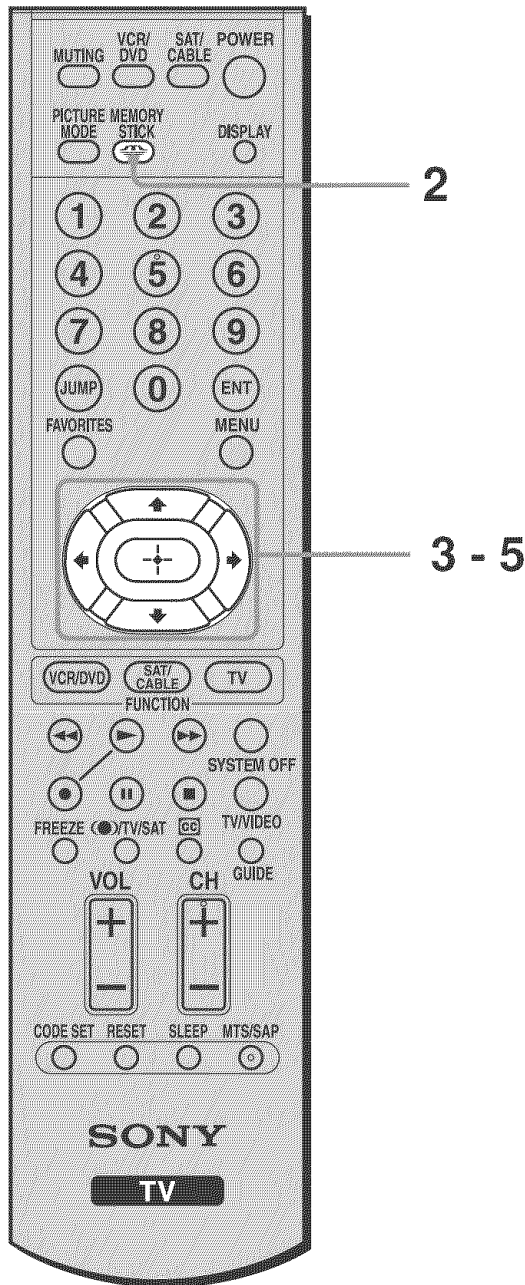

1 Insert a "Memory Stick" into the Memory Stick slot.
Be sure to insert the "Memory Stick" correctly (see page 56).

2 Press ("Memory Stick") and the Memory Stick Home screen appears.

3 Press /// to select the digital photo you want to see, then press .
The Index menu appears.

The Index menu

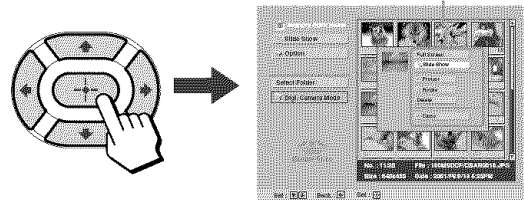

4 Press / to select "Full Screen," then press .
The digital photo you selected will be displayed at full-screen size.

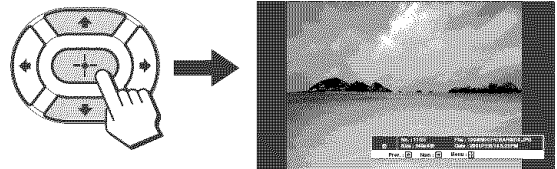

To view previous or subsequent files with the screen at full-screen size, press /.

5 Press .
The Digital Photo menu appears.

The Digital Photo menu

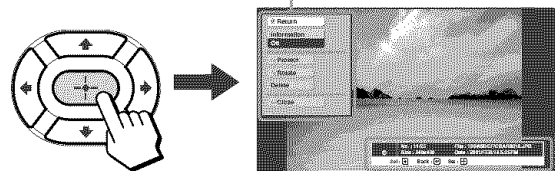

The Information Bar

To view other files that are not in this series of photos, press to select "Return," then press to return to the Memory Stick Home.

Tip

The information on the current photo is displayed at the bottom right of the screen as factory default setting. To view photos without the information displayed, select "Information" in the Digital Photo menu, then select "Off."

Notes

- The quality of the photo display when enlarged depends on the resolution of the file. See your digital camera instruction manual for details.
- Some files may take longer to display at full-screen size.

Rotating and viewing your digital photos

You can rotate digital photos in 90 degree increments clockwise or counterclockwise.

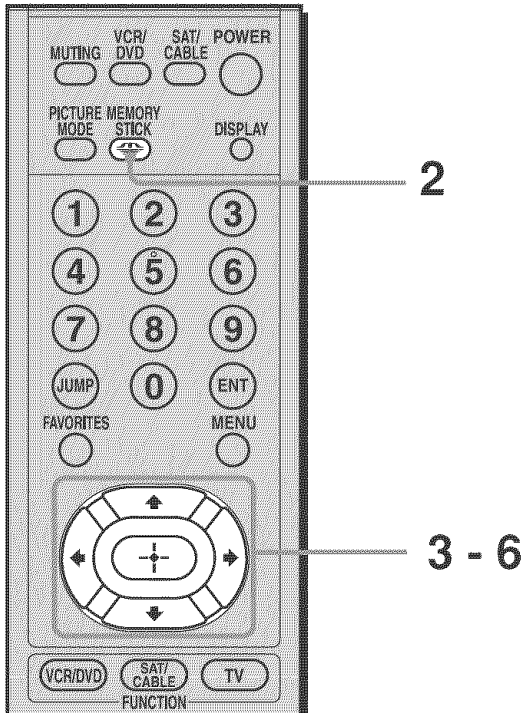

- 1 Insert a "Memory Stick" into the Memory Stick slot.
Be sure to insert the "Memory Stick" correctly (see page 56).
- 2 Press ("Memory Stick"), and the Memory Stick Home screen appears.
- 3 Press /// to select the photo you want to rotate, then press .
The Index menu appears.

The Index menu

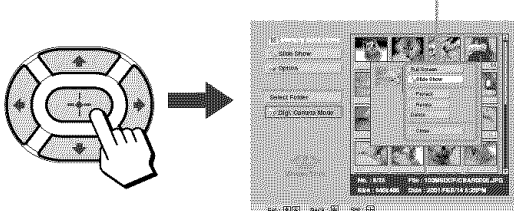

- 4 Press / to select "Rotate," then press .
- 5 Press / to select either (rotate to the right/clockwise) or (rotate to the left/counterclockwise) for the direction in which to rotate the photo, then press .
Each time you press , the photo rotates 90 degrees in the direction you selected.
- 6 Press to select "Close," then press .
The photo will be saved in the rotated position shown on the screen.

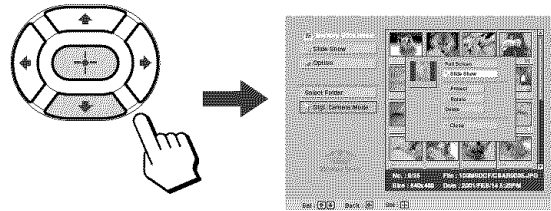

Rotating a photo shown at full-screen size

- 1 With a photo shown on the TV screen at full-screen size (see page 60), press .
The Digital Photo menu appears.
- 2 Press / to select "Rotate," then press .
- 3 Press / to select the direction in which you want to rotate the photo, then press .
Each time you press , the photo rotates 90 degrees in the direction you selected.
- 4 Press to select "Close," then press .

Notes

- Only digital photos can be rotated.
- Protected photos (see page 63) cannot be rotated. Check to see if there is a Protected file icon on the Information Bar. If you want to rotate a protected file, you must first remove the protection.
- If the write-protect switch on the "Memory Stick" you are using is set to LOCK, you will not be able to rotate the photo.

Playing Movies ("Movie Player")

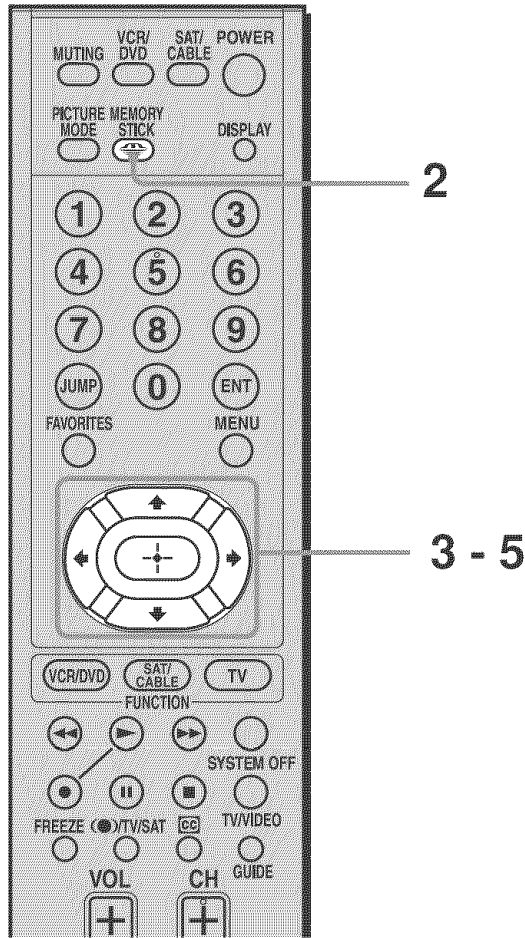

- 1 Insert a "Memory Stick" into the Memory Stick slot.
Be sure to insert the "Memory Stick" correctly (see page 56).
- 2 Press ("Memory Stick"), and the Memory Stick Home screen appears.
- 3 Press /// to select the movie you want to view, then press .
The Index menu appears.

The Index menu

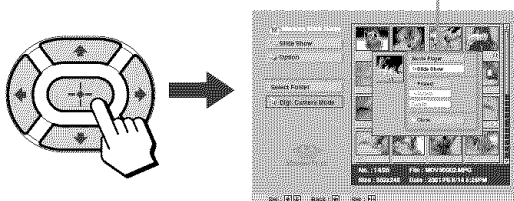

- 4 Press / to select "Movie Player," then press .
The Movie Player screen appears.

The Movie Player screen

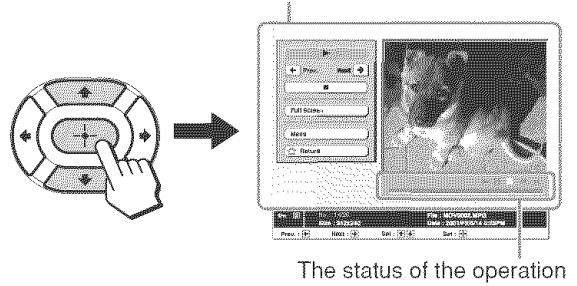

The status of the operation

- 5 Press / to select on the Movie Player screen, then press .
The movie begins to play. When the movie is finished, the screen returns to the beginning of the movie, and stops. If you want to stop the movie while it is playing, press / to select , then press .

The Movie Player menu and its operation

Menu	Operation
Return	Returns to the Memory Stick Home screen.
Play/Pause	Plays a movie. If you press it again while a movie is playing, the movie is paused.
Stop	Stops the movie.
Full Screen	Expands the image to fill the entire screen.
Menu	Displays menu.
Reverse (Fast Reverse)	Press once while the movie is stopped to return to the previous screen.* Press while movie is playing to play movie backwards at a higher speed.
Forward (Fast Forward)	Press once while movie is stopped to advance to the next screen.* Press while movie is playing to play faster.

* If you press / again while the movie is stopped, and the screen moves to the next movie, it may take some time for that movie to begin playing. During that time, the Return button lights, and the movie is read into memory. If you press at this time, the display returns to the Memory Stick Home screen.

To switch the voice channel

- 1 Press \uparrow/\downarrow to select "Menu" on the Movie Player screen, then press \oplus .
The Movie menu appears.
- 2 Press \uparrow/\downarrow to select "Audio Select," then press \oplus .
- 3 Press \uparrow/\downarrow to select the item you want to set, then press \oplus .

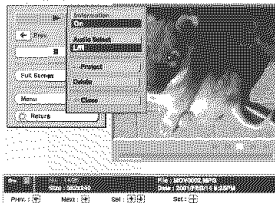

The items that can be set, and the channel that will be heard

Items	For stereo	For the alternative voice track
L/R	Both left and right	Main and alternative voice channels
L	Left voice channel	Main voice channel
R	Right voice channel	Alternative voice channel

Note

When there is no voice track included in the movie, "Audio Select" cannot be selected.

To view the movie at full-screen size

- 1 Perform steps 1 to 4 on page 62, and the Movie Player screen appears.
- 2 Press \uparrow/\downarrow to select "Full Screen" on the Movie Player screen, then press \oplus .
The movie is displayed at full-screen size, and begins to play.

To return to the Movie Player screen

While the movie is playing, press $\uparrow/\downarrow/\leftarrow/\rightarrow$, or press \oplus .

Notes

- If the screen size at which the movie was shot is small, even if you select "Full Screen," the movie may not play at full-screen size.
- Depending on the movie you are playing, it may look rough and grainy if you play it at full-screen size.
- Depending on the file, it may take some time to display the image at full-screen size.
- When you are playing a movie at full-screen size, Fast Forward and Fast Reverse features are not available.

Protecting/Deleting the Files

Protecting digital photos or movies

You can protect the photos and movies from accidental erasure by protecting them. You can also remove protection from digital photos or movies that you have previously protected.

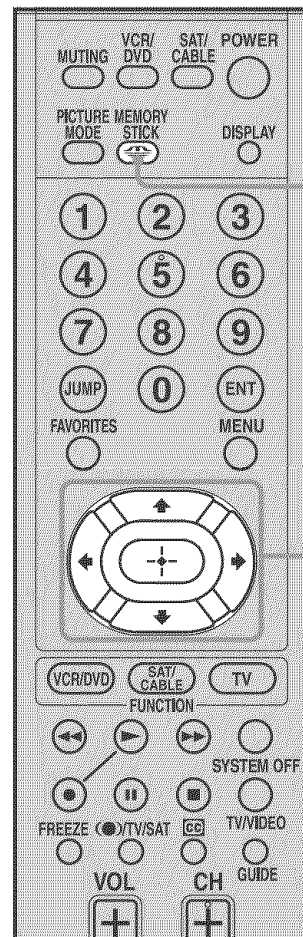

- 1 Insert a "Memory Stick" into the Memory Stick slot.
Be sure to insert the "Memory Stick" correctly (see page 56).
- 2 Press Memory Stick icon ("Memory Stick"), and the Memory Stick Home screen appears.

(Continued)

- 3 Press $\uparrow/\downarrow/\leftarrow/\rightarrow$ to select the image you want to protect, then press + .
The Index menu appears.

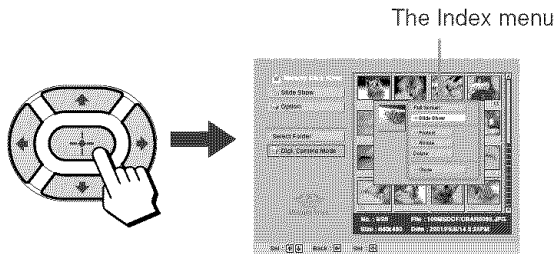

- 4 Press \uparrow/\downarrow to select "Protect," then press + .

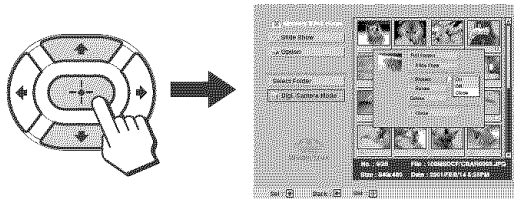

- 5 Press \uparrow/\downarrow to select "On," then press + .

A Protected file icon  appears.

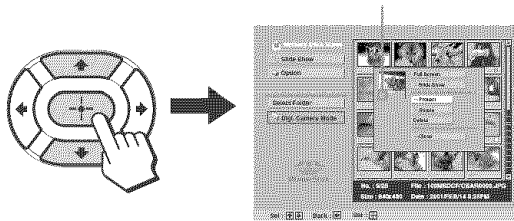

To remove protection, select "Off," then press + .

To protect a digital photo shown at full-screen size

- 1 While the digital photo is being displayed at full-screen size (see page 60), press + .
The Digital Photo menu appears.
- 2 Press \uparrow/\downarrow to select "Protect," then press + .
- 3 Press \uparrow/\downarrow to select "On," then press + .

To protect a movie from the Movie Player screen

- 1 With the Movie Player screen displayed (see page 62), press \uparrow/\downarrow to select "Menu," then press + .
The Movie menu appears.
- 2 Press \uparrow/\downarrow to select "Protect," then press + .
- 3 Press \uparrow/\downarrow to select "On," then press + .

Tip

When you view a protected movie on a PC, the file attribute for the movie becomes "Read Only."

Deleting digital photos or movies

You can delete unwanted files from a "Memory Stick." However, please be careful when deleting files, as they cannot be recovered once they are deleted.

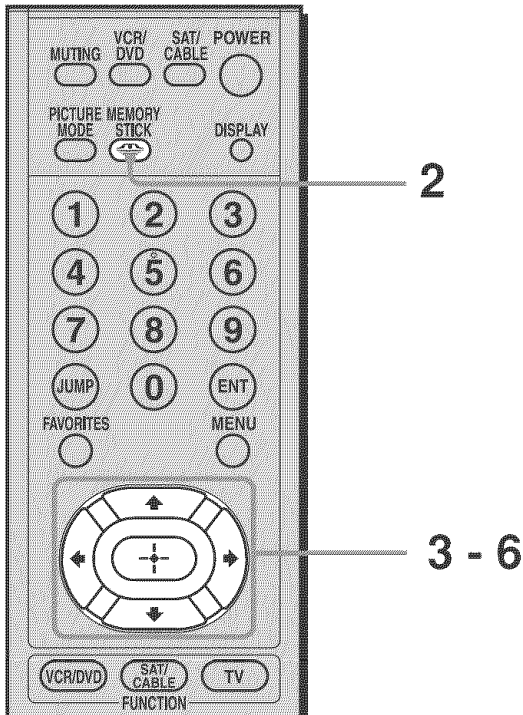

- 1** Insert a "Memory Stick" into the Memory Stick slot.
Be sure to insert the "Memory Stick" correctly (see page 56).
- 2** Press ("Memory Stick"), and the Memory Stick Home screen appears.
- 3** Press /// to select the image you want to delete, then press .
The Index menu appears.

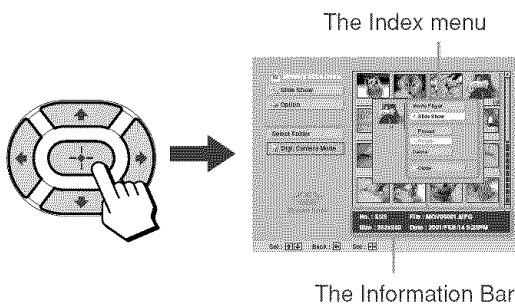

- 4** Press / to select "Delete," then press .
- 5** Press / to select "Sel. Img.," then press .
A confirmation message appears.
- 6** Press / to select "Yes," then press .
If you don't want to delete the image, select "No," then press .

Notes

- When "Digi. Camera Mode" is set to "On," and the selected image is deleted, related files will also be deleted (see page 58).
- Before you delete an image, be sure to confirm the information shown on the Information Bar, first.
- You cannot delete a protected image (see page 63).
- If the write-protect switch on the "Memory Stick" you are using is set to LOCK, you will not be able to delete the image.

To delete a digital photo shown at full-screen size

- 1** While the digital photo is being displayed at full-screen size (see page 60), press .
The Digital Photo menu appears.
- 2** Press / to select "Delete," then press .
- 3** Press / to select "Sel. Img.," then press .
- 4** Press / to select "Yes," then press .

To delete a movie from the Movie Player screen

- 1** With the Movie Player screen displayed (see page 62), press / to select "Menu," then press .
The Movie menu appears.
- 2** Press / to select "Delete," then press .
- 3** Press / to select "Sel. Img.," then press .
- 4** Press / to select "Yes," then press .

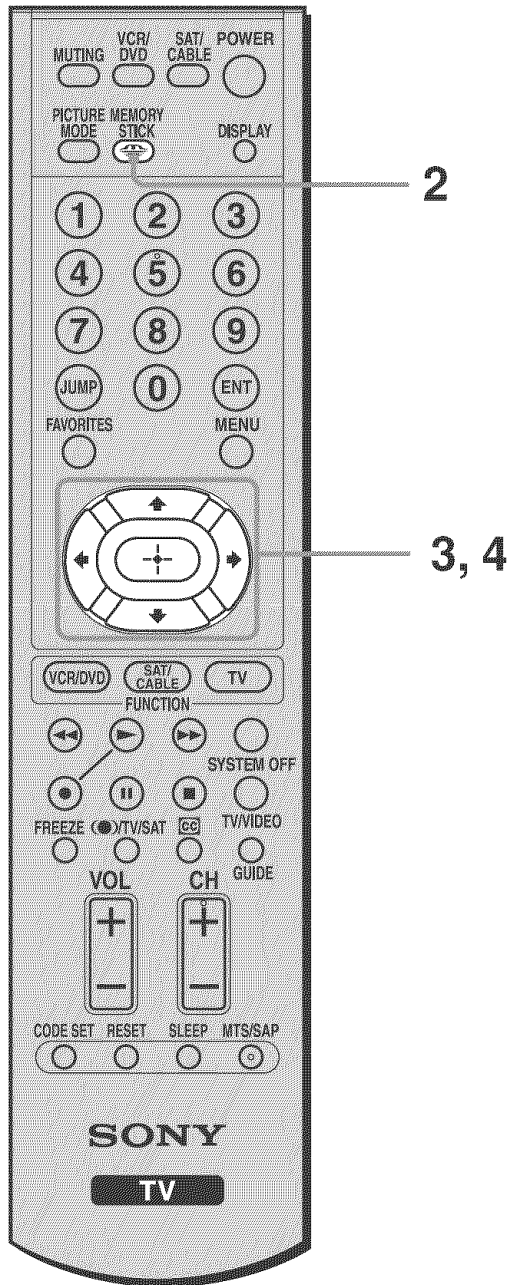

About the Memory Stick Home Menu Options

You can check the "Memory Stick" type, or its current status.



1 Insert a "Memory Stick" into the Memory Stick slot.
Be sure to insert the "Memory Stick" correctly.
(see page 56)

2 Press  ("Memory Stick"), and the Memory Stick Home screen appears.

3 Press  to select "Option," then press .
The Option Settings menu appears.

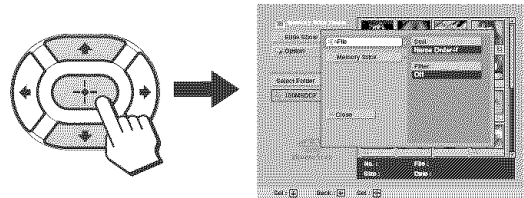

4 Press  to select "Memory Stick."
Information on the "Memory Stick" you are using is displayed.

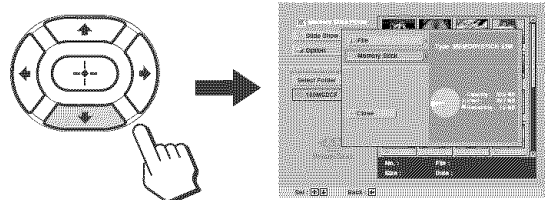

Selecting a folder and viewing digital photos or movies

To view digital photos or movies that have been made into albums and saved in a folder using a PC, you must first select the folder. To select these photos or movies, you must set "Digi. Camera Mode" to "Off" beforehand.

Also, when "Digi. Camera Mode" is set to "On," you can display up to 2,000 digital photos or movies, but if you want to display more than 2,000, you must set "Digi. Camera Mode" to "Off."

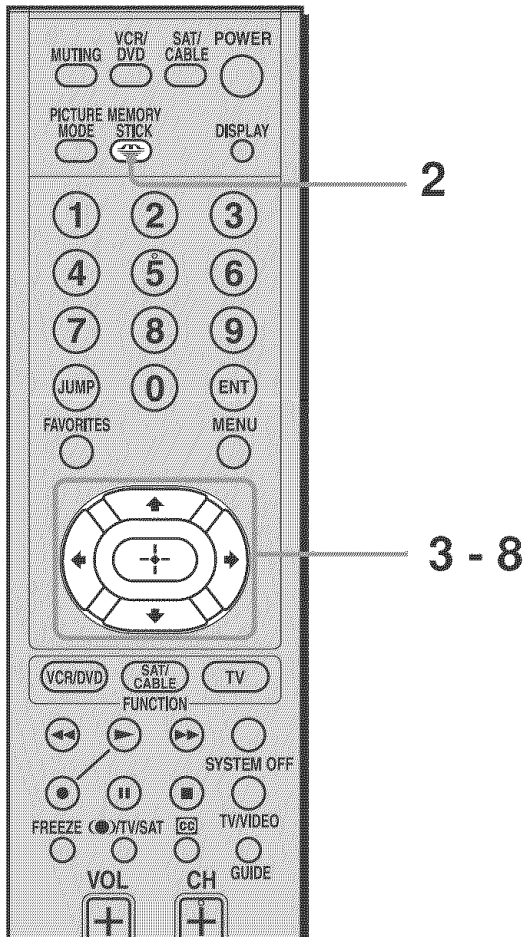

- 1** Insert a "Memory Stick" into the Memory Stick slot.
Be sure to insert the "Memory Stick" correctly (see page 56).
- 2** Press ("Memory Stick"), and the Memory Stick Home screen appears.
- 3** Press to select "Select Folder," then press .

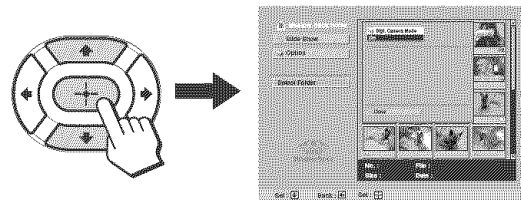

- 4** Press to select "Digi. Camera Mode," then press .

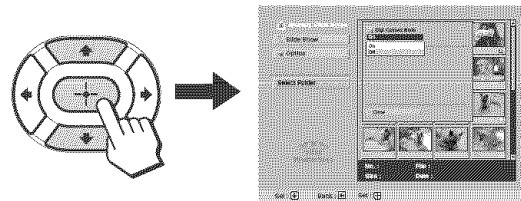

- 5** Press to select "Off," then press .

The currently selected folder The Folder List

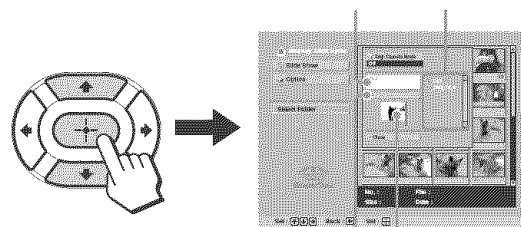



One level up The first image in the current folder is displayed.



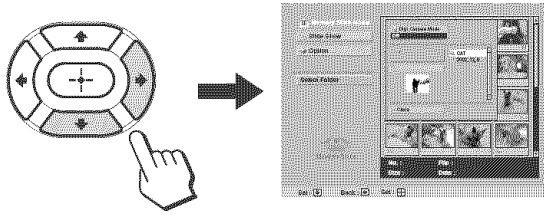

(Continued)

- 6** Press  to move the cursor to the Folder List.

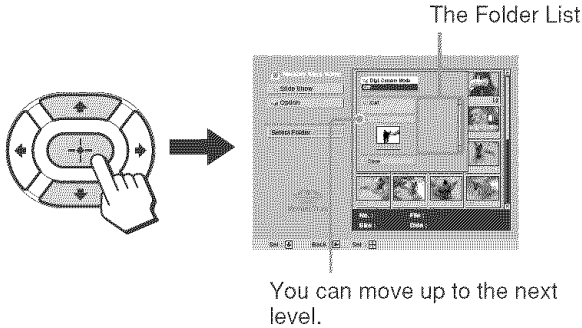

- 7** Press / to select the folder containing the image you want to see, then press .



- 8** Press / to select "Close," then press  or .
- The display returns to the Memory Stick Home screen, and the image files in the currently selected folder are displayed in the list.

Tip

An electronic storage area where multiple images are stored together is called a folder. In addition to digital photos and movies, folders can contain other folders. When folders are arranged in a hierarchy with several levels, to move to the next level up, select , then repeat steps 6 and 7.

Note

Folders or files with non-DOS-format names (file names of 9 characters and above) may not be displayed correctly.

Sorting image files

You can sort the image files stored on a "Memory Stick" by name or by recorded date order. To do this, first set "Digi. Camera Mode" on the Select Folder menu of the Memory Stick Home screen to "Off."

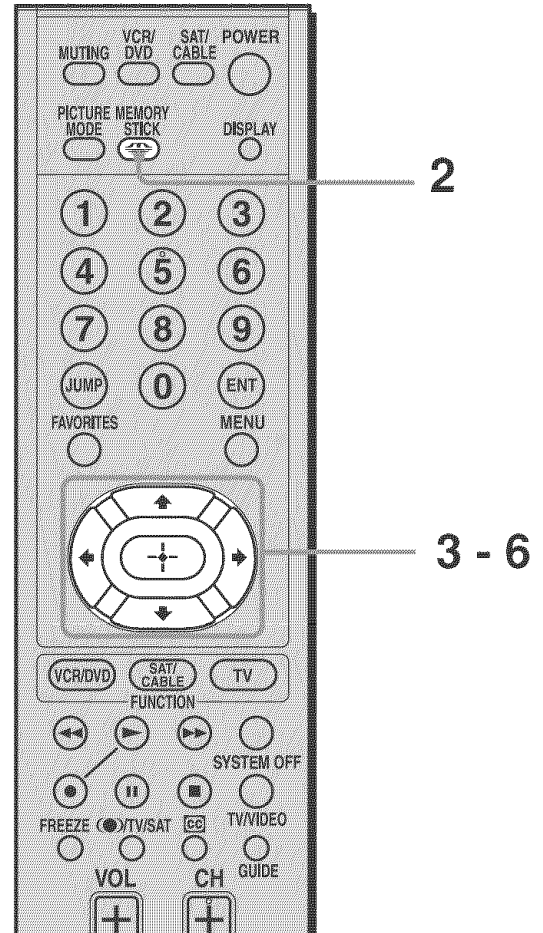

- 1** Insert a "Memory Stick" into the Memory Stick slot.
Be sure to insert the "Memory Stick" correctly (see page 56).
- 2** Press  ("Memory Stick"), and the Memory Stick Home screen appears.

- 3 Press \uparrow/\downarrow to select "Option," then press \oplus .
The Option Settings menu appears.

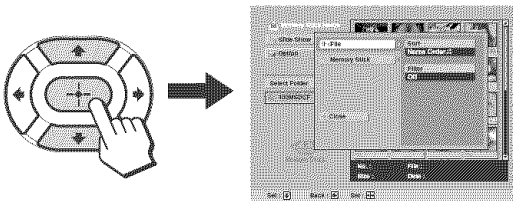

- 4 Press \uparrow/\downarrow to select "File," then press \oplus .

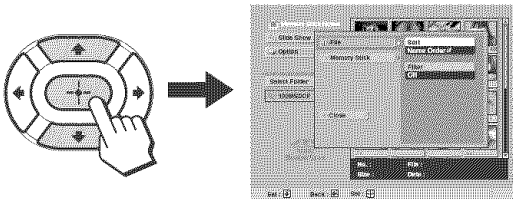

- 5 Press \uparrow/\downarrow to select "Sort," then press \oplus .

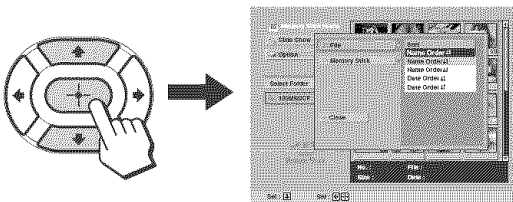

- 6 Press \uparrow/\downarrow to select how you want to sort items, then press \oplus .

Items that can be selected	Sort order
Name Order \downarrow A \downarrow Z	Image file names will be sorted alphabetically, starting with A.
Name Order \downarrow Z \downarrow A	Image file names will be sorted alphabetically, starting with Z.
Date Order \downarrow 1 \downarrow 9	Image files will be sorted by shooting date, starting with the oldest.
Date Order \downarrow 9 \downarrow 1	Image files will be sorted by shooting date, starting with the most recent.

Note

Images modified on a PC may be sorted based not on their recorded dates, but on the date they were modified.

Selectively displaying digital photos or movies

You can selectively display either digital photos or movies saved on a "Memory Stick." To do this, first set "Digi. Camera Mode" on the Select Folder menu of the Memory Stick Home screen to "Off."

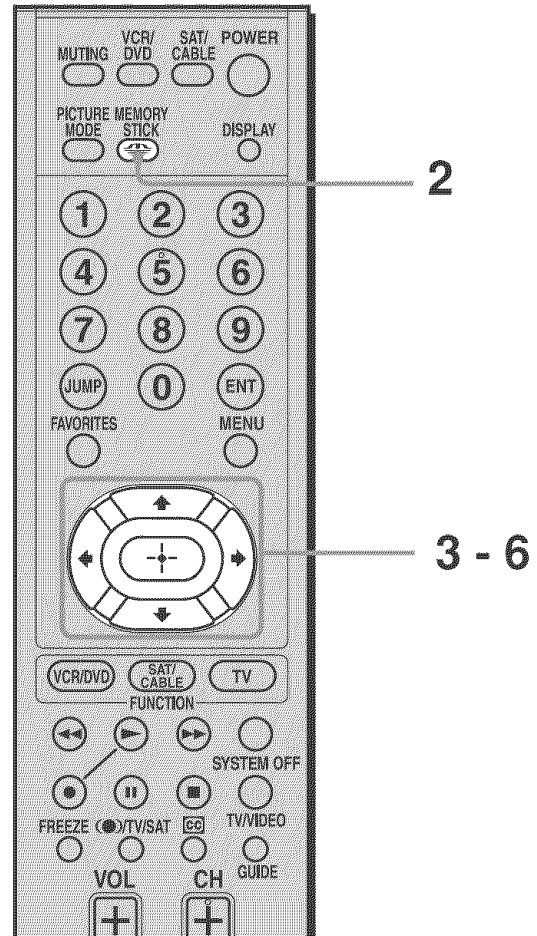

- 1 Insert a "Memory Stick" into the Memory Stick slot.
Be sure to insert the "Memory Stick" correctly (see page 56).
- 2 Press Memory Stick icon ("Memory Stick"), and the Memory Stick Home screen appears.

(Continued)

- 3 Press \uparrow/\downarrow to select “Option,” then press \odot .
The Option Settings menu appears.

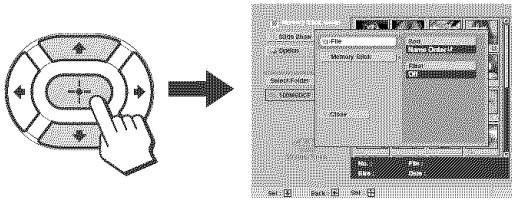

- 4 Press \uparrow/\downarrow to select “File,” then press \odot .

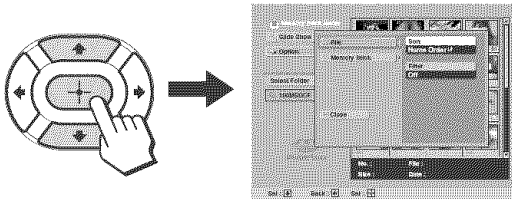

- 5 Press \uparrow/\downarrow to select “Filter,” then press \odot .

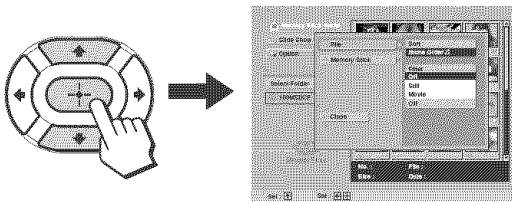

- 6 Press \uparrow/\downarrow to select either “Still” or “Movie,” then press \odot .

Images of the type selected are displayed.

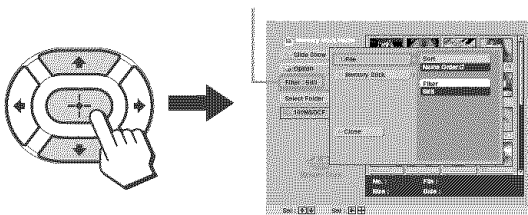

Item	The displayed image
Still	Digital photos only
Movie	Movies only
Off	Digital Photos - Movies

Tip

When Filter is set, the currently selected image type (“Still” or “Movie”) is displayed on the Memory Stick Home screen.

Caution icons and messages

If there is a file problem in the “Memory Stick,” the following icons and messages may appear on the screen. Use the list below to identify the problem and take the appropriate action.

The image file is in the JPEG or MPEG1 format but is not DCF-compatible.

There is a thumbnail image but it is not DCF-compatible.

There is no selected image file.

There is an image file but the thumbnail image is corrupted.

The image file is corrupted.

No Memory Stick Insert the “Memory Stick” into the Memory Stick slot correctly.

No file No image files are contained in the currently selected folder.

No movie file No moving image files are contained in the currently selected folder, even though “Filter” is set to “Movie” in the Option Settings menu.

No still file No still image files are contained in the currently selected folder, even though “Filter” is set to “Still” in the Option Settings menu.

Cannot play Data in the moving image file is corrupted.

Memory Stick locked The write-protect switch on the “Memory Stick” is set to LOCK. Release the lock.

Memory Stick error • The image file may be corrupted.
• The image file may not be stored in JPEG or MPEG1 format. Check to see if the image file can be viewed on other equipment compatible with the “Memory Stick,” such as a digital camera, etc.

Memory Stick type error A “Memory Stick” that is not compatible or cannot be used with the TV has been inserted.

Format error The “Memory Stick” has not been formatted correctly.

File error	The selected folder has not been named correctly. Re-enter the name with fewer than 66 characters, including "/" by displaying the "Select Folder" menu.
Read Only Memory	A read-only "Memory Stick" has been inserted. You cannot record or delete the data on a read-only "Memory Stick."

Additional Information

Troubleshooting

If, after reading the following instructions, you have additional questions related to the use of your Sony TV, please call one of the following numbers.

Customers in the continental United States contact the Direct Response Center at:
1-800-222-SONY (7669)

Customers in Canada contact the Customer Relations Center at:
1-877-899-SONY (7669)

Self-diagnosis function

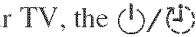
The TV is equipped with a self-diagnosis function. If there is a problem with your TV, the  (Standby/Sleep) indicator on the front panel will flash repeatedly in red. Writing down the duration of flashes and interval between flashes helps you inform qualified Sony personnel of the TV's condition.

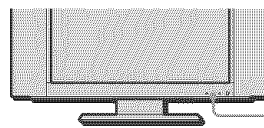



 (Standby/Sleep) indicator (flashing in red)





- 1 Measure how long the  (Standby/Sleep) indicator flashes and stops flashing.

For example, the indicator flashes for 2 seconds, stops flashing for 1 second, and flashes for 2 seconds.



- 2 Press **|** (power) on the TV to turn it off, and disconnect the power cord, then inform qualified Sony personnel or the Direct Response Center/ Customer Relations Center of how the indicator flashes (duration and interval).

Trouble symptoms and remedies

Problem	Possible remedies
No picture. Cannot receive any channels.	<ul style="list-style-type: none"> • Make sure the power cord is connected securely. • Turn on the power of the TV. • Check antenna/cable connections.
Cannot receive upper channels (VHF/UHF) when using an antenna.	<ul style="list-style-type: none"> • Set "Cable" to "Off" in the  (Channel) menu (page 20). • Perform Auto Program to add receivable channels that are not presently in the TV's memory (page 20).
TV is locked to one channel.	<ul style="list-style-type: none"> • Perform Auto Program to add receivable channels that are not presently in the TV's memory (page 20). • Check your Channel Fix setting (page 21).
Cannot receive any channels when using cable TV.	<ul style="list-style-type: none"> • Perform Auto Program to add receivable channels that are not presently in the TV's memory (page 20). • Make sure "Cable" in the  (Channel) menu is set to "On" (page 20).
Cannot receive or select channels.	<ul style="list-style-type: none"> • Perform Auto Program to add receivable channels that are not presently in the TV's memory (page 20).
The TV turns off automatically. (The TV enters the standby mode.)	<ul style="list-style-type: none"> • This TV automatically changes to the standby mode after displaying the message "TV will turn off soon" if it receives no broadcast or input signal through the connected equipment for 10 minutes. • Check that the Sleep timer is activated (page 50).
Some video sources do not appear.	<ul style="list-style-type: none"> • Check the connection between the optional video equipment and the TV. • Press TV/VIDEO on the remote control (page 28). • When you connect video equipment to both the VIDEO and the S VIDEO input jacks, make sure "Auto YC" in the  (Setup) menu is set to "On" to view the S VIDEO input (page 12).

Problem	Possible remedies
Poor picture.	
Double images or ghosts.	<ul style="list-style-type: none"> • Check antenna/cable connections. • Check the antenna location and direction.
Only snow and noise appear on the screen.	<ul style="list-style-type: none"> • Check if the antenna is broken or bent. • Check if the antenna has reached the end of its serviceable life. (3-5 years in normal use, 1-2 years at the seaside.)
Dotted lines or stripes.	<ul style="list-style-type: none"> • Keep the TV away from noise sources such as cars, motorcycles, or hair-dryers.
No color. Color is not correct. Dark picture.	<ul style="list-style-type: none"> • Press PICTURE MODE to select the desired Picture Mode (page 24). • Adjust the Picture Mode options in the  (Video) menu (page 37).
The picture is too bright.	<ul style="list-style-type: none"> • Press PICTURE MODE to select the desired Picture Mode (page 24).
Picture (stripe) noise.	<ul style="list-style-type: none"> • Make sure that the antenna is connected using the supplied 75-ohm coaxial cable. • Keep the antenna cable away from other connecting cords. • Do not use 300-ohm twin lead cables as interference may occur.
No sound./Noisy sound.	
Good picture, no sound.	<ul style="list-style-type: none"> • Check the volume control. • Press MUTING or VOL + so that “Muting” disappears from the screen (page 23). • Disconnect your headphones. • Set “Speaker” to “On” in the  (Audio) menu (page 15). If it is set to “Off,” sound is not output from the TV’s speakers regardless of the TV’s volume control.
Audio noise.	<ul style="list-style-type: none"> • Make sure that the antenna is connected using the supplied 75-ohm coaxial cable. • Keep the antenna cable away from other connecting cords. • Do not use 300-ohm twin lead cables as interference may occur. • Press MTS/SAP to select “Mono” (page 40).
Cannot operate the menu.	<ul style="list-style-type: none"> • If the option you want to select appears in a pale color, you cannot select it.
Screen Mode changes automatically with the “16:9 Enhanced” option set to “Auto.”	<ul style="list-style-type: none"> • The TV automatically detects the aspect ratio signal transmitted with the picture signal and displays the picture at its original aspect ratio (page 26).
The picture looks distorted, with people appearing unnaturally short and fat, with the “16:9 Enhanced” option set to “On.”	<ul style="list-style-type: none"> • If you set the “16:9 Enhanced” option to “On,” the picture is forcibly compressed vertically regardless of its aspect ratio signal. Therefore, a picture in the 4:3 aspect ratio, such as a normal 4:3 broadcast, looks unnatural because of compression. This problem is more serious for a Letterbox movie because the entire picture, including its upper and lower black bands, is compressed. You can watch these pictures at their original aspect ratio by setting the “16:9 Enhanced” option to “Auto” (page 26).
Remote control does not operate.	<ul style="list-style-type: none"> • The batteries could be weak. Replace the batteries. • Check the polarity of the batteries. • If the  (Standby/Sleep) indicator on the TV does not light in red, press  (power) on the TV. • Point the remote control at the remote control sensor of the TV. • Install the TV away from fluorescent lights.
Cannot change channels with the remote control.	<ul style="list-style-type: none"> • Be sure you have not inadvertently switched your TV from channel 3 or 4 setting if you are using another device to change channels. • If you are using another device to control channels, be sure the FUNCTION button for that device has been pressed. For example, if you are using your cable box to control channels, be sure to press SAT/CABLE (page 30).
Lost password.	<ul style="list-style-type: none"> • Select the  (Parent) menu on the menu screen, then enter the following master password: 4357. The master password clears your previous password and allows you to enter a new password (page 43).

(Continued)

Problem	Possible remedies
“Memory Stick” Cannot insert the “Memory Stick” into the Memory Stick slot.	<ul style="list-style-type: none"> • The “Memory Stick” is not facing in the correct direction. Insert the “Memory Stick” with the ◀ mark facing forward into the Memory Stick slot (page 56).
Cannot delete a file or all materials.	<ul style="list-style-type: none"> • The write-protect switch on the “Memory Stick” is set to LOCK. Release the lock. • The image file is protected. Release the protection using the Index menu.
The still image files in the JPEG format stored in a “Memory Stick” cannot be displayed.	<ul style="list-style-type: none"> • Select “Option” in the Memory Stick Home and select “File.” Then set “Filter” to “Still” or “Off” (page 69).
The moving image files in the MPEG1 format stored in a “Memory Stick” cannot be displayed.	<ul style="list-style-type: none"> • Select “Option” in the Memory Stick Home and select “File.” Then set “Filter” to “Movie” or “Off” (page 69).
The image is not displayed and  or  appears.	<ul style="list-style-type: none"> • The image file is not DCF-compatible.

Specifications

Television system:

American TV standard

Channel coverage:

VHF: 2-13/UHF: 14-69/CATV: 1-125

Antenna:

75-ohm external terminal for VHF/UHF

Screen size (measured diagonally):

21 inches

Panel System:

a-Si TFT Active Matrix LCD panel
(Effective dots: more than 99.99%)

Display resolution:

1,024 dots (horizontal) × 768 lines (vertical)

VIDEO 1/2 IN:

S VIDEO (4-pin mini DIN):

Y: 1 Vp-p, 75 ohms unbalanced,
sync negative

C: 0.286 Vp-p (Burst signal),
75 ohms

VIDEO: 1 Vp-p, 75 ohms unbalanced,
sync negative

AUDIO: 500 mVrms (100% modulation)
Impedance: 47 kilohms

VIDEO 3 IN:

Y, P_B, P_R (Component Video):

Y: 1.0 Vp-p, 75 ohms
unbalanced, sync negative

P_B: 0.7 Vp-p, 75 ohms

P_R: 0.7 Vp-p, 75 ohms

Signal format:

480i, 480p, 720p, 1080i

AUDIO: 500 mVrms (100% modulation)
Impedance: 47 kilohms

AUDIO OUT:

500 mVrms (100% modulation)

More than 500 mVrms at the maximum volume setting
(Variable)

More than 500 mVrms (Fixed)

Headphones:

Stereo mini jack

Impedance: 16 ohms

Speaker:

Full range: 4.0 × 10.0 cm oval (1 ⁹/₁₆ × 3 ¹⁵/₁₆ inches) (2)

Tweeter: ø2.5 cm (³/₃₂ inches) (2)

Speaker output:

4.0 W + 4.0 W

Power requirement:

120 V AC, 60 Hz

Power consumption:

In use: 118 W

In standby: Less than 1 W

Dimensions (W/H/D):

Including TV stand and rear cover:

630 × 461 × 242 mm

(24 ¹³/₁₆ × 18 ⁵/₃₂ × 9 ¹⁷/₃₂ inches)

Without TV stand and rear cover:

630 × 400 × 126 mm

(24 ¹³/₁₆ × 15 ³/₄ × 4 ³¹/₃₂ inches)

Mass:

Including TV stand and rear cover:

11.3 kg (24 lb. 15 oz.)

Without TV stand and rear cover:

8.6 kg (18 lb. 15 oz.)

Supplied accessories:

Remote control RM-Y1106 (1)

Size AA batteries (2)

75-ohm coaxial cable (1)

AC power cord (1)

Rear cover (1)

Operating Instructions

Warranty Card

Product Registration

Optional accessories:

Note that some optional accessories may be out of stock.

Headphones plug adaptor

Connecting cables

“Memory Stick” media

Wall-Mount Bracket SU-W210

Design and specifications are subject to change without notice.

Index to Parts and Controls

TV Front panel

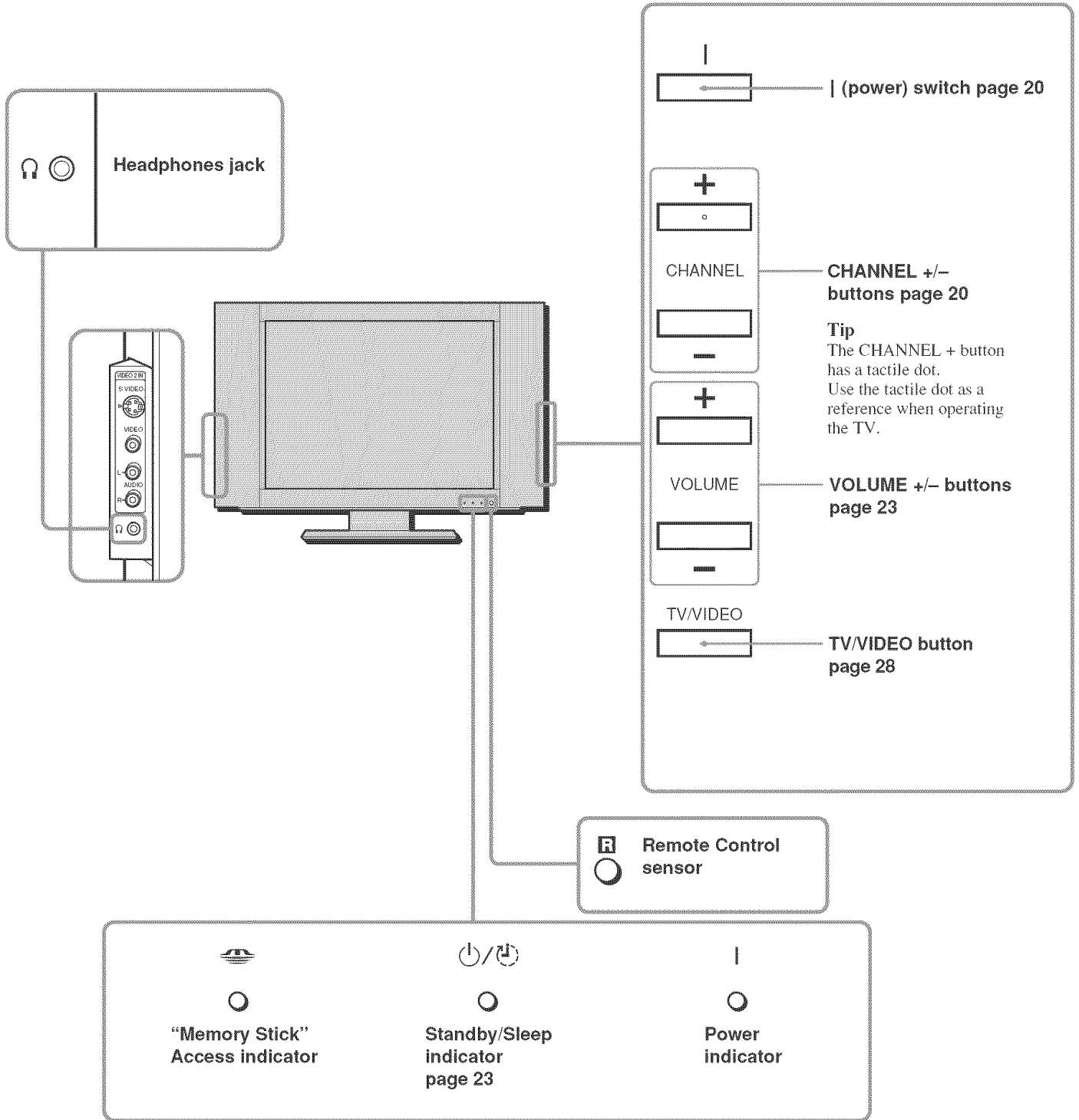

Remote control buttons

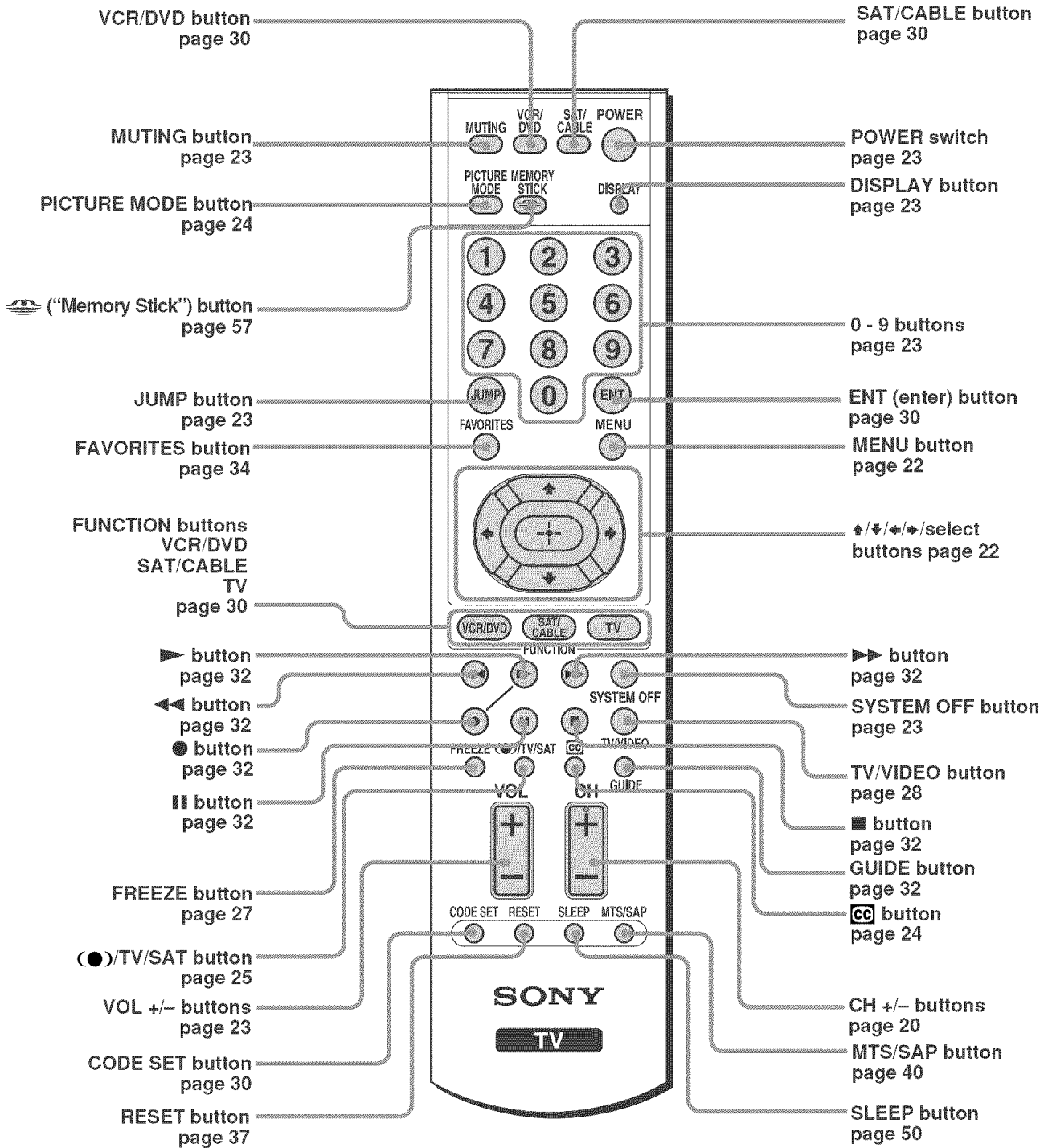

Tip

The MTS/SAP button, the number 5 button and the CH + button have a tactile dot.

Use the tactile dot as a reference when operating the TV.

Index

16:9 Enhanced 26

A

Adjusting

picture quality 37
 sound quality 39
 viewing angle of the TV 11
 volume 23

Audio Out 15

Auto Program 20

Auto SAP 40

Auto YC 12

C

Cable TV 20

Channel setting 20

Channel Fix 21

Channel Skip/Add 21

Closed caption 24

Component Video connectors .. 16, 18, 19

Connecting 8

antenna 8

audio receiver 15

cable box 8

digital satellite receiver 19

digital TV receiver 18

DVD player 16, 17

power cord 9

satellite receiver 13, 14

VCR 12

D

DISPLAY 23

E

Effect 25

F

Favorite channels 33

Front and rear connectors 7

I

Input select 28

J

JUMP 23

L

Language selection 22

M

“Memory Stick” 52

Menu 36

Mono 40

MTS 40

MUTING 23

O

Optional equipment 30

P

Parent 41

password 43

ratings 46

Picture Mode 24

Power on/off 23

Pro 25

R

Remote control 6

battery installation 6

operating optional equipment 32

programming 30

S

S Video input jack 12

Self-diagnosis function 72

Sleep timer 50

Speaker 15

Specifications 75

SRS WOW 25

Standard 25

Stereo 40

SYSTEM OFF 23

T

Troubleshooting 72

U

Unpacking 6

V

VHF/UHF channels 20

Vivid 25

Volume 23

<http://www.sony.net/>

Printed in U.S.A.