

**NO
TOOLS
REQUIRED**

**the
Big Easy®**

**THE GRILL THAT COOKS
BREAKFAST
LUNCH AND DINNER**

4638248 / 0-4165032 (01-03-02)

**the
Big Easy®**

4638248

ASSEMBLY MANUAL



**THIS GRILL IS FOR
OUTDOOR USE ONLY**

CAUTION: Read and follow all safety statements, assembly instructions, and use and care directions before attempting to assemble and cook.

INSTALLER/ASSEMBLER: Leave these instructions with consumer.

CONSUMER: Keep this manual for future reference.

▲ WARNING

Failure to follow all manufacturer's instructions could result in serious personal injury and/or property damage.

▲ CAUTION

Some parts may contain sharp edges – especially as noted in the manual! Wear protective gloves if necessary.

If you have any questions or need assistance during assembly, please call 1-800-241-7548.

Visit us on the web at:
www.charbroil.com

Char-Broil

1

NOTE: To prevent scratching, lay grill on packing material to assemble.

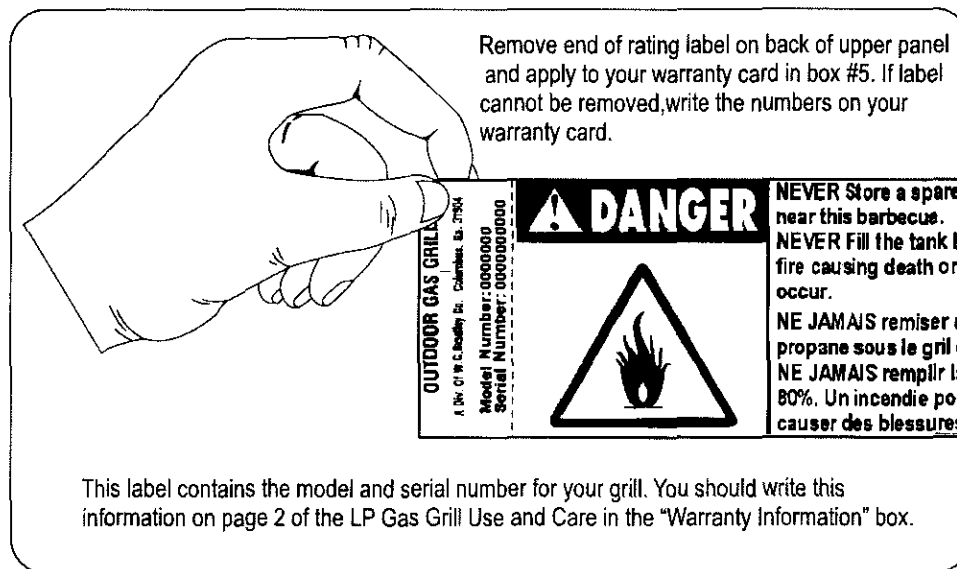

2

1st: Unfold legs. Do not stand cart up until front panel is attached. The front panel stabilizes the cart.

Items to Assemble:

- 2 Wheels
- 1 Tank Bracket
- 2 Axle Bolt
- 2 Hitch Pin

- 1 Tank Retainer
- 1 1-1/4" Carriage Bolt
- 1 Wing Nut, Metal

- 2 Control Knobs

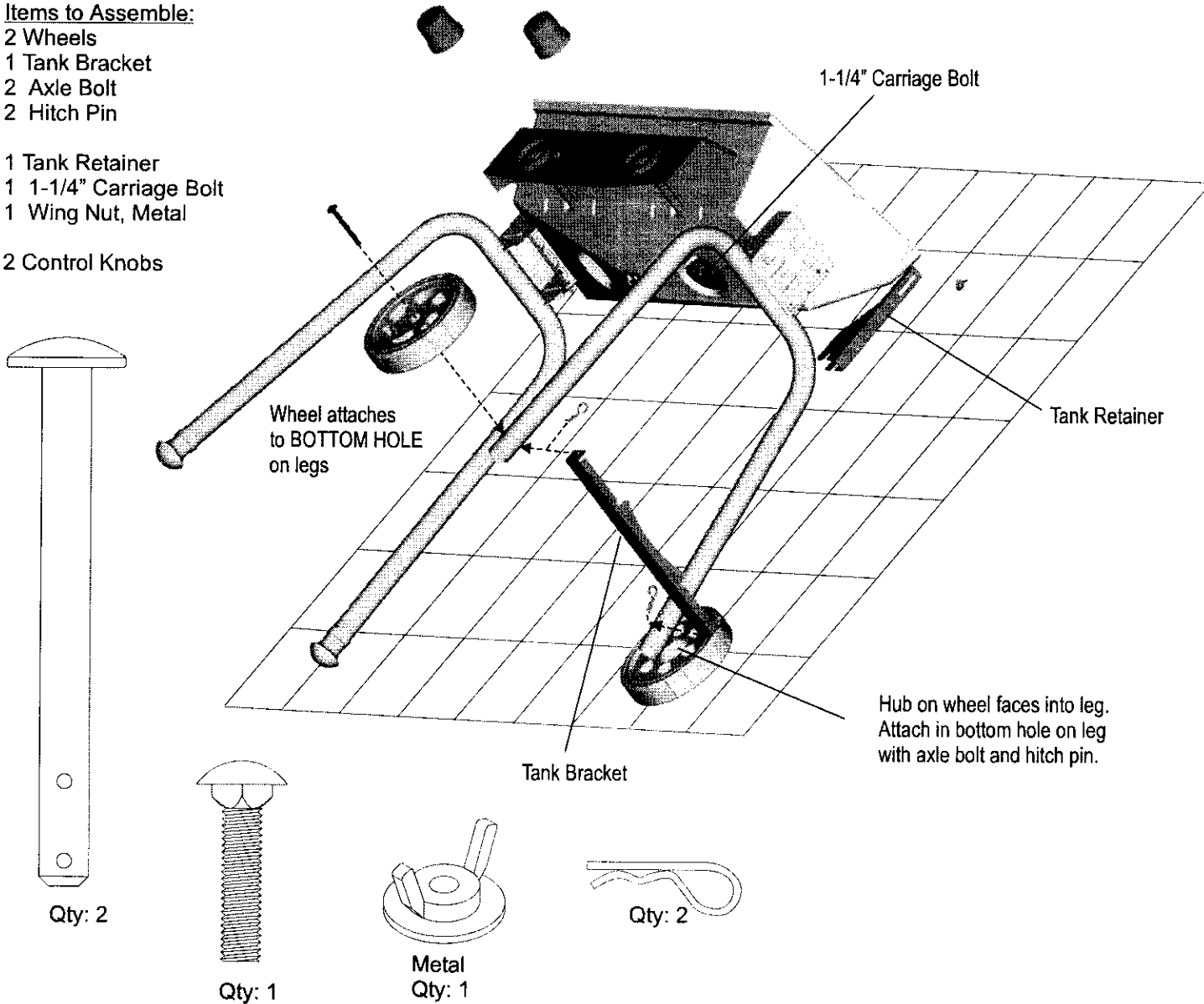

3

Items to Assemble:

- 1 Upper Panel
- 4 2" Carriage Bolt
- 4 Wing Nut, Plastic

- 1 Lower Panel
- 3 2" Carriage Bolt
- 3 Wing Nut, Plastic

Lower Panel inserts into Upper Panel

Upper Panel

Lower Panel

Slide Upper Panel under UFC

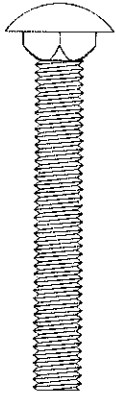

Qty:7

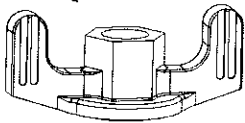

Plastic
Qty:7

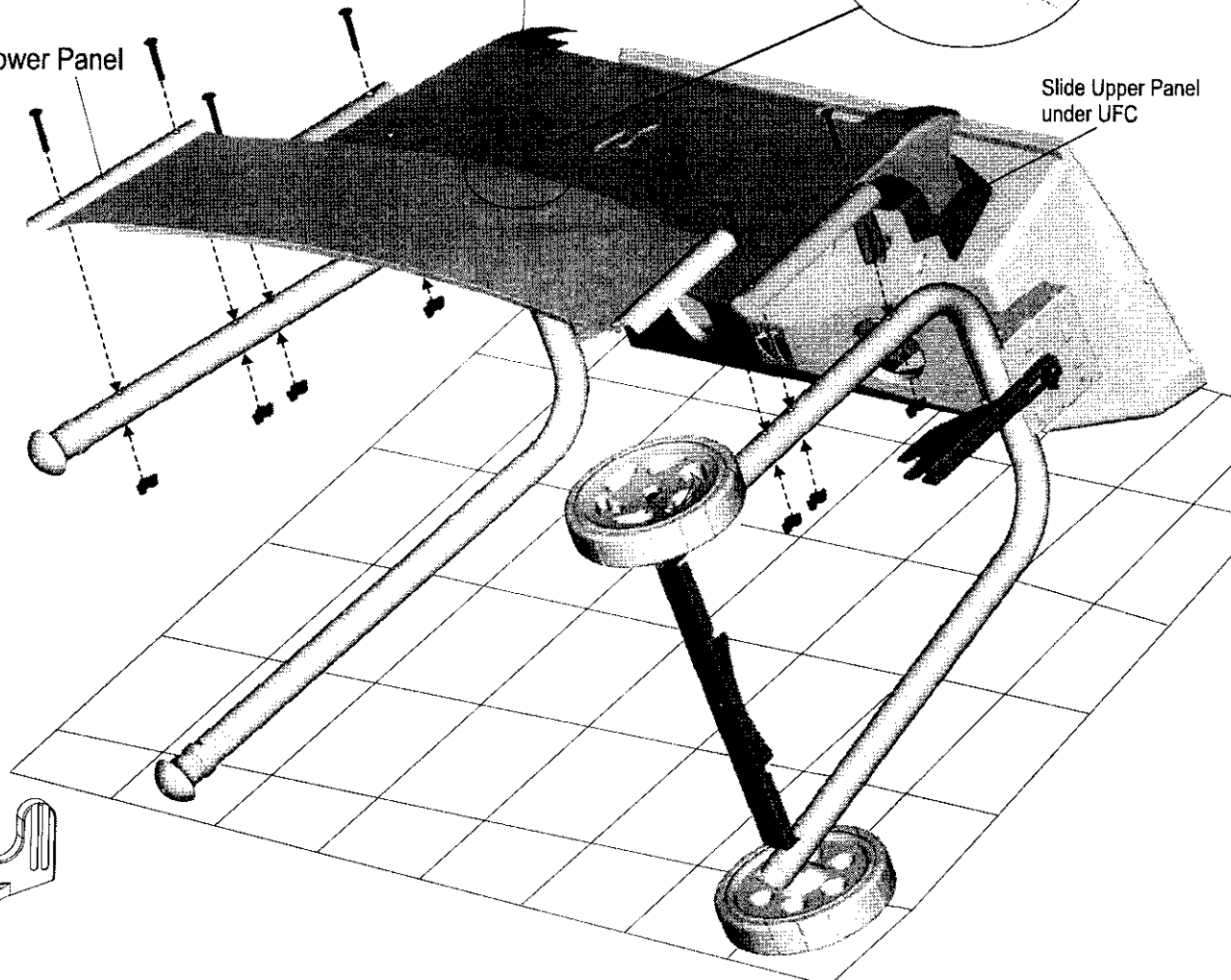

4

Stand Cart Upright

Items to Assemble:

- 1 Left Shelf
- 2 3/4" Carriage Bolts
- 2 Wing Nuts, Metal
- 2 Wing Screws, "AB" point

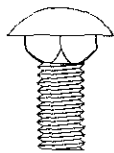

Qty: 2



Metal
Qty: 2



Qty: 2
End has
sharp point
"AB"

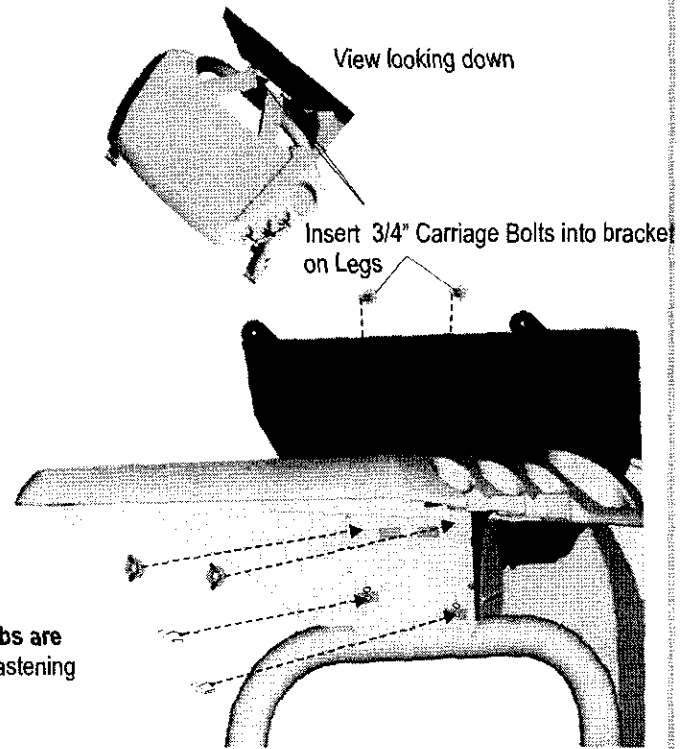

Make sure all four tabs are
inside slots before fastening

5

Items to Assemble

- 1 Sideburner
- 1 Sideburner Toolholder
- 2 3/4" Carriage Bolts
- 2 Wing Nuts, Metal
- 2 Wing Screws, "AB" point
- 2 Wing Screws

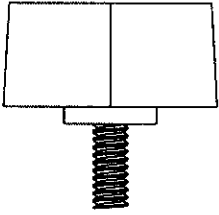

Qty: 2
Blunt end use to
attach Toolholder to
Sideburner Shelf

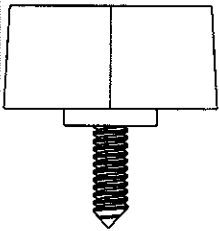

Qty: 2
End has
sharp point
"AB"

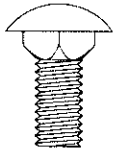

Qty: 2

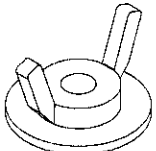

Metal
Qty: 2

1st
Tabs on Toolholder
lock into Sideburner
Shelf

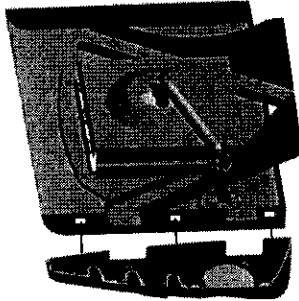

2nd
Attach Toolholder to Sideburner
with blunt end wing nuts.

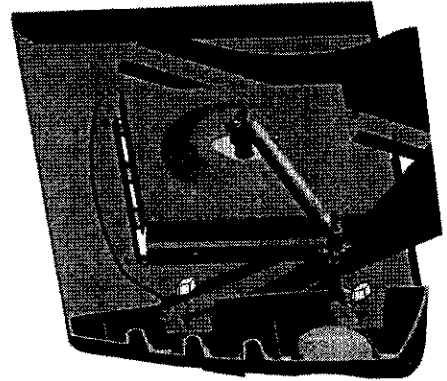

View looking down

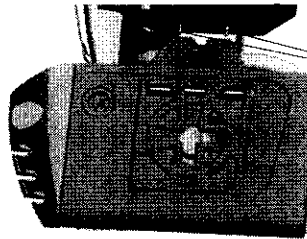

Insert 3/4" Carriage Bolts into bracket on Legs

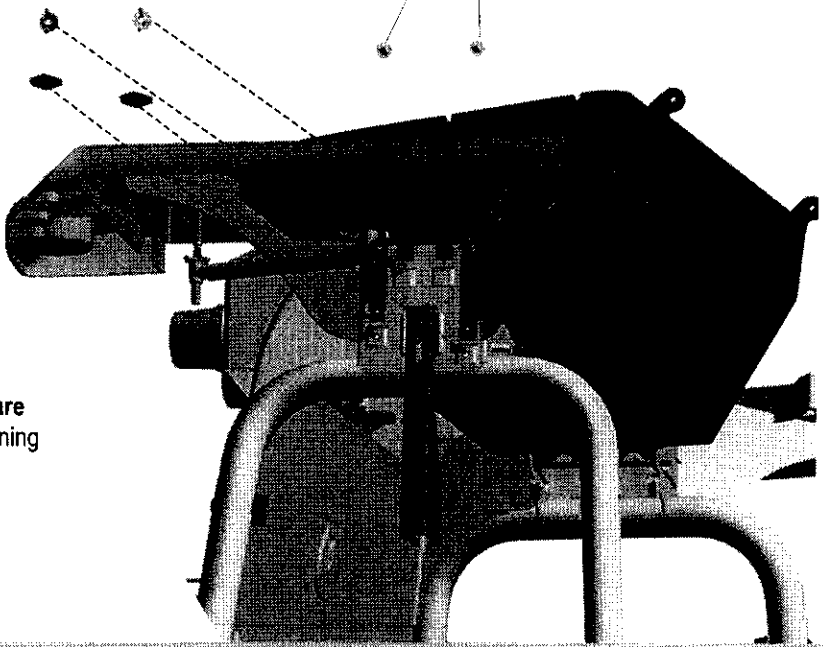

Make sure all four tabs are
inside slots before fastening



1st: Remove styrofoam pad

Items to Assemble:

- 2 Tent Frames
- 2 Burner Tents
- 2 Grates
- 1 Griddle
- 1 Shield

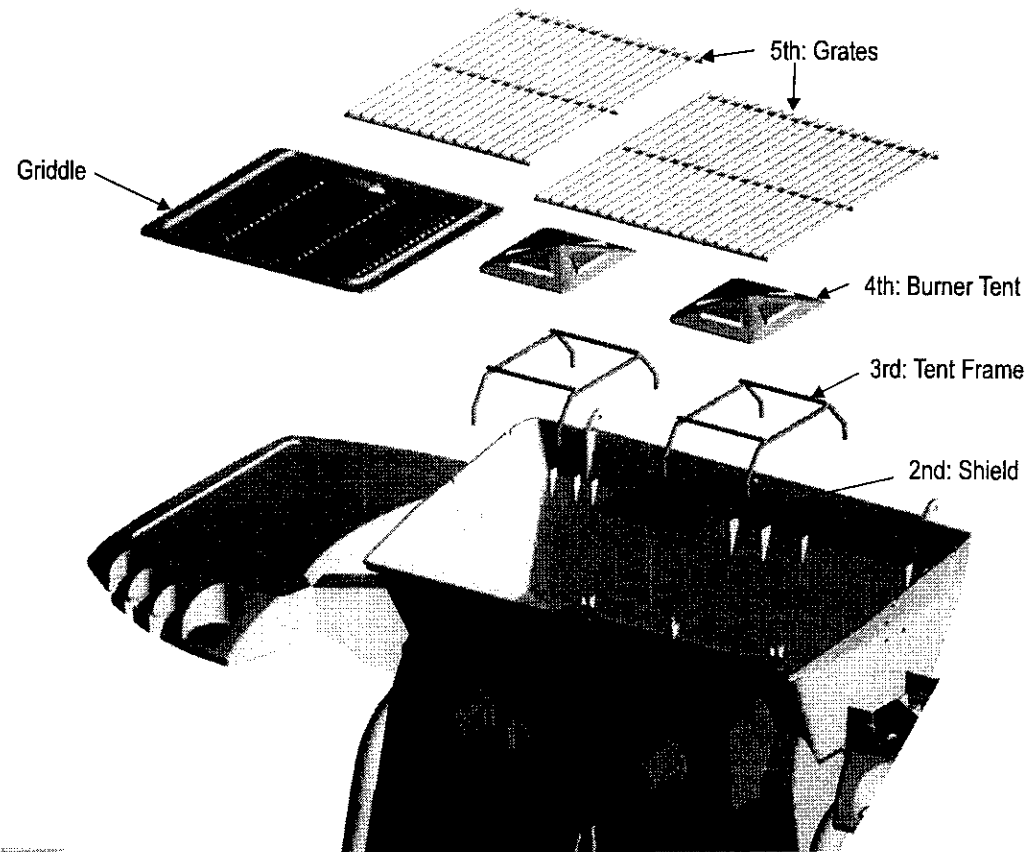

7

Items to Assemble:

- 1 Grill Lid
- 2 Hinge Pin
- 2 Hitch Pin

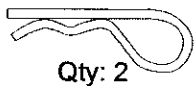

Qty: 2

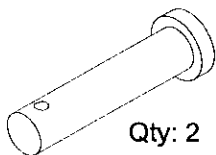

Qty: 2

Hinge Pin
and Hitch Pin

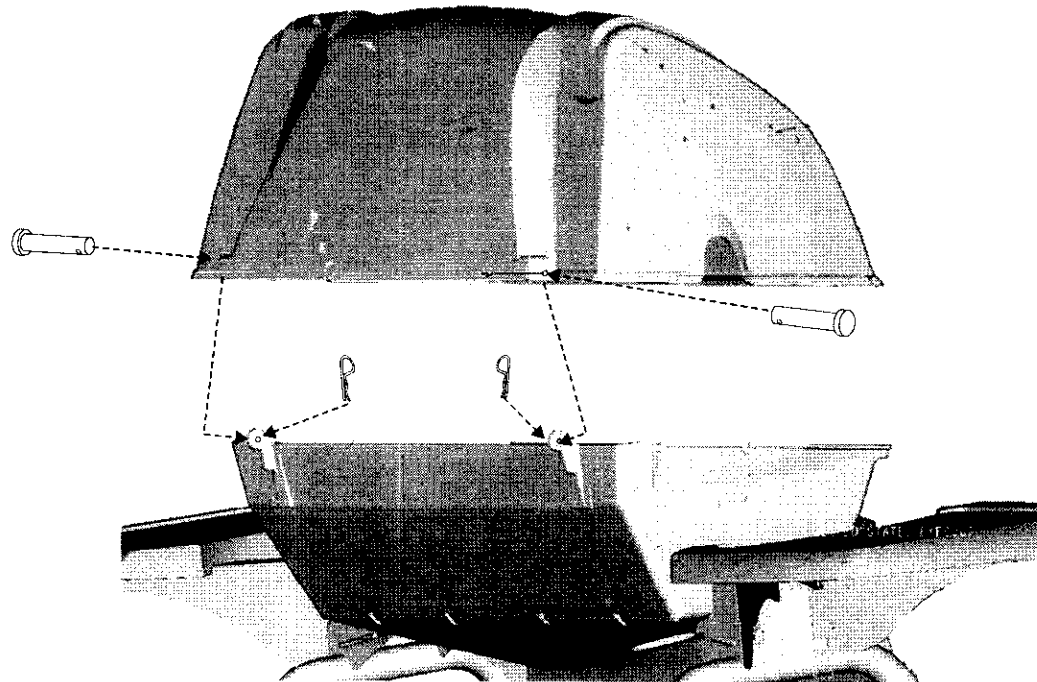

2nd Items to Assemble:

- 1 Logo Plate with clips
- 1 Handle
- 2 Wing Nuts

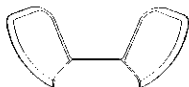

Qty: 2

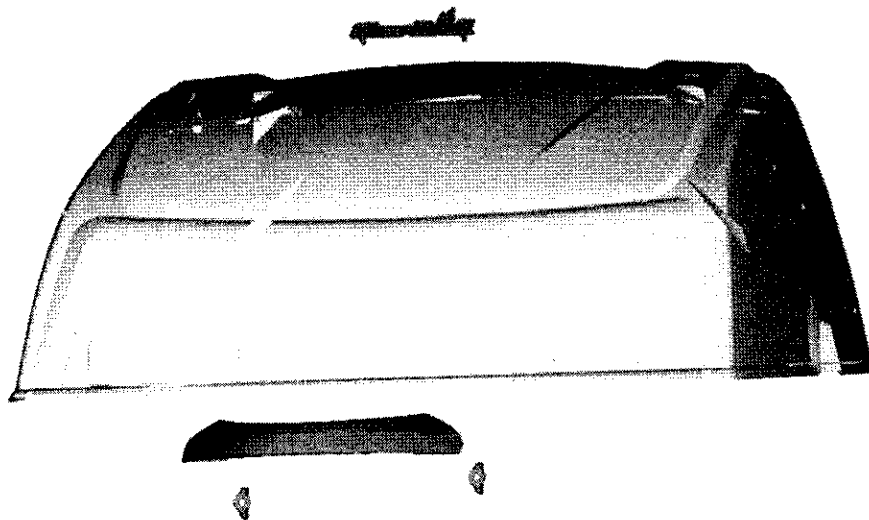



Items to Assemble:
1 Warming Rack

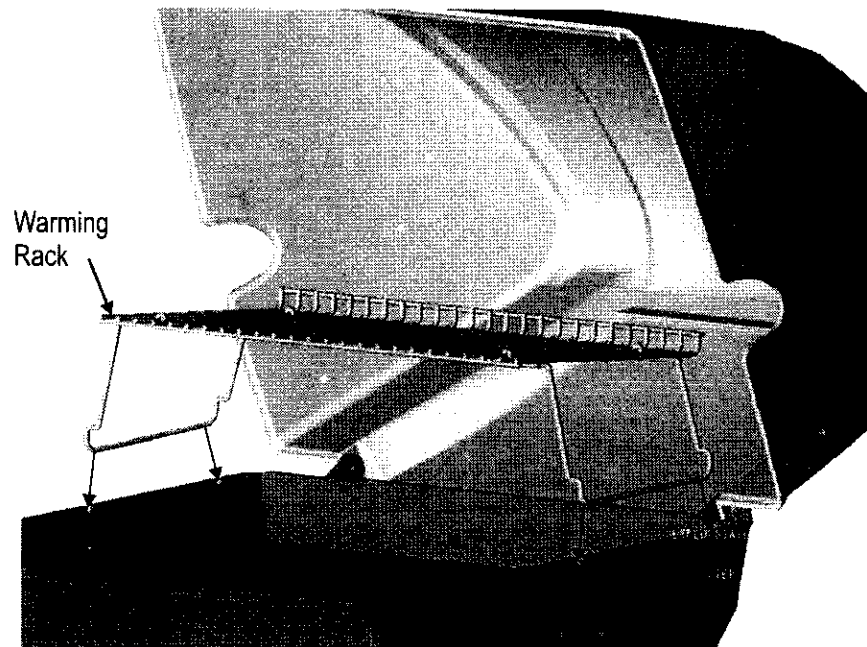

9

Items to Assemble:

1 Chain with Coupling

1 Match-Holder

Place end of chain through hole, reattach coupling to end of chain.
Thread eyelet on other end of chain into loop of match holder.

See Use & Care Manual for
"Match Lighting Instructions"

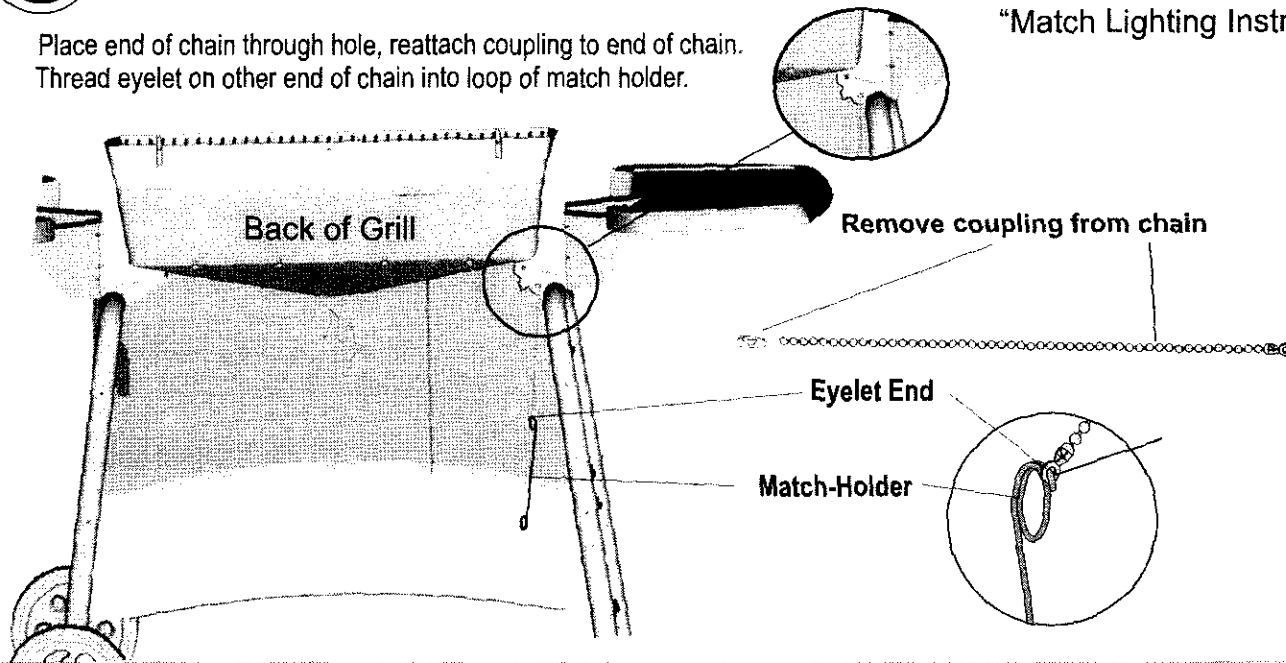

10

1st: Insert Valve into Sideburner Tube and snap valve cup into bottom of shelf (see inset for proper engagement).
2nd: Attach long wire from beneath console to electrode beneath Sideburner.

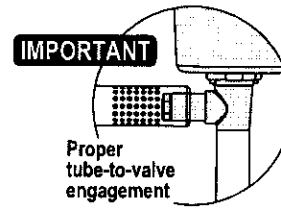
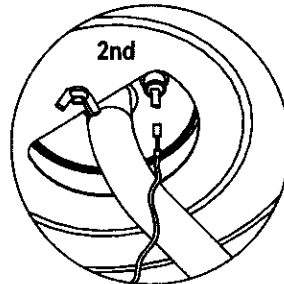
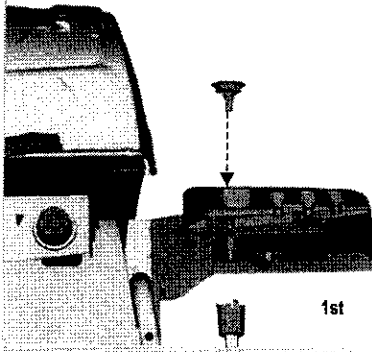

4638248

11

Items to Assemble:
1 Grease Clip

Hang grease clip from center of grill bottom.
Hang an empty soup can (not included) from grease clip.

⚠ CAUTION

• Failure to install can in clip will cause hot grease to drip from bottom of grill with risk of fire or property damage.

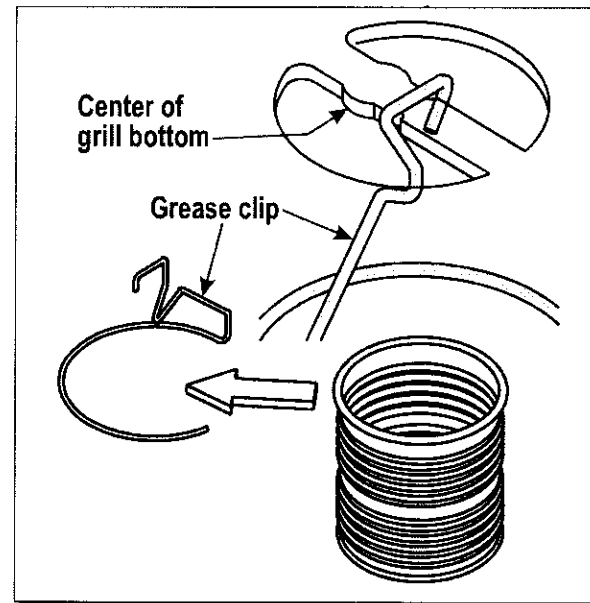

12

Items to Assemble:
1 LP Tank

Loosen wing-nut on tank holder.
Center base of tank in notches between wheels.
Lower tank holder onto tank and tighten the wing-nut.

LP tank is sold separately. Fill and leak check before attaching to grill and regulator.

See Use and Care to perform the "Burner Flame Check" and important safety instructions before using

CAUTION

- Tank collar opening must face to front of cart once tank is attached.
- Failure to install tank correctly may allow gas hose to be damaged in operation, resulting in the risk of fire.

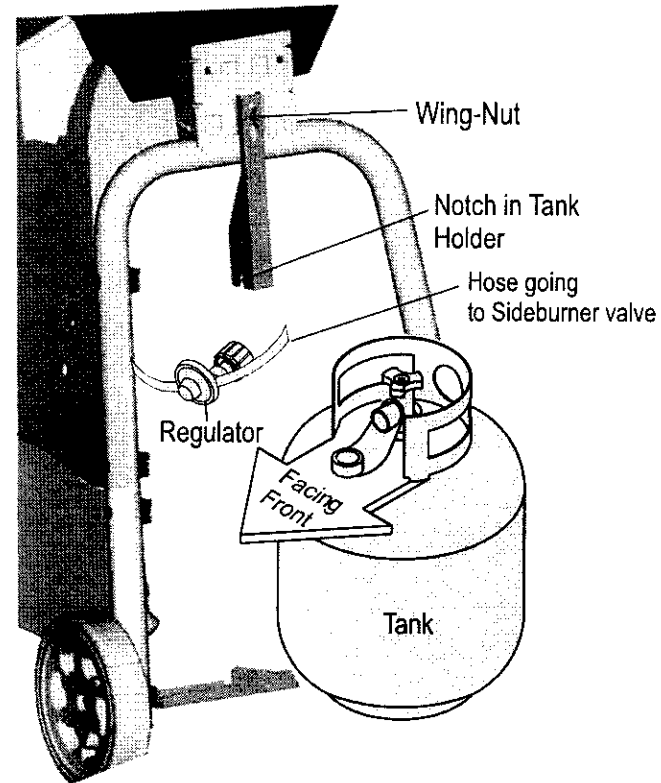

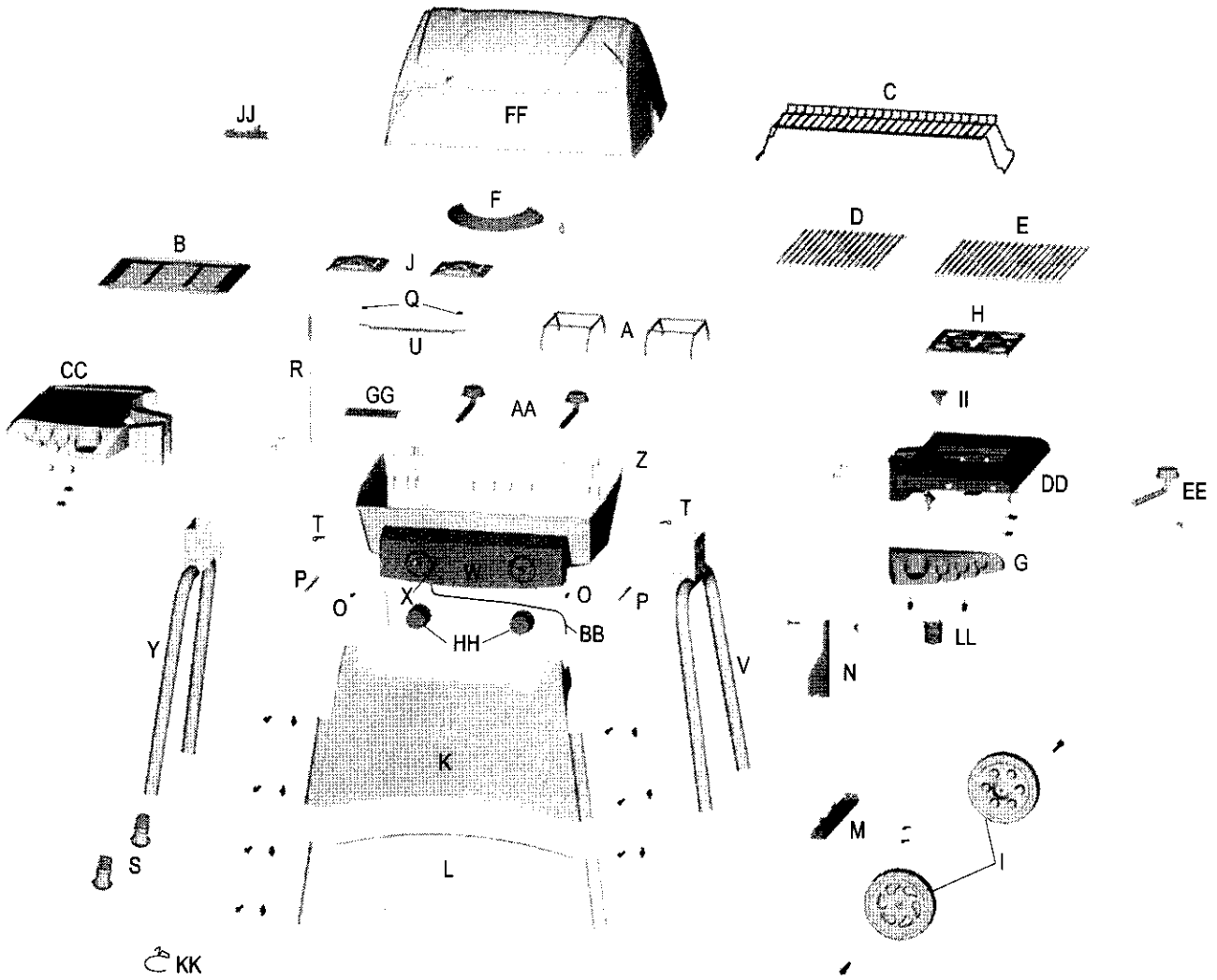

Parts List - Model 4638248

<u>Key Qty.</u>	<u>Description</u>	<u>Part #</u>	<u>Key Qty.</u>	<u>Description</u>	<u>Part #</u>
A 2	Burner Frame	4151014	CC 1	Left Shelf	4520012
B 1	Griddle	4152038	DD 1	Sideburner Assembly	4520014
C 1	Warming Rack	4152043	EE 1	Sideburner Burner	5068017
D 1	Cooking Grid, 12"	4152045	FF 1	Grill Top	4581964
E 1	Cooking Grid, 15"	4152046	GG 1	Shield	5501038
F 1	Handle	4154488	HH 2	Control Knob	4154507
G 1	Sideburner Tool Holder	4154520	II 1	Sideburner Knob	4154471
H 1	Sideburner Grate	4156179	JJ 1	Logo Plate	4157147
I 2	Wheel	4156957	-- 1	Hardware, Cart Assy.	4254007
J 2	Burner Tent	4500226	-- 1	Hardware, Shelf	4254011
K 1	Upper Panel	4502072	KK 1	Grease Clip	5156607
L 1	Lower Panel	4502073	LL 1	Sideburner Valve Cup	4154476
M 1	Tank Support	4502098			
N 1	Tank Retainer	4502113			
O 2	#10x1/2" Screw, Self-tap	4080043			
P 2	Pivot Pin	4080066			
Q 2	3/16 Pal Nut	4153096			
R 1	Ignitor Wire	4153184			
S 2	Leg Extender	4154516			
T 2	Hitch Pin	4156515			
U 1	Carry-over Tube	4500227			
V 1	Right Leg	4502158			
W 1	Console Assembly	4530054			
X 1	Ignitor	5156113			
Y 1	Left Leg	4502159			
Z 1	Grill Bottom	4580316			
AA 2	Burner	5068016			
BB 1	Sideburner Ignitor Wire	5156110			