

# Panasonic®

## LCD TV Operating Instructions

---

Model No. **TC-20LA2**  
**TC-20LA2D**

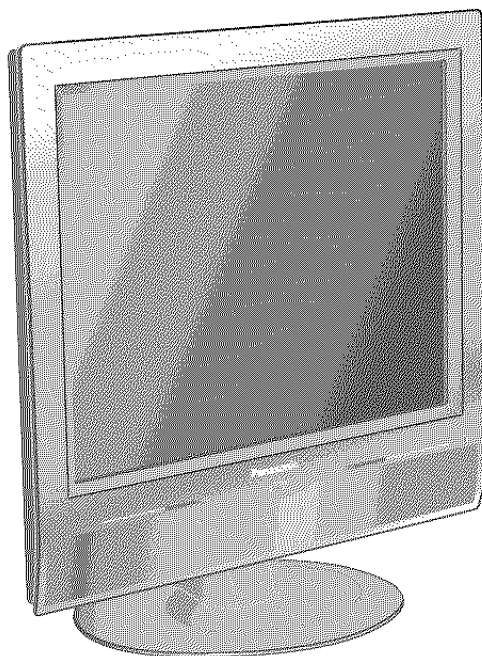

LCD TV shown above is model TC-20LA2.

<p><b>For assistance, please call : 1-800-211-PANA (7262)</b> or send e-mail to : <a href="mailto:consumerproducts@panasonic.com">consumerproducts@panasonic.com</a> or visit us at <a href="http://www.panasonic.com">www.panasonic.com</a> (U.S.A)</p>
<p><b>For assistance, please call : 787-750-4300</b> or visit us at <a href="http://www.panasonic.com">www.panasonic.com</a> (Puerto Rico)</p>
<p><b>For assistance, please call : 1-800-561-5505</b> or visit us at <a href="http://www.panasonic.ca">www.panasonic.ca</a> (Canada)</p>

Before connecting, operating or adjusting this product, please read these instructions completely.  
Please keep this manual for future reference.

**English**

**Español** [Resumen]

TOBC0758

# Important Safety Instructions

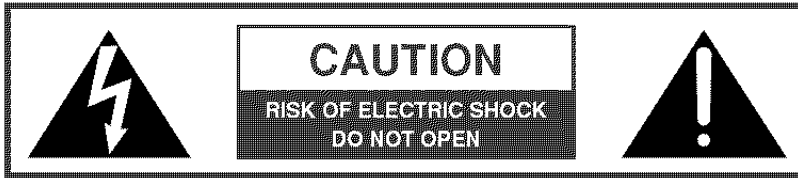

The lightning flash with arrow head within a triangle is intended to tell the user that parts inside the product are a risk of electric shock to persons.



The exclamation point within a triangle is intended to tell the user that important operating and servicing instructions are in the papers with the appliance.

- **Note to CATV System Installer:** This reminder is provided to direct the CATV system installer's attention to Article 820-40 of the NEC that provides guidelines for proper grounding and, in particular, specifies that the cable ground shall be connected to the grounding system of the building, as close to the point of cable entry as practical.

## ■ Important Safety Instructions for LCD TV

- 1) Read these instructions. All the safety and operating instructions should be read before the appliance is operated.
- 2) Keep these instructions.
- 3) Heed all warnings.
- 4) Follow all instructions.
- 5) Do not use this apparatus near water. For example: Avoid placing it near a bathtub, washbowl, kitchen sink, or laundry tub, in a wet basement, or near a swimming pool, etc.
- 6) Clean only with dry cloth. Unplug this LCD TV from the wall outlet before cleaning. Do not use liquid or aerosol cleaners.
- 7) Do not block any ventilation openings. Install in accordance with the manufacturer's instructions. Slots and openings in the cabinet and the back or bottom are provided for ventilation, and to ensure reliable operation of the LCD TV and to protect it from overheating. These openings must not be blocked or covered. There should be at least 10 cm of space from these openings. The openings should never be blocked by placing the LCD TV on a bed, sofa, rug or other similar surface. This LCD TV should not be placed in a built-in installation such as a bookcase unless proper ventilation is provided.
- 8) Do not install near any heat sources such as radiators, heat registers, stoves, or other apparatus (including amplifiers) that produce heat.
- 9) Do not defeat the safety purpose of the polarized or grounding-type plug. A polarized plug has two blades with one wider than the other. A grounding type plug has two blades and a third grounding prong. The wide blade or the third prong are provided for your safety. If the provided plug does not fit into your outlet, consult an electrician for replacement of the obsolete outlet.
- 10) Protect the power cord from being walked on or pinched particularly at plugs, convenience receptacles, and the point where they exit from the apparatus.
- 11) Only use attachments/accessories specified by the manufacturer. Otherwise it may cause hazards.
- 12) Use only with the cart, stand, tripod, bracket, or table specified by the manufacturer, or sold with the apparatus. When a cart is used, use caution when moving the cart/apparatus combination to avoid injury from tip-over.
- 13) Unplug this apparatus during lightning storms or when unused for long periods of time. This will prevent damage to the receiver due to lightning and power-line surges.
- 14) Refer all servicing to qualified service personnel. Servicing is required when the apparatus has been damaged in any way, such as power-supply cord or plug is damaged, liquid has been spilled or objects have fallen into the apparatus, the apparatus has been exposed to rain or moisture, does not operate normally, or has been dropped.  
Upon completion of any service or repairs to this LCD TV, ask the service technician to perform routine safety checks to determine that the television is in safe operating condition.
- 15) Operate only from the type of power source indicated on the marking label. If you are not sure of the type of power supplied to your home consult your television dealer or local power company.
- 16) Follow all warnings and instructions marked on the LCD TV.
- 17) Never push objects of any kind into this LCD TV through cabinet slots as they may touch dangerous voltage points or short out parts that could result in a fire or electric shock. Never spill liquid of any kind on the LCD TV.



## Important Safety Instructions

18) If an outside antenna is connected to the television equipment, be sure the antenna system is grounded so as to provide some protection against voltage surges and built up static charges. In the U.S. Selection 810-21 of the National Electrical Code provides information with respect to proper grounding of the mast and supporting structure, grounding of the lead-in wire to an antenna discharge unit, size of grounding conductors, location of antenna discharge unit, connection to grounding electrodes, and requirements for the grounding electrode.

19) An outside antenna system should not be located in the vicinity of overhead power lines or other electric light or power circuits, or where it can fall into such power lines or circuits. When installing an outside antenna system extreme care should be taken to keep from touching such power lines or circuits as contact with them might be fatal.

20) Unplug this LCD TV from the wall outlet, and refer servicing to qualified service personnel under the following conditions:

- a. When the power cord or plug is damaged or frayed.
- b. If liquid has been spilled into the LCD TV.
- c. If the LCD TV has been exposed to rain or water.

d. If the LCD TV does not operate normally by following the operating instructions.

Adjust only those controls that are covered by the operating instructions as improper adjustment of other controls may result in damage and will often require extensive work by a qualified technician to restore the LCD TV to normal operation.

e. If the LCD TV has been dropped or the cabinet has been damaged.

f. When the LCD TV exhibits a distinct change in performance - this indicates a need for service.

21) When replacement parts are required, be sure the service technician to use replacement parts specified by the manufacturer that have the same characteristics as the original part. Unauthorized substitutions may result in fire, electric shock, or other hazards.

22) **WARNING: TO REDUCE THE RISK OF FIRE OR ELECTRIC SHOCK, DO NOT EXPOSE THIS APPARATUS TO RAIN OR MOISTURE.**

**DO NOT PLACE LIQUID CONTAINERS (FLOWER VASES, CUPS, COSMETICS, ETC.) ABOVE THE SET. (INCLUDING ON SHELVES ABOVE, ETC.)**

23) **CAUTION: TO PREVENT ELECTRIC SHOCK DO NOT USE THIS PLUG WITH A RECEPTACLE OR OTHER OUTLET UNLESS THE BLADES CAN BE FULLY INSERTED TO PREVENT BLADE EXPOSURE.**

24) **CAUTION: USE WITH OTHER STAND MAY RESULT IN INSTABILITY CAUSING POSSIBLE INJURY.**

25) **CAUTION: DANGER OF EXPLOSION IF BATTERY IS INCORRECTLY REPLACED. REPLACE ONLY WITH THE SAME OR EQUIVALENT TYPE.**

EXAMPLE OF ANTENNA  
GROUNDING AS PER (NEC)  
NATIONAL ELECTRICAL  
CODE

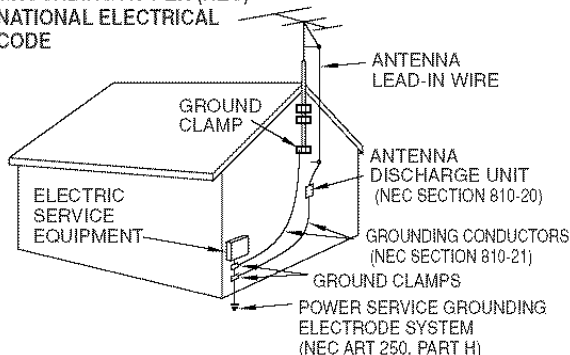

**NOTE:** ● This equipment is designed to operate in the U.S.A. and other countries where the broadcasting system and AC house current is exactly the same as in the U.S.A.

- The marking or retained image on the LCD panel resulting from fixed image use is not an operating defect and as such is not covered by Warranty. This product is not designed to display fixed image patterns for extended periods of time.

### ■ Important Information Regarding Use of Video Games, Computers, Captions or Other Fixed Image Displays.

The extended use of fixed image program material can cause a permanent "shadow image" on the LCD panel. This background image is viewable on normal programs in the form of a stationary fixed image. This type of irreversible LCD panel deterioration can be limited by observing the following steps:

- A. Reduce the brightness/contrast setting to a minimum viewing level.
- B. Do not display the fixed image for extended periods of time.
- C. Turn the power off when not in actual use.

■ This product utilizes tin-lead solder, and has a fluorescent lamp containing a small amount of mercury. Disposal of these materials may be regulated in your community due to environmental considerations. For disposal or recycling information please contact your local authorities, or the Electronics Industries Alliance: [www.eiae.org](http://www.eiae.org).

# Dear Panasonic Customer

*Welcome to the Panasonic family of customers.*

*We hope that you will have many years of enjoyment from your new LCD TV. To obtain maximum benefit from your set, please read these instructions before making any adjustments, and retain them for future reference. Retain your purchase receipt, and record the model number and serial number of your set in the space provided on the rear cover of these instructions.*

<b>For assistance, please call : 1-800-211-PANA (7262)</b> or send e-mail to : <a href="mailto:consumerproducts@panasonic.com">consumerproducts@panasonic.com</a> or visit us at <a href="http://www.panasonic.com">www.panasonic.com</a> (U.S.A.)
<b>For assistance, please call : 787-750-4300</b> or visit us at <a href="http://www.panasonic.com">www.panasonic.com</a> (Puerto Rico)
<b>For assistance, please call : 1-800-561-5505</b> or visit us at <a href="http://www.panasonic.ca">www.panasonic.ca</a> (Canada)

Federal Communication Commission Information

This equipment has been tested and found to comply with the limits for a TV Broadcast Receiver, pursuant to Part 15 of the FCC Rules. These limits are designed to provide reasonable protection against harmful interference in a residential installation. This equipment generates, uses and can radiate radio frequency energy and, if not installed and used in accordance with the instructions, may cause harmful interference to radio communications. If this equipment does cause or receive interference, which can be determined by turning equipment off and on, the user is encouraged to try to correct the interference by one of the following measures:

- Reorient or relocate the TV antenna.
- Increase the separation between TV and other equipment.
- Connect TV into separate outlet from other equipment.
- Consult the dealer or an experienced radio/TV technician for help.

FCC Caution: Any changes or modifications not expressly approved by the party responsible for compliance could void the user's authority to operate this equipment.



The Energy Star label, a symbol for energy efficiency, was created by the U.S. Environmental Protection Agency (EPA) and the U.S. Department of Energy (DOE) to help customers identify products that can save them money and protect the environment by saving energy. Energy Star compliant products generally consume less energy than similar standard products.

# Table of Contents

<b>Important Safety Instructions</b> .....	2
<b>Installation</b> .....	6
<b>SUPPLIED ACCESSORIES</b> .....	7
Remote control battery installation .....	7
<b>Maintenance</b> .....	8
<b>Connections</b> .....	8
Antenna Connection .....	8
Cable Box Connection .....	9
Connecting Other Equipment .....	10
Connecting Headphones / Earphones .....	11
<b>Power ON / OFF</b> .....	12
Connecting the Plug to the Wall Outlet .....	12
Turning the Power On .....	12
<b>Basic Controls</b> .....	13
<b>Menu Operations</b> .....	14
Tuning Channels .....	16
LOCK .....	18
CLOSED CAPTION .....	22
INPUT LABEL .....	23
OTHER ADJUST .....	23
PICTURE ADJUST .....	24
AUDIO ADJUST .....	25
<b>ASPECT Controls</b> .....	26

## Manual de instrucciones [ Resumen ]

<b>Instalación de las pilas del mando a distancia</b> .....	27
<b>Ajuste el soporte con el ángulo deseado</b> ...	28
<b>Conexión</b> .....	29
Conexión de antena .....	29
Conexión de antena / cable .....	29
Conexión del receptor de TV por cable .....	30
Conexión de auriculares .....	31
<b>Conexión/desconexión de la alimentación</b> ...	32
Conexión de la clavija a la toma de corriente ...	32
Cómo conectar la alimentación .....	32
<b>Controles básicos</b> .....	33
<b>Operaciones con menús</b> .....	34
Sintonización de canales .....	36

<b>Troubleshooting</b> .....	38
<b>Specifications</b> .....	39

# Installation

## Receiver Location

Locate for comfortable viewing. Avoid placing where sunlight or other bright light (including reflections) will fall on the screen.

Use of some types of fluorescent lighting can reduce remote control transmitter range.

Adequate ventilation is essential to prevent internal component failure. Keep away from areas of excessive heat or moisture.

## Optional External Equipment

The Video/Audio connection between components can be made with shielded video and audio cables. For best performance, Antenna cables should utilize 75 ohm coaxial shielded wire. Cables are available from your dealer or electronic supply store.

Before you purchase any cables, be sure you know what type of output and input connectors your various components require. Also determine the length of cable you'll need.

## For optimum quality picture

When the LCD is exposed to light from outdoors or lighting fixtures, high-contrast pictures may not be displayed clearly. Turn off florescent lamps near the LCD and place in a location not exposed to outdoor light.

## How to use the LCD stand

Adjust the stand to your desired angle.

### • TC-20LA2

The stand angle can be adjusted between 5° forward to 15° back, and rotated 30° to the right/left.

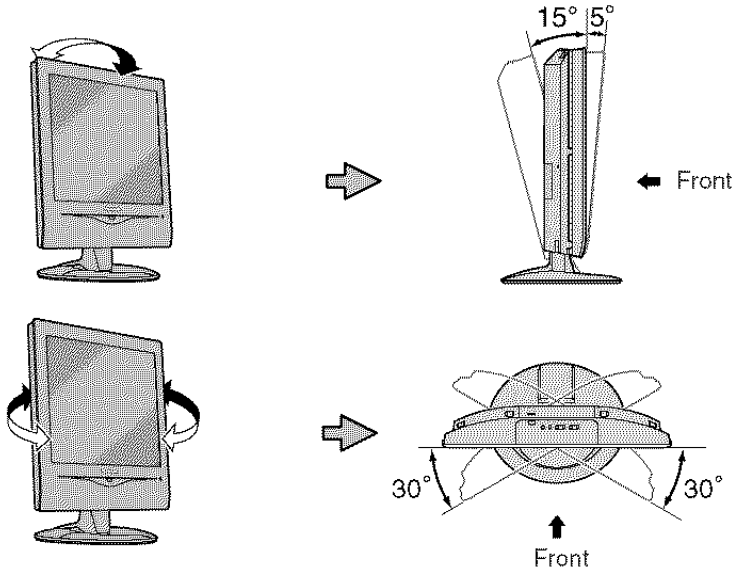

### • TC-20LA2D

The stand angle is fixed 14° back.

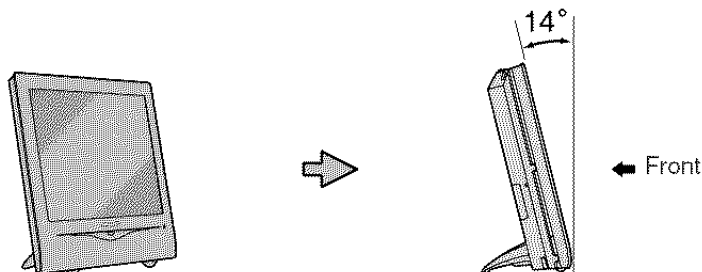

## SUPPLIED ACCESSORIES

Check the accessories before installations.

- Operating Instruction book

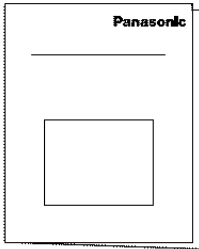

- Remote Control Transmitter (EUR7726020)

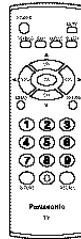

- Warranty Card

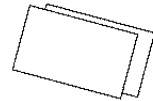

- Service Center List (For U.S.A.)

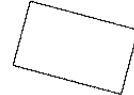

- Customer Card (For U.S.A.)

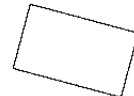

- Batteries for the Remote Control Transmitter (2 × AA size)



## Remote control battery installation

Requires two AA batteries.

1. Open the battery cover.

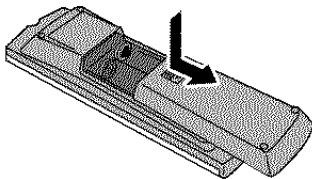

2. Install the batteries and replace the cover. Note the correct polarity (+ and -).

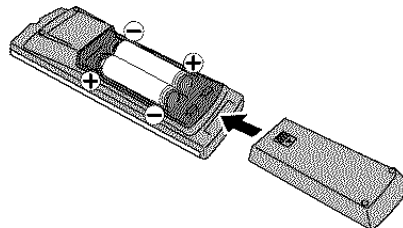

### ⚠ Precaution on battery use

Incorrect installation can cause battery leakage and corrosion that will damage the remote control transmitter.

**Observe the following precautions:**

1. Always use new batteries when replacing the old set.
2. Do not attempt to charge, short-circuit, disassemble, heat or burn used batteries.
3. Battery replacement is necessary when remote control acts sporadically or fails to operate this unit.

**Notes:**

- Do not drop, apply shock to or step on the remote control.
- Do not spill water on the remote control.
- Do not place objects between the remote control and remote control receiver.
- Do not use remote controls for other equipment at the same time.
- If the TV does not operate even when using the remote control from a close range, it is time to replace the batteries. Refer to the label on back of the remote control for directions on replacing batteries.

# Maintenance

To clean this unit, wipe with a soft, dry cloth.

If the surfaces are extremely dirty, use a soft cloth dipped in a soap and water solution or a weak detergent solution.

- Use eyeglass cleaner to remove stubborn dirt from the LCD.
- Never use alcohol, paint thinner or benzine to clean this unit.
- Before using a chemically treated cloth, read the instructions that came with the cloth carefully.

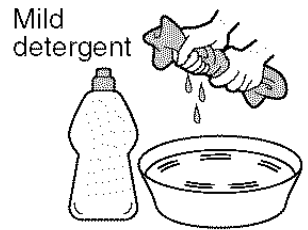

## CAUTION :

If water or similar substances get inside the monitor via the liquid crystal panel surface, a malfunction may result.

# Connections

## Note:

Cables and adapters are not supplied with this set.

## Antenna Connection

For proper reception of VHF/UHF channels, an external antenna is required. For best reception, an outdoor antenna is recommended. The antenna mode must be set to TV (see page 16, MODE).

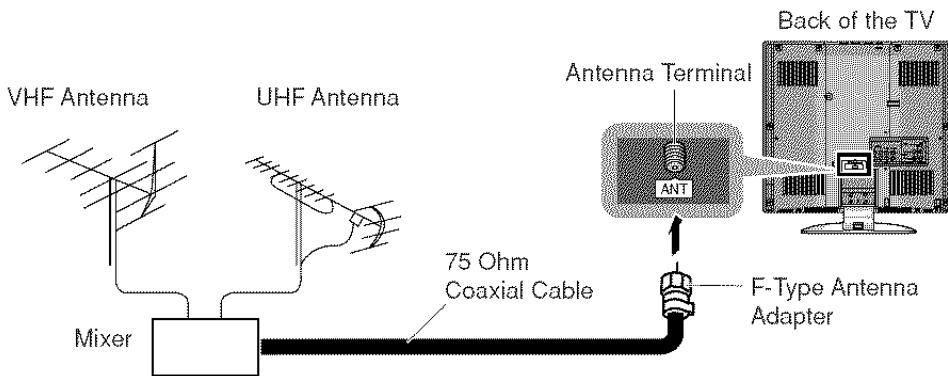

## ■ Antenna / Cable Connection

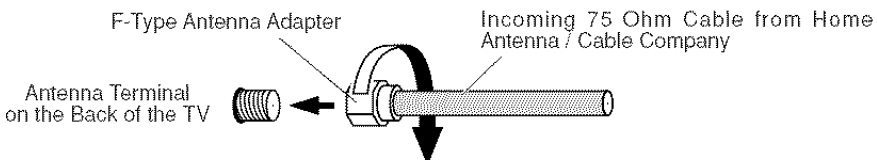



## Cable Box Connection

- For reception of cable channels (01 - 125), connect the cable supplied by your local cable company. The antenna mode must be set to CABLE (see page 16, MODE).
- Certain cable systems offset some channels to reduce interference or have Premium (scrambled) channels. A cable converter box is required for proper reception. Check with your local cable company for its compatibility requirements.
- Set the TV channel to CH3 or CH4, cable when using this connection.

### Cable Box

Back of the TV

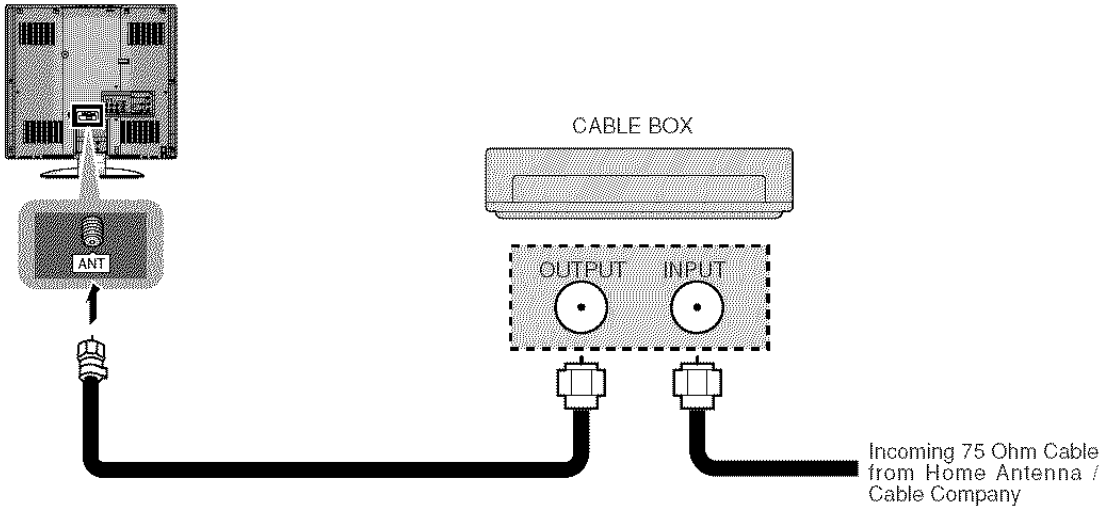

### Cable Box and VCR

Back of the TV

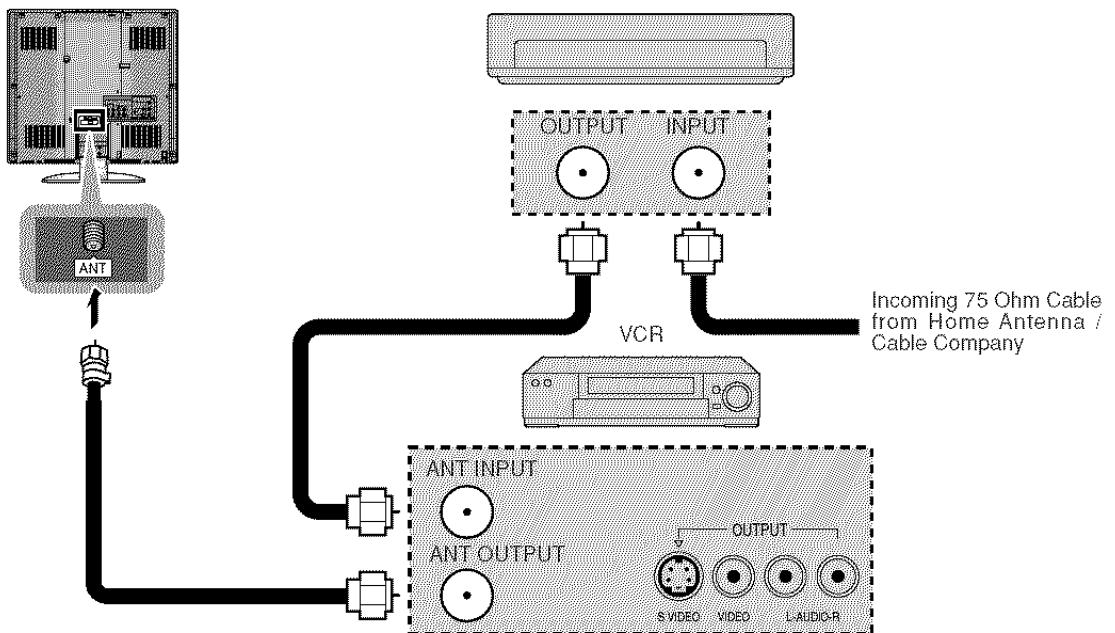

## Connecting Other Equipment

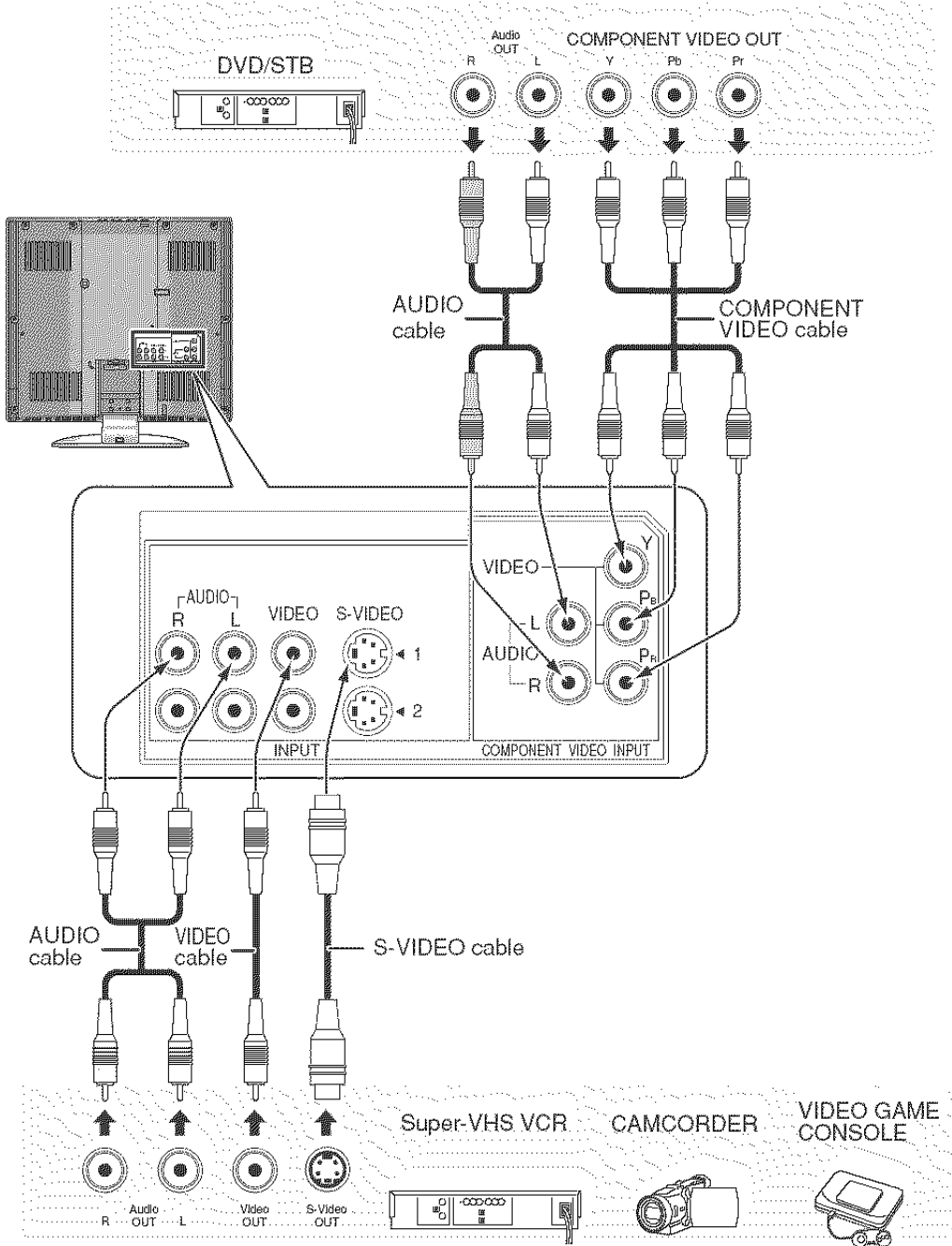

### Notes:

- Only 480i and 480p are available through the component input terminals.
- When connecting video cables, priority is given to the S-Video cable when both the S-VIDEO input terminal and the VIDEO input terminal are connected.
- With a monaural VCR, connect the monaural audio cable to the AUDIO-L terminal.
- Please make inquiries to video game manufacturers concerning component cables to connect with video game console.

## ■ To bundle the cables with the clumper [TC-20LA2]

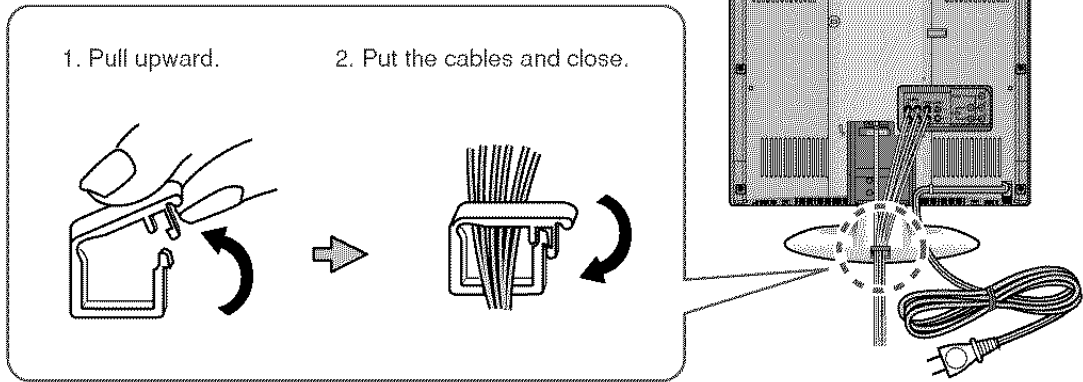

### Note:

- Do not put the antenna cable and the power cord together to avoid noise.

## Connecting Headphones / Earphones

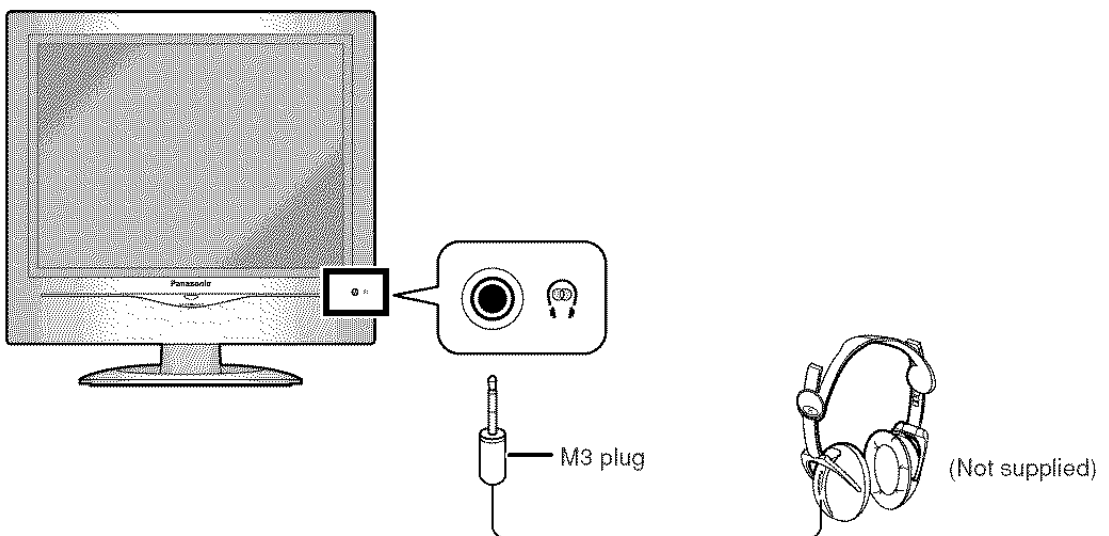

# Power ON / OFF

## Connecting the Plug to the Wall Outlet

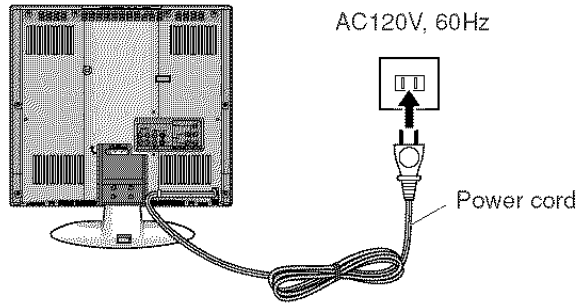

**Note:**

- The TV consumes some power as long as the power cord is inserted into the wall outlet.

## Turning the Power On

**Main Power switch**

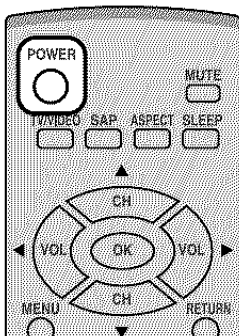
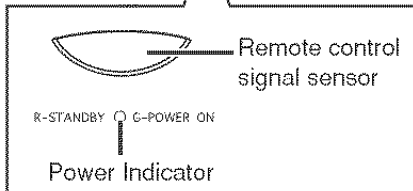
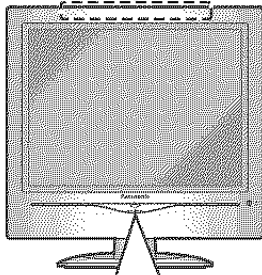

**On the main unit**



Press to turn the TV's main power on/off.

- Power indicator  
Main power ON: Green  
Main power OFF: No light

The screen below is displayed for a while when the TV is turned on.

e.g.

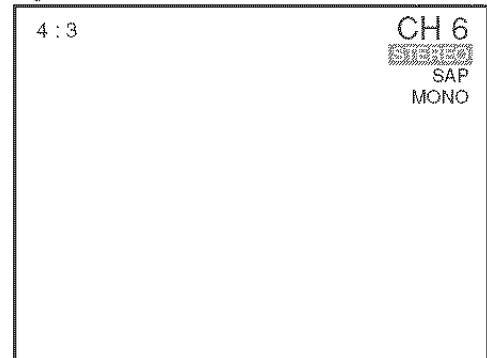

**On the remote control**

POWER



Press to turn the TV on/off.

- Power indicator  
Power ON: Green  
Power OFF (Standby): Red
- This does not work when the main power is off (No light) (see above).

**Note:**

- Select the menu language before operating the TV (see page 15, LANGUAGE).

# Basic Controls

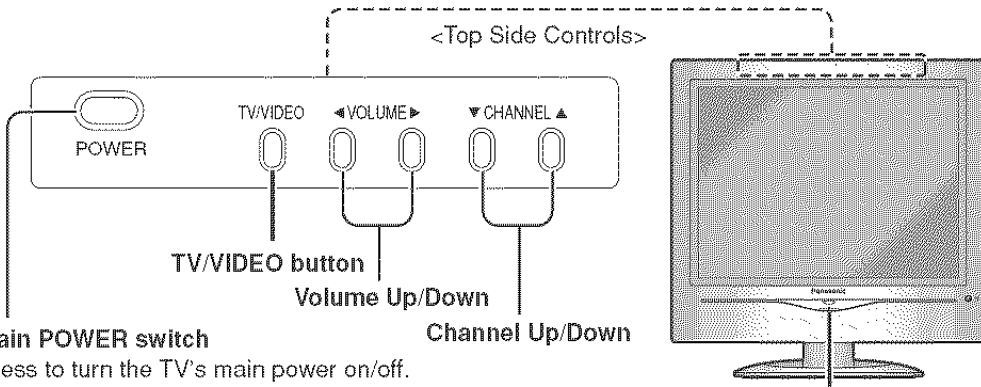

## Main POWER switch

Press to turn the TV's main power on/off.  
(see page 12)

## Remote control sensor

Within about 20 feet (6 meters) in front of the TV set.

## POWER button

Press to turn the TV on or off.  
(see page 12)

### Note:

This does not work when the main power is off (No light).

## TV/VIDEO button

Press to change the input mode.

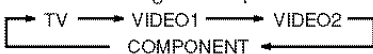

## SAP button

Press to select the audio mode. You can also change the mode in the MENU screen (see page 25).

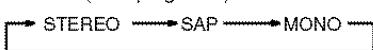

## MENU button

(see page 14)

## RETURN button

Press to return to the previous screen.

## Numbered buttons

## R-TUNE button

Switches to previously viewed channel or video mode.

## MUTE button

Press to mute the sound.

Press again to cancel mute.

Mute is canceled when the power is turned off or volume level is changed.

## ASPECT button

(see page 26)

## SLEEP button

Set the sleep time to turn the TV into standby mode.

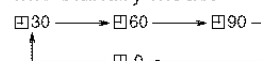

- When 3 minutes left, " 3 " will flash. ("2" for 2 minutes and "1" for 1 minute).
- The SLEEP timer is cancelled when the power is turned off.

## Channel up

Moves cursor upward during menu mode.

Reduces volume  
Moves cursor to the left during menu mode.

Increases volume  
Moves cursor to the right during menu mode.



## Channel down

Moves cursor downward during menu mode.

## RECALL button

Press to display channel number, sleep timer and other options.

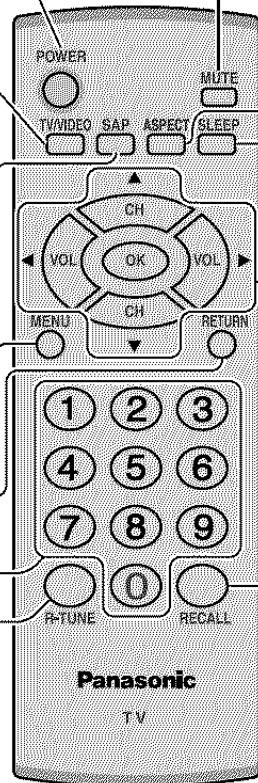

# Menu Operations

1

Press to display MENU screen.

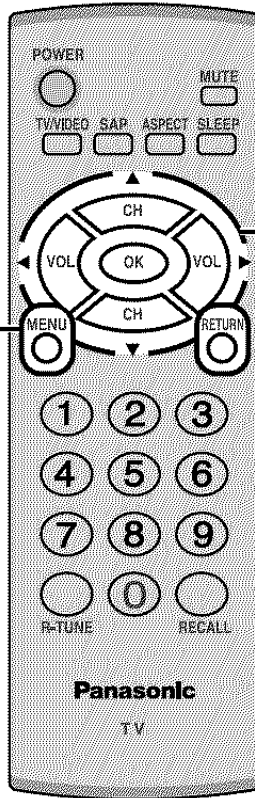
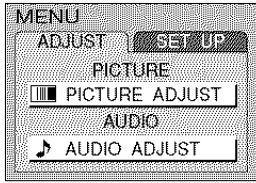

2

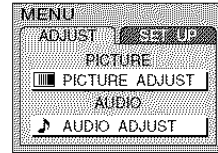

or

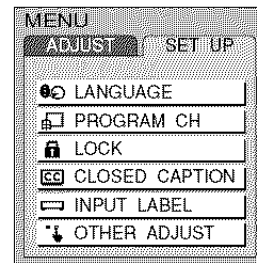
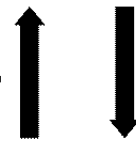
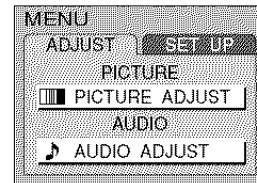
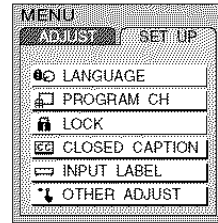

## ON SCREEN HELP 'Instruction' box

An On Screen Help box is displayed when a menu is displayed on the TV. This Help box indicates which keys on the remote control are used to navigate the menu shown.

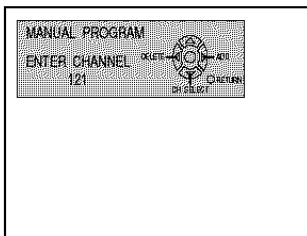

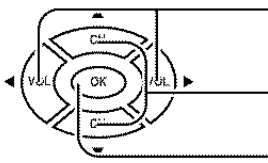

Press to select the MENU screen (ADJUST or SET UP).

Press to select the sub-menu feature.

Press to display the sub-menu screen.

- To return to the previous screen :  RETURN
- To exit the MENU screen:  MENU This returns to the normal viewing.

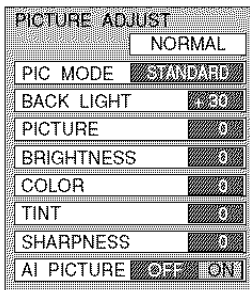

(See page 24)

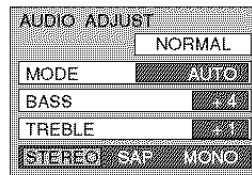

(See page 25)



Select the menu language.

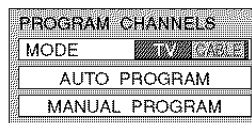
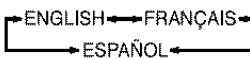

(See pages 16,17)

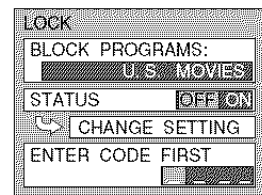

(See page 18 - 21)

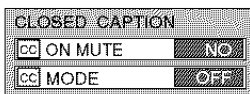

(See page 22)

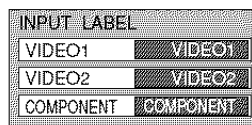

(See page 23)

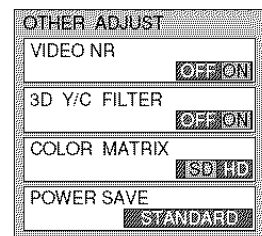

(See page 23)





## Manual channel programming

Add or delete a channel manually.

4

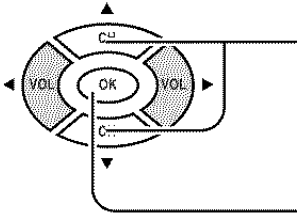

Press to select MANUAL PROGRAM.

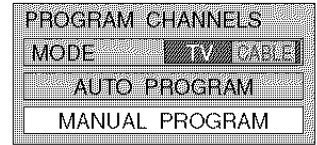

Press to display the MANUAL PROGRAM screen.



5

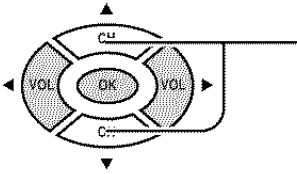

Press to select the channel.

• You can also use the numbered buttons.

6

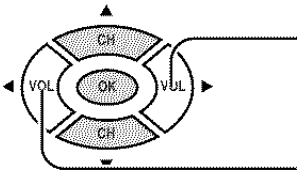

Press to add the channel to the Channel Memory (the channel number turns blue).

Press to delete the channel from the Channel Memory (the channel number turns yellow).

• Repeat steps 5 and 6 for other channels.

## LOCK

In the United States, the V-CHIP consists of two rating systems, which are MPAA (MOTION PICTURE) and TV PARENTAL GUIDELINES. Its function is to block programs by the rating data in the XDS data packets sent from broadcasting stations. The user can select which rating programs should be blocked by the LOCK MENU options.

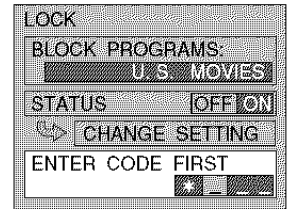
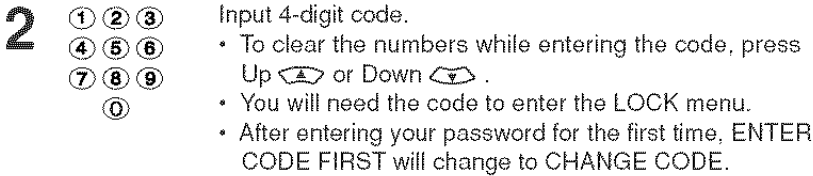
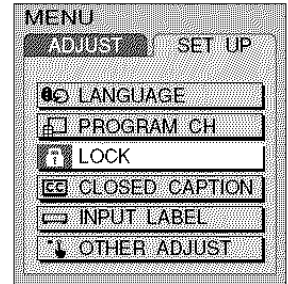
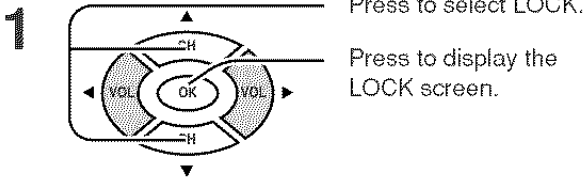

**Note:**

Use a code that is easy to remember and record it in a safe place.

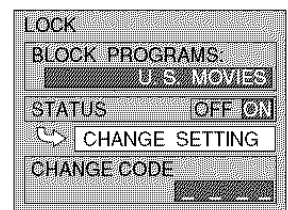
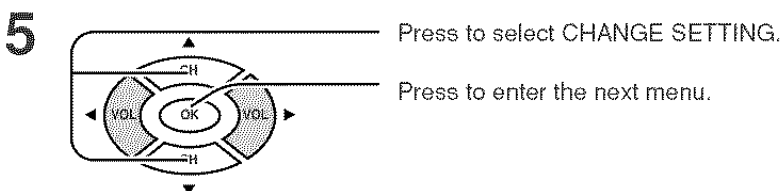
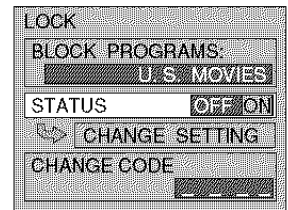
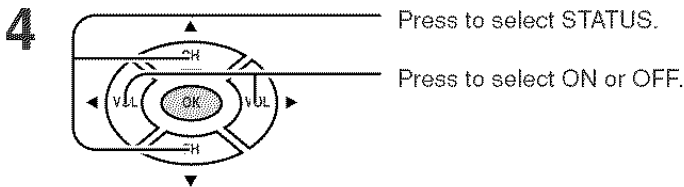
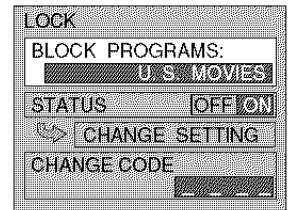
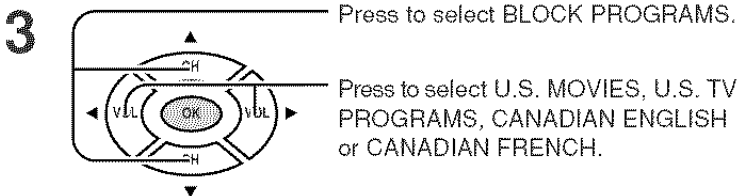

## U.S. TV PROGRAM

6

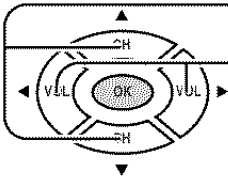

Press to select VIEW NR PROGRAMS?.

Press to select NO or YES.

NO : Cannot view programs with NR signals.

YES : Can view programs with NR signal.

7

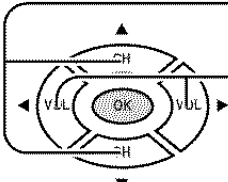

Press to select SETTING.

Press to select BASIC or DETAILED.

8

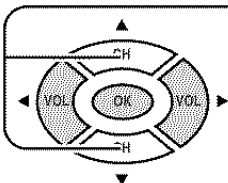

Press to select the rating.

BASIC : You can select the titles.

DETAILED : You can select the titles and options.

- When a title field is selected, all ratings below this rating are selected.  
When options within an option field are selected, ratings below this rating within the same field are selected.

9

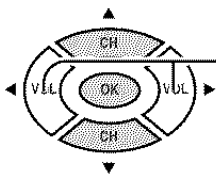

Press to lock or unlock the rating.

Lock : Red

Unlock : Green

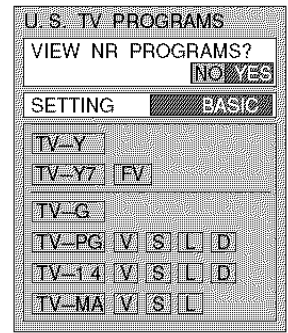

Title      Option

### Rating

1. Ratings for children: Divided into ranks as follows.

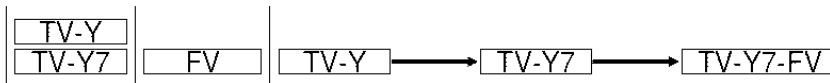

2. Ratings for teenagers: Created out of these major categories to form various combinations. These combinations are described in the below diagram. Ratings for all ages are on top and ratings for adults are on the bottom.

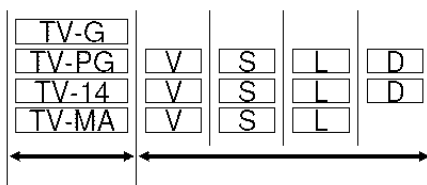

# Menu Operations

## U.S. MOVIES

6

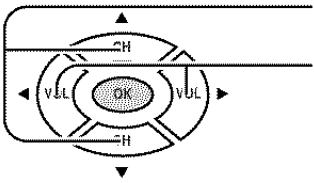

Press to select VIEW NR PROGRAMS?.

Press to select NO or YES.

NO : Cannot view programs with NR signals.  
YES : Can view programs with NR signals.

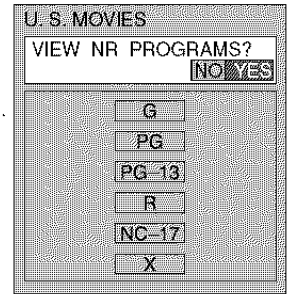

7

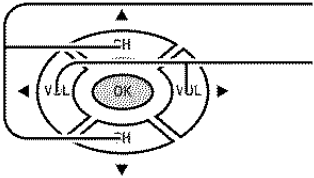

Press to select the rating.

Press to lock or unlock the rating.

Lock : Red

Unlock : Green

### Rating

G : General audience

PG : Parental guidance suggested

PG-13 : Parental guidance needed  
under 13 years old

R : Restricted

NC-17 : No one under 17 is admitted

X : Pornography

## CANADIAN ENGLISH / CANADIAN FRENCH

6

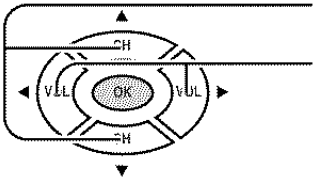

Press to select VIEW E PROGRAMS?.

Press to select NO or YES.

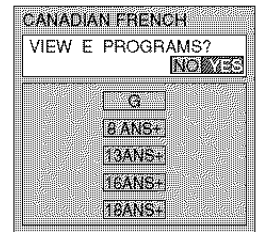
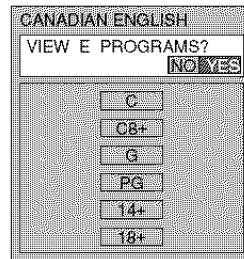

7

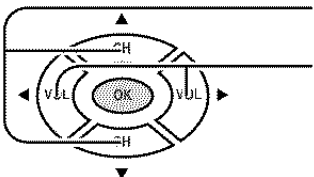

Press to select the rating.

Press to lock or unlock the rating.

Lock : Red

Unlock : Green

## CANADIAN ENGLISH RATINGS CHART

<b>E</b>	Exempt - Exempt programming includes: news, sports, documentaries and other information programming, talk shows, music videos, and variety programming.
<b>C</b>	Programming intended for children under age 8. No offensive language, nudity or sexual content.
<b>C8+</b>	Programming generally considered acceptable for children 8 years and over. No profanity, nudity or sexual content.
<b>G</b>	General programming, suitable for all audiences.
<b>PG</b>	Parental Guidance suggested. Some material may not be suitable for children.
<b>14+</b>	Programming contains themes or content which may not be suitable for viewers under the age of 14. Parents are strongly cautioned to exercise discretion in permitting viewing by pre-teens and early teens.
<b>18+</b>	General programming, suitable for all audiences.

## CANADIAN FRENCH RATINGS CHART

<b>E</b>	Exempt - Exempt programming.
<b>G</b>	General - Programming intended for audience of all ages. Contains no violence, or the violence content is minimal or is depicted appropriately.
<b>8 ANS+</b>	8+ General - Not recommended for young children. Programming intended for a broad audience but contains light or occasional violence. Adult supervision recommended.
<b>13ANS+</b>	Programming may not be suitable for children under the age of 13 - Contains either a few violent scenes or one or more sufficiently violent scenes to affect them. Adult supervision strongly suggested.
<b>16ANS+</b>	Programming may not be suitable for children under the age of 16 - Contains frequent scenes of violence or intense violence.
<b>18ANS+</b>	18+ ans Programming restricted to adults. Contains constant violence or scenes of extreme violence.

## CLOSED CAPTION

This unit has a built in decoder that provides a visual depiction of the audio portion of a television program in the form of written words across the screen (white or colored letters on a black background). It allows you to read the dialogue of a television program or other information.

**1**

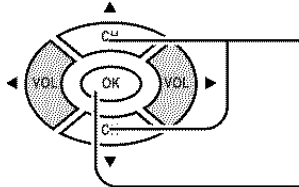

Press to select CLOSED CAPTION.

Press to display the CLOSED CAPTION screen.

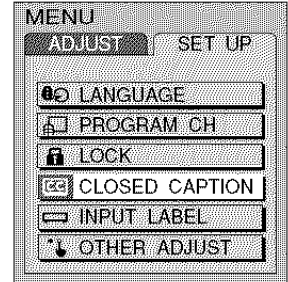

### CC ON MUTE

Displays the On-Screen Closed Caption when the MUTE button is pressed. To delete the closed caption, press the MUTE button again.

**2**

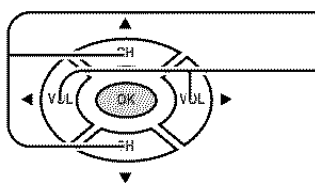

Press to select **CC** ON MUTE.

Press to select NO (OFF), C1 or C2.

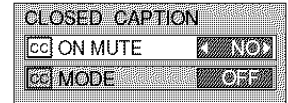

#### Notes:

- To activate this feature, set **CC** MODE to OFF.
- The program must have Closed Caption.

### CC MODE

Displays the On-Screen Closed Caption.

**2**

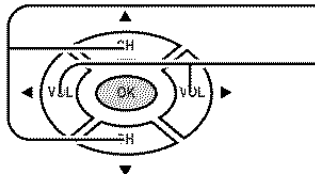

Press to select **CC** MODE.

Press to select OFF, C1 or C2.

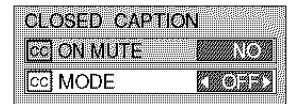

- OFF** - Recommended mode when Closed Caption is not being used.
- C1** - For video related information that can be displayed (up to 4 lines of script strategically placed on the television screen so that it does not obstruct relevant parts of the picture).
- C2** - Another mode used for video related information.

## INPUT LABEL

You can change the label of the video inputs to match with the connected device (VCR, DVD player etc.).

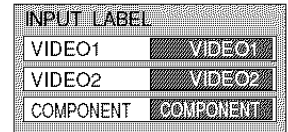
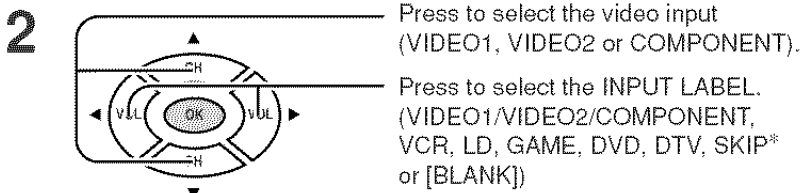
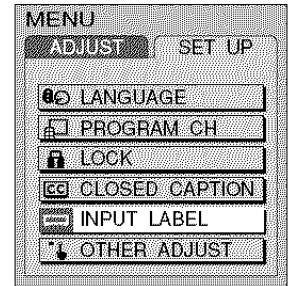
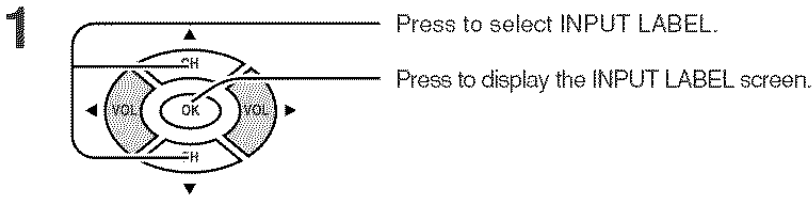

\* Select to skip unused video input when pressing TV/VIDEO button.

## OTHER ADJUST

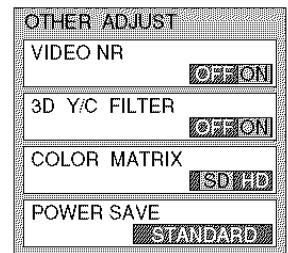
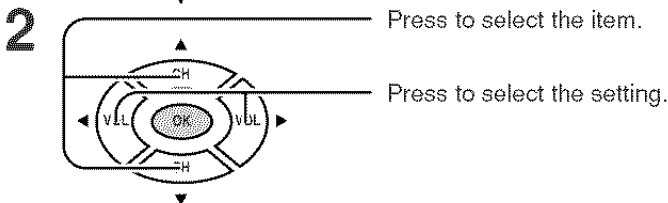
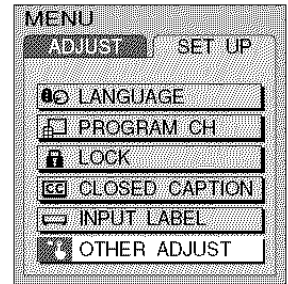
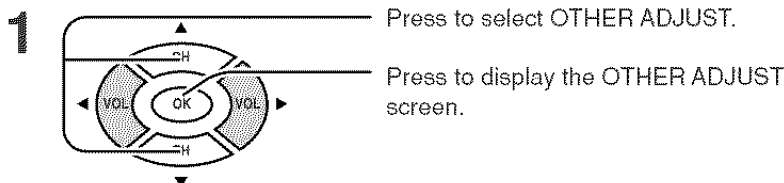

### VIDEO NR

Reduce video noise in the picture.

OFF ↔ ON

### 3D Y/C FILTER

Minimizes noise and cross color in the picture. Not available for COMPONENT VIDEO INPUT and S-VIDEO INPUT.

OFF ↔ ON

### COLOR MATRIX

Displays input signals (480p signals) in a natural color. Automatically adjusts color parameters for HD (high definition) and SD (standard definition).

SD ↔ HD

### POWER SAVE

The POWER SAVE mode is suitable for watching television at night. Power consumption will be reduced.

STANDARD ↔ SAVING

## PICTURE ADJUST

1

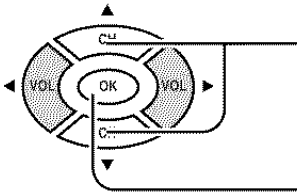

Press to select PICTURE ADJUST.

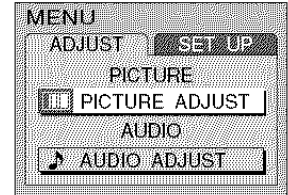

Press to display the PICTURE ADJUST screen.

2

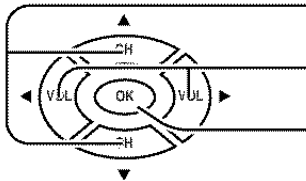

Press to select the sub-menu.

Adjust the setting watching the picture behind the menu.

Press to activate the setting if necessary.

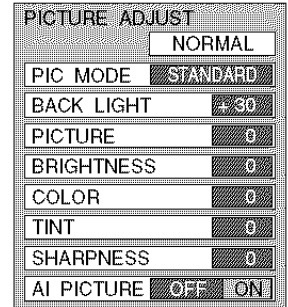

### NORMAL/NORMALIZE

Select "NORMALIZE" and press "OK" button to return each PIC MODE to the factory default setting.

#### Notes:

- "NORMAL" means the PIC MODE is in the factory default setting. "NORMAL" changes to "NORMALIZE" when you change the setting of BACK LIGHT, PICTURE, BRIGHTNESS, COLOR, TINT, SHARPNESS or AI PICTURE.
- You can normalize each PIC MODE separately.

### PIC MODE

The picture mode is stored for TV, VIDEO1, VIDEO2 and COMPONENT individually.

MODE	Function
VIVID	Displays a clear screen with high contrast.
STANDARD	Displays a standard image.
CINEMA	Ideal for watching movies in a dark room.

### BACK LIGHT, PICTURE, BRIGHTNESS, COLOR, TINT, SHARPNESS, AI PICTURE

You can change the sub-menu settings (BACK LIGHT, PICTURE, BRIGHTNESS, COLOR, TINT, SHARPNESS and AI PICTURE) for each PIC MODE (STANDARD, CINEMA, and VIVID) according to your personal preference.

Sub-menu	Function
BACK LIGHT	Luminance of the back light is adjusted.
PICTURE	Selects proper brightness and density for the room.
BRIGHTNESS	Adjusts for easier viewing of dark pictures such as night scenes.
COLOR	Adjusts the level of color.
TINT	Adjusts for flesh tone color.
SHARPNESS	Adjusts the degree of sharpness.
AI PICTURE	Displays black and white more accurately when turned ON.



## AUDIO ADJUST

1

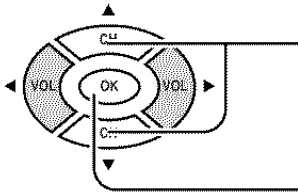

Press to select AUDIO ADJUST.

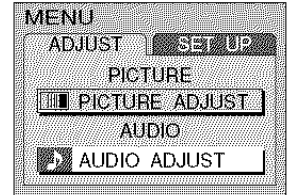

Press to display the AUDIO ADJUST screen.

2

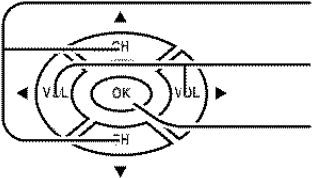

Press to select the sub-menu.

Select the setting listening to the sound.

Press to activate the setting if necessary.

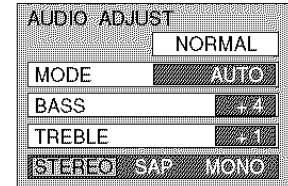

### NORMAL/NORMALIZE

Select "NORMALIZE" and press "OK" button to return each MODE to the factory default setting.

#### Notes:

- "NORMAL" means the MODE is in the factory default setting. "NORMAL" changes to "NORMALIZE" when you change the setting of BASS or TREBLE.
- You can normalize each MODE separately.

### MODE

MODE	Function
<b>DYNAMIC</b>	Gives contrast to sound.
<b>MUSIC</b>	For programs consisting mainly of music. Enhances high sounds (around 4 kHz).
<b>AUTO</b>	Automatically adjusts for a wide Dynamic Range.
<b>STANDARD</b>	Emits the original sound.

### BASS, TREBLE

You can change the level of each sub-menu (BASS and TREBLE) for each MODE (AUTO, STANDARD, DYNAMIC and MUSIC) according to your personal preference.

Sub-menu	Function
<b>BASS</b>	Adjusts low frequencies.
<b>TREBLE</b>	Adjusts high frequencies.

### STEREO/SAP/MONO

#### Note:

- Red display : With signal
- White display : No signal
- White display (All modes) : MONO
- To change the mode using SAP button (see page 13).

MODE	Function
<b>STEREO</b>	Two channel audio reception.
<b>SAP</b>	Second Audio Programming (typically used for bilingual audio).
<b>MONO</b>	Select when stereo signal is weak.

# ASPECT Controls

(For Video input only)

This feature allows you to enjoy viewing the picture at its maximum size, including wide screen cinema format picture.

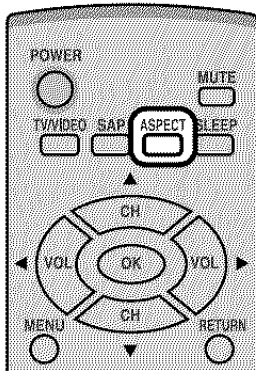

Each time you press the button:

4 : 3 ↔ 16 : 9

**Notes:**

- The aspect setting is stored separately for VIDEO1, VIDEO2 and COMPONENT.
- In TV mode, the aspect is fixed at 4:3.

Mode	Picture	Explanation
4 : 3		4:3 mode will display a 4:3 picture at its standard 4:3 size without any stretching.
16 : 9		16:9 mode will display 16:9 aspect ratio picture. Bars can be seen at the top and bottom of the image (not available in TV mode).

# Manual de instrucciones [ Resumen ]

## *Estimado cliente de Panasonic*

*Bienvenido a la familia de clientes de Panasonic.*

*Esperamos sinceramente que disfrute durante muchos años de su nuevo Esperamos sinceramente que disfrute durante muchos años de su nuevo televisor LCD.*

*Para obtener el máximo beneficio de su aparato, lea estas instrucciones antes de hacer cualquier ajuste, y guárdelas para poder utilizarlas como referencia en el futuro.*

*Guarde también el recibo de su compra, y anote el número del modelo y el número de serie de su aparato en el espacio provisto en la cubierta posterior de estas instrucciones.*

## Instalación de las pilas del mando a distancia

Se necesitan dos pilas AA.

1. Abra la cubierta de las pilas.

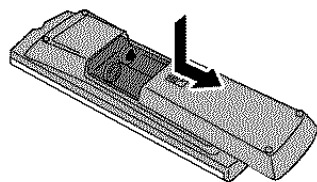

2. Instale las pilas y vuelva a poner la tapa. Tenga en cuenta las polaridades (+ y -) al instalar las pilas.

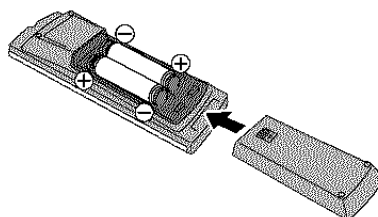

### **⚠ Precauciones relacionadas con la utilización de las pilas**

La instalación incorrecta de las pilas puede causar fugas en las mismas que podrían estropear el transmisor de mando a distancia.

**Tome las precauciones siguientes:**

1. Utilice siempre pilas nuevas cuando reemplace las viejas.
2. No intente cargar, cortocircuitar, desarmar, calentar o quemar las pilas usadas.
3. Las pilas deberán cambiarse cuando el mando a distancia funcione esporádicamente o no pueda controlar esta unidad.

# Ajuste el soporte con el ángulo deseado

## • TC-20LA2

El ángulo del soporte se puede ajustar entre  $5^\circ$  hacia delante y  $15^\circ$  hacia atrás, y se puede girar  $30^\circ$  hacia la derecha/izquierda.

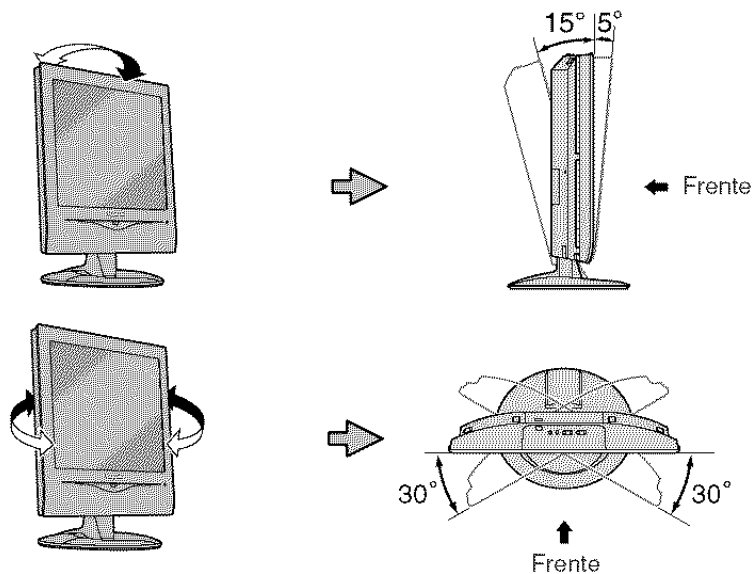

## • TC-20LA2D

El ángulo del soporte está fijado en  $14^\circ$  hacia atrás.

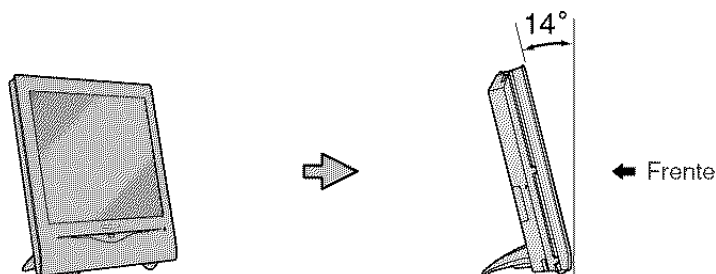

# Conexión

## Nota:

Con este aparato no se suministran cables ni adaptadores.

## Conexión de antena

Para recibir correctamente los canales de VHF/UHF se requiere una antena externa. Para obtener la mejor recepción se recomienda utilizar una antena para exteriores. El modo de antena debe ajustarse a TV (consulte la página 36, MODO).

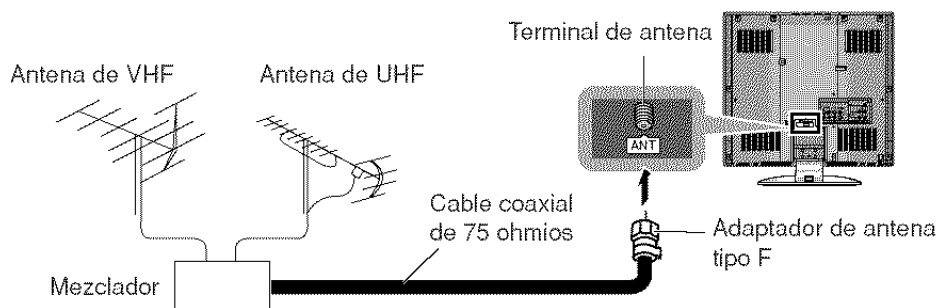

### ■ Conexión de antena / cable

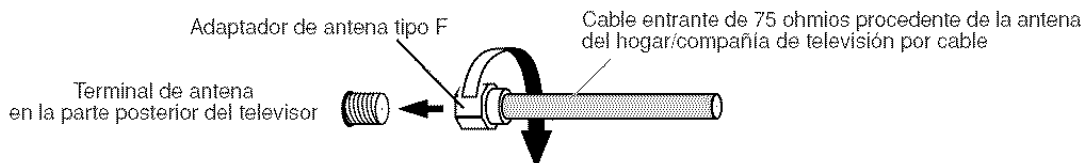

## Conexión del receptor de TV por cable

- Para recibir los canales de televisión por cable (01 - 125) conecte el cable suministrado por su compañía de televisión por cable. El modo de antena debe ajustarse a CABLE (consulte la página 36, MODO).
- Ciertos sistemas de televisión por cable neutralizan algunos canales para reducir interferencias o tienen canales especiales (codificados). Para recibir correctamente estos canales se necesita un sintonizador de conversión de televisión por cable. Póngase en contacto con su compañía de televisión por cable para conocer los requerimientos de compatibilidad.
- Ponga el canal del televisor en CH3 o CH4 cuando utilice esta conexión.

### Receptor de TV por cable

La parte posterior del televisor

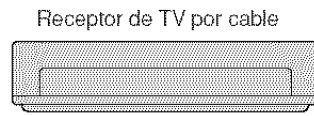
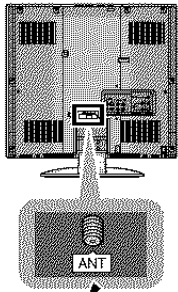

Cable entrante de 75 ohmios procedente de la antena del hogar/compañía de televisión por cable

### Cable Box and VCR

La parte posterior del televisor

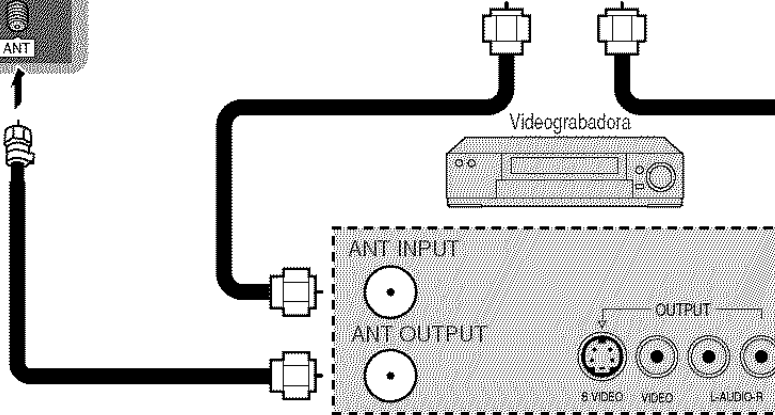
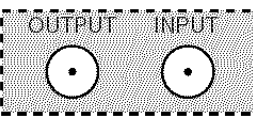
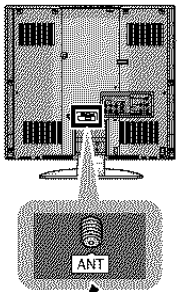

Cable entrante de 75 ohmios procedente de la antena del hogar/compañía de televisión por cable

## ■ Para unir y atar los cables con la abrazadera [TC-20LA2]



### Nota:

- No ponga el cable de la antena y el cable de la alimentación juntos para evitar ruidos.

## Conexión de auriculares

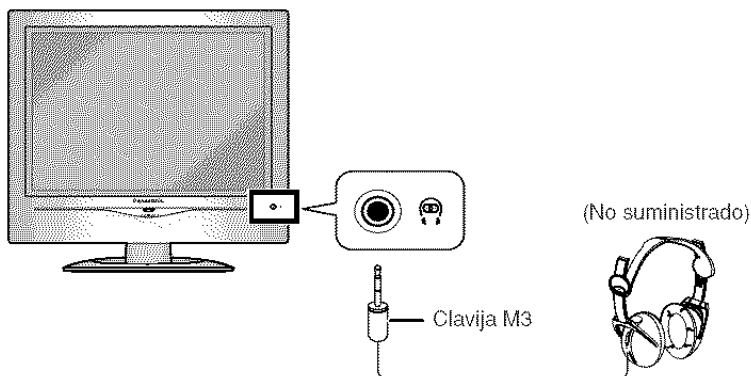

# Conexión/desconexión de la alimentación

## Conexión de la clavija a la toma de corriente

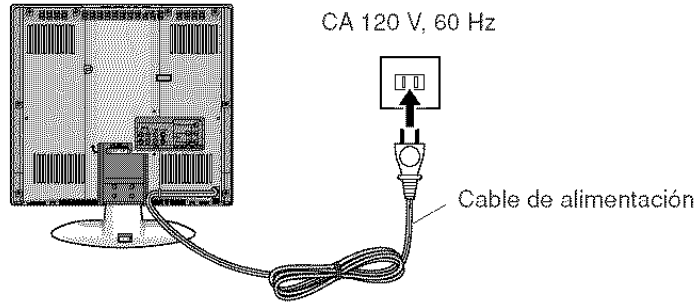

### Nota:

- El televisor consumirá algo de corriente siempre que el enchufe del cable de alimentación esté introducido en la toma de corriente.

## Cómo conectar la alimentación

### Interruptor POWER principal

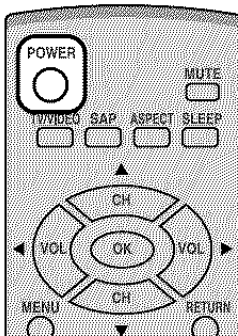
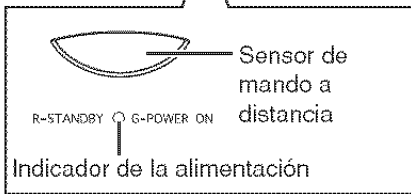
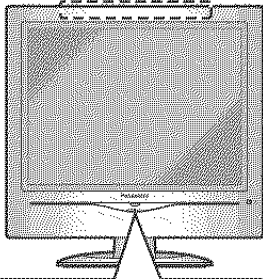
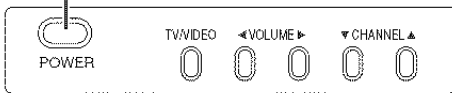

### En el aparato principal



Púlselo para conectar/desconectar la alimentación principal del televisor.

- Indicador de la alimentación

Alimentación principal conectada: Verde

Alimentación principal desconectada: Apagado

La pantalla de abajo se visualiza durante un rato cuando se enciende el televisor.

Ej.:

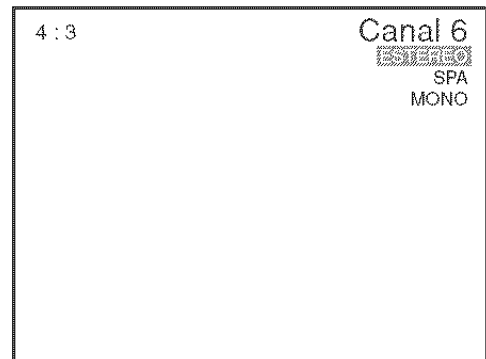

### En el mando a distancia



Púlselo para encender/apagar el televisor.

- Indicador de la alimentación

Encendido: Verde

Apagado (En espera): Rojo

- Esto no funciona cuando la alimentación principal está desconectada (apagado) (consulte arriba).

### Nota:

- Seleccione el idioma de menú antes de utilizar el televisor (consulte la página 35, Idioma).



# Controles básicos

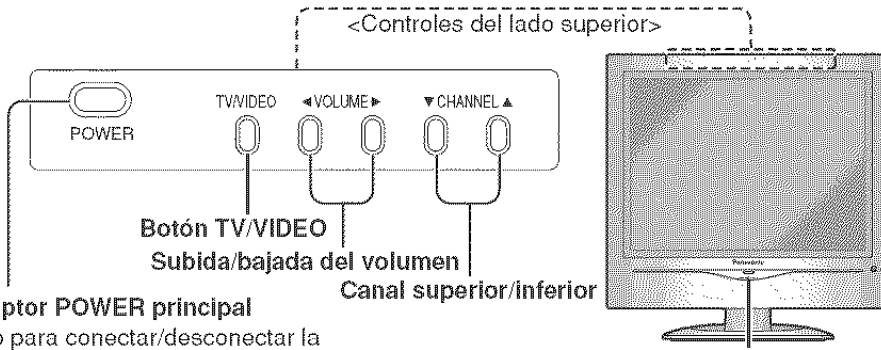

**Interruptor POWER principal**  
Púlselo para conectar/desconectar la alimentación principal del televisor (consulte la página 32).

**Sensor de mando a distancia**  
Dentro de 20 pies (6 metros) a partir del panel delantero del televisor.

**Botón MUTE**  
Púlselo para silenciar el sonido.  
Púlselo de nuevo para cancelar el silenciamiento.  
El silenciamiento se cancela cuando se desconecta la alimentación o se cambia en nivel del sonido.

**Botón de la alimentación**  
Púlselo para encender o apagar el televisor (consulte la página 32).  
**Nota:**  
Esto no funciona cuando la alimentación principal está desconectada (apagado).

**Botón TV/VIDEO**  
Púlselo para cambiar el modo de entrada.

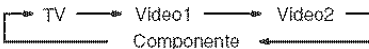

**Botón SAP**  
Púlselo para seleccionar el modo de audio. También puede cambiar el modo en la pantalla MENU (consulte la página 35).

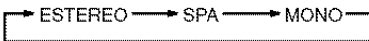

**Botón MENU**  
(consulte la página 34)

**Botón RETURN**  
Púlselo para volver a la pantalla anterior.

**Botones numerados**

**Botón R-TUNE**  
Para cambiar a un canal o modo de vídeo anterior.

**Botón ASPECT**  
4:3 ↔ 16:9

**Botón SLEEP**  
Ponga el tiempo tras el cual el televisor se pondrá en el modo de espera.



- Cuando queden 3 minutos parpadeará " 3 " ("2" para 2 minutos y "1" para 1 minuto).
- El temporizador de cancelado se cancelará cuando se desconecte la alimentación.

**Canal superior**  
Mueve el cursor hacia arriba durante el modo del menú.

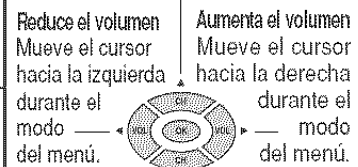

**Canal inferior**  
Mueve el cursor hacia abajo durante el modo del menú.

**Botón RECALL**  
Púlselo para visualizar el número del canal, el temporizador de cancelado y otras opciones.

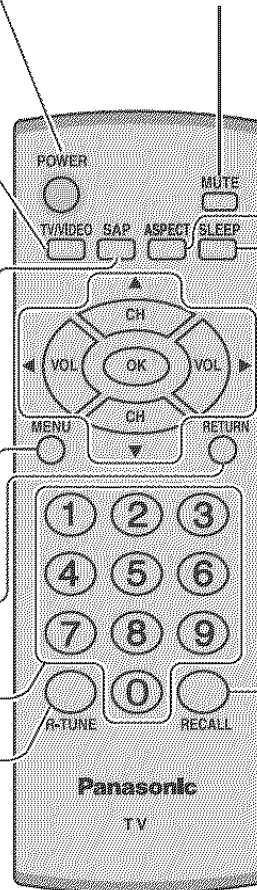

# Operaciones con menús

1

Púselo para visualizar la pantalla MENU.

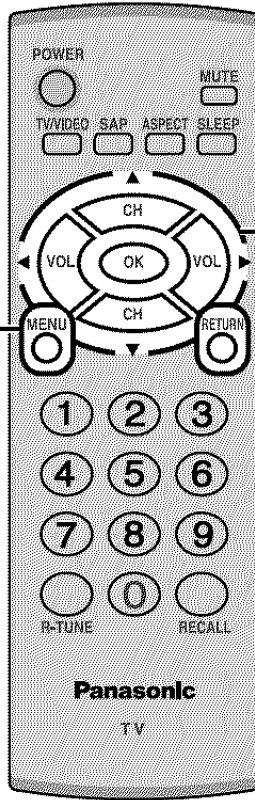
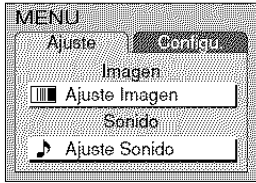

2

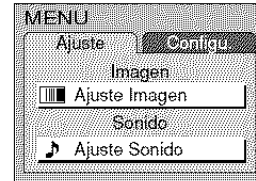
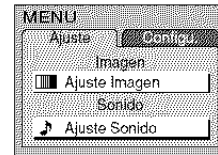

## Cuadro de instrucciones de ayuda en pantalla

Cuando se visualiza un menú en el televisor aparece un cuadro de ayuda en la pantalla. Este cuadro de ayuda indica qué teclas del mando a distancia se utilizan para navegar por el menú mostrado.

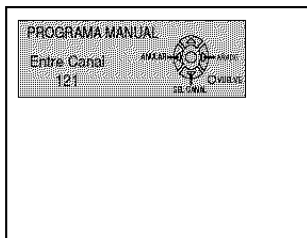

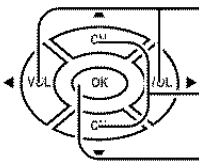

Púlselo para seleccionar la pantalla MENU (Ajuste o Configu.).

Púlselo para seleccionar la función de menú secundario.

Púlselo para visualizar la pantalla de menú secundario.

● Para volver a la pantalla anterior :  RETURN

● Para salir de la pantalla MENU :  MENU Con esto se retorna a la visión normal.

Ajuste Imagen

Normal

Imagen Normal

Luz Posterior +30

CONTRASTE 0

BRILLO 0

COLOR 0

TINTE 0

NITIDEZ 0

Imagen IA No SI

Ajuste Sonido

Normal

Sonido Auto

BAJOS +4

ALTOS +1

ESTEREO SPA MONO

Idioma

Idioma ESPAÑOL

Seleccione el idioma del menú.

ENGLISH FRANÇAIS

ESPAÑOL

Prog. Canales

MODO TV CABLE

PROGRAMA AUTO

PROGRAMA MANUAL

Bloqueo

Programas:

Felículas de EEUU

Activado No SI

Modificar

INGRESAR CLAVE

Subtítulos

EN MUDO No

MODO No

Ponga Títulos

Video1 Video1

Video2 Video2

Componente Componente

Otro Ajuste

REDUC DE RUIDO No SI

3D Y/C Filtro No SI

Matriz Color DS HD

ECON ENERGÍA ESTÁNDAR

## Sintonización de canales

1 Pulse el botón TV/VIDEO para visualizar el canal de TV.

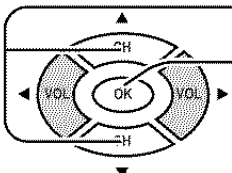
2  Pulse para seleccionar Prog. Canales.  
Pulse para visualizar la pantalla Prog. Canales.

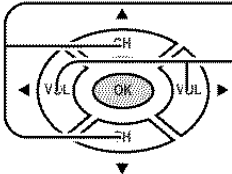

3  Pulse para seleccionar MODO.  
Pulse para seleccionar TV o CABLE.

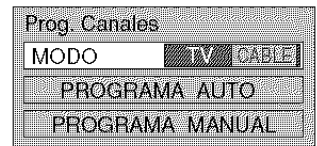

### Programación automática de canales

Explora y guarda automáticamente todos los canales de TV.

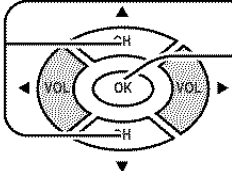
4  Pulse para seleccionar PROGRAMA AUTO.  
Púselo para visualizar la pantalla PROGRAMA AUTO.

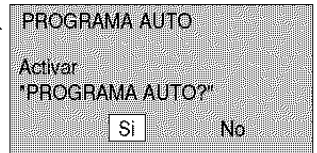

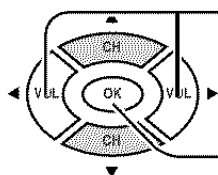
5  Púselo para seleccionar Si.  
Púselo para iniciar PROGRAMA AUTO.

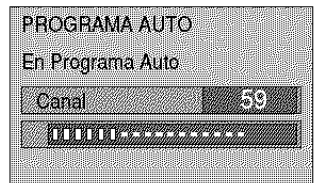

Los canales avanzarán automáticamente hasta que todos ellos hayan sido explorados. Los números de los canales con señal de vídeo recibida se guardarán en la memoria de canales.

#### Notas:

- Cuando se pulse cualquier botón durante PROGRAMA AUTO, el televisor volverá a mostrar la imagen normal. (Los canales encontrados hasta ese punto se añaden.)
- Después de terminar PROGRAMA AUTO se visualizará el número del canal más bajo añadido.
- Cuando no haya canales que puedan recibirse, se visualizará el canal 69 (para TV) o el canal 125 (para TV por cable).

## Programación automática de canales

Añada o borre un canal manualmente.

4

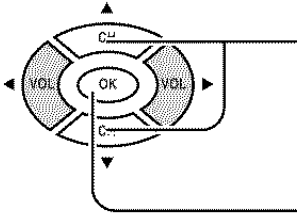

Pulse para seleccionar PROGRAMA MANUAL.

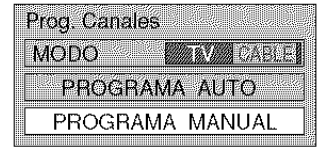

Pulse para visualizar la pantalla PROGRAMA MANUAL.

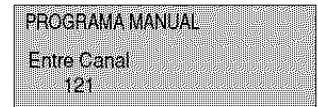

5

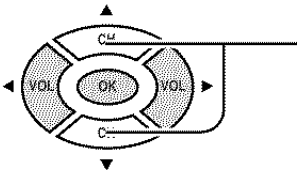

Pulse para seleccionar canal.

• También puede utilizar los botones numerados.

6

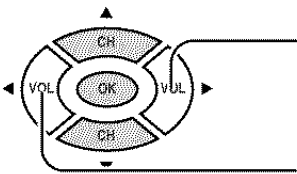

















Púselo para añadir el canal a la memoria de canales (el número del canal se pone de color azul).

Púselo para borrar el canal de la memoria de canales (el número del canal se pone amarillo).

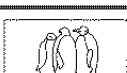
• Repita los pasos 5 y 6 para otros canales.

# Troubleshooting

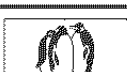
If there is a problem with your TV please refer to the table below to determine the symptoms, then carry out the suggested check. If this does not solve the problem, please contact your local Panasonic dealer, quoting the model number and serial number (both found on the rear of the TV).

Symptoms		Checks
Picture	Sound	
 Snowy Picture	 Noisy Sound	Antenna location, direction or connection
 Multiple Image	 Normal Sound	Aerial location, direction or connection
 Interference	 Noisy Sound	Electrical appliances Cars / Motorcycles Fluorescent lights
 Normal Picture	 No Sound	Volume level Sound mute switched on.
 No Picture	 No Sound	TV set to AV mode. Not plugged into AC outlet. Not switched on. Picture / Sound controls set at minimum levels. Check if in Standby mode.
 No Colour	 Normal Sound	Color controls set at minimum levels. Weak signal.
 Poor or Distorted Picture	 Weak or No Sound	Retune Channel (s).
 Normal Picture	 Weak or No Sound	Sound reception may have deteriorated. Switch STEREO mode (AUDIO ADJUST menu) to Off until reception improves.
Cannot operate with the remote control.		The battery is exhausted. The battery's polarity is wrong. The remote control sensor is exposed to strong light of a fluorescent lamp, etc.
The main unit is hot.		The main unit radiates heat and some of the parts may become hot. This is not a problem for performance or quality. Set up at a location with good ventilation. Do not cover the ventilation holes of the TV with a tablecloth etc., and do not place on top of other equipment.
There may be red spots, blue spots, green spots and black spots on the screen.		This is a characteristic of liquid crystal panels and is not a problem. The liquid crystal panel is built with very high precision technology giving you fine picture details. Occasionally, a few non-active pixels may appear on the screen as a fixed point of red, blue, green, or black. Please note this does not affect the performance of your LCD.

# Specifications

	TC-20LA2	TC-20LA2D
<b>Power Source</b>	AC 120 V, 60 Hz	
<b>Power Consumption</b>	Average use : 65 W Stand-by condition : 0.11 W Power off : 0.08 W	
<b>LCD</b>	20-inch (510 mm), 4:3 aspect ratio LCD panel	
<b>Screen Size</b>	16.06 " (408.0 mm) (W) × 12.05 " (306.0 mm) (H)	
<b>Channel Capability</b>	VHF-12 : UHF-56 : Cable-125	
<b>Sound</b>		
<b>Speaker</b>	∅ 4 cm, 2 pcs, 16 Ω	
<b>Headphones</b>	M3 (3.5 mm) Jack × 1	
<b>FEATURES</b>	3D Y/C Digital Comb Filter CLOSED CAPTION V-Chip	
<b>Operating Conditions</b>	Temperature : 41 °F - 95 °F (5 °C – 35 °C) Humidity : 5 % - 90 % RH (non-condensing)	
<b>Connection Terminals</b>		
<b>INPUT</b>	VIDEO (RCA PIN Type × 1) × 2	1.0 Vp-p (75 Ω)
	S-VIDEO (MINI DIN 4pin × 1) × 2	Y : 1 Vp-p (75 Ω), C : 0.286 Vp-p (75 Ω)
	AUDIO L-R (RCA PIN Type × 2) × 2	0.5 Vrms
<b>COMPONENT VIDEO INPUT</b>	Y	1.0 Vp-p (including synchronization)
	P <sub>B</sub> / P <sub>R</sub>	±0.35 Vp-p
	AUDIO L-R (RCA PIN Type × 2)	0.5 Vrms
<b>Dimensions (W × H × D)</b>		
<b>Including TV Stand</b>	19 39/64 " (498 mm) ×	19 39/64 " (498 mm) ×
	19 59/64 " (506 mm) ×	17 29/32 " (455 mm) ×
	10 9/32 " (260 mm)	7 31/64 " (190 mm)
<b>TV Set Only</b>	19 39/64 " (498 mm) ×	
	17 23/32 " (450 mm) ×	
	3 35/64 " (90 mm)	
<b>Mass (Weight)</b>	16.8 lb. (7.6 kg) Net	14.1 lb. (6.4 kg) Net

**Note:** Design and specifications are subject to change without notice. Weight and dimensions shown are approximate.

**Customer' Record**

The model number and serial number of this product can be found on its rear panel. You should note this serial number in the space provided below and retain this book, plus your purchase receipt, as a permanent record of your purchase to aid in identification in the event of theft or loss, and for Warranty Service purposes.

Model Number \_\_\_\_\_

Serial Number \_\_\_\_\_

**Panasonic Consumer Electronics  
Company, Division of Matsushita  
Electric Corporation of America**  
One Panasonic Way Secaucus  
New Jersey 07094

**Panasonic Sales Company,  
Division of Matsushita Electric  
of Puerto Rico Inc. ("PSC")**  
Ave. 65 de Infanteria, Km 9.5  
San Gabriel Industrial Park,  
Carolina, Puerto Rico 00985

**Panasonic Canada Inc.**  
5770 Ambler Drive  
Mississauga, Ontario  
L4W 2T3

Printed in Japan  
MBS0204S0