

Fisher & Paykel

DishDrawer[®]

USER GUIDE

<i>Introduction</i>	2
<i>Operating Instructions - Prefinished Model</i>	4
<i>Operating Instructions - Integrated Model</i>	6
<i>Accessories</i> Basket, Cup racks, Drain filter access panel, Mega rack, Plate insert, Cutlery basket	8
<i>Loading</i> Examples of how we recommend you load your DishDrawer® , Examples of how not to load your DishDrawer®	9
<i>Dispensers</i> Detergent dispenser, Filling the detergent dispenser, Detergent quantities, Rinse agent dispenser, Filling the rinse agent dispenser	10
<i>Water Softener</i>	12
<i>Dinnerware Care</i> Caring for your dinnerware, Vacation Time	14
<i>Wash Programs</i> Wash descriptions for Rinse, Heavy, Normal, Fast, Delicate, Standard & Eco programs	15
<i>Dishwasher Standards Test</i>	16
<i>Option Adjustment Mode</i> How to enter Option Adjustment Mode, How to change the Rinse Agent Setting, Water Softener Setting, Auto Power Option, End of Wash Program Beeps, Closed Drawer Option, and the Clean Dish Indicator Option.	17
<i>User Maintenance Instructions</i> Cleaning the DishDrawer® , Cleaning the drain filter, spray arm, and filter plate	20
<i>Trouble Shooting</i> Problem solver chart, Possible causes, What to do	22
<i>Fault codes</i> How to recognize a fault code, How to attend to a fault code, Fault code chart	24
<i>Important Safety Information</i>	25
<i>Fisher & Paykel SmartCare Manufacturer's Warranty</i>	27
<i>Customer Care</i>	28
<i>Installation Checklist</i>	29



PREFINISHED & INTEGRATED MODELS

PREFINISHED DD603

*White, Brushed stainless steel,
Indium stainless steel and Black*

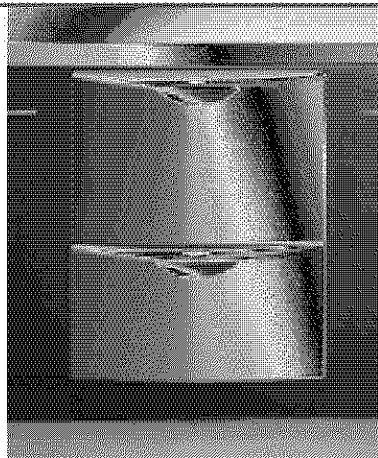

INTEGRATED DD603 I

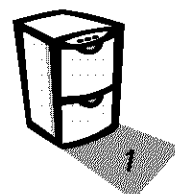
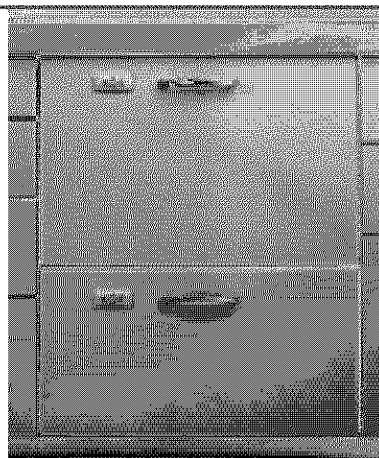

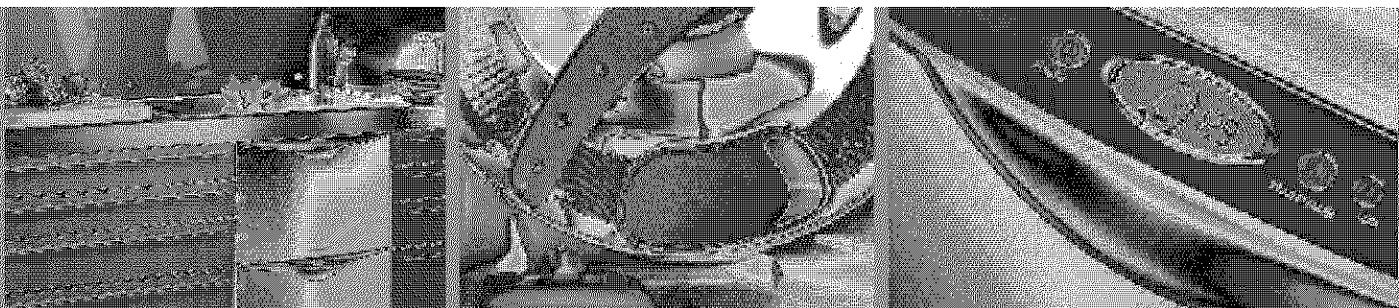

*Thank you and congratulations for purchasing your Fisher & Paykel **DishDrawer**[®]. The **DishDrawer**[®] is unique and offers benefits no other dishwasher can. The **DishDrawer**[®] utilizes the efficiency and easy access of the everyday kitchen drawer, and turns it into the most advanced dishwasher in the world. This booklet will guide you through the operating instructions and features of your **DishDrawer**[®]. We recommend that you read this User Guide thoroughly before you start using your **DishDrawer**[®], for the sake of safety as well as success.*

The drawers of the **DishDrawer®** are totally independent of each other. An interchangeable and easy to remove rack system, to suit your daily needs and a deeper drawer design to accommodate 12 large dinner plates up to 11 7/16" in diameter. The **DishDrawer®** minimizes water and energy consumption with each drawer using less than half the water of a conventional dishwasher. Combining this with the precise markings inside the detergent dispenser, you will never use too much or too little detergent for each program allowing you to be guilt-free when washing even the smallest load. Used cleverly, the double **DishDrawer®** can even provide extra kitchen storage.

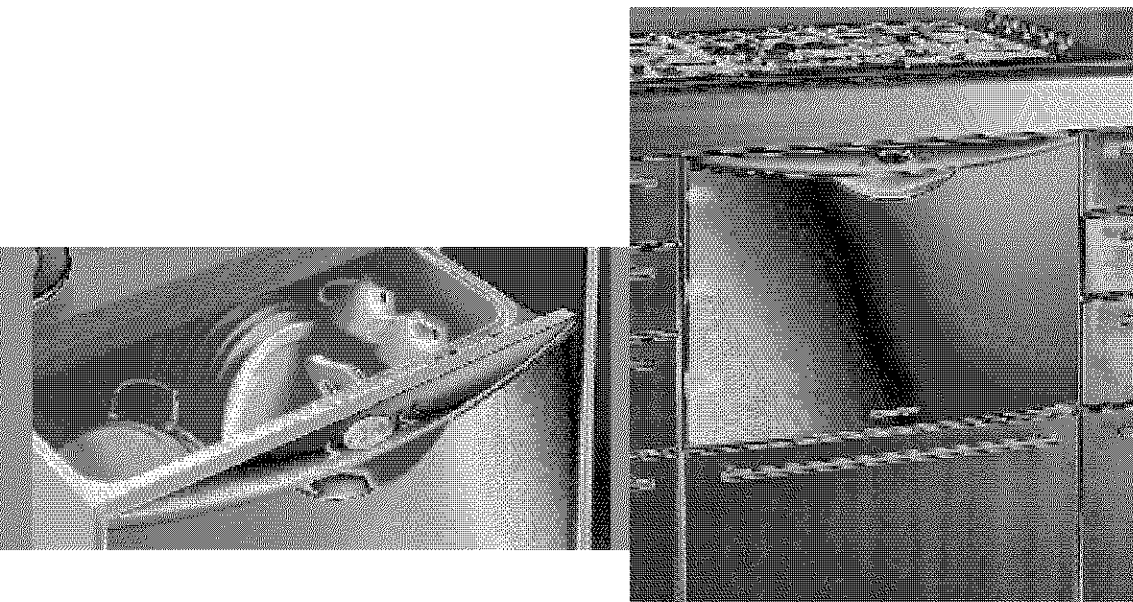

DishDrawer®

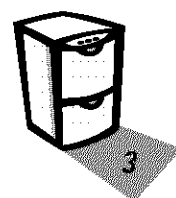

If you have a double **DishDrawer®**, each **DishDrawer®** has its own control panel and can run independently of the other.



Electronic Display

The Electronic Display shows progress through a wash program and time remaining. When the wash program has started, the Electronic Display will countdown in one minute increments.

1

Load Dishes

Remove all food scraps and load the dishes.

2

Add Detergent & Rinse Aid

3

Press the **POWER** Button

Press the **POWER** button  to turn the **DishDrawer®** on or off. Opening the **DishDrawer®** will automatically power up for 30 seconds. To end the wash program in mid cycle, press the **POWER** button. Any water in the **DishDrawer®** will be pumped out.

4

Select Wash Program

Press the **PROGRAM** button  to select the desired wash. The **DishDrawer®** will remember the last program used.

5

ECO Button (optional)

Press the **ECO** button  if you would like the wash program to use less energy and time. The red **ECO** light will indicate the feature is on. If your dishes are heavily soiled or you require enhanced dry performance, we do not recommend **ECO** programs.

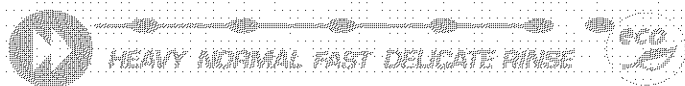

Progress of the wash program

As the wash program advances through the cycle, the following symbols will be highlighted in the Electronic Display to indicate the progression.



DIRTY



PRE WASH



MAIN WASH



POST RINSE



DRYING



CLEAN



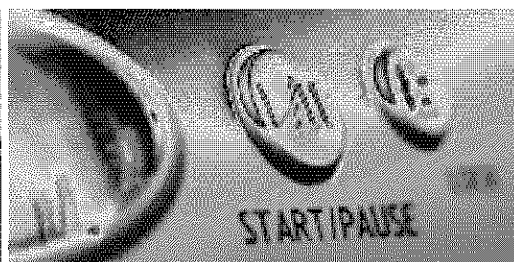
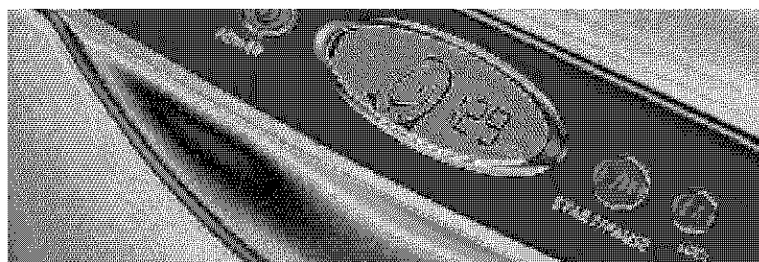

6

Check

Ensure the drain filter is flush with filter plate and the spray arm can rotate about the center easily.

7

Start

Close the **DishDrawer®**. Press the START/PAUSE button  to initiate the wash program. This button also functions as the Delay Start.

Pause

To pause the **DishDrawer®** during its wash cycle, press the START/PAUSE button and wait for three beeps before opening. Restart by pressing the START/PAUSE button. Forcing the drawer open while in mid cycle may cause damage or injury.

8

Finish

The **DishDrawer®** will beep six times to indicate the end of the wash program. At the end of the wash program the drying fan will continue to run for a set time or until the drawer is opened. The fan assists with drying and uses negligible amounts of energy. It is normal for some water to remain in the drain filter area after the wash program is complete.

Note

If the **DishDrawer®** is operating and a power failure occurs, it will stop. The **DishDrawer®** may be unable to be opened during this time. When the power supply is resumed, the **DishDrawer®** will restart in the same part of the wash program.

Lock Button (optional)

The Lock button  activates/ deactivates the Keylock or the Childlock functions.

Keylock

The Keylock function disables all the buttons on the **DishDrawer®**. To activate, press and hold the LOCK button until you hear one beep (about 3 seconds).

Childlock

The Childlock feature locks the **DishDrawer®** and disables all the buttons. To activate, press and hold the LOCK button until you hear two beeps (about 5 seconds).

To cancel Keylock or Childlock, press and hold the LOCK button until you hear one beep and the Lock symbol disappears from the electronic display.

DELAY START MODE (optional)

The start of the wash program can be delayed from 1 to 12 hours. To activate Delay Start:

1. Press and hold the START/PAUSE button until the delay symbol  appears on the Electronic Display.
2. Continue until the desired delay time has been reached.
3. The **DishDrawer®** will start once the delay time has elapsed and the drawer is closed.



To cancel Delay Start, press the POWER button or hold the START/PAUSE button until the delay symbol  disappears.

DishDrawer®

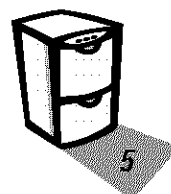

If you have a double **DishDrawer**[®], each **DishDrawer**[®] has its own control panel and can run independently of the other.

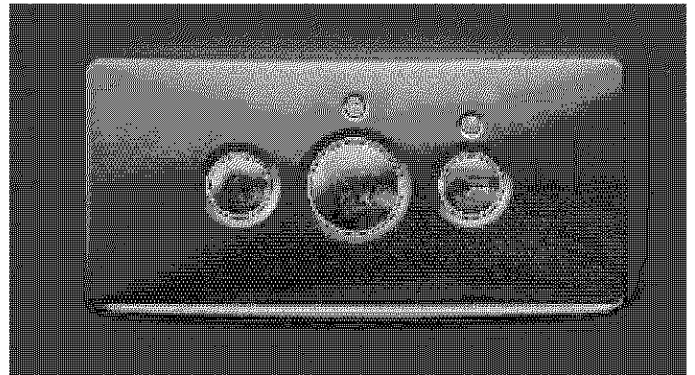

1

Load Dishes

Remove all food scraps and load the dishes.

2

Add Detergent & Rinse Aid

3

Press the POWER Button

Press the POWER button **I** to turn the **DishDrawer**[®] on or off. Opening the **DishDrawer**[®] will automatically power up for 30 seconds. To end the wash program in mid cycle, press the POWER button. Any water in the **DishDrawer**[®] will be pumped out.

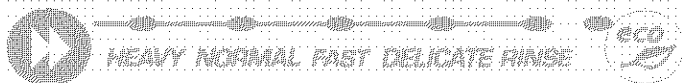

4

Select Wash Program

Press the PROGRAM button **▶▶** to select the desired wash. The **DishDrawer**[®] will remember the last program used.

5

ECO Button (optional)

Press the ECO button **eco** if you would like the wash program to use less energy and time. The red ECO light will indicate the feature is on. If your dishes are heavily soiled or you require enhanced dry performance, we do not recommend ECO programs.

6

Check

Ensure the drain filter is flush with filter plate and the spray arm can rotate about the center easily.

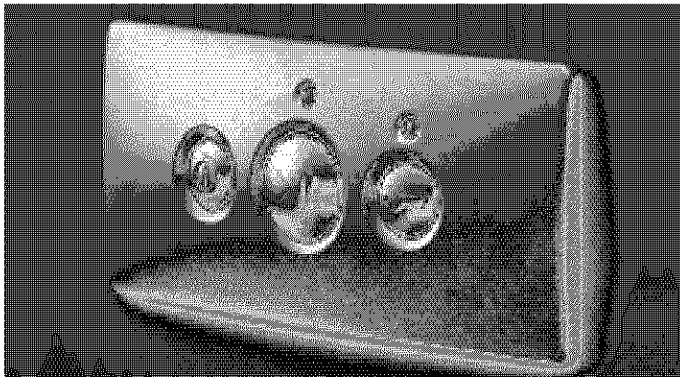

7

Start

Close the **DishDrawer®**. Press the START/PAUSE button ►/|| to initiate the wash program. This button also functions as the Delay Start.

Pause

To pause the **DishDrawer®** during its wash cycle, press the START/PAUSE button and wait for three beeps before opening. Restart by pressing the START/PAUSE button. Forcing the drawer open in mid-cycle may cause damage or injury.

Note

If the **DishDrawer®** is operating and a power failure occurs, it will stop. The **DishDrawer®** may be unable to be opened during this time. When the power supply is resumed, the **DishDrawer®** will restart in the same part of the wash program.

8

Finish

The **DishDrawer®** will beep six times to indicate the end of the wash program. At the end of the wash program the drying fan will continue to run for a set time or until the drawer is opened. The fan assists with drying and uses negligible amounts of energy. It is normal for some water to remain in the drain filter area after the wash program is complete.

DELAY START MODE (optional)

The start of the wash program can be delayed from 1 to 12 hours.

To activate Delay Start:

1. Press and hold the START/PAUSE button until the light above the START/PAUSE button turns orange.
2. The **DishDrawer®** will emit a 'beep' as you hold down the START/PAUSE button, each beep indicates another hour delay. Continue holding the START/PAUSE button until the desired delay time is reached.
3. The **DishDrawer®** will start once the delay time has elapsed and the drawer is closed.

To cancel Delay Start, press the POWER button or hold the START/PAUSE button until the light turns green.

Lock Button (optional)

The Lock button  activates/ deactivates the Keylock or the Childlock functions.

Keylock

The Keylock function disables all the buttons on the **DishDrawer®**. To activate, press and hold the LOCK button until you hear one beep (about 3 seconds).

Childlock

The Childlock feature locks the **DishDrawer®** and disables all the buttons. To activate, press and hold the LOCK button until you hear two beeps (about 5 seconds).

To cancel Keylock or Childlock, press and hold the LOCK button until the green light above the LOCK button disappears.

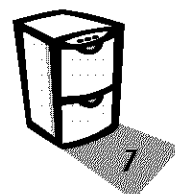

The inserts and racks can be added or removed to suit your individual needs. If you have the double **DishDrawer®** model, some of the accessories are interchangeable between the two drawers. For example you can combine the two Mega Racks into one drawer and wash all cups and glasses, leaving the other drawer for plates and larger items.

a. Basket

The basket holds some of the accessories in place and keeps the dishes above the spray arm. Without the inserts, large bowls and pots can be placed flat.

b. Drain Filter Access Panel

The drain filter access panel is designed to snap onto the basket over the drain filter. This prevents objects from touching the base of the **DishDrawer®** and stopping the rotation of the spray arm, while still giving access to the drain filter.

c. Mega Rack

The Mega rack is designed to hold glasses, cups and small plates.

d. Plate Insert

The plate insert supports plates and bowls.

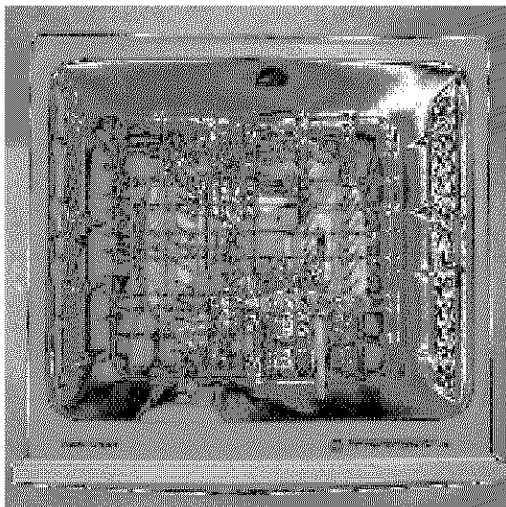
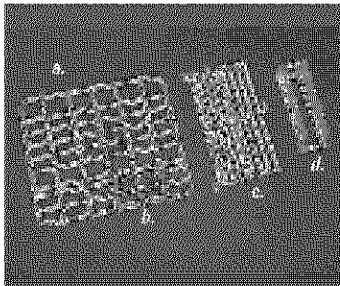

Cutlery Basket

Cutlery, small kitchen utensils and some plastic lids are best placed into the cutlery basket. For best wash performance, we recommend loading cutlery with handles pointing down and sharp utensils with their handles facing up, to reduce the risk of injury. Mix spoons, knives and forks within each section, to stop cutlery nesting together and to ensure the water circulates freely. Keep stainless steel from touching silver cutlery to avoid staining. Use the oval slots (spoon rack) for spoons and teaspoons. Small items, like

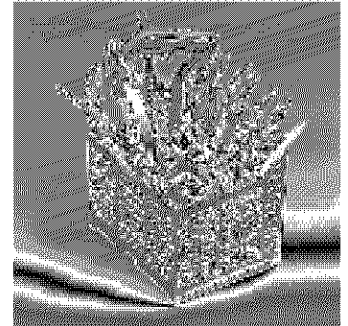

plastic lids, can be placed under the spoon rack, this will prevent them from being displaced by wash water and falling to the bottom, where they may stop the spray arm rotation.

Cup Racks

Cups, glasses and kitchen utensils can be placed on the left and right hand side of the cup racks. For best performance ensure there are no large items below, blocking the wash water from reaching the cup racks. Wine glasses can be supported on the cup racks if used in conjunction with the Mega Rack. There are stops on the cup rack to prevent cups from touching the **DishDrawer®** wall. This will help improve the dry and wash performance.



How to install the Mega Rack

To install the Mega rack, place the outer legs of the rack on top of the basket, and clip the Mega rack to the side of the basket. When the Mega rack is correctly installed it should not feel loose in the basket.



The wash water for the **DishDrawer®** comes from the spray arm which is situated at the base of the dishwasher. The spray arm rotates, providing wash water to all areas of the **DishDrawer®** so care needs to be taken when loading the **DishDrawer®**. Ensure that there is sufficient space and room for the water to reach all areas particularly the cup racks. If there are any items blocking the spray arm path or wash water, then the performance will be ineffective.

✓ **HOW TO LOAD YOUR DishDrawer®**

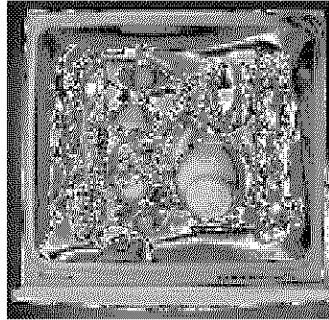
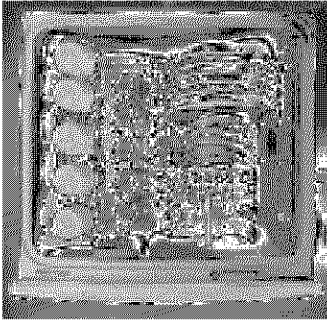

Please note that the basket and its inserts are not designed to be lifted out of the **DishDrawer®** while loaded with dishes.

✗ **HOW NOT TO LOAD YOUR DishDrawer®**

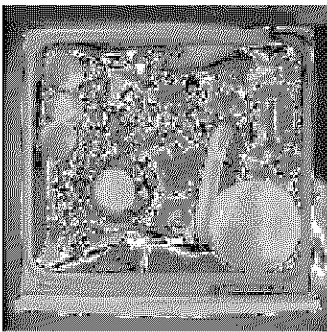

The **DishDrawer®** is overcrowded and wash water will not reach some of the dinnerware.

Cups, glasses and bowls must have their openings facing downwards.

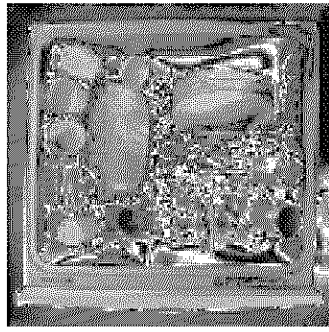

The plates are nesting together and wash water may not get through.

Ensure cutlery are not nesting or stuck together. They need to be evenly spread out.

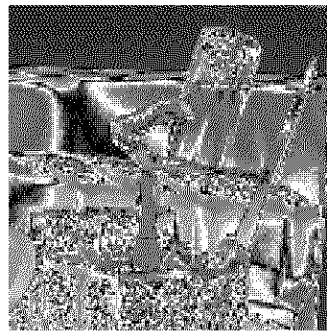

Ensure dishware items are not forced into or protrude above the DishDrawer® as it may prevent the lid from properly sealing which could result in a service call.

Locate sharp items to prevent injuring the user and damaging the lid assembly.

Check the bottom of the cutlery basket to ensure sharp or pointed items have not come through as they may stop spray arm rotation.

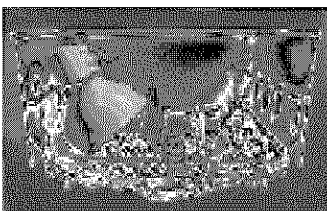

Ensure cutlery has not fallen through and stopped the spray arm from rotating.

The large bowl is blocking wash water reaching the cup racks.

Large utensils should be on cup racks so they do not become dislodged and stop the spray arm from rotating.



loading and accessories

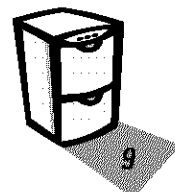

The detergent and rinse agent dispenser is located on the inside of the **DishDrawer®**. The detergent dispenser has two compartments, the pre wash compartment is the smaller and the other is for the main wash detergent. The pre wash and main wash compartments both have markings on the inside. The pre wash compartment has one marking which represents 1 tsp, when it is full, it holds 2 tsp. The main wash compartment has two markings, the lowest mark indicates 2 tsp, the middle mark 4 tsp and when full it contains 6 tsp.

The detergent dispenser is designed for use with powdered detergent. Liquid and tablet detergents are not suitable to be used in the DishDrawer®.



Filling the Detergent Dispenser

1. Press the latch down and the door will open.
2. Pour in detergent. No detergent is needed for the Rinse program.
3. After filling the compartment(s), close the dispenser door until it clicks shut. The detergent will automatically be released into the **DishDrawer®** during the wash program.

IMPORTANT Only use powdered detergent recommended for domestic automatic dishwashers. Hand washing liquids, soap, laundry detergents or disinfectants will damage the **DishDrawer®**. Never sprinkle or pour detergent directly onto any item in the **DishDrawer®**.

WARNING

Dishwasher detergents are strongly alkaline. They can be dangerous if swallowed. Avoid contact with skin and eyes. Keep children and infirm person(s) away from the DishDrawer® when the drawer is open.

open detergent dispenser

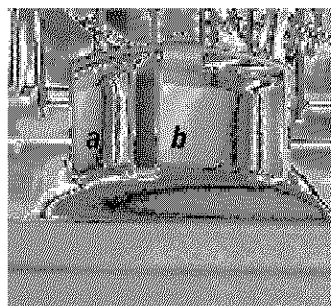

- a. Pre Wash Compartment
- b. Main Wash Compartment
- c. Salt Indicator Light
- d. Salt Reservoir Cap
- e. Detergent Dispenser Latch
- f. Rinse Agent Indicator Light
- g. Rinse Agent Plug



closed detergent dispenser and salt reservoir

Detergent Quantities

The detergent quantities suggested below are for individual **DishDrawer®**.

Water Type	Wash Program	Detergent Quantities	
		pre wash (tsp)	main wash (tsp)
Hard (>150ppm or >9gpg)	All**	2	6
Medium (100-150ppm or 6-9gpg)	All**	2	4
Soft (<100ppm or <6gpg)	Heavy	1	3
	Normal	1	2
	Delicate		1
	Fast		1

* tsp = teaspoon. 1 tsp = 5g.

** No detergent is required in pre wash compartment for the fast wash.

We highly recommend the regular use of liquid rinse agent to give the best drying results. Rinse agent gives a streak free, sparkling clean look to glass and chinaware, in addition it prevents metal from tarnishing. The rinse agent dispenser is on the inside of the drawer, located underneath the detergent dispenser. The dispenser holds approximately 1.7 fl. oz. of rinse agent.

How Much Rinse Agent to Use

The regulator may need adjusting to suit your water conditions. The lowest setting is '1' and the highest is '5'. Refer to Option Adjustment Mode section to adjust the rinse agent setting. If there is excessive foam at the end of the wash, reduce the setting. If dishes are wet or streaky after drying, increase the setting.

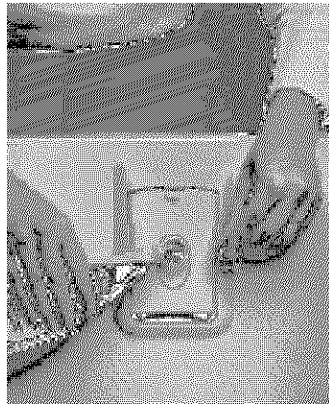

Filling the Rinse Agent Dispenser

1. Turn the plug counter clockwise and remove.
2. Pour the rinse agent into the circular opening.
3. Take care not to spill rinse agent into the **DishDrawer®**. Any spillages must be wiped up to prevent excess foaming. Failure to wipe rinse agent spillages may result in a service call which will not be covered by warranty.
4. Fit the plug back into the original position.

Rinse Agent Indicator Light

If the rinse agent indicator light is red, refill the dispenser. If the rinse agent indicator light is not lit, there is enough rinse agent for the wash.

Hard Water Situations

If you live in a hard water situation, we recommend the installation of a household water softener to improve the water quality, detergent effectiveness and prevent the build up of calcium deposits on dishes and in the **DishDrawer®**.

Certain brands of dishwasher detergent contain varying quantities of phosphates, which help soften water. We suggest you use a detergent with high phosphate content to improve the wash. The detergent compartments need to be completely FULL and rinse agent is used with its setting fixed at 5.

We recommend the use of a dishwasher cleaner/descaler whenever you notice a build up of calcium deposits in your **DishDrawer®**.

*After you have used the dishwasher cleaner/descaler you must run another wash program with detergent to prevent damage to the **DishDrawer®**.*

Soft Water Situations

If you live in an area of naturally soft water or your household water is softened, avoid using too much detergent in your **DishDrawer®**. An excess amount of detergent is very aggressive on glassware and may cause irreversible etching.

Etching is a chemical deterioration that occurs on the surface of glassware when it is subjected to high temperatures, too much detergent and/or soft water situations. Etching is caused by a combination of very hot water, which causes the detergent to become very aggressive, but because the water is soft, there are no water hardness mineral ions for the detergent to bind to, so it extracts mineral ions directly from the glass.

Etching looks like rainbow colored film, as the glass is subjected to further washing the surface will eventually appear opaque. This type of etching is irreversible.

To prevent further etching from occurring on glassware use less detergent (follow the recommended detergent quantities in the User Guide for soft water situations), and ensure the dishwasher is not overloaded, so water can reach all the dishes during the wash.



detergent
rinse agent
water softener

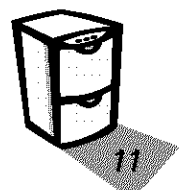

Soft water is required for dishwashing to prevent the build up of scale (lime deposits) on your dishes and in your **DishDrawer®**. If hard water is used for dishwashing, you will notice glasses will become opaque, dishes will become spotted or have a white film on them and your dishwasher will become less efficient over a period of time. Tap water above 100ppm must be softened for dishwashing for optimum wash performance.

DishDrawer® models DD603H and DS603H are fitted with a water softener which is designed to remove the calcium and magnesium ions that cause water to be 'hard'. The water softener will automatically remove the hardness from the water using a salt solution. The amount of salt required will depend on the local water hardness. Your local water company will be able to provide you with the information on the water hardness in your local area.

To Ensure Optimum Performance of the Water Softener

The water softener must be set to the correct local water hardness and must always be filled with granular salt made especially for dishwasher water softening systems. We do not recommend the use of cooking salt like table or rock salt or pellets as they may contain impurities that will impair or diminish the life of the water softener.

SETTING UP THE WATER SOFTENER

Determine the Water Hardness in Your Local Area

Identify the setting you require for your **DishDrawer®** from the water hardness table below. For example, if your water hardness is 500ppm, then the water softener setting on your **DishDrawer®** should be four. Refer to the Option Adjustment Mode to adjust the water softener so that the setting corresponds to your water hardness.

DishDrawer® setting	Grains per Gallon (gpg)	Parts per Million (ppm)
0	0 - 6	0 - 100
1	6 - 14	100 - 250
2	14 - 20	250 - 350
3	20 - 26	350 - 450
4	26 - 32	450 - 550
5	32 - 36	550 - 625

Note

If your water hardness is above 625ppm, we highly recommend you completely fill the detergent compartment for all programs except Rinse and the rinse agent setting be at 5. If your water hardness is above 625ppm, the performance of your **DishDrawer®** will decline.

The Salt Reservoir

Water softening can only take place when there is salt in the reservoir. The salt reservoir must be filled prior to using the DishDrawer® and whenever the salt reservoir indicator light is red.

How to Fill the Salt Reservoir

1. Open the DishDrawer®.
2. Unscrew the salt reservoir plug by turning counter-clockwise.
3. Place the salt into the salt container and pour the contents into the salt reservoir. The salt reservoir can hold up to approximately 1lb of salt.
4. Fit the cap tightly back into its original position.
5. If you do not wash your dishes immediately after filling the salt reservoir, run a rinse program to remove any salt water or spilt granules.

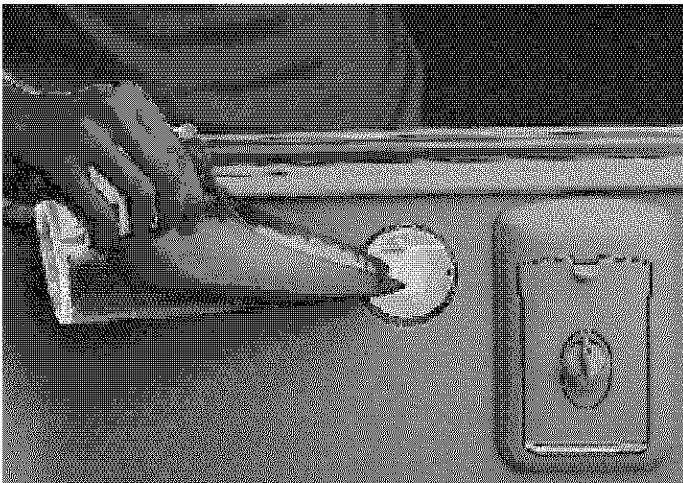

Note

When filling the salt dispenser, you may notice water being displaced from the water softener overflow.

Salt Indicator Light

If the salt indicator light is red, the salt reservoir is empty. If the salt indicator light is black, there is enough salt in the reservoir for the wash program that has been selected.

Prefinished Models: The electronic display will also indicate when the salt reservoir is empty by displaying the salt  symbol.

WARNING

Do not pour detergent or rinse agent into the salt reservoir. Detergent and rinse agent will destroy the water softener.

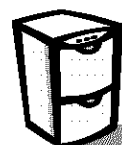
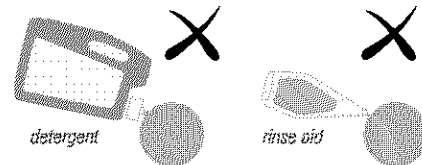
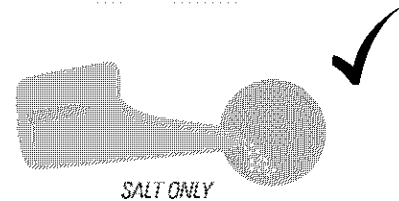

The combination of high temperatures and dishwasher detergent may cause damage to some items if they are washed in the **DishDrawer®**. Remember, if in any doubt about any aspect concerning items washed in the **DishDrawer®**, follow the instructions from the manufacturer of the items, or wash the item by hand.

Cutlery & Silverware

All cutlery and silverware should be rinsed immediately after use to prevent tarnishing caused by some foods. The Rinse wash program is useful for this. Silver items should not come into contact with stainless steel, for example other cutlery. Mixing these items can cause staining. Remove silver cutlery from the **DishDrawer®** and hand dry it immediately after the program has finished.

Aluminium

Aluminium can be dulled by Dishwasher detergent. The degree of change depends on the quality of the product.

Other Metals

Iron and cast iron objects can rust and stain other items. Copper, pewter and brass tend to stain.

Woodware

Wooden items are generally sensitive to heat and water. Regular use in the Dishwasher may cause deterioration over time. If in doubt, wash by hand.

Glassware

Most everyday glassware is dishwasher safe. Crystal, very fine and antique glassware may etch i.e. become opaque. You may prefer to wash these items by hand.

Decorated Items

Most modern china patterns are Dishwasher safe. Antique items, those with a pattern painted over the glaze, gold rims or hand painted china may be more sensitive to machine washing. If in doubt wash these items by hand.

Glued Items

Certain adhesives are softened or dissolved in machine washing. If in doubt, wash glued items by hand.

Plastic

Some plastic may change shape or color with hot water. Check manufacturer's instructions about washing plastic items. Washable plastic items should be weighed down so they do not flip over and fill with water or fall through the basket during the wash.

VACATION TIME

If the **DishDrawer®** is not going to be used for some time, we recommend you ensure the baskets are empty. Leave the inside of the **DishDrawer®** clean. Leave the drawers ajar to allow air to circulate. Turn off both the power and water supply to the **DishDrawer®**.

STANDARD PROGRAM - when to use				
Heavy <small>HEAVY</small>	Normal <small>NORMAL</small>	Fast <small>FAST</small>	Delicate <small>DELICATE</small>	Rinse <small>RINSE</small>
Heavily soiled pots, pans & dishes	Dishes with normal soils for optimum wash & dry performance	Lightly soiled dishes	Lightly soiled & heat sensitive crockery	To prevent odors & soil drying on dishes
pre wash 1 pre wash 2 pre wash 3 main wash 150°F post rinse 1 post rinse 2 final rinse 165°F drying phase	pre wash 1 pre wash 2 main wash 140°F post rinse final rinse 150°F drying phase	pre wash main wash 115°F post rinse final rinse 115°F	pre wash main wash 120°F post rinse final rinse 130°F drying phase	pre wash

ECO PROGRAM - when to use				
Heavy <small>HEAVY ECO</small>	Normal <small>NORMAL ECO</small>	Fast <small>FAST ECO</small>	Delicate <small>DELICATE ECO</small>	
Heavily soiled everyday dishes	Normal soiled dishes for optimum energy use	Lightly soiled, non greasy dishes	Non greasy, lightly soiled & heat sensitive crockery	
pre wash 1 pre wash 2 main wash 140°F post rinse 1 post rinse 2 final rinse 150°F drying phase	pre wash main wash 125°F post rinse final rinse 125°F drying phase	pre wash main wash 105°F post rinse final rinse 105°F	pre wash main wash 115°F post rinse final rinse 125°F drying phase	

Note

Wash times can vary depending on the incoming water temperature, ambient conditions, type of dish load and whether the drawer has been opened during the wash. Wash times are only APPROXIMATE on the Electronic Display and based on 120°F incoming water.

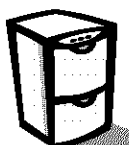

Fisher & Paykel DishDrawer®s are tested to various standards for both wash and dry performance. The following are loading pattern diagrams, detergent and rinse agent quantities used for the DishDrawer®.

Detergent Quantities*	5g (pre wash) 10g (main wash)
*for soft water situations only	
Rinse Agent Setting	4
Water Softener Setting**	Adjust the water softener to match the water hardness. Refer to the water softener and option adjustment mode section of the User Guide.
**for DD603H and DS603H models only	

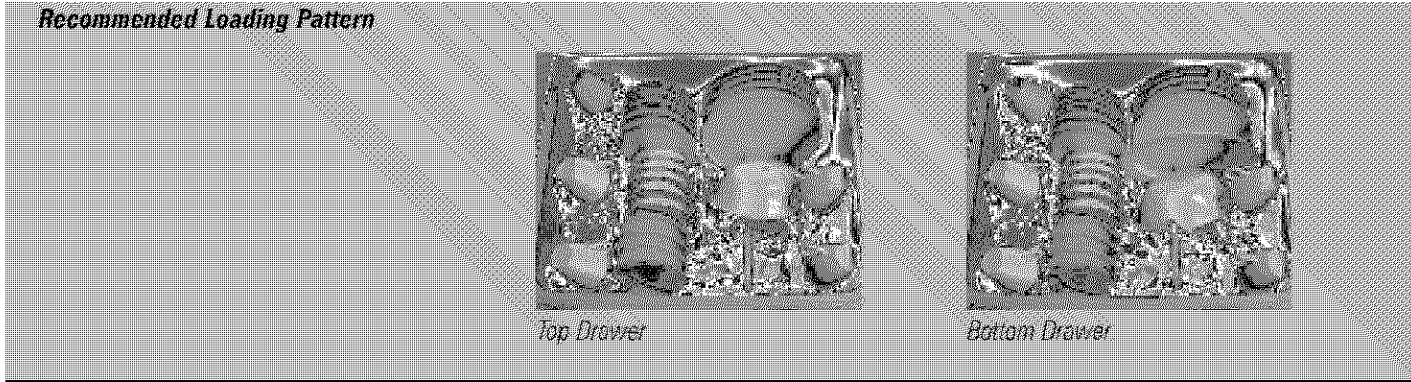

HOW TO ENTER OPTION ADJUSTMENT MODE

After using the DishDrawer® you may want to change some of the preset options to suit your needs. The settings for Rinse Agent, Water Softener, Auto Power, End of Wash Program Beeps, Closed Drawer and Clean Dish Indicator options can be changed.

Prefinished and Integrated Models

1. Press the POWER button to turn the DishDrawer® to the Normal Operating Mode.
 2. Press and hold the ECO and LOCK buttons for 5 seconds. When the buttons have been correctly pressed, one long beep is emitted.
 3. Release the LOCK and ECO buttons.
 4. Use the appropriate buttons on the control panel to make the necessary adjustments. These are explained below.
 5. Once the changes have been made, press the POWER button to return to the Normal Operating Mode.
- The DishDrawer® will save these changes automatically.

How to Adjust the Rinse Agent Setting

Prefinished Models

1. Enter the Option Adjustment Mode as explained previously. The letters "rA" will be shown on the Electronic Display.
2. The current rinse aid setting is shown on the wash program indicator in red lights. If four red lights are lit on the wash program indicator then the rinse agent setting is at four.
3. Press the LOCK button to increase or decrease the rinse agent setting, the red lights will scroll up to 5 and then start from 1 again.
4. Once you have selected the desired rinse agent setting, press the POWER button to return to the Normal Operating Mode.

Electronic display



Example of Rinse Agent set to 4.

Integrated Models

1. Enter the Option Adjustment Mode as explained previously. The light above the START/PAUSE button is red to indicate this setting has been chosen.
2. The current rinse agent setting is shown on the wash program indicator in red lights. If four red lights are lit on the wash program indicator then the rinse agent setting is at four.
3. Press the LOCK button to increase or decrease the rinse agent setting, the red lights will scroll up to 5 and then start from 1 again.
4. Once you have selected the desired rinse agent setting, press the POWER button to return to the Normal Operating Mode.



Example of Rinse Agent set to 4.

How to Adjust the Water Softener Setting

(for models DD603H and DS603H only)

Prefinished Models

1. Enter the Option Adjustment Mode as explained previously.
2. Press the START/PAUSE button until the letters "hd" appear on the electronic display. The current water softener setting is shown on the wash program indicator in red lights. If four red lights are lit then the water softener setting is at four.
3. Press the LOCK button to increase or decrease the water softener setting. For example, if the water hardness is 500ppm, the number of lights that are lit should be four.
4. Once you have selected the desired water softener setting, press the POWER button to return to the Normal Operating Mode.

Electronic display

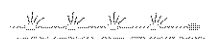

Example of the Water Softener set to 4.

Integrated Models

1. Enter the Option Adjustment Mode as explained previously.
2. Press the START/PAUSE button until the light above the START/PAUSE button is green, if it is not, press the POWER button and start again. The current water softener setting is shown on the wash program indicator in red lights. If four red lights are lit, then the water softener is set to four.
3. Press the LOCK button to increase or decrease the water softener setting. For example, if the water hardness is 500ppm, there should be four red lights lit.
4. Once you have selected the desired water softener setting, press the POWER button to return to the Normal Operating Mode.

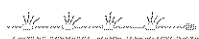

Example of the Water Softener set to 4.

DishDrawer®

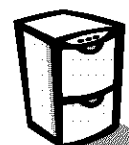

How to Remove the Auto Power Option

When the DishDrawer® leaves the factory, it is programmed to automatically turn itself on whenever the drawer is opened. The DishDrawer® will not start washing until the drawer is closed and the START/PAUSE button has been pressed. If you do not want the DishDrawer® to turn itself on automatically, this feature can be turned off.

Prefinished Models

1. Enter the Option Adjustment Mode as explained previously.
2. Press the START/PAUSE button until the letters 'AP' appear on the electronic display.
3. Press the LOCK button to turn the Auto Power feature on or off. The brush symbol is not present on the electronic display when the Auto Power feature has been turned off.
4. Press the POWER button to return to the Normal Operating Mode.

Integrated Models

1. Enter the Option Adjustment Mode as explained previously.
2. Press the START/PAUSE button until the lights above the START/PAUSE button is orange and the ECO button is red. If it is not, press the POWER button to return to Normal Operating Mode and start again.
3. Press the LOCK button to turn the Auto Power feature on or off. If all the red lights on the wash program indicator are off then the Auto Power feature has been turned off.
4. Press the POWER button to return to the Normal Operating Mode.

Electronic display

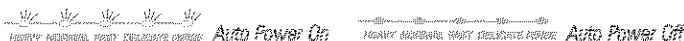
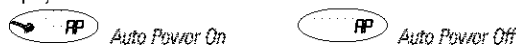

How to Remove the End of Wash Program Beeps

The factory has programmed the DishDrawer® to beep six times at the end of the wash program. This feature can be turned off.

Prefinished Models

1. Enter the Option Adjustment Mode as explained previously.
2. Press the START/PAUSE button until the letters 'EC' appear on the Electronic Display.
3. Press the LOCK button to turn the End of Wash Program Beeps on or off as desired. The brush symbol is not present on the Electronic Display when the End of Wash Program Beeps have been turned off.
4. Press the POWER button to return to the Normal Operating Mode.

Integrated Models

1. Enter the Option Adjustment Mode as explained previously.
2. Press the START/PAUSE button until the lights above the START/PAUSE button is green and the ECO button is red. If it is not, press the POWER button to start again.
3. Press the LOCK button to turn the End of Wash Program Beeps on or off as desired. The End of Wash Program Beeps have been turned off if all the red lights on the wash program indicator are off.
4. Press the POWER button to return to the Normal Operating Mode.

Electronic display

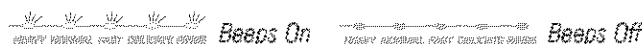

How to Install the Closed Drawer Option

When the Closed Drawer Option has been selected it will keep the **DishDrawer®** locked at all times. When you wish to open the **DishDrawer®** press the POWER button. When the **DishDrawer®** is fully closed again, the lid will automatically come down after 30 seconds and lock the **DishDrawer®**. *NOTE: If the Lock feature is used in conjunction with the Closed Drawer Option, pressing the POWER button will not open the DishDrawer®. The Lock feature must be turned off to enable the DishDrawer® to be opened.*

Prefinished Models

1. Enter the Option Adjustment Mode as explained previously.
2. Press the START/PAUSE button until the letters 'Ld' appear on the Electronic Display.
3. Press the LOCK button to turn the Closed Drawer Option on or off. The brush symbol indicates the Closed Drawer Option is selected.
4. Press the POWER button to return to the Normal Operating Mode.

Integrated Models

1. Enter in the Option Adjustment Mode as explained previously.
2. Press the START/PAUSE button until the lights above the START/PAUSE button and the ECO button is red. If it is not, press the POWER button to return to the Normal Operating Mode and start again.
3. Press the LOCK button to turn the Closed Drawer feature on or off. If all the red lights on the wash program indicator are on then the Closed Drawer feature is on.
4. Press the POWER button to return the Normal Operating Mode.

Electronic display

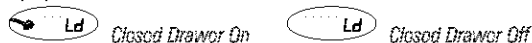

How to Install the Clean Dish Indicator

Examples of where this feature might be beneficial are when dishes have been left in the **DishDrawer®** and you cannot remember if they have been washed or in situations where household members regularly remove a few clean dishes without emptying the remaining drawer.

When the **DishDrawer®** leaves the factory it is programmed with the Clean Dish Indicator off. When the wash program has finished, the "End of Program" symbol will remain on until the **DishDrawer®** is opened. Once the **DishDrawer®** is opened, it will return to the Normal Operating Mode.

If the Clean Dish Indicator is chosen, the "End of Program" symbol will remain on to indicate the dishes are clean. When you have unloaded the clean dishes or putting in dirty dishes into the **DishDrawer®**, press the POWER button. The **DishDrawer®** will return to the Normal Operating Mode, this could be used to indicate that dirty dishes are in or can be loaded into the **DishDrawer®**.

NOTE: We do not recommend the Clean Dish Indicator be used in conjunction with the Closed Drawer Option.

Prefinished Models

1. Enter the Option Adjustment Mode as explained previously.
2. Press the START/PAUSE button until letters "dS" appear on the Electronic Display.
3. Press the LOCK button to turn the Clean Dish Indicator on or off. When the Clean Dish Indicator has been turned on, the brush symbol is present on the Electronic Display.
4. Press the POWER button to return to the Normal Operating Mode.

Integrated Models

This option is not available for Integrated Models.

Electronic display

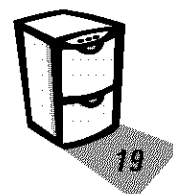
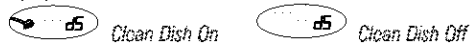

CLEANING THE DishDrawer®

From time to time the wash program indicator panel and its surrounds need to be cleaned to remove food particles, hard water scale and any spillages. We recommend wiping these areas with a clean damp cloth.

We do not recommend the use of the following cleaning aids on your DishDrawer® as they may damage it:

- Plastic or stainless steel scouring pads
- Abrasive, solvent, household cleaners
- Acid or alkaline cleaners
- Hand washing liquids or soap
- Laundry detergents or disinfectants.

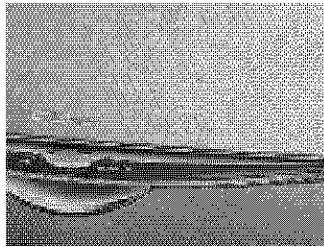

Depending on the type of exterior finish on your DishDrawer®, we recommend the following:

Iridium Finish (Matt Stainless Steel)

This new easy-clean surface requires only a mild dishwash detergent and warm water. Take care not to wet the control panel.

Dry with a clean lint free cloth

DO NOT use proprietary "Stainless Steel" type cleaners or polishes as these may damage the protective coating.

WARNING

Never use abrasive cleaners or harsh solvents as these will damage the Iridium surface.

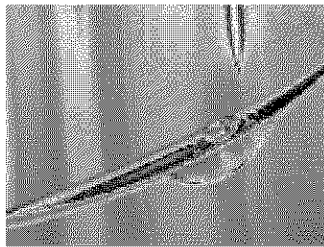

Stainless Steel Finish (Brushed Stainless)

To clean the brushed stainless surface doors, stainless steel cleaners can be used. Alternatively wipe the doors with a clean damp cloth.

Dry with a lint free cloth.

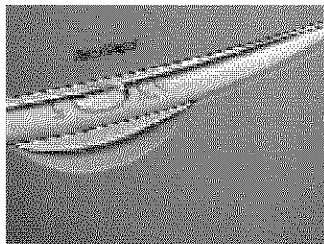

White or Black Finish

To clean the doors wipe the doors with a damp clean cloth. Dry with a lint-free cloth.

If a dishwasher cleaner/descaler is used, you must run a wash program with detergent immediately afterward to prevent any damage to the **DishDrawer®**.

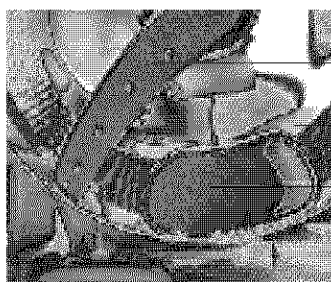

Spray Arm

Filter Plate

Drain Filter

Internal Parts of the **DishDrawer®**

Cleaning the Drain Filter, Spray Arm and Filter Plate

We recommend the drain filter to be cleaned whenever there is evidence of food particles. The filter plate is designed to be self-cleaning, but food scraps may accumulate. The spray arm and filter plate may need cleaning about once a month in normal use or more often, should the need arise.

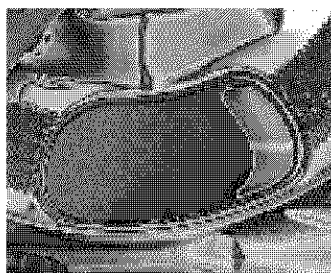

Cleaning the Drain Filter

1. Lift up the drain filter access panel, if fitted on the basket.
2. Lift and remove the drain filter out of the **DishDrawer®**.
3. Empty, rinse under clean running water and replace back into the allocated space.
4. Ensure the drain filter is flush with the filter plate.

Cleaning the Spray Arm

1. Remove the basket carefully. Lift from the back end first so that you do not knock the detergent and rinse agent dispenser.
2. Lift the spray arm and shake any foreign material out.
3. Rinse the spray arm under water and wipe the spray arm with a damp cloth.
4. Replace the spray arm back onto the impeller.

Cleaning the Filter Plate

1. Ensure the **DishDrawer®** is cool before you start cleaning and follow the instructions for removing the drain filter and spray arm.
2. In the center of the filter plate, there are two rings. Hold the center ring still and turn the outer ring counter-clockwise, about a 1/8 turn. This will release the filter plate.
3. When cleaning the underside of the filter plate, care must be taken on the sharp outer edge to avoid the risk of cut type injuries.
4. Remove any soil, wash in hot soapy water and rinse thoroughly in clean water. The heater plate can be wiped with a damp cloth.
5. Replace the filter plate so it lies flat in the base of the **DishDrawer®** ensuring the filter plate is fully locked into position with the center ring.
6. To lock the filter plate into position, ensure the lines align with each other (refer to the diagram for the correct position). The filter plate must not be able to move about freely.

Correct Locking Position of Filter Plate with Motor Assembly

Impeller

Center Ring

Outer Ring

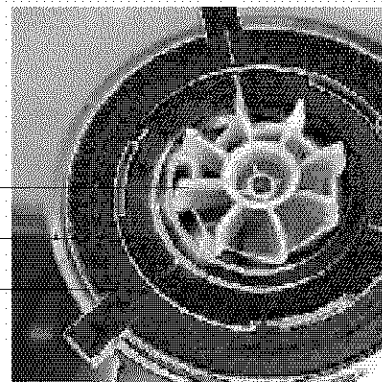

WARNING

The DishDrawer® must be used with the filter plate, drain filter and spray arm correctly in place.

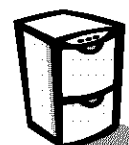

If the **DishDrawer®** does not appear to be operating properly, check this chart below and correct where possible.

Problem	Possible Causes	What to Do
DishDrawer® will not start	<ul style="list-style-type: none"> <input type="checkbox"/> Power supply is not connected. <input type="checkbox"/> The drawer is not properly closed. <input type="checkbox"/> Lock feature is on. <input type="checkbox"/> START/PAUSE button not pressed. 	<ul style="list-style-type: none"> <input type="checkbox"/> Connect the power supply. <input type="checkbox"/> Ensure the drawer is firmly closed. <input type="checkbox"/> Turn the Lock off. Hold down the LOCK button until the 'lock' symbol (prefinished models) or the green light (integrated models) disappears. <input type="checkbox"/> Press the START/PAUSE button.
Excess water in the DishDrawer®	<ul style="list-style-type: none"> <input type="checkbox"/> Drain hose(s) bent or kinked. <input type="checkbox"/> Blocked filters and/or drain hose(s). 	<ul style="list-style-type: none"> <input type="checkbox"/> Straighten the drain hose(s). <input type="checkbox"/> Clean the filter plate/drain filter. Unblock the drain hose(s). Refer to the user maintenance section.
Water marks on the dishes	<ul style="list-style-type: none"> <input type="checkbox"/> Insufficient rinse agent. <input type="checkbox"/> Rinse agent setting too low. <input type="checkbox"/> DishDrawer® overloaded/incorrectly loaded. <input type="checkbox"/> Insufficient or no salt in the water softener. (DS603H and DS603H models only) 	<ul style="list-style-type: none"> <input type="checkbox"/> Ensure there is enough rinse agent in the dispenser. <input type="checkbox"/> Increase the rinse agent setting. <input type="checkbox"/> Refer to the section on loading. <input type="checkbox"/> Ensure there is enough salt in the water softener and/or increase the water softener setting.
Unclean dishes	<ul style="list-style-type: none"> <input type="checkbox"/> Wash program unsuitable for the load. <input type="checkbox"/> Spray arm unable to rotate. <input type="checkbox"/> DishDrawer® overloaded/incorrectly loaded. <input type="checkbox"/> Filter plate/drain filter is incorrectly inserted. <input type="checkbox"/> Detergent put in the wrong compartment. <input type="checkbox"/> Excessive food not removed from dinnerware prior to cleaning. <input type="checkbox"/> Unsuitable detergent. <input type="checkbox"/> Not enough detergent. <input type="checkbox"/> Spray arm holes are blocked. <input type="checkbox"/> Filter plate/drain filter is blocked. <input type="checkbox"/> Mega rack incorrectly installed. <input type="checkbox"/> Insufficient salt in the water softener. (DS603H and DS603H models only) 	<ul style="list-style-type: none"> <input type="checkbox"/> Refer to the wash programs section for a suitable wash program, or the soils were too heavily baked on and dishes may need soaking. <input type="checkbox"/> Ensure no items are obstructing the spray arm path. <input type="checkbox"/> Refer to the section on loading. <input type="checkbox"/> Refer to the user maintenance section. <input type="checkbox"/> Detergent must be placed in the large compartment. <input type="checkbox"/> Scrape all food scraps off dinnerware prior to loading. <input type="checkbox"/> Use recommended brands of dishwasher detergent. <input type="checkbox"/> Refer to the detergent section or the detergent manufacturer's instructions. <input type="checkbox"/> Clean the spray arm. <input type="checkbox"/> Clean the filter plate and drain filter. <input type="checkbox"/> Refer to the accessories section for correct installation. <input type="checkbox"/> Ensure there is enough salt in the water softener and you may need to increase the water softener setting if the problem persists.

Problem	Possible Causes	What to Do
DishDrawer® interior is stained	<input type="checkbox"/> Some foods, like tomato based products, may stain the inside of the DishDrawer® .	<input type="checkbox"/> Pre-rinse dishes before placing in the DishDrawer® . Alternatively, using the Rinse program after adding the dishes may minimize staining.
Dishes did not dry	<input type="checkbox"/> Incorrect loading. <input type="checkbox"/> Rinse agent depleted. <input type="checkbox"/> Rinse agent setting too low. <input type="checkbox"/> Eco wash program used.	<input type="checkbox"/> Ensure the dishes are not nesting together. <input type="checkbox"/> Refill the rinse agent dispenser. <input type="checkbox"/> Increase the rinse agent setting. <input type="checkbox"/> Choose a standard wash program.
Foaming	<input type="checkbox"/> Incorrect amount of detergent. <input type="checkbox"/> Too much egg in the wash load. <input type="checkbox"/> Rinse agent setting too high.	<input type="checkbox"/> Refer to the detergent section or consult the detergent manufacturer's instructions. <input type="checkbox"/> Add detergent to the pre-rinse compartment. <input type="checkbox"/> Decrease the rinse agent setting.
No detergent dispensed	<input type="checkbox"/> Detergent was wet when loaded.	<input type="checkbox"/> Clean the dispenser and ensure the dispenser is dry when adding detergent.
Excessive motor noise	<input type="checkbox"/> The filter plate and/or spray arm is incorrectly placed. <input type="checkbox"/> No water in the motor area. This usually occurs on the first use or when the DishDrawer® has not been used for long periods of time.	<input type="checkbox"/> Refer to the user maintenance section for details on correct placement. <input type="checkbox"/> Run the DishDrawer® through a wash program.
Water leaking	<input type="checkbox"/> Drain hose disconnected from waste pipe. <input type="checkbox"/> Supply inlet hose not properly connected. <input type="checkbox"/> Other leaks.	<input type="checkbox"/> Reconnect the drain hose to the waste pipe. <input type="checkbox"/> Ensure the inlet hose is connected securely. <input type="checkbox"/> Turn water and power supplies to the DishDrawer® off. Call your <i>Fisher & Paykel</i> dealer or Authorized Service Agent.
DishDrawer® will not open	<input type="checkbox"/> Childlock function is on or the Closed Drawer option is on, or both.	<input type="checkbox"/> Turn Lock off. Hold down the LOCK button until the 'lock' symbol (prefinished models) or the green light (integrated models) disappears and/or press the POWER button to open the DishDrawer® .
Intermittent beeping	<input type="checkbox"/> DishDrawer® is in pause mode.	<input type="checkbox"/> Close the DishDrawer® and press the START/PAUSE button.
Continuous beeping	<input type="checkbox"/> A fault has occurred.	<input type="checkbox"/> Refer to the fault codes section.

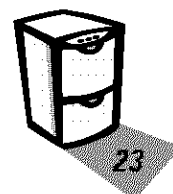

How to Recognize a Fault Code

When a fault has occurred, the **DishDrawer®** will continuously beep every second.

The fault code will be displayed on the Electronic Display for prefinished and on the inside control panel for integrated models.

Each fault code is shown in the chart below for prefinished and integrated models.

How to Attend to a Fault Code

1. Press the POWER button to remove the fault code.











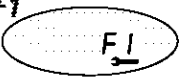

2. If the fault code and continuous beeps cannot be removed by pressing the POWER button, turn the power off at the power supply.

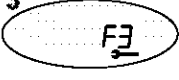
3. We recommend you check the chart below and correct the fault where possible.

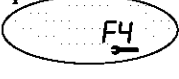
4. After attending to the fault, turn the **DishDrawer®** on at the power supply.

5. If the fault code and continuous beeps remain, turn the water and power supply off to the **DishDrawer®**.

6. When calling your *Fisher & Paykel* Authorized Service Center advise them of the fault code that has appeared on the **DishDrawer®**. This information will help the Authorized Service Center respond better to your request.

Fault Codes		Possible Causes	What to Do
Prefinished Models	Integrated Models		
<p>F1</p> 	 <p>HEAVY NORMAL PART DELICATE HANDLE</p>	Hood switch has been activated.	Turn the water and power supply to the DishDrawer® off and call your <i>Fisher & Paykel</i> Authorized Service Center.
<p>F2</p> 	 <p>HEAVY NORMAL PART DELICATE HANDLE</p>	Motor problem.	Call your <i>Fisher & Paykel</i> Authorized Service Center.
<p>F3</p> 	 <p>HEAVY NORMAL PART DELICATE HANDLE</p>	Temperature sensor failed.	Ensure water coming in through the inlet hose is not hotter than 149°F. You may need to install a tempering valve on your water supply.
<p>F4</p> 	 <p>HEAVY NORMAL PART DELICATE HANDLE</p>	Faulty temperature sensor or element	Call your <i>Fisher & Paykel</i> Authorized Service Center.
<p>F9</p> 	 <p>HEAVY NORMAL PART DELICATE HANDLE</p>	Electronics malfunction.	Call your <i>Fisher & Paykel</i> Authorized Service Center.
<p>U1</p> 	 <p>HEAVY NORMAL PART DELICATE HANDLE</p>	Fill Fault	<ul style="list-style-type: none"> Turn the DishDrawer® water supply on. Ensure the spray arm can rotate about the center, and if the DishDrawer® is full of water, it will need to be emptied manually.

If you have any questions about operating the product, please contact our *Fisher & Paykel* Customer Care Center.



WARNING

When using your DishDrawer[®], follow basic precautions, including the following: Please read all instructions before operating the DishDrawer[®].

For your safety the information in this manual must be followed to minimize the risk of fire or explosion or to prevent property damage, personal injury or loss of life.

Use the **DishDrawer[®]** only for its intended function as described in this User Guide.

Use only detergents or rinse agent recommended for use in a domestic dishwasher and keep them out of reach of children. Check that the detergent dispenser is empty after the completion of each wash program.

When loading items to be washed locate sharp items so that they are not likely to damage the lid seal and load sharp knives with the handles up to reduce the risk of cut type injuries.

Do not touch the heater plate during or immediately after use.

Do not operate your **DishDrawer[®]** unless all the enclosure panels are properly in place.

Do not tamper with the controls.

Do not abuse, sit on, stand in or on the drawer or dish rack of the **DishDrawer[®]**.

The cup racks are designed to support cups, glasses and kitchen utensils. When the cup racks are in the **DishDrawer[®]** do not lean on or use the cup racks to support your body weight.

To reduce the risk of injury, do not allow children to play in or on the **DishDrawer[®]**.

Under certain conditions hydrogen gas may be produced in a hot water heater system that has not been used for two weeks or more. HYDROGEN GAS IS EXPLOSIVE. If the hot water system has not been used for such a period, before using the dishwasher, turn on all hot water taps and let the water flow from each for several minutes. This will release any accumulated hydrogen gas. As gas is flammable, do not smoke or use an open flame during this time.

Remove the door to the washing compartment when removing an old dishwasher from service or discarding it.

Dishwasher detergents are alkaline. They can be dangerous if swallowed. Avoid contact with skin and eyes, keep children and infirm person(s) away from the dishwasher when the drawer is opened.

Installation

This **DishDrawer[®]** must be installed and located in accordance with the Installation Instructions before it is used. If you did not receive Installation Instruction sheets with your **DishDrawer[®]**, you can order them by calling your *Fisher & Paykel* Authorized Service Agent or our Customer Care Center.

Installation and service must be performed by a qualified technician.

If the power supply cord is damaged, it must be replaced by a *Fisher & Paykel* Dealer or Authorized Service Center or a similar qualified trades person in order to avoid a hazard.

Ensure the **DishDrawer[®]** is secured to adjacent cabinetry using the brackets provided. Failure to do so may result in an unstable product, which may cause damage or injury.

Do not operate this appliance if it is damaged, malfunctioning, partially disassembled or has missing or broken parts, including a damaged power supply cord or plug.

Do not store or use petrol, or other flammable vapours and liquids in the vicinity of the **DishDrawer[®]**.

Connect to a properly rated, protected and sized power supply circuit to avoid electrical overload.

Make sure that the power supply cord is located so that it will not be stepped on, tripped over or otherwise subject to damage or stress.

Do not install or store the **DishDrawer[®]** where it will be exposed to temperatures below freezing or exposed to weather.

Do not use an extension cord or a portable electrical outlet device (e.g. multi socket outlet box) to connect the **DishDrawer[®]** to the power supply.

DishDrawer[®]

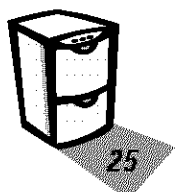

Maintenance

Do not repair or replace any part of the appliance or attempt any servicing unless specifically recommended in this User Guide. We recommend that you call a *Fisher & Paykel* Authorized Service Agent.

Keep the floor around your appliance clean and dry to reduce the possibility of slipping.

Keep the area around/ underneath your appliance free from the accumulation of combustible materials, such as lint, paper, rags and chemicals.

When cleaning the underside of the filter plate, care must be taken on the sharp outer edge to avoid the risk of cut type injuries.

Operational

Under no circumstances should you open the drawer whilst the DishDrawer® is in operation. Always press the Start/Pause button to pause and wait until you hear the three additional beeps before opening the drawer.

The **DishDrawer®** must be used with the motor assembly, filter plate, drain filter and spray arm in place.

When disconnecting the appliance pull the plug rather than the power supply cord or junction of cord to avoid damage.

Take care when loading the **DishDrawer®** not to load dishware items so it prevents the lid from properly sealing with the drawer. Items should be placed so they do not protrude above and/or forced into the drawer, otherwise a service call may result.

Household appliances are not intended to be played with by children. Children or persons with a disability which limits their ability to use the appliance, should have a responsible person instruct them in its use. The instructor should be satisfied that they can then use the appliance without danger to themselves or their surroundings.

Close supervision is necessary if this appliance is used by or near children. Do not allow children to play inside, on or with this appliance or any discarded appliance.

If a Dishwasher cleaner is used, we would strongly recommend a wash program with detergent afterward, to prevent any damage to the **DishDrawer®**.

The **DishDrawer®** is designed for washing normal household utensils. Items that are contaminated by petrol, paint, steel or iron debris, corrosive, acidic or alkaline chemicals are not to be washed in the **DishDrawer®**.

If the **DishDrawer®** is not being used for long periods of time, turn the electricity and water supply to the **DishDrawer®** off.

Do not pour detergent or rinse agent into the salt reservoir. The detergent or rinse agent will destroy the water softener (DD603H and DS603H models only).

It is important that the User Guide should be retained with the appliance for future reference. Should the appliance be sold or transferred to another owner, always ensure that the User Guide is left with the appliance in order that the new owner can become familiar with the appliance and the relevant warnings.

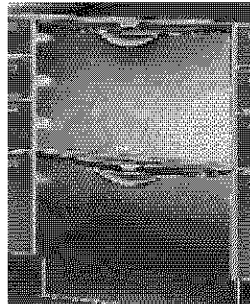

When you purchase any new *Fisher & Paykel* whiteware Product you automatically receive a 2 year Manufacturer's Warranty covering parts and labor for servicing within the 48 mainland states, Hawaii and Washington DC.

FISHER & PAYKEL UNDERTAKES TO:

Repair or, at its option, replace without cost to the owner either for material or labor any part of the Product, the serial number of which appears on the Product, which is found to be defective within TWO YEARS of the date of purchase.

This warranty DOES NOT cover

- A.** Service calls to which are not related to any defect in the Product. The cost of a service call will be charged if the problem is not found to be a Product fault. For example:
 - 1. Correct the installation of the Product.
 - 2. Instruct you how to use the Product.
 - 3. Replace house fuses or correct house wiring or plumbing.
 - 4. Correcting fault(s) caused by the user.
 - 5. Noise or vibration that is considered normal, e.g. drain sounds, regeneration noises or user warning beeps.
 - 6. Correcting damage caused by pests, e.g. rats, cockroaches etc.
- B.** Defects caused by factors other than:
 - 1. Normal domestic use or
 - 2. Use in accordance with the Product's User Guide.
- C.** Defects to the Product caused by accident, neglect, misuse or Act of God.
- D.** The cost of repairs carried out by non-authorized repairers or the cost of correcting such unauthorized repairs.
- E.** Normal recommended maintenance as set out in the Product's User Guide.

SERVICE UNDER THIS MANUFACTURER'S WARRANTY MUST BE PROVIDED BY *FISHER & PAYKEL*. SUCH SERVICE SHALL BE PROVIDED DURING NORMAL BUSINESS HOURS. THIS WARRANTY CERTIFICATE SHOULD BE SHOWN WHEN MAKING ANY CLAIM.

Note: This Warranty is an extra benefit and does not affect your legal rights.

PRODUCT DETAILS

Fisher & Paykel Ltd.

Model/Serial No.

Date of Purchase

Purchaser

Dealer

Suburb

Town

Country

This warranty applies only to product purchased in the United States of America.



Please keep this User Guide in a safe place.

Do not return to Fisher & Paykel.

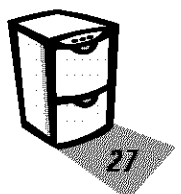

Before you call for service or assistance ...

Check the things you can do yourself. Refer to your User Guide and check...

1. Your product is correctly installed
2. You are familiar with its normal operation

If after checking these points you still need assistance, please refer to the following...

In the USA if you need assistance ...*

For your local Fisher & Paykel Authorized Service Agent, please call

Toll Free: 1 888 9 FNP USA (1 888 9 367 872)

or contact us through our web site,

Website: www.fisherpaykel.com

** If you call or write, please provide: name and address, model number, serial number, date of purchase and a complete description of the problem. This information is needed in order to better respond to your request for assistance.*

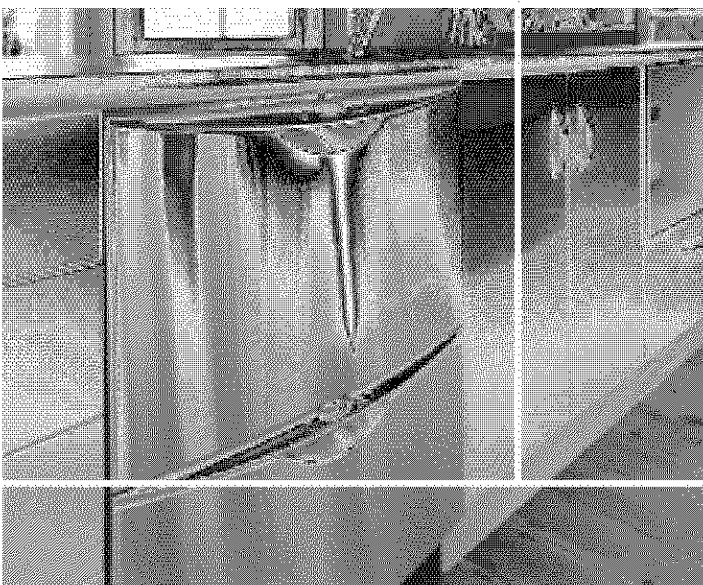

Installation Checklist

Your installer **MUST** have completed and checked the following:

- The **DishDrawer®** is square and level.
- The **DishDrawer®** is fastened securely to the cabinetry.
- Ensure moisture protection tape has been applied and the cabinet is sealed according to the Installation Instructions.
- The **DishDrawer®** opens and closes freely. The **DishDrawer®** must be free to close completely with no resistance from cabinetry.
- For the integrated models, check the 8mm air gap has been achieved in the correct place.
- The power supply is connected and switched on.
- The inlet water hose is connected and turned on. There should be no leaks.
- The drain hose(s) are connected and there are no leaks. There must be no kinks, or obstructions in the drain hose(s).
- The spray arm is in the center and can freely rotate.
- The rinse program has been run.
- The water level will be below the stainless steel filter plate at the end of the wash program. It is normal to find some water in the drain filter area.
- Set the water softener to the correct water hardness for your area (DD603H and DS603H models only).

The installer is responsible for the DishDrawer® installation. Incorrect installation is not covered by warranty.

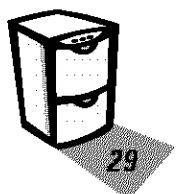

Copyright Reserved © Fisher & Paykel 2003.

The product specifications in this booklet apply to the specific products and models described at the date of issue.

Under our policy of continuous product improvement, these specifications may change at any time.

You should therefore check with your Dealer to ensure this booklet correctly describes the product currently available.

USA Customer Care - 1 888 9 FNP USA (1 888 9 367 872)

www.fisherpaykel.com

date of issue : **March 2003**

part number : **526985 B**

USA