

ENGLISH
OWNER'S
MANUAL

Memorex[®]

COLOR TELEVISION

MT1134
MT1194

CAUTION

Changes or modifications not expressly approved by the party responsible for compliance with the FCC Rules could void the user's authority to operate this equipment.

ATTENTION

If you purchase a universal remote control from your local retailer, please contact the remote manufacturer for the required programming code.

TV/CATV MODE SELECTION

When shipped from the factory, the TV/CATV menu option is set to the "CATV" (Cable Television) mode. If not using CATV, set this menu option to "TV" mode.

FEATURES

Quartz PLL Frequency Synthesized Tuning System - Electronically locks in and memorizes available channels for perfect reception.

181 Channel Tuner - The tuning system is capable of receiving all 68 VHF/UHF standard broadcast channels that are available in your area. When operating on a cable system, it can tune to the standard VHF channel frequencies plus up to 113 cable channel frequencies. The actual number of channels received depends upon channel reception in your area or your cable system.

On-Screen 3 Language Display - This TV can display the on screen language in English, Spanish or French.

Picture Adjustments Using The Remote Control - The On-Screen display allows precise remote control adjustment of BRIGHTNESS, COLOR, CONTRAST, SHARPNESS and TINT.

Sleep Timer - Operable from the remote control, this TV can be programmed up to 120 minutes to turn off automatically.

Memory Back Up - This system prevents loss of memorized channel selections in case a power interruption to the TV should occur.

Closed Captioned Decoder - Displays text captions or 1/2 of full screen text on the screen for hearing impaired viewers.

V-Chip - The V-Chip function can read the rating of a TV program or movie content if the program is encoded with this information. The V-Chip will allow you to set a restriction level.

ANTENNA/CATV CONNECTIONS

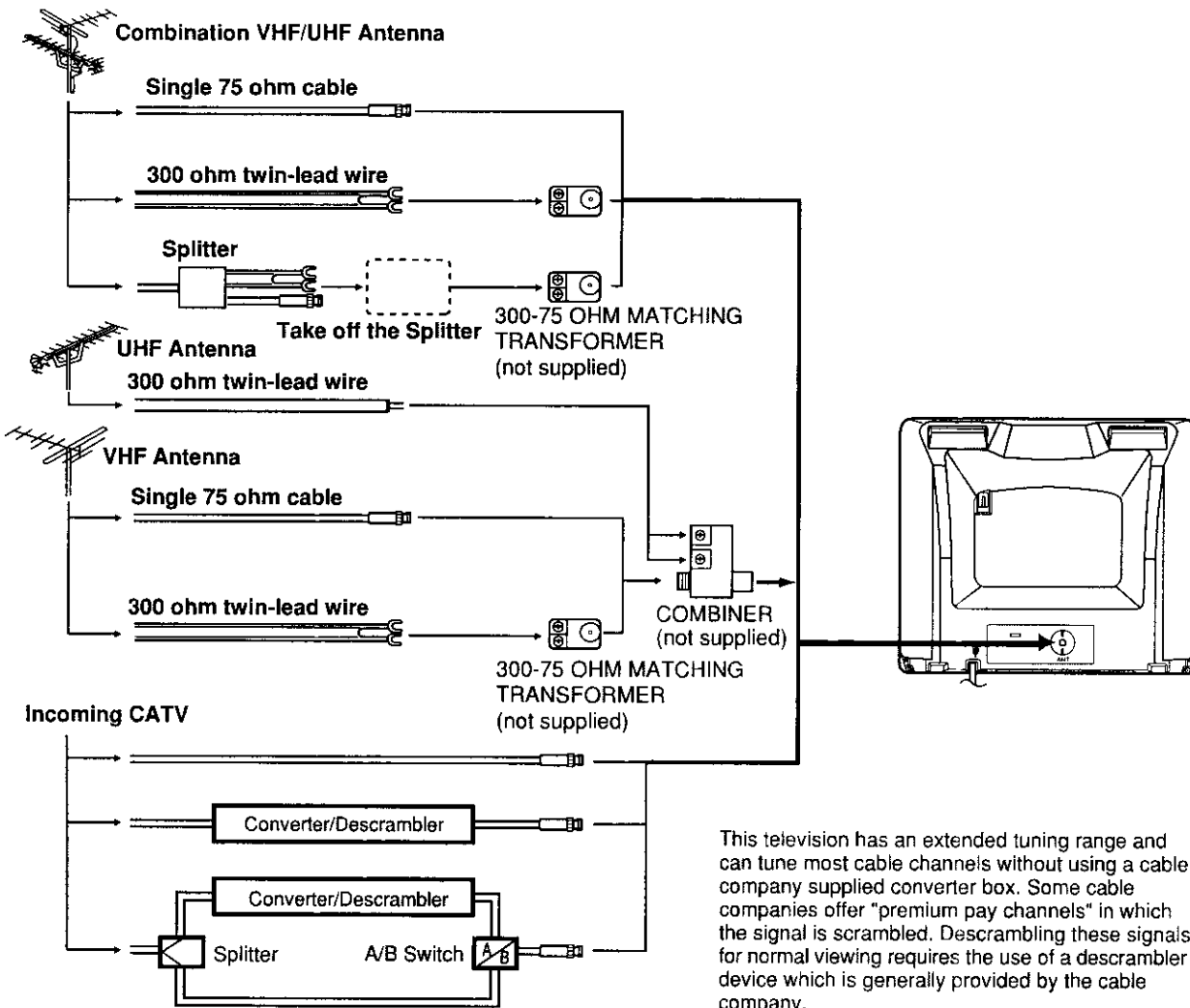

This television has an extended tuning range and can tune most cable channels without using a cable company supplied converter box. Some cable companies offer "premium pay channels" in which the signal is scrambled. Descrambling these signals for normal viewing requires the use of a descrambler device which is generally provided by the cable company.

Combination VHF/UHF Antenna (Single 75 ohm cable or 300 ohm twin-lead wire)

Connect the 75 ohm cable from a combination VHF/UHF antenna to the antenna jack.
If your combination antenna has a 300 ohm twin-lead wire, use the 300-75 ohm matching transformer (not supplied).

Combination VHF/UHF Antenna (Separate VHF and UHF 300 ohm twin-lead)

Connect the UHF twin-lead wire to a combiner (not supplied). Connect the VHF twin-lead to the 300-75 ohm matching transformer (not supplied). Attach the transformer to the combiner. Attach the combiner to the antenna jack.

Separate VHF/UHF Antenna

Connect the 75 ohm cable from the VHF antenna and the UHF antenna twin-lead to a combiner (not supplied). Attach the combiner to the antenna jack.

NOTE: If your VHF antenna has a twin-lead wire, use the 300-75 ohm matching transformer (not supplied), then connect the transformer to the combiner.

For Subscribers to Basic Cable TV Service

For basic cable service not requiring a converter/descrambler box, connect the CATV 75 ohm coaxial cable directly to the antenna jack on the back of the television.

For Subscribers to Scrambled Cable TV Service

If you subscribe to a cable service which requires the use of a converter/descrambler box, connect the incoming cable to the converter/descrambler box and connect the output of the box to the antenna jack on the back of the television. Follow the connections shown left. Set the television to the output of the converter/descrambler box (usually channel 3 or 4) and use the converter/descrambler box to select channels.

For Subscribers to Unscrambled Basic Cable with Scrambled Premium Channels

If you subscribe to a cable service in which basic cable channels are unscrambled and premium channels require the use of a converter/descrambler box, you may wish to use a two-set signal splitter (sometimes called a "two-set coupler") and an A/B switch box from the cable installer or an electronics supply store. Follow the connections shown left. With the switch in the "B" position, you can directly tune any unscrambled channels on your TV. With the switch in the "A" position, tune your TV to the output of the converter/descrambler box (usually channel 3 or 4) and use the box to tune scrambled channels.

TO MEMORIZE CHANNELS

This TV is equipped with a channel memory feature which allows channels to skip up or down to the next channel set into memory, skipping over unwanted channels. Before selecting channels, they must be programmed into the TV's memory. In addition to normal VHF and UHF channels, this TV can receive up to 113 Cable TV channels. To use this TV with an antenna, set the TV/CATV menu option to the TV setting. When shipped from the factory, this menu option is in the CATV setting.

TV/CATV SELECTION

- Press the MENU button.
- Press the SET + or - button until the indicator next to "CH SETUP" begins to flash, then press the ENTER button.
- Press the SET + or - button until the indicator next to "TV/CATV" begins to flash.
- Press the ENTER button to select the TV or CATV mode. The arrow indicates the selected mode.
- Press the MENU button twice to return to normal TV viewing.



The chart below is typical of many cable system channel allocations.
CATV CHART

Number on this TV	Corresponding CATV channel	14	15	16	17	18	19	20	21	22
23	24	25	26	27	28	29	30	31	32	33
J	K	L	M	N	O	P	Q	R	S	T
41	42	43	44	45	46	47	48	49	50	51
EE	FF	GG	HH	II	JJ	KK	LL	MM	NN	OO
59	60	61	62	63	64	65	66	67	68	69
WW	AAA	BBB	CCC	DDD	EEE	FFF	GGG	HHH	III	JJJ
77	78	79	80	81	82	83	84	85	86	87
RRR	SSS	TTT	UUU	VVV	WWW	XXX	YYY	ZZZ	88	89
95	96	97	98	99	100	101	102	103	104	105
A-5	A-4	A-3	A-2	A-1	100	101	102	103	104	105
113	114	115	116	117	118	119	120	121	122	123
113	114	115	116	117	118	119	120	121	122	123

NOTE:
 Contact your cable company to determine the type of cable system used in your area.

AUTOMATIC CHANNEL MEMORY

- Press the MENU button.
- Press the SET + or - button until the indicator next to "CH SETUP" begins to flash, then press the ENTER button.
- Press the SET + or - button until the indicator next to "AUTO CH MEMORY" begins to flash, then press the ENTER button. The TV will begin memorizing all the channels available in your area. Channel numbers will remain red until auto memorizing is complete.
- Press the MENU button twice to return to normal TV viewing.



TO ADD/DELETE CHANNELS

- Press the MENU button.
- Press the SET + or - button until the indicator next to "CH SETUP" begins to flash, then press the ENTER button.
- Press the SET + or - button until the indicator next to "ADD/DELETE" begins to flash, then press the ENTER button.
- Select the desired channels to be added or deleted using the Direct Channel Selection buttons (10 keys, 0-9), the CH ^ or v button or the SET + or - button.
- Press the ENTER button to select ADD or DELETE. If an unmemorized channel was selected (step 4), the channel indicator will be red. Press the ENTER button if you wish to ADD the unmemorized channel. The channel indicator will change from red to green when a channel is added and the channel will be memorized. If a memorized channel was selected (step 4), the channel indicator will be green. Press the ENTER button if you wish to DELETE the channel from memory. The channel indicator will change from green to red when a channel is deleted. Repeat steps 4 and 5 for each channel to be added or deleted.
- Press the MENU button three times after adding or deleting all of the desired channels, to return to normal TV viewing.

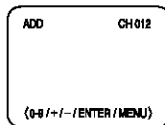
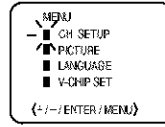

ADJUSTING PICTURE

You can adjust the settings for color, sharpness, contrast, brightness and tint.

- Press the MENU button.
- Press the SET + or - button until the indicator next to "PICTURE" begins to flash, then press the ENTER button.
- Press the ENTER button repeatedly to select the item you want to adjust.
 BRIGHTNESS → CONTRAST → COLOR → TINT → SHARPNESS
- Press the SET + or - button to adjust the setting.

	+	-
BRIGHTNESS	increase brightness	decrease brightness
CONTRAST	increase contrast	decrease contrast
COLOR	be brilliant color	be pale color
TINT	be greenish color	be reddish color
SHARPNESS	makes picture clearer	makes picture softer

TO RETURN TO INITIAL SETTING
 Press the RESET button while the picture adjusting mode appears on-screen.

CONNECTION TO OTHER EQUIPMENT

The exact arrangement you use to interconnect various video and audio components to the TV is dependent on the model and features of each component. Check the Owner's Manual provided with each component for the location of video and audio inputs and outputs.

The connection diagrams below are offered as suggestions. You may need to modify them to accommodate your particular assortment of components. The diagrams are intended to show component video and audio interconnections only.

TV/AV SELECTION

If you connect the TV to a VCR, camcorder or TV game, through the audio/video in jacks, use the TV/AV button to make your selection.

Press the TV/AV button repeatedly to select the desired mode.
 "AUX" will display on the screen for 4 seconds.

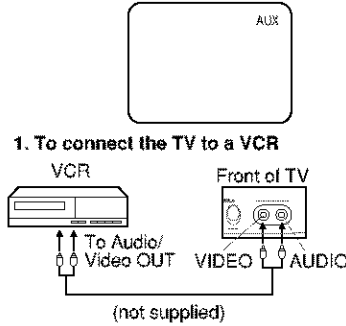

1. To connect the TV to a VCR

2. To connect the TV to a TV Game

The TV can also be used as a display device for many video games. However, due to the wide variety of different types of signal generated by these devices and subsequent hook-up variations required, they have not all been included in the suggested connection diagrams. You'll need to consult each component's Owner's Manual for additional information.

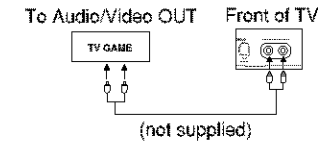

3. To connect the TV to a camcorder

To playback from the camcorder, connect the camcorder to the TV as shown.

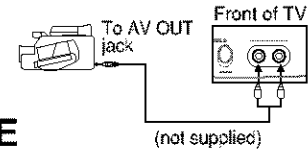

TROUBLESHOOTING GUIDE

Before requesting service, please refer to the following chart for the symptom and possible solution.

SYMPTOMS	POSSIBLE SOLUTIONS
TV does not operate.	<ul style="list-style-type: none"> Make sure the power cord is plugged in. Try another AC outlet. Power is off, check fuse or circuit breaker. Unplug unit for an hour, then plug it back in.
Poor sound or No sound.	<ul style="list-style-type: none"> Station or CATV experiencing problems, tune to another station. Check sound adjustments (VOLUME and MUTE). Check for sources of possible interference.
Poor picture or No picture.	<ul style="list-style-type: none"> Station or CATV experiencing problems, tune to another station. Make sure channels are set into memory. Check antenna or CATV connections, adjust antenna. Check for sources of possible interference. Check picture control adjustments.
Poor reception on some channels.	<ul style="list-style-type: none"> Station or CATV experiencing problems, tune to another station. Make sure channels are set into memory. Station is weak, adjust antenna to receive desired station. Check for sources of possible interference.
Poor color or no color.	<ul style="list-style-type: none"> Station or CATV experiencing problems, tune to another station. Make sure channels are set into memory. Check picture control adjustments. Check antenna or CATV connections, adjust antenna. Check for sources of possible interference.
Picture wobbles or drifts.	<ul style="list-style-type: none"> Station or CATV experiencing problems, tune to another station. Make sure channels are set into memory. CATV company is scrambling signal. Adjust antenna.
No CATV reception.	<ul style="list-style-type: none"> Check all CATV connections. Set TV/CATV menu option to the CATV mode. Station or CATV system problems, try another station.
Horizontal or diagonal bars on screen.	<ul style="list-style-type: none"> Check antenna connections, adjust or re-direct antenna. Check for sources of possible interference.
No reception above channel 13.	<ul style="list-style-type: none"> Make sure TV/CATV menu option is in the appropriate mode. If using antenna, check UHF antenna connections.
No Remote operation.	<ul style="list-style-type: none"> Batteries are weak, dead or inserted incorrectly. Remote is out of range, move closer to TV (within 15 feet). Make sure Remote is aimed at sensor. Confirm there are no obstructions between the Remote and the TV. Make sure the power cord is plugged in.
TV shuts off.	<ul style="list-style-type: none"> No broadcast on station tuned. Sleep Timer is set. Power interrupted.
Closed - Caption is not activated.	<ul style="list-style-type: none"> TV station experiencing problems or program tuned is not closed captioned. Try another channel. Check CATV connection or VHF/UHF antenna, reposition or rotate antenna. Press TV/CAP/TEXT button to turn on the closed caption decoder.
Display is not shown in your language.	<ul style="list-style-type: none"> Select proper language in the menu options.

DEGAUSSING SYSTEM

This television has a degaussing circuit that will clear up color distortions on the TV screen that are caused by any excess magnetism which happens to get too close to the TV. This circuit is designed to operate once when the set is first plugged in. If minor color distortions are seen in some locations on the screen, please unplug the TV for approximately 15 minutes. When the TV is plugged back in, the degaussing circuit will operate once to clear up any color distortions. Repeat this procedure any time the TV screen is accidentally magnetized, or when the TV is moved or relocated.

SPECIFICATIONS

Model	MT1134	MT1194
AC Power Input:	120V, 60Hz	
AC Power Consumption:	54 Watts	73 Watts
Chassis Construction:	IC Solid state	
Picture Tube:	13" (measured diagonally)	19" (measured diagonally)
Horizontal resolution:	260 lines	
Audio Power Output Rating:	1.0 Watts	1.5 Watts
Speaker:	3" Full Range, 8 ohm	
Tuner Type:	181 Channel, Quartz PLL Frequency Synthesized	
Remote Control:	Infrared, Direct Access, 2 x AAA batteries (not supplied)	
Receiving Channels:	VHF 2-13 UHF 14-69 CATV 01-97 (5A)-(A-3) 98-99 (A-2)-(A-1) 14-22 (A)-(I) 23-36 (J)-(W) 37-65 (AA)-(FFF) 66-125 (GGG)-(125)	
Antenna Input Impedance:	75 Ohm (VHF/UHF/CATV) Coaxial Input	
Input:	Video: 1.0 Vp-p 75 ohm Audio: 300 mV, 47k ohm	
Dimensions:	14-1/4" (W) x 14-3/16" (D) x 12-5/8" (H)	19-3/16" (W) x 18-5/16" (D) x 16-3/8" (H)
Weight:	20.9 lbs	38.6 lbs

ACCESSORIES

Remote Control
 Telescopic Antenna (MT1134 only)

90 Day Full Warranty

If this (product) experiences any failure due to a defect in material or workmanship within 90 days from the date of purchase, return it to your nearest Sears store, and it will be replaced free of charge.

This warranty applies only if this (product) is used for private household purposes.

This warranty gives you specific legal rights, and you may also have other rights which vary from state to state.

Sears, Roebuck and Co., Dept. 817WA, Hoffman Estates, IL 60179

Please keep all packaging material for at least 90 days in case you need to return this product.

For parts, accessories, and service information, see the back cover.

Get it fixed, at your home or ours!

Your Home

For repair – **in your home** – of all major brand appliances, lawn and garden equipment, or heating and cooling systems, **no matter who made it, no matter who sold it!**

For the replacement parts, accessories and owner s manuals that you need to do-it-yourself.

For Sears professional installation of home appliances and items like garage door openers and water heaters.

1-800-4-MY-HOME® (1-800-469-4663)

Call anytime, day or night (U S A and Canada)

www.sears.com www.sears.ca

Our Home

For repair of carry-in items like vacuums, lawn equipment, and electronics, call or go on-line for the location of your nearest **Sears Parts & Repair Center.**

1-800-488-1222

Call anytime, day or night (U S A only)

www.sears.com

To purchase a protection agreement (U S.A.) or maintenance agreement (Canada) on a product serviced by Sears

1-800-827-6655 (U S A)

1-800-361-6665 (Canada)

Para pedir servicio de reparacion a domicilio, y para ordenar piezas

1-888-SU-HOGARSM

(1-888-784-6427)

Au Canada pour service en français

1-800-LE-FOYER^{MC}

(1-800-533-6937)

www.sears.ca

SEARS

® Registered Trademark / ™ Trademark / SM Service Mark of Sears Roebuck and Co
© Marca Registrada / ™ Marca de Fábrica / SM Marca de Servicio de Sears Roebuck and Co
^{MC} Marque de commerce / ^{MD} Marque déposée de Sears Roebuck and Co

© Sears, Roebuck and Co

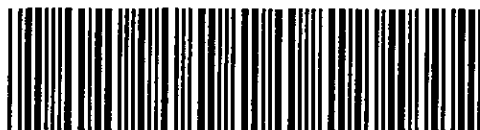

04/04



J3R00601A