

Memorex®

Is it live or is it Memorex?™

MT1701

User's Guide

17" Wide-screen LCD Stereo
Monitor with Integrated TV Tuner

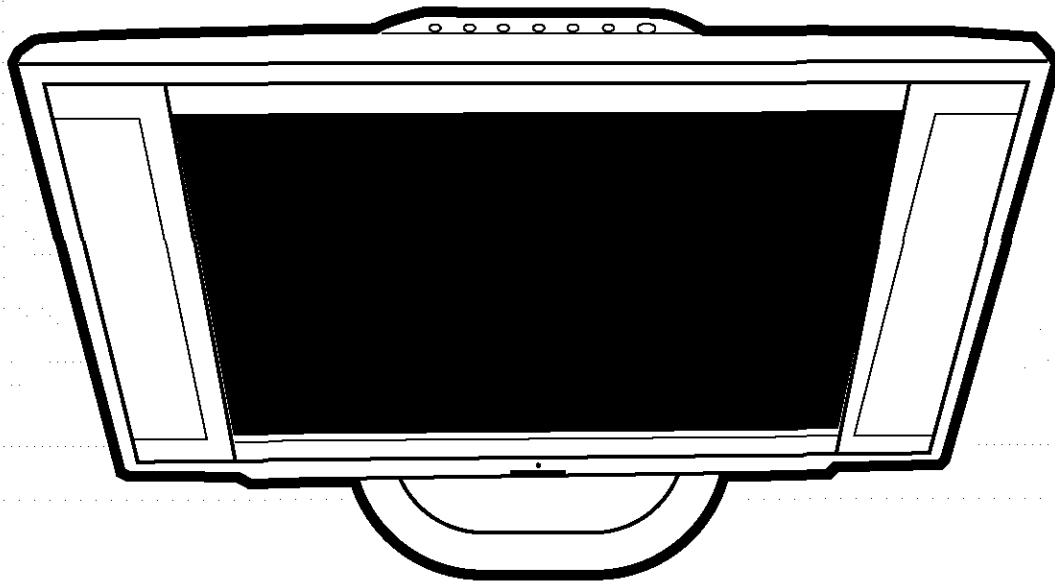

CONTENTS

Contents	1
Important Safety Instructions	2
Location of Controls	4
• Front	4
• Rear	5
• Remote Control	6
Remote Control	7
• Battery Installation	7
• Effective Distance of the Remote Control Transmitter	7
Power Source	8
Outdoor Antenna Connections	8
Cable (CATV)/Satellite Connections	9
VCR Connections	10
DVD Connections	12
Computer Connection	14
Kensington Lock	14
Viewing Angle Adjustment	15
Wall Mounting the Unit	16
TV Menus	17
• Audio Menu	17
• Video Menu	17
• System Menu	17
• Closed Captions Menu	18
• Setting the V-chip	19
AV Menus	20
• Audio Menu	20
• Video Menu	20
• System Menu	20
PC Menus	21
Setting the Channels into Memory	22
Adding and Skipping Channels	23
TV Operation	24
• Mute	25
• Last Channel	25
• TV/AV/PC	25
• MTS	25
• Display	26
• Sleep Timer	26
• 4:3/16:9	26
Standard Timing Table	27
Troubleshooting Guide	28
Reception Disturbances	29
Care and Maintenance	29
Specifications	30

IMPORTANT SAFETY INSTRUCTIONS



CAUTION

**RISK OF ELECTRIC SHOCK
DO NOT OPEN**



The lightning flash with arrowhead symbol within an equilateral triangle is intended to alert the user to the presence of uninsulated dangerous voltage within the product's enclosure that may be of sufficient magnitude to constitute a risk of electric shock to persons.



The exclamation point within an equilateral triangle is intended to alert the user to the presence of important operating and maintenance (servicing) instructions in the literature accompanying the appliance.

CAUTION: TO REDUCE THE RISK OF ELECTRIC SHOCK, DO NOT REMOVE COVER (OR BACK). NO USER-SERVICEABLE PARTS INSIDE. REFER SERVICING TO QUALIFIED SERVICE PERSONNEL.

WARNING: TO REDUCE THE RISK OF FIRE OR ELECTRIC SHOCK, DO NOT EXPOSE THIS APPLIANCE TO RAIN OR MOISTURE. TO PREVENT ELECTRIC SHOCK, MATCH THE WIDE BLADE OF THE PLUG TO THE WIDE SLOT AND FULLY INSERT.

Before using the unit, be sure to read all operating instructions carefully. Please note that these are general precautions and may not pertain to your unit. For example, this unit may not have the capability to be connected to an outdoor antenna.

1. READ INSTRUCTIONS

All the safety and operating instructions should be read before the product is operated.

2. RETAIN INSTRUCTIONS

The safety and operating instructions should be retained for future reference.

3. HEED WARNINGS

All warnings on the product and in the operating instructions should be adhered to.

4. FOLLOW INSTRUCTIONS

All operating and use instructions should be followed.

5. CLEANING

Unplug this product from the wall outlet before cleaning. Do not use liquid cleaners or aerosol cleaners. Use a damp cloth for cleaning.

6. ATTACHMENTS

Do not use attachments not recommended by the product's manufacturer as they may cause hazards.

7. WATER AND MOISTURE

Do not use this product near water- for example, near a bathtub, washbowl, kitchen sink, or laundry tub, in a wet basement, or near a swimming pool.

8. ACCESSORIES

Do not place this product on an unstable cart, stand, tripod, bracket, or table. The product may fall, causing serious injury and serious damage to the product. Use only with a cart, stand, tripod, bracket, or table recommended by the manufacturer or sold with the product. Any mounting of the product should follow the manufacturer's instructions, and should use a mounting accessory recommended by the manufacturer.

8A. An appliance and cart combination should be moved with care. Quick stops, excessive force, and uneven surfaces may cause the appliance and cart combination to overturn.

9. VENTILATION

Slots and openings in the cabinet and in the back or bottom are provided for ventilation and to ensure reliable operation of the product and to protect it from overheating. These openings must not be blocked or covered. The openings should never be blocked by placing the product on a bed, sofa, rug, or other similar surface. This product should never be placed near or over a radiator or heat source. This product should not be placed in a built-in installation such as a bookcase or rack unless proper ventilation is provided or the manufacturer's instructions have been adhered to.

10. POWER SOURCES

This product should be operated only from the type of power source indicated on the marking label. If you are not sure of the type of power supply to your home, consult your appliance dealer or local power company. For products intended to operate from battery power, or other sources, refer to the operating instructions.

11. GROUNDING OR POLARIZATION

This product is equipped with a polarized alternating-current line plug (a plug having one blade wider than the other). This plug will fit into the power outlet only one way. This is a safety feature. If you are unable to insert the plug fully into the outlet, try reversing the plug. If the plug should still fail to fit, contact your electrician to replace your obsolete outlet. Do not defeat the safety purpose of the polarized plug.

12. POWER-CORD PROTECTION

Power-supply cords should be routed so that they are not likely to be walked on or pinched by items placed upon or against them, paying particular attention to cords at plugs, convenience receptacles, and the point where they exit from the appliance.

PORTABLE CART WARNING
(symbol provided by RETAC)



S3126A

IMPORTANT SAFETY INSTRUCTIONS (CONTINUED)

13. LIGHTNING

To protect your product from a lightning storm, or when it is left unattended and unused for long periods of time, unplug it from the wall outlet and disconnect the antenna or cable system. This will prevent damage to the product due to lightning and power-line surges.

14. POWER LINES

An outside antenna system should not be located in the vicinity of overhead power lines or other electric light or power circuits, or where it can fall into such power lines or circuits. When installing an outside antenna system, extreme care should be taken to keep from touching such power lines or circuits as contact with them might be fatal.

15. OVERLOADING

Do not overload wall outlets and extension cords as this can result in a risk of fire or electric shock.

16. OBJECT AND LIQUID ENTRY

Never push objects of any kind into this product through openings as they may touch dangerous voltage points or short out parts that could result in fire or electric shock. Never spill or spray any type of liquid on the product.

17. OUTDOOR ANTENNA GROUNDING

If an outside antenna is connected to the product, be sure the antenna system is grounded so as to provide some protection against voltage surges and built-up static charges. Section 810 of the National Electric Code, ANSI/NFPA 70, provides information with respect to proper grounding of the mast and supporting structure, grounding of the lead-in wire to an antenna discharge product, size of grounding conductors, location of antenna discharge product, connection to grounding electrodes, and requirements for grounding electrode.

18. SERVICING

Do not attempt to service this product yourself as opening or removing covers may expose you to dangerous voltage or other hazards. Refer all servicing to qualified service personnel.

19. REPLACEMENT PARTS

When replacement parts are required, be sure the service technician uses replacement parts specified by the manufacturer or those that have the same characteristics as the original part. Unauthorized substitutions may result in fire, electric shock or other hazards.

20. SAFETY CHECK

Upon completion of any service or repairs to this product, ask the service technician to perform safety checks to determine that the product is in proper operating condition.

21. WALL OR CEILING MOUNTING

The product should be mounted to a wall or ceiling only as recommended by the manufacturer.

22. DAMAGE REQUIRING SERVICE

Unplug the product from the wall outlet and refer servicing to qualified service personnel under the following conditions:

- When the power-supply cord or plug is damaged.
- If liquid has been spilled, or objects have fallen into the product.
- If the product has been exposed to rain or water.
- If the product does not operate normally by following the operating instructions. Adjust only those controls that are covered by the operating instructions, as an adjustment of other controls may result in damage and will often require extensive work by a qualified technician to restore the product to its normal operation.
- If the product has been dropped or the cabinet has been damaged.
- When the product exhibits a distinct change in performance - this indicates a need for service.

23. HEAT

The product should be situated away from heat sources such as radiators, heat registers, stoves, or other products (including amplifiers) that produce heat.

24. NOTE TO CATV SYSTEM INSTALLER

This reminder is provided to call the CATV system installer's attention to Article 820-40 of the NEC that provides guidelines for proper grounding and, in particular, specifies that the cable ground shall be connected to the grounding system of the building, as close to the point of cable entry as practical.

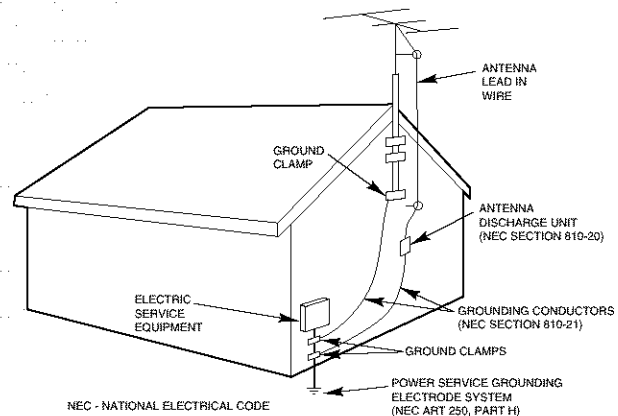

EXAMPLE OF ANTENNA GROUNDING AS PER NATIONAL ELECTRICAL CODE

LOCATION OF CONTROLS

FRONT

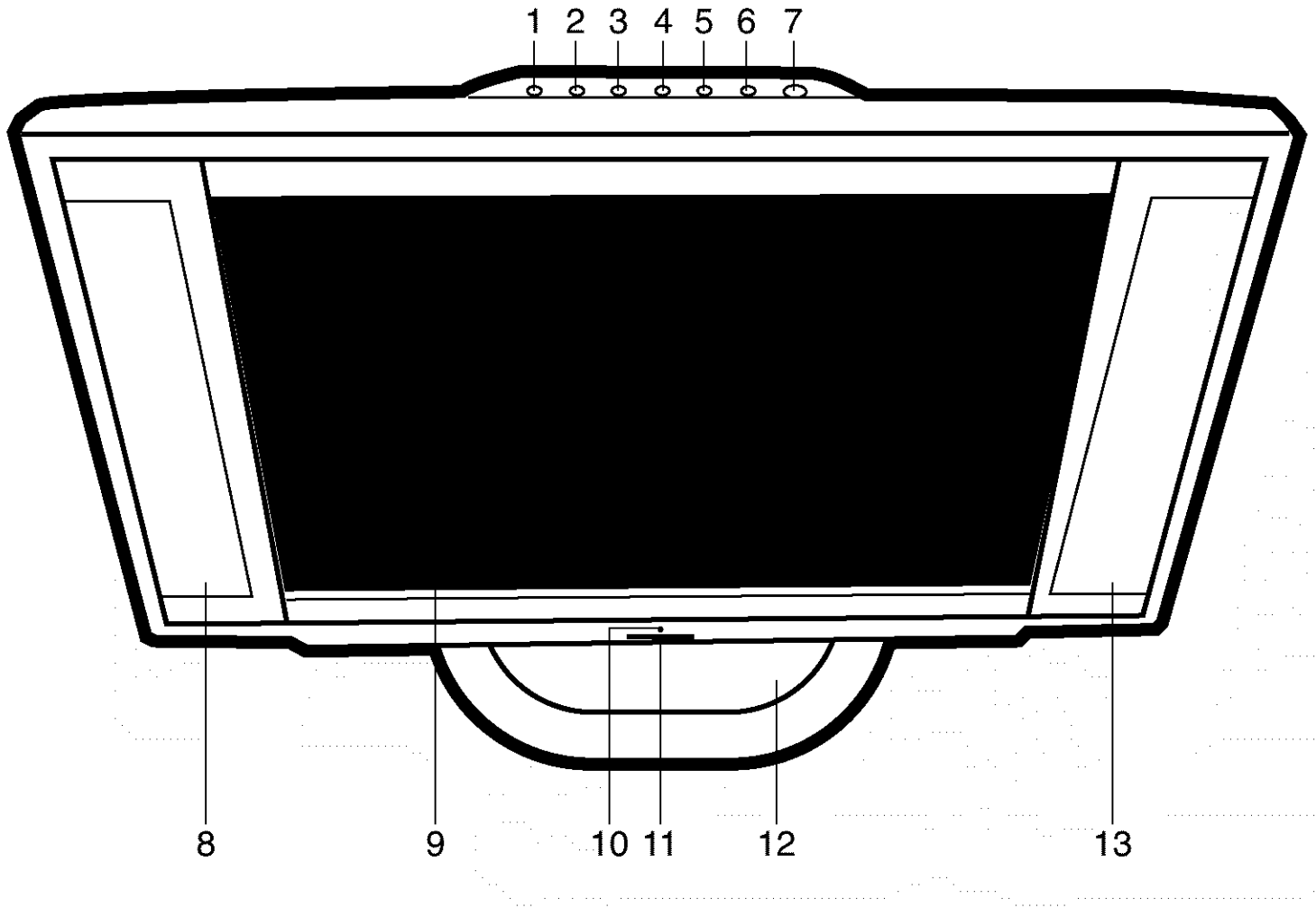

1. TV/AV/PC Button
2. Volume Down Button
3. Volume Up Button
4. Channel Down Button
5. Channel Up Button
6. MENU Button
7. Power Button
8. Left Speaker
9. Display
10. Power Indicator
11. Remote Sensor
12. Stand
13. Right Speaker

LOCATION OF CONTROLS (CONTINUED)

REAR

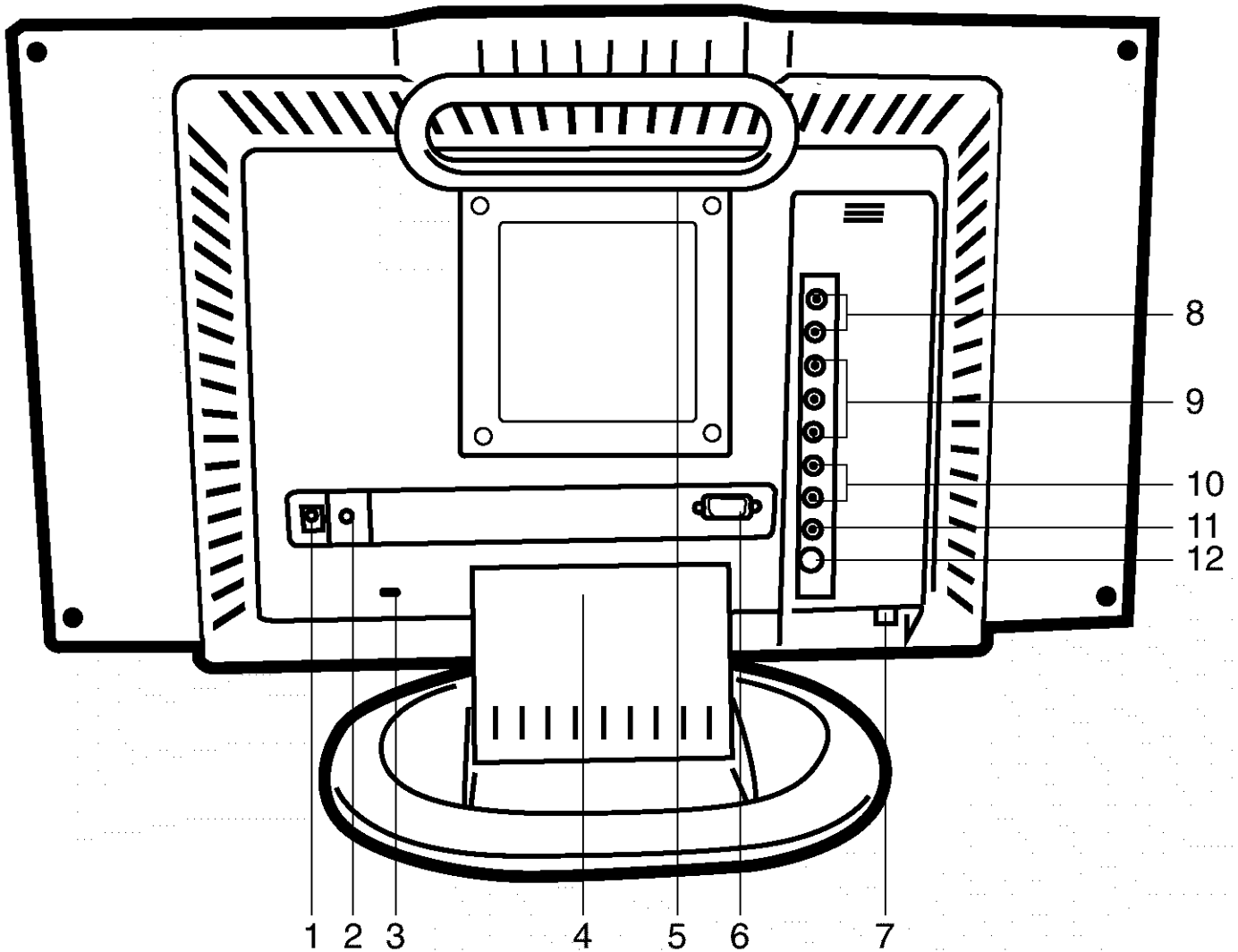

1. DC 12V IN Jack $\ominus\oplus$
2. VGA Audio IN Jack
3. Kensington Lock
4. Stand Cover
5. Handle
6. VGA IN Jack
7. ANT. IN Jack
8. AV2 AUDIO IN Right and Left Jacks
9. AV2 COMPONENT IN Jacks (Cr/Cb/Y)
10. AV1 AUDIO IN Right and Left Jacks
11. AV1 VIDEO IN Jack
12. S-VIDEO IN Jack

LOCATION OF CONTROLS (CONTINUED)

REMOTE

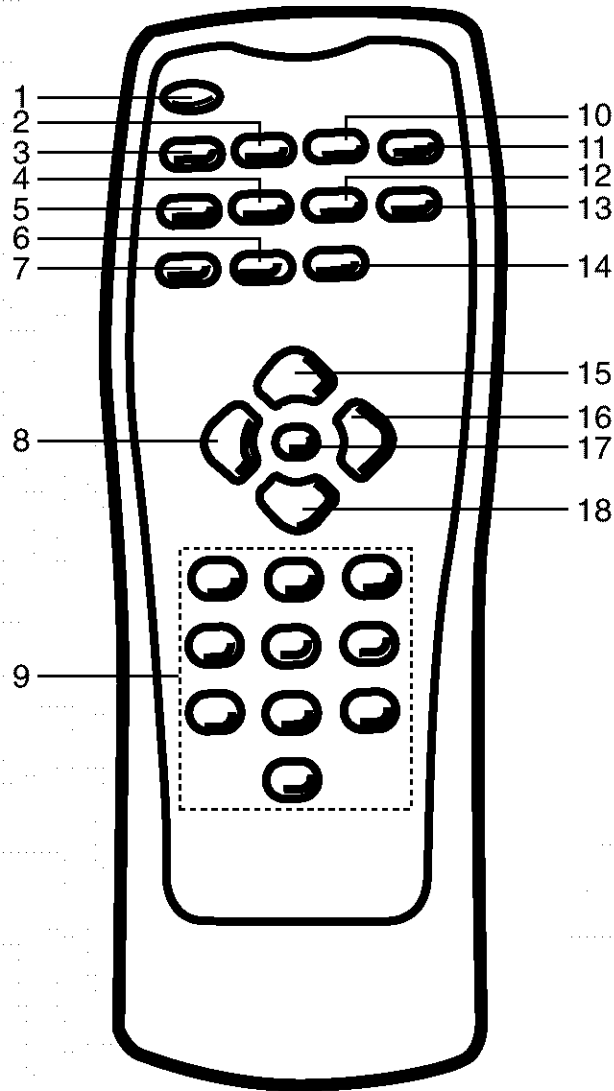

- | | |
|-------------------------------------|-------------------------|
| 1. POWER Button | 13. CHANNEL Down Button |
| 2. MTS Button | 14. 4:3/16:9 Button |
| 3. MUTE Button | 15. Navigation ↑ Button |
| 4. SLEEP Button | 16. Navigation ⇒ Button |
| 5. TV/AV/PC Button | 17. Menu (▶) Button |
| 6. DISPLAY Button | 18. Navigation ↓ Button |
| 7. LAST CH Button | |
| 8. Navigation ⇐ Button | |
| 9. Direct Channel Selection Buttons | |
| 10. VOLUME Up Button | |
| 11. CHANNEL Up Button | |
| 12. VOLUME Down Button | |

REMOTE CONTROL

BATTERY INSTALLATION

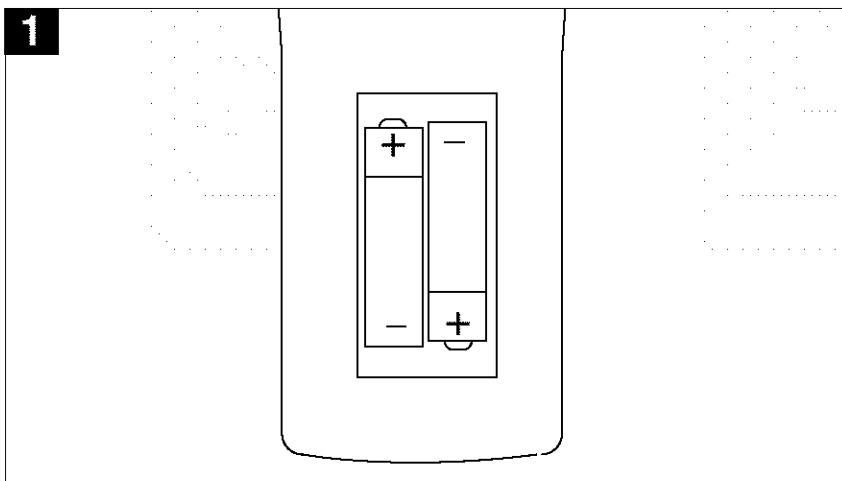

Open the battery compartment cover by pushing in on the tab, then lifting it up.

Install two “AAA” batteries, paying attention to the polarity diagram in the battery compartment.

Replace the battery compartment cover.

BATTERY PRECAUTIONS

Follow these precautions when using batteries in this device:

1. Use only the size and type of batteries specified.
2. Be sure to follow the correct polarity when installing the batteries as indicated in the battery compartment. Reversed batteries may cause damage to the device.
3. Do not mix different types of batteries together (e.g. Alkaline, Rechargeable and Carbon-zinc) or old batteries with fresh ones.
4. If the device is not to be used for a long period of time, remove the batteries to prevent damage or injury from possible battery leakage.
5. Do not try to recharge batteries not intended to be recharged; they can overheat and rupture. (Follow battery manufacturer’s directions.)

EFFECTIVE DISTANCE OF THE REMOTE CONTROL TRANSMITTER

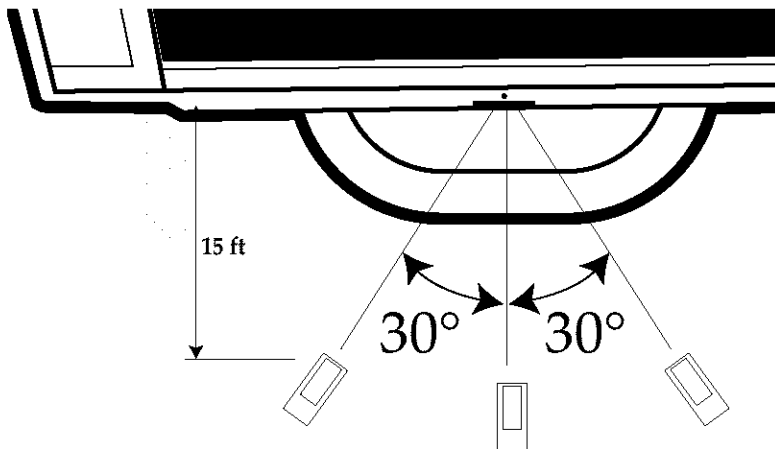

NOTES:

- When there is an obstacle between the TV and the transmitter, the transmitter may not operate.
- When direct sunlight, incandescent lamp, fluorescent lamp or any other strong light shines on the Remote Sensor of the TV, the remote operation may be unstable.

FAQs:

Why is the remote control not working properly?

- The remote control is not aimed at the sensor.
- The remote control is too far away from the remote sensor.
- There is too much light in the room.
- There is an obstacle in the path of the beam.
- The batteries are weak or dead.
- The batteries are inserted incorrectly.
- The TV is not plugged in.

POWER SOURCE

This appliance must be grounded. In the event of an electrical short circuit, grounding reduces the risk of electric shock by providing an escape wire for the electric current. This appliance is equipped with a cord having a grounding wire with a grounding plug. The plug must be inserted into an outlet that is properly installed and grounded.

WARNING: Improper use of the grounding plug can result in a risk of electric shock. Consult a qualified electrician or service person if the grounding instructions are not completely understood, or if doubt exists as to whether the unit is properly grounded.

If it is necessary to use an extension cord, use only a three wire extension cord that has a three blade grounding plug, and a three slot receptacle that will accept the plug on the appliance. The marked rating of the extension cord should be equal to or greater than the electrical rating of the unit.

To operate the unit using AC power, connect the AC Adapter to the DC 12V IN jack  on the rear of the unit,. Connect the AC cord to the adapter and then to a wall outlet having 120V AC, 60Hz only.

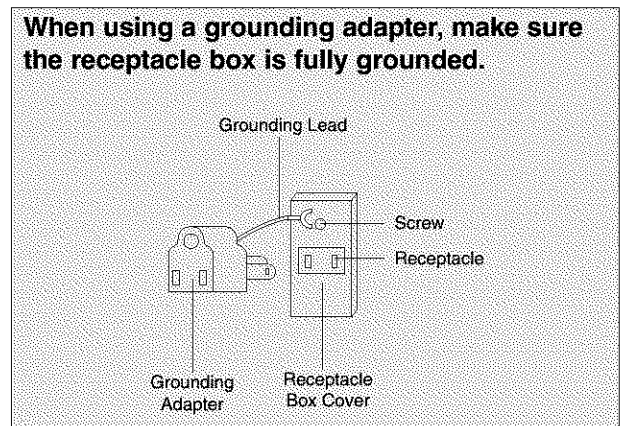
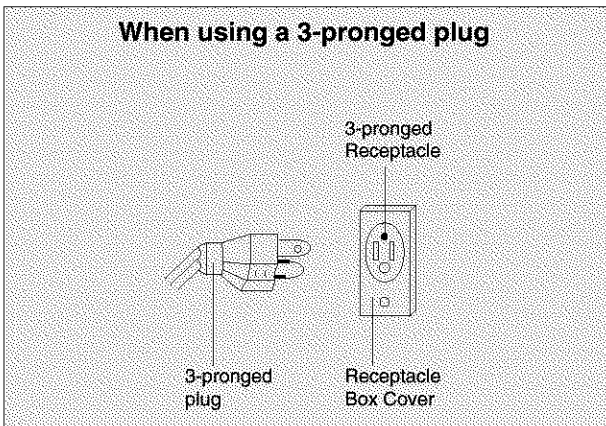

OUTDOOR ANTENNA CONNECTIONS

OUTDOOR VHF/UHF ANTENNA CONNECTION (ANTENNA NOT SUPPLIED)

Follow the instructions for the type of antenna system you intend to use.

Combination VHF/UHF Antenna (Single 75 ohm cable or 300 ohm twin-lead wire)

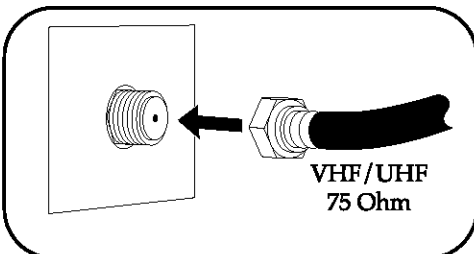

Connect the 75 ohm cable from the combination VHF/UHF antenna to the antenna jack.

OR

If your combination antenna has a 300 ohm twin-lead wire, use a 300-75 ohm matching transformer (NOT SUPPLIED).

Combination VHF/UHF Antenna (Separate VHF and UHF 300 ohm twin-leads)

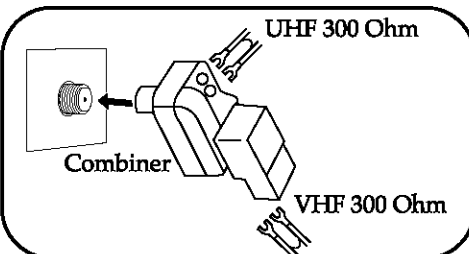

Connect the UHF twin-lead wire to a combiner (NOT SUPPLIED). Connect the VHF twin-lead to a 300-75 ohm matching transformer (NOT SUPPLIED). Attach the transformer to the combiner. Attach the combiner to the antenna jack.

Separate VHF/UHF Antennas

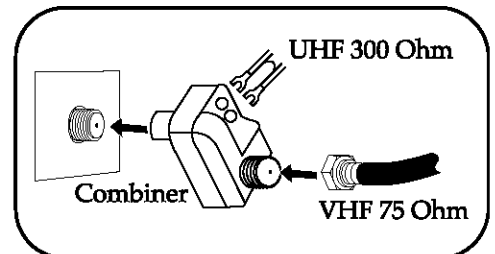

Connect the 75 ohm cable from the VHF antenna and the UHF antenna twin-lead wire to a combiner (NOT SUPPLIED). Attach the combiner to the antenna jack.

NOTE: If your VHF antenna has a twin-lead wire use a 300-75 ohm matching transformer, then connect the transformer to the combiner.

CABLE (CATV)/SATELLITE CONNECTIONS

This TV has an extended tuning range and can tune most cable channels without using a Cable TV converter box. Some Cable TV companies offer "premium pay channels" in which the signal is scrambled. Descrambling these signals for normal viewing requires the use of a descrambler device which is generally provided by the cable company.

FOR SUBSCRIBERS TO BASIC CABLE TV SERVICE

For basic cable tv service not requiring a converter/descrambler box, connect the CATV 75 ohm coaxial cable to the VHF/UHF jack on the rear of the TV.

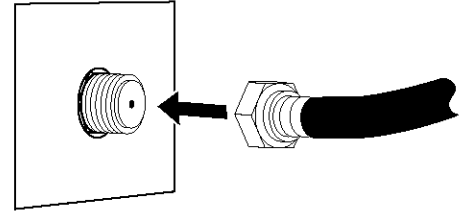

FOR SUBSCRIBERS TO SCRAMBLED CABLE TV SERVICE OR SATELLITE

If you subscribe to a satellite service or a cable TV service which requires the use of a converter/descrambler box, connect the incoming 75 ohm coaxial cable to the converter/descrambler or satellite box. Using another 75 ohm cable, connect the output of the converter/descrambler or satellite box to the antenna jack on the TV. Follow the connections shown below. Set the TV/VCR to the output channel of the converter/descrambler or satellite box (usually 3 or 4) and use the converter/descrambler or satellite box to select channels.

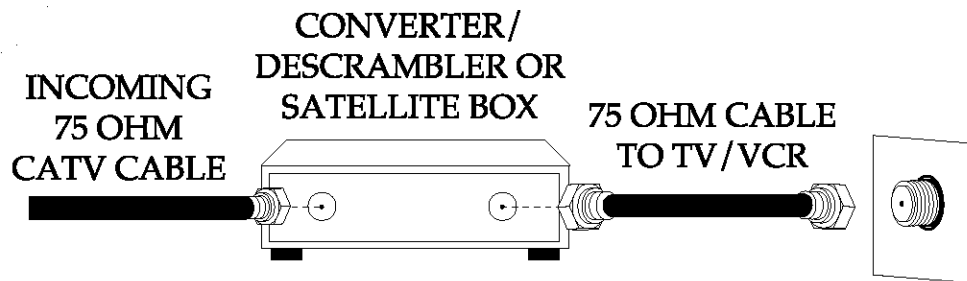

FOR SUBSCRIBERS TO UNSCRAMBLED BASIC CABLE TV SERVICE WITH SCRAMBLED PREMIUM CHANNELS

If you subscribe to a satellite service or a cable TV service in which basic channels are unscrambled and premium channels require the use of a converter/descrambler box, you may wish to use a signal splitter and an A/B switch box (available from the cable company or an electronic supply store). Follow the connections shown below. With the switch in the "B" position, you can directly tune any unscrambled channels on your TV. With the switch in the "A" position, tune your TV to the output of the converter/descrambler box (usually channel 3 or 4) and use the converter/descrambler box to tune scrambled channels.

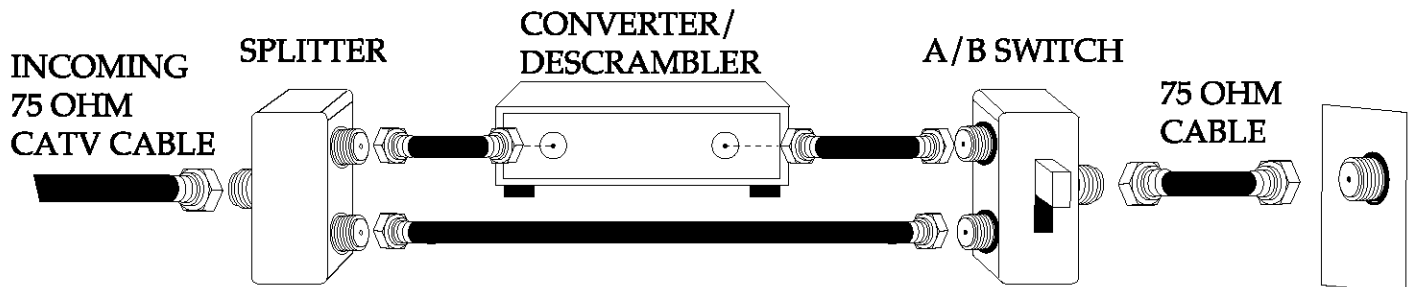

VCR CONNECTIONS

CONNECTION USING COAXIAL CABLE:

Follow the instructions below to connect a VCR to your television using a 75 ohm coaxial cable. (CABLES NOT INCLUDED.)

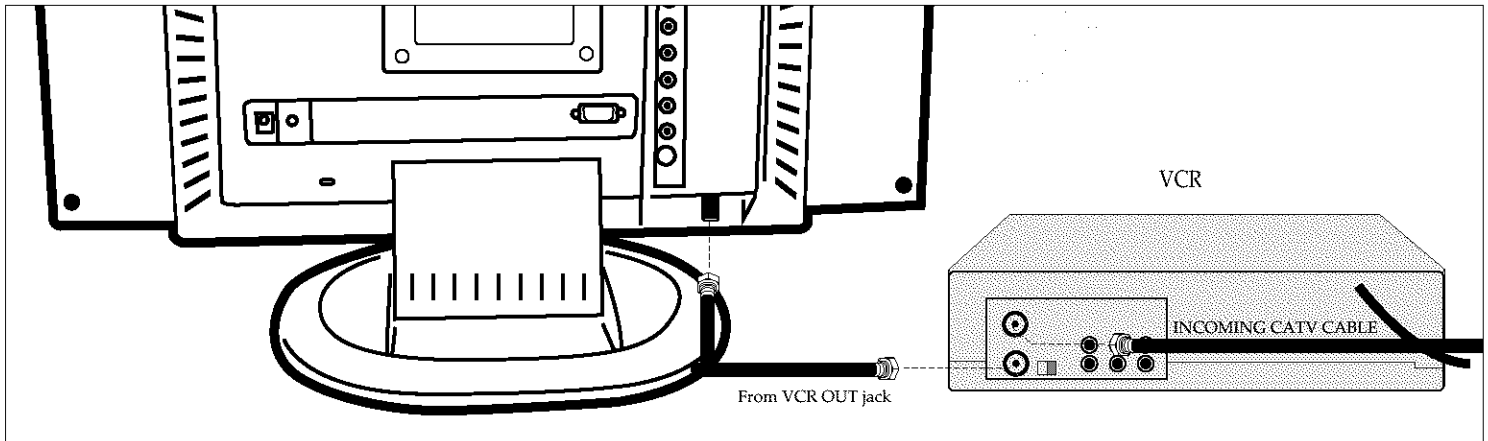

1. Connect the cable, satellite or incoming antenna to the VHF/UHF IN jack on the rear of the VCR.
2. Connect a 75 ohm coaxial cable from the VCR's 75 ohm OUT jack to the ANT jack on the rear of the TV.
3. Press the TV/AV/PC button until regular TV or CATV appears on the TV screen and press PLAY on the VCR to watch a tape.

CONNECTION USING AUDIO/VIDEO CABLES:

Follow the instructions below to connect a VCR to your television using Audio/Video cables. (CABLES NOT INCLUDED.)

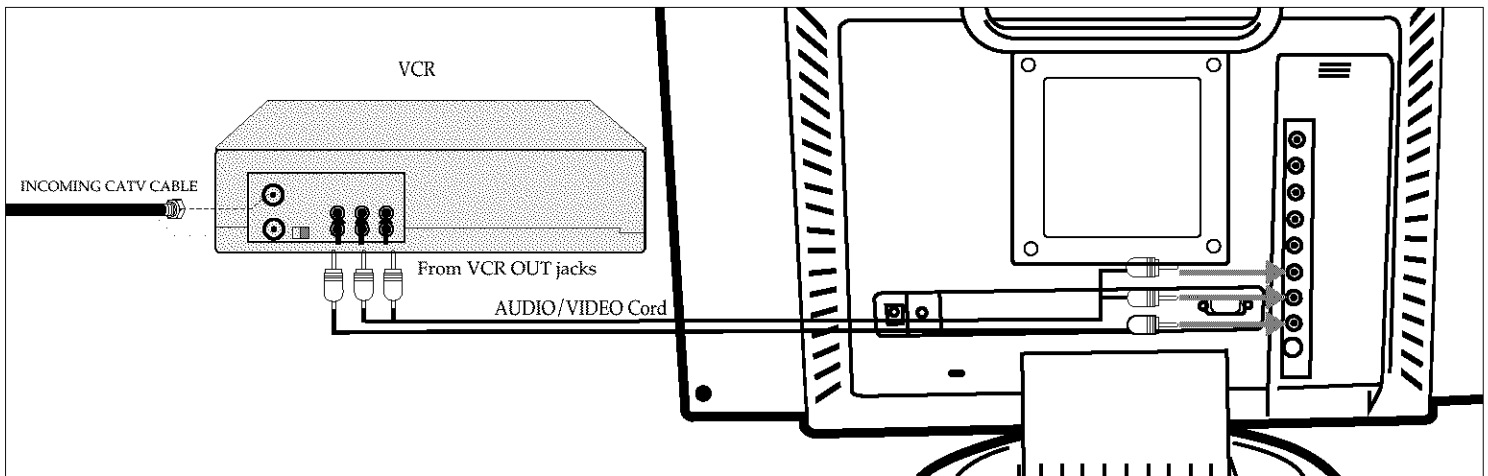

1. Connect the cable, satellite or incoming antenna to the VHF/UHF IN jack on the rear of the VCR.
2. Connect the left and right audio cable from the VCR's Audio OUT jacks to the TV's AUDIO left and right AV1 IN jacks. Connect the VCR's Video OUT jack to the TV's VIDEO AV1 IN jack.
3. Press the TV/AV/PC button until AV1/CVBS appears on the TV screen and press PLAY on the VCR to watch a tape.

FAQ:

My VCR has only 1 Audio jack, but this TV has two Audio input jacks, how do I connect it?
Simply connect it to the "L (Mono)" Audio input jack, but the sound will be monaural.

VCR CONNECTIONS (CONTINUED)

CONNECTION USING S-VIDEO CABLE:

Follow the instructions below to connect an S-VIDEO VCR to your television using an S-video cable. (CABLES NOT INCLUDED.)

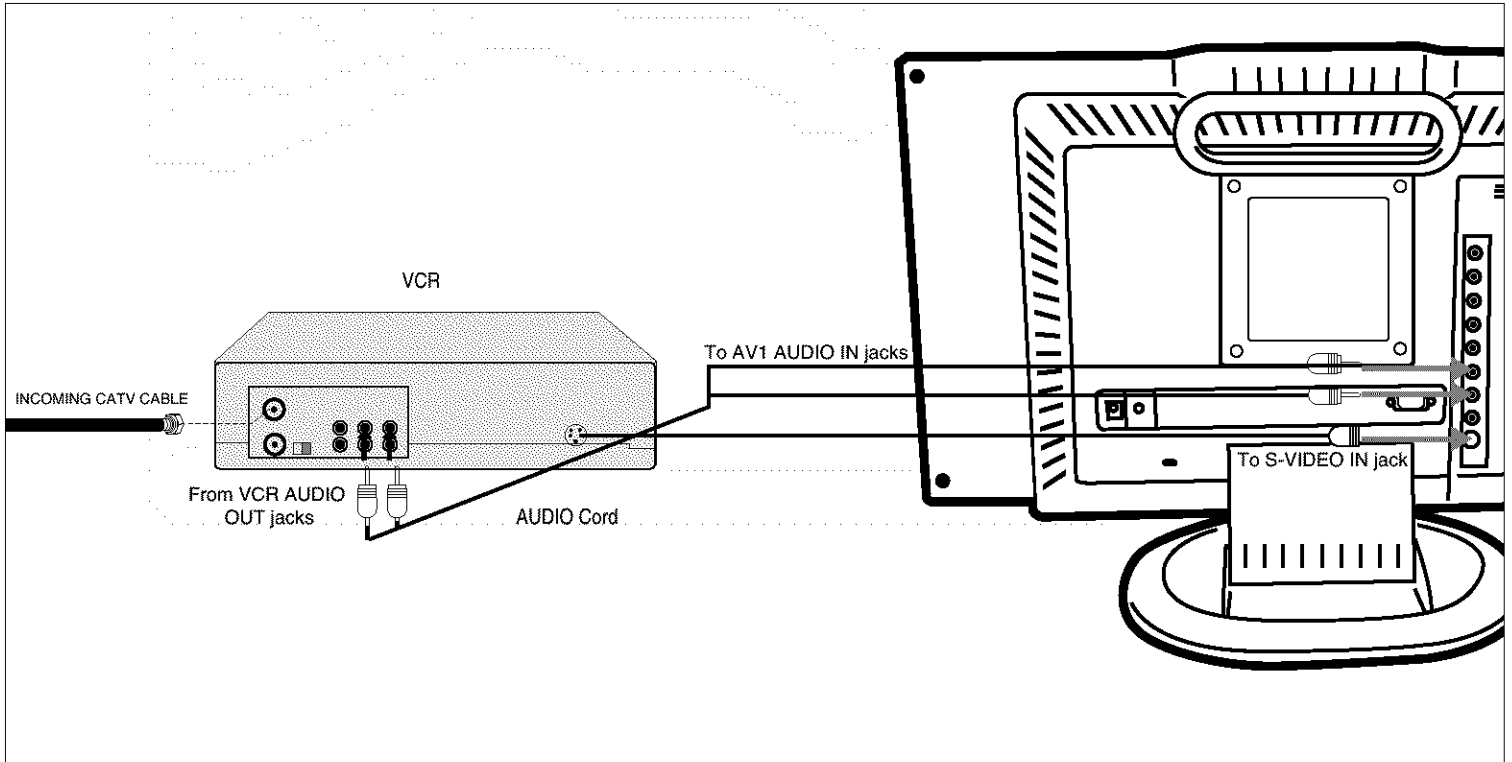

1. Connect the cable, satellite or incoming antenna to the ANT jack on the rear of the VCR.
2. Connect the left and right audio cable from the VCR's Audio OUT jacks to the TV's AUDIO left and right AV1 IN jacks.
3. Connect the VCR's S-VIDEO OUT jack to the TV's S-VIDEO AV1 IN jack.
4. Press the TV/AV/PC button until AV1/S-V appears on the TV screen and press PLAY on the VCR to watch a tape.

DVD CONNECTIONS

CONNECTION USING AUDIO/VIDEO CABLES:

Follow the instructions below to connect a DVD player to your television using Audio/Video cables. (CABLES NOT INCLUDED.)

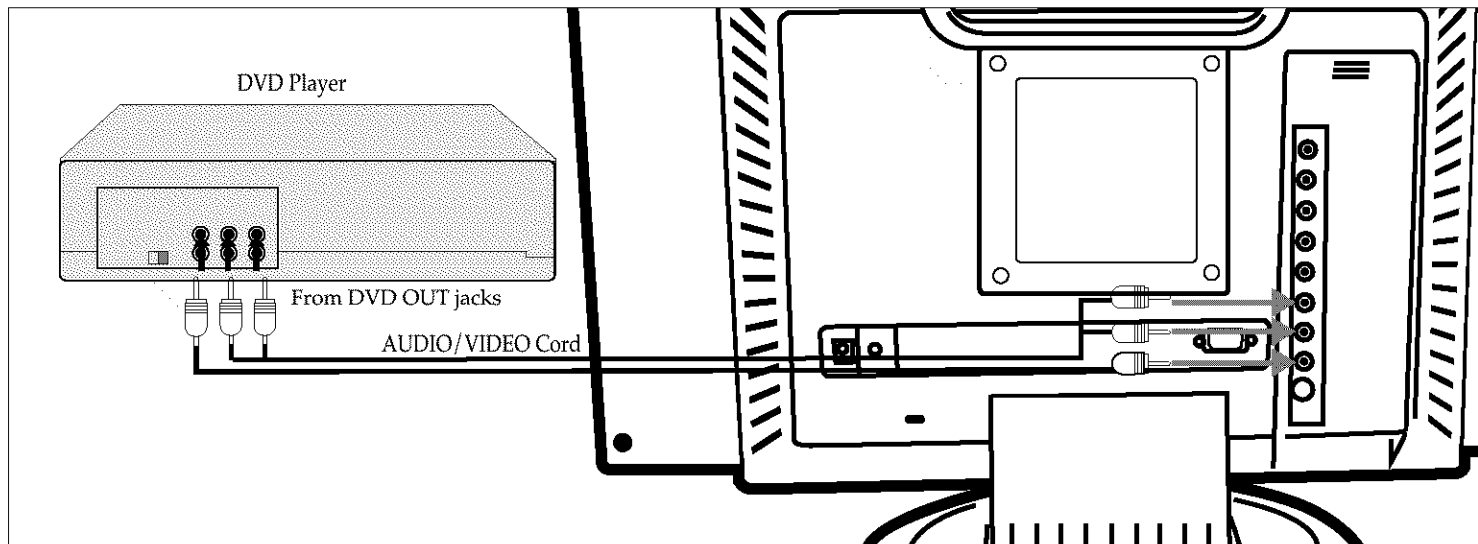

1. Connect the left and right audio cable from the DVD's Audio OUT jacks to the TV's AUDIO left and right AV1 IN jacks. Connect the DVD's Video OUT jack to the TV's VIDEO AV1 IN jack.
2. Press the TV/AV/PC button until AV1/CVBS appears on the TV screen and press PLAY on the DVD to watch a DVD.

CONNECTION USING S-VIDEO CABLE:

Follow the instructions below to connect a DVD player to your television using the S-Video cable. (CABLES NOT INCLUDED.)

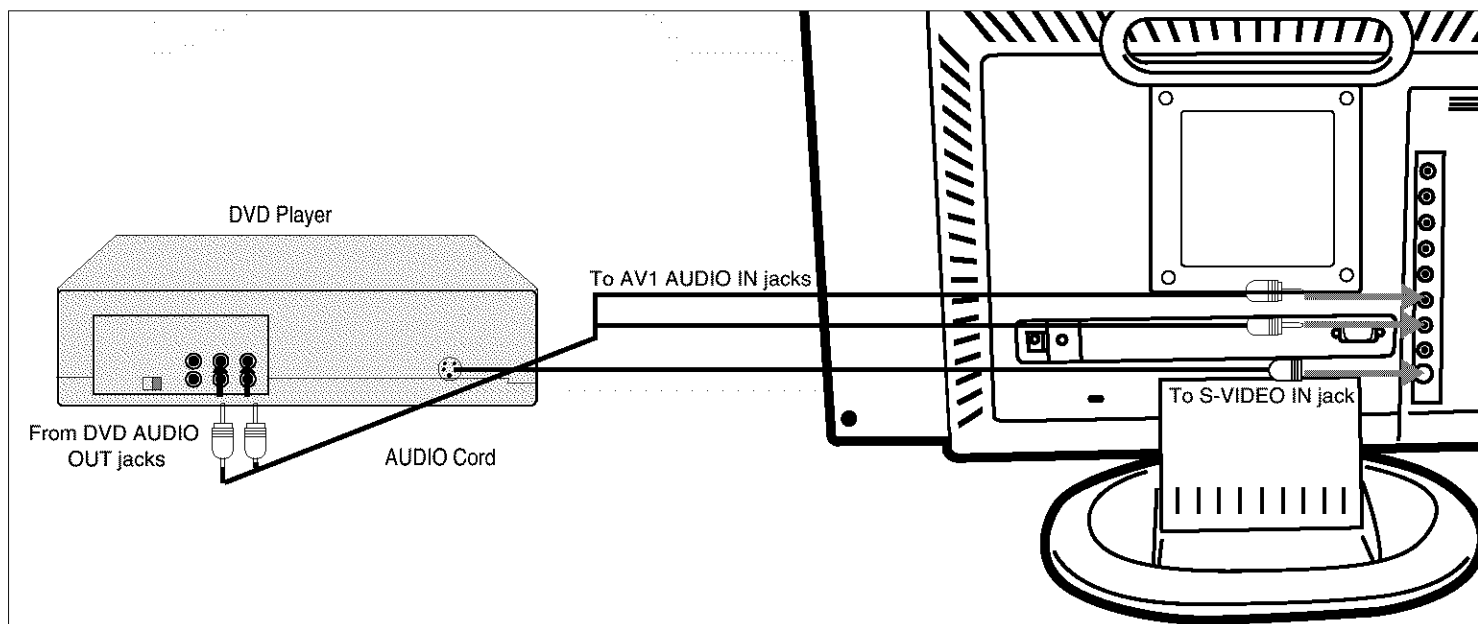

1. Connect the left and right audio cable from the DVD's Audio OUT jacks to the TV's AUDIO left and right AV1 IN jacks.
2. Connect the DVD's S-VIDEO OUT jack to the TV's S-VIDEO AV1 IN jack.
3. Press the TV/AV/PC button until AV1/S-V appears on the TV screen and press PLAY on the DVD to watch the DVD.

DVD CONNECTIONS (CONTINUED)

CONNECTION USING COMPONENT CABLES:

Follow the instructions below to connect a DVD player to your television using the Cr, Cb, Y jacks. (CABLES NOT INCLUDED.)

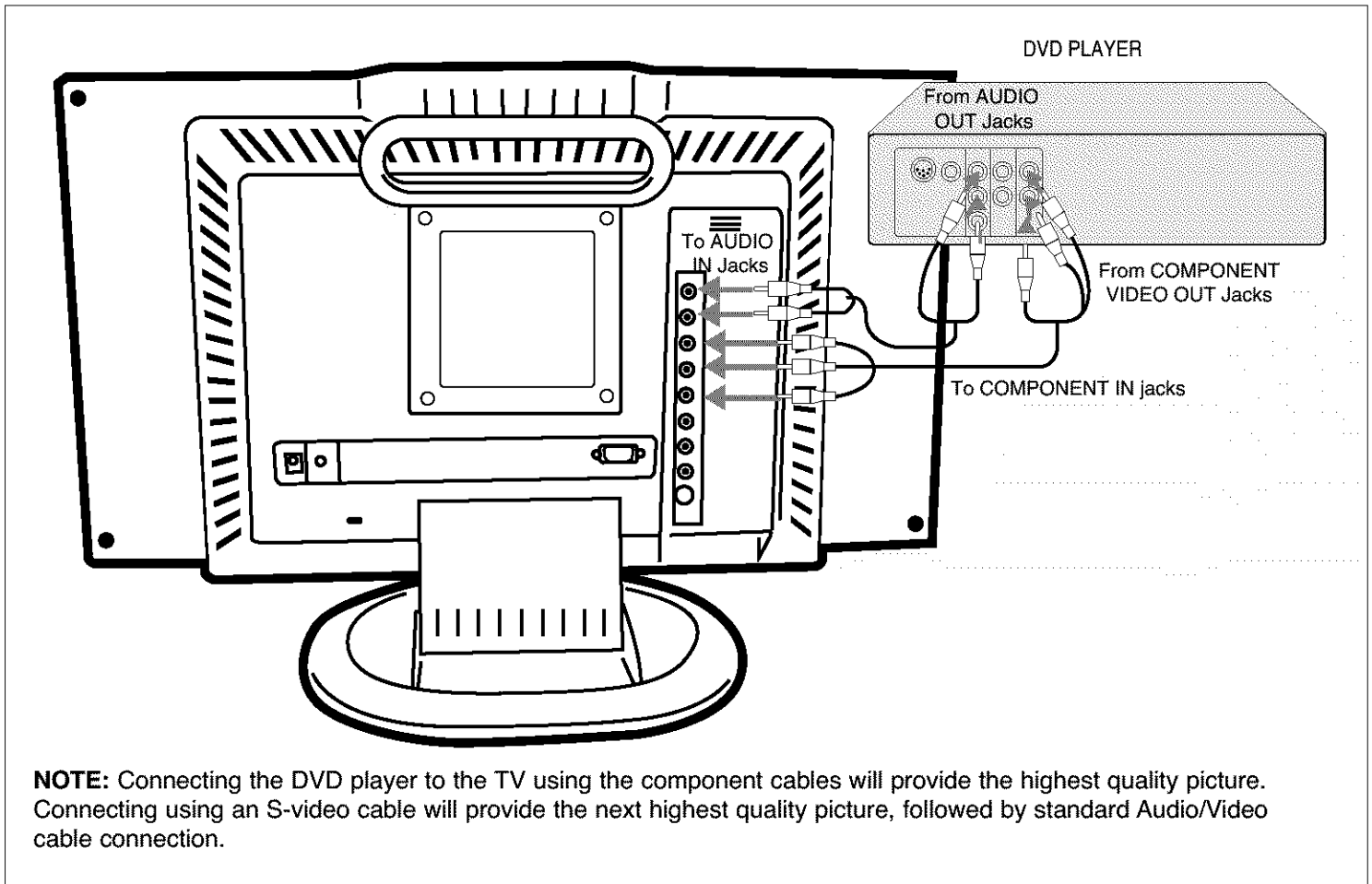

1. Connect the left and right audio cable from the DVD's Audio OUT jacks to the TV's AUDIO left and right AV2 IN jacks.
2. Connect a video cable from the DVD's Component Out jacks to the TV's AV2 IN (Cr, Cb, Y) jacks.
3. Press the TV/AV/PC button until AV2 appears on the TV screen and press PLAY on the DVD to watch a DVD.

COMPUTER CONNECTION

Follow the instructions below to connect a computer to your television/monitor. (CABLES NOT INCLUDED.)

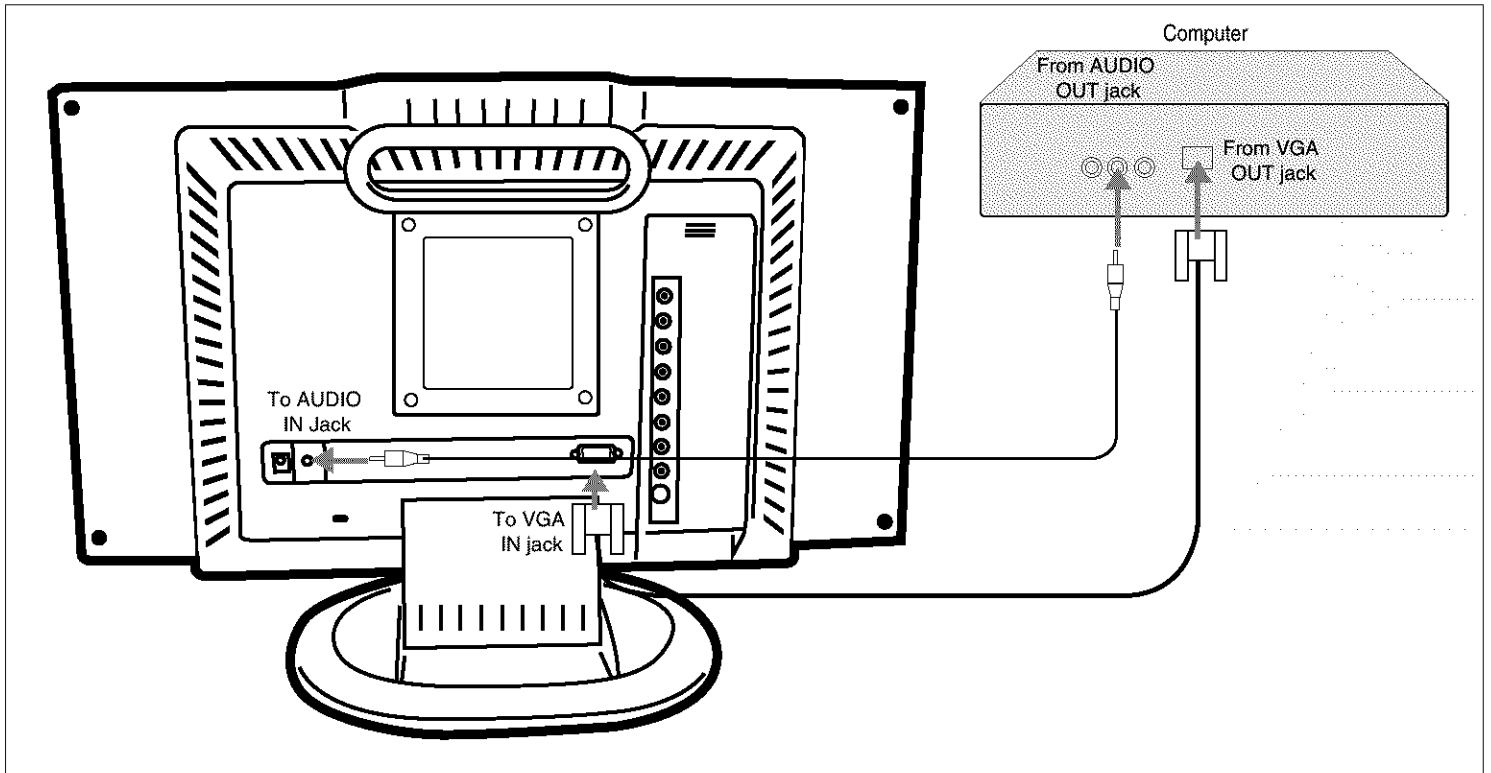

1. Connect the audio cable from the computer's Audio OUT jacks to the TV's VGA Audio IN jack.
2. Connect a VGA cable from the computer's VGA OUT jack to the TV's VGA IN jack.
3. Press the TV/AV/PC button until PC appears on the TV screen.
4. Refer to the computer's owner's manual for instructions.

KENSINGTON LOCK

The monitor can be secured to your desk or any other fixed object with Kensington lock security products. Kensington lock is not included.

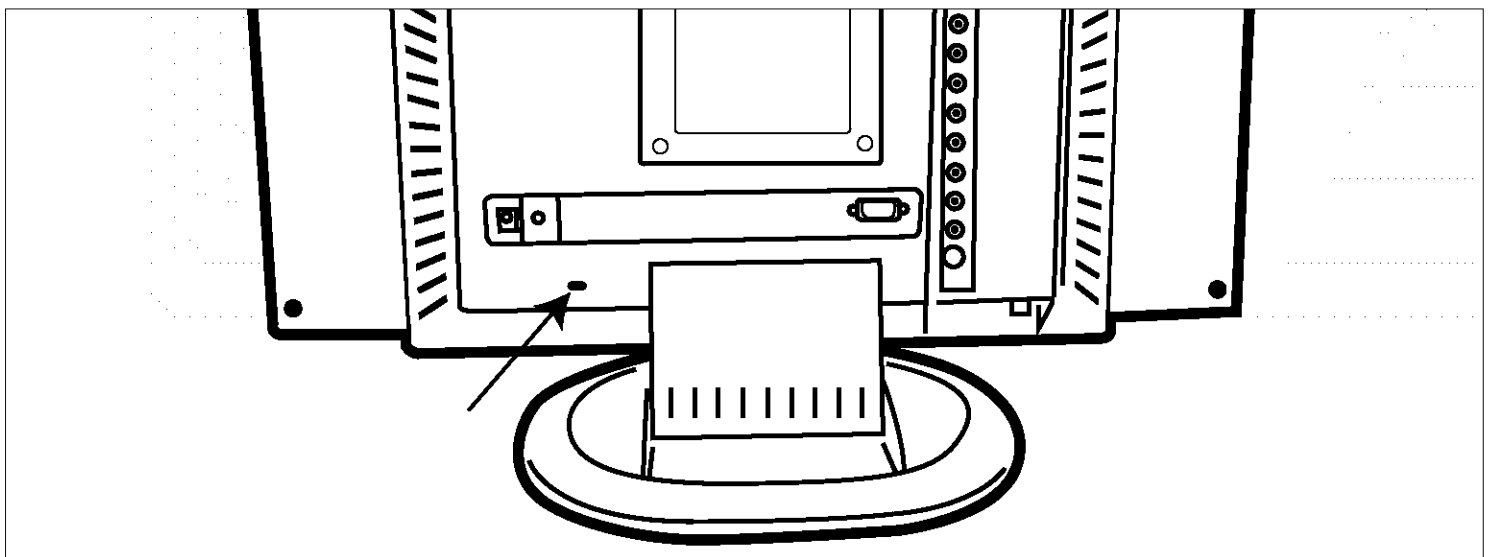

VIEWING ANGLE ADJUSTMENT

This unit is designed to allow you to have a comfortable viewing angle, which can be adjusted from -5° to $+25^{\circ}$.

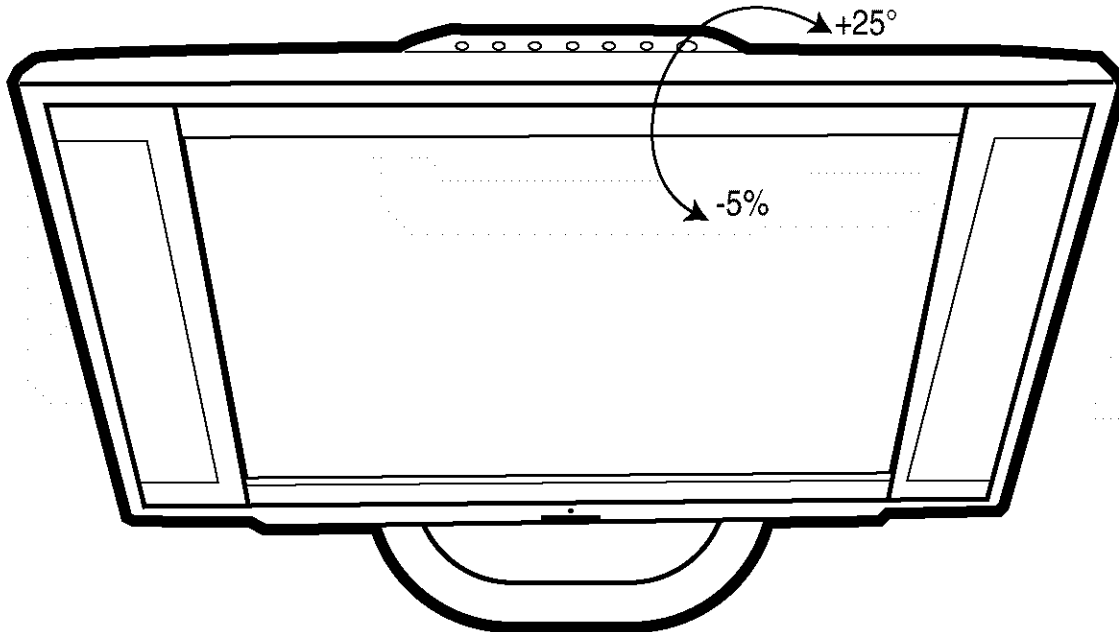

To adjust the base so it is at 90° , simply press the Release button on the bottom of the stand. This is useful for storing the monitor.

NOTE: Do not force the LCD monitor over its maximum viewing angle settings as stated above. Attempting this will result in damage to the monitor and stand.

WALL MOUNTING THE UNIT

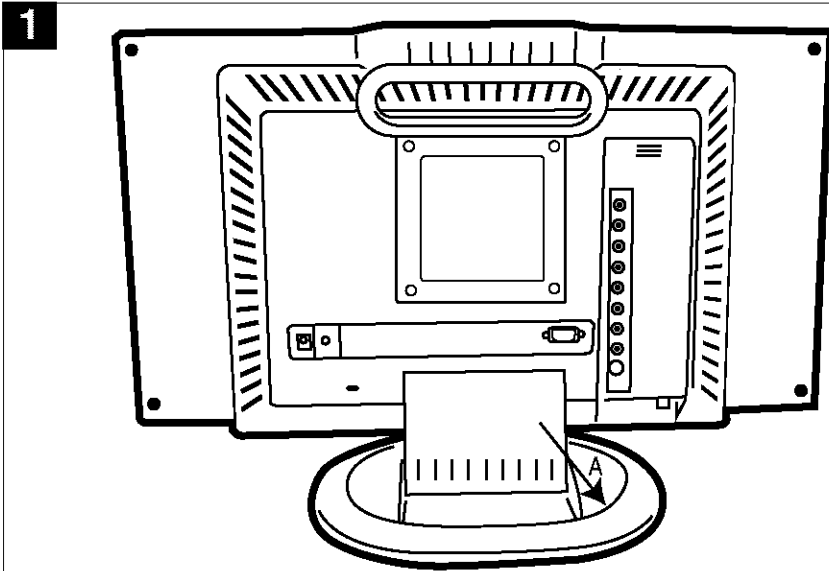

Detach the stand cover by pulling it outward as per arrow A.

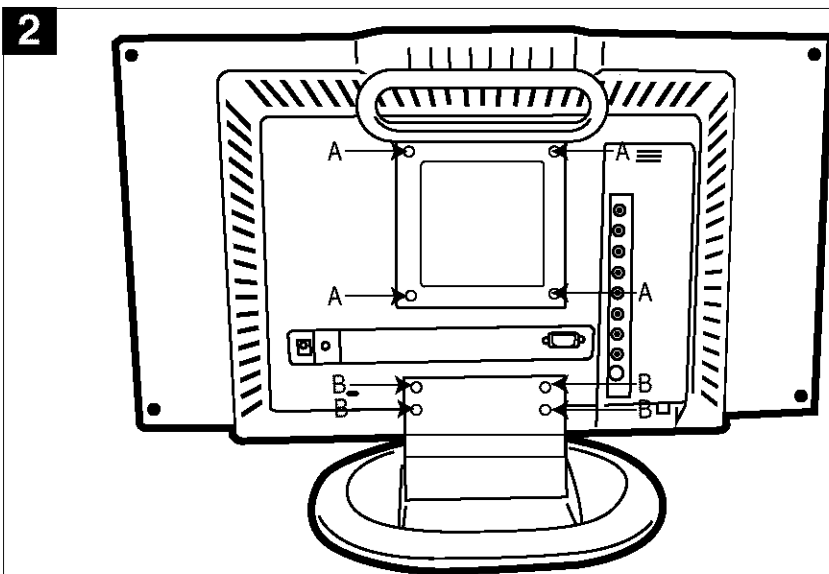

Remove the four (4) screws (A) using a phillips head screwdriver and remove the handle.

Remove the four (4) screws (B) using a phillips head screwdriver and remove the stand.

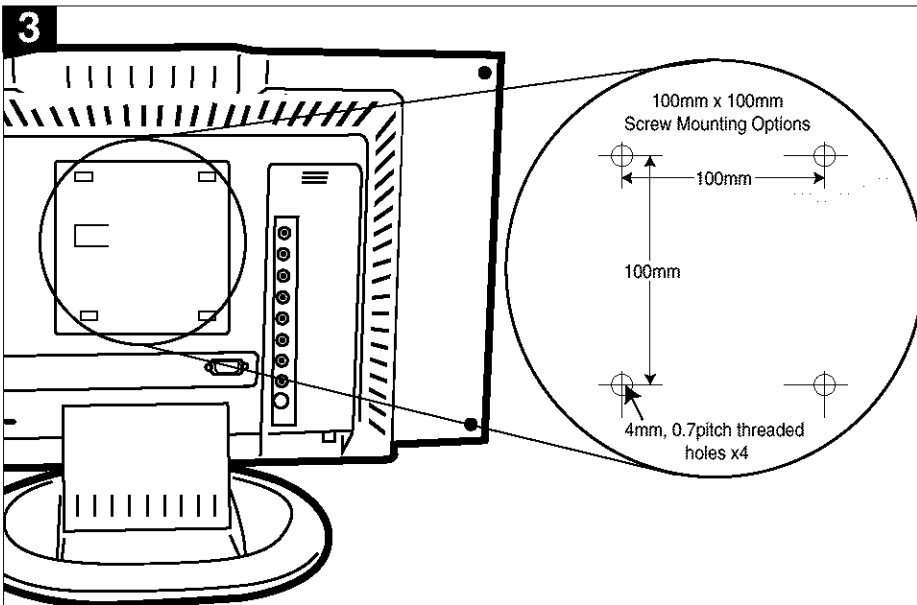

This monitor conforms to the VESA Flat Panel Mounting Physical Mounting Interface Standard which defines a physical mounting interface for flat panel monitors, and corresponding standards for flat panel monitor mounting devices, such as wall and table arms. The VESA mounting interface is located on the back of your monitor. The VESA Mounting slots of this model are located inside the handle cover (shown in the following figure).

To mount the monitor on a swing arm or other mounting fixture, follow the instruction included with the mounting fixture to be used.

TV MENUS

TV MODE

When the TV is set to the TV mode, the menu lets you customize the unit by allowing you to change various settings as follows:

1. Press the MENU button on the main unit or the ► button ❶ on the remote to access the on-screen menu.
2. Select one of the options at the top of the screen (AUDIO, VIDEO, SYSTEM, C.C. or V-CHIP) using the Navigation ⇐ ❷ or ⇒ ❸ button.
3. Use the Navigation ↑ ❹ or ↓ ❺ button to select one of the setup options, then press the Navigation ⇐ ❷ or ⇒ ❸ button to adjust it as per the following steps.

YOU MUST BE IN TV MODE TO ACCESS THESE MENUS. TO ENTER TV MODE, SIMPLY PRESS THE TV/AV/PC BUTTON UNTIL TV OR CATV APPEARS ON THE SCREEN.

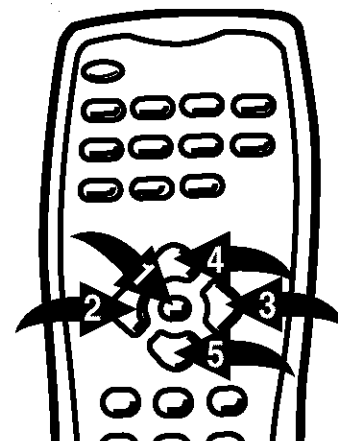

AUDIO MENU

1

AUDIO	VIDEO	SYSTEM	C. C.	V-CHIP
TREBLE	+ 1
BASS	+ 2
BALANCE	+ 1

If AUDIO option is selected, you can set the following:
TREBLE: Adjust for best treble (high) response.
BASS: Adjust for best bass (low) response.
BALANCE: Adjust for best balance between the left and right speakers. Usually setting this option in the middle is optimal.

VIDEO MENU

1

AUDIO	VIDEO	SYSTEM	C. C.	V-CHIP
BRIGHT	0
PICTURE	0
COLOR	0
HUE	0
SHARP	0

If VIDEO option is selected, you can set the following:
BRIGHT: Adjusts the brightness of the image.
PICTURE: Adjusts the contrast of the image.
COLOR: Adjusts the color intensity.
HUE: Adjusts the red-green color balance of the unit.
SHARP: Adjusts the sharpness of the image.

SYSTEM MENU

1

AUDIO	VIDEO	SYSTEM	C. C.	V-CHIP
MTS	STEREO	SAP	MONO	
MUTE	No	Yes		
LANGUAGE	ENGLISH	日本語	中文	
SLEEP	OFF	30	60	90
TV/CATV	TV	CATV		
CH. SEARCH	No	Yes		
CH. MEMORY	No	Yes		
RECALL	No	Yes		

If SYSTEM option is selected, you can set the following:
MTS: Adjust the MTS setting to select the desired audio option (STEREO, SAP or MONO). You can also select the desired audio option using the remote, see page 25.
MUTE: Select YES to mute the sound or NO for normal sound. You can also mute the TV using the remote, see page 25.
LANGUAGE: Select a language, which is used for the on-screen display (ENGLISH, JAPANESE or CHINESE).
SLEEP: Select a desired sleep time of 30, 60 or 90 minutes. The TV will then turn off after the selected amount of time.
TV/CATV: Select CATV if using cable television or TV if using an outdoor antenna.
CH. SEARCH: Select YES to start auto channel scan (see page 22).
CH. MEMORY: Select YES to add a channel into memory or NO to remove a channel from memory (see page 23).
RECALL: Select YES to recall the original video setting.

TV MENUS

CLOSED CAPTIONS MENU

WHAT IS CLOSED CAPTIONING?

This television has the capability to decode and display Closed Captioned television programs. Closed Captioning will display text on the screen for hearing impaired viewers or it will translate and display text in another language.

CLOSED CAPTIONING WITH A VCR

Closed Captioned programs can be recorded and played back on a VCR with the Closed Captioned text intact. The Closed Captioned text will disappear during Cue (Fast Forward Search), Review (Rewind Search) and Pause modes or if the VCR tracking is not adjusted properly.

TO VIEW CLOSED CAPTIONS

Enter the MENU and select CLOSED CAPTION. Scroll down and select the desired settings:

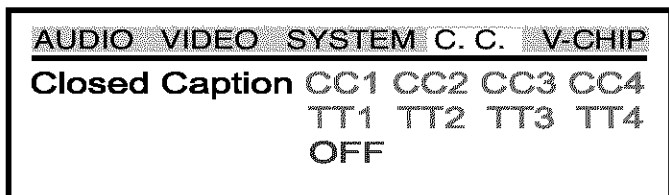

Select one of the four CC (Captions) or four TEXT (Full screen text) or OFF as follows:

CAPTIONS (CC1-4): This Closed Caption Mode will display text on the screen in English or another language. Generally, Closed Captions in English are transmitted on Captions 1 and Closed Captions in other languages are transmitted on Captions 2.

TEXT (TT1-4): The Text Closed Caption Mode will usually fill the screen with a programming schedule or other information.

OFF: Turns closed captions off.

After selecting a Closed Caption Mode, it will stay in effect until it is changed, even if the channel is changed. If the Captions signal is lost due to a commercial or a break in the signal, the Captions will reappear when the signal is received again. If the channels are changed, the Captions will be delayed approximately 10 seconds.

The Captions will appear in places on the screen where they will least interfere with the picture, usually on the bottom of the screen. News programs will usually show three-line Closed Captions which scroll onto the screen. Most other shows provide two or three lined Captions placed near the character who is speaking so the viewer can follow the dialogue.

Words in italics or underlined describe titles, words in foreign languages or words requiring emphasis. Words that are sung usually appear enclosed by musical notes.

For television programs broadcasting with Closed Captions, look in your TV guide for the Closed Captions symbol (CC).

NOTES:

- When selecting Closed Captions, the captioning will be delayed approximately 10 seconds.
- Misspellings or unusual characters may occasionally appear during Closed Captioning. This is normal with Closed Captioning, especially with live programs. This is because during live programs, captions are also entered live. These transmissions do not allow time for editing.
- When Captions are being displayed, on-screen displays, such as volume and mute may not be seen or may interfere with Closed Captions.
- Some cable systems and copy protection systems may interfere with the Closed Caption signal.
- If using an indoor antenna or if TV reception is very poor, the Closed Caption decoder may not appear or may appear with strange characters or misspelled words. In this case, adjust the antenna for better reception or use an outdoor antenna.

FAQs:

I entered the Captions mode, but no captions are appearing, why?

If no caption signal is received, no captions will appear, but the television will remain in the Caption mode.

Why is there a big black box on the screen?

Because you are in a Captions mode. Turn the captions off, or select a different Captions mode.

TV MENUS

SETTING THE V-CHIP

V-Chip enables parents to prevent their children from watching inappropriate material on TV. V-Chip reads the ratings for programming (except for news, sports, unedited movies on premium cable and Emergency System signals), then denies access to programming if the program's rating meets the limitations you select. In this case, the program will be blocked.

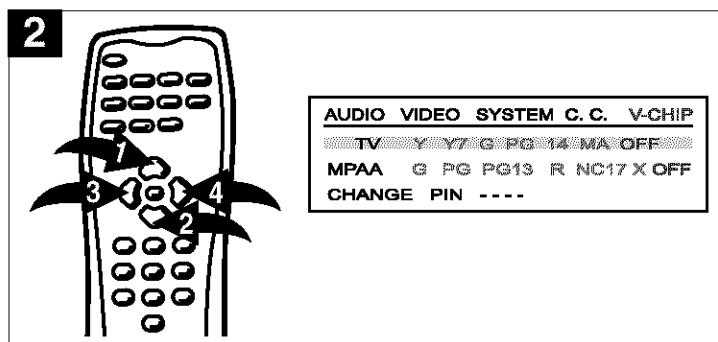
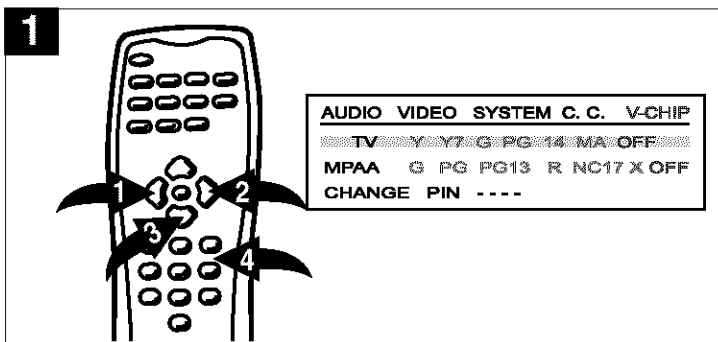

Enter the TV menu, then select V-CHIP using the Navigation \leftarrow 1 or \rightarrow 2 button. Press the Navigation \downarrow button 3, then enter the pin number using the Direct Channel Selection buttons 4. When first using the unit, the pin number is set to "1234".

Press the Navigation \uparrow 1 or \downarrow 2 button to select the TV rating, then press the the Navigation \leftarrow 3 or \rightarrow 4 button to set the TV rating.

Y: Young	14: Parental Guidance, less than 14 years old.
Y7: 7 and older	MA: Mature Audiences
G: All ages	OFF: No option set
PG: Parental Guidance.	

All programs with a higher rating than the one selected will also be blocked.

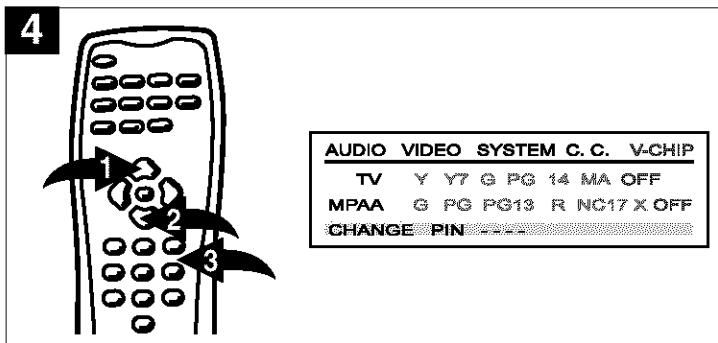
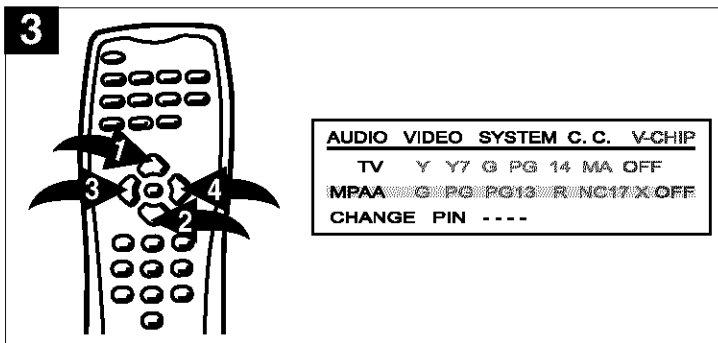

Press the Navigation \uparrow 1 or \downarrow 2 button to select the MPAA rating, then press the the Navigation \leftarrow 3 or \rightarrow 4 button to set the MPAA rating.

G: All ages	NC17: 17 years old and above
PG: Parental Guidance	X: Adult only
PG-13: Parental Guidance, less than 13 years old	OFF: No option set
R: Under 17 years old, Parental Guidance suggested	

All programs with a higher rating than the one selected will also be blocked.

Press the Navigation \uparrow 1 or \downarrow 2 button to select CHANGE PIN, then enter the desired pin number using the Direct Channel Selection buttons 4; then confirm again using the Direct Channel Selection buttons 4.

AV MENUS

AV MODE

When the TV is set to the AV1 or AV2 mode, the menu lets you customize the unit by allowing you to change various settings as follows:

1. Press the MENU button on the main unit or the ► button ❶ on the remote to access the on-screen menu.
2. Select one of the options at the top of the screen (AUDIO, VIDEO, SYSTEM) using the Navigation ◀ ❷ or ▶ ❸ button.
3. Use the Navigation ↑ ❹ or ↓ ❺ button to select one of the setup options, then press the Navigation ◀ ❷ or ▶ ❸ button to adjust it as per the following steps.

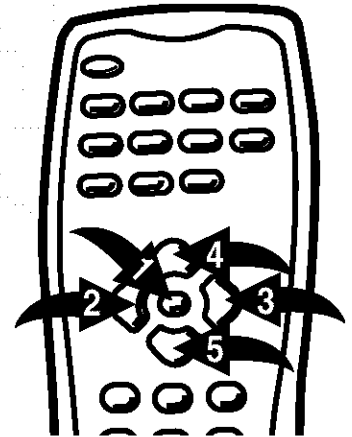

AUDIO MENU

1

AUDIO VIDEO SYSTEM		
TREBLE	+ 1
BASS	+ 2
BALANCE	+ 1

If AUDIO option is selected, you can set the following:
TREBLE: Adjust for best treble (high) response.
BASS: Adjust for best bass (low) response.
BALANCE: Adjust for best balance between the left and right speakers. Usually setting this option in the middle is the most optimal.

VIDEO MENU

1

AUDIO VIDEO SYSTEM		
BRIGHT	0
PICTURE	0
COLOR	0
SHARP	0

If VIDEO option is selected, you can set the following:
BRIGHT: Adjusts the brightness of the image.
PICTURE: Adjusts the contrast of the image.
COLOR: Adjusts the color intensity.
SHARP: Adjusts the sharpness of the image.

SYSTEM MENU

1

AUDIO VIDEO SYSTEM		
MUTE	No Yes	
LANGUAGE	ENGLISH	日本語 中文
RECALL	No Yes	

If SYSTEM option is selected, you can set the following:
MUTE: Select YES to mute the sound or NO for normal sound. You can also mute the TV using the remote, see page 25.
LANGUAGE: Select a language, which is used for the on-screen display (ENGLISH, JAPANESE or CHINESE).
RECALL: Select YES to recall the original video setting.

PC MENUS

PC MODE

When the TV is set to the PC mode, the menu lets you customize the unit by allowing you to change various settings as follows:

1. Press the MENU button on the main unit or the ► button ❶ on the remote to access the on-screen menu.
2. Use the Navigation ↑ ❷ or ↓ ❸ button to select one of the setup options, then press the Navigation ← ❹ or → ❺ button to adjust it as per the following:

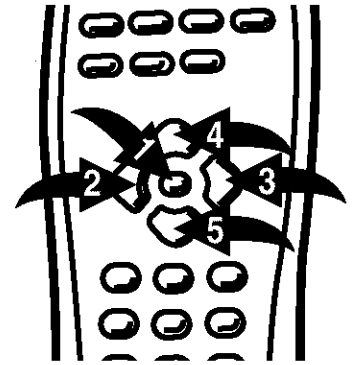

Icon	Function	Description
	Brightness	Adjusts the brightness of the image.
	Contrast	Adjusts the contrast of the image.
	H-position	This function will shift the entire image left or right.
	V-position	This function will shift the entire image up or down.
	Auto	This function will adjust the display size automatically to fit the screen.
	Phase	This function will adjust the focus and clarity of the display.
	Clock	This function carries a frequency-tracking feature that allows the user to adjust for best stability and clarity. The clock value can be increased up to +50 scales. It can be decreased depending on the value of the input timing.
	PIP	Picture in picture will allow you to display a sub-picture on the display. Selecting this option will allow you to set the following: SOURCE: Select the video source (TV, AV1 or AV2) or turn PIP off. AUDIO: Select the sound output (PC or SUB {video}). MUTE: Select YES to mute the sound from the video window or NO for normal sound. SCALE: Select one of the four picture scales/sizes. H-POS: Moves the PIP window left or right. V-POS: Moves the PIP window up or down.
	OSD H-POS	This function moves the OSD menu window left or right.
	OSD V-POS	This function moves the OSD menu window up or down.
	Graph test	Select a display that allows maximum graphics text quality. The resolution can be 640 x 400 or 720 x 400. Refer to page 27, Standard Timing Table for different timing modes.
	Recall	Select to return all adjusted parameters to factory preset levels.
	Language	Select a language, which is used for the on-screen display (ENGLISH, JAPANESE or CHINESE).
	Color Temp	Select the desired color temperature (9300°K or 6500°K) and also adjust the red (R), green (G) and/or blue (B) colors on the screen.
	Save Exit	Saves the changed settings and exits the OSC screen.

SETTING THE CHANNELS INTO MEMORY

This TV is equipped with a channel memory feature which allows channels to skip up or down to the next channels set into memory, skipping over unwanted channels. Before selecting channels, they must be programmed into the TV's memory. In addition to normal VHF/UHF channels, this TV can receive up to 113 Cable TV channels.

TV/CATV menu option must be selected.

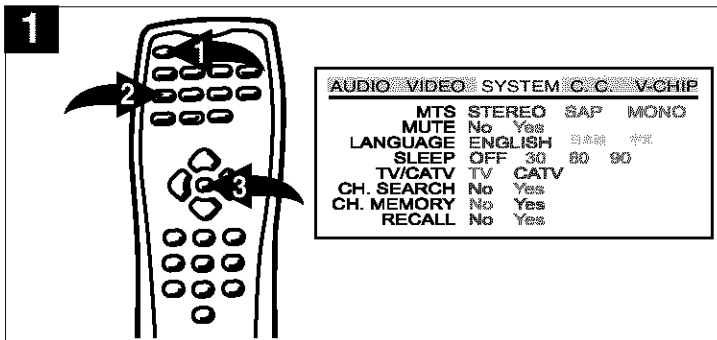

Press the POWER button ❶ to turn on the TV; the POWER indicator will light green. Press the TV/AV/PC button ❷ until TV or CATV appears. Select the TV or CATV option as described on page 17. Press the ► button ❸; the MENU screen will appear

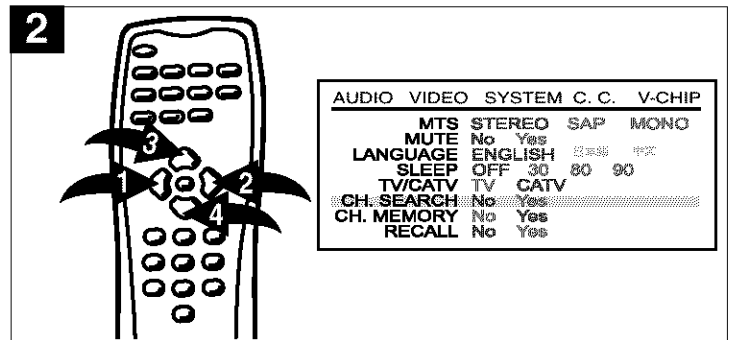

Select the SYSTEM menu using the Navigation ⇐ ❶ or ⇒ ❷ button. Use the Navigation ↑ ❸ or ↓ ❹ button to select CH. SEARCH.

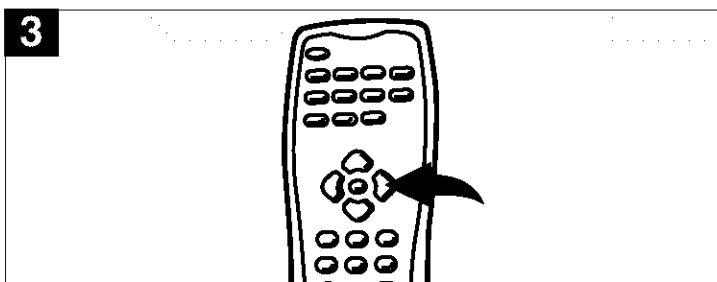

When CH. SEARCH is selected, press the Navigation ⇒ button to start the Auto Search. The TV will automatically cycle through all the channels and store active channels into memory. When completed, the TV will be on the first available channel.

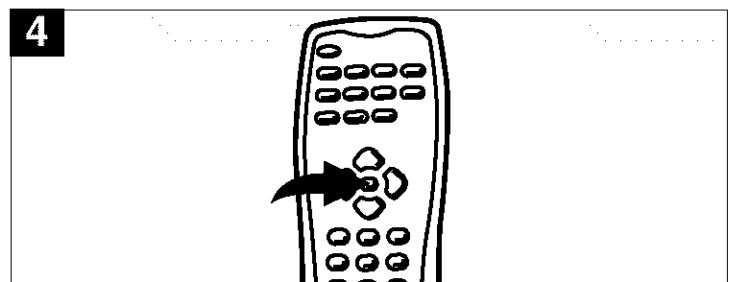

Press the ► button to stop Auto Memory while it is searching (if desired).

FAQs:

How many channels will I actually receive?

The actual number of channels that can be received depends on how many channels your cable or satellite company, or local area provides. Contact your company to determine the number of channels in your area.

Do channels need to be set into memory before using the CHANNEL Up or Down button?

Yes, the channels must be programmed into memory.

ADDING AND SKIPPING CHANNELS

After setting channels into memory, you can add or delete channels as follows:

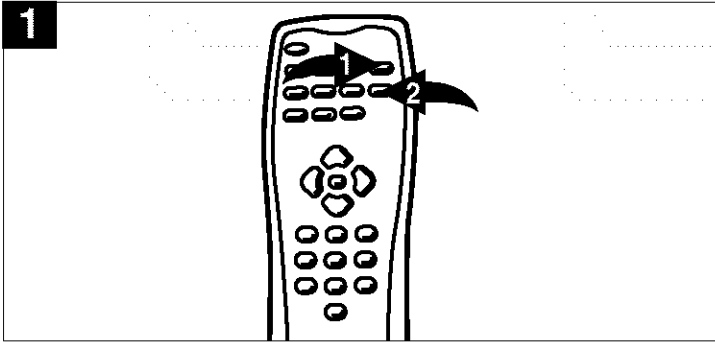

Press the POWER button ❶ to turn on the TV; the POWER indicator will light green. Press the TV/AV/PC button ❷ until TV or CATV appears. Select the TV or CATV option as described on page 17. Press the ► button ❸; the MENU screen will appear.

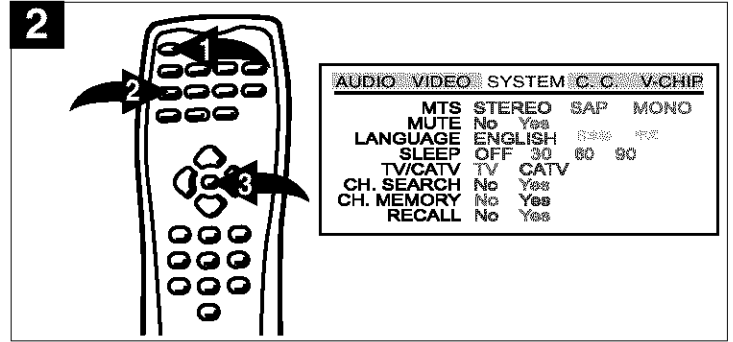

Select a channel to be skipped or added using the CHANNEL Up ❶ or Down ❷ button.

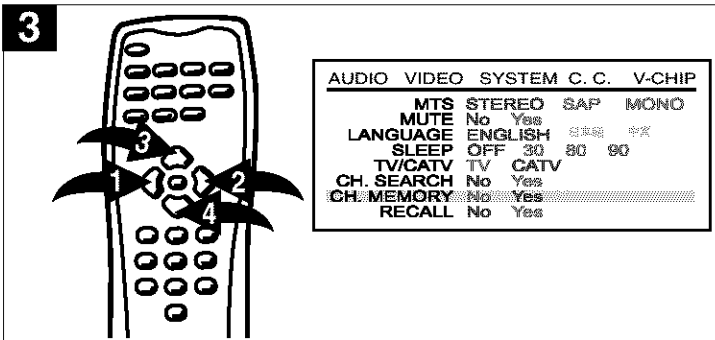

Select the SYSTEM menu using the Navigation ◀ ❶ or ▶ ❷ button. Use the Navigation ↑ ❸ or ↓ ❹ button to select CH. MEMORY.

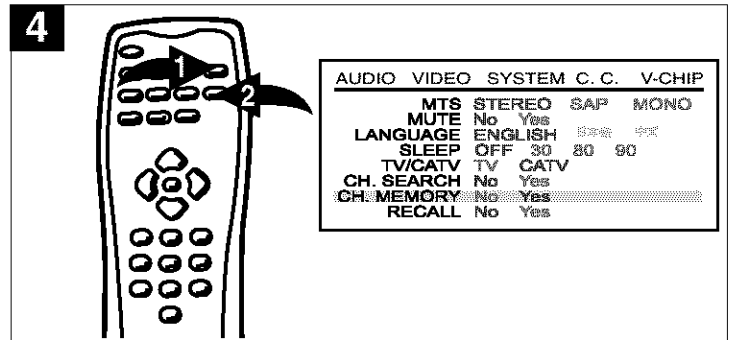

Using the Navigation ◀ ❶ or ▶ ❷ button, select NO to skip the channel or YES to keep the channel.

TV OPERATION

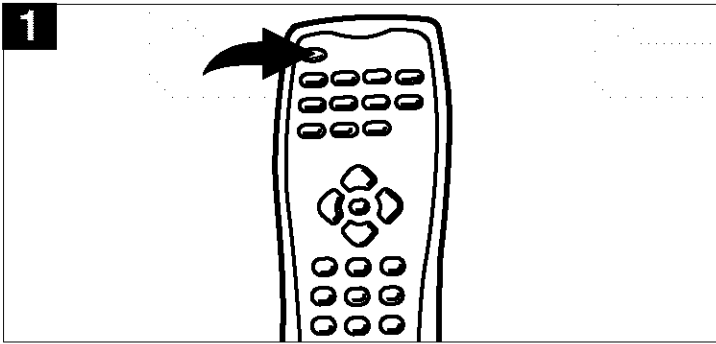

Press the POWER button to turn on the TV; the POWER indicator will light green.

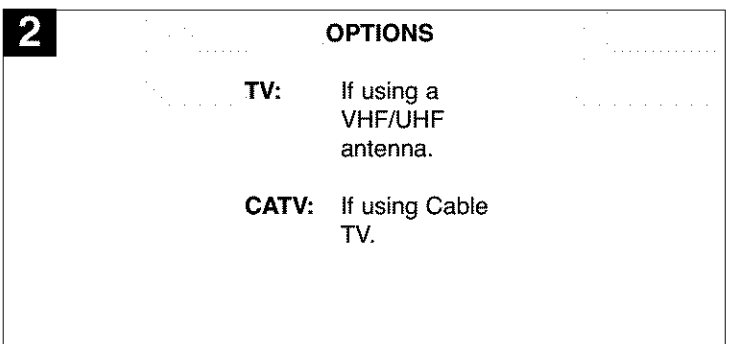

OPTIONS

TV: If using a VHF/UHF antenna.

CATV: If using Cable TV.

Select the TV or CATV option as described on page 17.

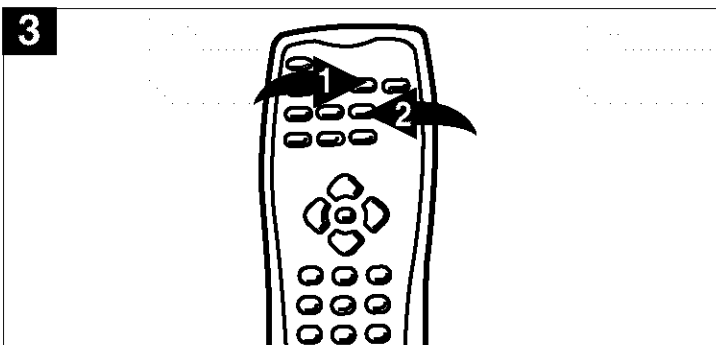

Adjust the volume level by pressing the VOLUME Up **1** or Down **2** button. The volume level will be indicated on the screen by green bands and a green numerical display between 0 and 24 where 0 is the lowest setting and 24 is the loudest.

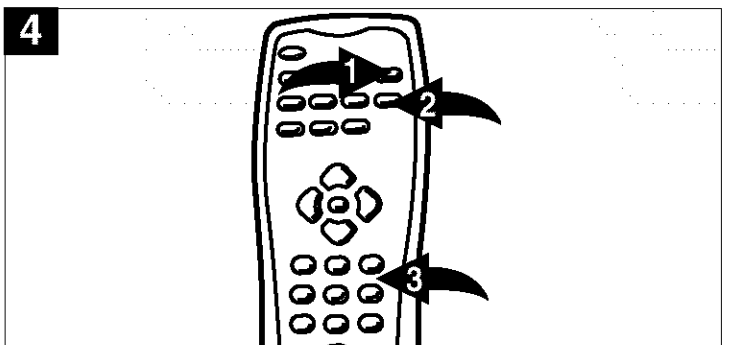

For proper operation, before selecting channels, they must be set into the TV's program memory, see page 22. Press and release the CHANNEL Up **1** or Down **2** button. The TV automatically stops at the next channel set into memory. This will not operate if channels are not set into memory.

Direct Program Selection buttons (0 - 9)

Use these buttons to select a channel. The channel number will appear at the top right corner of the screen.

- Select a channel using the Direct Channel Selection buttons **3** and the channel will change in approximately two seconds.

NOTES:

- When TV/CATV option is set to TV, only channels up to 69 can be selected. When set to CATV, channels up to 125 can be selected.
- If an invalid channel is selected, the display will revert to the original channel.

FAQs:

Why do I only receive 69 channels, when my cable goes much higher?
TV/CATV option must be set to CATV when using cable, see page 17.

Why are some channels scrambled?
You must subscribe to these channels through your cable company.

TV OPERATION (CONTINUED)

MUTE

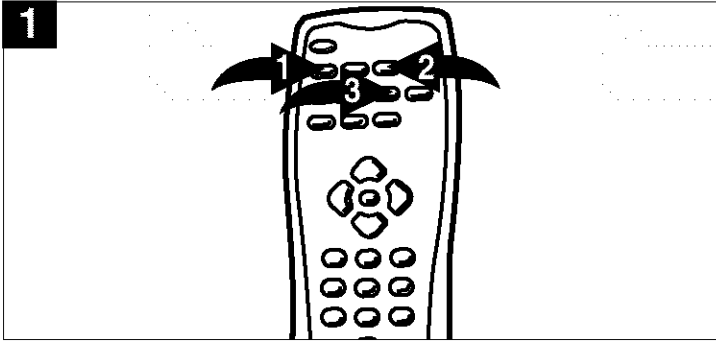

Press the MUTE button ❶ to turn off the sound. The TV's sound will be silenced and "MUTE" will appear on the screen. The sound can be turned back on by pressing this button again or the VOLUME Up ❷ or Down ❸ button.

LAST CHANNEL

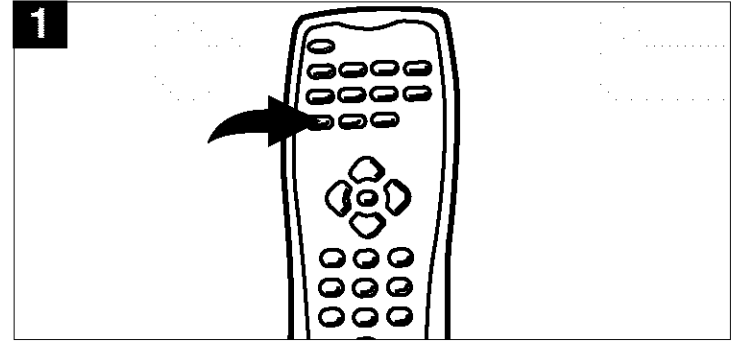

Press the LAST CH button to go back to the last channel selected. Press the LAST CH button again to return to the channel you were watching.

TV/AV/PC

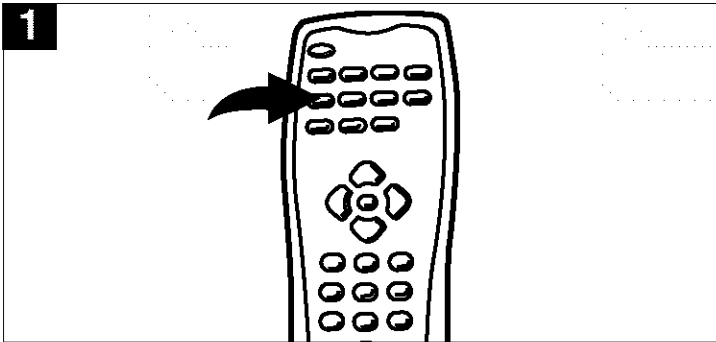

Repeatedly press this button to cycle through the device(s) connected to the INPUT jacks.

MTS

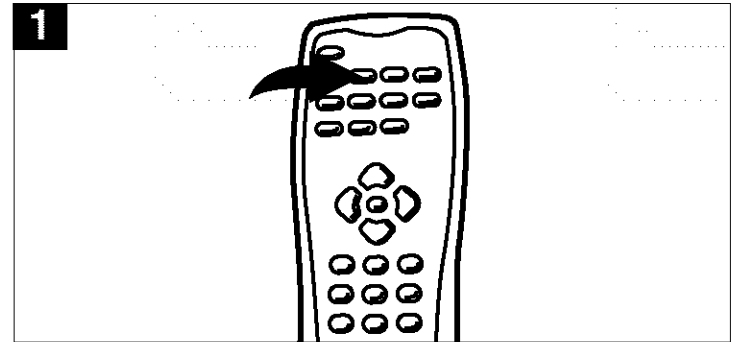

Press to select one of the following sound modes:
STEREO: Select for channels that are broadcasting in stereo.
MONO: Select for channels broadcasting in mono or if you are having difficulty receiving a stereo signal.
SAP (Separate Audio Program): Select to listen to a Separate Audio Program which is usually a foreign language translation.

TV OPERATION (CONTINUED)

DISPLAY

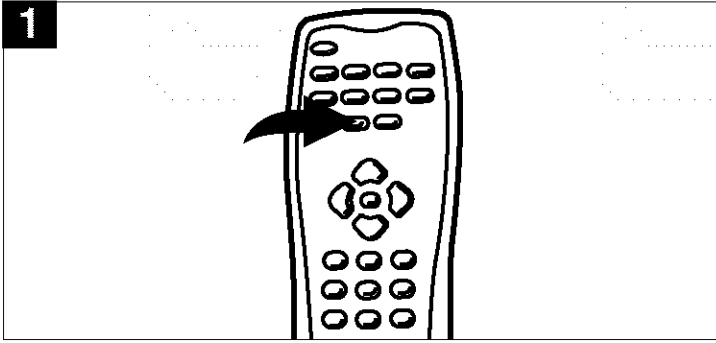

Press the DISPLAY button once to show the mode (i.e. S-VIDEO) and audio mode. Press again to clear the display.

SLEEP TIMER

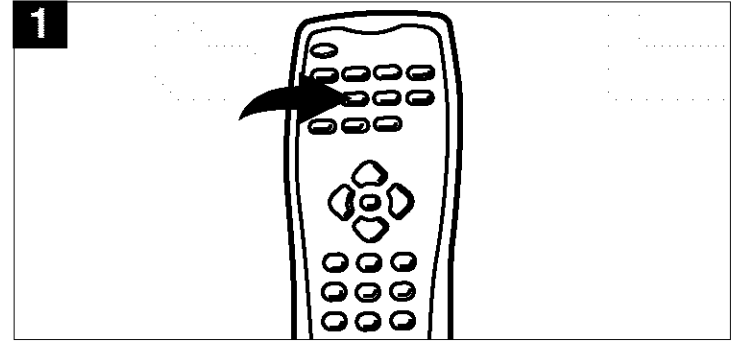

Press repeatedly to set the sleep time between "10" and "90" (each press will increase the time by 10 minutes). When the sleep time is up, the TV will shut off.

4:3/16:9

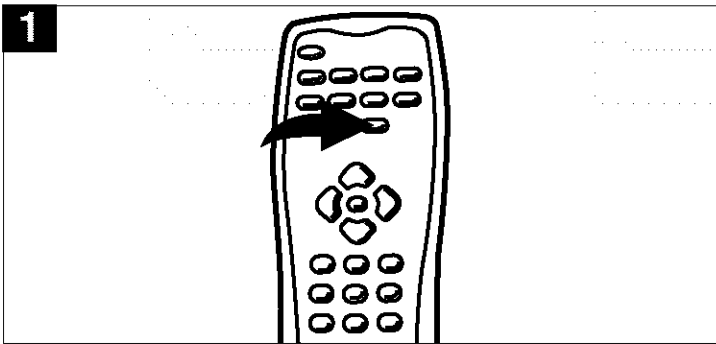

Press to select the screen scale (4:3 standard screen or 16:9 wide-screen).

STANDARD TIMING TABLE

Mode	Resolution	Total	Nominal Frequency (KHz)	Sync Polarity	Nominal Freq. (Hz)	Sync Polarity	Nominal Pixel Clock (MHz)
			Horizontal		Vertical		
VESA MODES							
VGA	640x480@60Hz	800 x 525	31.469	N	59.940	N	25.175
	640x480@72Hz	832 x 520	37.861	N	72.809	N	31.500
	640x480@75Hz	840 x 500	37.500	N	75.00	N	31.500
SVGA	800x600@56Hz	1024 x 625	35.156	N/P	56.250	N/P	36.000
	800x600@60Hz	1056 x 628	37.879	P	60.317	P	40.000
	800x600@72Hz	1040 x 666	48.077	P	72.188	P	50.000
	800x600@75Hz	1056x625	46.875	P	75.000	P	49.500
XGA	1024x768@60Hz	1344x806	48.363	N	60.004	N	65.000
	1024x768@70Hz	1328x806	56.476	N	70.069	N	75.000
	1024x768@75Hz	1312x800	60.023	P	75.029	P	78.750
IBM MODES							
DOS*	720x400@70Hz	900 x 449	31.469	N	70.087	P	28.322
DOS	640x350@70Hz	800 x 449	31.469	P	70.087	N	25.175

TROUBLESHOOTING GUIDE

Check the following before requesting service:

SYMPTOM	POSSIBLE CAUSE	POSSIBLE SOLUTION
POWER		
No power.	The AC power cord is not connected.	Connect the AC power cord to the AC outlet.
TV BROADCAST RECEPTION		
Poor or no picture.	TV station experiencing problems.	Try another channel.
	Picture control is not adjusted.	Check picture control settings.
	Possible local interference.	Check for source of reception disturbance.
	Antenna/CATV connector is not connected.	Check CATV connection or VHF/UHF antenna.
Picture wobbles or drifts.	TV station experiencing problems.	Try another channel.
	Cable TV channel is scrambled.	A Cable box needs to be used (if desired).
	Possible local interference.	Check for source of reception disturbance.
No CATV reception.	CATV connected improperly or not connected.	Check all CATV connections.
	TV/CATV option set to TV.	Set TV/CATV option to CABLE.
	Cable TV service interrupted.	Contact your Cable TV company.
No reception above ch13.	ATV/CATV option set to AIR.	Set TV/CATV option to CABLE.
Poor or no sound.	TV station experiencing problems.	Try another channel.
	MUTE button is pressed.	Press MUTE button again.
	Possible local interference.	Check for source of reception disturbance.
	Antenna/CATV connector is not connected.	Check CATV connection or VHF/UHF antenna.
	Volume is set to minimum.	Increase volume.
TV shuts off.	TV station stopped broadcasting.	Tune to a new channel.
	Sleep Timer is set.	Set Sleep Timer to Off.
Closed Captioning not working.	TV signal is weak.	Check CATV or VHF/UHF antenna connection.
	TV station experiencing problems or program tuned is not closed captioned.	Try another channel.
	Closed Captioning not turned on.	Turn Closed Captioning on.
REMOTE CONTROL		
Remote control does not operate.	Distance is too far or too much light in the room.	Operate within 15 feet or reduce the light in the room.
	There is an obstacle in the path of the beam or remote is not aimed at the sensor.	Clear the path of the beam and/or aim the remote at the sensor.
	The batteries are weak or installed incorrectly.	Replace the batteries or install correctly.
PARENTAL CONTROL (V-CHIP)		
Parental control protection is not working properly.	V-Chip setting is turned off.	Turn V-Chip setting on.
	News or sports event being broadcast.	Parental Control does not work with news or sporting events.
	Ratings not set.	Set ratings as desired.

RECEPTION DISTURBANCES

Most types of television interference can be remedied by adjusting the height and position of the VHF/UHF antenna. Outdoor antennas are recommended for best results if not using cable or a satellite. The most common types of television interference are shown below. If one of these symptoms appear when the TV is connected to a Cable TV system, the disturbance may be caused by the local cable company broadcast.

IGNITION:

Black spots or horizontal streaks may appear, picture may flutter or drift. Usually caused by interference from automobile ignition systems, neon lamps, electric drills and other electric appliances.

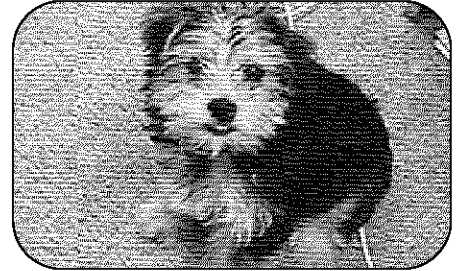

GHOSTS:

Ghosts are caused by the television signal following two paths. One is the direct path and the other is reflected from tall buildings, hills or other objects. Changing the direction or position of the antenna may improve the reception.

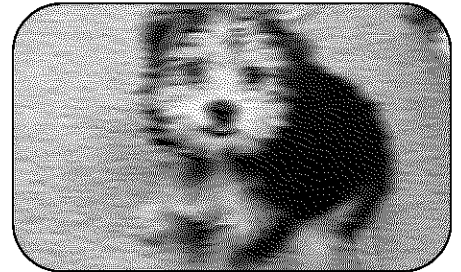

SNOW:

If your receiver is located in the fringe area of a television station where the signal is weak, your picture may be marred by the appearance of small dots. When the signal is extremely weak, it may be necessary to install an external antenna to improve the picture.

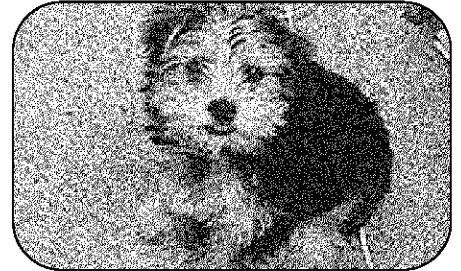

RADIO FREQUENCY INTERFERENCE:

This interference produces moving ripples or diagonal streaks, and in some cases, causes loss of contrast in the picture.

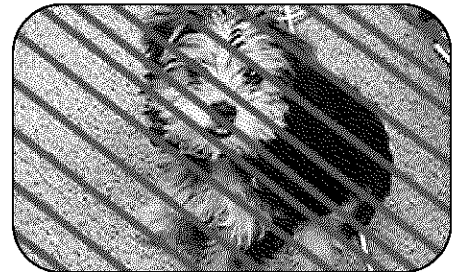

PICTURE SIZE VARIATION:

A slight picture size variation is quite normal when you adjust the CONTRAST or BRIGHTNESS setting.

CARE AND MAINTENANCE

To prevent fire or shock hazard, disconnect your unit from the AC power source when cleaning. The finish on the receiver may be cleaned with a dust cloth and cared for as other furniture. Use caution when cleaning and wiping the plastic parts. Mild soap and a soft, damp cloth may be used.

SPECIFICATIONS

LCD PANEL

Size	17" (43cm)
Display Type	Active matrix color TFT LCD
Resolution	1280 x 768
Display Dot	1280 x (RGB) x 768
Display Area (mm)	369.6 x 221.7 (H x V)
Display Color	262K
Brightness	400 cd/m ² (typical)
Contrast Ratio	400:1 (typical)
Response Time	Ta=25°C T on=15ms T off =10ms
Lamp Voltage	630Vrms (typical)
Lamp Current	10.5mA rms (typical)
Viewing Angle	Vertical -80° ~ +80°

DISPLAY COLORS16.7M with FRC or dithering

VIDEO

Input Signal	Analog RGB 0.7Vp-p
Input Impedance	75Ohm \pm 2%
Polarity	Positive, Negative
Amplitude	0 - .7 \pm 0.05Vp
Mutli-mode Supported	Horizontal Frequency: 30 ~ 60KHz Vertical Frequency: 50 ~ 75Hz

SPEAKER.....2.5W, 4.5Ohm

SYNC INPUT

Signal	Separate TTL compatible horizontal and vertical synchronization
Polarity	Positive, Negative

ENVIRONMENT

Operating Condition Temperature	5°C to 40°C/41°F to 104°F
Operating Condition Relative Humidity	20% to 85%
Storage Temperature	-20°C to 60°C/-4°F to 140°F
Operating Condition Relative Humidity	5% to 85%

POWER SUPPLY

Input Voltage	Single phase 120V AC 60Hz
Input Current	1.2A max

MISCELLANEOUS

Dimensions	518 (W) x 333 (H) x 198 (D) mm
Net Weight	5 \pm 0.3kg
Gross Weight	6.8 \pm 0.3kg

**FOR ADDITIONAL SET-UP OR OPERATING ASSISTANCE, PLEASE VISIT OUR WEBSITE AT
WWW.MEMOREXELECTRONICS.COM
OR CONTACT CUSTOMER SERVICE AT 1-877-4MEMCRP (1-877-463-6277).**

**PLEASE KEEP ALL PACKAGING MATERIAL FOR AT LEAST 90 DAYS IN CASE YOU NEED TO RETURN
THIS PRODUCT TO YOUR PLACE OF PURCHASE OR MEMOREX.**

FOR PARTS AND ACCESSORIES, CONTACT FOX INTERNATIONAL AT 1-800-321-6993.

Memcorp, Inc.
Weston, FL
Printed in Taiwan

Visit our website at www.memorexelectronics.com