

Memorex®

Is it live or is it Memorex?™

MVD2022

User's Guide

DVD/VCD/MP3/PHOTO CD Player

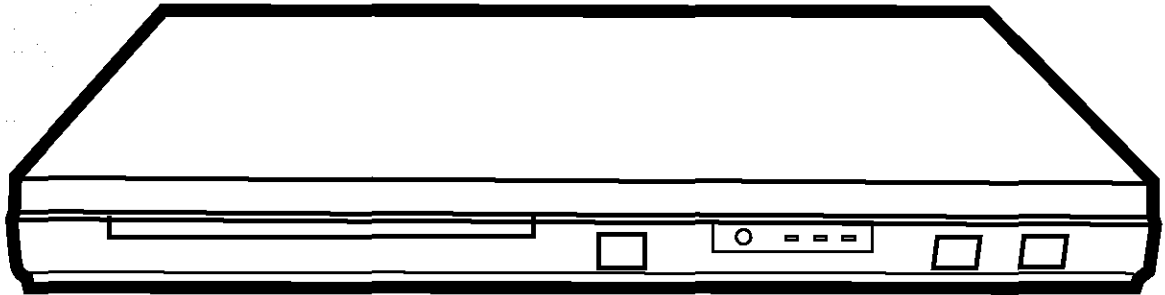

COMPACT
disc
DIGITAL AUDIO

BUILT-IN
MP3
DECODER

DVD
VIDEO

DOLBY
DIGITAL

dts
DIGITAL OUT

Before operating this product,
please read these instructions completely.

CONTENTS

Contents	1	• Repeat Playback.....	22
Important Safety Instructions	2	• A-B Playback	22
Precautions	5	• Audio Menu.....	23
Power Source	5	• Subtitle Menu	23
Location of Controls	6	• DVD Menu	23
• Front.....	6	• Title Menu	23
• Rear	6	• Zoom.....	23
• Remote	7	• Angle.....	23
Remote Control	8	MP3 Basic Operation	24
• Battery Installation	8	• Playback of an MP3.....	24
• Effective Distance of the Remote Control Transmitter	8	• Selecting Folders/Tracks using the SKIP Buttons.....	25
Connection	9	• Selecting Folders/Tracks using the Number Buttons.....	25
• Connecting the DVD to a TV Using the Audio/Video Output Jacks	9	• Forward/Reverse	25
• Connecting the DVD to a TV Using the S-Video Output Jack.....	9	• Repeat Play	25
• Connecting the DVD to a TV Using the Y/PB/PR Jacks	10	• MP3 FAQs.....	25
• Progressive (Y, PB, PR) Video OUT.....	10	CD/VCD Basic Operation	26
• 525 Line Digital Progressive-scan Component Video Output.....	10	• Playback of a CD/VCD	26
• Connecting the DVD to a Home Theatre System.....	11	• Selecting Tracks/Files using the Number Buttons.....	26
About Discs	12	• Selecting Tracks/Files using the SKIP Buttons.....	26
Setup Menu	14	• Forward/Reverse	27
• General Setup Menu.....	15	• Repeat One/All Play	27
• Speaker Setup Menu.....	16	• Repeat A-B Play	27
• Dolby Digital Setup Menu	16	• Random Playback.....	27
• Preferences Menu.....	17	• PBC (VCD Only).....	28
• Parental.....	18	PICTURE CD Basic Operation	29
• Password	18	Troubleshooting Guide	30
Basic Operation	19	Care and Maintenance	32
• Audio Mode.....	19	Specifications	33
• Mute	19		
• Display	19		
DVD Basic Operation	20		
• Playback of a DVD.....	20		
• Skip.....	21		
• Search.....	21		
• Slow/R and Slow/F	21		
• Pause/Step	21		
• Title/Chapter Search	22		
• Title/Time Search.....	22		

IMPORTANT SAFETY INSTRUCTIONS



CAUTION

**RISK OF ELECTRIC SHOCK
DO NOT OPEN**



The lightning flash with arrowhead symbol within an equilateral triangle is intended to alert the user to the presence of uninsulated dangerous voltage within the product's enclosure that may be of sufficient magnitude to constitute a risk of electric shock to persons.



The exclamation point within an equilateral triangle is intended to alert the user to the presence of important operating and maintenance (servicing) instructions in the literature accompanying the appliance.

CAUTION: TO REDUCE THE RISK OF ELECTRIC SHOCK, DO NOT REMOVE COVER (OR BACK). NO USER-SERVICEABLE PARTS INSIDE. REFER SERVICING TO QUALIFIED SERVICE PERSONNEL.

CAUTION:

THIS DIGITAL VIDEO DISC PLAYER EMPLOYS A LASER SYSTEM.

TO ENSURE PROPER USE OF THIS PRODUCT, PLEASE READ THIS OWNER'S MANUAL CAREFULLY AND RETAIN FOR FUTURE REFERENCE. SHOULD THE UNIT REQUIRE MAINTENANCE, CONTACT AN AUTHORIZED SERVICE LOCATION-SEE SERVICE PROCEDURE.

USE OF CONTROLS, ADJUSTMENTS OR THE PERFORMANCE OF PROCEDURES OTHER THAN THOSE SPECIFIED HEREIN MAY RESULT IN HAZARDOUS RADIATION EXPOSURE.

TO PREVENT DIRECT EXPOSURE TO LASER BEAM, DO NOT TRY TO OPEN THE ENCLOSURE. VISIBLE LASER RADIATION MAY BE PRESENT WHEN THE ENCLOSURE IS OPENED. DO NOT STARE INTO BEAM.

WARNING:

TO REDUCE THE RISK OF FIRE OR ELECTRIC SHOCK, DO NOT EXPOSE THIS PRODUCT TO RAIN OR MOISTURE.

WARNING:

TO REDUCE THE RISK OF FIRE OR ELECTRIC SHOCK, AND ANNOYING INTERFERENCE, USE THE RECOMMENDED ACCESSORIES ONLY.

SURGE PROTECTORS:

It is recommended to use a surge protector for AC connection. Lightning and power surges ARE NOT covered under warranty for this product.

FCC NOTICE:

This equipment has been tested and found to comply with the limits for a Class B digital device, pursuant to part 15 of the FCC Rules. These limits are designed to provide reasonable protection against harmful interference in a residential installation. This equipment generates, uses and can radiate radio frequency energy and, if not installed and used in accordance with the instructions, may cause harmful interference to radio communications.

However, there is no guarantee that interference will not occur in a particular installation. If this equipment does cause harmful interference to radio or television reception, which can be determined by turning the equipment off and on, the user is encouraged to try to correct the interference by one or more of the following measures:

- Reorient or relocate the receiving antenna.
- Increase the separation between the equipment and receiver.
- Connect the equipment into an outlet on a circuit different from that to which the receiver is connected.
- Consult the dealer or an experienced radio/TV technician for help.

FCC CAUTION:

To assure continued compliance, follow the attached installation instructions and use only shielded cables when connecting to other devices. Also, any changes or modifications not expressly approved by the party responsible for compliance could void the user's authority to operate the equipment.

Manufactured under license from Dolby Laboratories.

"Dolby" and the double-D symbol are trademarks of Dolby Laboratories.

IMPORTANT SAFETY INSTRUCTIONS (CONTINUED)

IMPORTANT:

PLEASE KEEP ALL PACKAGING MATERIAL FOR AT LEAST 90 DAYS IN CASE YOU NEED TO RETURN THIS PRODUCT TO YOUR PLACE OF PURCHASE OR TO MEMOREX.

Before using the unit, be sure to read all operating instructions carefully. Please note that these are general precautions and may not pertain to your unit. For example, this unit may not have the capability to be connected to an outdoor antenna.

1. READ INSTRUCTIONS

All the safety and operating instructions should be read before the product is operated.

2. RETAIN INSTRUCTIONS

The safety and operating instructions should be retained for future reference.

3. HEED WARNINGS

All warnings on the product and in the operating instructions should be adhered to.

4. FOLLOW INSTRUCTIONS

All operating and use instructions should be followed.

5. CLEANING

Unplug this product from the wall outlet before cleaning. Do not use liquid cleaners or aerosol cleaners. Use a dry cloth for cleaning.

6. ATTACHMENTS

Do not use attachments not recommended by the product's manufacturer as they may cause hazards.

7. WATER AND MOISTURE

Do not use this product near water-for example: near a bathtub, washbowl, kitchen sink or laundry tub; in a wet basement; or near a swimming pool.

8. ACCESSORIES

Do not place this product on an unstable cart, stand, tripod, bracket or table. The product may fall, causing serious injury and serious damage to the product. Use only with a cart, stand, tripod, bracket or table recommended by the manufacturer or sold with the product. Any mounting of the product should follow the manufacturer's instructions, and should use a mounting accessory recommended by the manufacturer.

8A. An appliance and cart combination should be moved with care. Quick stops, excessive force and uneven surfaces may cause the appliance and cart combination to overturn.

9. VENTILATION

Slots and openings in the cabinet and in the back or bottom are provided for ventilation, to ensure reliable operation of the product and to protect it from overheating. These openings must not be blocked or covered. The openings should never be blocked by placing the product on a bed, sofa, rug or other similar surface. This product should never be placed near or over a radiator or heat source. This product should not be placed in a built-in installation such as a bookcase or rack unless proper ventilation is provided or the manufacturer's instructions have been adhered to.

10. POWER SOURCES

This product should be operated only from the type of power source indicated on the marking label. If you are not sure of the type of power supply to your home, consult your appliance dealer or local power company. For products intended to operate from battery power, or other sources, refer to the operating instructions.

11. GROUNDING OR POLARIZATION

This product is equipped with a polarized alternating-current line plug (a plug having one blade wider than the other). This plug will fit into the power outlet only one way. This is a safety feature. If you are unable to insert the plug fully into the outlet, try reversing the plug. If the plug should still fail to fit, contact your electrician to replace your obsolete outlet. Do not defeat the safety purpose of the polarized plug.

12. POWER-CORD PROTECTION

Power-supply cords should be routed so that they are not likely to be walked on or pinched by items placed upon or against them, paying particular attention to cords at plugs, convenience receptacles, and the point where they exit from the appliance.

13. LIGHTNING

To protect your product from a lightning storm, or when it is left unattended and unused for long periods of time, unplug it from the wall outlet and disconnect the antenna or cable system. This will prevent damage to the product due to lightning and power-line surges.

14. POWER LINES

An outside antenna system should not be located in the vicinity of overhead power lines or other electric light or power circuits, or where it can fall into such power lines or circuits. When installing an outside antenna system, extreme care

PORTABLE CART WARNING
(symbol provided by RETAC)



IMPORTANT SAFETY INSTRUCTIONS (CONTINUED)

should be taken to keep from touching such power lines or circuits as contact with them might be fatal.

15. OVERLOADING

Do not overload wall outlets and extension cords as this can result in a risk of fire or electric shock.

16. OBJECT AND LIQUID ENTRY

Never push objects of any kind into this product through openings as they may touch dangerous voltage points or short out parts that could result in fire or electric shock. Never spill or spray any type of liquid on the product.

17. OUTDOOR ANTENNA GROUNDING

If an outside antenna is connected to the product, be sure the antenna system is grounded so as to provide some protection against voltage surges and built-up static charges. Section 810 of the National Electric Code, ANSI/NFPA 70, provides information with respect to proper grounding of the mast and supporting structure, grounding of the lead-in wire to an antenna discharge product, size of grounding conductors, location of antenna discharge product, connection to grounding electrodes and requirements for grounding electrode.

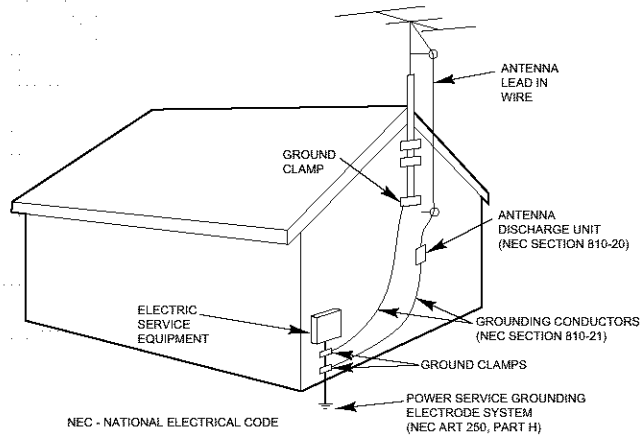

EXAMPLE OF ANTENNA GROUNDING AS PER
NATIONAL ELECTRICAL CODE

18. SERVICING

Do not attempt to service this product yourself as opening or removing covers may expose you to dangerous voltage or other hazards. Refer all servicing to qualified service personnel.

19. REPLACEMENT PARTS

When replacement parts are required, be sure the service technician uses replacement parts specified by the manufacturer or those that have the same characteristics as the original part. Unauthorized substitutions may result in fire, electric shock or other hazards.

20. SAFETY CHECK

Upon completion of any service or repairs to this product, ask the service technician to perform safety checks to determine that the product is in proper operating condition.

21. WALL OR CEILING MOUNTING

The product should be mounted to a wall or ceiling only as recommended by the manufacturer.

22. DAMAGE REQUIRING SERVICE

Unplug the product from the wall outlet and refer servicing to qualified service personnel under the following conditions:

- When the power-supply cord or plug is damaged.
- If liquid has been spilled or objects have fallen into the product.
- If the product has been exposed to rain or water.
- If the product does not operate normally by following the operating instructions. Adjust only those controls that are covered by the operating instructions, as an adjustment of other controls may result in damage and will often require extensive work by a qualified technician to restore the product to its normal operation.
- If the product has been dropped or the cabinet has been damaged.
- When the product exhibits a distinct change in performance-this indicates a need for service.

23. HEAT

The product should be situated away from heat sources such as radiators, heat registers, stoves or other products (including amplifiers) that produce heat.

24. NOTE TO CATV SYSTEM INSTALLER

This reminder is provided to call the CATV system installer's attention to Article 820-40 of the NEC that provides guidelines for proper grounding and, in particular, specifies that the cable ground shall be connected to the grounding system of the building, as close to the point of cable entry as practical.

PRECAUTIONS

NOTES ON HANDLING:

- When shipping the DVD player, always use the original shipping carton and packing materials. For maximum protection, repack the unit as it was originally packed at the factory.
- Do not use volatile liquids, such as insect spray, near the DVD player. Do not leave rubber or plastic products in contact with the DVD player for a long time. They will leave marks on the finish.
- The top and rear panels of the DVD player may become warm after a long period of use. This is normal and not a malfunction.
- When the DVD player is not in use, be sure to remove the disc and turn off the power.
- If you do not use the DVD player for a long period, the unit may not function properly in the future. Turn on and use the DVD player occasionally.

NOTES ON LOCATING THE DVD PLAYER:

- When you place this DVD player near a TV, radio or VCR, the playback picture may become poor and the sound may be distorted. In this case, move the DVD player away from the TV, radio or VCR.

NOTES ON CLEANING:

Use a soft, dry cloth for cleaning.

- For stubborn dirt, soak the cloth in a weak detergent solution, wring well and wipe. Use a dry cloth to wipe it dry. Do not use any type of solvent, such as thinner and benzene, as they may damage the surface of the DVD player.
- If you use a chemical-saturated cloth to clean the unit, follow that product's instructions.

Warning: Cleaning and adjustment of lenses and/or other components of playback mechanism should be performed by a qualified service technician.

TO OBTAIN A CLEAR PICTURE:

The DVD player is a high technology, precision device. If the optical pick-up lens and disc drive parts are dirty or worn down, the picture quality becomes poor. To obtain a clear picture, we recommend regular inspection and maintenance (cleaning or parts replacement) every 1,000 hours of use depending on the operating environment. For details, contact your nearest dealer.

NOTES ON MOISTURE CONDENSATION:

Moisture condensation damages the DVD player. Please read the following carefully.

- Moisture condensation occurs, for example, when you pour a cold drink into a glass on a warm day. Drops of water form on the outside of the glass. In the same way, moisture may condense on the optical pick-up lens inside this unit, one of the most crucial internal parts of the DVD player.

Moisture condensation occurs during the following cases:

- When you bring the DVD player directly from a cold place to a warm place.
- When you use the DVD player in a room where you just turned on the heater, or a place where the cold wind from the air conditioner directly hits the unit.
- In summer, when you use the DVD player in a hot and humid place just after you moved the unit from an air conditioned room.
- When you use the DVD player in a humid place.

Do not use the DVD player when moisture condensation may occur.

- If you use the DVD player in such a situation, it may damage discs and internal parts. Remove the disc, connect the power cord of the DVD player to the wall outlet, turn on the DVD player and leave it "ON" for two or three hours. After two or three hours, the DVD player will have warmed up and evaporated any moisture. Keep the DVD player connected to the wall outlet and moisture condensation will seldom occur.

POWER SOURCE

Insert the AC plug (with the 2 blades) into a conveniently located AC outlet having 120V, 60Hz.

NOTE: The AC plug supplied with the unit is polarized to help minimize the possibility of electric shock. If the AC plug does not fit into a nonpolarized AC outlet, do not file or cut the wide blade. It is the user's responsibility to have an electrician replace the obsolete outlet.

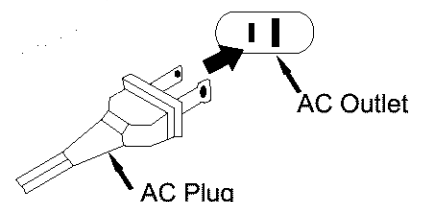

LOCATION OF CONTROLS

FRONT

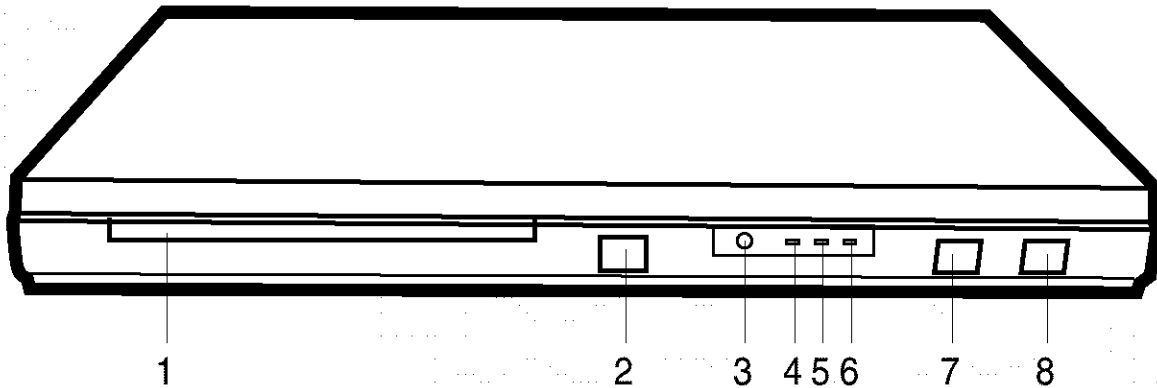

1. Disc Tray
2. OPEN/CLOSE Button
3. Remote Sensor
4. Remote Receive Indicator
5. STANDBY Indicator
6. POWER ON Indicator
7. STANDBY/STOP Button

To return to the Standby mode while the unit is on, press and hold the STANDBY/STOP button for two seconds then release; the unit will be turned off and the Standby indicator will light on.

8. PLAY (▶) Button

REAR

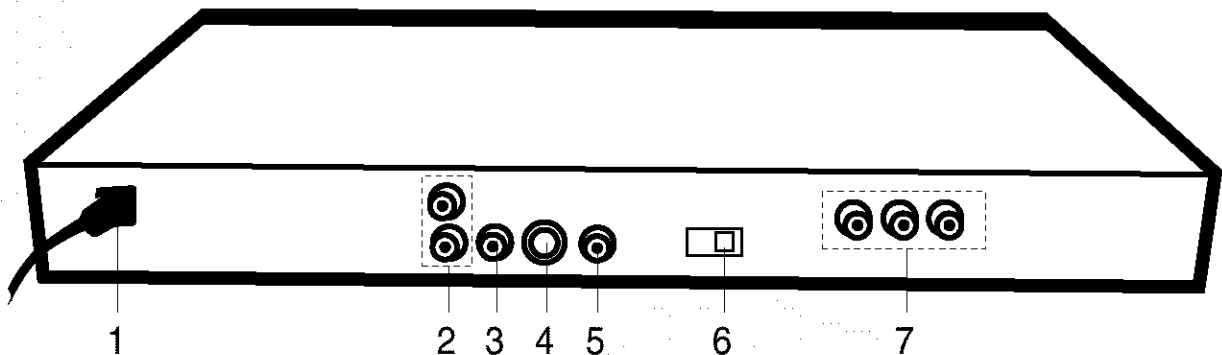

1. AC Power Cord
2. Stereo Audio Left/Right Output Jacks
3. Video Output Jack
4. S-Video Output Jack
5. Coaxial Digital Audio Output Jack
6. PROGRESSIVE SCAN ON/OFF Switch
7. Component Video (Y, PB, PR) Output Jacks

LOCATION OF CONTROLS (CONTINUED)

REMOTE

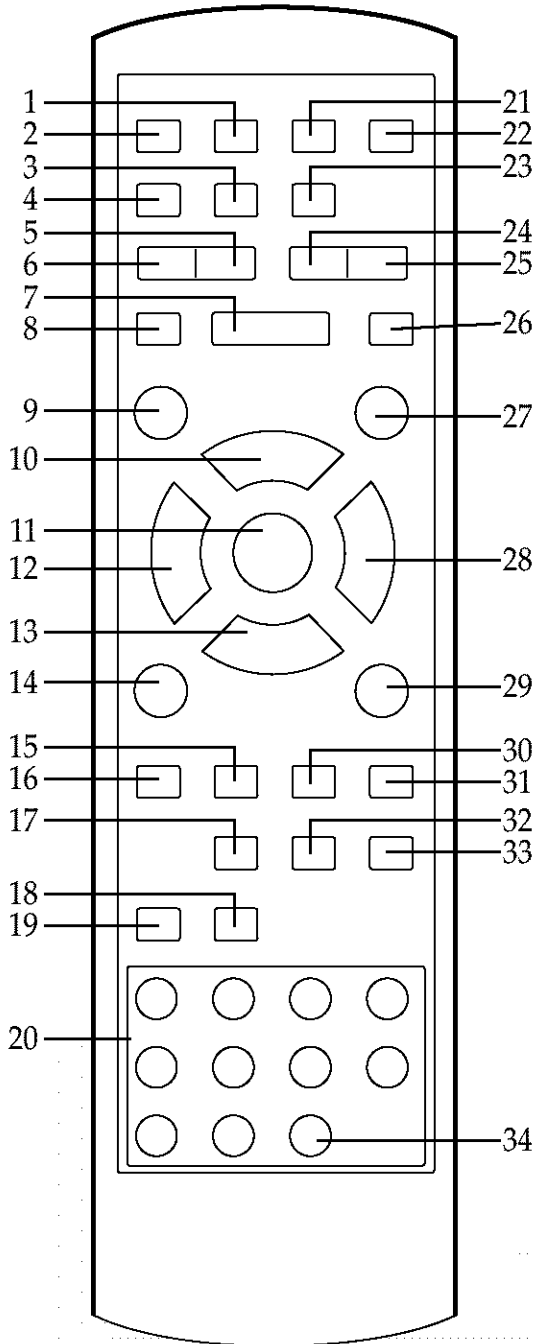

1. **DISPLAY** Button
2. **MUTE** Button
3. **REPEAT** Button
4. **RANDOM** Button
5. **SLOW/F** Button
6. **SLOW/R** Button
7. **PLAY (▶)** Button
8. **PAUSE/STEP** Button
9. **SKIP (⏮)** Button
10. **Navigation (▲)** Button
11. **ENTER** Button
12. **Navigation (◀)** Button
13. **Navigation (▼)** Button
14. **RETURN** Button
15. **TITLE MENU** Button
16. **DVD MENU** Button
17. **ANGLE** Button
18. **PBC** Button
19. **SEARCH** Button
20. **Number (0–9) Buttons**
21. **OPEN/CLOSE** Button
22. **STANDBY ON/OFF** Button
23. **Repeat A-B** Button
24. **SEARCH ◀◀** Button
25. **SEARCH ▶▶** Button
26. **STOP (■)** Button
27. **SKIP (⏭)** Button
28. **Navigation (▶)** Button
29. **SETUP** Button
30. **SUBTITLE MENU** Button
31. **AUDIO MENU** Button
32. **ZOOM** Button
33. **AUDIO MODE** Button
34. **CLEAR** Button

REMOTE CONTROL

BATTERY INSTALLATION

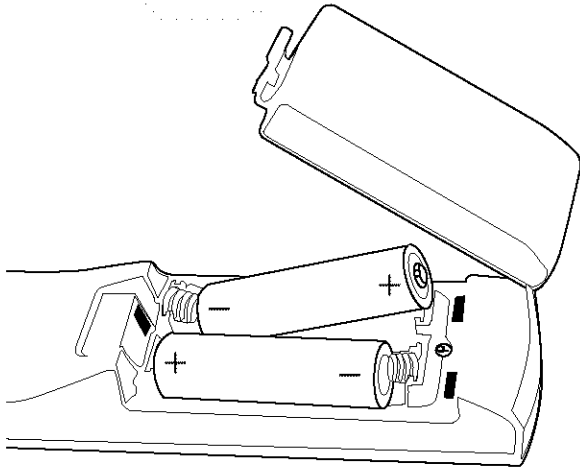

1. Open the battery compartment cover by pushing in on the tab and lifting it out.
2. Install two (2) "AA" batteries (not included), paying attention to the polarity diagram in the battery compartment.
3. Replace the battery compartment cover.

BATTERY PRECAUTIONS

Follow these precautions when using batteries in this device:

1. Use only the size and type of batteries specified.
2. Be sure to follow the correct polarity when installing the batteries as indicated next to the battery compartment. Reversed batteries may cause damage to the device.
3. Do not mix different types of batteries together (e.g. Alkaline, Rechargeable and Carbon-zinc) or old batteries with fresh ones.
4. If the device is not to be used for a long period of time, remove the batteries to prevent damage or injury from possible battery leakage.
5. Do not try to recharge batteries not intended to be recharged; they can overheat and rupture. (Follow battery manufacturer's directions.)

EFFECTIVE DISTANCE OF THE REMOTE CONTROL TRANSMITTER

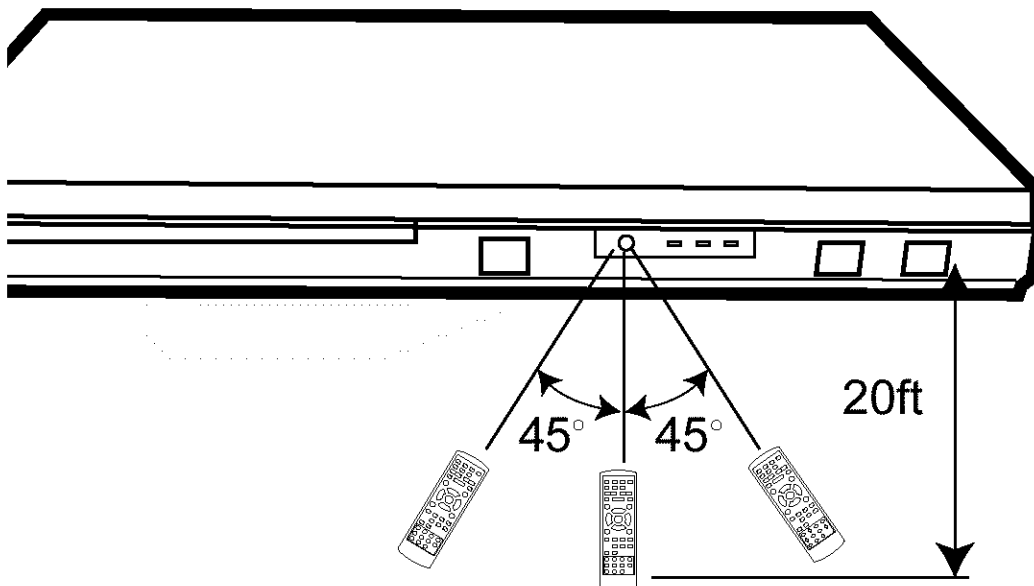

NOTES:

- When there is an obstacle between the DVD and the transmitter, the transmitter may not operate.
- When direct sunlight, an incandescent lamp, fluorescent lamp or any other strong light shines on the REMOTE SENSOR of the DVD, the remote operation may be unstable.

CONNECTION

CONNECTING THE DVD TO A TV USING THE AUDIO/VIDEO OUTPUT JACKS

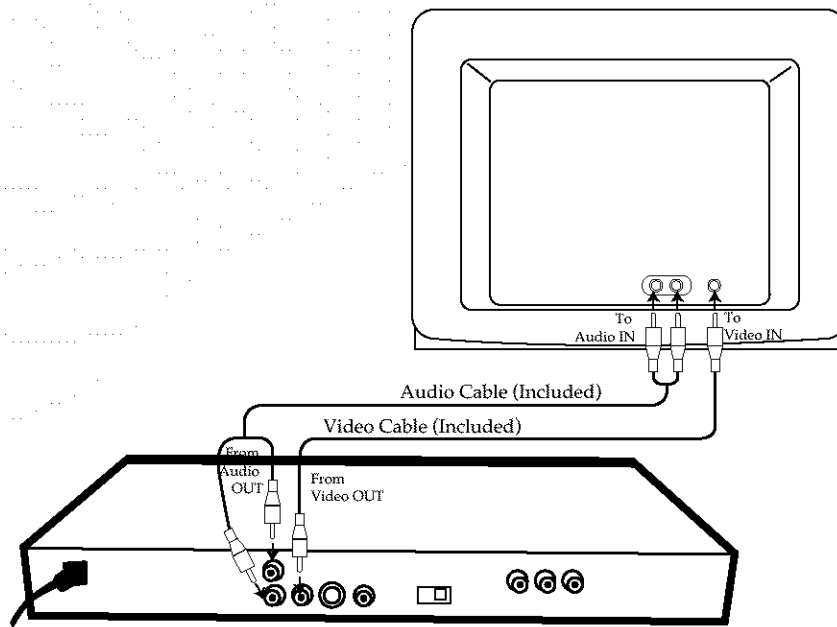

CONNECTING THE DVD TO A TV USING THE S-VIDEO OUTPUT JACK

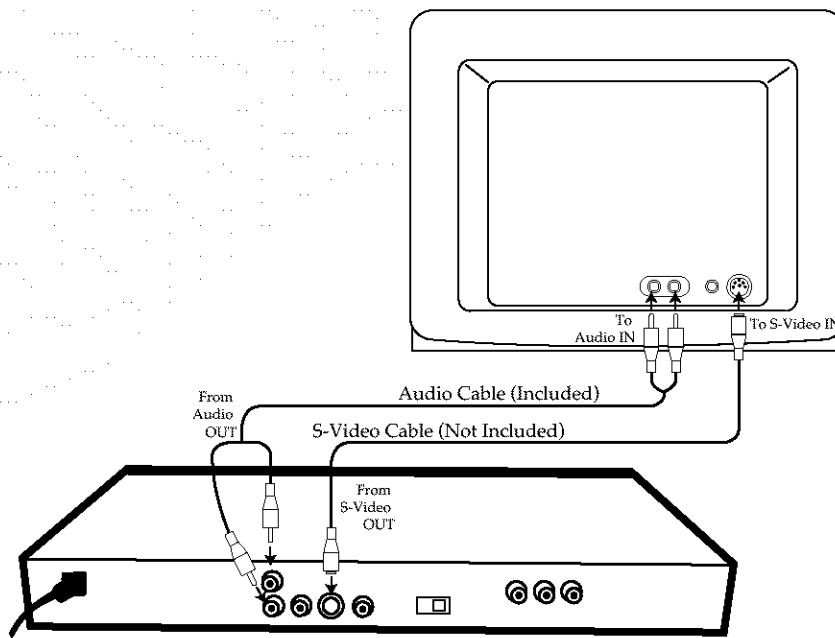

NOTES FOR CONNECTING TO A TV:

- If your TV has a component input, connect the DVD player with the component cable for best results, otherwise use the S-Video or Video Out jack on the DVD player.
- Set the TV's TV/VIDEO button or switch to the VIDEO setting.
- When connecting the DVD, refer to the owner's manual of the TV, as well as this manual.
- When connecting the DVD to the TV, make sure the power is off and both units are unplugged before making any connections.
- If your TV only has one audio input, the use of a "Y" connector may be necessary. Visit your local electronics supply store.
- Connect the DVD player to your TV directly. If you connect the DVD player through a VCR, the playback picture will be distorted because DVD video discs are copy protected.
- After connecting, press the AUDIO MODE button to the desired audio setting. (Please refer to AUDIO MODE on page 19.)

CONNECTION (CONTINUED)

CONNECTING THE DVD TO A TV USING THE Y/PB/PR JACKS

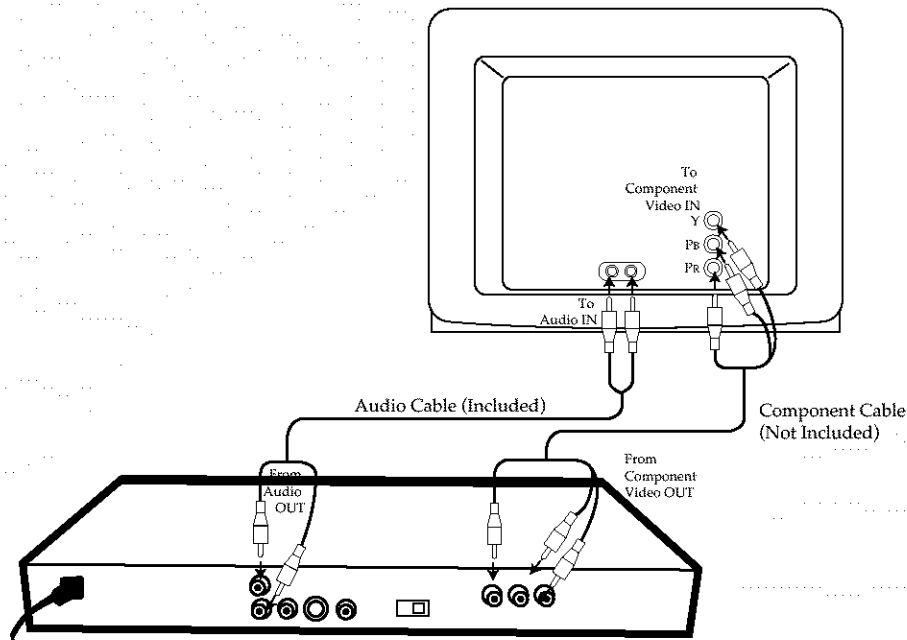

NOTES FOR CONNECTING TO A TV:

- TV must have Y, PB and PR input jacks.
- Set the TV's TV/VIDEO button or switch to the VIDEO setting.
- When connecting the DVD, refer to the owner's manual of the TV, as well as this manual.
- When connecting the DVD to the TV, make sure the power is off and both units are unplugged before making any connections.
- Connect the DVD player to your TV directly. If you connect the DVD player through a VCR, the playback picture will be distorted because DVD video discs are copy protected.
- If using a TV with a blue screen option, turn the option off, on the TV for best results.

PROGRESSIVE (Y, PB, PR) VIDEO OUT:

Use these jacks to connect to a TV with progressive video input jacks, set the PROGRESSIVE SCAN switch to ON. Progressive scan is a video scanning system that displays all lines in a frame in one pass, as opposed to the traditional system, interlaced scan. This connection provides optimum quality. To ensure maximum picture quality, use three video-grade cables for connections. Note that it is essential to match the color-coded connectors with a compatible TV.

525 LINE DIGITAL PROGRESSIVE-SCAN COMPONENT VIDEO OUTPUT

Compared to standard interlaced video, progressive scan effectively doubles the amount of video information fed to your TV or monitor. The result is a stable, flicker-free image. (Check your TV/monitor for compatibility with this feature.) For the very highest picture quality, try watching a movie on DVD-Video on a progressive-scan compatible TV.

NOTES:

- If you connect a TV that is not compatible with a progressive scan signal and the PROGRESSIVE SCAN switch is in the ON position, you will not be able to see any picture at all. To regain the picture, you must shut the unit off and set the PROGRESSIVE SCAN switch to the OFF position. Then, turn the unit on and the picture will appear.
- CONSUMERS SHOULD NOTE THAT NOT ALL HIGH DEFINITION TELEVISION SETS ARE FULLY COMPATIBLE WITH THIS PRODUCT AND MAY CAUSE ARTIFACTS TO BE DISPLAYED IN THE PICTURE. IN CASE OF 525 PROGRESSIVE SCAN PICTURE PROBLEMS, IT IS RECOMMENDED THAT THE USER SET THE PROGRESSIVE SCAN SWITCH TO "OFF".

CONNECTION (CONTINUED)

CONNECTING THE DVD TO A HOME THEATRE SYSTEM

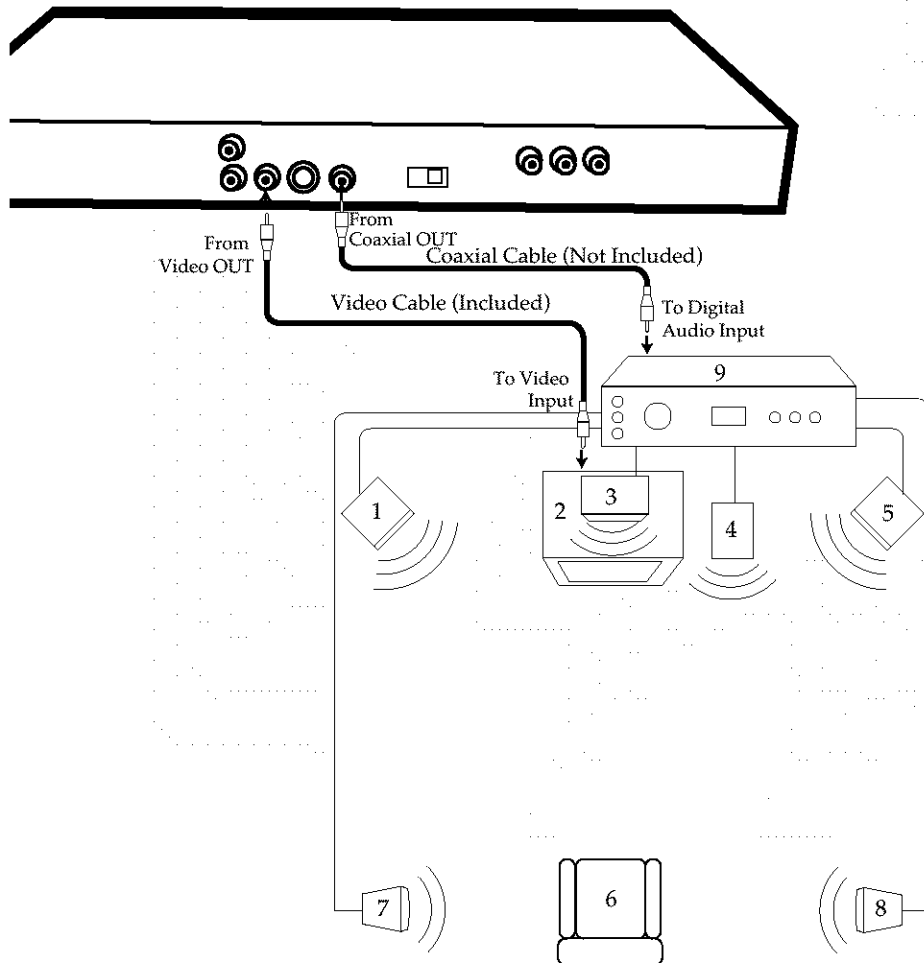

Place the subwoofer, front, rear and center speakers in locations as shown/described here. After correctly positioning the speakers, perform the Tone Test on the AV Amplifier and adjust the volume controls until the desired sound is achieved. For best results, sit in the viewing position and have someone adjust the volumes for you; this will enable you to set the optimal levels.

NOTE:

- The rear speakers can also be located on the side wall facing the viewing position and each other. Make sure the viewing position is located between the 2 speakers in this case. Experiment to find optimal position.

1. Front Left Speaker

2. Television

3. **Center Speaker**-can be located on top or below the Television.

4. **Sub-woofer**-can be located anywhere in the room.

5. Front Right Speaker

6. **Viewing/Listening Position**-The best listening position is obtained by positioning the chair, sofa, etc. in the middle of all the speakers.

7. Rear Left Speaker

8. Rear Right Speaker

9. AV Amplifier w/Dolby Digital Decoder/DTS Decoder

NOTES FOR CONNECTING TO A TV:

- If your TV has a Component input, connect the DVD player with the component cable for best results, otherwise use the S-Video or Video OUT jack on the DVD player.
- Set the TV's TV/VIDEO button or switch to the VIDEO setting.
- When connecting the DVD, refer to the owner's manual for the TV and the audio system, as well as this manual.
- When connecting, make sure the power is off and all units are unplugged before making any connections.
- Connect the DVD player to your TV directly. If you connect the DVD player through a VCR, the playback picture will be distorted because DVD video discs are copy protected.
- If using a TV with a blue screen option, turn the option off, on the TV for best results.
- If you place the DVD player near a tuner, the radio broadcast sound might be distorted. In this case, move the DVD player away from the tuner.
- After connecting, press the AUDIO MODE button to the desired audio setting. (Please refer to AUDIO MODE on page 19.)

ABOUT DISCS

The region number for this DVD Player is:
See the following page for information regarding region numbers.

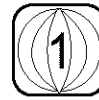

PLAYABLE DISCS:

The following discs can be played back on this DVD player:



MP3

When playing an MP3, the TV screen will list the folders/tracks.

MP3 is the abbreviation of "MPEG1 Audio Layer 3". MPEG Audio is a format that compresses the audio portion only.

IMPORTANT NOTES:

Due to many variables, including recording condition, type of disc, writing software, etc., this unit does not guarantee playback of all MP3 discs.

DISC TYPES:

DVD

Data on most DVDs is divided into sections called "titles" and then into subsections called "chapters", each of which is given a title or chapter number. Some features of this DVD player will not operate with some DVD discs as they are preset. If a function you selected does not run as desired, refer to the manual accompanying the DVD disc.

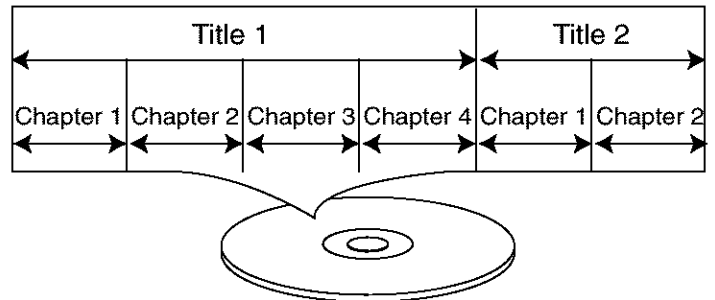

AUDIO CD

Data on an audio CD is divided into sections called "tracks", each of which is given a track number.

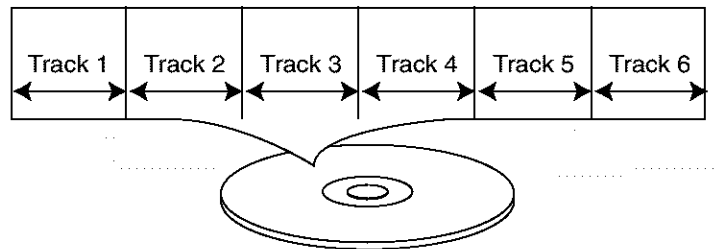

KODAK PICTURE CD

Data on a Kodak picture CD is usually not divided into separate folders, they should appear in the root directory.

IMPORTANT:

It is important that you read the manual that accompanies the DVD disc, as there are features that are on the DVD player that cannot be used with certain DVDs. There are also extra features on the DVD disc that are different for each DVD disc, so they are not explained in this owner's manual.

This player conforms to the NTSC and PAL color systems. However, if you are in the USA, leave this setting on NTSC. If incorrectly set to PAL, the TV picture will roll vertically. In this case, simply turn the DVD off, and then back on.

ABOUT DISCS (CONTINUED)

Notes on Copyright:

It is forbidden by law to copy, broadcast, show, broadcast on cable, play in public and rent copyrighted material without permission. DVD video discs are copy protected, and any recordings made from these discs will be distorted. This product incorporates copyright protection technology that is protected by method claims of certain U.S. patents and other intellectual property rights owned by Macrovision Corporation and other rights owners. Use of this copyright protection technology must be authorized by Macrovision Corporation, and is intended for home and other limited viewing uses only, unless otherwise authorized by Macrovision Corporation. Reverse engineering or disassembly is prohibited.

Region Management Information:

This DVD Player is designed and manufactured to respond to the Region Management Information that is recorded on a DVD disc. If the Region number described on the DVD disc does not correspond to the Region number of this DVD player, this DVD player cannot play that disc. You may not be able to play back some DVD video discs on this player if they were purchased from outside your geographic area or made for business purposes. When you try to play back an unauthorized disc, "Wrong Region" appears on the TV screen.

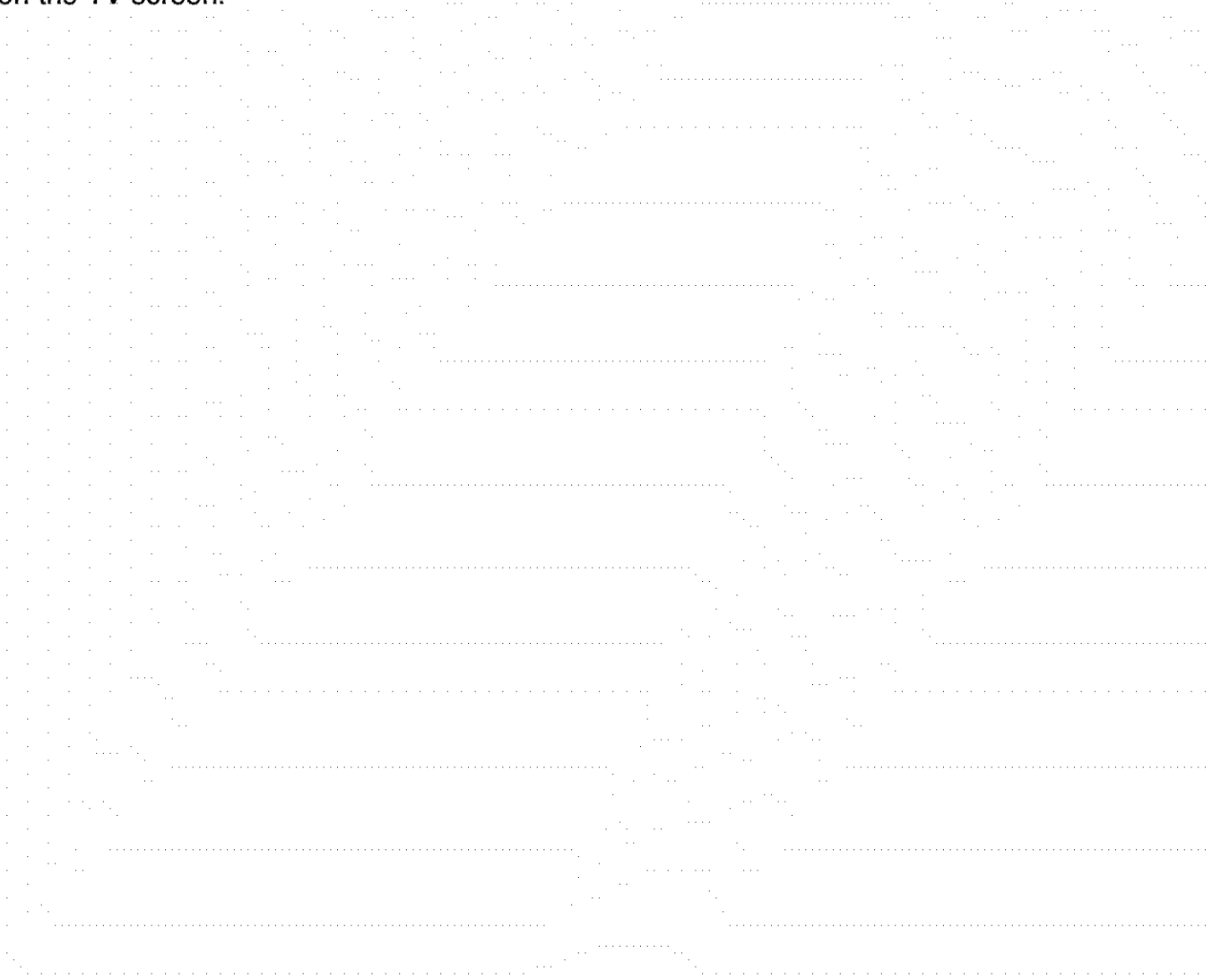

SETUP MENU

The setup menu lets you customize the DVD player by allowing you to select various language preferences, set up a parental level, turn captions and screen saver on and off, adjust what type of television screen you have and more. Below, find the menu, and then find the corresponding page that describes the features of the selected menu option.

Enter the SETUP MENU by pressing the SETUP button ❶. Use the Navigation (◀, ▶, ▲, ▼) buttons ❷ to navigate through the menus/screens and press the ENTER button ❸ to select the highlighted option.

To Exit the SETUP MENU, press the SETUP button ❶.

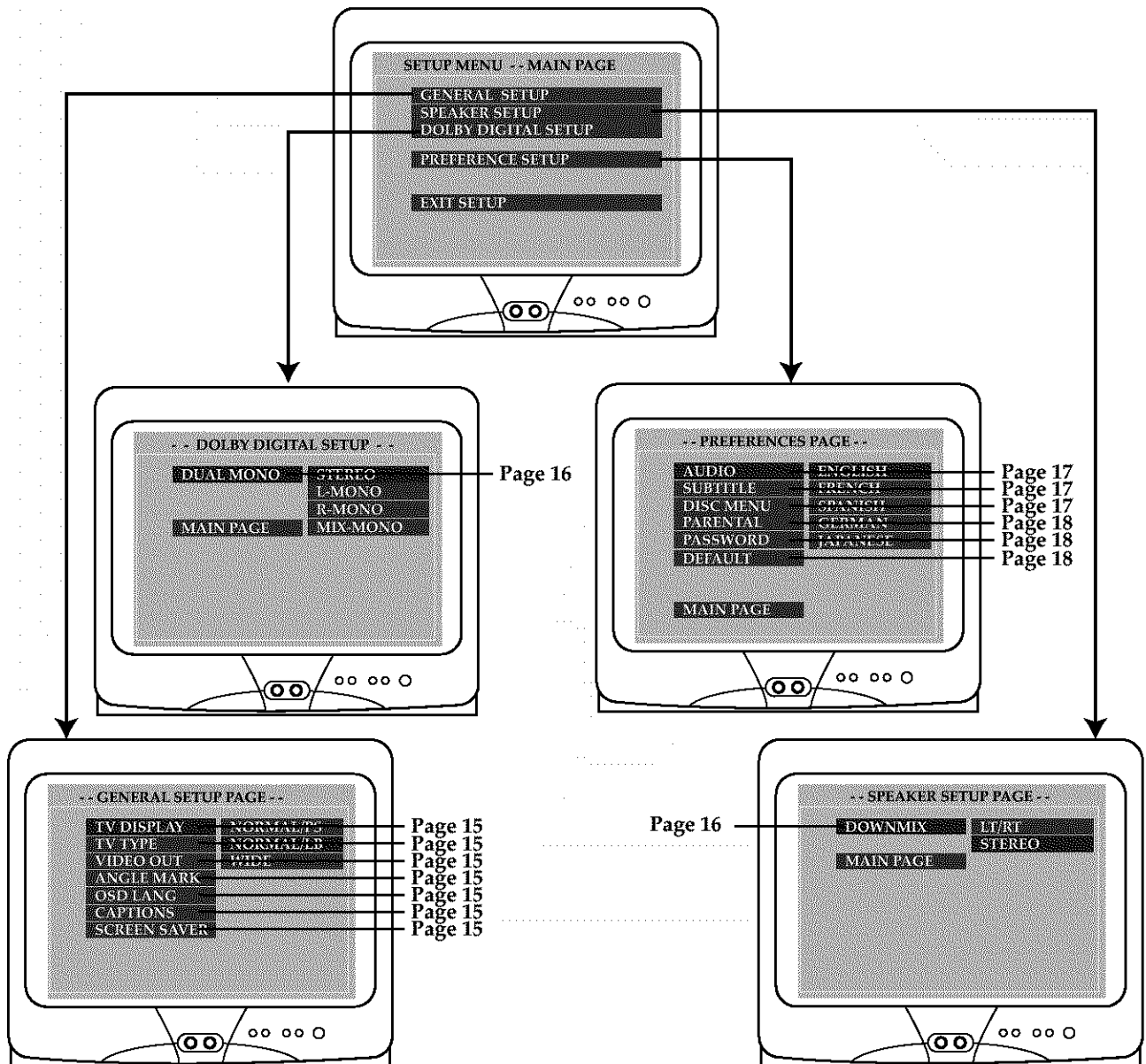
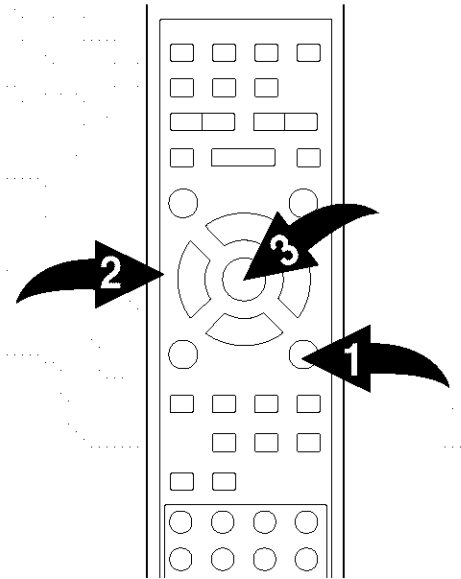

GENERAL SETUP MENU:

Select GENERAL SETUP in the SETUP MENU and then select the desired option using the Navigation (◀, ▶, ▲, ▼) buttons to navigate through the menus/screens and press the ENTER button to select.

TV DISPLAY

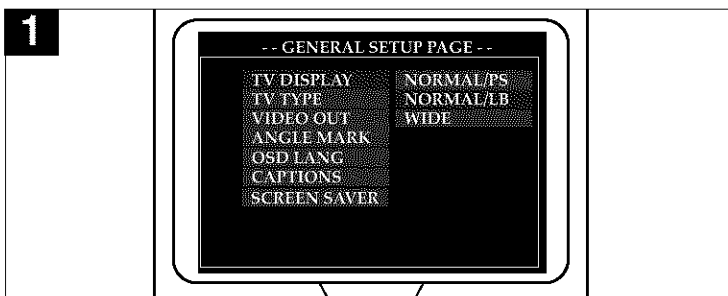

NORMAL/PS: Pan Scan. Select when the unit is connected to a conventional TV. Video material formatted in the Pan Scan style is played back in that style (the left and right edges are cut off).

NORMAL/LB: Letter Box. Select when the unit is connected to a normal TV. Wide-screen images are shown on the screen with a black band at the top or bottom.

WIDE: Select when the unit is connected to a wide-screen TV.

TV TYPE

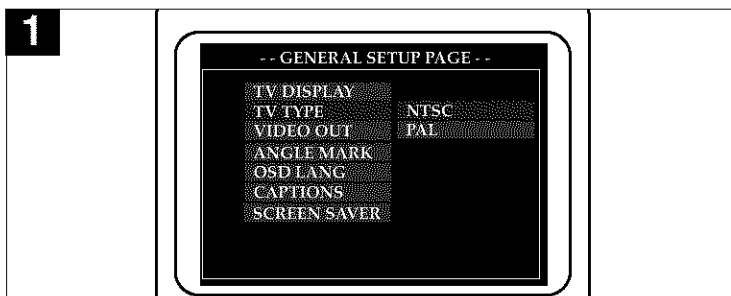

NTSC: Select when using an NTSC TV.

PAL: Select when using a PAL TV.

IMPORTANT: In the USA, the standard is NTSC.

VIDEO OUT (Color Video Connector Type)

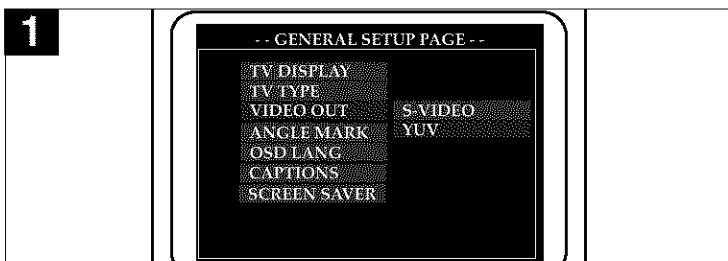

Select the color video type to fit your connector type:

S-VIDEO: Select when using S-Video and Video OUT.

YUV: Select when using Component and Video OUT.

This setting does not affect when connecting with other connections.

ANGLE MARK

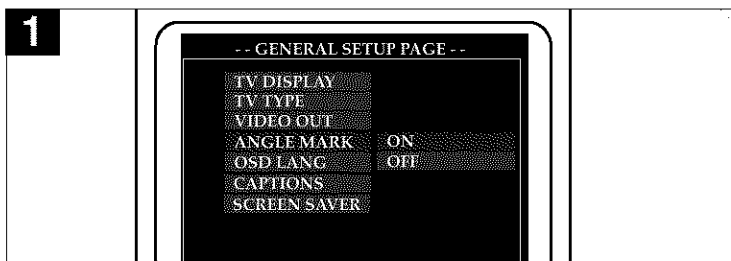

Select ON to turn the anglemarks on and OFF to turn them off.

Anglemarks are not available on all DVDs.

OSD LANGUAGE

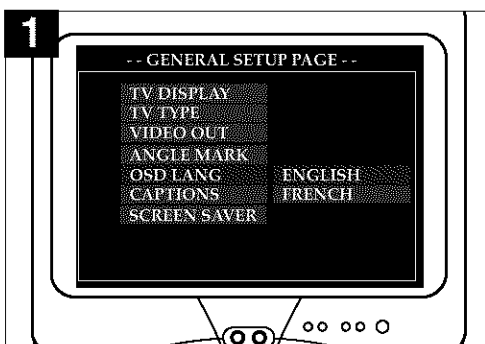

Select the desired language (ENGLISH, FRENCH) for the On-Screen display to display text. Note that the DVD must have the language included in order to display it.

CAPTIONS

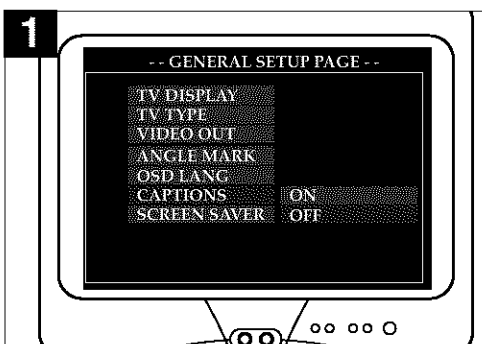

When this option is set to ON, closed captions will appear on the screen for the hearing impaired (if originally recorded on the DVD). When this option is OFF, the closed captions will not appear.

SCREEN SAVER

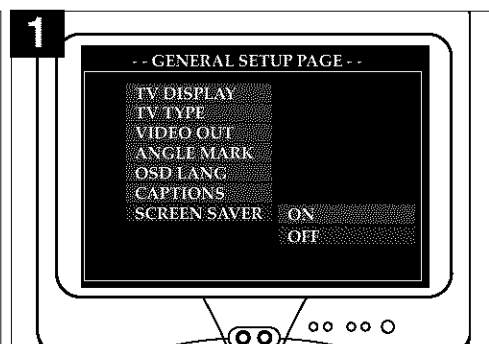

When this option is set to ON, the screen saver will come on when the unit stops or the image is paused for approximately one minute.

When this option is OFF, the screen saver will not come on.

SETUP MENU (CONTINUED)

SPEAKER SETUP MENU:

Select SPEAKER SETUP in the SETUP MENU and then select the desired option using the Navigation (◀, ▶, ▲, ▼) buttons to navigate through the menus/screens and press the ENTER button to select.

DOWNMIX

Sets the Audio Output mode.

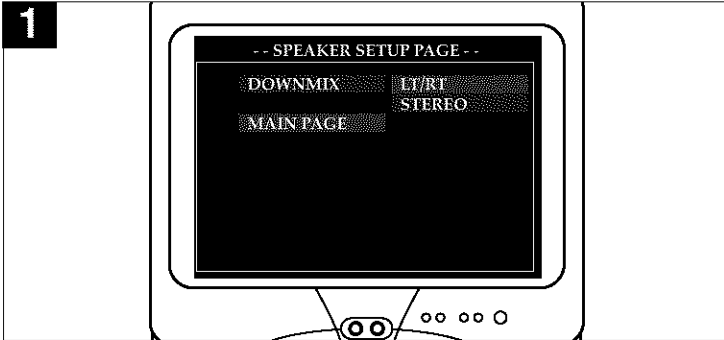

LT/RT: Select to hear the sound in theatrical downmix mode.

STEREO: Select to hear the sound in Stereo downmix mode.

DOLBY DIGITAL SETUP MENU:

Select DOLBY DIGITAL SETUP in the SETUP MENU and then select the desired option using the Navigation (◀, ▶, ▲, ▼) buttons to navigate through the menus/screens and press the ENTER button to select.

DUAL MONO

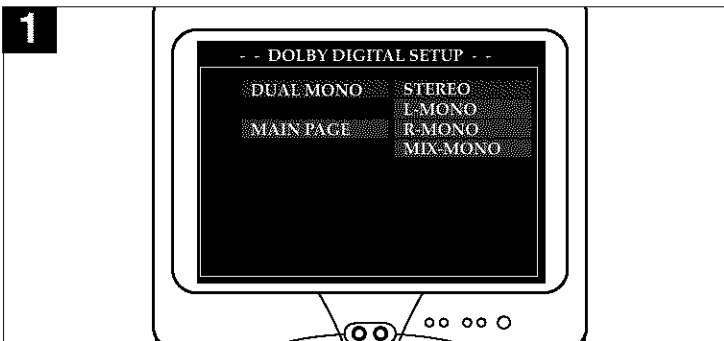

STEREO: Select this to set the Dolby Digital output to Stereo mode.

L-MONO: Select this to set the Dolby Digital output to left mono mode, meaning it will reproduce the left mono signal to the Left and Right channels.

R-MONO: Select this to set the Dolby Digital output to right mono mode, meaning it will reproduce the right mono signal to the Left and Right channels.

MIX-MONO: Select this to reproduce both channels mixed together.

SETUP MENU (CONTINUED)

PREFERENCE MENU (this menu cannot be accessed if a disc is inserted):

Select PREFERENCES in the SETUP MENU and then select the desired option using the Navigation (◀, ▶, ▲, ▼) buttons to navigate through the menus/screens and press the ENTER button to select.

AUDIO

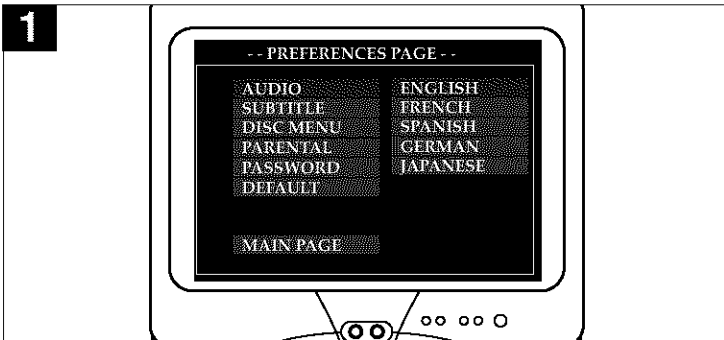

Select the language the DVD will be played back in (ENGLISH, FRENCH, SPANISH, GERMAN, JAPANESE). The DVD must be recorded in the selected language, otherwise the default language of the DVD will be played.

SUBTITLE

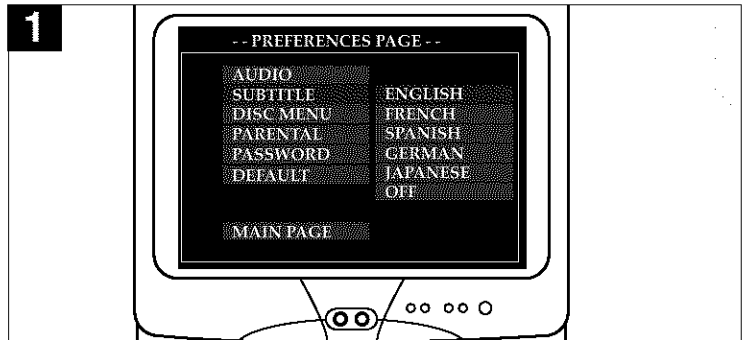

Select the language the Subtitle (OSD) will be in (ENGLISH, FRENCH, SPANISH, GERMAN, JAPANESE, OFF). The DVD must be recorded in the selected language, otherwise the default language of the DVD will be shown.

DISC MENU

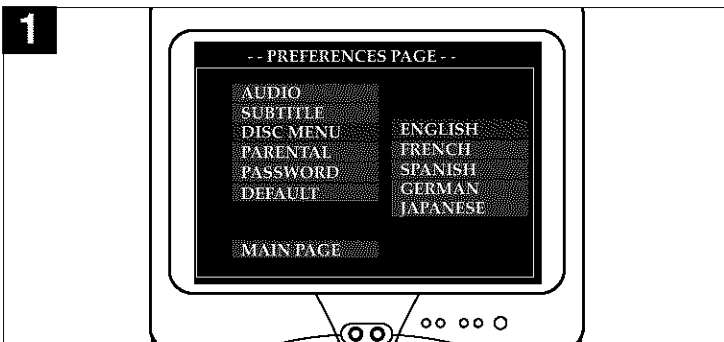

Select the language the DISC MENU will be in (ENGLISH, FRENCH, SPANISH, GERMAN, JAPANESE). The DVD's DISC MENU must be made in the selected language, otherwise the default language of the DVD will be shown.

DEFAULT

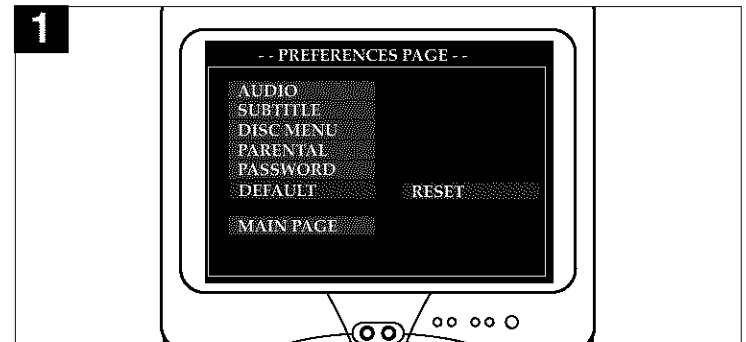

Select this option to reset all the preferences (except PASSWORD) to their original factory settings. This is useful to reset the NTSC System.

SETUP MENU (CONTINUED)

PARENTAL

The Parental option enables parents to prevent their children from watching inappropriate material on a DVD. It reads the ratings for programming, then denies access to programming if the program's rating meets the limitations you select. In this case, the user will have to enter a password.

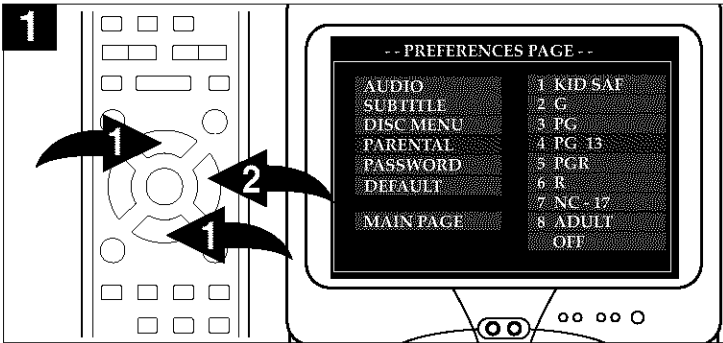

At the PREFERENCES MENU, use the Navigation (▲, ▼) buttons ❶ to select PARENTAL. Press the ► button ❷ followed by the Navigation (▲, ▼) buttons ❶ to select the desired rating.

1 (KID SAF): Kid Safe.	6 (R): Under 17 years old, Parental Guidance strongly suggested.
2 (G): All ages.	7 (NC17): 17 years old and above.
3 (PG): Parental Guidance.	8 (ADULT): Adult only.
4 (PG13): Parental Guidance less than 13 years old.	OFF: Parental Off
5 (PGR): Under 17 years old, Parental Guidance suggested.	

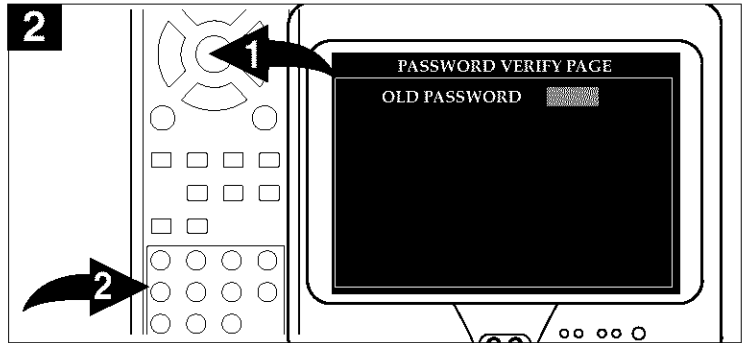

Press the ENTER button ❶ to select the rating. Input your password using the Number buttons ❷ (see note below), then press the ENTER button ❶ again. The desired rating will then be set, and if DVDs with this new rating or above are played, the user will require a password.

If an incorrect password is entered, access will not be allowed.

If you forget your password, contact customer service at the number listed in the Warranty.

NOTE: The default password is 1234.

PASSWORD

Select this option to change the password. You must know the old password in order to change it. If you have forgotten the password, call customer service at the number listed in the Warranty.

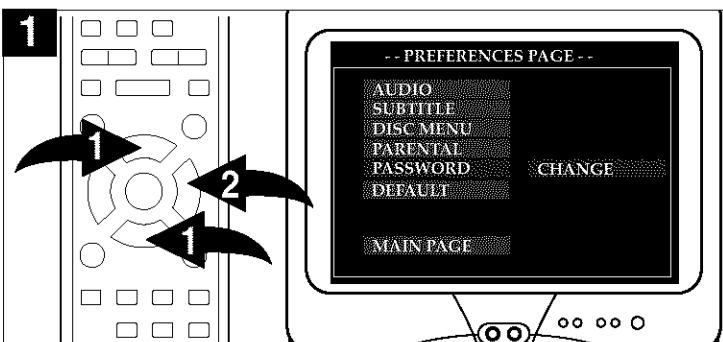

At the PREFERENCES MENU, use the Navigation (▲, ▼) buttons ❶ to select PASSWORD. Press the ► button ❷ to select CHANGE.

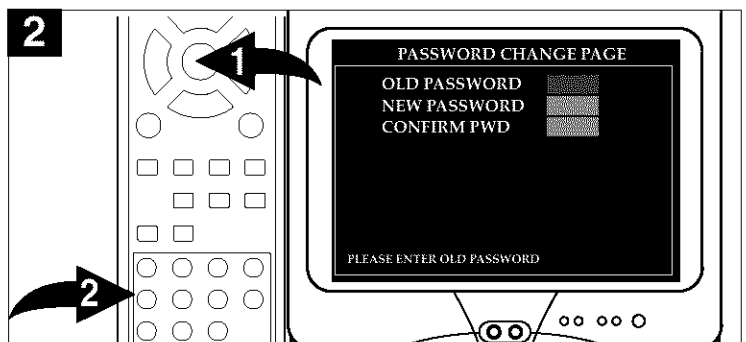

Press the ENTER button ❶ to change the password. Input your old password (see note above), then the new password and then confirm the new password using the Number buttons ❷, then press the ENTER button ❶ again. The desired new password will then be set, be sure to write it down for future reference.

BASIC OPERATION (GENERAL)

IMPORTANT:

When “” appears while pressing a button, this means that the corresponding function cannot be performed either on the disc inserted, or in the selected mode.

AUDIO MODE (AUDIO CD/VCD/MP3 ONLY)

While playing an audio CD (not a DVD), you can cycle between the audio modes as follows:

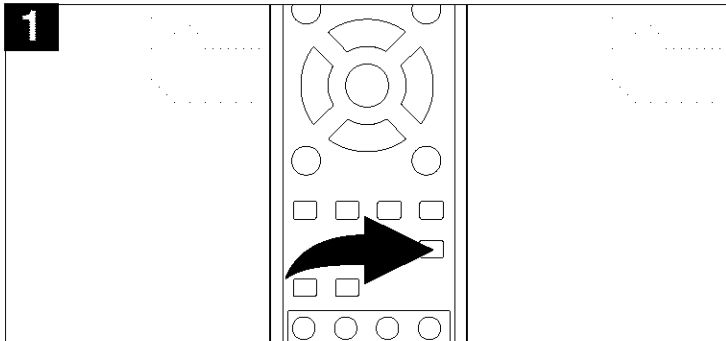

Press the AUDIO MODE button to cycle through the audio modes. The audio modes vary depending on the disc inserted, but include MONO LEFT, MONO RIGHT, MIX-MONO and STEREO.

“” will appear if the disc does not support audio mode changing.

MUTE

Press the MUTE button once to mute the sound, “MUTE” will appear on the TV screen. Press the MUTE button again to restore the sound; “MUTE OFF” will appear briefly on the TV screen.

DISPLAY

Each press of the DISPLAY button will display the elapsed time and remaining time of a playing disc. Each press of the DISPLAY button will cycle through, depending on the playback mode as follows:

	DVD	CD/VCD	MP3
1st press	Title Elapsed Time	Track Elapsed Time	Track Elapsed Time
2nd press	Title Remaining Time	Track Remaining Time	Track Remaining Time
3rd press	Chapter Elapsed Time	Total Elapsed Time	Off
4th press	Chapter Remaining Time	Total Remaining Time	
5th press	Off	Off	

NOTE: For VCD, if the PBC is on, the Total Elapsed Time and Total Remaining Time will not be available

DVD BASIC OPERATION

IMPORTANT NOTES:

- After plugging in, the unit will be in the Standby mode (the Standby indicator will be lit). Press the STANDBY ON/OFF button on the main unit or the remote to turn on the unit.
- “” will appear on the TV screen during operation if you try to access a function that is not available on the disc.
- Some discs may take a few seconds to load.
- If a disc is inserted incorrectly, is dirty and/or damaged, or is not present at all, “NO DISC” will appear in the display.
- Always hold the disc without touching either of its surfaces. When inserting a disc, position it with the printed title side facing up, align it with the guides and place it in its proper position.
- It is important that you read the manual that accompanies the DVD disc as there are features that are on this DVD player that cannot be used with certain DVDs. There are also extra features that are different for each DVD disc, so they are not explained in this owner’s manual.

PLAYBACK OF A DVD

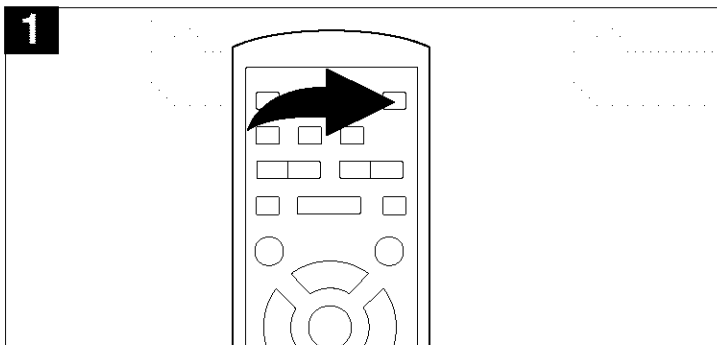

Press the STANDBY ON/OFF button to turn on the unit; the STANDBY indicator will go out and the POWER ON indicator will light.

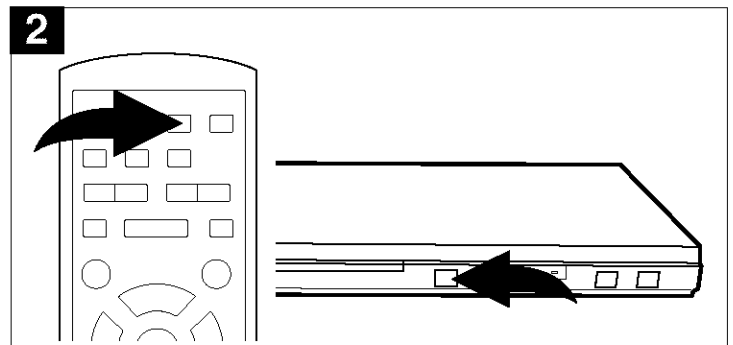

Press the OPEN/CLOSE button to open the disc tray, “OPEN” will appear on the screen. Insert a disc with the label side facing up on the disc tray.

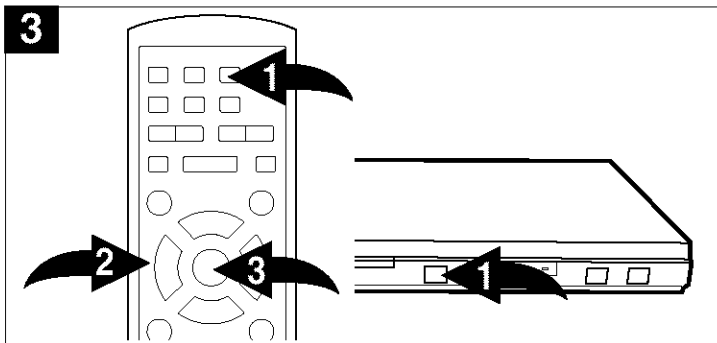

Press the OPEN/CLOSE button ❶ to close the disc tray. “CLOSE” will appear on the screen. After loading, “DVD VIDEO” will appear on the screen and the menu screen of the DVD should appear. Use the Navigation (◀, ▶, ▲, ▼) buttons ❷ to select the desired option and ENTER button ❸ to select it.
If the password is set and the inserted disc is within the Parental Ratings set, then the Password screen will appear, prompting you to enter the password.

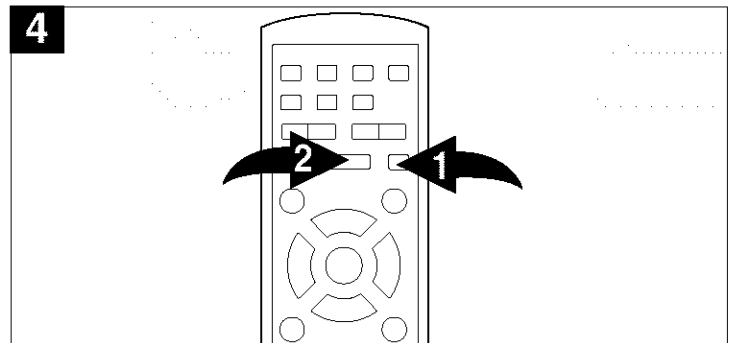

To stop playback, press the Stop (■) button ❶; “PRESS PLAY KEY TO CONTINUE” will appear on the TV screen. Because the unit will remember where you stopped, simply press the Play (▶) button ❷ to resume playback where you left off (resuming playback).
If the Stop (■) button ❶ is pressed twice, the unit will stop completely.

NOTES:

- If a MENU appears on the TV screen, press the Navigation (◀, ▶, ▲, ▼) buttons to select the desired option/item, then press the ENTER button. Please make sure to refer to the disc’s jacket or case for additional information.
- Resuming playback may not work on all discs.

DVD BASIC OPERATION (CONTINUED)

SKIP

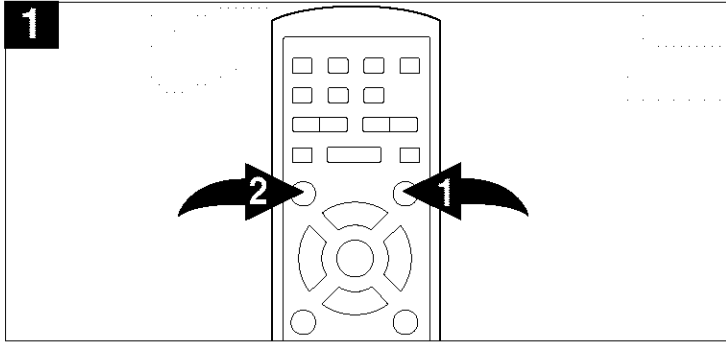

Press the Skip (▶▶) button ❶ to advance the DVD to the beginning of the next chapter.

Press the Skip (◀◀) button ❷ to move the DVD to the beginning of the previous chapter.

SEARCH

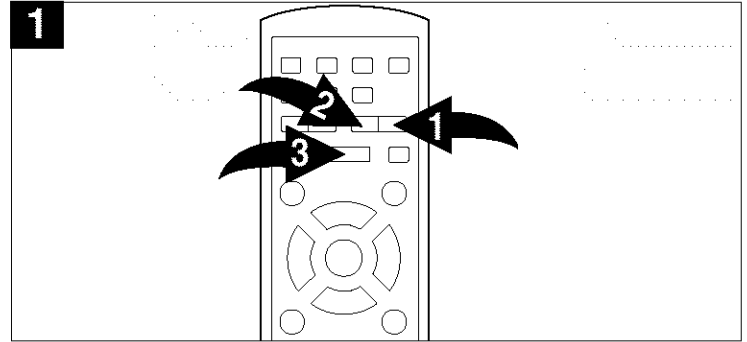

During playback, press either the Search ▶▶ ❶ or Search ◀◀ ❷ button to move the DVD forward or backward at double (x2) speed to locate a specific section. Repeatedly press these buttons and the speed will increase to x4, x8, x16 and resume normal playback. You can also resume normal playback by pressing the PLAY (▶) button ❸.

SLOW/R AND SLOW/F

Use this feature to move the DVD in slow motion.

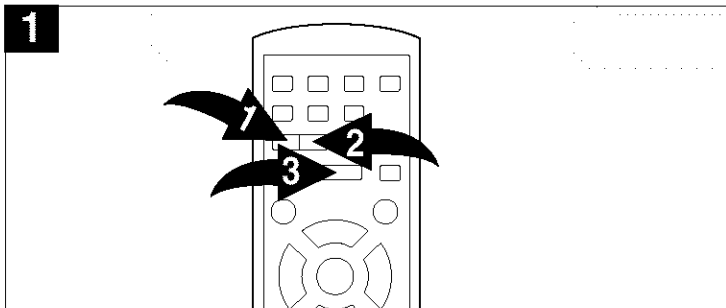

During playback, press either the SLOW/R ❶ or SLOW/F ❷ button to move the DVD forward or backward in slow motion speeds of 1/2, 1/4, 1/8, 1/16 and resume normal playback. The sound will be muted.

You can also resume normal playback by pressing the PLAY (▶) button ❸.

PAUSE/STEP

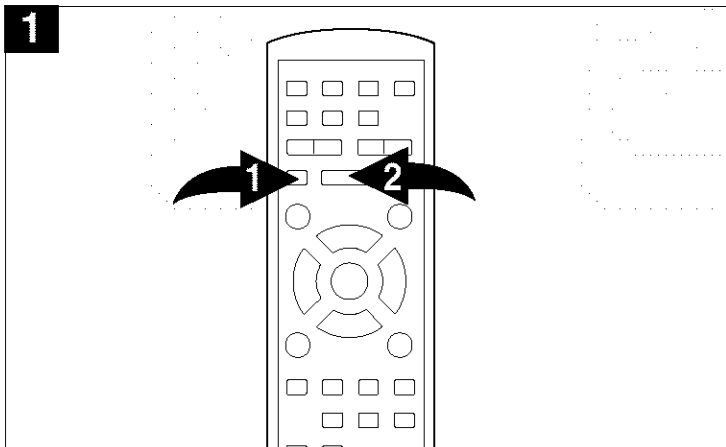

Press the PAUSE/STEP button ❶ once to pause the picture.

Repeatedly press the PAUSE/STEP button ❶ to play the DVD one frame at a time.

Press the PLAY (▶) button ❷ to resume normal playback.

If the Screen Saver option (page 15) is set to ON, the screen saver will appear in approximately one minute.

DVD BASIC OPERATION (CONTINUED)

TITLE/CHAPTER SEARCH

Use this feature to directly go to a specific title and/or chapter.

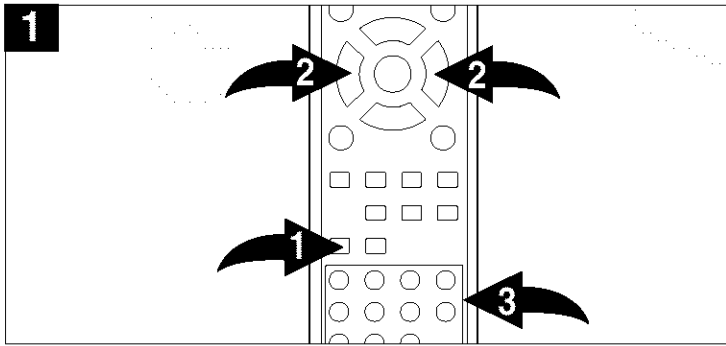

Press the SEARCH button ❶ once. Press the Navigation (◀, ▶) buttons ❷ to select the Title, then use the Number buttons ❸ to select the desired title number (i.e. for number 5, press “0”, “5”). Playback will start immediately.

OR

Press the Navigation (◀, ▶) buttons ❷ to select the Chapter, then use the Number buttons ❸ to select the desired chapter number (i.e. for number 2, press “0”, “2”). Playback will start immediately.

TITLE/TIME SEARCH

Use this feature to directly go to a specific title and/or time.

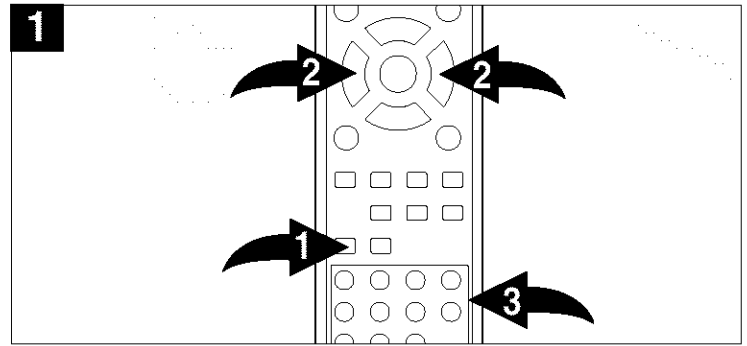

Press the SEARCH button ❶ twice. Press the Navigation (◀, ▶) buttons ❷ to select the Title, then use the Number buttons ❸ to select the desired title number (i.e. for number 5, press “0”, “5”). Playback will start immediately.

OR

Press the Navigation (◀, ▶) buttons ❷ to select the Time, then use the Number buttons ❸ to select the desired time (Hour/Minutes/Seconds); playback will start immediately.

REPEAT PLAYBACK

While playing back a DVD, this unit can repeatedly play back a chapter or title.

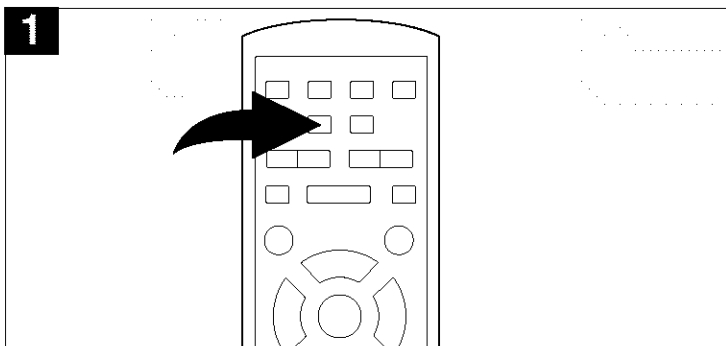

While in the Playback mode, press the REPEAT button once; “⏮ CHAPTER” will appear briefly on the TV screen and the currently playing Chapter will repeat continuously. While in the Playback mode, press the REPEAT button a second time; “⏮ TITLE” will appear briefly on the TV screen and the currently playing Title will repeat continuously. Press the REPEAT button once more to cancel Repeat mode; the Repeat indicator will disappear on the screen.

A-B REPEAT PLAYBACK

While playing back a DVD, this unit can repeatedly play back a specific section.

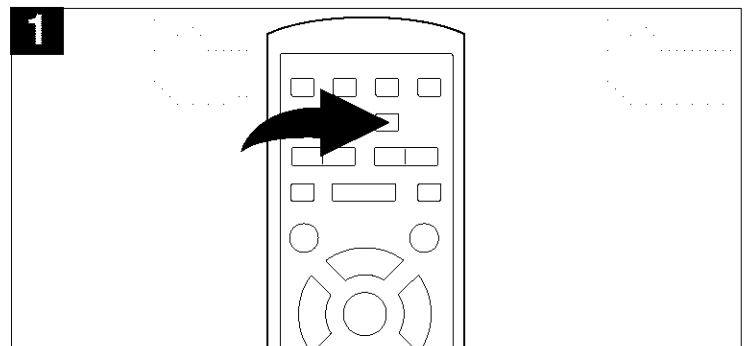

While in the Playback mode, press the Repeat A-B button to define where you want the section to start. Press the Repeat A-B button again to define where you would like the section to end, the unit will then play the selected area continuously. Press the Repeat A-B button again to cancel A-B Repeat mode.

NOTE:

- If you enter a time that exceeds the time limit of the DVD, then “⏮” will appear, and you must try again.
- Repeat may not work properly with some discs.

DVD BASIC OPERATION (CONTINUED)

AUDIO MENU

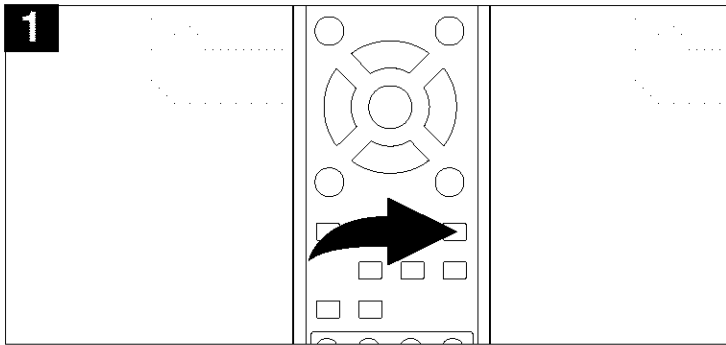

Press the AUDIO MENU button repeatedly to change the audio language. This feature is not available on all discs.

SUBTITLE MENU

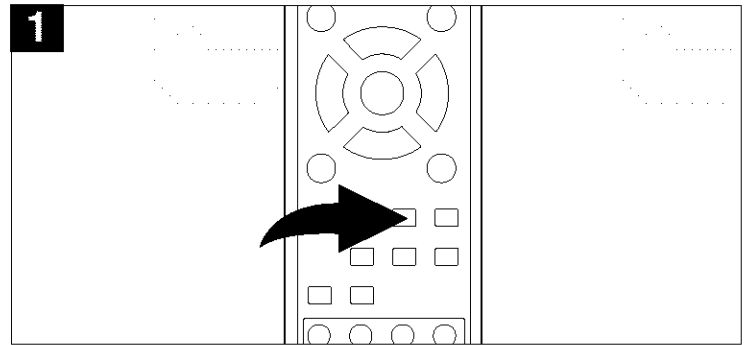

Press the SUBTITLE MENU button repeatedly to select a subtitle language, and to turn the subtitle menu on/off. This feature is not available on all discs.

DVD MENU

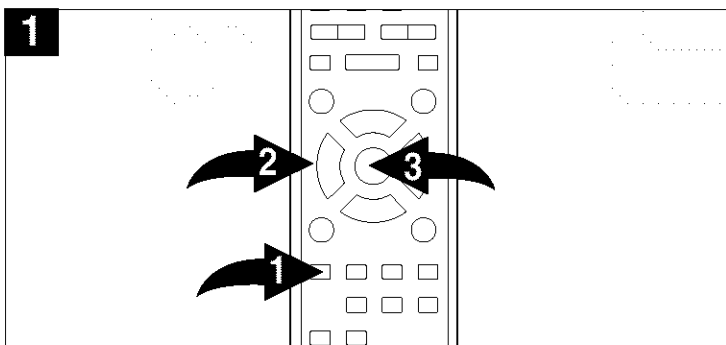

Press the DVD MENU button ❶, and the Main Menu of the disc will appear. Use the Navigation (◀, ▶, ▲, ▼) buttons ❷ to select the desired option, and then press the ENTER button ❸.

This is not available on all discs.

TITLE MENU

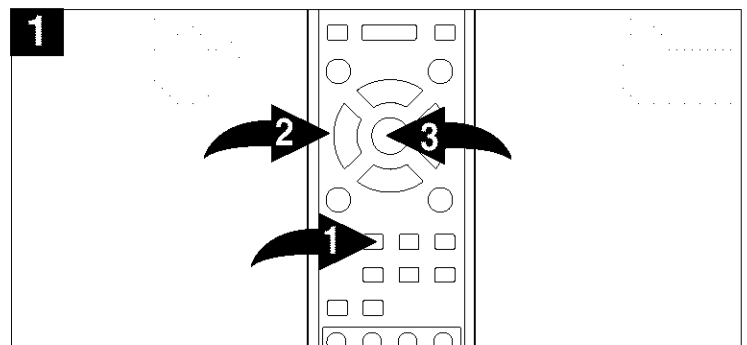

Press the TITLE MENU button ❶, and the Title Menu of the disc will appear. Use the Navigation (◀, ▶, ▲, ▼) buttons ❷ to select the desired option, and then press the ENTER button ❸.

This is not available on all discs.

ZOOM

The image on the screen can be magnified as follows:

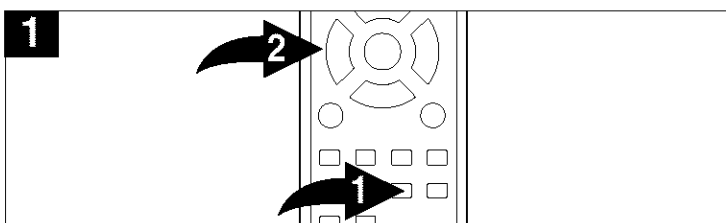

Press the ZOOM button ❶ once during Normal, Slow or Still playback modes, and the unit will zoom x2. Press once or twice more and the unit will zoom x3/x4. Use the Navigation (◀, ▶, ▲, ▼) buttons ❷ to move the image on the TV screen.

This is not available on all discs. Press the ZOOM button ❶ once more to cancel the zoom function.

This is not available on all discs.

ANGLE

Some discs may contain scenes which have been shot simultaneously from a number of different camera angles. This feature only works on discs with more than one camera angle. The jacket will be marked with "ⓐ".

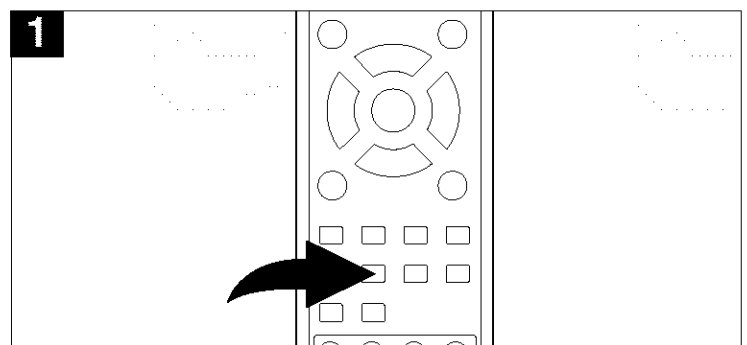

While in the Playback mode, press the ANGLE button; the total number of angles will appear on the screen. Repeatedly press the ANGLE button to select the desired angle; the angle will change in one to two seconds.

This is not available on all discs.

MP3 BASIC OPERATION

PLAYBACK OF AN MP3 CD

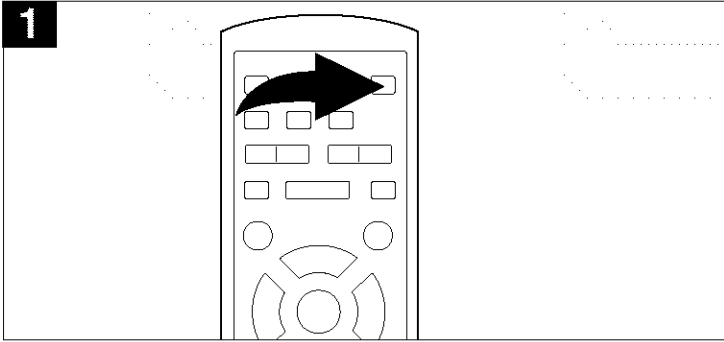

Press the STANDBY ON/OFF button to turn on the unit; the STANDBY indicator will go out and the POWER ON indicator will light.

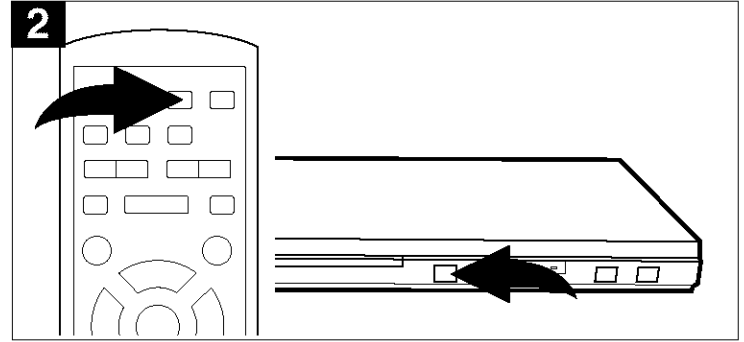

Press the OPEN/CLOSE button to open the disc tray, "OPEN" will appear on the screen. Insert an MP3 disc with the label side facing up on the disc tray.

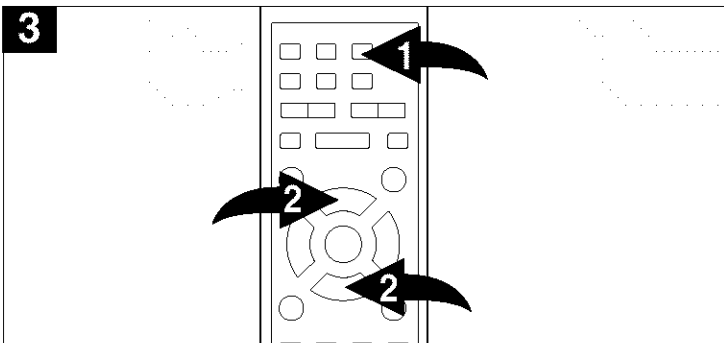

Press the OPEN/CLOSE button ❶ to close the disc tray. "CLOSE" will appear on the screen and the display. After loading, the FOLDER/TRACK menu will appear on the TV screen. Press the NAVIGATION (▲, ▼) button ❷ to select the desired folder/file.

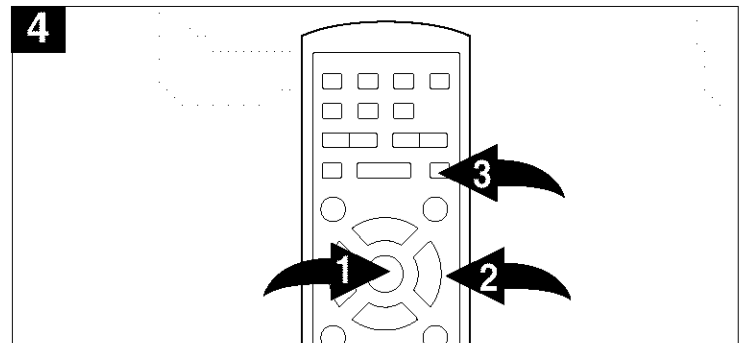

Press the ENTER button ❶ to confirm. If there are no folders on the CD, playback will begin immediately. If there are folders, then pressing the ENTER button ❶ will bring up the tracks in the right column. Press the Navigation (▶) button ❷ followed by the Navigation (▲, ▼) buttons ❸ to select the desired track, then press the ENTER button ❶ to play the track. Press the STOP (■) button ❹ to stop playback. To return to select another folder, while in the Stop mode, press the Navigation (◀) button ❸, then press the ENTER button ❶. The FOLDER/TRACK menu will appear again on the TV screen.

MP3 BASIC OPERATION (CONTINUED)

SELECTING FOLDERS/TRACKS USING THE SKIP (▶▶) OR (◀◀) BUTTON

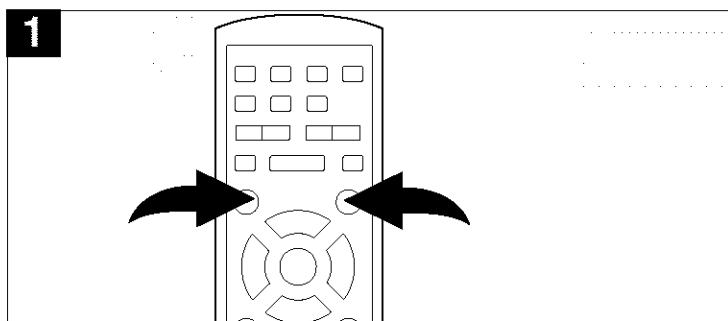

During playback, simply press the (▶▶) or (◀◀) button to select a track to be played.

SELECTING FOLDERS/TRACKS USING THE NUMBER BUTTONS

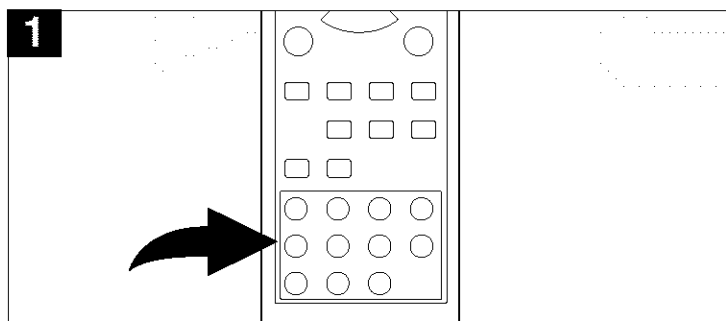

During playback, press the Number buttons corresponding to the track numbers to select your desired track, and the unit will playback the desired track automatically.

FORWARD ▶▶ / REVERSE ◀◀

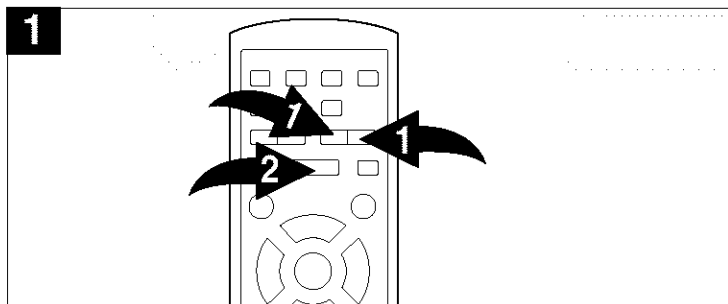

Each press of the SEARCH ▶▶ or ◀◀ button ❶ will increase the search as follows:

- 1st press: x 2
- 2nd press: x 4
- 3rd press: x 8
- 4th press: x 16
- 5th press: Resume Normal Playback

Press the PLAY (▶) button ❷ to resume normal playback.

REPEAT PLAY

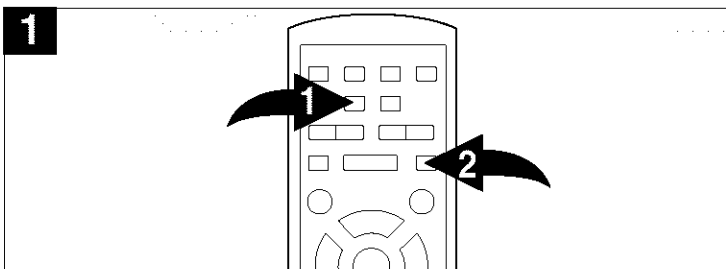

To Repeat play a track/file, simply select the track/file as described on the previous page, then press the REPEAT button ❶ once; "REPEAT ONE" will appear on the TV screen and the unit will repeat the selected track/file continuously until the STOP button ❷ is pressed.

To repeat the playing track's folder on an MP3 CD, simply select the track/file as described on the previous page. Then, press the REPEAT button ❶ a second time; "REPEAT FOLDER" will appear on the TV screen and the unit will repeat the tracks/files inside the folder continuously until the STOP ❷ is pressed.

To cancel Repeat play, press the REPEAT button ❶ until "FOLDER" appears on the TV screen.

MP3 FAQs (Frequently Asked Questions)

Please read before playing an MP3 CD.

What is an MP3 file?

An MP3 file is a computer format that makes a usually large music file into a smaller one which is more convenient to download and share.

Can I record my own MP3 CDs?

Yes, but you need a CD recorder, which is available from you local computer store.

Where can I find MP3 files?

MP3 files are available on the internet.

Can this unit read regular music CDs?

Yes it can. However, you cannot mix MP3s and WAV files on the same CD. If you do this, the unit will play only the MP3 files.

Can I use the MP3 extension for non-audio data files?

No, this may result in serious malfunction and harmful noise interference.

Can I mix MP3 files with other file types on the CDR?

Yes, but the unit will ignore those files and read only the MP3 files on the CDR.

Does this unit support subdirectories (subfolders)?

Yes, it can read MP3 files from subfolders.

CD/VCD BASIC OPERATION

PLAYBACK OF A CD/VCD

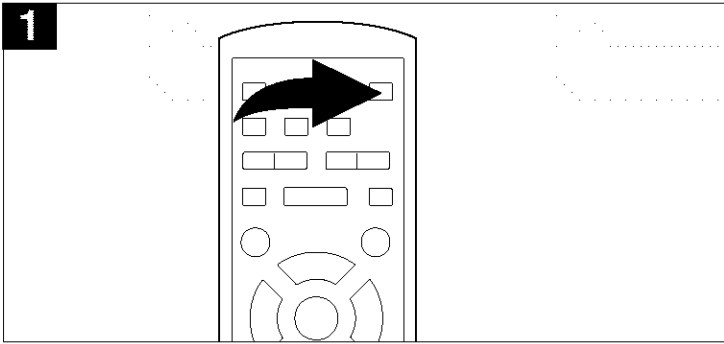

Press the STANDBY ON/OFF button to turn on the unit; the STANDBY indicator will go out and the POWER ON indicator will light.

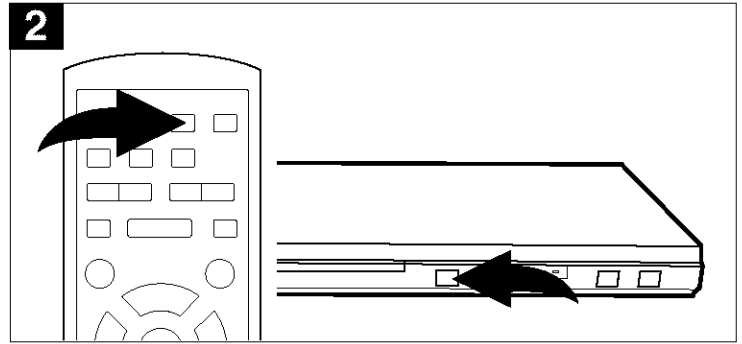

Press the OPEN/CLOSE button to open the disc tray, "OPEN" will appear on the screen. Insert a disc with the label side facing up on the disc tray.

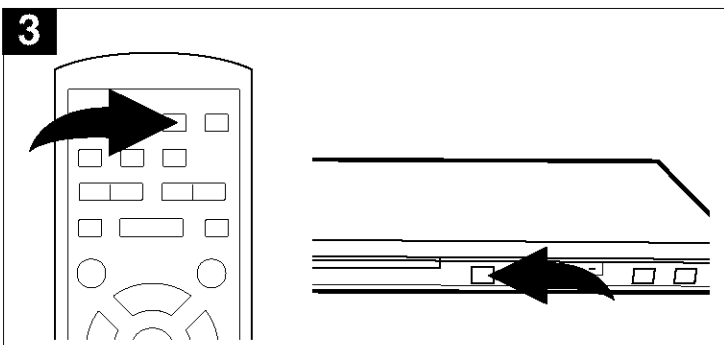

Press the OPEN/CLOSE button to close the disc tray. "CLOSE" will appear on the screen. After loading, playback will start automatically.

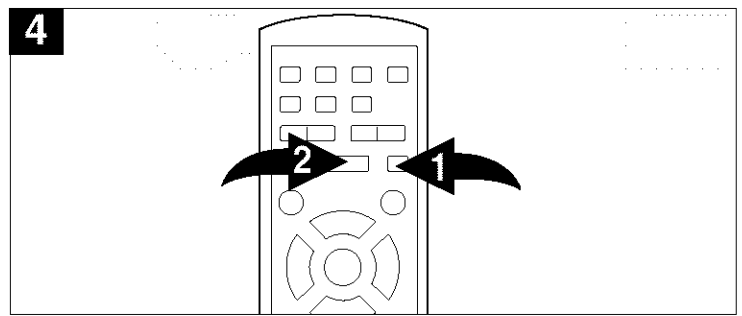

To stop playback, press the Stop (■) button ❶; "PRESS PLAY TO CONTINUE" will appear on the TV screen. Because the unit will remember where you stopped, simply press the Play (▶) button ❷ to resume playback where you left off (resuming playback). If the Stop (■) button ❶ is pressed twice, the unit will stop completely.

SELECTING TRACKS/FILES USING THE NUMBER BUTTONS

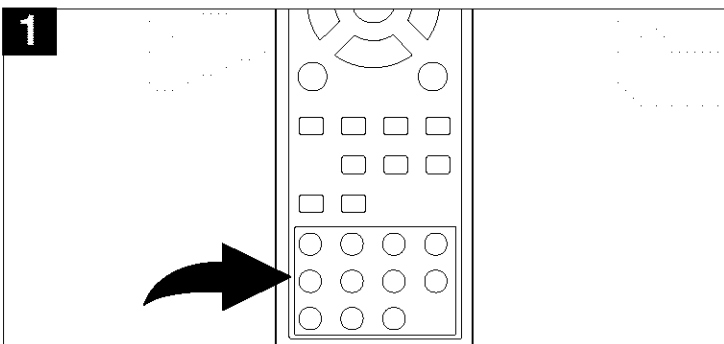

Press the number buttons corresponding to the track number you would like to play, and the unit will playback the desired track automatically.

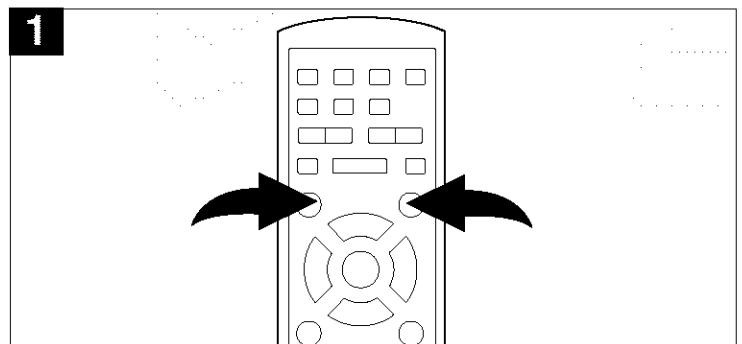

During playback, press the Skip (▶▶) or (◀◀) button to select a track to be played.

CD/VCD BASIC OPERATION (CONTINUED)

FORWARD ►►/REVERSE ◀◀

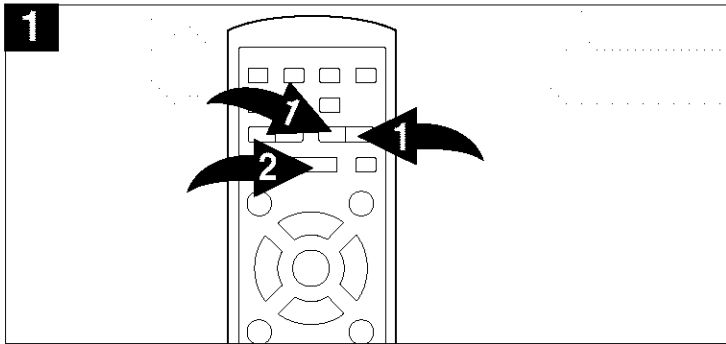

Each press of the SEARCH ►► or ◀◀ button ❶ will increase the search as follows:

- 1st press: x 2
- 2nd press: x 4
- 3rd press: x 8
- 4th press: x 16
- 5th press: Resume Normal Playback

Press the PLAY (►) button ❷ to resume normal playback.

NOTE: Reverse Search (◀◀) is not available during playback of a VCD.

REPEAT ONE/ALL PLAY

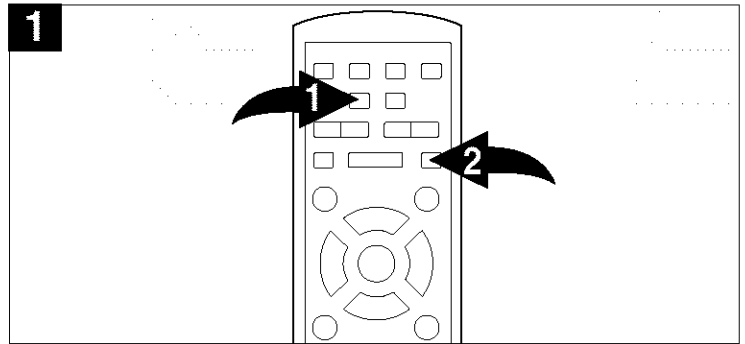

To Repeat play a track, simply select the track as described on the previous page, then press the REPEAT button ❶ once; "⏮ TRACK" will appear on the TV screen and the unit will repeat the selected track continuously until the STOP (■) button ❸ is pressed.

To Repeat play all tracks on a CD, press the REPEAT button ❶ a second time; "⏮ ALL" will appear on the TV screen and the unit will repeat the CD continuously until the STOP (■) button ❸ is pressed.

To cancel Repeat play, press the REPEAT button ❶ until the REPEAT indicators disappears on the TV screen.

IMPORTANT NOTE ON VCD REPEAT PLAYBACK:

PBC must be Off to use repeat playback with VCDs.

REPEAT A-B PLAY

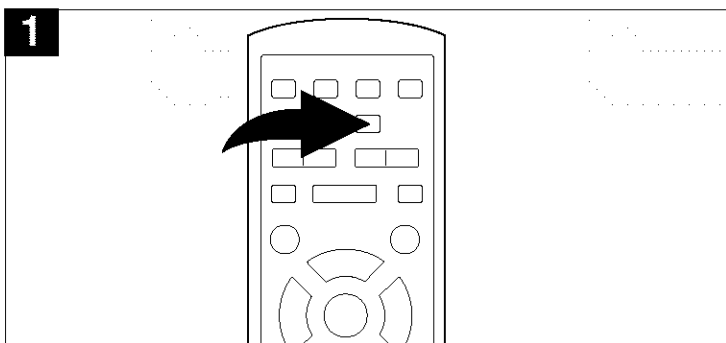

While playing back a CD, this unit can repeatedly play back a specific section.

While in the Playback mode, press the Repeat A-B button to define where you want the section to start. Press the Repeat A-B button again to define where you would like the section to end, the unit will then play the selected area continuously.

Press the A-B button again to cancel Repeat A-B Repeat mode.

RANDOM PLAYBACK

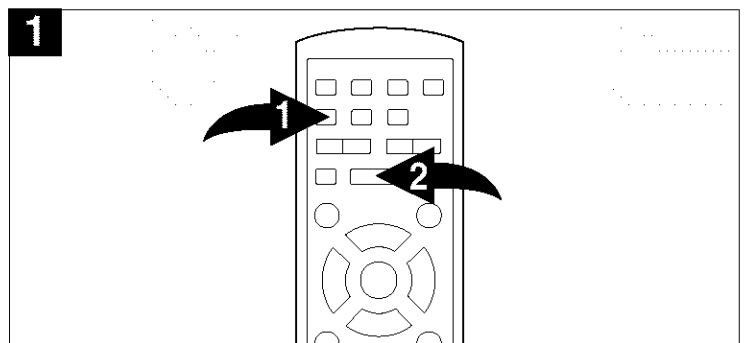

Press the RANDOM button ❶ once and "RANDOM" will appear on the TV screen. Press the PLAY (►) button ❷ and the unit will randomly play all the tracks on the CD until all the tracks have been played or the STOP (■) button ❸ is pressed. To cancel Random, press the RANDOM button ❶ until "RANDOM" disappears on the TV screen.

PBC (VCD ONLY)

When playing a VCD with PBC function, you can enjoy simple interactive software on your TV.

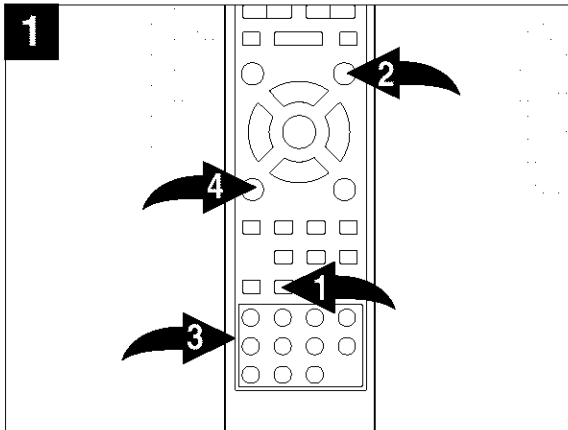

The PBC Function will activate automatically if the VCD has this function. To turn off the PBC, press the PBC button ❶ once.

Press the Skip (▶▶) button ❷ to go to the Track Selection Menu. THE VCD MUST HAVE THIS MENU.

Press the Number buttons ❸ to select the desired track to play. Press the RETURN button ❹ to return to the Track Selection Menu.

Follow the instructions supplied with the disc as the operating procedure may differ according to the VCD.

PICTURE CD BASIC OPERATION

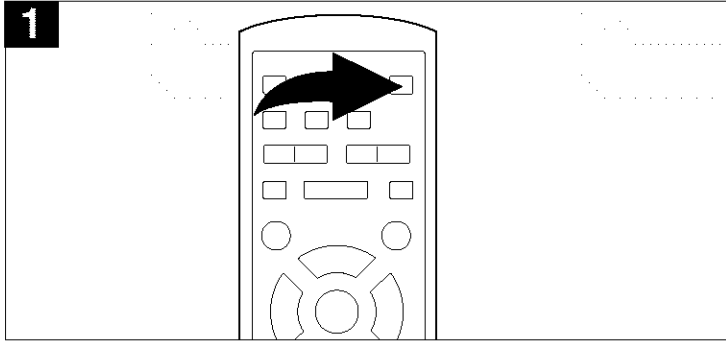

Press the STANDBY ON/OFF button to turn on the unit; the STANDBY indicator will go out and the POWER ON indicator will light.

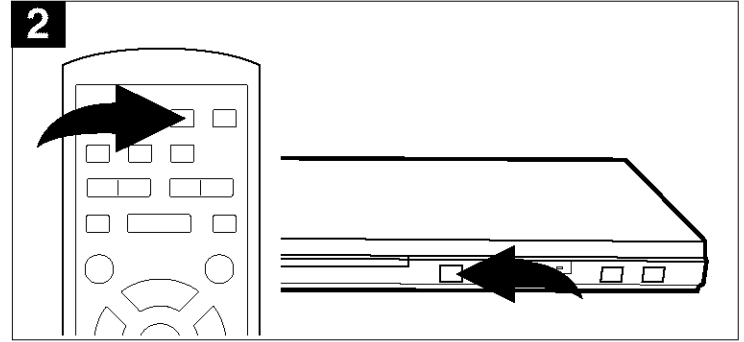

Press the OPEN/CLOSE button to open the disc tray, "OPEN" will appear on the screen. Insert a picture disc with the label side facing up on the disc tray.

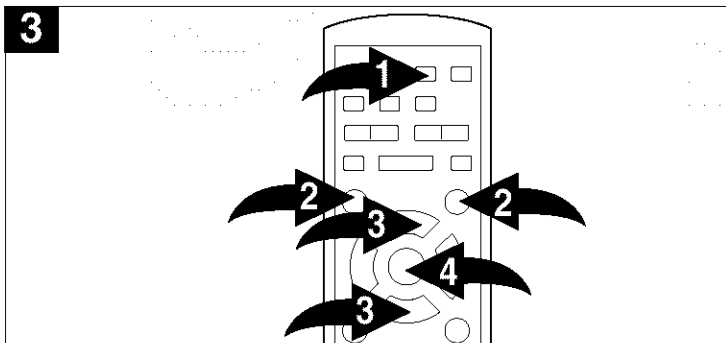

Press the OPEN/CLOSE button ❶ to close the disc tray. "LOADING" will appear on the TV screen. After loading, the picture will automatically show on the TV screen. Press the Skip (▶▶) or (◀◀) button ❷ to select a picture.

The unit will playback all the pictures on the disc, then the last picture will remain on the TV screen. If the screen saver option is set to on, the screen saver will turn on in about one minute.

TO STOP PICTURE CD FUNCTION: To stop playback of the picture CD, press the STOP (■) button.

TROUBLESHOOTING GUIDE

Check the following before requesting service:

SYMPTOM	POSSIBLE CAUSE	POSSIBLE SOLUTION
GENERAL		
No power.	AC cord unplugged.	Plug in the AC cord to an AC outlet.
Power on, but unit not functioning properly.	Condensation has formed.	Unplug the unit and wait about one to two hours to allow the player to dry.
	Wrong type of CD inserted.	This unit cannot play discs, other than DVD, VCD, MP3 or standard CDs.
	Unit needs to be reset.	Press the STANDBY button, then unplug the power cord. Wait one minute and then plug the unit back in.
	The disc is dirty or inserted incorrectly.	Clean disc and insert label side-up.
	Some features and functions are not available on all discs.	This is normal, try another function.
No picture.	The equipment is not connected properly.	Connect the equipment according to the instructions in this manual.
	The INPUT of the TV is not set to receive the DVD signal output.	Select the appropriate video input mode, usually VIDEO or AV.
	The video cables are not securely connected.	Connect the video cables securely.
	Progressive Scan switch is set to ON.	Set switch to OFF, see bottom of next page.
	The connected TV power is off.	Turn the TV on.
No sound.	The equipment is not connected properly.	Connect the equipment according to the instructions in this manual.
	The equipment connected with the audio cable is not set to receive the DVD signal input.	Select the appropriate audio input mode.
	The audio cables are not securely connected.	Connect the audio cables securely.
	The connected receiver's power is off.	Turn the audio receiver on.
Playback picture rolls.	Unit needs to be reset to NTSC.	Turn unit off and then back on to auto set it.
The playback picture is poor.	The disc is dirty.	Clean the disc.
The Search feature is not working.	Some discs have sections that do not allow searching.	This is normal on some discs.
The picture is not fitting properly.	Wrong menu option is selected in the SETUP MENU.	Select the correct TV type (PS, LB, WIDE) which matches the TV you are using.
The remote control is not working.	The batteries are weak or dead.	Install fresh batteries.
	The batteries are not installed properly.	Install batteries according to the diagram.
	The remote is not aimed at the sensor.	Aim the remote at the sensor.
	Distance is too far or there is too much light in the room.	Operate within 20ft, or reduce the light in the room.
	There is an obstacle in the path of the beam.	Move the obstacle.
The PREFERENCES menu cannot be accessed (it is dimmed) in the SETUP MENU.	There is a CD in the disc tray.	Remove the disc from the disc tray, as there cannot be any disc inserted when setting the preferences.

TROUBLESHOOTING GUIDE (CONTINUED)

SYMPTOM	POSSIBLE CAUSE	POSSIBLE SOLUTION
DVD		
The unit does not start playback.	Rating level set to block the DVD.	Enter your password, and/or change the rating level.
	DVD not inserted, or inserted upside-down.	Insert DVD correctly.
	A non-playback disc is inserted.	Make sure to insert a DVD; "DVD VIDEO" will appear in the display.
	The disc is not placed in the guide.	Place the disc on the disc tray correctly inside the guide.
	The disc is dirty.	Clean the disc.
Some functions do not operate as stated.	Some features and functions are not available on all discs.	This is normal, try another function.
Selected language is not being shown in the subtitles, or spoken.	If the audio or subtitle language does not appear on the disc, then the initial setting will not be seen/heard.	This is normal, try another disc.
Subtitles are not working properly.	Subtitles appear only when the discs contain them.	This is normal, try another disc.
	Subtitles not turned on.	Turn the subtitles on.
Angle cannot be changed.	Angles may not be recorded on the disc (see disc jacket/case), or they may only be recorded on certain scenes.	Try another disc, or wait for a scene which allows a different camera angle.
The Rating Level password has been forgotten.	Call the number listed on the warranty to get the information to reset the password.	After receiving the information, reset the password and write it down.
VCD (VIDEO CD)		
No menu playback.	The VCD inserted does not have the playback control.	Try another VCD.
PROGRESSIVE SCAN		
No picture.	If you connect a TV that is not compatible with a progressive scan signal and set the PROGRESSIVE SCAN switch to 'ON', you will not be able to see any picture.	Slide the PROGRESSIVE SCAN switch to the OFF position if you set is not compatible, then turn the unit off and back on again; the picture should reappear.

**FOR ADDITIONAL SET-UP OR OPERATING ASSISTANCE, PLEASE VISIT OUR WEBSITE AT
WWW.MEMOREXELECTRONICS.COM OR CONTACT CUSTOMER SERVICE AT
1-800-919-3647**

**PLEASE KEEP ALL PACKAGING MATERIAL FOR AT LEAST 90 DAYS IN CASE YOU NEED TO RETURN
THIS PRODUCT TO YOUR PLACE OF PURCHASE OR MEMOREX.**

FOR PARTS AND ACCESSORIES, CONTACT FOX INTERNATIONAL AT 1-800-321-6993.

CARE AND MAINTENANCE

Caring for Discs

- Treat the disc carefully. Handle the disc only by its edges. Never allow your fingers to come in contact with the shiny, unprinted side of the disc.

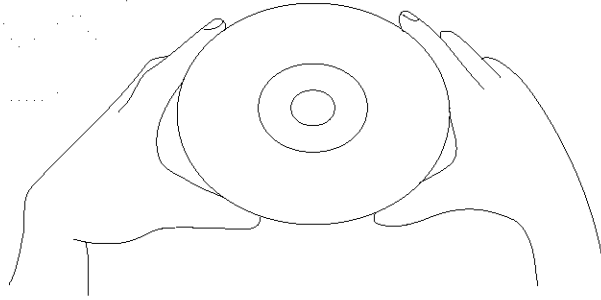

- Do not attach adhesive tape, stickers, etc. to the disc label.
- Clean the disc periodically with a soft, lint-free, dry cloth. Never use detergents or abrasive cleaners to clean the disc. If necessary, use a CD cleaning kit.
- If a disc skips or gets stuck on a section of the disc, it is probably dirty or damaged (scratched).
- When cleaning the disc, wipe in straight lines from the center of the disc to the outer edge of the disc. Never wipe in circular motions.

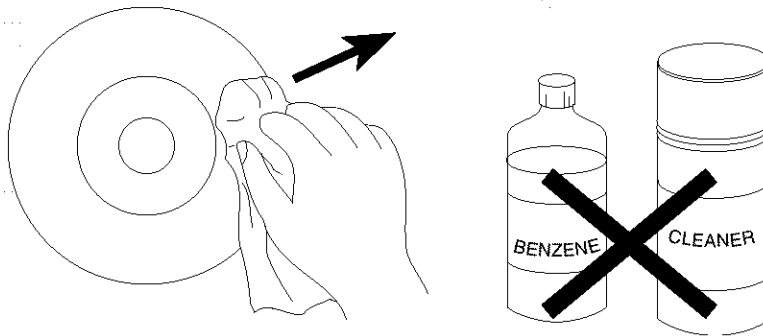

- Discs should be stored in their cases after each use to avoid damage.
- Do not expose discs to direct sunlight, high humidity, high temperatures or dust, etc. Prolonged exposure or extreme temperatures can warp the disc.
- Do not stick or write anything on either side of the disc. Sharp writing instruments, or the ink, may damage the surface.

Cleaning the Unit

- To prevent fire or shock hazard, disconnect your unit from the AC power source when cleaning.
- The finish on your unit may be cleaned with a dust cloth and cared for as other furniture. Use caution when cleaning and wiping the plastic parts.
- Mild soap and a damp cloth may be used on the front panel.

SPECIFICATIONS

Power Requirements.....	AC120V, 60Hz
Power Consumption.....	<15W (approx. 5W when set to Standby mode by remote)
Weight.....	3.2 Lbs
Dimensions.....	14-1/8 (L) x 8 (W) x 1-7/8 (H) inches
Weight and dimensions are approximate.	
Signal System	NTSC/PAL
Operating Temperature	+5° to +35°C
Operating Humidity Range.....	5% to 90% (no condensation)
Discs Played:	
DVD-VIDEO Disc	
12cm single-sided, single layer	
12cm single-sided, dual layer	
12cm double-sided, single layer	
8cm single-sided, single layer	
8cm single-sided, dual layer	
8cm double-sided, single layer	
COMPACT DISC (VIDEO CD)	
12cm disc	
8cm disc	
Video Output Level	1Vp-p
Audio Output Level.....	2Vrms (1KHz, 0dB)
Audio Signal Output Characteristics:	
Frequency Responses:	
DVD (Linear Audio).....	20Hz-20KHz (48KHz/96KHz sampling)
CD Audio	20Hz-20KHz
S/N Ratio.....	70dB
Wow and Flutter	Below Measurable Level
Pickup:	
Wavelength.....	655nm
Laser Power	Class 1
Specifications are subject to change without notice.	

Memcorp, Inc.
Weston, FL
Printed in Hong Kong

Visit our website at www.memorexelectronics.com