

Panasonic®

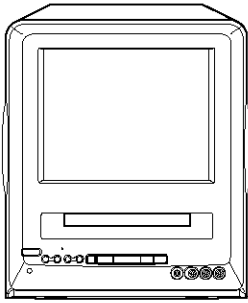

TV/DVD Combination Operating Instructions

Model No. **PV-9D53**



*Ability to play back may depend on recording conditions.



As an ENERGY STAR® Partner, Matsushita Electric Corporation of America has determined that this product or product model meets the ENERGY STAR® guidelines for energy efficiency.

Please read these instructions carefully before attempting to connect, operate, or adjust this product. Please save this manual.

Spanish Quick Use Guide is included.

(Guía para rápida consulta en español está incluida.)

TV/CATV MODE SELECTION

When shipped from the factory, the TV/CATV menu option is set to the "CATV." (Cable Television) mode. If not using CATV, set this menu option to the "TV" position.

For assistance, please call : 1-800-211-PANA(7262) or send e-mail to : consumerproducts@panasonic.com

	CAUTION RISK OF ELECTRIC SHOCK DO NOT OPEN	
CAUTION: TO REDUCE THE RISK OF ELECTRIC SHOCK, DO NOT REMOVE COVER (OR BACK). NO USER-SERVICEABLE PARTS INSIDE. REFER SERVICING TO QUALIFIED SERVICE PERSONNEL.		



The lightning flash with arrowhead symbol, within an equilateral triangle is intended to alert the user to the presence of uninsulated dangerous voltage within the product's enclosure that may be of sufficient magnitude to constitute a risk of electric shock.



The exclamation point within an equilateral triangle is intended to alert the user to the presence of important operating and maintenance (servicing) instructions in the literature accompanying the appliance.

WARNING: TO PREVENT FIRE OR SHOCK HAZARD, DO NOT EXPOSE THIS APPLIANCE TO RAIN OR MOISTURE.

WARNING: This equipment has been tested and found to comply with the limits for a Class B digital device, pursuant to Part 15 of the FCC Rules. These limits are designed to provide reasonable protection against harmful interference in a residential installation. This equipment generates, uses and can radiate radio frequency energy and, if not installed and used in accordance with the instructions, may cause harmful interference to radio communications. However, there is no guarantee that interference will not occur in a particular installation. If this equipment does cause harmful interference to radio or television reception, which can be determined by turning the equipment off and on, the user is encouraged to try to correct the interference by one or more of the following measures:

- Reorient or relocate the receiving antenna.
- Increase the separation between the equipment and receiver.
- Connect the equipment into an outlet on a circuit different from that to which the receiver is connected.
- Consult the dealer or an experienced radio/TV technician for help.

CAUTION: Changes or modifications not expressly approved by the party responsible for compliance with the FCC Rules could void the user's authority to operate this equipment.

CAUTION:
THIS DIGITAL VIDEO PLAYER EMPLOYS A LASER SYSTEM.

TO ENSURE PROPER USE OF THIS PRODUCT, PLEASE READ THIS OWNER'S MANUAL CAREFULLY AND RETAIN FOR FUTURE REFERENCE. SHOULD THE UNIT REQUIRE MAINTENANCE, CONTACT AN AUTHORIZED SERVICE LOCATION-SEE SERVICE PROCEDURE.

USE OF CONTROLS, ADJUSTMENTS OR THE PERFORMANCE OF PROCEDURES OTHER THAN THOSE SPECIFIED HEREIN MAY RESULT IN HAZARDOUS RADIATION EXPOSURE.

TO PREVENT DIRECT EXPOSURE TO LASER BEAM, DO NOT TRY TO OPEN THE ENCLOSURE. VISIBLE LASER RADIATION MAY BE PRESENT WHEN THE ENCLOSURE IS OPENED. DO NOT STARE INTO BEAM.

Location of the required Marking

The rating sheet and the safety caution are on the rear of the unit.

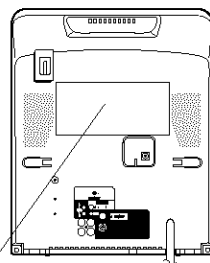

CERTIFICATION: COMPLIES WITH FDA RADIATION PERFORMANCE STANDARDS, 21 CFR SUBCHAPTER J.

IMPORTANT SAFEGUARDS

1. READ INSTRUCTIONS

All the safety and operating instructions should be read before the unit is operated.

2. RETAIN INSTRUCTIONS

The safety and operating instructions should be retained for future reference.

3. HEED WARNINGS

All warnings on the unit and in the operating instructions should be adhered to.

4. FOLLOW INSTRUCTIONS

All operating and use instructions should be followed.

5. CLEANING

Unplug this unit from the wall outlet before cleaning. Do not use liquid cleaners or aerosol cleaners.

Use a damp cloth for cleaning the exterior cabinet only.

6. ATTACHMENTS

The manufacturer of this unit does not make any recommendations for attachments, as they may cause hazards.

7. WATER AND MOISTURE

Do not use this unit near water. For example, near a bathtub, washbowl, kitchen sink, laundry tub, in a wet basement, or near a swimming pool.

8. ACCESSORIES

Do not place this unit on an unstable cart, stand, tripod, bracket, or table.

The unit may fall, causing serious injury, and serious damage to the unit.

- 8A. An appliance and cart combination should be moved with care. Quick stops, excessive force, and uneven surfaces may cause the appliance and cart combination to overturn.

9. VENTILATION

Slots and openings in the cabinet back or bottom are provided for ventilation, and to ensure reliable operation of the unit, and to protect it from overheating.

These openings must not be blocked or covered. The openings should never be blocked by placing the unit on a bed, sofa, rug, or other similar surface. This unit should never be placed near or over a radiator or heat source. This unit should not be placed in a built-in installations such as a bookcase or rack unless proper ventilation is provided or the manufacturer's instructions have been adhered to.

PORTABLE CART WARNING
(symbol provided by RETAC)



S3126A

10. POWER SOURCES

This unit should be operated only from the type of power source indicated on the rating plate. If you are not sure of the type of power supply to your home, consult your appliance dealer or local power company. For units intended to operate from battery power, or other sources, refer to the operating instructions.

11. GROUNDING OR POLARIZATION

This unit is equipped with a polarized alternating-current line plug (a plug having one blade wider than the other). This plug will fit into the power outlet only one way. This is a safety feature. If you are unable to insert the plug fully into the outlet, try reversing the plug. If the plug should still fail to fit, contact your electrician to replace your obsolete outlet. Do not defeat the safety purpose of the polarized plug, if your unit is equipped with a 3-wire grounding-type plug, a plug having a third (grounding) pin. This plug will only fit into a grounding-type power outlet. This too, is a safety feature. If you are unable to insert the plug into the outlet, contact your electrician to replace your obsolete outlet.

Do not defeat the safety purpose of the grounding-type plug.

IMPORTANT SAFEGUARDS

12. POWER-CORD PROTECTION

Power-supply cords should be routed so that they are not likely to be walked on or pinched by items placed upon or against them, paying particular attention to cords at plugs, convenience receptacles, and the point where they exit from the appliance.

13. LIGHTNING

To protect your unit from a lightning storm, or when it is left unattended and unused for long periods of time, unplug it from the wall outlet and disconnect the antenna or cable system. This will prevent damage to the unit due to lightning and power line surges.

14. POWER LINES

An outside antenna system should not be located in the vicinity of overhead power lines or other electric light or power circuits, or where it can fall into such power lines or circuits. When installing an outside antenna system, extreme care should be taken to keep from touching such power lines or circuits, as contact with them might be fatal.

15. OVERLOADING

Do not overload wall outlets and extension cords, as this can result in a risk of fire or electric shock.

16. OBJECT AND LIQUID ENTRY

Do not push objects through any openings in this unit, as they may touch dangerous voltage points or short out parts that could result in fire or electric shock. Never spill or spray any type of liquid into the unit.

17. OUTDOOR ANTENNA GROUNDING

If an outside antenna or cable system is connected to the unit, be sure the antenna or cable system is grounded to provide some protection against voltage surges and built-up static charges, Section 810 of the National Electrical Code, ANSI/NFPA 70, provides information with respect to proper grounding of the mast and supporting structure, grounding of the lead-in wire to an antenna discharge unit, size of grounding conductors, location of antenna discharge unit, connection to grounding electrodes, and requirements for the grounding electrode.

18. SERVICING

Do not attempt to service this unit yourself as opening or removing covers may expose you to dangerous voltage or other hazards. Refer all servicing to qualified service personnel.

19. DAMAGE REQUIRING SERVICE

Unplug this unit from the wall outlet and refer servicing to qualified service personnel under the following conditions:

- a. When the power-supply cord or plug is damaged.
- b. If liquid has been spilled, or objects have fallen into the unit.
- c. If the unit has been exposed to rain or water.
- d. If the unit does not operate normally by following the operating instructions. Adjust only those controls that are covered by the operating instructions, as an improper adjustment of other controls may result in damage and will often require extensive work by a qualified technician to restore the unit to its normal operation.
- e. If the unit has been dropped or the cabinet has been damaged.
- f. When the unit exhibits a distinct change in performance, this indicates a need for service.

20. REPLACEMENT PARTS

When replacement parts are required, be sure the service technician uses replacement parts specified by the manufacturer or those that have the same characteristics as the original part. Unauthorized substitutions may result in fire, electric shock or other hazards.

21. SAFETY CHECK

Upon completion of any service or repairs to this unit, ask the service technician to perform safety checks to determine that the unit is in proper operating condition.

22. HEAT

The product should be situated away from heat sources such as radiators, heat registers, stoves, or other products (including amplifiers) that produce heat.

23. DISC TRAY

Keep your fingers clear of the disc tray as it is closing. It may cause serious personal injury.

24. CONNECTING

When you connect the product to other equipment, turn off the power and unplug all of the equipment from the wall outlet. Failure to do so may cause an electric shock and serious personal injury. Read the owner's manual of the other equipment carefully and follow the instructions when making any connections.

25. SOUND VOLUME

Reduce the volume to the minimum level before you turn on the product. Otherwise, sudden high volume sound may cause hearing or speaker damage.

IMPORTANT SAFEGUARDS

26. SOUND DISTORTION

Do not allow the product to output distorted sound for an extended period of time. It may cause speaker overheating and fire.

27. HEADPHONES

When you use the headphones, keep the volume at a moderate level. If you use the headphones continuously with high volume sound, it may cause hearing damage.

28. LASER BEAM

Do not look into the opening of the disc tray or ventilation opening of the product to see the source of the laser beam. It may cause eye damage.

29. DISC

Do not use a cracked, deformed, or repaired disc. These discs are easily broken and may cause serious personal injury and product malfunction.

30. NOTE TO CATV SYSTEM INSTALLER

This reminder is provided to call the CATV system installer's attention to Article 820-40 of the NEC that provides guidelines for proper grounding and, in particular, specifies that the cable ground shall be connected to the grounding system of the building, as close to the point of cable entry as practical.

EXAMPLE OF ANTENNA GROUNDING AS PER THE NATIONAL ELECTRICAL CODE

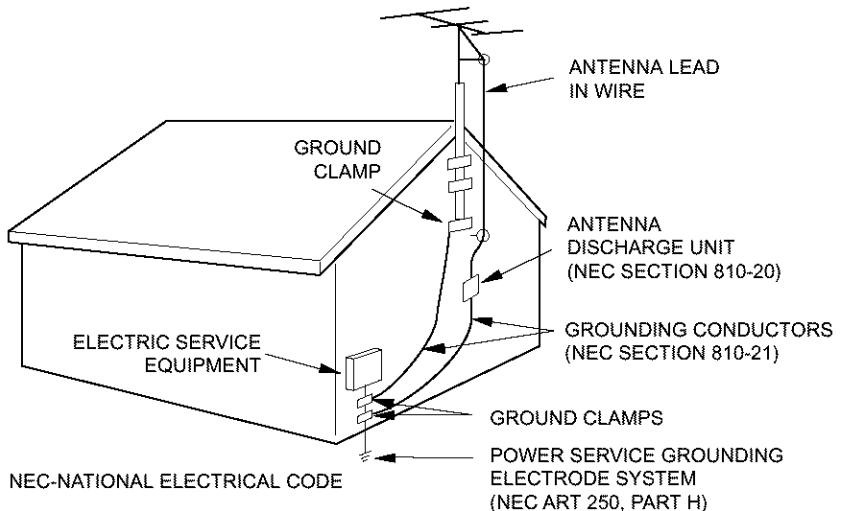

CONDENSATION

Moisture will form in the operating section of the player if the player is brought from cool surroundings into a warm room or if the temperature of the room rises suddenly. When this happens, player's performance will be impaired.

To prevent this, let the player stand in its new surroundings for about an hour before switching it on, or make sure that the room temperature rises gradually.

Condensation may also form during the summer if the player is exposed to the breeze from an air conditioner. In such cases, change the location of the player.

Safety precautions



WARNING!

INSTALL THE TV/DVD IN YOUR CAR

- For a car equipped with air bags, be sure to follow the manufacturer's instructions whenever performing any electrical wiring work. Incorrect wiring can cause the air bag system of a car to malfunction.
- Never cut the insulation from the power supply lead in an attempt to draw power for another device. Doing so can overload the current capacity of the lead, creating the danger of fire and electric shock.
- For proper installation and wiring special technical knowledge is required. If you have any doubts about where to position or how to install components, contact the retailer where you purchased the product, your automobile dealership, or an automotive service provider. Note that you will be charged separately for installation work.
- Use all of the components that come with this product only as directed. Improper use of components can damage interior components or result in improper anchoring of components, which creates the danger of accident and personal injury.
- Improper installation creates the danger of fire and accident.
- Take care so wires are not pinched between chassis parts, by screws or by the seat as it slides on its rails, etc. Such conditions can cut wires and cause shorts, creating the danger of accident, electric shock, and fire.
- Avoid installation in areas subject to strong vibration and areas where secure anchoring cannot be achieved. Components installed in such areas can work loose, creating the danger of accident and personal injury.
- Never install the TV/DVD on the dashboard or in any other location where it obstructs forward vision.
- Never attach the stand to the roof of your car. Doing so creates the danger of the TV/DVD falling down.
- Never attach the stand to a sharply angled surface or to a surface that causes the TV/DVD to face downwards. Such installation can cause the TV/DVD to fall.
- Be sure to turn the ignition key of the car to the "OFF" position before connecting or disconnecting wires and cables. Failure to do so creates the danger of electric shock and personal injury.

DRIVING SAFETY

- Never watch the TV/DVD or try to adjust settings while driving. Doing so creates the danger of traffic accident. Before operating the TV/DVD, be sure to stop the car in a safe area.
- Never install the unit on the dashboard or in any other location where it obstructs forward vision. Items that obstruct forward vision in a motor car may be illegal. Also, make sure that all components are installed where they do not interfere with operation of the steering wheel, shift lever, brake pedal, etc., for example under the driver's seat, and where they do not endanger passengers. Improper installation creates the danger of traffic accident and personal injury.
- Make sure all cables are bundled together so they do not interfere with car operation, as described in this manual. Improperly installed cables create the danger of entanglement with the steering wheel, shift lever, brake pedal, etc.

IMPORTANT NOTES:

- The unit is designed for use with a 12V DC automotive power supply. Never use it in a truck, bus, or any other car that has a 24V power supply.
- Be sure to stop your car in a safe area before watching or adjusting the TV/DVD.
- Operating the TV/DVD for a long time with the engine of your car stopped can run down your car's battery.
- Never leave the TV/DVD in areas exposed to temperature extremes or strong direct sunlight. Leaving it in a closed car, in direct sunlight, near a heater, etc. can cause deformation of the case. Using this product in areas that are colder than 5°C (41°F) or hotter than 40°C (104°F) can result in poor image quality.
- Never use benzene or other chemical agents for cleaning. Chemicals can damage the case and remove markings. Use a soft cloth moistened with a weak solution of water and mild neutral detergent. Wring out all excess moisture from the cloth before wiping.
- Never drop the TV/DVD or otherwise subject it to strong impact.
- Should the TV/DVD ever begin to emit smoke, abnormal odor, or a strange noise, immediately turn off power and unplug the unit from the cigarette lighter socket. Continued use of the TV/DVD under any of these conditions creates the danger of fire and electric shock.
- Do not continue to use the TV/DVD if it is malfunctioning and does not produce a video image or sound. Whenever you notice such symptoms, immediately turn off power, unplug the TV/DVD from the cigarette lighter socket. Continued use of the TV/DVD creates the danger of fire and electric shock.
- When you leave your car unattended for long periods, be sure to unplug the TV/DVD from the cigarette lighter socket. Leaving the TV/DVD plugged in can run down the car's battery.

This product utilizes both a Cathode Ray Tube (CRT) and other components that contain lead. Disposal of these materials may be regulated in your community due to environmental considerations. For disposal or recycling information please contact your local authorities, or the Electronics Industries Alliance: <<http://www.eiae.org>>

Before using your unit

IMPORTANT SAFEGUARDS	3
Safety precautions	6
Contents	7
Features	8
Disc information	9
Parts and functions	10
Remote control	11
Power sources	12
Antenna connections	13
Cable TV connections	14

TV operation

Setting the on screen display language	15
TV operation	16
Closed caption	18
To memorize channels	19
Setting the V-Chip	21
Picture control adjustment	24
Stereo and second audio program (SAP)	25

Playback operation

Preparation/Status display of disc	26
Playback procedure	27
Special playback	28
MP3 playback	29

Advanced Function

Zooming/Locating desired scene	30
Repeat/Random/Program playback and Repeat A-B	31
Marking desired scenes	32
Changing soundtrack language/Subtitles	33
Changing angles/Title selection/DVD menu	34

Additional Information

Setting language	35
Setting the aspect ratio of TV screen/ Setting on screen display	36
Dynamic Range Control	37
Parental control setting	38
To change the parental level	39
Temporary disabling of rating level by DVD disc	40
Language code list	41
Connections to other equipment	42
Problems and troubleshooting	44
Reception disturbances	46
Specifications	47
Index of Controls	48
Spanish Quick Use Guide (Guía para rápida consulta)	50
Limited Warranty	56
Customer Services Directory	57
Index	58

Accessories



Remote Control
(076N0GV010)

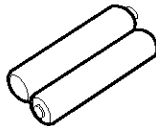

Batteries 2 "AAA"
(1411004015)



Telescopic Antenna
(121B164101)

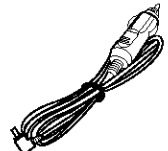

12V DC Car Cord
(125C108027)

Region Management Information

This unit is designed and manufactured to respond to the Region Management Information that is recorded on a DVD disc. If the Region number described on the DVD disc does not correspond to the Region number of this unit, this unit cannot play this disc.

- The region number of this player is "1."
- The player will play DVD-Video marked with labels containing "1" or "ALL."

Example:



Features

Color TV With DVD/CD player

Unique space saving design combines a 9" color TV and a DVD/CD player.

The DVD disc has much more capacity, but is the same size as the audio CD disc. Picture/Audio quality of the DVD exceeds other software. Picture quality is higher than Super VHS. Audio quality is higher than audio CD. The DVD also has special options; audio language selection, subtitle language selection or multi-angle, etc.

The DVD PLAYER can play back video CDs, audio CDs and MP3 CDs.

High Quality Picture

Horizontal Resolution

More than 500 lines. It exceeds Super VHS (400 lines) or Laser Disc (430 lines) in resolution.

Compatible with a wide range of DVD audio outputs

Digital Audio Jack (Coaxial)

- When a component with a built-in Dolby Digital decoder is connected, Dolby Digital sound can produce the effect of being in a movie theatre or a concert hall.
- Surround standard different from Dolby Digital. This format is already in use in many theatres. By connecting this unit to a DTS decoder or an AV amplifier with a built-in DTS decoder, the DTS audio of DVD discs recorded in this format can be enjoyed. However, audio will not be output from the analog audio output jacks.
- By connecting this unit to an AV amplifier with a built-in MPEG decoder, the MPEG audio of DVD discs recorded in this format can be enjoyed.
- The Linear PCM sound of a 48 kHz/24 bit through 96 kHz/24 bit exceeds audio CD sound.

Convenience Features

Direct selection of your desired scenes using Title/Chapter/Time/Track - You can play back from the desired scene.

Recalling Up to 3 Scenes (DVD only) - You can program up to 3 scenes in memory and recall the marked scenes.

Frame Advance - The PAUSE/STILL moves one frame at a time.

Slow Motion - The SLOW moves you back and forth through the program by 4 steps of 1/8-1/2 times.

Repeat Playback - You can repeat chapter, track, title, sides or material between two selected points.

Program Playback - You can play back tracks in programmed sequences.

Zoom (DVD only) - You can zoom in the selected subject on the screen during playback.

Note: Make sure that discs are suitable for the following functions.

Multi-Language - Maximum 32 language subtitles and maximum 8 language soundtracks can be played back for movies or programmes.

Multi-Angle - Pictures of Sports or a Live Concert are recorded with many cameras. When you play such a disc, you can change the angles during playback.

Parental Control - You can limit the play back of scenes or sounds of adult DVD discs which have parental level.

Video Aspect Ratio - You can change the aspect ratio of the screen for your monitor.

TV Features

120V AC or DC Operation - This TV/DVD is designed to operate from household AC current or from a 12V DC car cigarette lighter socket.

181 Channel Tuner - Receives standard VHF and UHF broadcast channels and up to 113 cable channels. The actual number of channels received depends upon channel reception in your area or your cable system.

Closed Caption Decoder With Full Text Mode - Displays text captions or full screen text on the screen for hearing impaired viewers.

Picture Adjustments Using The Remote Control - The On-Screen display allows precise remote control adjustment of BRIGHTNESS, CONTRAST, COLOR, TINT and SHARPNESS.







Programmable TV Sleep Timer - Operable from the remote control, the TV can be programmed up to 120 minutes to turn off automatically.

On-Screen 3 Language Display - You can select one of 3 languages, English, Spanish or French for on-screen programming.

V-Chip - The V-Chip function can read the rating of a TV program or movie content if the program is encoded with this information. V-chip will allow you to set a restriction level.

This product incorporates copyright protection technology that is protected by method claims of certain U.S. patents and other intellectual property rights owned by Macrovision Corporation and other rights owners. Use of this copyright protection technology must be authorized by Macrovision Corporation and is intended for home and other limited viewing uses only unless otherwise authorized by Macrovision Corporation. Reverse engineering or disassembly is prohibited.

Discs that can be played

Disc type	Disc Logo	Disc formats supported by this unit
DVD-Video		• DVD-Video format
		
Video CD		• Video-CD format
CD-DA		• CD-DA format
CD-R		• CD-DA format
		• Video-CD format
CD-RW		• MP3 file and finalized*

- Discs played 8 cm (3") or 12 cm (5")
- * A process that allows play on compatible equipment.

Discs which cannot be played with this unit

- DVD with Region No. other than "1" or "ALL"
- DVD of PAL system
- DVD-ROM
- DVD-AUDIO
- DVD-RW
- DVD+RW
- CD-ROM
- CDV
- CVD
- CD-G
- CD-TEXT
- SACD
- Photo-CD

Definition of Terms

Angle

Some DVD discs feature scenes simultaneously shot from different angles. The ANGLE button can be used to view the scene from different angles.

Chapter Number

Titles are subdivided into numbered sections. You can quickly search for a favorite scene using these numbers.

DVD

A high-density optical disc on which high-quality pictures and sound have been digitally recorded. DVD incorporates new video compression technology (MPEG II) and high-density recording technology which allow entire movies to be recorded with incredible playback quality.

Playback Control

With Video CD (version 2.0), scenes or information may be selected for viewing or listening from an interactive menu that appears on the TV screen.

Subtitles

Written dialogue which appears at the bottom of the screen.

Time Number

The elapsed play time from the start of a disc or title. Use to quickly find scenes. (May not work with some discs.)

Title Number

For DVD discs with two or more titles, the title is numbered as title 1, title 2, etc.

Track Number

Numbers assigned to tracks on Video CDs and CDs to allow specific tracks to be quickly located.

Video CD

CD containing picture and sound with same quality level as video tape. This unit also supports Video CDs with playback control (version 2.0).

Disc Handling

Handling precautions

- Do not attach sticker to discs. (Do not use discs with exposed adhesive from tape or left over peeled-off stickers.)

- Only hold disc by edges as shown. Fingerprints, dirt, and scratches can cause skipping and distortion.

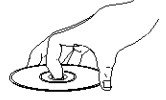

- Do not write on label side of disc.



- Never use record cleaning sprays, benzine, thinner, static electricity prevention liquids, or any other solvent.

- Be careful not to drop or bend disc.

- Do not place more than 1 disc on disc tray.

- Do not try to close disc tray when disc is not properly placed.

- Always store discs in their proper cases when not in use.

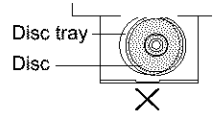

To clean disc surface

With a soft, damp (water only) cloth, gently wipe from the center hole to the outer edge as shown below. (Wiping in a circular pattern will scratch the surface.)

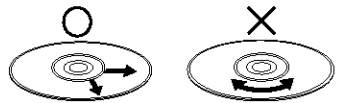

If disc is brought from a cold to a warm environment, moisture may form on the disc

Wipe away moisture with a soft, dry, lint-free cloth before using disc. (See above.)

Improper disc storage

Discs could be damaged if stored or left in areas:

- exposed to direct sunlight.
- that are humid or dusty.
- near heat (i.e. heater, radiator, etc.).

Parts and functions

Front

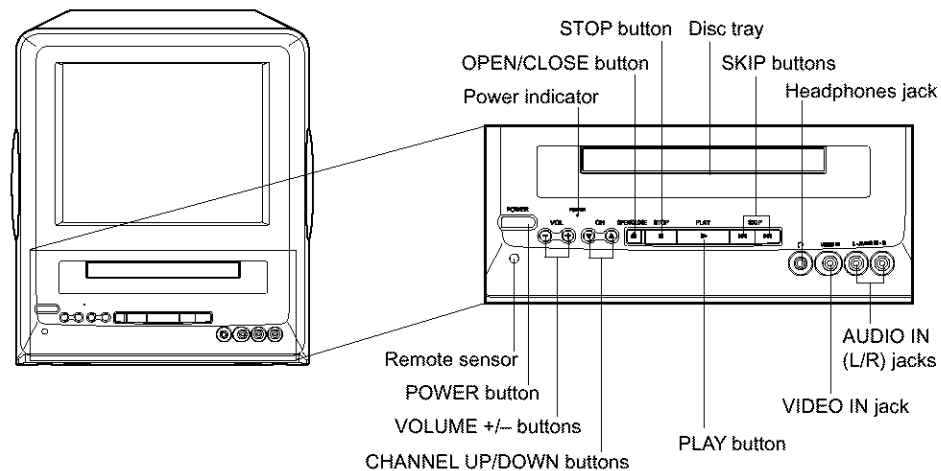

Rear

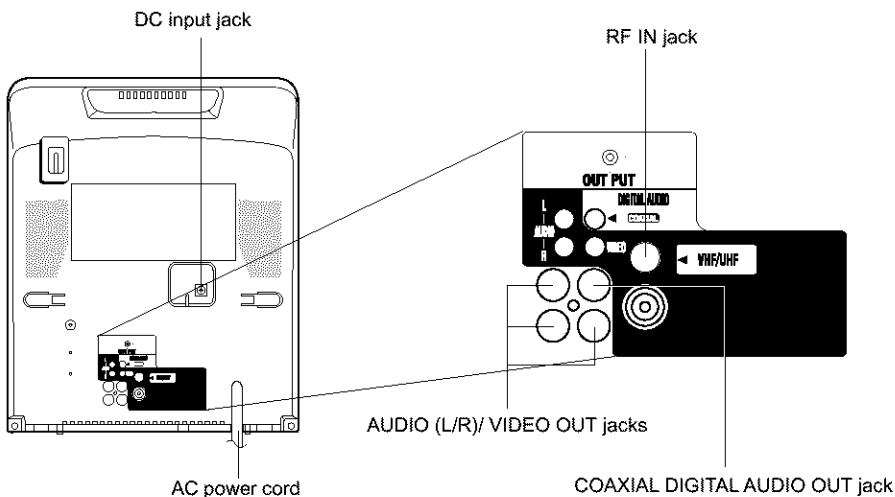

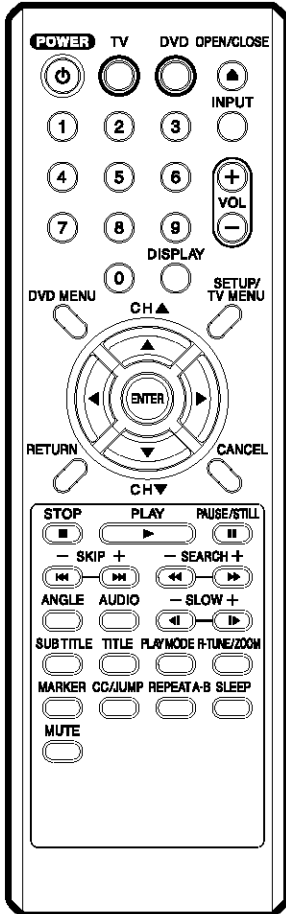

		Page
POWER	Power On/Off	15,16,26
TV	Switch to operate TV/AV	15
DVD	Switch to operate DVD	26
OPEN/CLOSE	Open or Close the tray	27,29,40
0-9	Direct channel selection of TV Input setting Enter a password	16,20 29,30,31 21,23,38-40
INPUT	Switch between TV/AV	43
VOL +/-	Adjust volume of TV	16
DISPLAY	Call TV information Call DVD information	17,22 26
DVD MENU	Display DVD menu	34
SETUP/TV MENU	TV mode - Display menu of TV DVD mode - Call up initial setup mode	15,19-24 35-39
CH ▲/▼	Select channel of TV	17
▲▼◀▶	Cursor buttons	15,19-24 27,29,30,32,34-39
ENTER	Enter information in the menu	15,21,23 27,29,30-32,34-40
RETURN	Remove DVD set up menu	35-40
CANCEL	Reset information in the menu	21,23,24,30-32,38,39
STOP	Stop	27,29,31
PLAY	Playback	27-29,31,34,40
PAUSE/STILL	Pause CD sound Still picture of DVD	28
SKIP +/-	Skip chapter to forward or reverse direction	28
SEARCH +/-	Fast Forward/Review playback	28
ANGLE	Change playback angle	34
AUDIO	Switch the sound of TV Change sound track language	25 33
SLOW +/-	Forward/Reverse- slow motion	28
SUB TITLE	Set subtitle	33
TITLE	Select title	34
PLAY MODE	Select playback mode	31
R-TUNE/ZOOM	Switch between present/last channel Zoom	17 30
MARKER	Index	32
CC/JUMP	Switch between TV/Caption/Text in Closed Caption mode Locating desired scene	18 30
REPEAT A-B	Repeat playback between A and B	31
SLEEP	Sleep timer	17
MUTE	Switch off the sound	17

Remote control

BATTERY INSTALLATION

Open the battery compartment cover in the direction of the arrow.

Install two "AAA" batteries, paying attention to the polarity diagram in the battery compartment.

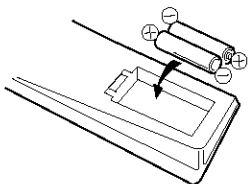

Replace the compartment cover.

OPERATION

- Aim the remote control at the remote sensor and press control buttons to operate.
- Operate the remote control within 30° angle on either side of the remote sensor, up to a distance of Approx. 5 meters.

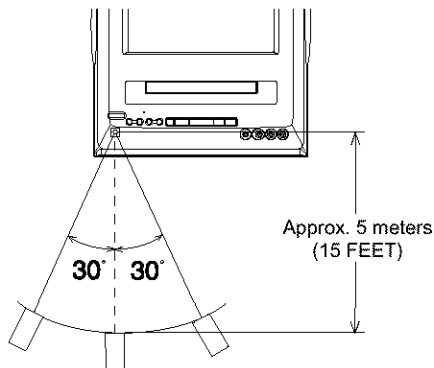

NOTES:

- Do not leave the remote control unit exposed to direct sunlight or in hot or humid places.
- The remote control unit uses infrared beams to transmit signals, so sunlight or fluorescent light on the remote sensor may shorten operating distance.
- Incorrect use of batteries may cause them to leak or burst. Read the battery warnings and use the batteries properly.
- Do not mix old and new batteries.
- Remove batteries if the remote control will not be operated for an extended period of time.

Power sources

TO USE AC POWER

Use the AC polarized line cord provided for operation on AC. Insert the AC cord plug into a standard 120V 60Hz polarized AC outlet.

NOTES:

- Never connect the AC line cord plug to anything other than the specified voltage (120V 60Hz). Use the attached power cord only.
- If the polarized AC cord does not fit into a nonpolarized AC outlet, do not attempt to file or cut the blade. It is the user's responsibility to have an electrician replace the obsolete outlet.
- If you cause a static discharge when touching the unit, and the unit fails to function, simply unplug the unit from the AC outlet, wait a few minutes, and plug it back in. The unit should return to normal operation.

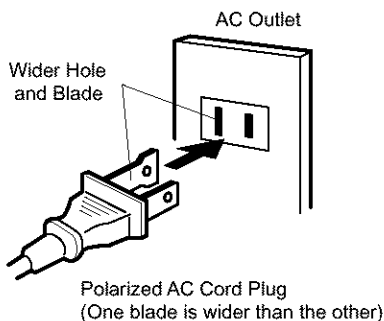

TO USE DC POWER

By using the DC car cord supplied with the TV/DVD, you can operate this TV/DVD from a cigarette lighter socket in any car that utilizes a negative ground system.

The fused 12V DC car cord has been designed to power the set from the external DC power (12 volt negative ground) through the TV/DVD DC input jack.

Connect the smaller plug on the end of the cord to the DC input jack on the rear of the TV/DVD, then insert the other end of the car cord into the cigarette lighter socket of your car. Make sure that the cord makes a firm connection. It may be necessary to try several insertions, rotating the plug for proper electrical connection.

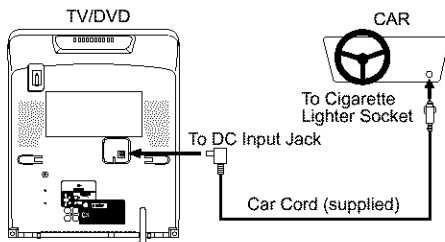

Antenna connections

NOTES: • ALWAYS TURN THE TV/DVD TO "OFF" BEFORE SWITCHING THE IGNITION OF THE CAR ENGINE.

- Make sure that the negative terminal of the battery is grounded.
This set is designed for use with negative grounding systems only.
- Use the supplied car cord only.
- When the TV/DVD is not in use, always disconnect it from the car cigarette lighter socket to avoid a battery drain.
- If the TV/DVD is to be directly connected to a 12V DC power source, for example, recreational vehicle (RV) applications, make sure the power cord is connected after the ignition switch to avoid battery drain.
- Do not operate the TV/DVD if the car battery is weak. Peak current from the car alternator could blow the DC fuse.
- Check the battery's charge level regularly when the TV/DVD is used in a vehicle.

REPLACING THE FUSE IN THE CAR BATTERY CORD PLUG

If the fuse in the car battery cord plug blows, replace it with a new 8 A fuse (Fast Blow Type) as shown below. Unscrew the tip of the plug to remove.

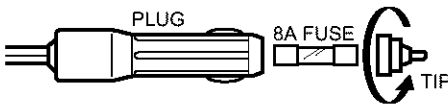

 Please use correct fuse.

If you are using an indoor or outdoor antenna, follow the instructions below that correspond to your antenna system. If you are using a cable TV service (CATV), see page 14 for Cable TV connections.

Combination VHF/UHF Antenna (Single 75 ohm cable or 300 ohm twin-lead wire)

Connect the 75 ohm cable from the combination VHF/UHF antenna to the Antenna Jack.

If your combination VHF/UHF antenna has a 300 ohm twin-lead wire, the use of the 300-75 ohm Matching Transformer may be necessary.

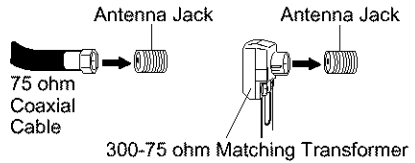

Combination VHF/UHF Antenna (Separate VHF and UHF 300 ohm twin-lead wires)

Connect the UHF 300 ohm twin-lead wire to the Combiner (not supplied). Connect the VHF 300 ohm twin-lead wire to the 300-75 ohm Matching Transformer. Attach the Transformer to the Combiner, then attach the Combiner to the Antenna Jack.

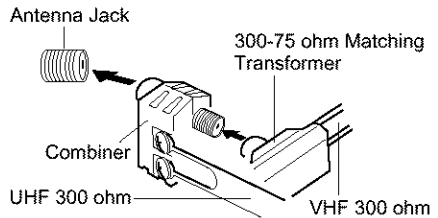

Separate VHF/UHF Antennas (75 ohm VHF cable and 300 ohm UHF twin-lead wires)

Connect the VHF 75 ohm cable and UHF 300 ohm twin-lead wire to the Combiner (not supplied). Attach the Combiner to the Antenna Jack.

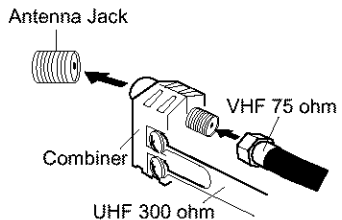

Cable TV connections

This TV/DVD has an extended tuning range and can tune most cable channels without using a Cable TV Converter box. Some cable companies offer "premium pay channels" in which the signal is scrambled. Descrambling these signals for normal viewing requires the use of a descrambler device which is generally provided by the cable company.

FOR SUBSCRIBERS TO BASIC CABLE TV SERVICE

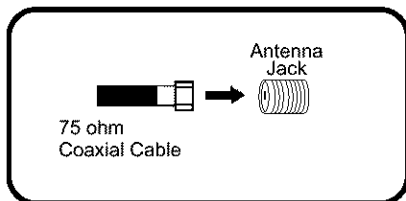

For basic cable service not requiring a Converter/Descrambler box, connect the CATV 75 ohm Coaxial Cable directly to the Antenna Jack on the back of the TV/DVD.

FOR SUBSCRIBERS TO SCRAMBLED CABLE TV SERVICE

If you subscribe to a cable TV service which requires the use of a Converter/Descrambler box, connect the incoming 75 ohm Coaxial Cable to the Converter/Descrambler box. Using another 75 ohm Coaxial Cable, connect the output jack of the Converter/Descrambler box to the Antenna Jack on the TV/DVD. Follow the connections shown below. Set the TV/DVD to the output channel of the Converter/Descrambler box (usually channel 3 or 4) and use the Converter/Descrambler box to select channels.

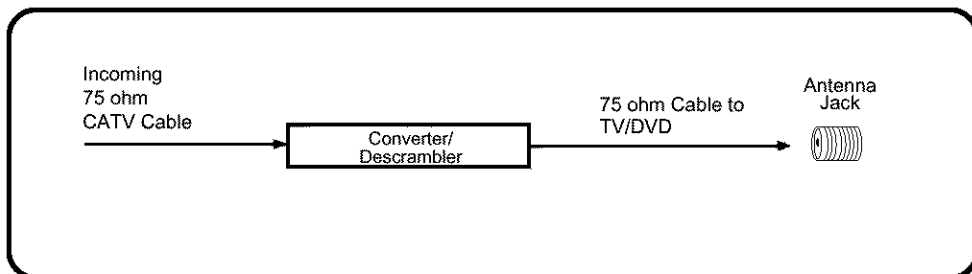

FOR SUBSCRIBERS TO UNSCRAMBLED BASIC CABLE TV SERVICE WITH SCRAMBLED PREMIUM CHANNELS

If you subscribe to a cable TV service in which basic channels are unscrambled and premium channels require the use of a Converter/Descrambler box, you may wish to use a signal Splitter and an A/B Switch box (available from the Cable company or an electronics supply store). Follow the connections shown below. With the switch in the "B" position, you can directly tune any unscrambled channels on your TV/DVD. With the switch in the "A" position, tune your TV/DVD to the output of the Converter/Descrambler box (usually channel 3 or 4) and use the Converter/Descrambler box to tune scrambled channels.

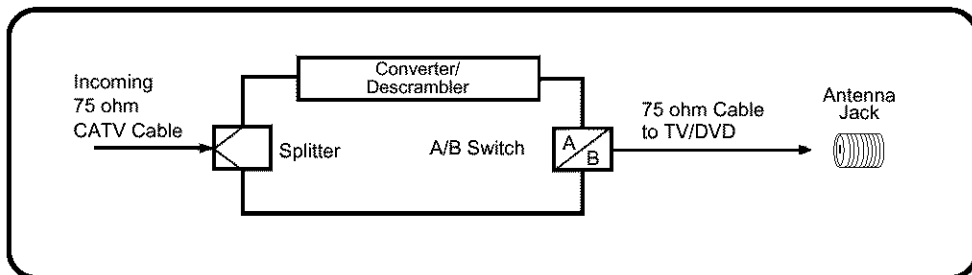

Setting the on screen display language

You can choose from three different languages (English, French and Spanish) for the on-screen displays. Adjustment menus and messages will appear in the language of your choice.

On-screen language selection (step 5) will automatically appear on the screen when you press the TV MENU button initially. Select the language you prefer first, then proceed with the other menu options.

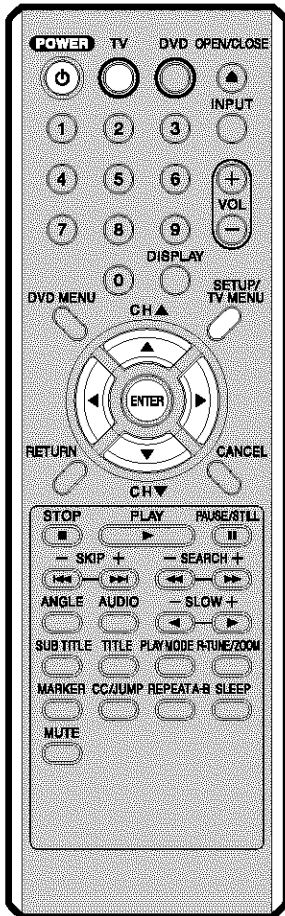

- 1 To turn on the TV/DVD, press **POWER**. The Power indicator will light. Press **TV** to select TV mode.
 - Every time you press **POWER**, the TV/DVD starts from TV mode.

- 2 Press **TV MENU**.
The TV menu screen will appear.

- 3 Press **◀** or **▶** until the **OPTION** menu appears.

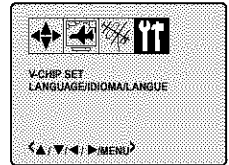

- 4 Press **▲** or **▼** to select the "LANGUAGE" option, then press **◀** or **▶** button.



- 5 Press **▲** or **▼** to select the desired language: English (ENGLISH), Spanish (ESPAÑOL) or French (FRANCAIS), then press **ENTER**.



Press **TV MENU** until the MENU screen is cleared.

NOTES:

- If the unit does not operate properly (by the buttons on the unit and/or the remote control) disconnect the AC cord, wait a few minutes and plug it back in. Static electricity, etc., may have affected the player's operation.
- The TV section has its own menu and also DVD section has its own menu (see page 35).

TV operation

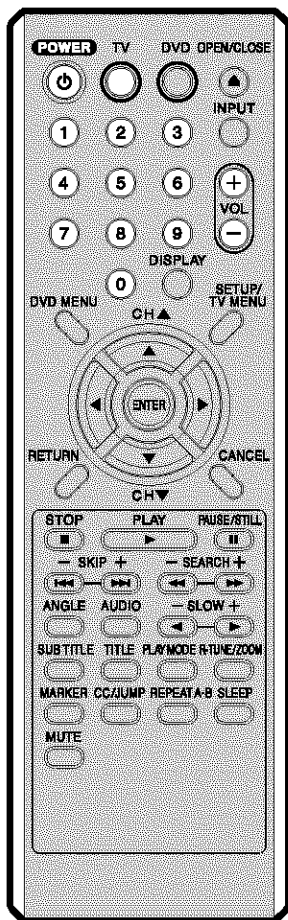

- 1 To turn on the TV/DVD, press **POWER**. Press **TV** to select TV mode.
- 2 Adjust the volume level by pressing **VOL +** or **-**. The volume level will be indicated on the screen by green bars. As the volume level increases, so do the number of bars. If the volume decreases, the number of green bars also decreases.

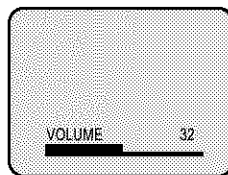

- 3 Set the TV/CATV menu option to the appropriate position. (See page 19.)

TV - VHF/UHF channels
CATV - CABLE TV channels

- 4 Press the Direct Channel selection buttons to select the channel.
TV Mode Direct Channel Selection
When the TV/CATV menu option is in the TV position, all channels can be instantly selected by using two buttons. (for example, to select channel 2, press "0", then "2". If you press only "2", channel selection will be delayed for a few seconds.) For channels 10 and above, press the 2 digits in order.

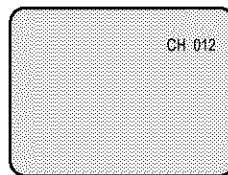

CATV Mode Direct Channel Selection

When the TV/CATV menu option is in the CATV position, channels can be selected as follows:

TO SELECT CATV CHANNELS:

- 1-9: Press "0" twice, then 1-9 as needed. Example, to select channel 2, press "002".
- 10-12: Press "0", then the remaining 2 digits. Example, to select channel 12, press "012".
- 13-99: Press the 2 digits in order. Example, to select channel 36, press "36".
- 100-125: Press the 3 digits in order. Example, to select channel 120, press "120".

NOTE FOR CHANNELS 1-12:

If only 1 or 2 buttons are pressed, the corresponding channel will be selected in 2 seconds.

TV	CATV
VHF 2-13	VHF 2-13
UHF 14-69	STD/HRC/IRC 14-36 (A) (W) 37-59 (AA) (WW) 60-85 (AAA) (ZZZ) 86-94 (86) (94) 95-99 (A-5) (A-1) 100-125 (100) (125) 01 (5A)

NOTES:

- If a channel with no broadcast is selected, the sound will automatically be muted.
- If a station being viewed stops broadcasting, the TV will automatically shut itself off after 15 minutes.

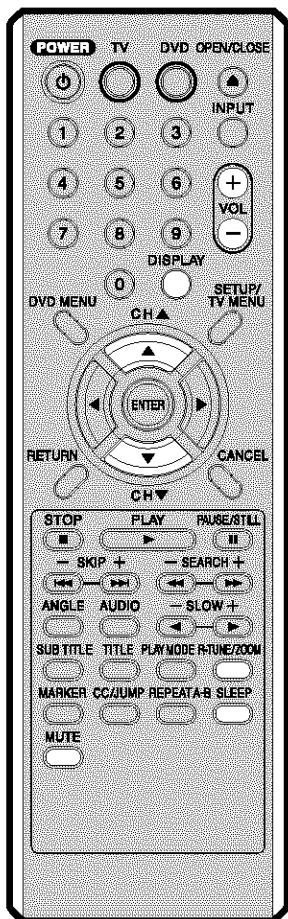

CHANNEL

Press and release **CH ▲** or **▼**. The channel automatically stops at the next channel set into memory. For proper operation, before selecting channels, they should be set into the memory. See pages 20 and 21 "To memorize channels".

NOTE: **CH ▲** or **▼** on the remote control does not operate in DVD mode.

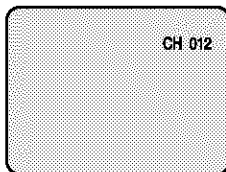

DISPLAY

Press **DISPLAY** to display the current information on the screen. Press **DISPLAY** again to clear the call display.

- Channel number or VIDEO mode
- Stereo or SAP (second audio program) audio status
- Audio output status

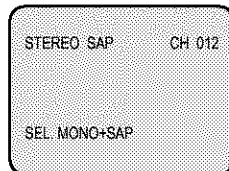

R-TUNE

This button allows you to go back to the last channel selected by pressing **R-TUNE**. Press **R-TUNE** again to return to the last channel you were watching.

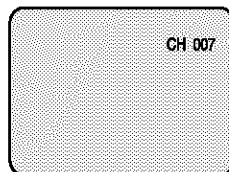

MUTE

Press **MUTE** to switch off the sound. The TV/DVD's sound will be silenced and "MUTE" will briefly appear on the screen. The sound can be switched back on by pressing this button again or one of the **VOL +** or **-** buttons.

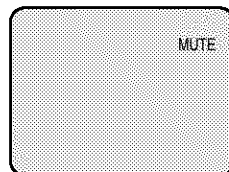

SLEEP

To set the TV/DVD to turn off after a preset amount of time, press **SLEEP** on the remote control. The clock will count down 10 minutes for each press of **SLEEP** (120, 110, ..., 10, 0). After the sleep time is programmed, the display will appear briefly every ten minutes to remind you that the sleep timer is operating. To confirm the sleep timer setting, press **SLEEP** and the remaining time will be displayed for a few seconds. To cancel the sleep timer, press **SLEEP** repeatedly until the display turns to 0.

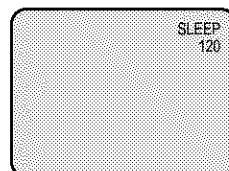

Closed caption

WHAT IS CLOSED CAPTIONING?

This television has the capability to decode and display Closed Captioned television programs. Closed Captioning will display text on the screen for hearing impaired viewers or it will translate and display text in another language.

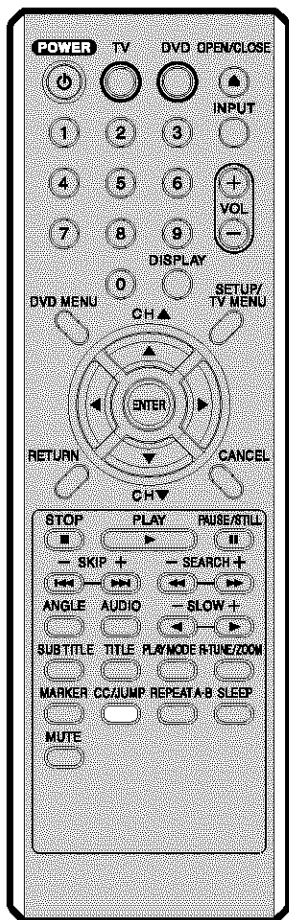

Captions: This Closed Caption Mode will display text on the screen in English or another language (depending on the setting of the Closed Captions CH 1/2).

Generally, Closed Captions in English are transmitted on Captions Channel 1 and Closed Captions in other languages are transmitted on Captions Channel 2.

The Captions will appear in places on the screen where they will least interfere with the picture, usually on the bottom of the screen. News programs will usually show three-line Closed Captions which scroll onto the screen.

Most other shows provide two or three lined Captions placed near the character who is speaking so the viewer can follow the dialogue. Words in italics or underlined describe titles, words in foreign languages or words requiring emphasis. Words that are sung usually appear enclosed by musical notes.

Text: The Text Closed Caption Mode will usually fill the screen with a programming schedule or other information.

After selecting a Closed Caption Mode, it will stay in effect until it is changed, even if the channel is changed.

If the Captions signal is lost due to a commercial or a break in the signal, the Captions will reappear when the signal is received again. If the channels are changed, the Captions will be delayed approximately 10 seconds.

For television programs broadcasting with Closed Captions, look in your TV guide for the Closed Captions symbol (CC).

TO VIEW CLOSED CAPTIONS

Press **CC** to switch between normal TV and the two closed caption modes (captions and full screen text). Closed captioning will display text on the screen for hearing impaired viewers.

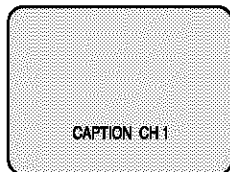

NOTES:

- When selecting Closed Captions, the captioning will be delayed approximately 10 seconds.
- If no caption signal is received, no captions will appear, but the television will remain in the Caption Mode.
- Misspellings or unusual characters may occasionally appear during Closed Captioning. This is normal with Closed Captioning, especially with live programs. This is because during live programs, captions are also entered live. These transmissions do not allow time for editing.
- When Captions are being displayed, on-screen displays, such as volume and mute may not be seen or may interfere with Closed Captions.
- Some cable systems and copy protection systems may interfere with the Closed Captioned signal.
- If using an indoor antenna or if TV reception is very poor, the Closed Caption Decoder may not appear or may appear with strange characters or misspelled words. In this case, adjust the antenna for better reception or use an outdoor antenna.

To memorize channels

This TV/DVD is equipped with a channel memory feature which allows channels to skip up or down to the next channel set into memory, skipping over unwanted channels. Before selecting channels, they must be programmed into the TV/DVD's memory. In addition to normal VHF and UHF channels, this TV/DVD can receive up to 113 Cable TV channels. To use this TV/DVD with an antenna, set the TV/CATV menu option to the TV mode. When shipped from the factory, this menu option is in the CATV mode.

TV/CATV SELECTION

- 1 Press **TV** to select TV mode, then press **TV MENU**. The TV menu screen will appear.
- 2 Press **◀** or **▶** until the SET UP menu appears.

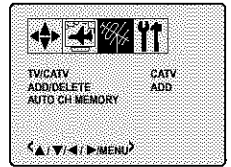

- 3 Press **▲** or **▼** to select the "TV/ CATV" option.

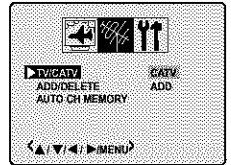

- 4 Press **◀** or **▶** to select the TV or CATV mode.

TV - VHF/UHF channels
CATV - CABLE TV channels

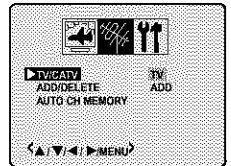

- 5 Press **TV MENU** until the MENU screen is cleared.

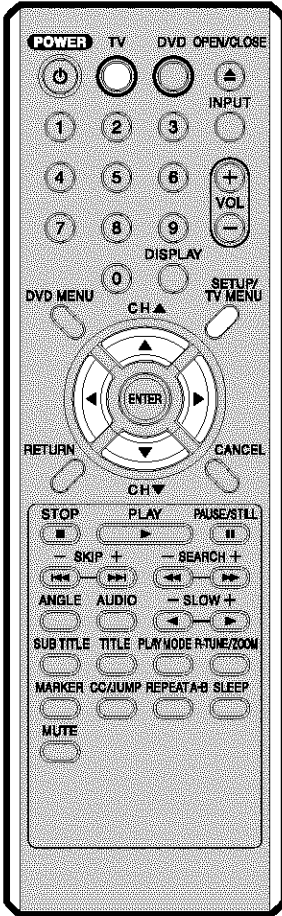

CATV CHART

The chart below is typical of many cable system channel allocations.

Number on this TV												14	15	16	17	18	19	20	21	22
Corresponding CATV channel												A	B	C	D	E	F	G	H	I
23	24	25	26	27	28	29	30	31	32	33	34	35	36	37	38	39	40			
J	K	L	M	N	O	P	Q	R	S	T	U	V	W	AA	BB	CC	DD			
41	42	43	44	45	46	47	48	49	50	51	52	53	54	55	56	57	58			
EE	FF	GG	HH	II	JJ	KK	LL	MM	NN	OO	PP	QQ	RR	SS	TT	UU	VV			
59	60	61	62	63	64	65	66	67	68	69	70	71	72	73	74	75	76			
WW	AA	BBB	CCC	DDD	EEE	FFF	GGG	HHH	III	JJJ	KKK	LLL	MMM	NNN	OOO	PPP	QQQ			
77	78	79	80	81	82	83	84	85	86	87	88	89	90	91	92	93	94			
RRR	SSS	TTT	UUU	VVV	WWW	XXX	YYY	ZZZ	86	87	88	89	90	91	92	93	94			
95	96	97	98	99	100	101	102	103	104	105	106	107	108	109	110	111	112			
A-5	A-4	A-3	A-2	A-1	100	101	102	103	104	105	106	107	108	109	110	111	112			
113	114	115	116	117	118	119	120	121	122	123	124	125	01							
113	114	115	116	117	118	119	120	121	122	123	124	125	5A							

To memorize channels

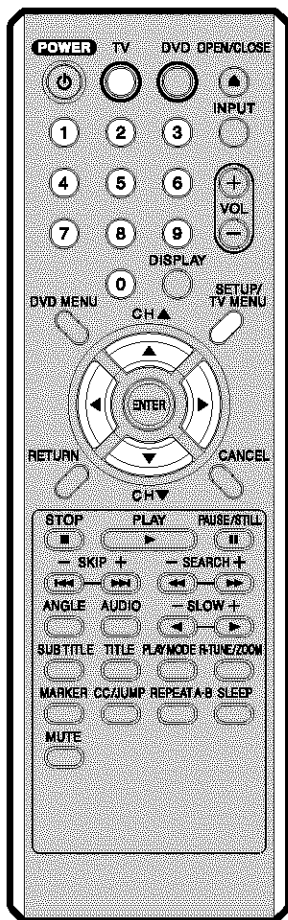

AUTOMATIC MEMORY TUNING

- 1 Press **TV** to select TV mode, then press **TV MENU**. The TV menu screen will appear.
- 2 Press **◀** or **▶** until **SET UP** menu appears.
- 3 Press **▲** or **▼** to select the "AUTO CH MEMORY", then press **◀** or **▶**. The TV will begin memorizing all the channels available in your area.
- 4 Press **TV MENU** until the MENU screen is cleared.

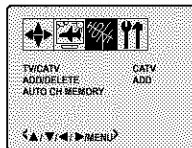

TO ADD/DELETE CHANNELS

- 1 Select the desired channel to be memorized or deleted using **Direct Channel Selection (0-9)**, or **CH ▲** or **▼**.
- 2 Press **TV MENU**. The TV menu screen will appear.
- 3 Press **◀** or **▶** until **SET UP** menu appears.
- 4 Press **▲** or **▼** to select the "ADD/DELETE".
- 5 Press **◀** or **▶** to select **ADD** or **DELETE**, whichever function you want to perform.
- 6 Press **TV MENU** until the MENU screen is cleared.
- 7 Repeat steps 1-6 for other channels you want to add or delete.

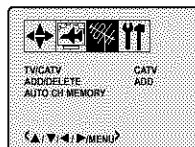

Setting the V-Chip

This TV/DVD is equipped with a V-Chip Controller which provides you with channel viewing access controls and restrictions. This function is to prevent your children from watching violence or sexual scenes, that you may choose to exclude.

To use the V-Chip function, you must register a password.

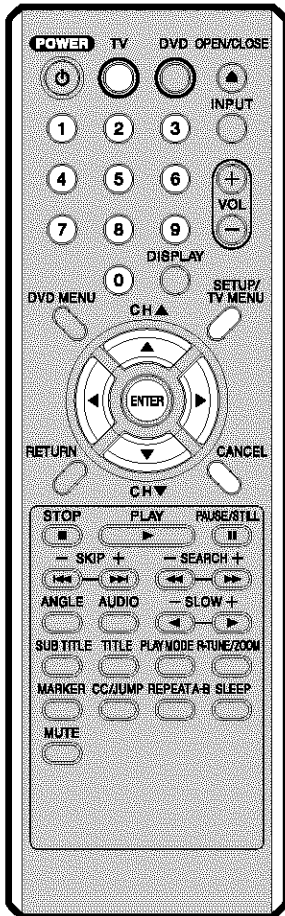

TO REGISTER PASSWORD

1 Press **TV** to select TV mode, then press **TV MENU**.
The TV menu screen will appear.

2 Press **◀** or **▶** until the **OPTION** menu appears.

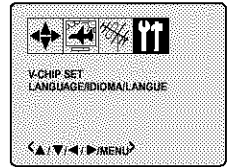

3 Press **▲** or **▼** to select the "V-CHIP SET", then press **◀** or **▶**.

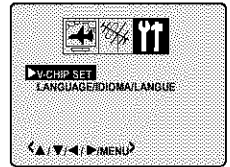

4 Enter the password (4 digits) using **Direct Channel Selection (0-9)**, then press **ENTER**.

- If you put a wrong number, press **CANCEL**.

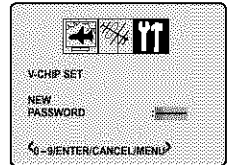

"*" appears instead of the number.

5 Enter the same password again for confirmation, then press **ENTER**.

Now the password is registered and the V-Chip setting menu will appear on the display.

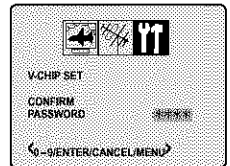

NOTES:

- To avoid forgetting the password, write it down and keep in a safe place.
- If you forget the password, turn the volume level into a minimum, then press **VOL -** on the unit and **0** on the remote control for more than 1 second simultaneously.

Setting the V-Chip

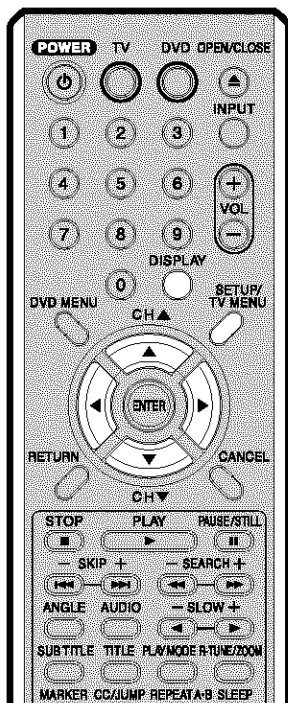

To use after the TV is protected
When a program is received with the V-Chip protection applied, enter the password. Protection can be temporarily overridden.

NOTES:

- The V-Chip function is activated only on programs and tapes that have the rating signal.
- If you are changing channels using a VCR or a cable box, while the TV remains on channel 3 or 4, the V-Chip operates differently. When you enter your password to temporarily release the block on any channel, you have completely disabled the V-Chip function for all stations. To reset the V-Chip turn your TV off and back on.
- Some cable boxes are built with a delay feature, in some cases it can take up to 10 seconds for a program to appear after the password has been input.

TO SET THE V-CHIP

- 1 In the V-CHIP SET menu, press ▲ or ▼ to select the "TV RATING".

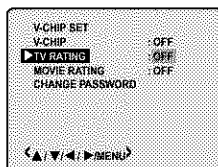

- 2 Press ◀ or ▶ to display the desired setting.

OFF : TV RATING is not set
TV-Y : All children
TV-Y7 : 7 years old and above
TV-G : General Audience
TV-PG : Parental guidance
TV-14 : 14 years old and above
TV-MA : 17 years old and above

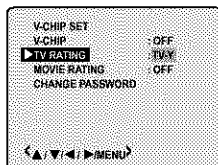

When you select TV- Y7, TV-PG, TV-14 or TV-MA, press **DISPLAY** to show the contained rating. Press ▲/▼ or ◀/▶ to select the desired item you want.

- 3 Press ▲ or ▼ to select the "MOVIE RATING".

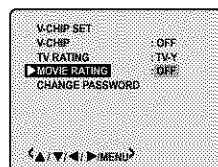

- 4 Press ◀ or ▶ to select desired rating.

OFF : MOVIE RATING is not set
G : All ages
PG : Parental guidance
PG-13 : Parental guidance less than 13 years old
R : Under 17 years old
 Parental guidance suggested
NC-17 : 17 years old and above
X : Adult only

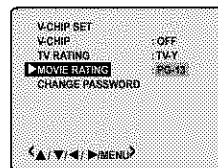

- 5 Press ▲ or ▼ to select "V-CHIP".

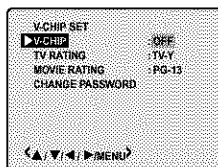

- 6 Press ◀ or ▶ to Display "ON". Now your settings were set into the memory.

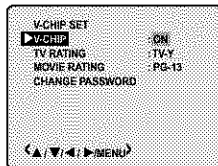

- 7 Press **TV MENU** until the MENU screen is cleared.

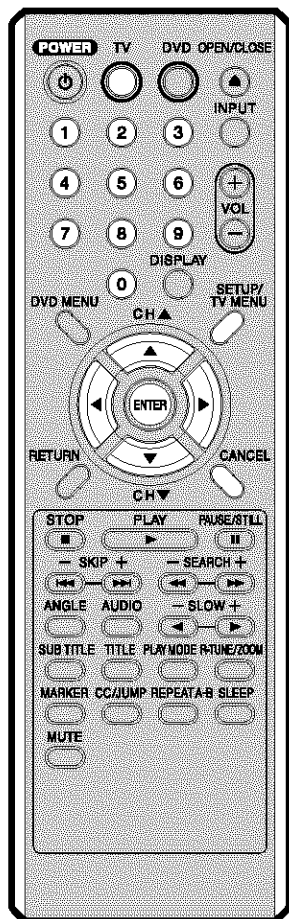

TO CHANGE PASSWORD

- 1 Press **TV** to select TV mode, then press **TV MENU**. The TV menu screen will appear.
- 2 Press **◀** or **▶** until **OPTION** menu appears.
- 3 Press **▲** or **▼** to select the "V-CHIP SET", then press **◀** or **▶**.
- 4 Enter the Password using **Direct Channel Selection (0-9)**, then press **ENTER**.
 - If you put a wrong number, press **CANCEL**.
- 5 Press **▲** or **▼** to select "CHANGE PASSWORD", then press **◀** or **▶**.
- 6 Enter the new password using **Direct Channel Selection (0-9)**, then press **ENTER**.
- 7 Enter the new password again for confirmation, then press **ENTER**.
- 8 Press **TV MENU** repeatedly to return to normal screen.

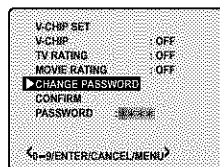
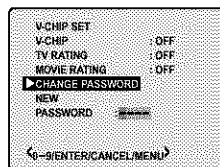
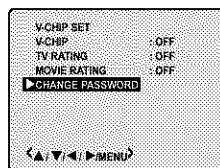
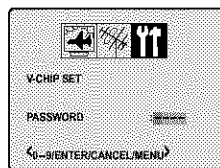

Picture control adjustment

Picture controls are factory preset but you can adjust them individually as follows:

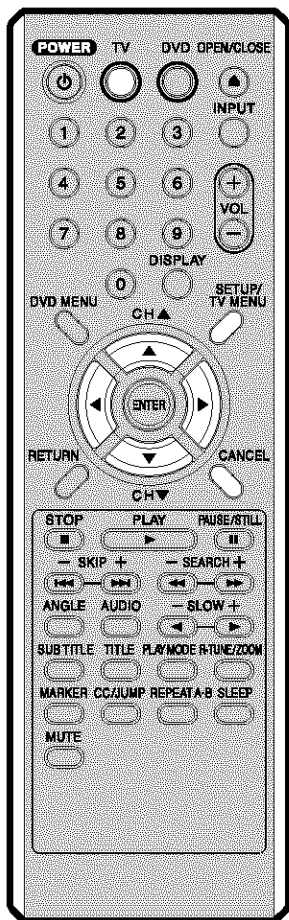

1 Press **TV** to select TV mode, then press **TV MENU**. The TV menu screen will appear.

2 Press **◀** or **▶** until PICTURE menu appears.



3 Press **▲** or **▼** to select the item you want to adjust.



4 Press **◀** or **▶** to adjust the setting.

	▶	◀
BRIGHTNESS	increase brightness	decrease brightness
CONTRAST	increase contrast	decrease contrast
COLOR	brilliant color	pale color
TINT	greenish color	reddish color
SHARPNESS	makes picture clearer	makes picture softer

5 After your desired setting changes press **TV MENU** until the MENU screen is cleared.

CANCEL

Pressing **CANCEL** while making picture adjustments will return all adjustments to the factory preset levels.

NOTE:

The **CONTRAST** default setting is set to maximum at the factory.

Stereo and second audio program (SAP)

The TV/DVD is equipped with a feature known as Multi-channel TV Sound or MTS. MTS broadcasts greatly enhance TV viewing by bringing you programs with high fidelity stereo sound. MTS also provides an extra channel called the Second Audio Program or SAP which broadcasters can use to transmit a second language for bilingual transmission or for other purposes.

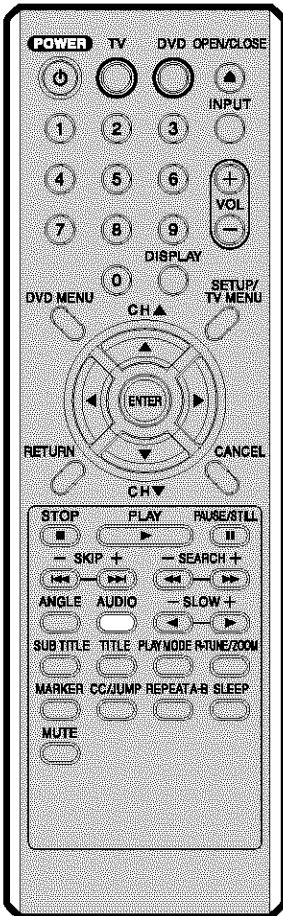

LISTENING TO STEREO SOUND

When the TV is turned on or a channel selection is made, make certain the **STEREO** appears on the screen. This means that "Stereo" broadcasting is available. You can enjoy stereo sound from the left and right speakers.

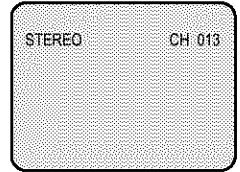

- When "Mono" broadcasting is received, no indication is displayed.
- If the broadcast signal is not strong enough or clear stereo sound is not available, press **AUDIO** to change to mono sound. The noise should be eliminated. Press it again to return to the stereo sound.

LISTENING TO SAP (SECOND AUDIO PROGRAM)

When the TV is turned on or a channel selection is made, make certain the SAP appears on the screen. This means that the "Second Audio Program" broadcasting is available.

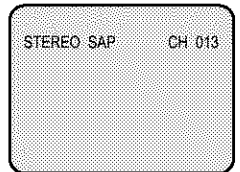

TO SELECT DESIRED SOUND

Press **AUDIO** to select the desired sound.

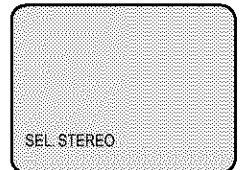

MONO+SAP BROADCASTING

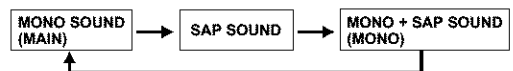

STEREO+SAP BROADCASTING

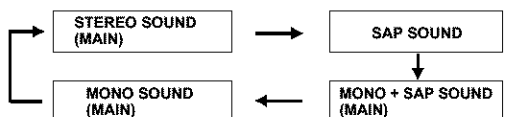

Preparation/Status display of disc

The following pages describe the setup/operation in DVD mode.

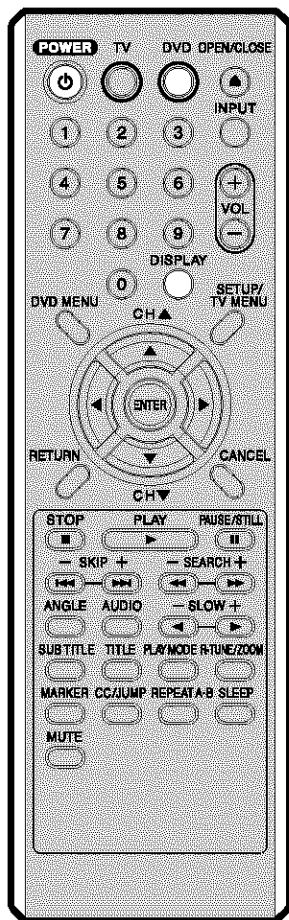

Preparation

Before DVD/CD operation, please make preparations as follows.

- 1 Insert the AC cord plug into a standard 120V 60Hz polarized AC outlet.
 - If the AC cord plug is plugged in for the first time, wait for about 5 seconds before pressing **POWER**.

NOTE: When connecting to other equipment, unplug the unit from the AC outlet.

- 2 Press **POWER** on the unit or on the remote control to turn on the unit. The **POWER** indicator will light.
 - Every time you press **POWER**, the TV/DVD starts from TV mode.
 - When using an amplifier, switch on the amplifier.

- 3 Press **DVD** on the remote control to select DVD mode. The DVD startup screen will appear on the screen.



Status display of disc

Press **DISPLAY**. The status display of the disc will appear on the screen.

DVD

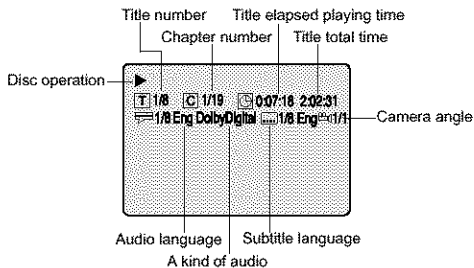

To make status display disappear, press **DISPLAY** again.

Audio CD/Video CD

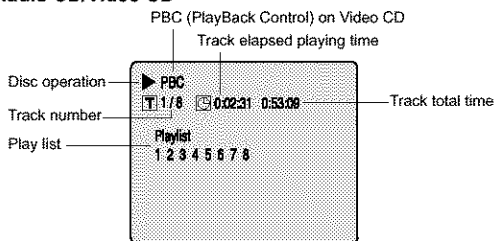

- When you play a CD disc, the status display will appear and remain on the screen.
- When you play the Video CD, Playlist will not appear on the screen.

Playback procedure

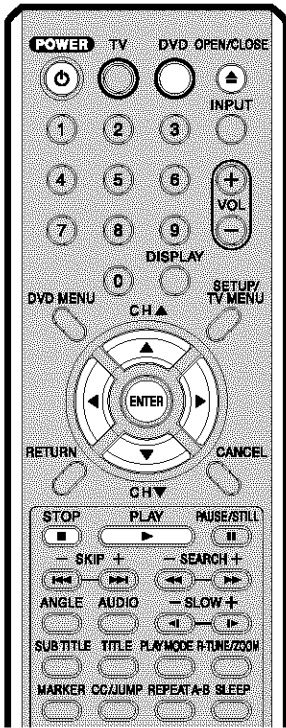

NOTES:

- If a non-compatible disc is loaded, "Incorrect Disc", "Region Code Error" or "Parental Error" will appear on the TV screen according to the type of loaded disc. If these appear, check your disc again (see pages 9 and 38).
- Some discs may take a minute or so to start playback.
- When you set a single-faced disc label downwards (ie. the wrong way up) and press **PLAY** or **OPEN/CLOSE** on the unit, a disc icon will appear on the display for about 3 seconds and then "No Disc" or "Incorrect Disc" will be displayed.
- Some playback operations of DVDs may be intentionally fixed by software producers. Since this unit plays DVDs according to the disc contents the software producers designed, some playback features may not be available. Also refer to the instructions supplied with the DVDs.

- 1 Press **DVD** on the remote control to select DVD mode.
Press **OPEN/CLOSE** on the unit or the remote control.
The disc tray will open.

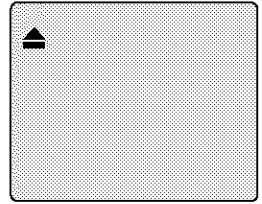

- 2 Place a disc onto the tray.
Position it with the printed label side up, align it with the guides, and place it in its proper position.

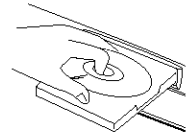

- 3 Press **OPEN/CLOSE** or **PLAY**.
The disc tray closes automatically.
The TV-screen, ▲ changes to a disc icon and then playback commences.

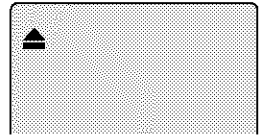

- A menu screen will appear on the TV screen, if the disc has a menu feature.

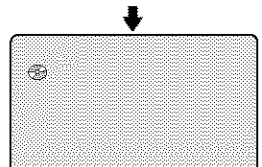

- 4 Press ▲/▼ or ◀/▶ to make a selection.

- 5 Press **ENTER**.
 - Title is selected and play commences.

- 6 Press **STOP** to end playback.
 - The unit memorizes the stopped point, depending on the disc. "■" appears on the screen. Press **PLAY** to resume playback (from the scene point).
 - If you press **STOP** again or unload the disc ("■" appears on the screen.), the unit will clear the stopped point.

- 7 Press **OPEN/CLOSE**.
The disc tray opens.
Remove the disc and press **OPEN/CLOSE** then press **POWER**.
The disc tray closes and unit turns off.

Special playback

Note: There may be a slight delay between when you press the button and the function activating.

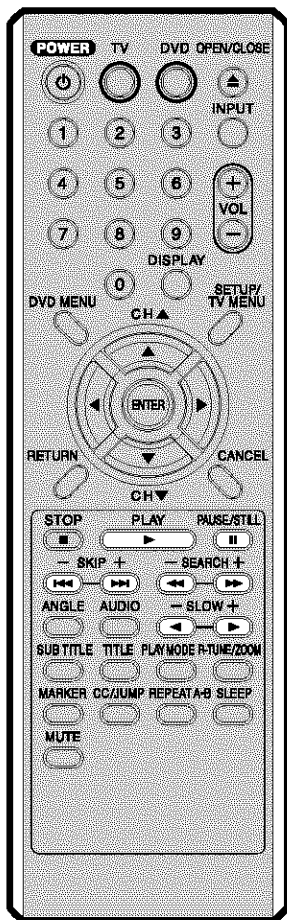

NOTE:

The unit is capable of holding a still video image or On screen display image on your television screen indefinitely. If you leave the still video image or On screen display image displayed on your TV for an extended period of time, you risk permanent damage to your television screen. Projection televisions are very susceptible.

Fast Forward Playback

Press **SEARCH +** during normal playback.

Each press of the **SEARCH +** will increase the speed of the search **▶▶** (x 2), **▶▶▶** (x 4), **▶▶▶▶** (x 8), **▶▶▶▶▶** (x 15).

(CD: **▶▶** (x 2), **▶▶▶** (x 4), **▶▶▶▶** (x 8), **▶▶▶▶▶** (x 20))

- To resume normal playback, press **PLAY**.

Review Playback

Press **SEARCH -** during normal playback.

Each press of the **SEARCH -** will increase the speed of the search **◀◀** (x 2), **◀◀◀** (x 4), **◀◀◀◀** (x 8), **◀◀◀◀◀** (x 15).

(CD: **◀◀** (x 2), **◀◀◀** (x 4), **◀◀◀◀** (x 8), **◀◀◀◀◀** (x 20))

- To resume normal playback, press **PLAY**.

Still Playback

Press **PAUSE/STILL** during normal playback to pause playback.

To resume normal playback, press **PLAY**.

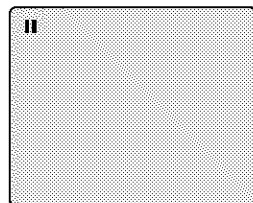

Frame Advance

Press **PAUSE/STILL** during still playback.

One frame is advanced each time you press **PAUSE/STILL**.

To resume normal playback, press **PLAY**.

Slow-motion Playback

Press **SLOW -** Reverse or **SLOW +** Forward during normal playback or still playback.

Each press of **SLOW** will change the speed of the slow x1/2, x1/4, x1/6, x1/8.

- To resume normal playback, press **PLAY**.
- To resume the still playback, press **PAUSE/STILL**.

Locating a chapter or track

Press **SKIP +** Forward or **SKIP -** Reverse during playback to locate a chapter that you want to watch.

Each time you press the button, a chapter or track is skipped.

This player can play back the MP3-data which has been recorded on CD-R or CD-RW. To produce the MP3-data, you need a Windows-PC with CD-ROM drive and a MP3-encoding Software (not supplied). The Apple-HFS-System can not be played.

MP3 CD Information

Limitations on MP3 CD playback

- MP3 CD is the disc that is standardized by ISO9660, its file name must include 3-digits extension letters, "mp3".
- The directory and file names of the MP3 CD must correspond to the ISO standardized files.
- This unit can read 200 files per disc. If one directory has more than 200 files, it reads up to 200 files, the remaining files will be omitted.
- MP3 CD's cannot be used for playback for the purpose of recording.
- It may take more than one minute for this unit to read MP3 files depending on its structure.
- Music recorded by "Joliet Recording Specification" can be played back, the file name is displayed on the screen. Long file names will be condensed.
- The music files recorded by "Hierarchical File System" (HFS) cannot be played.

Notes on MP3 files

To play back MP3 CD in the recorded order,

1. Use MP3 software that records data alphabetically or numerically.
2. Name each file including two-digit or three-digit number (e.g. "01" "02" or "001" "002").
3. Refrain from making too many sub-folders.

CAUTION:

- Some MP3 CDs can not be played back depending on the recording conditions.
- The CD-R/RW that has no music data or non-MP3 files can not be played back.

- 1 Press **OPEN/CLOSE**.
The disc tray will open.
Place a disc onto the tray.

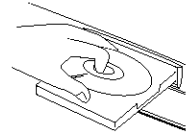

- 2 Press **DVD** to select the DVD mode. Press **PLAY** or **OPEN/CLOSE**. The disc tray closes automatically. On the TV-screen, "Scanning..." will appear. Scanning will take as much time as the number of file.

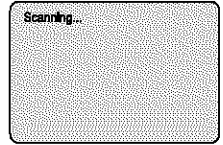

- 3 A MP3 menu screen will appear on the TV screen. Press **▲/▼** or **◀/▶** or **Number buttons (0-9)** to select the desired track, then press **ENTER**. Track is selected and play commences.

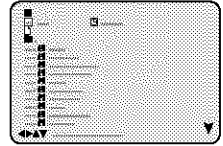

- In case the folder includes more than 11 tracks, press **◀** or **▶** to display next track list.

- 4 Press **STOP** to end playback.
 - The unit records the stopped point. "■" appears on the screen. Press **PLAY** to resume playback (from the scene point).
 - If you press **STOP** again or unload the disc, the unit will clear the stopped point.

- 5 Then press **OPEN/CLOSE**.

The disc tray opens.

Remove the disc and press **POWER**.

The disc tray closes automatically and the unit turns off.

NOTES:

- During MP3 Playback, you can not use SEARCH, A-B Repeat functions.
- You can use Repeat (Track or All), Random functions and Program playback for MP3 CD Playback. (See page 31)

Zooming/Locating desired scene

Zooming

This unit will allow you to zoom in on the frame image. You can then make selections by switching the position of the frame.

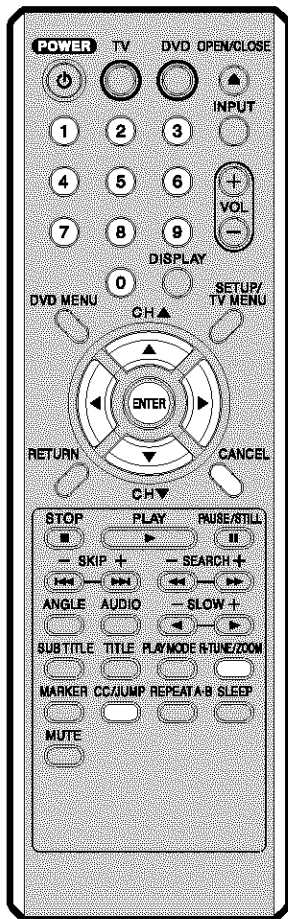

- 1 Press **ZOOM** during playback.
The center part of the image will be zoomed in.
Each press of **ZOOM** will change the ZOOM **Q** 1 (x 2), **Q** 2 (x 3) and **Q** 3 (x 4).

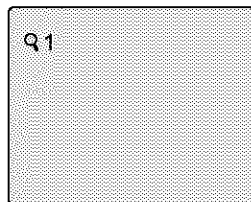

- 2 Press **▲/▼/◀/▶** to view a different part of the frame.
You may move the frame from the center position to UP, DOWN, LEFT or RIGHT direction.
- 3 In the zoom mode press **ZOOM** repeatedly to return to a 1:1 view (**Q** Off).

Locating Desired Scene

Use the title, chapter and time recorded on the disc to locate the desired point to play back.

- 1 Press **JUMP** during playback.

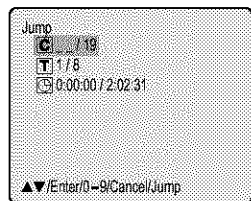

- 2 Press **▲** or **▼** to select the "**C**" (Chapter), "**T**" (Title/Track) or "**C**" (Time)".
- 3 Press **Number buttons (0-9)** to input the number.

NOTES:

- You can select the Pause, Slow or Search playback in the zoom mode.
- Some discs may not respond to zoom feature.

- If you input a wrong number, press **CANCEL**.
- Refer to the package supplied with the disc to check the numbers.

- 4 Press **ENTER**.

- Playback starts.
- When you change the title, playback starts from Chapter 1 of the selected title.
- Some discs may not work in the above operation.

Repeat/Random/Program playback and Repeat A-B

Press **PLAY MODE** during playback or stop mode.

Each time you press **PLAY MODE**, playback mode changes as follows.

DVD

On screen display	Operation
→ Title:	Repeats the current title.
↓ Chapter:	Repeats the current chapter.
↓ Off:	Resumes normal playback.

- During stop mode, **PLAY MODE** key is not effective.

Audio CD/Video CD/MP3 CD

On screen display	Operation
→ All:	Repeats entire disc.
↓ Track:	Repeats the current track.
↓ Random Play:	Plays the tracks in random order.
↓ *Program:	Plays the tracks in program order.
↓ (Status display):	Resumes normal playback.

- During stop mode, you can not select " Track".
- Random playback and Program playback do not function on the Video CD.

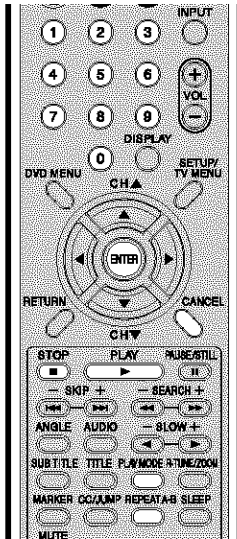

*Program menu

Use **number buttons (0–9)** to enter the track's number you want to program, then press **ENTER**. The track number and total time are displayed. Repeat this step to enter additional tracks. When you have finished entering tracks, press **PLAY** to start Program playback.

A playlist of your programmed tracks is displayed.

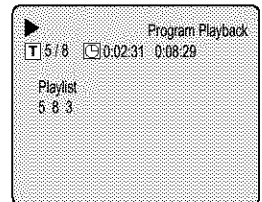
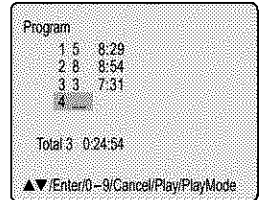

NOTES:

- If you enter a wrong number – press **CANCEL**.
- To cancel program play, press **STOP** 3 times.
- To clear the programs on the program menu – press **CANCEL** until all programs are cleared.
- The program is cancelled when you open the disc tray or turn off the power.

Repeat A-B

Repeat A-B playback allows you to repeat material between two selected points.

- 1 Press **REPEAT A-B** during playback. The start point is selected.

- 2 Press **REPEAT A-B** again. The end point is selected. Playback starts at the point that you selected. Playback stops at the end point, returns to Point A automatically, then starts again.

To resume normal playback press **REPEAT A-B** again. " Off" appears on the screen.

NOTES:

- Some discs may not work with the repeat operation.
- In Repeat A-B mode, subtitles near point A or B may not appear.
- You may not be able to set Repeat A-B, depending on the scenes of the DVD.
- Repeat A-B does not work with MP3 CDs and interactive DVDs.

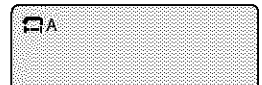

Marking desired scenes

The TV/DVD stores the points that you want to watch again. You can resume playback from that scene.

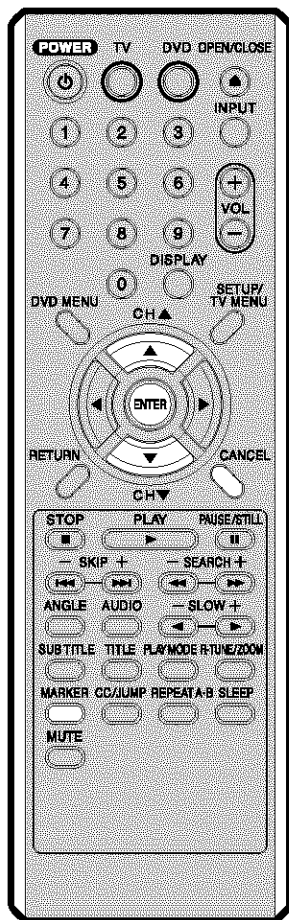

Marking the Scenes

1 Press **MARKER** during playback.

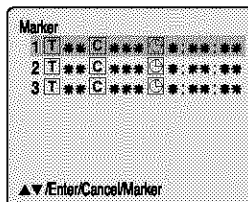

2 Select the blank Marker using **▲/▼**, then press **ENTER** at the desired scene.

- Up to 3 scenes can be selected.
- Repeat this procedure to set the other 2 scenes.

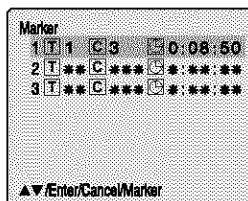

3 Press **MARKER** to remove this display.

Returning to the Scenes

1 Press **MARKER** during playback or stop mode.

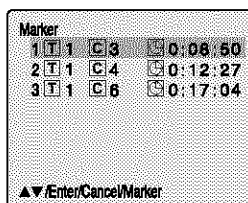

2 Press **▲** or **▼** to select the Marker 1-3.

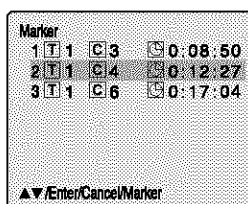

3 Press **ENTER**.
Playback starts from the marked scene.

NOTES:

- The marking is canceled when you open the disc tray or turn the power off.
- Some subtitles recorded around the marker may fail to appear. [DVD]

To Cancel the Mark

1 Press **MARKER**.

2 Press **▲** or **▼** to select the Marker 1-3.

3 Press **CANCEL**.

Changing soundtrack language/Subtitles

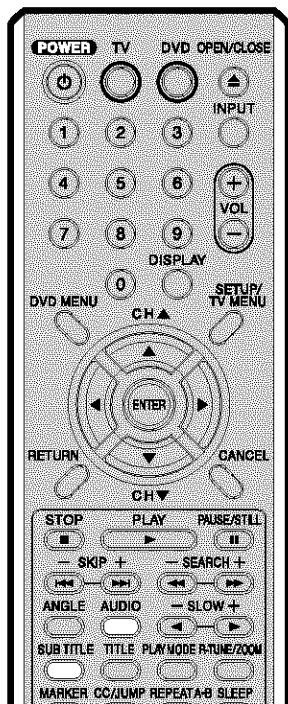

Changing soundtrack language

You can select the language when you play a multilingual disc.

- 1 Press **AUDIO** during playback.

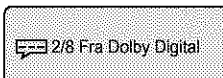

The current soundtrack language will appear.

- 2 Press **AUDIO** repeatedly until the desired language is selected.

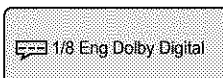

The on-screen display will disappear after a few seconds.

In case of Video CD playback

Audio type changes as follows each time you press **AUDIO**.

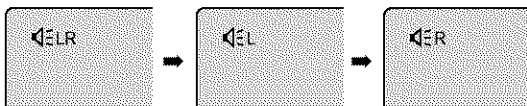

NOTES:

- If the desired language is not heard after pressing the **SUB TITLE** button several times, the language is not recorded on the disc.
- Changing soundtrack language is cancelled when you open the disc tray. The initial default language or available language will be heard if the disc is played back again.
- Changing subtitle language is cancelled when you open the disc tray or turn the power off.
- Some functions may not work on some DVDs. You may not be able to turn subtitles on or off or change subtitles. While playing the DVD, the subtitle may change when:
 - you open or close the disc tray
 - you change the title.
- In some cases, the subtitle language is not changed to the selected one immediately.

Subtitles

Turning the Subtitles On and Off

When playing back a disc recorded with subtitles, you can turn the subtitles on or off.

Press **SUB TITLE** during playback until "Off" appears.



Changing the subtitle language

You can select the language when playing back a disc recorded with multi-lingual subtitles.

- 1 Press **SUB TITLE** repeatedly during playback until your desired language appears.

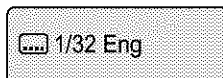

- 2 The on-screen display will disappear after a few seconds.

Changing angles/Title selection/DVD menu

Changing angles

When playing back a disc recorded with multi-angle facility, you can change the view angle.

- 1 Press **ANGLE** during playback.

The current angle will appear.

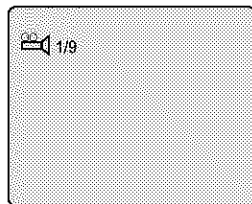

- 2 Press **ANGLE** repeatedly until the desired angle is selected.

Title selection

Two or more titles are recorded on some discs. If the title menu is recorded on the disc, you can select the desired title.

- 1 Press **TITLE** during playback.
Title menu appears on the screen.

- 2 Press **▲/▼** or **◀/▶** to select the desired title.

- 3 Press **ENTER** or **PLAY**.
The playback of the selected title will start.

DVD menu

Some DVDs allow you to select the disc contents using the menu.

When you play back these DVDs, you can select the subtitle language and sound-track language, etc. using the DVD menu.

- 1 Press **DVD MENU** during playback.
The DVD menu appears on the screen.

• Press **DVD MENU** again to resume playback at the scene when you pressed **DVD MENU**.

- 2 Press **▲/▼** or **◀/▶** to select the desired item.

- 3 Press **ENTER**.
The menu continues to another screen. Repeat steps 2 and 3 to set additional items if any.

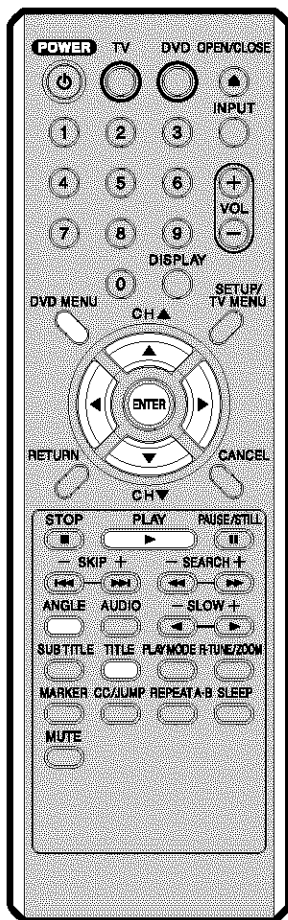

NOTES:

- Depending on the DVD, you may not be able to change the angles even if multi-angles are recorded on the DVD.
- Depending on the DVD, you may not be able to select the title. Depending on the DVD, a "title menu" may simply be called a "menu" or "title" in the instructions supplied with the disc.

Setting language

You can change the default settings to customise performance to your preference.

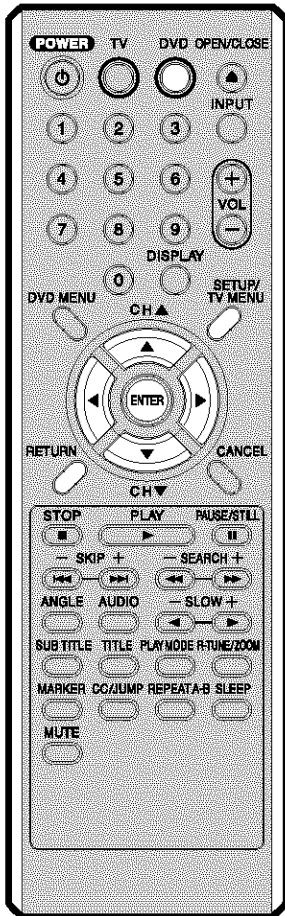

1 Press **DVD** to select DVD mode.
Press **SETUP** in the stop mode or No Disc.
Press **▲** or **▼** to select "Language", then press **▶** or **ENTER**.

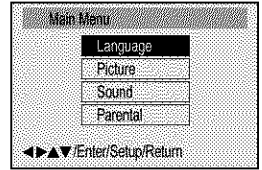

2 Press **▲** or **▼** to select "OSD Language", then press **▶** or **ENTER**.

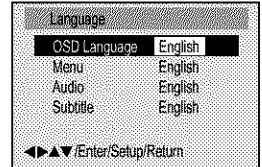

3 Press **▲** or **▼** to select desired language (e.g. English), then press **ENTER**.
The menu returns to "Language" menu automatically.

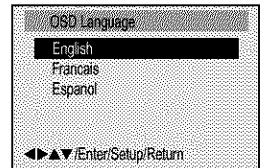

• If you want to return to the previous menu, press **◀** or **RETURN**.

4 Repeat steps 2-3 for other "Language" setting.

Other Selection: (Menu/Audio/Subtitle)

If you want to select another language, enter the language code (see the Language code list on page 41).

Off: (subtitle)

Subtitles do not appear.

5 Press **SETUP** to remove the Menu screen.

NOTES:

- If the selected soundtrack language is not recorded on the disc, the original language will be heard.
- If the selected subtitle language is not recorded on the disc, the first-priority language is selected.

Setting the aspect ratio of TV screen/Setting on screen display

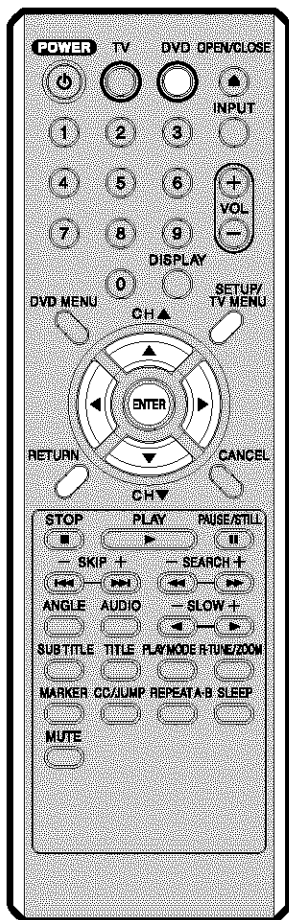

Setting the aspect ratio of TV screen

You can select the aspect ratio for your TV.

- 1 Press **DVD** to select DVD mode.
Press **SETUP** in the stop mode or No Disc.
Press **▲** or **▼** to select "Picture", then press **▶** or **ENTER**.
- 2 Press **▲** or **▼** to select "TV Screen", then press **▶** or **ENTER**.
- 3 Press **▲** or **▼** to select your desired screen type, then press **ENTER**.

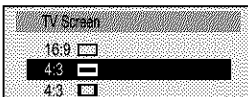
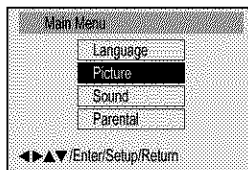

You have the following screen sizes to choose from:

16:9 Wide screen

Select this mode when connecting to a wide-screen TV. A wide screen picture is displayed full size.

4:3 Letterbox

Select this mode when connecting to a conventional TV. When playing back a wide screen-DVD disc, it displays the wide picture with black bands at the top and bottom of screen.

4:3 Panscan

It displays the wide picture on the whole screen with left and right edges automatically cut off.

- If you want to return to the previous menu, press **◀** or **RETURN**.

- 4 Press **SETUP** to remove the Menu screen.

Setting on screen display

On screen display can be switched on or off when you press the buttons.

- 1 Press **DVD** to select DVD mode.
Press **SETUP** in the stop mode or No Disc.
Press **▲** or **▼** to select "Picture", then press **▶** or **ENTER**.
- 2 Press **▲** or **▼** to select "Display".
- 3 Press **▶** or **ENTER** to select "On" or "Off".

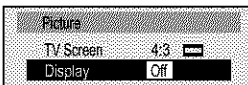
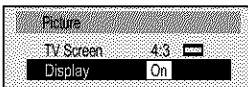

On: On screen displays appear when you press the buttons (factory setting).

Off: On screen displays do not appear when you press any buttons.

- If you want to return to the previous menu, press **◀** or **RETURN**.

- 4 Press **SETUP** to remove the Menu screen.

NOTE:

If the DVD disc is not formatted in the pan & scan style, it displays 4:3 style.

Dynamic Range Control

DRC (Dynamic Range Control) enables you to control the dynamic range so as to achieve a suitable sound for your equipment.

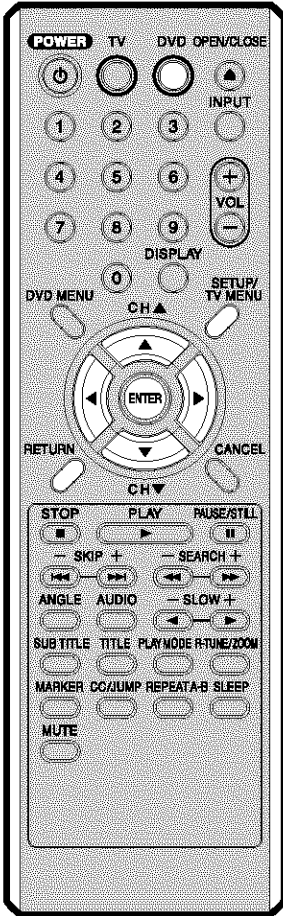

- 1 Press **DVD** to select DVD mode. Press **SETUP** in the stop mode or No Disc. Press **▲** or **▼** to select "Sound".

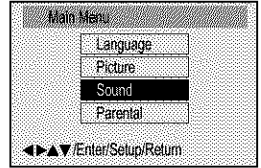

- 2 Press **▶** or **ENTER** to select "DRC".

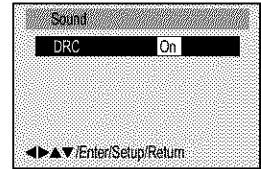

- 3 Press **▶** or **ENTER** to select "On" or "Off".

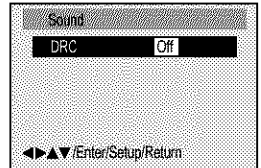

- If you want to return to the previous menu, press **◀** or **RETURN**.

- 4 Press **SETUP** to remove the Menu screen.

NOTES:

- This function works only during playback of Dolby Digital recorded discs.
- The level of Dynamic Range Reduction may differ depending on DVD video disc.

Parental control setting

Some discs are specified not suitable for children. Such discs can be prevented from play back with the unit.

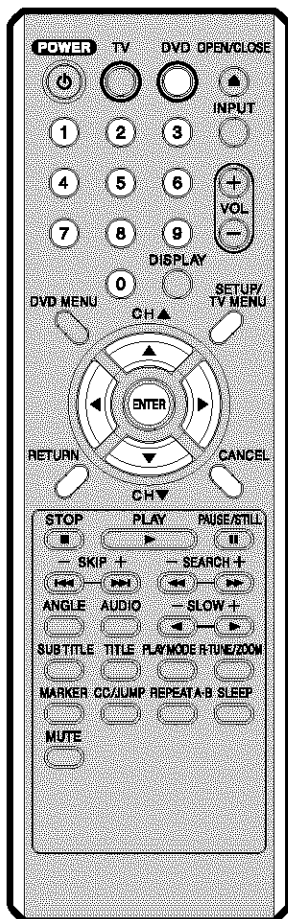

NOTES:

- If each setup (P.35–39) has been completed, the unit can always be operated under the same conditions (especially with DVD discs). Each setup will be retained in the memory when you turn the power off.
- Depending on the discs, the unit cannot limit playback.
- Some discs may not be encoded with specific rating level information though its disc jacket says "adult." For those discs, the age restriction will not work.

- 1 Press **DVD** to select DVD mode. Press **SETUP** in the stop mode or No Disc. Press **▲** or **▼** to select "Parental", then press **▶** or **ENTER**.

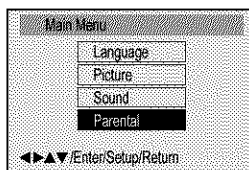

- 2 Press **▲** or **▼** to select "Parental Level", then press **▶** or **ENTER**.

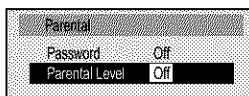

- 3 Press **▲** or **▼** to select a level from Off or 1–8. Press **▶** or **ENTER** to set the selected level.

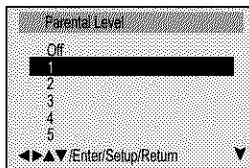

- **Level Off:** The parental control setting does not function. (Factory preset)
 - **Level 1:** **LOCK ALL:** Playback of all DVDs is prohibited. (Use to prohibit play of mature theme DVDs not encoded with a rating level.)
 - **Level 2:** DVDs expressly for children can be played back.
 - **Level 3 to 7:** DVDs for general audiences/children can be played back. (DVDs with mature content are prohibited.)
 - **Level 8:** **NO LIMIT:** All DVDs can be played back.
- Select from the level 1 to level 8. The limitation will be more severe as the level number is lower.

- 4 Press **▲** or **▼** to select "Password", then press **▶** or **ENTER**.

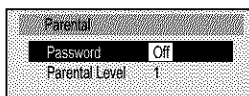

- 5 Press **number buttons (0–9)** for the password. Don't forget the password. • If you input a wrong number, press **CANCEL**.

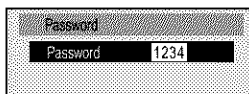

- 6 Press **ENTER** to store the password. **Note:** Now the rating is locked and the setting cannot be changed unless you enter the correct password.

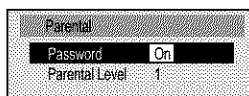

- If you want to return to the previous menu, press **◀** or **RETURN**.

- 7 Press **SETUP** to remove the parental control screen.

To change the parental level

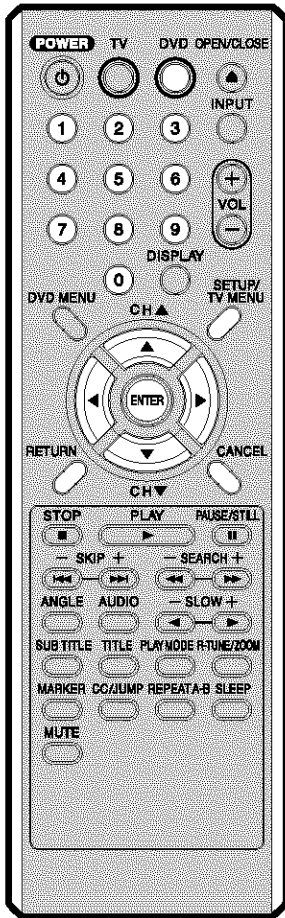

NOTE:

Do not forget the password. If you forget the password, in the No Disc DVD mode, press and hold **STOP** on the unit, and simultaneously press and hold **7** on the remote control for more than 3 seconds. "PASSWORD CLEAR" appears on the screen. The password has been cleared. The above procedure will clear the password only.

- 1 Press **DVD** to select DVD mode. Press **SETUP** in the stop mode or No Disc. Press **▲** or **▼** to select "Parental", then press **▶** or **ENTER**.

- 2 Press **▲** or **▼** to select "Password", then press **▶** or **ENTER**.

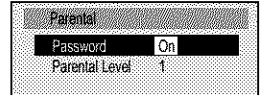

- 3 Press **number buttons (0-9)** to enter the password you have stored.

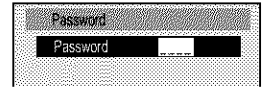

• If you input a wrong number, press **CANCEL**.

- 4 Press **ENTER**. The password is now Off.

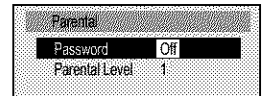

- 5 Press **▲** or **▼** to select "Parental Level". Then press **▶** or **ENTER**. The Parental Level screen is displayed.

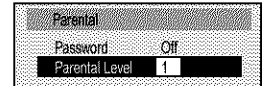

- 6 Press **▲** or **▼** to select a level from Off or 1-8 and then press **▶** or **ENTER**.

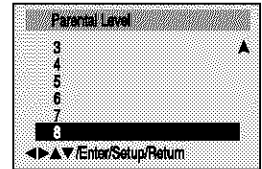

- 7 Press **▲** or **▼** to select "Password" and then press **▶** or **ENTER**.

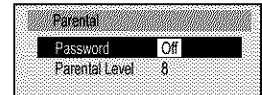

- 8 Press **number buttons (0-9)** to enter a 4-digit password.

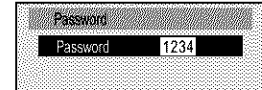

Note: You can enter a new password.

- 9 Press **ENTER**. The parental level is now changed and locked.

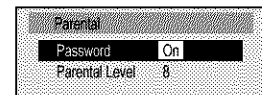

• If you want to return to the previous menu, press **◀** or **RETURN**.

- 10 Press **SETUP** to remove the parental control screen.

Temporary disabling of rating level by DVD disc

Depending on the DVD disc, the disc may try to temporarily cancel the rating level that you have set. It is up to you to decide whether to cancel the rating level or not.

- 1 Load a DVD disc and press **PLAY** (see page 27).

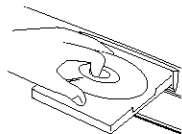

- 2 If the DVD disc has been designed to temporarily cancel the Rating level, the screen which appears after inserting a DVD will change, depending on which disc is played. If you select "YES" with the **ENTER** key, "Your disc exceeds the parental control level." screen will then appear.

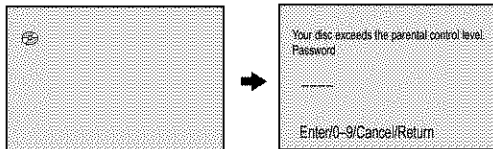

- 3 If you wish to cancel the set rating level temporarily, enter the 4-digit password. Then press **ENTER**. Alternatively, if the password has not been set, playback will commence. If you don't know (or have forgotten) the password, select "STOP". The setting screen will disappear. Press **OPEN/CLOSE** to remove the disc.

To quit entering, press **RETURN**.

- 4 Playback will commence if the entered password was correct.

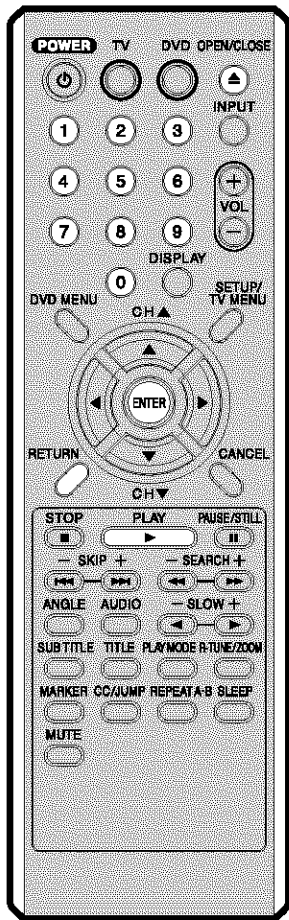

NOTE:

The rating level will remain disabled until the disc is ejected.

When the disc is ejected, the original rating level will be set again automatically.

Language code list

Enter the appropriate code number for the initial settings "AUDIO", "SUBTITLE" and/or "MENU LANGUAGE" (see page 35).

Language Name Code	Language Name Code	Language Name Code	Language Name Code
Abkhazian 1112	Fiji 1620	Lingala 2224	Singhalese 2919
Afar 1111	Finnish 1619	Lithuanian 2230	Slovak 2921
Afrikaans 1116	French 1628	Macedonian 2321	Slovenian 2922
Albanian 2927	Frisian 1635	Malagasy 2317	Somali 2925
Amharic 1123	Galician 1722	Malay 2329	Spanish 1529
Arabic 1128	Georgian 2111	Malayalam 2322	Sundanese 2931
Armenian 1835	German 1415	Maltese 2330	Swahili 2933
Assamese 1129	Greek 1522	Maori 2319	Swedish 2932
Aymara 1135	Greenlandic 2122	Marathi 2328	Tagalog 3022
Azerbaijani 1136	Guarani 1724	Moldavian 2325	Tajik 3017
Bashkir 1211	Gujarati 1731	Mongolian 2324	Tamil 3011
Basque 1531	Hausa 1811	Nauru 2411	Tatar 3030
Bengali; Bangla 1224	Hebrew 1933	Nepali 2415	Telugu 3015
Bhutani 1436	Hindi 1819	Norwegian 2425	Thai 3018
Bihari 1218	Hungarian 1831	Oriya 2528	Tibetan 1225
Breton 1228	Icelandic 1929	Panjabi 2611	Tigrinya 3019
Bulgarian 1217	Indonesian 1924	Pashto, Pushto 2629	Tonga 3025
Burmese 2335	Interlingua 1911	Persian 1611	Turkish 3028
Byelorussian 1215	Irish 1711	Polish 2622	Turkmen 3021
Cambodian 2123	Italian 1930	Portuguese 2630	Twi 3033
Catalan 1311	Japanese 2011	Quechua 2731	Ukrainian 3121
Chinese 3618	Javanese 2033	Rhaeto-Romance 2823	Urdu 3128
Corsican 1325	Kannada 2124	Romanian 2825	Uzbek 3136
Croatian 1828	Kashmiri 2129	Russian 2831	Vietnamese 3219
Czech 1329	Kazakh 2121	Samoan 2923	Volapük 3225
Danish 1411	Kirghiz 2135	Sanskrit 2911	Welsh 1335
Dutch 2422	Korean 2125	Scots Gaelic 1714	Wolof 3325
English 1524	Kurdish 2131	Serbian 2928	Xhosa 3418
Esperanto 1525	Laothian 2225	Serbo-Croatian 2918	Yiddish 2019
Estonian 1530	Latin 2211	Shona 2924	Yoruba 3525
Faroese 1625	Latvian, Lettish 2232	Sindhi 2914	Zulu 3631

Connections to other equipment

The exact arrangement you use to interconnect various video and audio components to the TV/DVD is dependent on the model and features of each component. Check the Owner's Manual provided with each component for the location of video and audio inputs and outputs.

Using an Audio Amplifier

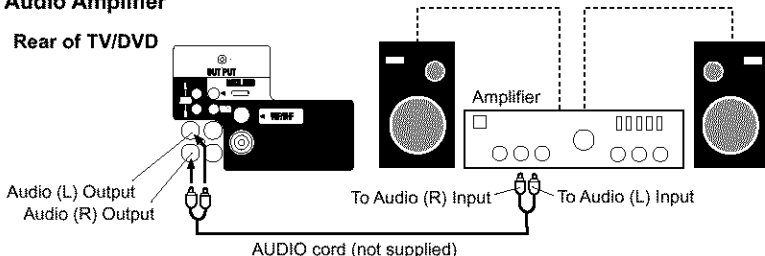

Using an AV Amplifier with built-in digital surround

If you are using an Amplifier with a built-in digital surround as follows, you can enjoy the various audio systems including Dolby Digital Surround audio that sounds just like the movie.

Connect an AV amplifier with built-in Dolby Digital decoder, DTS decoder, MPEG decoder or etc as shown below.

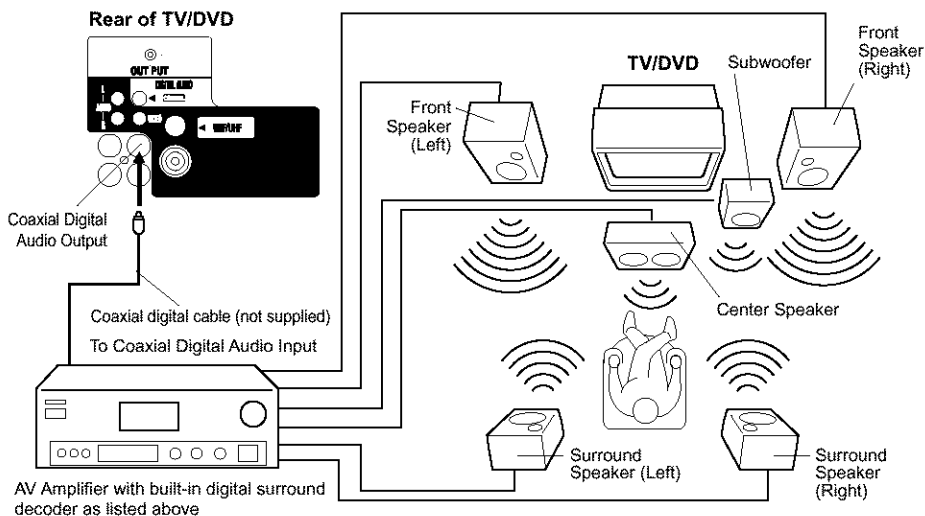

* Manufactured under license from Dolby Laboratories. "Dolby" and the double-D symbol are trademarks of Dolby Laboratories. Confidential unpublished works. © 1992-1997 Dolby Laboratories, Inc. All rights reserved.

* "DTS" and "DTS Digital Out" are trademarks of Digital Theater Systems, Inc.

NOTES:

- When you make the connections above, do not set DOLBY DIGITAL to DOLBY DIGITAL, MPEG to MPEG to ON on the AV Amplifier. If you do, a loud noise will suddenly come out from the speakers, affecting your ears or causing the speakers to be damaged.
- When playing DTS-encoded CDs, only noise will be heard from the speakers or analogue stereo outputs.
- Some DTS decoders which do not support DVD-DTS interface may not work properly with the unit.

Using the audio/video inputs

If you connect the TV/DVD to VCR, camcorder or TV game, you can select by pressing **INPUT**.

Press **INPUT** repeatedly to select the desired mode. "LINE" or TV channel will display on the screen.

NOTE:

In the DVD mode this key will not operate.



1. To connect the TV/DVD to a VCR

Press the **INPUT** to select the desired mode to use the TV as a monitor. Operate your VCR as usual.

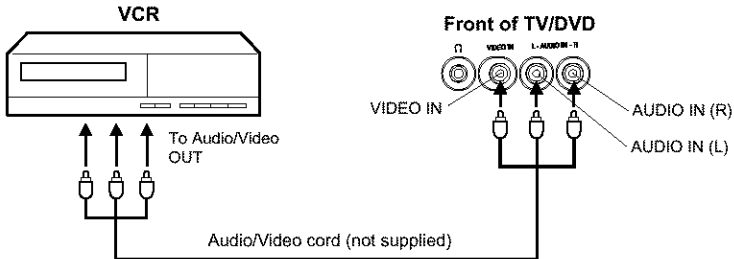

2. To connect the TV to a camcorder

To playback from the camcorder, connect the camcorder to the TV/DVD as shown.

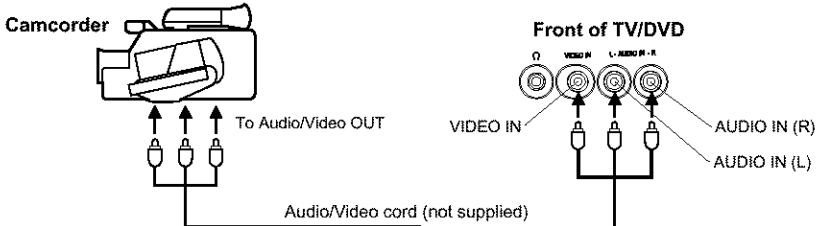

3. To connect the TV to a TV Game

The TV/DVD can also be used as a display device for many video games. However, due to the wide variety of different types of signal generated by these devices and subsequent hook-up variations required, they have not all been included in the suggested connection diagrams. You'll need to consult each component's Owner's Manual for additional information.

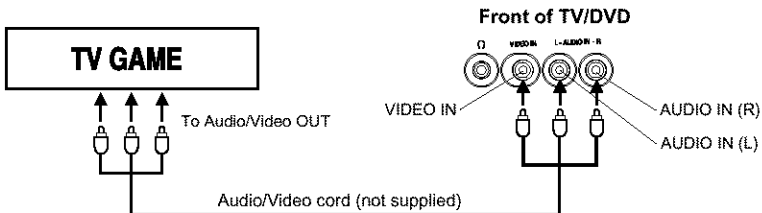

Problems and troubleshooting

Use the following check list for troubleshooting when you have problems with your unit. Consult your local dealer or service outlet if problems persist.

Be sure all connections are properly made when using with other units.

SYMPTOMS	POSSIBLE SOLUTIONS	PAGE
POWER		
TV/DVD does not operate.	<ul style="list-style-type: none"> • Make sure the power cord is plugged in. • Try another AC outlet. • Power is off, check fuse or circuit breaker. • Unplug unit, then plug it back in. • Connect the DC car cord to the cigarette lighter socket. • The DC car cord fuse is down, replace fuse. 	12,13
TV BROADCAST RECEPTION		
Poor sound or No sound	<ul style="list-style-type: none"> • Station or CATV experiencing problems, tune to another station. • Check Volume adjustments. • Check for sources of possible interference. 	16 16 46
Poor picture or No picture	<ul style="list-style-type: none"> • Station or CATV experiencing problems, tune to another station. • Check antenna or CATV connections, reorient antenna. • Check for sources of possible interference. • Check picture control adjustments. 	16 13,14 46 24
Poor reception on some channels	<ul style="list-style-type: none"> • Station or CATV experiencing problems, tune to another station. • Station signal is weak, reorient antenna to receive weaker station. • Check for sources of possible interference. 	16 13,14 46
Poor color or no color	<ul style="list-style-type: none"> • Station or CATV experiencing problems, tune to another station. • Make sure channels are set into memory. • Check picture control adjustments. • Check antenna or CATV connections, reorient antenna. • Check for sources of possible interference. 	16 20 24 13,14 46
Picture wobbles or drifts	<ul style="list-style-type: none"> • Station or CATV experiencing problems, tune to another station. • Make sure channels are set into memory. • CATV company is scrambling signal. • Check antenna orientation. 	16 20 — 13
No CATV reception	<ul style="list-style-type: none"> • Check all CATV connections. • Set TV/CATV menu option to the CATV mode. • Station or CATV system problems, try another station. 	14 19 16
Horizontal or diagonal bars on screen	<ul style="list-style-type: none"> • Check antenna connections, reorient antenna. • Check for sources of possible interference. 	13,14 46
No reception above channel 13	<ul style="list-style-type: none"> • Make sure TV/CATV menu option is in the appropriate mode. • If using antenna, check UHF antenna connections. 	19 13
TV shuts off	<ul style="list-style-type: none"> • No broadcast on station tuned. • Sleep Timer is set. • Power interrupted. 	20 17 —
Closed - Caption is not activated.	<ul style="list-style-type: none"> • TV station experiencing problems or program tuned is not closed captioned. Try another channel. • Check CATV connection or VHF/UHF antenna, reposition or rotate antenna. • Press CC button to turn on the closed caption decoder. 	16 13,14 18
Display is not shown in your language.	<ul style="list-style-type: none"> • Select proper language in the menu options. 	15

SYMPTOMS	POSSIBLE SOLUTIONS	PAGE
DVD		
Playback doesn't start.	<ul style="list-style-type: none"> • No disc is inserted. • The disc may be dirty. Clean up the disc. • The unit cannot play CD-ROMs, etc. 	27 9 —
No picture	<ul style="list-style-type: none"> • TV/DVD selector is not set correctly. 	26
No sound	<ul style="list-style-type: none"> • Check the input selector of the amplifier is set properly. • The unit is in the Special playback mode. • Select the correct Audio Output position on AV amplifier. 	— 28 42
Picture is distorted during CUE or REVIEW.	<ul style="list-style-type: none"> • The picture will be distorted occasionally. 	—
Stopping playback, search, slow-motion play, repeat play, or program play, etc. cannot be performed.	<ul style="list-style-type: none"> • Some discs may not do some of the functions. 	—
No 4:3 (16:9) picture	<ul style="list-style-type: none"> • The setup does not match your TV. 	36
No on-screen display	<ul style="list-style-type: none"> • Select Display On. 	36
No surround sound	<ul style="list-style-type: none"> • The setup does not match your stereo system. 	42
The unit or remote operation key is not functioning.	<ul style="list-style-type: none"> • Turn off the unit and unplug the AC power cord for several minutes, then replug it. 	—
Playback does not start when the title is selected.	<ul style="list-style-type: none"> • Check the RATING LEVEL setup. 	38~40
Audio soundtrack and/or subtitle language is not changed when you play back a DVD.	<ul style="list-style-type: none"> • Multilingual language is not recorded on the DVD disc. 	35
No subtitle	<ul style="list-style-type: none"> • Some discs have no subtitles. • Subtitles are cleared. Press SUB TITLE. 	33
Angle cannot be changed.	<ul style="list-style-type: none"> • Multi-angles are not recorded on the DVD disc. 	34
"O" appears on the screen.	<ul style="list-style-type: none"> • The function is prohibited with the unit or the disc. 	—
REMOTE CONTROL		
The remote control does not function.	<ul style="list-style-type: none"> • Aim at the remote control at the remote sensor. • Operate within Approx. 5 Meters or reduce the light in the room. • Clear the path of the beam. • The batteries are weak. Replace the batteries. • Check the batteries are inserted correctly. 	12

If you cannot resolve the problem, please call the Customer Satisfaction Center for product assistance at 1-800-211-PANA(7262).

To locate an authorized servicer call toll free 1-800-211-PANA(7262) or send e-mail to : consumerproducts@panasonic.com.

Reception disturbances

Most types of television interference can be remedied by adjusting the height and position of the VHF/UHF antenna. Outdoor antennas are recommended for best results. The most common types of television interference are shown below. If one of these symptoms appear when the TV/DVD is connected to a Cable TV system, the disturbance may be caused by the local Cable TV company broadcast.

IGNITION

Black spots or horizontal streaks may appear, the picture may flutter or drift. Usually caused by interference from automobile ignition systems, neon lamps or AC powered tools and appliances such as drills or hair dryers.



GHOSTS

Ghosts are caused by the television signal following two paths. One is the direct path and the other is reflected by tall buildings, hills or other large objects. Changing the direction or position of the antenna may improve the reception.

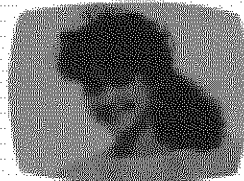

SNOW

If the TV/DVD is located far from the TV station, in a fringe reception area where the signal is weak, small dots may appear in the picture. If the signal is extremely weak, the installation of a larger external antenna may be necessary.

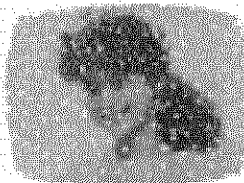

RADIO FREQUENCY INTERFERENCE (RFI)

Caused by two-way radios, this type of interference produces moving ripples or diagonal streaks in the picture. Some cases may cause a loss of contrast in the picture. Changing the direction and position of the antenna or installing an RFI filter may improve the picture.

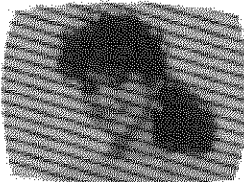

PICTURE SIZE VARIATION

A slight picture size variation is normal when you adjust the CONTRAST or BRIGHTNESS settings.



CARE AND MAINTENANCE

To prevent fire or shock hazard, disconnect the TV/DVD from the power source before cleaning. The finish on the cabinet may be cleaned with mild soap and a soft, damp cloth and cared for as other furniture. Use caution when cleaning or wiping the plastic parts.

GENERAL

Power supply:	AC 120V 60Hz DC 12V
Power consumption:	Operation: 55W (AC120V, DC12V) Stand by: 4W (AC120V), 3W (DC12V)
Weight:	8 kg (17.6 lbs)
Dimensions:	Width : 278 mm (10-15/16 inches) Height: 311.5 mm (12-1/4 inches) Depth : 312.5 mm (12-5/16 inches)
Operating temperature:	5° - 40°C
Operating humidity:	Less than 80% RH

TELEVISION

Picture tube:	9" (229 mm diagonal)
Tuner type:	Quartz PLL Frequency Synthesized
Receiving channels:	VHF 2-13 UHF 14-69 CATV 14-36 (A)-(W) 37-59 (AA)-(WW) 60-85 (AAA)-(ZZZ) 86-94 (86)-(94) 95-99 (A-5)-(A-1) 100-125 (100)-(125) 01 (5A)
Antenna input:	VHF/UHF In 75 ohm coaxial
Speaker:	3" (76 mm), 8 ohm x 2
Audio output power:	1.2W + 1.2W

DVD/CD player

Signal system:	NTSC
Applicable disc:	1. DVD (12cm, 8cm) 2. CD (12cm, 8cm)
Audio characteristics frequency response:	DVD: 4Hz - 22KHz CD: 4Hz - 20KHz
S/N Ratio:	90dB
Harmonic distortion:	0.06%
Wow and flutter:	Below Measurable Level
Input/Output:	Inputs : Video : (RCA) 1 Vp-p/75ohm Audio : (RCA) -8 dBm/50Kohm Outputs : Video : (RCA) 1 Vp-p/75ohm Audio : (RCA) -12 dBm/1Kohm
Digital audio out:	0.5Vp-p 75ohms terminated
Pickup:	CD : Wavelength: 775 - 815 nm Maximum output power: 0.5 mW DVD : Wavelength: 650 - 666 nm Maximum output power: 2.0 mW

ACCESSORIES:

Remote control
Batteries 2 "AAA"
Telescopic Antenna
12V DC Car Cord

Index of Controls

Remote Control Button

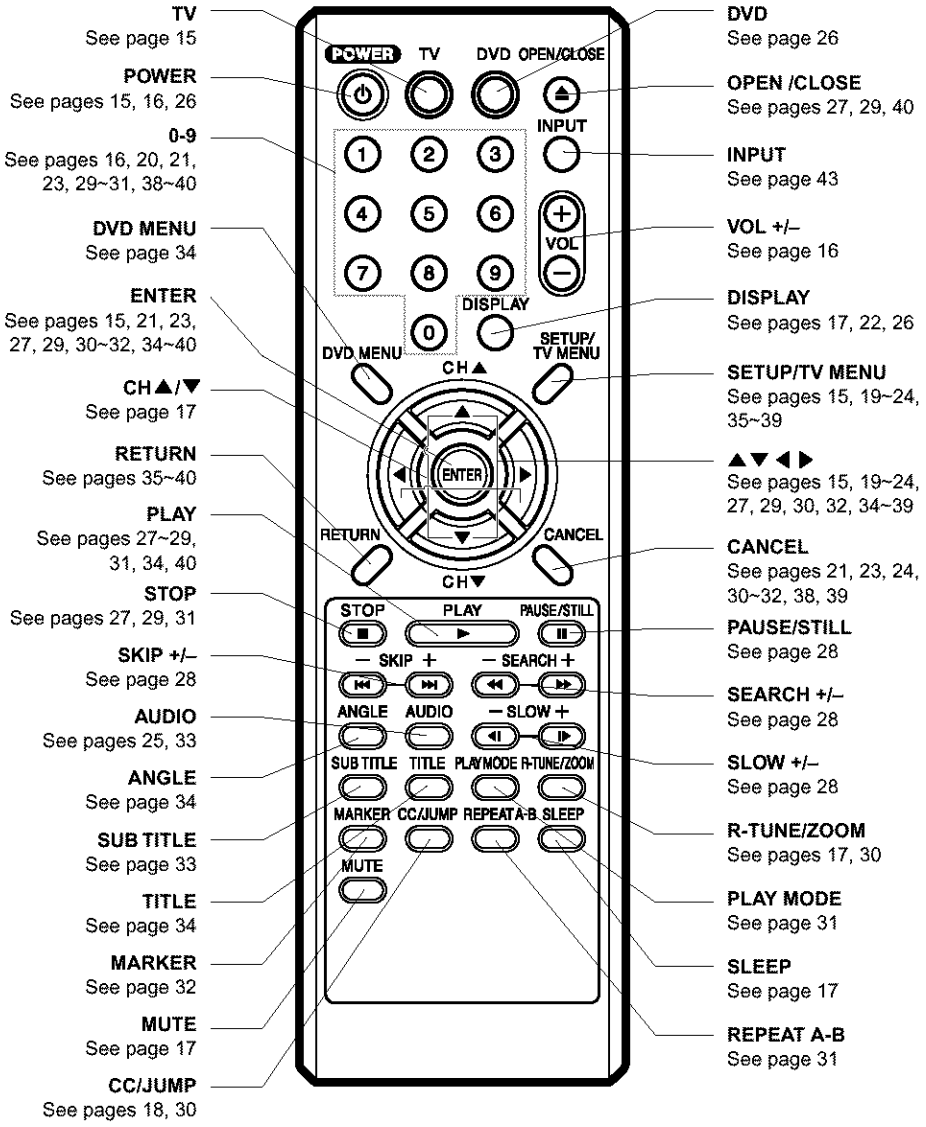

Front

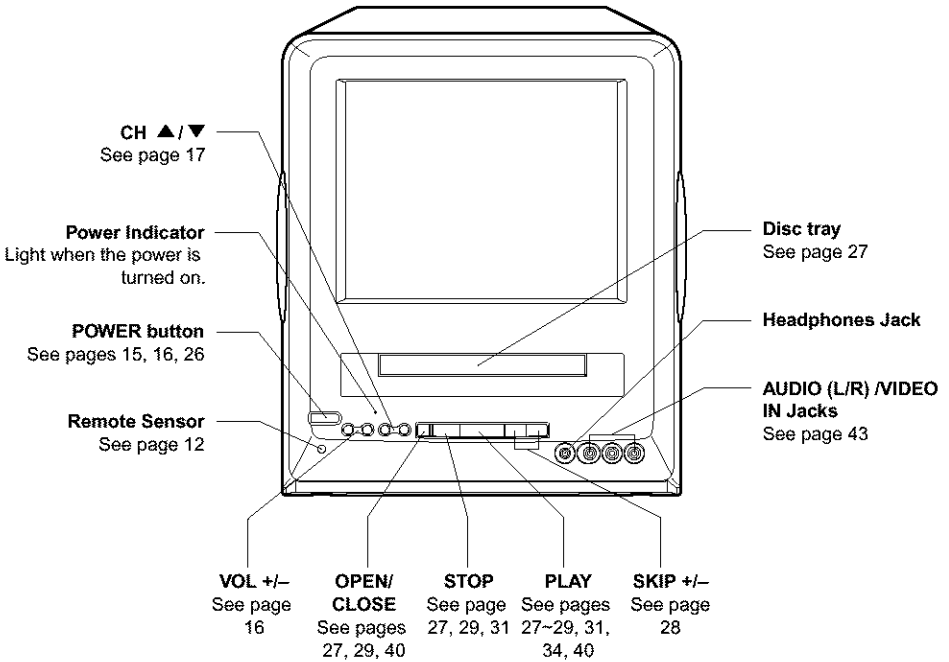

Rear

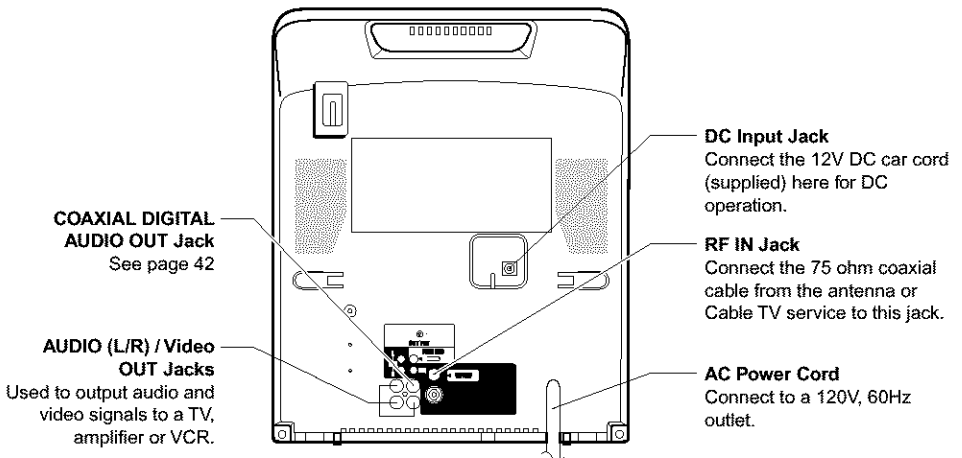

Spanish Quick Use Guide (Guía para rápida consulta)

Conexiones de la antena

Antena combinada de VHF/UHF (Cable único de 75 ohmios o cable con doble conductor de 300 ohmios)

Conecte el cable de 75 ohmios de la antena combinada de VHF/UHF en el jack de la antena. Si su antena combinada de VHF/UHF posee un cable de dos conductores de 300 ohmios, es posible que sea necesario utilizar un transformador de adaptación de 300-75 ohmios.

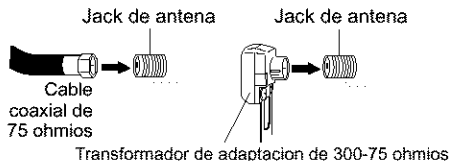

Antena combinada de VHF/UHF (Cables de 300 ohmios independientes de dos conductores de VHF y de UHF)

Conecte el cable de dos conductores de 300 ohmios de UHF en el combinador (no suministrado). Conecte el cable de dos conductores de 300 ohmios de VHF en el transformador de adaptación de 300-75 ohmios. Conecte el transformador al combinador, y luego conecte el combinador al jack de la antena.

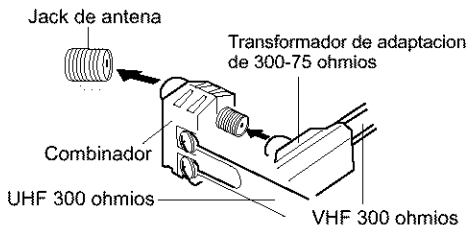

Antenas independientes de VHF/UHF (cable de VHF de 75 ohmios y cables de dos conductores UHF de 300 ohmios)

Conecte el cable de 75 ohmios de VHF y el cable de dos conductores de 300 ohmios de UHF al combinador (no suministrado). Conecte el combinador en el jack de la antena.

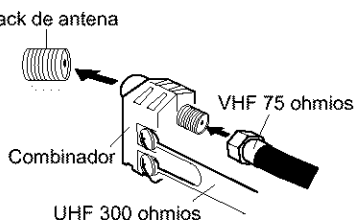

Conexiones de TV cable

Para abonados al servicio básico de TV cable

Para el servicio básico de cable y cuando no es necesario un convertidor/caja decodificadora, conecte el cable coaxial de 75 ohmios de CATV al jack de la antena en la parte trasera del TV/DVD.

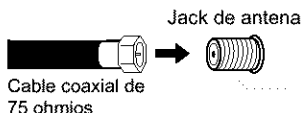

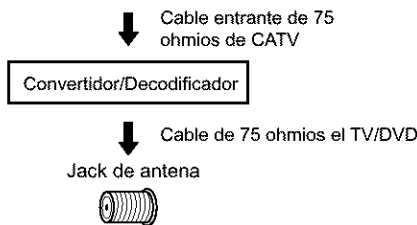

Para abonados al servicio codificado de TV cable

Si usted es abonado a un servicio de TV cable que requiere el uso de un convertidor/caja decodificadora, conecte el cable coaxial entrante de 75 ohmios al convertidor/caja decodificadora. Utilizando otro cable coaxial de 75 ohmios conecte el jack de salida del convertidor/caja decodificadora al jack de la antena del TV/DVD. Vea las conexiones mostradas abajo. Sintonice el TV/DVD al canal de salida del convertidor/caja decodificadora (generalmente canal 3 ó 4), y utilice el convertidor/caja decodificadora para seleccionar los canales.

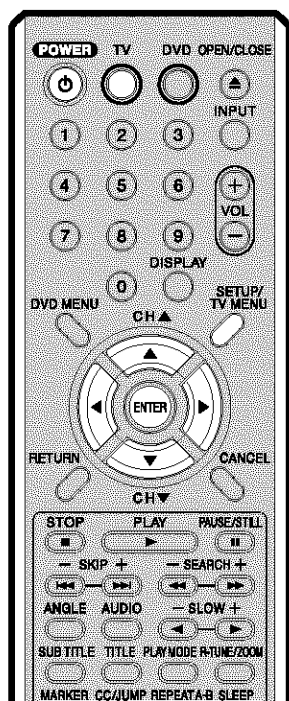

Selección de idioma en pantalla

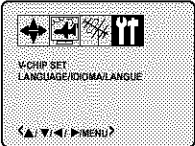



- 1 Para encender el TV/DVD, presione **POWER** se encenderá el indicador Power. Presione **TV** para seleccionar el modo TV.
 - Cada vez que presiona **POWER**, el TV/DVD se enciende desde el modo TV.
- 2 Presione **TV MENU**. Aparecerá la pantalla del menú de la TV.
- 3 Presione ◀ ó ▶ hasta que aparezca el menú **OPTION**.
 
- 4 Presione ▲ ó ▼ para seleccionar el modo **LANGUAGE**, luego presione ◀ ó ▶.
 
- 5 Presione ▲ ó ▼ para seleccionar el idioma deseado: inglés (**ENGLISH**), español (**ESPAÑOL**) o francés (**FRANCAIS**), luego presione **ENTER**.
 

Presione **TV MENU** hasta que se borre la pantalla **MENU**.

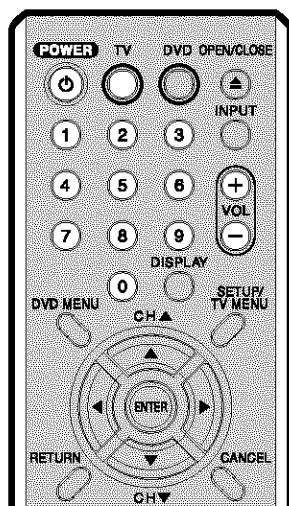
Operación del TV

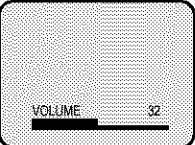

- 1 Para encender el TV/DVD, presione **POWER**. Presione **TV** para seleccionar el modo TV.
- 2 Ajuste el nivel de volumen presionando **VOL +** ó **-**. El nivel de volumen será indicado en la pantalla por medio de barras verdes y una indicación de número. A medida que el volumen aumenta, se incrementan el número de barras y la indicación de número. Si se reduce el volumen, el número de barras verdes y la indicación de número decrecen.
 
- 3 Ajuste el modo TV/CATV a la posición apropiada.

TV	- Canales de VHF/UHF
CATV	- Canales de TV CABLE
- 4 Presione el botón de selección directa de canal.
 

Spanish Quick Use Guide (Guía para rápida consulta)

Para menorizer canales

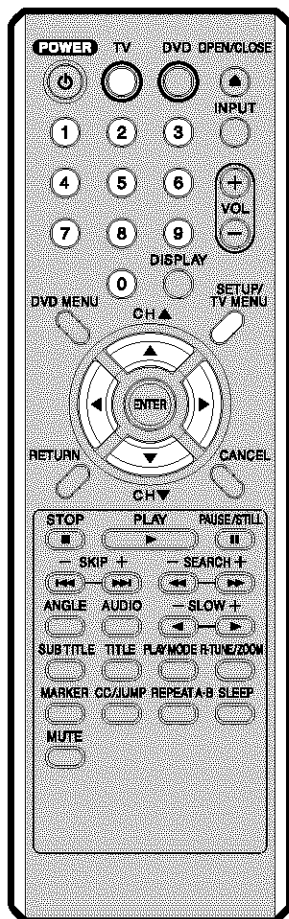

SELECCION DE TV/CATV

- 1 Presione **TV** para seleccionar el modo TV. Presione **TV MENU**. Aparece la pantalla del menú de la TV.
- 2 Presione ◀ ó ▶ hasta que aparezca el menú SET UP.
- 3 Presione ▲ ó ▼ para seleccionar el modo TV/CATV.

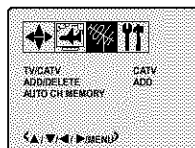

- 4 Presione ◀ ó ▶ para seleccionar el modo TV ó CATV. La flecha indica el modo seleccionado.

TV - Canales de VHF/UHF
CATV - Canales de TV CABLE

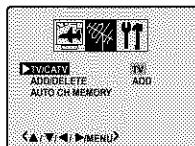

- 5 Presione **TV MENU** hasta que se borre la pantalla MENU.

SINTONIZACION DE MEMORIA AUTOMATICA DE CANAL

- 1 Presione **TV** para seleccionar el modo TV. Presione **TV MENU**. Aparece la pantalla del menú de la TV.
- 2 Presione ◀ ó ▶ hasta que aparezca el menú SET UP.
- 3 Presione ▲ ó ▼ para seleccionar el modo AUTO CH MEMORY, a continuación presione ◀ ó ▶. El TV comenzará a memorizar todos los canales disponibles en su área.

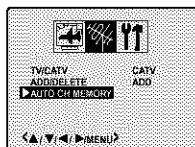
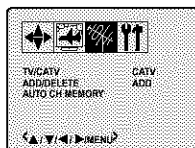

- 4 Presione **TV MENU** hasta que se borre la pantalla MENU.

Procedimiento de reproducción

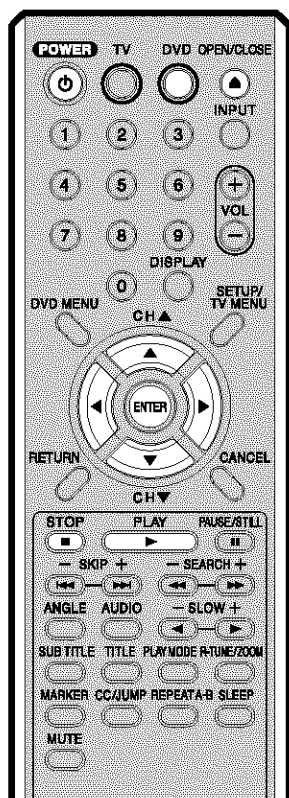

Nota:

- Si se coloca un disco no compatible, aparecerá "Incorrect Disc", "Region Code Error" o "Parental Error" en la pantalla de TV dependiendo del tipo de disco cargado. En este caso, revisar el disco nuevamente.
- Algunos discos pueden demorar un minuto antes de empezar la reproducción.
- Cuando coloque un disco de una sola cara con esa etiqueta abajo (i.e. del lado incorrecto) y presione **PLAY** o **OPEN/CLOSE** en el aparato, aparecerá "Ⓢ" en la pantalla durante 3 segundos y después aparecerá continuamente la palabra "No Disc".
- Algunas funciones de reproducción de DVD pueden haber sido elegidas por el productor de la película. Como este aparato reproduce los DVD de acuerdo con las posibilidades introducidas por el productor, algunas funciones de reproducción pueden no existir. Consulte además las instrucciones que vienen con el DVD.

- 1 Presione **POWER** en la unidad o en el mando a distancia para encender la unidad. Se encenderá el indicador **POWER**.
 - Cada vez que presiona **POWER**, el TV/DVD se enciende desde el modo TV.
 - Cuando use un amplificador, enciéndalo.

- 2 Presione **DVD** para seleccionar el modo DVD. Aparecerá la pantalla de inicio del DVD.
 

- 3 Presione **OPEN/CLOSE** en el aparato. Se abrirá la bandeja del disco.
 

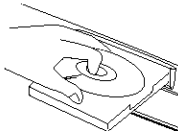
- 4 Coloque un disco en la bandeja. Sujete el disco, colóquelo con el lado de etiqueta impresa hacia arriba, alinee en las guías y coloque el disco en su posición correcta.
 

- 5 Presione **PLAY** u **OPEN/CLOSE** en el aparato. La bandeja del disco se cierra automáticamente. En la pantalla del TV la indicación "▲" cambia a "Ⓢ" y empieza la reproducción.
 





- Aparece la pantalla del menú en la pantalla de TV, si el disco tiene una función de menú.

- 6 Presione **▲/▼** ó **◀/▶** para seleccionar el título.

- 7 Presione **ENTER**.
 - Se selecciona el título y empieza la reproducción.

- 8 Presione **STOP** para terminar la reproducción.
 - El aparato graba el punto de parada, según el disco. Aparece "■" en la pantalla. (Presione **PLAY** para continuar reproduciendo (desde el mismo punto).
 - Si presiona nuevamente **STOP** o se retira el disco (Aparece "■" en la pantalla), el aparato borrará el punto de parada.

- 9 Presione **OPEN/CLOSE** en el aparato. Se abre la bandeja del disco. Saque el disco y presione **OPEN/CLOSE** en el aparato y presione **POWER**. La bandeja del disco se cierra automáticamente y se desconecta el aparato.

A series of 25 horizontal dotted lines for writing.

Limited Warranty

PANASONIC CONSUMER ELECTRONICS
COMPANY, DIVISION OF MATSUSHITA ELECTRIC
CORPORATION OF AMERICA
One Panasonic Way Secaucus, New Jersey 07094

PANASONIC SALES COMPANY, DIVISION OF
MATSUSHITA ELECTRIC OF PUERTO RICO, INC.,
AVE. 65 de Infantería, Km. 9.5 San Gabriel Industrial
Park, Carolina, Puerto Rico 00985

Panasonic/Quasar Video Products Limited Warranty

Limited Warranty Coverage

If your product does not work properly because of a defect in materials or workmanship, Panasonic Consumer Electronics Company or Panasonic Sales Company (collectively referred to as "the warrantor") will, for the length of the period indicated on the chart below, which starts with the date of original purchase ("warranty period"), at its option either (a) repair your product with new or refurbished parts, or (b) replace it with a new or a refurbished product. The decision to repair or replace will be made by the warrantor.

Product	Parts	Labor	Service	Contact Number
Camcorder	One (1) Year (except CCD Image Sensor) CCD Image Sensor - 6 (Six) Months	Ninety (90) Days Ninety (90) Days	Carry-In or Mail-In	1-800-211-PANA(7262)
DVD/VCR Deck, A/V Mixer	One (1) Year	Ninety (90) Days	Carry-In or Mail-In	1-800-211-PANA(7262)
TV/VCR, TV/DVD, TV/DVD/VCR Combination	One (1) Year (except CRT) CRT - Two (2) Years	Ninety (90) Days Ninety (90) Days	Carry-In: 21" CRT and Smaller In-Home or Carry-In: 22" CRT and Larger	1-800-211-PANA(7262)
TV/HDR Combination	One (1) Year (except CRT) CRT - Two (2) Years	Ninety (90) Days Ninety (90) Days	In-Home or Carry-In	1-888-843-9788
Rechargeable Batteries (In exchange for defective item)	Ten (10) Days	Not Applicable	Carry-In or Mail-In	1-800-211-PANA(7262)
Tape (In exchange for defective item)	Five (5) Days	Not Applicable	Carry-In or Mail-In	1-800-211-PANA(7262)
Memory Cards (In exchange for defective item)	Ninety (90) Days	Not Applicable	Carry-In or Mail-In	1-800-211-PANA(7262)

During the "Labor" warranty period there will be no charge for labor. During the "Parts" warranty period, there will be no charge for parts. You must carry-in or mail-in your product or arrange for in-home service, as applicable, during the warranty period.

If non-rechargeable batteries are included, they are not warranted. This warranty only applies to products purchased and serviced in the United States or Puerto Rico. This warranty is extended only to the original purchaser of a new product which was not sold "as is." A purchase receipt or other proof of the original purchase date is required for warranty service.

Carry-In, Mail-in or In-Home Service

For Carry-In, Mail-In or In-Home Service (as applicable) in the United States call toll free contact number listed above or visit Panasonic Web Site: <http://www.panasonic.com>

For assistance in Puerto Rico call Panasonic Sales Company (787)-750-4300 or fax (787)-768-2910.

In-Home service, if applicable, requires clear, complete and easy access to the product by the authorized servicer and does not include removal or re-installation of an installed product. It is possible that certain in-home repairs will not be completed in-home, but will require that the product, or parts of the product, be removed for shop diagnosis and/or repair and then returned.

Limited Warranty Limits And Exclusions

This warranty ONLY COVERS failures due to defects in materials or workmanship, and DOES NOT COVER normal wear and tear or cosmetic damage, nor does it cover markings or retained images on the picture tube resulting from viewing fixed images (including, among other things, letterbox pictures on standard 4:3 screen TV's, or non-expanded standard 4:3 pictures on wide screen TV's, or onscreen data in a stationary and fixed location). The warranty ALSO DOES NOT COVER damages which occurred in shipment, or failures which are caused by products not supplied by the warrantor, or failures which result from accidents, misuse, abuse, neglect, mishandling, misapplication, alteration, faulty installation, set-up adjustments, misadjustment of consumer controls, improper maintenance, power line surge, lightning damage, modification, or commercial use (such as in a hotel, office, restaurant, or other business), rental use of the product, service by anyone other than a Factory Servicenter or other Authorized Servicer, or damage that is attributable to acts of God.

THERE ARE NO EXPRESS WARRANTIES EXCEPT AS LISTED UNDER "LIMITED WARRANTY COVERAGE." THE WARRANTOR IS NOT LIABLE FOR INCIDENTAL OR CONSEQUENTIAL DAMAGES RESULTING FROM THE USE OF THIS PRODUCT, OR ARISING OUT OF ANY BREACH OF THIS WARRANTY. (As examples, this excludes damages for lost time, cost of having someone remove or re-install an installed unit if applicable, or travel to and from the servicer, loss of media or images, data or other memory or recorded content. The items listed are not exclusive, but are for illustration only.)

ALL EXPRESS AND IMPLIED WARRANTIES, INCLUDING THE WARRANTY OF MERCHANTABILITY, ARE LIMITED TO THE PERIOD OF THE LIMITED WARRANTY.

Some states do not allow the exclusion or limitation of incidental or consequential damages, or limitations on how long an implied warranty lasts, so the exclusions may not apply to you. This warranty gives you specific legal rights and you may also have other rights which vary from state to state. If a problem with this product develops during or after the warranty period, you may contact your dealer or Servicenter. If the problem is not handled to your satisfaction, then write to the warrantor's Consumer Affairs Department at the addresses listed for the warrantor.

PARTS AND SERVICE (INCLUDING COST OF AN IN-HOME SERVICE CALL, WHERE APPLICABLE) WHICH ARE NOT COVERED BY THIS LIMITED WARRANTY ARE YOUR RESPONSIBILITY.

Customer Services Directory

*For Product Information, Operating Assistance, Literature Request, Dealer Locations, and all Customer Service inquiries please contact:
1-800-211-PANA (7262), Monday-Friday 9 am-9 pm; Saturday-Sunday 10 am-7 pm,
EST. or send e-mail : consumerproducts@panasonic.com
For hearing or speech impaired TTY users, TTY : 1-877-833-8855*

*Web Site: <http://www.panasonic.com>
You can purchase parts, accessories or locate your nearest servicenter by visiting our Web Site.*

Accessory Purchases:

1-800-332-5368 (Customer Orders Only)

For hearing or speech impaired TTY users, TTY : 1-866-605-1277

Panasonic Services Company 20421 84th Avenue South, Kent, WA 98032

(Monday-Friday 6 am-5 pm; Saturday 6 am-10:30 am, PST)

(Visa, MasterCard, Discover Card, American Express, Check)

*Service in Puerto Rico
Matsushita Electric of Puerto Rico, Inc. Panasonic Sales Company/ Factory
Servicenter:*

Ave. 65 de Infantería, Km. 9.5, San Gabriel Industrial Park,

Carolina, Puerto Rico 00985

Phone (787)750-4300 Fax (787)768-2910

Index

A

Accessories	7
Add/Delete Channels	20
Angle	34
Antenna Connections	13
Aspect Ratio of TV Screen	36
Audio CD	9,26,31
Automatic Memory Tuning	20

B

Battery	12
---------------	----

C

Cable TV Connections	14
Change Password	23
Channel ▲/▼	17
Chapter	9
Closed Caption	18
Condensation	5
Connections to Other Equipment	42,43
Customer Service Directory	57

D

Digital Audio Out	42
Disc	9
Display	17,26
DVD Menu	34
Dynamic Range Control (DRC)	37

F

Fast Forward Playback	28
Features	8
Frame Advance	28

I

Important Safeguards	3
Index of Controls	48,49
Install the TV/DVD in Your Car	6

J

Jump	30
------------	----

L

Language	15,35
Language Code	35,41
Letterbox	36
Limited Warranty	56
Locating a Chapter or Track	28

M

Marker	32
Memorize Channels	19
MP3	9,26,29,31
MP3 Playback	29
Mute	18

O

OPEN/CLOSE	27
------------------	----

P

Panscan	36
Parental Control	38-40
Parts and Functions	10
Password	21,23,38-40
Picture Control Adjustment	24
Playback	27
Power Sources	12
Problems and Troubleshooting	44
Program Playback	31

R

Random Playback	31
Reception Disturbances	46
Region Number	7
Remote Control	11
Repeat	31
Repeat A-B	31
Replacing the Fuse	13
Review Playback	28
R-Tune	17

S

Safety Precautions	6
Setting the Language	15,35
Sleep	17
Slow-motion Playback	28
Soundtrack	33
Spanish Quick Use Guide	50
Specifications	47
Stereo and Second Audio Program (SAP)	25
Still Playback	28
Stop	27
Subtitle	33

T

Title	9
Title Selection	34
Track	9
TV Operation	16
TV/CATV Selection	19

V

Video CD	9,26,31
Volume	16
V-Chip	21-23

W

Wide Screen	36
-------------------	----

Z

Zoom	30
------------	----

Panasonic Consumer Electronics Company,
Division of Matsushita Electric Corporation of America
One Panasonic Way Secaucus,
New Jersey 07094

Panasonic Sales Company ("PSC"),
Division of Matsushita Electric of Puerto Rico, Inc.
Ave. 65 de Infanteria. Km. 9.5
San Gabriel Industrial Park, Carolina, Puerto Rico 00985



Printed in Thailand