



DVD PLAYER

DVD-HD931



Important Safety Instructions

- 1) Read these instructions.
- 2) Keep these instructions.
- 3) Heed all warnings.
- 4) Follow all instructions.
- 5) Do not use this apparatus near water.
- 6) Clean only with dry cloth.
- 7) Do not block any ventilation openings. Install in accordance with the manufacturer's instructions.
- 8) Do not install near any heat sources such as radiators, heat registers, or other apparatus (including amplifiers) that produce heat.
- 9) Do not defeat the safety purpose of the polarized or grounding-type plug. A polarized plug has two blades with one wider than the other. A grounding type plug has two blades and a third grounding prong. The wide blade or the third prong are provided for your safety. If the provided plug does not fit into your outlet, consult an electrician for replacement of the obsolete outlet.
- 10) Protect the power cord from being walked on or pinched particularly at plugs, convenience receptacles, and the point where they exit from the apparatus.
- 11) Only use attachments/accessories specified by the manufacturer.
- 12) Use only with cart, stand, tripod, bracket, or table specified by the manufacturer, or sold with the apparatus.
- 13) Unplug this apparatus. When a cart is used, use caution when moving the cart/apparatus combination to avoid injury from tip-over.
- 14) Refer all servicing to qualified service personnel. Servicing is required when the apparatus has been damaged in any way, such as power-supply cord or plug is damaged, liquid has been spilled or objects have fallen into the apparatus the apparatus has been exposed to rain or moisture, does not operate normally, or has been dropped.



Precautions



TO REDUCE THE RISK OF ELECTRIC SHOCK, DO NOT REMOVE THE COVER(OR BACK). NO USER-SERVICEABLE PARTS ARE INSIDE. REFER SERVICING TO QUALIFIED SERVICE PERSONNEL.



This symbol indicates "dangerous voltage" inside the product that presents a risk of electric shock or personal injury.



This symbol indicates important instructions accompanying the product.

Do not install this equipment in a confined space such as a bookcase or similar unit.

WARNING : To prevent damage which may result in fire or electric shock hazard, do not expose this appliance to rain or moisture.

CAUTION : DVD PLAYERS USE AN INVISIBLE LASER BEAM WHICH CAN CAUSE HAZARDOUS RADIATION EXPOSURE IF DIRECTED. BE SURE TO OPERATE PLAYER CORRECTLY AS INSTRUCTED.

CAUTIONS

Caution: To prevent electric shock, match wide blade of plug to wide slot, fully insert.

Attention: Pour éviter les chocs électriques, introduire la lame la plus large de la fiche dans la borne correspondante de la prise et pousser jusqu'au fond.

This product satisfies FCC regulations when shielded cables and connectors are used to connect the unit to other equipment. To prevent electromagnetic interference with electric appliances, such as radios and televisions, use shielded cables and connectors for connections.

FCC NOTE (for U.S.A):

This equipment has been tested and found to comply with the limits for a Class B digital device, pursuant to Part 15 of the FCC rules. These limits are designed to provide reasonable protection against harmful interference in a residential installation. This equipment generates, uses and can radiate radio frequency energy and, if not installed and used in accordance with the instructions, may cause harmful interference to radio or television reception, which can be determined by turning the equipment off and on. The user is encouraged to try to correct the interference by one or more of the following measures.

- Reorient or relocate the receiving antenna.
- Increase the separation between the equipment and receiver.
- Connect this equipment into an outlet on a circuit different from that to which the receiver is connected.
- Consult the dealer or an experienced radio/TV technician for help.

This class B digital apparatus meets all requirements of the Canadian Interference -- Causing Equipment Regulations.

CLASS 1 LASER PRODUCT
KLASSE 1 LASER PRODUKT
LUOKAN 1 LASER LAITE
KLASS 1 LASER APPARAT
PRODUCTO LÁSER CLASE 1

CAUTION

THIS PRODUCT UTILIZES A LASER. USE OF CONTROLS OR ADJUSTMENTS OR PERFORMANCE OF PROCEDURES OTHER THAN THOSE SPECIFIED HEREIN MAY RESULT IN HAZARDOUS RADIATION EXPOSURE. DO NOT OPEN COVER AND DO NOT REPAIR YOURSELF. REFER SERVICING TO QUALIFIED PERSONNEL.

Note:

- This unit can be used only where the power supply is AC 120V, 60Hz. It cannot be used elsewhere.
- This DVD player is designed and manufactured to respond to the Region Management Information. If the Region number of a DVD disc does not correspond to the Region number of this DVD player, the DVD player cannot play the disc.
- This device is protected by U.S. patent numbers 4,631,603, 4,577,216, 4,819,098 and 4,907,093 and other intellectual property rights. The use of Macrovision's copy protection technology in the device must be authorized by Macrovision and is intended for home and other limited pay-per-view uses only, unless otherwise authorized in writing by Macrovision. Reverse engineering or disassembly is prohibited.

Handling Cautions

- Before connecting other components to this player, be sure to turn them all off.
- Do not move the player while a disc is being played, or the disc may be scratched or broken, and the player's internal parts may be damaged.
- Do not put a flower vase filled with water or any small metal objects on the player.
- Be careful not to put your hand into the disc tray.
- Do not place anything other than the disc in the disc tray.
- Exterior interference such as lightning and static electricity can affect normal operation of this player. If this occurs, turn the player off and on again with the POWER button, or disconnect and then reconnect the AC power cord to the AC power outlet. The player will operate normally.
- Be sure to remove the disc and turn off the player after use.
- Disconnect the AC power cord from the AC outlet when you don't intend to use the player for long periods of time.
- Clean the disc by wiping in a straight line from the inside to the outside of the disc.

Disc Storage

- Be careful not to harm the disc because the data on these discs is highly vulnerable to the environment.
- Do not keep under direct sunlight.
 - Keep in a cool ventilated area.
 - Store vertically.
 - Keep in a clean protection jacket.

Maintenance of Cabinet

- For safety reasons, be sure to disconnect the AC power cord from the AC outlet.
- Do not use benzene, thinner, or other solvents for cleaning.
 - Wipe the cabinet with a soft cloth.

Accessories



Remote Control
(AK59-00012A)



Batteries for
Remote Control (AAA Size)
(AC43-12002H)

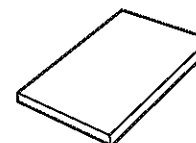

User's Manual
(AK68-00168A)

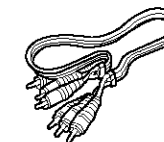

Video/Audio Cable
(AC39-42001R)

Install Batteries in the Remote

- 1 Open the battery cover on the back of the remote.
- 2 Insert two AAA batteries. Make sure that the polarities (+ and -) are aligned correctly.
- 3 Replace the battery cover.

If remote doesn't operate properly:

- Check the polarity + - of the batteries (Dry-Cell)
- Check if the batteries are drained.
- Check if remote sensor is blocked by obstacles.
- Check if there is any fluorescent lighting nearby.

Setup	
General Features	7
Disc Type and Characteristics	8
Description-Front Panel	9
Display Indicators	10
Description-Rear Panel	11
Tour of the Remote Control	12
Connections	
Choosing a Connection	14
Basic Functions	
Playing a Disc	19
Using the Search & Skip Functions	21
Using the Display Function	22
Using the Disc and Title Menu	23
Using the Function Menu	24
Advanced Functions	
Repeat Play	25
Selecting the Audio Language	26
Selecting the Subtitle Language	27
Changing the Camera Angle, S.FIT Play	28
Using the Instant Replay/Skip Function	29
Using the Bookmark Function	30
Using the Zoom & 3D Sound Functions	31
MP3 Play	32
Program Play & Random Play	34
Picture CD Playback	35
Changing Setup menu	
Using the Setup Menu	37
Setting Up the Language Features	38
Setting Up the Audio Options	42
Setting Up the Display Options	43
Setting Up the Parental Control	44
Reference	
Controlling a with TV the Remote	46
Troubleshooting	47
Specifications	49
Warranty	51

HD(1080i/720p) DVI(Digital Visual Interface) Output

HD(High Definition) Video has 1080i or 720p picture quality and 16:9 aspect ratio. The DVD SD video signal is converted to a 720 line maximum HD format to provide a higher picture quality than existing DVDP.

Excellent Sound

Dolby Digital, a technology developed by Dolby Laboratories, provides crystal clear sound reproduction.

Screen

Both regular and widescreen(16:9) pictures can be viewed.

Programmed Play

You can program tracks to play in desired order. (CD, MP3)

Parental Control

The parental control allows users to set the level necessary to prohibit children from viewing harmful movies such as those with violence, adult subject matter, etc.

Various On-Screen Menu Functions

You can select various languages (Audio/Subtitle) and screen angles while enjoying movies.

Repeat

You can repeat a song or movie simply by pressing the REPEAT button.

COPY PROTECTION

- Many DVD discs are encoded with copy protection. Because of this, you should only connect your DVD player directly to your TV, not to a VCR. Connecting to a VCR results in a distorted picture from copy-protected DVD discs.
- This product incorporates copyright protection technology that is protected by methods claims of certain U.S. patents and other intellectual property rights owned by Macrovision Corporation and other rights owners. Use of this copyright protection technology must be authorized by Macrovision Corporation, and is intended for home and other limited viewing uses only unless otherwise authorized by Macrovision Corporation. Reverse engineering or disassembly is prohibited.

Digital Photo Viewer (JPEG)

You can view Digital Photos on your TV.

Progressive Scan

Progressive scanning creates an improved picture with double the scan lines of a conventional interlaced picture.

MP3

This unit can play discs created from MP3 files.

Instant Replay

This function is used to replay the previous 10 seconds of the movie from the current position.

Instant Skip

This function skips playback ahead 10 seconds.

Slow Motion

An important scene can be viewed in slow motion.

NOTE



- * Discs which cannot be played with this player.

• DVD-ROM	• DVD-RAM
• CD-ROM	• CDV
• CDI	
• HD layer of super Audio CD	
• CDGs play audio only, not graphics.	
• WMA	
- * Ability to play back may depend on recording conditions.

• DVD-R, +R	• CD-RW
• DVD+RW, -RW	

Disc Type and Characteristics

This DVD player is capable of playing the following types of discs with the corresponding logos:

Disc Types (Logos)	Recording Types	Disc Size	Max. Playing Time	Characteristics
	Audio + Video	5"	Single-sided 240 min. Double-sided 480 min.	<ul style="list-style-type: none"> DVD contains excellent sound and video due to Dolby Digital and MPEG-2 system. Various screen and audio functions can be easily selected through the on-screen menu.
		3 1/2"	Single-sided 80 min. Double-sided 160 min.	
	Audio	5"	74 min.	<ul style="list-style-type: none"> CD is recorded as a Digital Signal with better audio quality, less distortion and less deterioration of audio quality over time.
		3 1/2"	20 min.	

Disc Markings

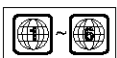

• Play Region Number



• NTSC broadcast system in U.S.A, Canada, Korea, Japan, etc.



• Dolby Digital disc



• Stereo disc



• Digital Audio disc



• DTS disc



• MP3 disc



• DCDi

Play Region Number

Both the DVD player and the discs are coded by region. These regional codes must match in order for the disc to play. If the codes do not match, the disc will not play.

The Region Number for this player is described on the rear panel of the player.

Description-Front Panel

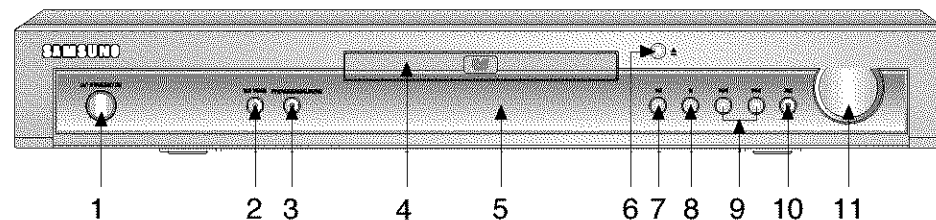

Front Panel Controls

- STANDBY/ON**
 - When the unit is first plugged in, the indicator lights. When STANDBY/ON is pressed on again, the light goes out and the player is turned on.
- DVI VIDEO**
 - The button will change color each time it is pressed to indicate the mode. 480p(Red), 720p(Blue) and 1080i(Green) modes are supported.
- PROGRESSIVE SCAN**
 - When this button is blue, the component jacks output progressive scan(480p) to your TV.
- DISC TRAY**
 - Load the disc here.
- DISPLAY**
 - Operation indicators are displayed here.
- OPEN/CLOSE (▲)**
 - Press to open and close the disc tray.
- PLAY/PAUSE (▶||)**
 - Begin or pause disc play.
- STOP (■)**
 - Stops disc play.
- SKIP (◀◀ / ▶▶)**
 - Use to skip a scene or music.
- JOG**
 - This button enables step playback using the JOG dial.
- JOG DIAL**
 - Turn the dial after with pressing the JOG button (Light turns blue) to perform step playback. Turn the dial without pressing the JOG button to perform fast search.

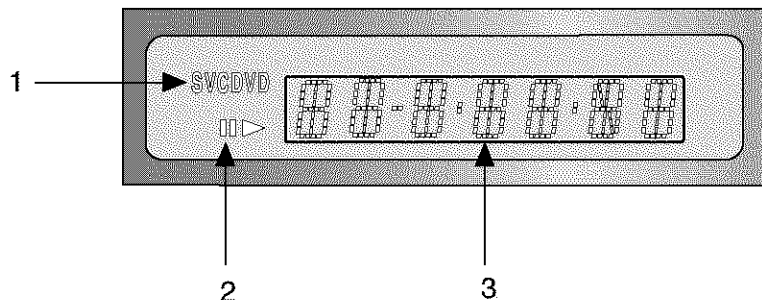

Front Panel Display

1. Disc type indicators
2. Play/Pause/Forward play
3. Displays various messages concerning operations such as PLAY, STOP, LOAD ...
no DISC : No disc loaded.
OPEN : The disc tray is open.
LOAD : Player is loading disc information.

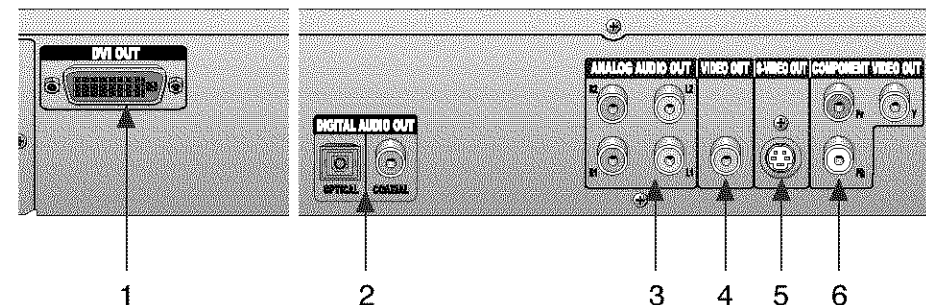

Rear Panel

1. **DVI OUT JACK**
 - Use the DVI cable to connect this jack to the DVI jack on your television for a higher quality picture.
2. **DIGITAL AUDIO OUT JACKS**
 - Use either an optical or coaxial digital cable to connect to a compatible Dolby Digital receiver.
 - Use to connect to an A/V Amplifier that contains a Dolby Digital or DTS decoder.
3. **ANALOG AUDIO OUT JACKS**
 - Connect to the Audio input jacks of your television, audio/video receiver, or VCR.
4. **VIDEO OUT JACK**
 - Use a video cable to connect to the VIDEO input jack on your television.
 - The PROGRESSIVE SCAN button must be set to off.
5. **S-VIDEO JACK**
 - Use the S-Video cable to connect this jack to the S-Video jack on your television for a higher quality picture.
 - The PROGRESSIVE SCAN button must be set to off.
6. **COMPONENT VIDEO OUT JACKS**
 - Use these jacks if you have a TV with Component Video in jacks. These jacks provide Pr, Pb and Y video. Along with S-Video, Component Video provides the best picture quality.
 - If PROGRESSIVE SCAN button is set to on, progressive scan mode will work.
 - If PROGRESSIVE SCAN button is set to off, interlace scan mode will work.

Important Note

- Consult your TV User's Manual to find out if your TV supports Progressive Scan. If Progressive Scan is supported, follow the TV User's Manual's instructions regarding Progressive Scan settings in the TV's menu system.
- If PROGRESSIVE SCAN button is set to on, VIDEO, S-VIDEO and DVI will not work.
- Make sure to stop DVD playback before enabling the PROGRESSIVE SCAN function.

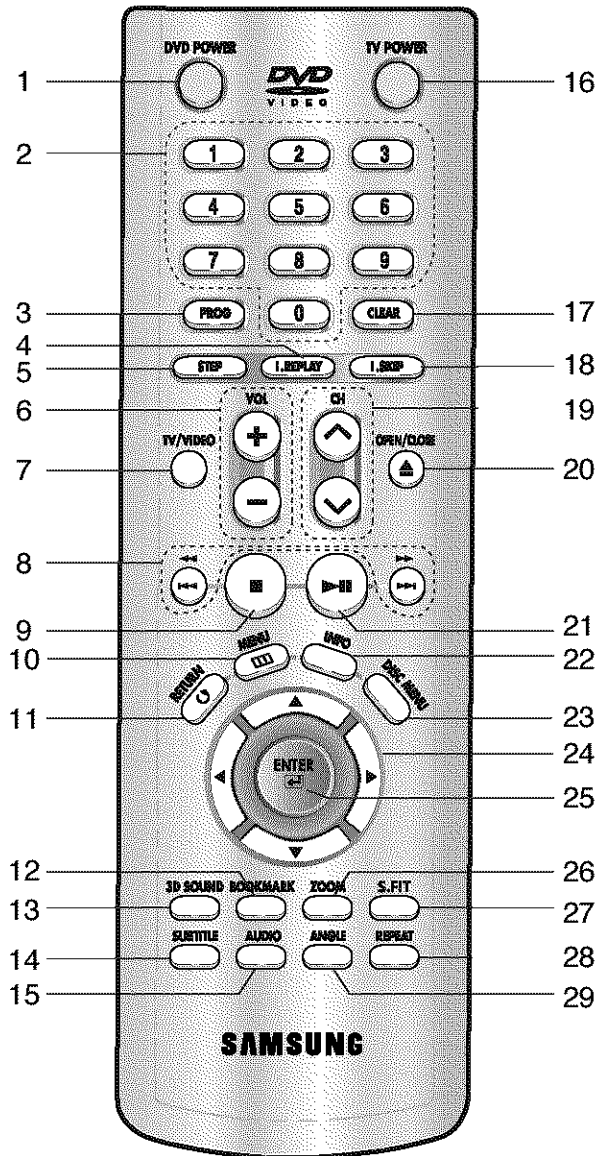

DVD Function Buttons

- 1. DVD POWER Button**
 - Turns the DVD player's power on or off.
- 2. NUMBER Buttons**
- 3. PROG Button**
 - Allows you to program a specific order.
- 4. I.REPLAY Button**
 - This function is used to replay the previous 10 seconds of the movie from the current position.
- 5. STEP button**
 - Advances play one frame at a time.
- 6. VOL +/- buttons**
 - Control volumes.
- 7. TV/VIDEO button**
 - Press to display all of the available video sources (i.e., TV, Cable, Video)
- 8. SEARCH/SKIP buttons (◀▶, ◀◀▶▶)**
 - Allows you to search forward/backward through a disc. Use to skip the title, chapter or track.
- 9. STOP button (■)**
- 10. MENU button (▢)**
 - Brings up the DVD player's setup menu.
- 11. RETURN button (⏪)**
 - Returns to a previous menu.
- 12. BOOKMARK button**
 - Use this to save a favorite scene within a movie.
- 13. 3D SOUND button**
 - Press this to listen to 3D surround sound through two existing stereo speakers.
- 14. SUBTITLE button**
 - Press this to switch the DVD's subtitle language.
- 15. AUDIO button**
 - Use this button to access various audio functions on a disc.
- 16. TV POWER button**
 - Turns the TV's power on or off.
- 17. CLEAR button**
 - Use to remove menus or status displays from the screen.
- 18. I.SKIP button**
 - This function skips playback ahead 10 seconds.
- 19. CH ▲/▼ buttons**
 - Channel selection.
- 20. OPEN/CLOSE (▲) button**
 - To open and close the disc tray.
- 21. PLAY/PAUSE (▶▶) button**
 - Begin/Pause disc play.
- 22. INFO button**
 - Displays the current disc mode.
- 23. DISC MENU button**
 - Brings up the Disc menu.
- 24. DIRECTION buttons (UP/DOWN or LEFT/RIGHT buttons)**
 - This button functions as a toggle switch.
- 25. ENTER button**
- 26. ZOOM button**
 - Enlarges DVD picture.
- 27. S.FIT button**
 - Allows you to eliminate the black bars in the top and bottom of the screen when a movie is playing.
- 28. REPEAT button**
 - Allows you to repeat a title, chapter, track or disc.
- 29. ANGLE button**
 - Use to access various camera angles on a DVD.

Choosing a Connection

The following show examples of connections commonly used to connect the DVD player with a TV and other components.

Before Connecting the DVD Player

- Always turn off the DVD player, TV, and other components before you connect or disconnect any cables.
- Refer to the owner's manual of the additional components you are connecting for more information on those particular components.

Connection to an Audio System

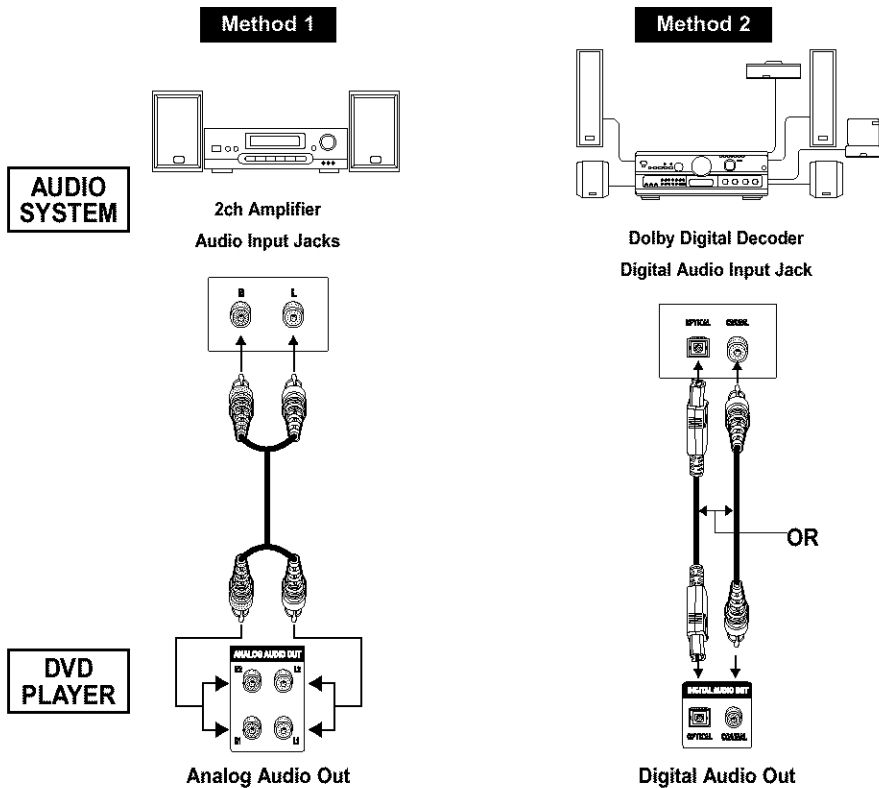

Choosing a Connection

Connection to a TV (For Video)

TV (Normal, Widescreen, Projection, etc..)

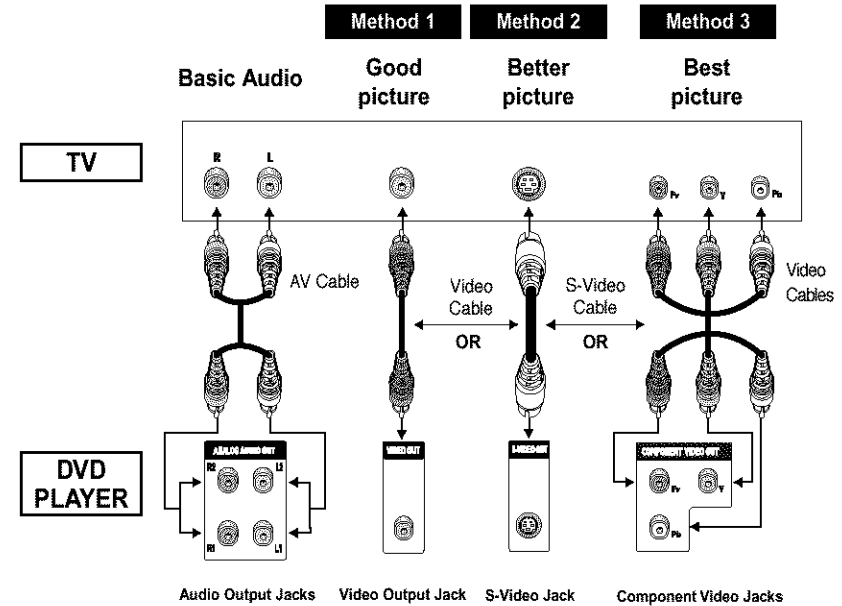

Method 1 DVD Player + TV with Video Input Jack

Method 2 DVD Player + TV with S-Video Input Jack

Method 3 DVD Player + TV with Component Video Jacks

NOTE

• If PROGRESSIVE SCAN is set to on, DVI, VIDEO and S-VIDEO will not work.

Choosing a Connection

Connection to a TV (For Progressive scan, HD Digital Video)

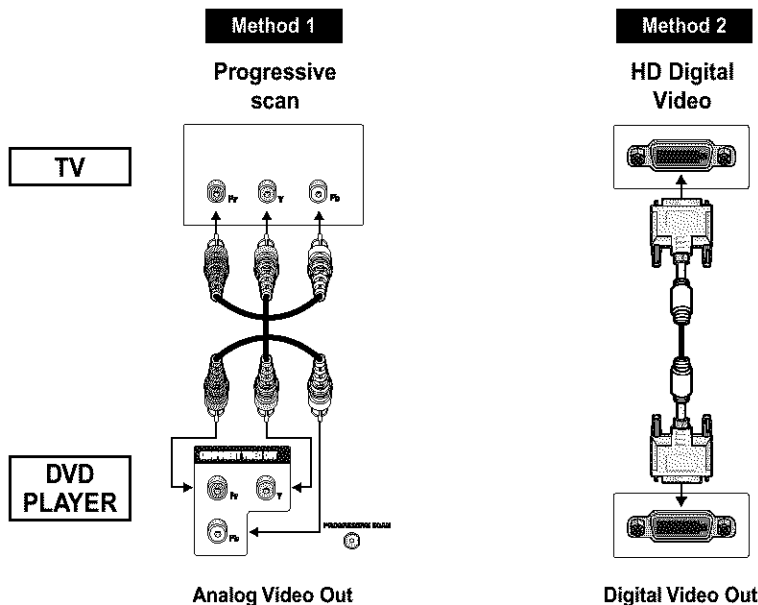

Method 1 DVD Player + TV with Progressive Scan Jacks.

Method 2 DVD Player + TV with DVI Jack.

- If PROGRESSIVE SCAN button is set to on, DVI, VIDEO and S-VIDEO will not work.
- Depending on your TV, your hookup for Method 2 may differ from the illustration.

Important Note

Consult your TV User's Manual to find out if your TV supports Progressive Scan. If Progressive Scan is supported, follow the TV User's Manual's instructions regarding Progressive Scan settings in the TV's menu system.

Choosing a Connection

DVI VIDEO Specifications

When you press the DVI VIDEO button :

1. The 480p DVI output will be selected when the "Red" light comes on.
2. The 720p DVI output will be selected when the "Blue" light comes on.
3. The 1080i DVI output will be selected when the "Green" light comes on.

Important Note

- DVI (Digital Visual Interface)
DVI is an interface to enable the digital transmission of video signals between various digital devices. Using DVI, the DVD player transmits a digital video signal and displays a vivid picture on a TV having a DVI jack.
- Description of the DVI connection
DVI-D connector : digital signal only.
DVI-I connector : digital and analog signal.
- Though the player is using DVI-I connector, the output from a DVI-I is only a digital signal.
- If TV does not support HDCP (High-bandwidth Digital content protect), snow noise appears on the screen.
- Be careful that various connectors are similar to DVI connector, for example VESA PnD, VESA DFD and so on.
- Why we adopt DVI?
Generally, with an analog TV, an analog video signal is input to VIDEO IN. However, when playing a DVD title the data transmitted to a TV is digital. Therefore either a digital-to-analog converter(in the dvd player) and an analog-to-digital converter (in the TV) is required. During this conversion, the picture quality is degraded due to noise and loss of signal. DVI technology requires no D/A conversion and DVI is a pure digital signal from the player to your TV.
- What is the HDCP ?
HDCP(High-bandwidth Digital Content Protection) is a system for protecting DVD content outputted via DVI from being copied. It provides a secure digital link between a video source(PC, DVD . etc) and a display device(TV, projector . etc). Content is encrypted at the source device to prevent unauthorized copies from being made.

PROGRESSIVE SCAN Specifications

Progressive scanning creates an improved picture with double the scan lines of a conventional interlaced picture.

When you press the PROGRESSIVE SCAN button;

1. The 480p will be enabled at the component output when the blue light comes on.
2. The 480i will be enabled at the component output when the light turns off.

NOTE

- If the PROGRESSIVE SCAN button is set to on, the DVI, VIDEO and S-video outputs will be disabled.
- If the PROGRESSIVE SCAN button is set to off, the LED will be turned off and all of DVI, VIDEO, S-VIDEO and COMPONENT outputs will be enabled.
- Make sure to stop DVD playback before enabling the progressive scan function.

Before Play

- Turn on your TV and press the TV/VIDEO button to select the video mode.
- Turn on your Audio System and select AUX, CD or DVD.

After plugging in the player, the first time you press the DVD POWER button, this screen comes up :
If you want to select the language, press a NUMBER button.
(This screen will only appear the very first time you plug in the player.)

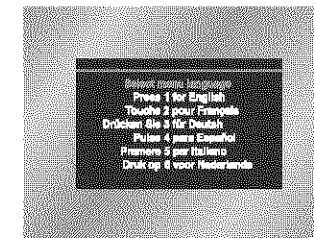

Play

- 1 Press the OPEN/CLOSE (▲) button.
The STANDBY indicator light goes out and the tray opens.
- 2 Place a disc gently into the tray with the disc's label facing up.
- 3 Press the PLAY/PAUSE (▶||) button or OPEN/CLOSE (▲) button to close the disc tray.
- 4 Stopping Play
Press the STOP (■) button during play.
- 5 Removing Disc
Press the OPEN/CLOSE (▲) button.
- 6 Pausing Play
Press the PLAY/PAUSE (▶||) or STEP button on the remote during play.
- Screen stops, no sound.
- To resume again, press PLAY/PAUSE (▶||) button once again.

Playing a Disc

7 Step Motion Play (Only DVD)

Press the STEP button on the remote during play.

- Each time the button is pressed, a new frame will appear.
- No sound is heard during STEP mode.
- Press PLAY/PAUSE (▶||) to resume normal play.
(You can only perform step motion play in the forward direction.)

8 Slow Motion Play (Only DVD)

Press the SEARCH (▶▶) button for more than 1 second on the remote during PAUSE or STEP mode.

- By pressing the SEARCH (▶▶) button for more than 1 second, you can select slow motion play for 1/8, 1/4 or 1/2 of normal speed.
- No sound is heard during slow mode.
- Press PLAY/PAUSE (▶||) to resume normal play.
- When playing a DVD, reverse slow motion play will not work.

RESUME function

When you stop disc play, the player remembers where you stopped, so when you press PLAY (▶||) again, it will pick up where you left off. (unless the disc is removed, the STOP (■) button is pressed twice or the player is unplugged.)

NOTE

- If the player is left for 5 minutes in pause mode, it will stop.
- If the player is left in the stop mode for more than 30 minutes, the power will automatically shut off. (Automatic Power-Off Function)
- If the player is left in the stop mode for more than two minute without any user interaction, a screen saver will be activated. Press the PLAY (▶||) button to resume normal play.
- This  icon indicates an invalid button press.

Using the Search & Skip Functions

During play, you can search quickly through a chapter or track or use the skip function to jump to the next selection.

Searching through a Chapter or Track

1 During play, press the SEARCH (◀◀ or ▶▶) button on the remote.

- Press the SEARCH (◀◀ or ▶▶) button on the remote for more than 1 second and press again or press continuously to search at a faster speed on the DVD, CD.

DVD	2X, 4X, 8X, 16X, 32X, 128X
CD	2X, 4X, 8X

Skipping Tracks

1 During play, press the SKIP (◀◀ or ▶▶) button.

- When playing a DVD, if you press the ▶▶ button, it moves to the next chapter. If you press the ◀◀ button, it moves to the beginning of the chapter. One more press makes it move to the beginning of the previous chapter.
- When playing a CD, if you press the ▶▶ button, it moves to next track. If you press the ◀◀ button, it moves to the beginning of the track. One more press makes it move to the beginning of the previous track.

Using the Display Function

When Playing a DVD/CD

- 1 During play, press the INFO button on the remote.
- 2 Use the UP/DOWN buttons to select the desired item.
- 3 Use the LEFT/RIGHT buttons to make the desired setup, then press ENTER.
 - You may use the number buttons of the remote control to directly access a title, chapter or to start playback from a desired time.
- 4 To make the screen disappear, press the INFO button again.

Title To access the desired title when there is more than one in the disc. For example, if there is more than one movie on a DVD, each movie will be identified.

Chapter Most DVD discs are recorded in chapters so that you can quickly find a specific passage.

Time Allows playback of the film from a desired time. You must enter the starting time as a reference.

Audio Refers to the language of the film soundtrack. In the example, the soundtrack is played in English 5.1CH. A DVD disc can have up to eight different soundtracks.

Subtitle Refers to the subtitle languages available in the disc. You will be able to choose the subtitles language or, if you prefer, turn them off from the screen. A DVD disc can have up to 32 different subtitles.

Angle When a DVD contains multiple angles of a particular scene, you can select the Angle function. Refers to the angle available in the disc.

DVD

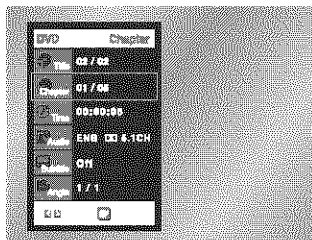

CD

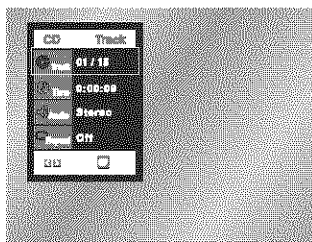

NOTE

What is a Chapter?

Each Title on a DVD is usually divided into chapters (similar to tracks on an audio CD).

What is a Title?

A DVD may contain several different titles. For example, if a disc contains four different movies, each might be considered a title.

Using the Disc Menu

- 1 During the playback of a DVD disc, press the MENU button on the remote.
- 2 Select **Disc Menu** using the UP/DOWN buttons, then press the RIGHT or ENTER button.



Using the Title Menu

- 1 During the playback of a DVD disc, press the MENU button on the remote.
- 2 Select **Title Menu** using the UP/DOWN buttons, then press the RIGHT or ENTER button.

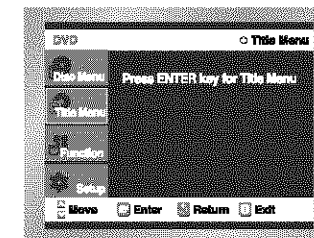

NOTE

- Depending on the disc, the Title and Disc Menus may not work.
- Title Menu will only be displayed if there are at least two titles in the disc.
- You can also use the Disc Menu, using the DISC MENU button on the remote.

Using the Function Menu

- 1 Press the MENU button during playback.
- 2 Use the UP/DOWN buttons to highlight **Function**, then press the RIGHT or ENTER button.
- 3 Function selection screen appears : Info, Screen Fit, Zoom, Bookmark, Repeat and 3D Sound.
 - Info (See Page 22)
 - Screen Fit (See Page 28)
 - Zoom (See Page 31)
 - Bookmark (See Page 30)
 - Repeat (See Page 25)
 - 3D Sound (See Page 31)
- 4 Use the UP/DOWN button to highlight one of the 6 functions. Then press the RIGHT or ENTER button to access the function.

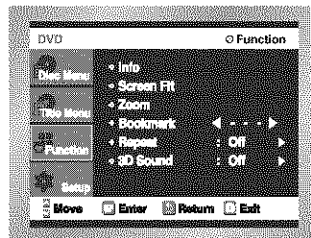

NOTE

- You can also directly select these functions using their respective buttons on the remote. (Info, Screen Fit, Zoom, Bookmark, Repeat and 3D Sound)

Repeat the current track, chapter, title, or all of the disc.

When playing a DVD

- 1 Press the REPEAT button on the remote. Repeat screen appears.
- 2 Select Title, Chapter or A-B using the LEFT/RIGHT buttons.
 - REPEAT a chosen section (A-B).
 - Press the REPEAT button to select A-B.
 - Press the ENTER button to select the point where the function starts. (A)
 - Press the ENTER button to select the point where the function ends. (B)
 - REPEAT a chosen section (A-B) does not allow you to set point (B) until at least 5 seconds has elapsed after point (A) has been set.
 - To terminate the function, press the CLEAR button.
- 3 Press ENTER.
- 4 To return to normal play, press REPEAT again, then press the LEFT/RIGHT buttons to select Off and Press the ENTER.

NOTE

- DVD repeats play by chapter or title, CD repeats play by disc or track.
- Depending on the disc, the Repeat function may not work.

DVD

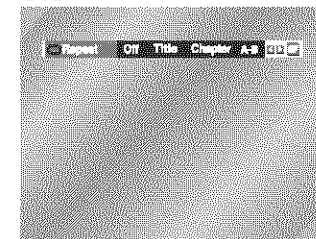

CD

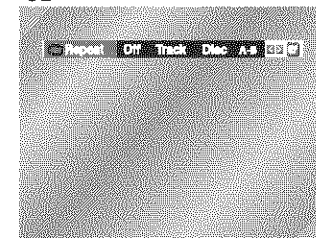

Selecting the Audio Language

You can select a desired language quickly and easily with the AUDIO button.

Using the AUDIO button

- 1 Press the AUDIO button.
- 2 Use the LEFT/RIGHT buttons to select the desired language on a DVD.
 - The audio languages are represented by abbreviations.
- 3 Use the LEFT/RIGHT buttons to select Stereo, LEFT or RIGHT. (On CD)

DVD

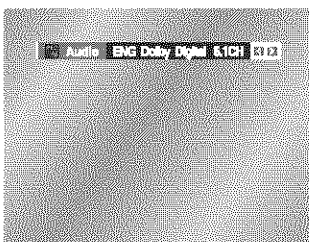

CD

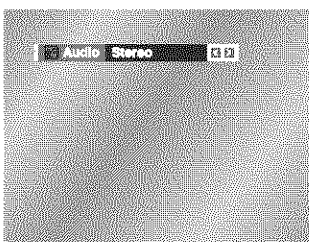

NOTE

- This function depends on what languages are encoded on the disc and may not work with all DVDs.
- A DVD disc can contain up to 8 audio languages.
- **How to have the same audio language come up whenever you play a DVD;**
Refer to "Setting Up the Language Features" on page 40.

Selecting the Subtitle Language

You can select a desired subtitle quickly and easily with the SUBTITLE button.

Using the SUBTITLE button

- 1 Press the SUBTITLE button.
- 2 Use the LEFT/RIGHT buttons to select the desired subtitle language.
- 3 Use the UP/DOWN buttons to determine whether or not the subtitle will be displayed.
 - Initially, the subtitling will not appear on screen.
 - The subtitle languages are represented by abbreviations.

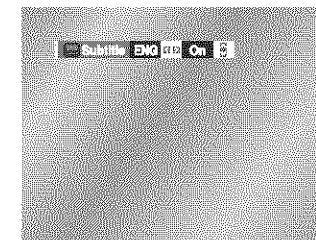
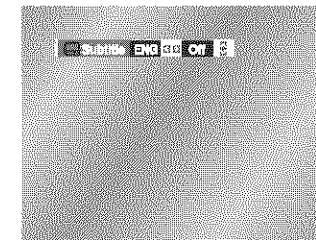

NOTE

- This function depends on what languages are encoded on the disc and may not work with all DVDs.
- A DVD disc can contain up to 32 subtitle languages.
- **How to have the same subtitle language come up whenever you play a DVD;**
Refer to "Setting Up the Language Features" on page 41.

Changing the Camera Angle, S.FIT Play

When a DVD contains multiple angles of a particular scene, you can select the Angle function.

Using the ANGLE button

Press the ANGLE button to see if an ANGLE () mark is present at the upper left hand corner of the screen.

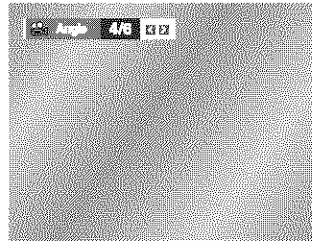

- 1 When an ANGLE mark is shown, press the ANGLE button, then an ANGLE select icon will appear at the upper left hand corner of the screen.
- 2 Use the LEFT/RIGHT buttons to select the desired screen angle.
- 3 To turn off the display, press the ANGLE button again.

Using the Screen Fit button

During play, press S.FIT button on remote control.

- 1 - Allows you to eliminate the black bars in the top and bottom of the screen when a movie is playing in the Widescreen format(16:9).
- Screen Fit will not work when the Zoom mode is active. (you can not remove the black bars on the screen) However, Zoom mode will work when Screen Fit is active.

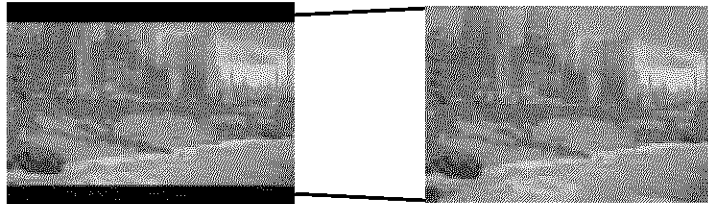

NOTE

- Various aspect ratios are available only in multiple screen format discs.
- This function does not work when a DVD has been recorded with a multi-camera angle format.
- On some DVDs, the black bars cannot be eliminated due to their aspect ratio.

Using the Instant Replay/Skip Function

Using the Instant Replay function (DVD)

If you miss a scene, you can see it again using this function.

- 1 If you press the I.REPLAY button, the current scene moves backward about 10 seconds, and plays back.

- Depending on the disc, the Instant Replay function may not work.

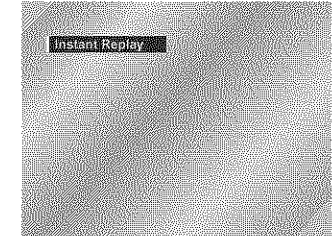

Using the Instant Skip function (DVD)

Use this function to skip playback 10 seconds ahead of the current scene.

- 1 Press the I.SKIP button.

- Playback will skip ahead 10 seconds.
- Depending on the disc, this feature may not work.

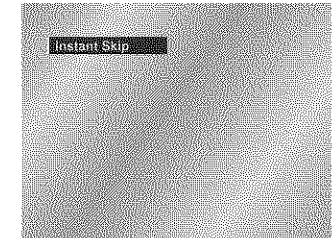

Using the Bookmark Function

This feature lets you bookmark sections of a DVD so you can quickly find them at a later time.

Using the Bookmark Function (DVD)

- 1 During play, press the BOOKMARK button on the remote. The Bookmark (--) icons will be displayed.
- 2 Use the LEFT/RIGHT buttons to move to the desired bookmark icon.
- 3 When you reach the scene you want to mark, press the ENTER button. The icon will change to a number (1, 2, or 3).
- 4 Press the BOOKMARK button to turn off the display.

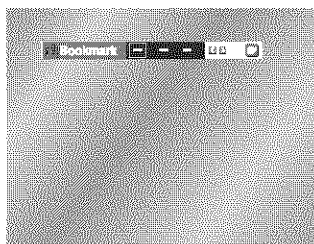

Recalling a Marked Scene

- 1 During play, press the BOOKMARK button on the remote.
- 2 Use the LEFT/RIGHT buttons to select a marked scene.
- 3 Press the PLAY/PAUSE (▶||) buttons to skip to the marked scene.

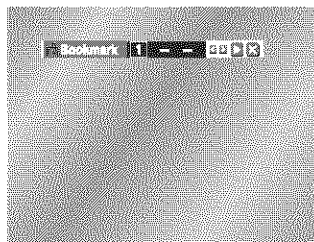

Clearing a Bookmark

- 1 During play, press the BOOKMARK button on the remote.
- 2 Use the LEFT/RIGHT buttons to select the bookmark number you want to delete.
- 3 Press the CLEAR button to delete a bookmark number. Press the BOOKMARK button to turn off the display.

NOTE

- Up to three scenes may be marked at a time.
- Depending on the disc, the Bookmark function may not work.

Using the Zoom & 3D Sound Functions

Using the Zoom Function (DVD)

- 1 During play or pause mode, press the ZOOM button on the remote.
A ZOOM (🔍) mark will be displayed on screen.
- 2 Use the UP/DOWN or LEFT/RIGHT buttons to select the part of the screen you want to zoom in on.
- 3 Press the ENTER button.
- During DVD play, press ENTER to zoom in 2X/4X/2X/Normal in order.

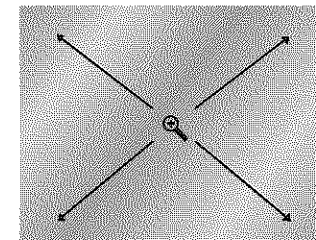

Using the 3D Sound Function

The simulated surround effect depends on the disc contents. If you connect the unit to your stereo system, you can enhance sound quality and produce a greater surround effect. This feature is useful when you are using the DVD player with a two channel stereo through the analog outputs. (Discs which are recorded with LPCM or DTS will not work.)

- 1 During play, press the 3D button.
The 3D SOUND (🎧) mark will be displayed on screen.
- 2 Press the UP/DOWN buttons to turn the 3D Sound feature On or Off.

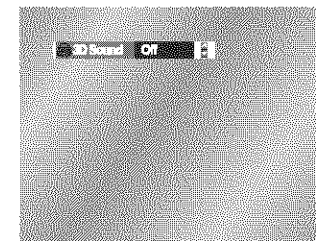

NOTE

- 3D Sound is possible only on discs recorded using DOLBY SURROUND or DOLBY DIGITAL. However, some of these discs do not contain rear channel sound signals.
- Depending on the disc, the Zoom and 3D Sound functions may not work.

When an MP3 Disc is inserted into the DVD player, the first song file of the first folder plays.

- If more than two file extensions are present, select the media of your choice by pressing UP/DOWN, then ENTER.
- To change the currently playing media, press the STOP (■) button twice and then press the MENU button.
- If no button on the remote controller is pressed for 60 seconds, the menu will disappear and the selected item will be played.

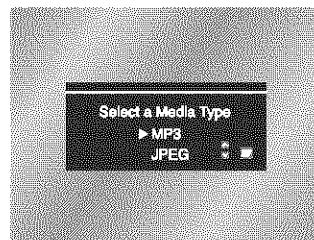

MP3 Play Function

1 When the first song file is playing, the music folder menu will appear on the right side of the screen.

Up to 8 music folders can be displayed at a time. If you have more than 8 folders on a disc, press the LEFT/RIGHT buttons to bring them up on the screen.

2 Use the UP/DOWN buttons to select the desired music folder, then press ENTER. Use the UP/DOWN buttons again to select a song file. Press ENTER to begin playback of the song file.

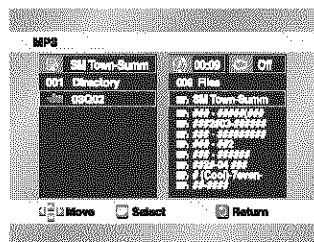

Program/Random playback

Press the PROG button to switch between the PROGRAM and RANDOM modes. See page 34 for more information on these modes.

NOTE

- Press the REPEAT button to hear only music continuously and press it once again to release.
- WMA discs are not supported on this player.
- It does not work Setup Menu in CD-R (MP3, JPEG)
- If the player is left for 10 minutes in MP3 play mode, the screen will fade out. Press any button to resume the screen.

CD-R MP3 discs

When playing CD-R/MP3 disc, please follow all the recommendations for CD-R above, plus the comments below:

- **Your MP3 files should be ISO 9660 format.**
ISO 9660 format and Joliet MP3 files are compatible with Microsoft's DOS and Windows, and with Apple's Mac. These two formats are the most widely used.
- **When naming your MP3 files do not exceed 8 characters, and place ".mp3" as the file extension.**
General name format of: Title.mp3. When composing your title, make sure that you use 8 characters or less, have no spaces in the name, and avoid the use of special characters including: (.,/\,=,+).
- **Use a decompression transfer rate of at least 128 Kbps when recording MP3 files.**
Sound quality with MP3 files basically depends on the rate of compression/decompression you choose. Getting audio CD quality sound requires an analog/digital sampling rate, that is conversion to MP3 format, of at least 128 Kbps and up to 160 Kbps. However, choosing higher rates, like 192 Kbps or more, only rarely give better sound quality. Conversely, files with decompression rates below 128 Kbps will not be played properly.
- **Do not try recording copyright protected MP3 files.**
Certain "secured" files are encrypted and code protected to prevent illegal copying. These files are of the following types: Windows Media™ (registered trade mark of Microsoft Inc) and SDMI™ (registered trade mark of The SDMI Foundation). You cannot copy such files.
- **Important:** The above recommendations cannot be taken as a guarantee that the DVD player will play MP3 recordings, or as an assurance of sound quality. You should note that certain technologies and methods for MP3 file recording on CD-Rs prevent optimal playback of these files on your DVD player (degraded sound quality and in some cases, inability of the player to read the files).
- This unit can play a maximum of 500 files and 300 folders per disc.

Program Play (CD/MP3)

- 1 Press the PROG button.
- 2 Use the UP/DOWN buttons to select Program. Press the ENTER button.
- 3 Use the LEFT/RIGHT/UP/DOWN buttons to select the first track to add to the program. Press the ENTER button. The selection numbers appear in the Program Order box.
- 4 Press the PLAY/PAUSE (▶||) button. The disc will be played in programmed order.

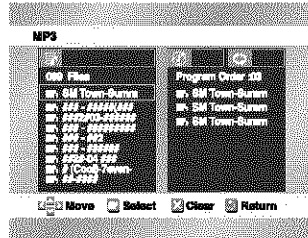
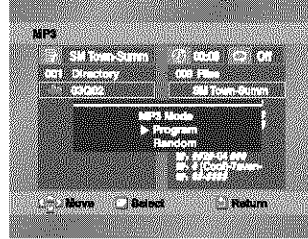

Random Play (CD/MP3)

- 1 Press the PROG button.
- 2 Use the UP/DOWN buttons to select Random. Press the ENTER button. The disc will be played in random order.

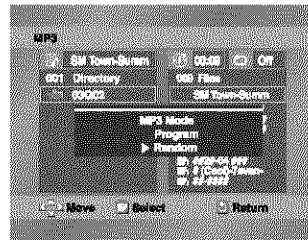

NOTE

- Depending on the disc, the Program and Random Play functions may not work.
- To resume normal play, press the CLEAR button.
- Up to 99 files can be programmed on this unit.

- 1 Open the disc tray.
- 2 Load the disc on the tray.
 - Load the disc with the labeled side up.
- 3 Close the tray.
 - The tray closes and you should get a screen that looks like the one to the right.
 - Select JPEG in the menu to view a Photo CD.
 - Use the UP/DOWN or LEFT/RIGHT buttons on the remote controller to select the picture you want to view and then press the ENTER button. (Press the PLAY/PAUSE (▶||) button if you want to play it in the Slide Show mode.)

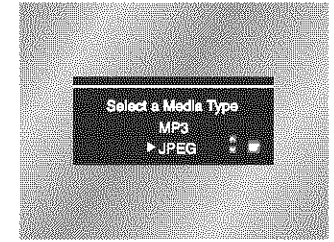

- To see the next 6 pictures, press the ▶▶ button.
 - To see the previous 6 pictures, press the ◀◀ button.
 - [MENU] : Return to the Album Screen. Press the UP/DOWN or LEFT/RIGHT buttons on the remote controller to display the menu again.
 - [ENTER] : Each time the ENTER button is pressed, the picture rotates 90 degrees clockwise.
 - [ENTER] : Each time the ENTER button is pressed, the picture is enlarged up to 4X. (Normal → 2X → 4X → 2X → Normal)
 - [SLIDE] : The unit enters slide show mode.
- *Press the RETURN button to return to the album screen.
*Before the Slide Show can begin, the picture interval must be set.

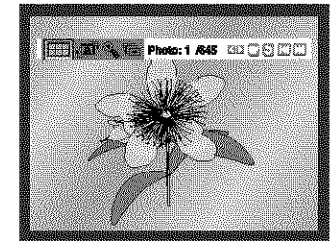
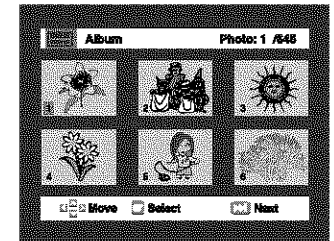

- [STOP] : When this icon is selected and ENTER is pressed, the pictures change automatically with about a 2 second interval.
- [STOP] : The pictures change automatically with about a 6 second interval.
- [STOP] : The pictures change automatically with about a 10 second interval.

- *Depending on the file size, the interval between images may take longer or shorter than set.
- To change the currently playing media, press the STOP (■) button twice and then press the MENU button.

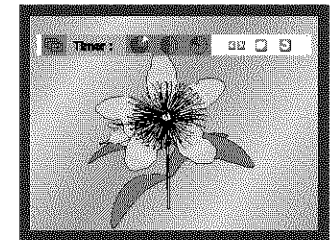

NOTE

- Press the DISC MENU button to return to the album screen at the stop mode.
- Press the RETURN button to return to the slide show.
- If no buttons on the remote controller pressed for 10 seconds, the menu will disappear. Press the UP/DOWN or LEFT/RIGHT buttons on the remote controller to display the menu again.
- It does not work Setup Menu in CD-R (MP3, JPEG)
- If the player is left for 30minutes in the album or photo screen of the picture CD mode, the player will be the STOP mode.

CD-R JPEG Discs

- Progressive JPEG files can not be played (Display N.A. mark).
- Only files with the ".jpg" and ".JPG" extensions can be played.
- If the disc is not closed, it will take longer to start playing and not all of the recorded files may be played.
- Only CD-R discs with JPEG files in ISO 9660 or Joliet format can be played.
- The name of the JPEG file may not be longer than 8 characters and should contain no blank spaces or special characters (. / = +).
- Only a consecutively written multisession disc can be played. If there is a blank segment in the multisession disc, the disc can be played only up to the blank segment.
- A maximum of 500 images can be stored on a single CD.

The Setup menu lets you customize your DVD player by allowing you to select various language preferences, set up a parental level, even adjust the player to the type of television screen you have.

- 1 With the unit in Stop mode, press the MENU button on the remote. Select **Setup** using UP/DOWN buttons, then press the RIGHT or ENTER button.



- 1 **Language Setup** : Setup of the Language Options.
 - 2 **Audio Setup** : Setup of the Audio Options.
 - 3 **Display Setup** : Setup of the Display Options. Use to select which type of screen you want to watch and several display options.
 - 4 **Parental Setup** : Setup of the Parental Level. Allows users to set the level necessary to prevent children from viewing unsuitable movies such as those with violence, adult subject matter, etc.
- 2 Use the UP/DOWN buttons on the remote to access the different features.
 - 3 Press the ENTER button to access the sub features.
 - 4 To make the setup screen disappear after setting up, press the MENU button again.

NOTE

Depending on the disc, some Setup Menu selections may not work.

Setting Up the Language Features

If you set the player menu, disc menu, audio and subtitle language in advance, they will come up automatically every time you watch a movie.

Using the Player Menu Language

- 1 With the unit in Stop mode, press the MENU button.
- 2 Select **Setup** using UP/DOWN buttons, then RIGHT or ENTER button.
- 3 Select **Language Setup** using UP/DOWN buttons, then press the RIGHT or ENTER button.
- 4 Select **Player Menu** using UP/DOWN buttons, then press the RIGHT or ENTER button.
- 5 Use the UP/DOWN buttons to select '**English**'.
- 6 Press the ENTER button.
 - English is selected and the screen returns to SETUP menu.
 - To make the SETUP menu disappear, press the RETURN or LEFT button.

e.g. Setting up in English.

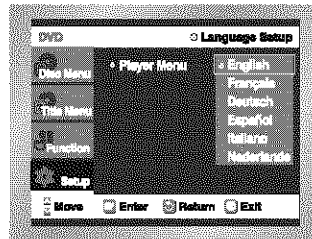
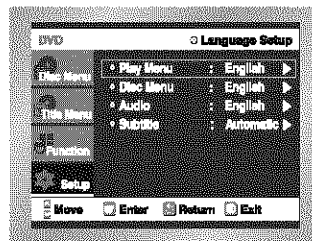
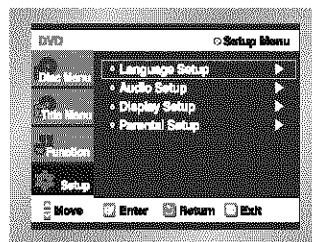

Setting Up the Language Features

Using the Disc Menu Language

This function changes the text language only on the disc menu screens.

- 1 With the unit in Stop mode, press the MENU button.
- 2 Select **Setup** using UP/DOWN buttons, then RIGHT or ENTER button.
- 3 Select **Language Setup** using UP/DOWN buttons, then press the RIGHT or ENTER button.
- 4 Select **Disc Menu** using UP/DOWN buttons, then press the RIGHT or ENTER button.
- 5 Use the UP/DOWN buttons to select '**English**'.
 - Select "Others" if the language you want is not listed.
- 6 Press the ENTER button.
 - English is selected and the screen returns to SETUP menu.

e.g. Setting up in English.

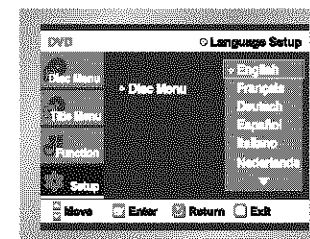
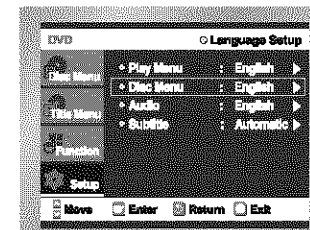

Setting Up the Language Features

Using the Audio Language

- 1 With the unit in Stop mode, press the MENU button.
- 2 Select **Setup** using UP/DOWN buttons, then RIGHT or ENTER button.
- 3 Select **Language Setup** using UP/DOWN buttons, then press the RIGHT or ENTER button.
- 4 Select **Audio** using UP/DOWN buttons, then press the RIGHT or ENTER button.
- 5 Press the UP/DOWN buttons to select '**English**'.
 - Select "Original" if you want the default soundtrack language to be the original language the disc is recorded in.
 - Select "Others" if the language you want is not listed.
- 6 Press the ENTER button.
 - English is selected and the screen returns to SETUP menu.

e.g Setting up in English.

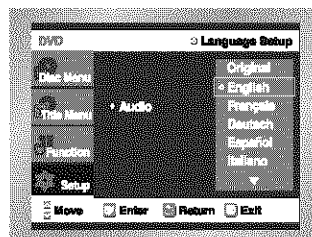
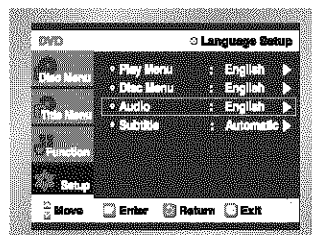
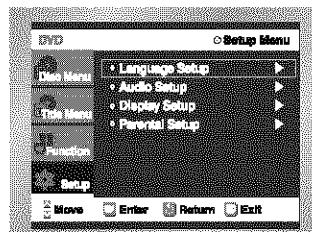

Setting Up the Language Features

Using the Subtitle Language

- 1 With the unit in Stop mode, press the MENU button.
- 2 Select **Setup** using UP/DOWN buttons, then RIGHT or ENTER button.
- 3 Select **Language Setup** using UP/DOWN buttons, then press the RIGHT or ENTER button.
- 4 Select **Subtitle** using UP/DOWN buttons, then press the RIGHT or ENTER button.
- 5 Use the UP/DOWN buttons to select '**Automatic**'.
 - Select "Others" if the language you want is not listed. Some discs may not contain the language you select as your initial language; in that case the disc will use its original language setting.
- 6 Press the ENTER button.
 - English is selected and the screen returns to SETUP menu.

e.g Setting up in Automatic mode

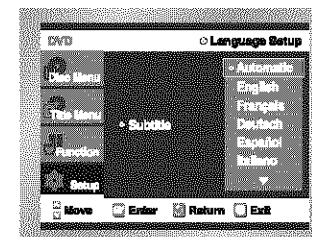
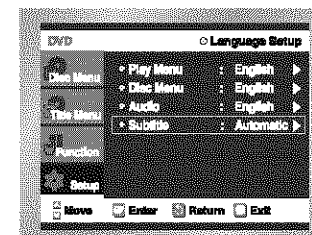
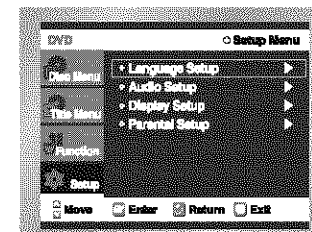

NOTE

- If the selected language is not recorded on the disc, the original pre-recorded language is selected.
- **How to make the SETUP menu disappear or return to menu screen during set up ;**
Press RETURN or LEFT button.

Setting Up the Audio Options

Using the Audio Options

- 1 With the unit in Stop mode, press the MENU button.
- 2 Select **Setup** using UP/DOWN buttons, then RIGHT or ENTER button.
- 3 Select **Audio Setup** using UP/DOWN buttons, then press the RIGHT or ENTER button.
- 4 Use the UP/DOWN buttons to select the desired item. Then press the RIGHT or ENTER button.

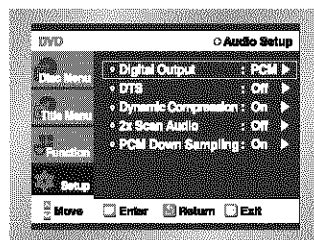
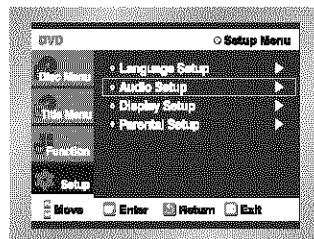

1 Digital Output

1. **PCM** : Converts to PCM(2CH) 48kHz audio.
Select PCM when using the Analog Audio Outputs.
2. **Bitstream** : Converts to Dolby Digital Bitstream (5.1CH).
Select Bitstream when using the Digital Audio Output.

NOTE : Be sure to select the correct Digital Output or no audio will be heard.

2 DTS

1. Off : Doesn't output digital signal.
2. On : Outputs DTS Bitstream via digital output only.
Select DTS when connecting to a DTS Decoder.

3 Dynamic Compression

1. On : To select dynamic compression.
2. Off : To select the standard range.

4 2x Scan Audio

1. Off : Doesn't output Double Scan Audio sound.
2. On : Output Double Scan Audio sound.

5 PCM Down Sampling

1. On : Select this when the amplifier connected to the player is not 96KHz compatible.
In this case, the 96KHz signals will be down converted to 48KHz.
2. Off : If the disc is copy protected, the output will be 48KHz.
If not, the output will be 96KHz.

NOTE

- How to make the **SETUP** menu disappear or return to menu screen during set up;
Press RETURN or LEFT button.
- Manufactured under license from Dolby Laboratories.
"Dolby" and the double-D symbol are trademarks of Dolby Laboratories.
- "DTS" and "DTS Digital Out" are trademarks of Digital Theater Systems, Inc.

Setting Up the Display Options

Using the Display Options

- 1 With the unit in Stop mode, press the MENU button.
- 2 Select **Setup** using UP/DOWN buttons, then RIGHT or ENTER button.
- 3 Select **Display Setup** using UP/DOWN buttons, then press the RIGHT or ENTER button.
- 4 Use the UP/DOWN buttons to select the desired item. Then press the RIGHT or ENTER button.

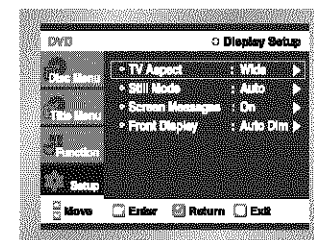

1 TV Aspect

Depending on the type of television you have, you may want to adjust the screen setting (aspect ratio).

1. **16:9 Wide** :
You can view the full 16:9 picture on your widescreen TV.
2. **4:3 Pan Scan** :
Select this for conventional size TVs when you want to see the central portion of the 16:9 screen.
(Extreme left and right side of movie picture will be cut off.)
3. **4:3 Letter Box** :
Select when you want to see the total 16:9 ratio screen DVD supplies, even though you have a TV with a 4:3 ratio screen.
Black bars will appear at the top and bottom of the screen.

2 Still Mode

These options will help prevent picture shake in still mode and display small text clearer.

1. **Auto** : When selecting Auto, Field/Frame mode will be automatically converted.
2. **Frame** : Select this feature when you want to see small letters more clearly in the Auto mode.
3. **Field** : Select this feature when the screen shakes in the Auto mode.

3 Screen Messages

Use to turn on-screen messages On or Off.

4 Front Display

Adjust the brightness of the unit's front panel display.

1. **Auto Dim** : Makes the Front Panel Display dim automatically when playing a DVD.
2. **Dim** : Makes the Front Panel Display dim.
3. **Bright** : Makes the Front Panel Display bright.

NOTE

- How to make the **SETUP** menu disappear or return to menu screen during set up;
Press the RETURN or LEFT button.

Setting Up the Parental Control

The Parental Control function works in conjunction with DVDs that have been assigned a rating - which helps you control the types of DVDs that your family watches. There are up to 8 rating levels on a disc.

- 1 With the unit in Stop mode, press the MENU button.
- 2 Select **Setup** using UP/DOWN buttons, then RIGHT or ENTER button.
- 3 Select **Parental Setup** using UP/DOWN buttons, then press the RIGHT or ENTER button.
- 4 Use RIGHT or ENTER to select **On** if you want to use a password. The **Enter Password** screen appears.
- 5 Enter your new password. The **Re-enter Password** screen appears to confirm the password. Enter your new password again. The Parental Control screen appears.

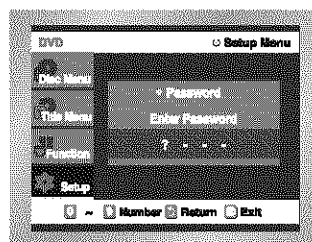
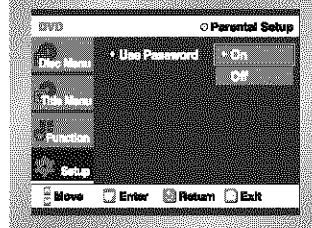
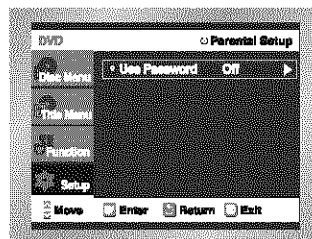

Setting Up the Parental Control

e.g Setting up in LEVEL1.

About the Rating Level ;

The Rating Level will work only when Use Password is set to On. To unlock the player, use UP/DOWN to select Off. Use RIGHT or ENTER to select Rating level. Press ENTER.

- Use UP/DOWN to select the level(e.g. Level 1) and press ENTER. Discs that contain Level 2~7 will now not play.
- To cancel the rating level, use RIGHT or ENTER to select Off in Use Password.

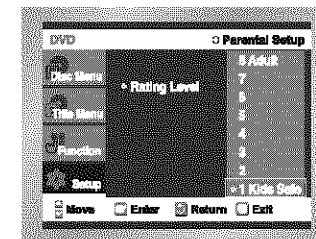
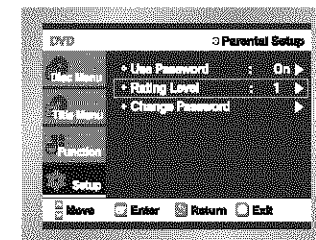

About the Change Password ;

- Use UP/DOWN to select **Change Password**. Press ENTER. The Change Password screen appears.
- Enter your new password. Re-enter the new password again.

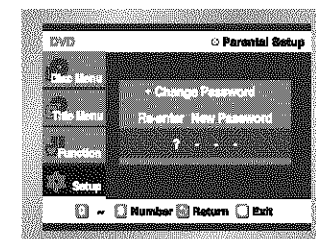
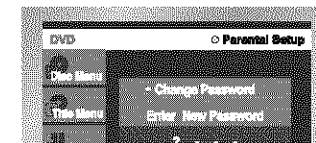
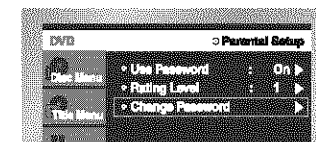

NOTE

- How to make the SETUP menu disappear or return to menu screen during set up; Press RETURN or LEFT button.
- If you have forgotten your password, see Forget Password in the Troubleshooting Guide.

CHANGING SETUP MENU

The remote can also be set up to control most TVs. To program the remote, use the code that corresponds to your brand.

TV Codes

Code	Brand	Code	Brand
01	SAMSUNG_1	16	SHARP_1
02	SHARP_2	17	ZENITH
03	SONY	18	LG_3
04	MAGNAVOX	19	DAEWOO_8
05	SANYO_1	20	SANYO_2
06	LG_2	21	EMERSON
07	RCA	22	SHARP_3
08	LG_1	23	SAMSUNG_4
09	TOSHIBA	24	PANASONIC_2
10	HITACHI	25	NOBLEX
11	JVC	26	TELEFUNKEN
12	PANASONIC_1	27	NEWSAN
13	MITSUBISHI_2	28	LOEWE
14	SAMSUNG_2	29	RCA2
15	SAMSUNG_3		

- 1 Turn on the TV
- 2 Point the DVD's remote at the TV.
- 3 While holding the TV POWER button down, enter the code for your brand.
- 4 If the TV turns off, setup is complete. Enter other codes of the same brand if the first code does not work.
- 5 To operate the TV, use the "TV Function Buttons" described on page 13.



e.g) For Samsung_1 TVs

While holding down the TV POWER button, enter 0 and then 1.

NOTE

The remote may not be able to control every model TV of the brands listed.

Before requesting service (troubleshooting), please check the following.

Problem	Action	Page
No operations can be performed with remote.	<ul style="list-style-type: none"> Check the batteries in the remote. May need replacing. Operate the remote control at a distance of no more than 20 feet. Remove batteries and hold down one or more buttons for several minutes to drain the microprocessor inside the remote to reset it. Reinstall batteries and try remote again. 	P5
Disc does not play.	<ul style="list-style-type: none"> Ensure that the disc is installed with the label side facing up. Check the region number of the DVD. 	P8
5.1 channel sound is not being reproduced.	<ul style="list-style-type: none"> 5.1 channel sound is reproduced only when the following conditions are met. : <ol style="list-style-type: none"> The DVD player is connected with the proper amplifier The disc is recorded with 5.1 channel sound. Check whether the disc being played has the "Dolby 5.1 ch" mark on the outside. Check if your audio system is connected and working properly. In a SETUP Menu, is the Audio Output set to Bitstream? 	P14 P42
The  icon appears on screen.	<ul style="list-style-type: none"> The features or action cannot be completed at this time because: <ol style="list-style-type: none"> The DVD's software restricts it. The DVD's software doesn't support the feature (e.g., angles). The feature is not available at the moment. You've requested a title or chapter number or search time that is out of range. 	P20
Disc Menu doesn't appear.	<ul style="list-style-type: none"> Check if the disc has a Menu. 	P23
Play mode differs from the Setup Menu selection.	<ul style="list-style-type: none"> Some of the functions selected in the Setup Menu may not work properly if the disc is not encoded with the corresponding function. 	P37~45
The screen ratio cannot be changed.	<ul style="list-style-type: none"> The Screen Ratio is fixed on your DVDs. 	P43
No audio.	<ul style="list-style-type: none"> Make sure you have selected the correct Digital Output in the Audio Options Menu. 	P42
Forgot password	<ul style="list-style-type: none"> Press power on from a cold start with no disc in the unit. Press the STOP () and PLAY () buttons simultaneously on the front panel for three seconds. The Select Menu Language display will appear. Select the desired language button. Press the MENU button on the remote control to select the Parental Mode. The Parental Mode is now unlocked as indicated on the display. Press the DOWN button to select Parental. Press ENTER and the Create Password display will appear. You can now set your rating level and change your password to a new number. 	P44~45
If you experience other problems.	<ul style="list-style-type: none"> Go to the contents and find the section of the instruction book that contains the explanations regarding the current problem, and follow the procedure once again. If the problem still cannot be solved, please contact your nearest samsung authorized service center. 	

Troubleshooting

Problem	Action	Page
No DVI output.	<ul style="list-style-type: none"> See if the "Progressive Scan" function is set to on in the DVD player front panel. If this function is activated, the video output to DVI will be disabled. Check the connection between the TV and the DVI jack of DVD player. See if the TV supports this 480p/720p/1080i DVD player. 	P16~18
Abnormal DVI output screen.	<ul style="list-style-type: none"> If snow noise appears on the screen, it means that TV does not support HDCP (High-bandwidth Digital content protect). Check the region number of the DVD. 	

Specifications

General	Power Requirements	AC 120 V, 60 Hz
	Power Consumption	18 W
	Weight	5.4 lbs
	Dimensions	W 16.9 in x D 9.4 in x H 2.4 in
	Operating Temperature Range	+41°F to +95°F
	Operating Humidity Range	10 % to 75 %
Disc	DVD (DIGITAL VERSATILE DISC)	Reading Speed : 11.45 ft/sec. Approx. Play Time (Single Sided, Single Layer Disc) : 135 min.
	CD : 5" (COMPACT DISC)	Reading Speed : 3.9 to 4.6 ft/sec. Maximum Play Time : 74 min.
	CD : 3 1/2" (COMPACT DISC)	Reading Speed : 3.9 to 4.6 ft/sec. Maximum Play Time : 20 min.
Video Output	Composite Video	1 channel : 1.0 Vp-p (75 Ω load)
	Component Video	Y : 1.0 Vp-p (75 Ω load) Pr : 0.70 Vp-p (75 Ω load) Pb : 0.70 Vp-p (75 Ω load)
	S-VIDEO	Luminance Signal : 1.0 Vp-p (75 Ω load) Chrominance Signal : 0.286 Vp-p (75 Ω load)
	DVI	Digital Visual Interface (50Ω load)
Audio Output	2 Channel	L(1/L), R(2/R)
	*Frequency Response	48 kHz Sampling : 4 Hz to 22 kHz 96 kHz Sampling : 4 Hz to 44 kHz
	*S/N Ratio	110 dB
	*Dynamic Range	100 dB
	*Total Harmonic Distortion	0.004 %

*: Nominal specification

- Samsung Electronics Co., Ltd reserves the right to change the specifications without notice.
- Weight and dimensions are approximate.

LIMITED WARRANTY TO ORIGINAL PURCHASER

This SAMSUNG brand product, as supplied and distributed by SAMSUNG ELECTRONICS AMERICA, INC. (SAMSUNG) and delivered new, in the original carton to the original consumer purchaser, is warranted by SAMSUNG against manufacturing defects in materials and workmanship for the following limited warranty period:

One (1) Year Parts and Labor

This limited warranty begins on the original date of purchase, and is valid only on products purchased and used in the United States, and does not include transportation, installation, removal or reinstallation. Warranty repairs must be performed by SAMSUNG's authorized service center. To receive warranty service, the original dated bill of sale must be presented upon request as proof of purchase to SAMSUNG or SAMSUNG's authorized service center. Transportation to and from the service center is the responsibility of the purchaser.

SAMSUNG will repair or replace this product, at our option and at no charge with new or reconditioned parts, if found to be defective during the limited warranty period specified above. The product must be returned during the warranty period with transportation charges prepaid to SAMSUNG's designated service center. Prior to returning any product for warranty service, the purchaser must contact SAMSUNG for problem determination and service procedures. SAMSUNG does not warrant uninterrupted or error-free operation of the product. All replaced parts and products become the property of SAMSUNG and must be returned to SAMSUNG. Replacement parts and products assume the remaining original warranty, or ninety (90) days, whichever is longer.

This limited warranty covers manufacturing defects in materials and workmanship encountered in normal, noncommercial use of this product and shall not apply to the following, including, but not limited to: damage which occurs in shipment; applications and uses for which this product was not intended; failures or problems which are caused by products or equipment not supplied by SAMSUNG; accidents, misuse, abuse, neglect, misapplication, fire, water, lightning or other acts of nature; incorrect electrical line voltage, fluctuations or surges; damage caused by improper or faulty installation; improper connection with any peripheral; product alteration or modification; improper or unauthorized repair; cosmetic damage or exterior finish; product with altered serial numbers; failure to follow operating instructions, customer adjustments, maintenance and environmental instructions that are covered and prescribed in the instruction book; use of non-SAMSUNG or unauthorized parts, supplies, accessories or equipment which damage this product or result in service problems; failures or problems due to incompatibility with other equipment.



ELECTRONICS

HEADQUARTERS

105 Challenger Road, Ridgefield Park,
N.J. 07660-0511

TEL: 1-800-SAMSUNG

SERVICE DIVISION

400 Valley Road, Suite 201
Mount Arlington, NJ 07856

1-800-SAMSUNG (1-800-726-7864)

www.samsungusa.com