

SONY

SONY®

4-093-894-11 (1)

WEGA

LCD Color TV KLV30XBR900

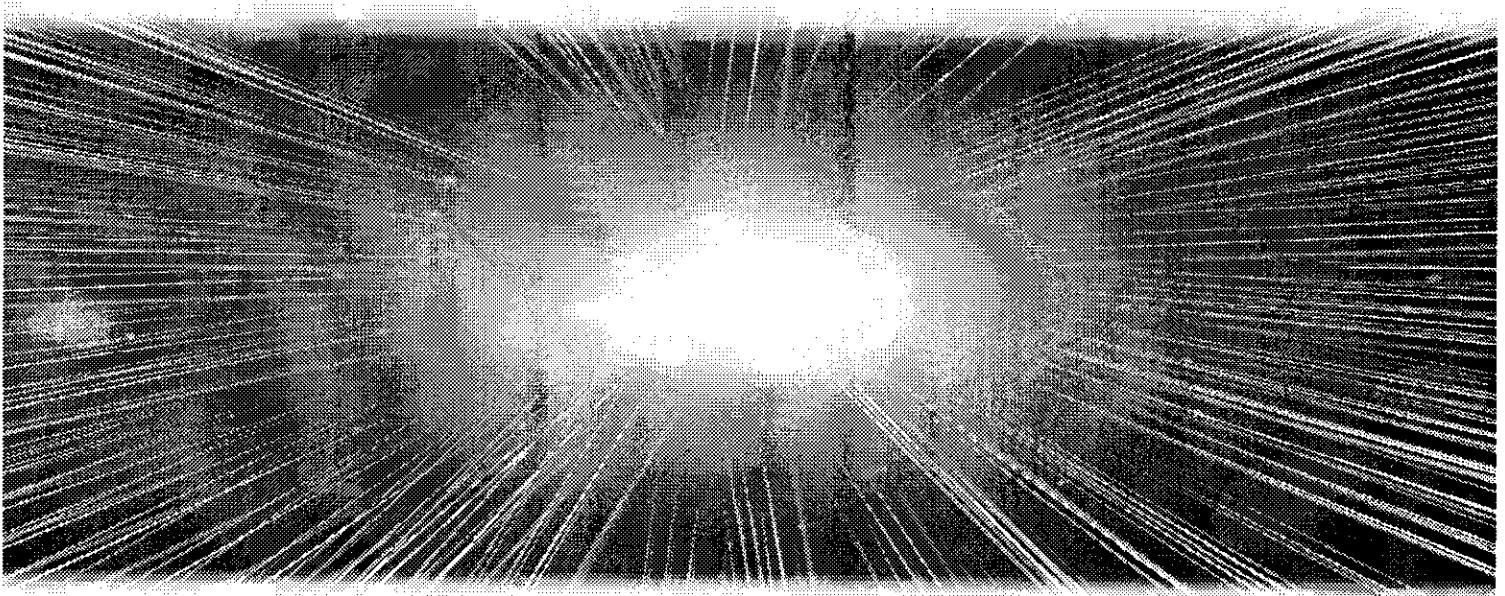

**LCD Color TV
Operating Instructions**

KLV30XBR900

XBR



— © 2003 Sony Corporation

WARNING

To reduce the risk of fire or shock hazard, do not expose the TV to rain or moisture.



This symbol is intended to alert the user to the presence of uninsulated “dangerous voltage” within the product’s enclosure that may be of sufficient magnitude to constitute a risk of electric shock to persons.



This symbol is intended to alert the user to the presence of important operating and maintenance (servicing) instructions in the literature accompanying the appliance.

CAUTION

To prevent electric shock, do not use this polarized AC plug with an extension cord, receptacle or other outlet unless the blades can be fully inserted to prevent blade exposure.

Note on Caption Vision

This television receiver provides display of television closed captioning in accordance with §15.119 of the FCC rules.

Note to CATV System Installer

This reminder is provided to call the CATV system installer’s attention to Article 820-40 of the National Electrical Code (NEC) that provides guidelines for proper grounding and, in particular, specifies that the cable ground shall be connected to the grounding system of the building, as close to the point of cable entry as practical.

Use of this television receiver for other than private viewing of programs broadcast on UHF or VHF or transmitted by cable companies for the use of the general public may require authorization from the broadcaster/cable company and/or program owner.

NOTIFICATION

This equipment has been tested and found to comply with the limits for a Class B digital device pursuant to Part 15 of the FCC Rules. These limits are designed to provide reasonable protection against harmful interference in a residential installation. This equipment generates, uses, and can radiate radio frequency energy and, if not installed and used in accordance with the instructions, may cause harmful interference with radio communications. However, there is no guarantee that interference will not occur in a particular installation. If this equipment does cause harmful interference to radio or television reception, which can be determined by turning the equipment off and on, the user is encouraged to try to correct the interference by one or more of the following measures:

- Reorient or relocate the receiving antennas.
- Increase the separation between the equipment and receiver.
- Connect the equipment into an outlet on a circuit different from that to which the receiver is connected.
- Consult the dealer or an experienced radio/TV technician for help.

You are cautioned that any changes or modifications not expressly approved in this manual could void your authority to operate this equipment.

Safety

- Operate the TV only on 120 V AC.
- The plug is designed, for safety purposes, to fit into the wall outlet only one way. If you are unable to insert the plug fully into the outlet, contact your dealer.
- If any liquid or solid object should fall inside the cabinet, unplug the TV immediately and have it checked by qualified service personnel before operating it further.
- If you will not be using the TV for several days, disconnect the power by pulling the plug itself. Never pull on the cord.
- For details concerning safety precautions, see “Important Safeguards” on page 3.

Installing

- To prevent internal heat buildup, do not block the ventilation openings.
- Do not install the TV in a hot or humid place, or in a place subject to excessive dust or mechanical vibration.
- Avoid operating the TV at temperatures below 5°C (41°F).
- If the TV is transported directly from a cold to a warm location, or if the room temperature changes suddenly, the picture may be blurred or show poor color due to moisture condensation. In this case, please wait a few hours to let the moisture evaporate before turning on the TV.
- To obtain the best picture, do not expose the screen to direct illumination or direct sunlight. It is recommended to use spot lighting directed down from the ceiling or to cover the windows that face the screen with opaque drapery. It is desirable to install the TV in a room where the floor and walls are not of a reflective material.

CAUTION

The following SONY appliance(s) for use only with the following WALL-HANGING RACK UNIT. Use with other TV STAND or WALL-HANGING RACK UNIT is capable of resulting in instability causing possible injury.

SONY APPLIANCE MODEL NO.

KLV30XBR900

WALL MOUNT UNIT MODEL NO.

SU-PW1

SONY Corp.

Trademark Information

TruSurround and the  symbol are trademarks of SRS Labs, Inc. TruSurround technology is incorporated under license from SRS Labs, Inc.

BBE and BBE Symbol are trademarks of BBE Sound, Inc. and are licensed by BBE Sound, Inc. under U.S. Patent No. 4,638,258 and 4,482,866.

Steady Sound, Digital Reality Creation, Caption Vision, CineMotion, Memory Stick, and Twin View are registered trademarks of Sony Corporation. ClearEdge VM, HD Detailer, and Uniform Brightness Screen are trademarks of Sony Corporation.

Owner's Record

The model and serial numbers are located at the rear of the TV, below the Sony logo, on the sticker, and also on the TV box (white label). Record these numbers in the spaces provided below. Refer to them whenever you call upon your Sony dealer regarding this product.

Model No. _____

Serial No. _____

Important Safeguards

Before using your TV, please read these instructions completely, and keep this manual for future reference.

Carefully observe and comply with all warnings, cautions and instructions placed on the set or described in the operating instructions or service manual.

WARNING

To guard against injury, the following basic safety precautions should be observed in the installation, use and servicing of the set.

Use

Power Sources

This set should be operated only from the type of power source indicated on the serial/model plate. If you are not sure of the type of electrical power supplied to your home, consult your dealer or local power company. For those sets designed to operate from battery power, refer to the operating instructions.



Grounding or Polarization

This set is equipped with a polarized AC power cord plug (a plug having one blade wider than the other), or with a three-wire grounding type plug (a plug having a third pin for grounding). Follow the instructions below:

For the set with a polarized AC power cord plug

This plug will fit into the power outlet only one way. This is a safety feature. If you are unable to insert the plug fully into the outlet, try reversing the plug. If the plug still fails to fit, contact your electrician to have a suitable outlet installed. Do not defeat the safety purpose of the polarized plug by forcing it in.



Wall outlet

Do not use a poor fitting outlet.

Insert the plug fully into the outlet. If it is loose, it may cause arcing and result in fire.

Contact your electrician to have the outlet changed.



Wiring

Unplug the AC power cord when wiring cables.

Be sure to unplug the AC power cord for your safety, when hooking up.

Moisture

Do not touch the AC power cord with a wet hand.

If you plug/unplug the AC power cord with a wet hand, it may cause electric shock.



Cleaning

Clean the AC power plug regularly.

If the plug is covered with dust and it picks up moisture, its insulation may deteriorate and result in fire. Unplug the AC power plug and clean it regularly.

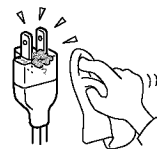

For the set with a three-wire grounding type AC plug

This plug will only fit into a grounding-type power outlet. This is a safety feature. If you are unable to insert the plug into the outlet, contact your electrician to have a suitable outlet installed. Do not defeat the safety purpose of the grounding plug.

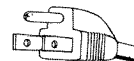

Overloading

Do not overload wall outlets, extension cords or convenience receptacles beyond their capacity, since this can result in fire or electric shock.

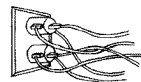

Always turn the set off when it is not being used. When the set is left unattended and unused for long periods of time, unplug it from the wall outlet as a precaution against the possibility of an internal malfunction that could create a fire hazard.



If a snapping or popping sound from a TV set is continuous or frequent while the TV is operating, unplug the TV and consult your dealer or service technician. It is normal for some TV sets to make occasional snapping or popping sounds, particularly when being turned on or off.

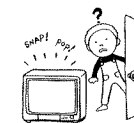

AC power cord and display cable

If you damage the AC power cord or display cable, it may result in fire or electric shock.

- Do not pinch, bend, or twist the cable excessively. The core lines may be bared and cut, and cause short-circuit, resulting in fire or electric shock.
- Do not convert or damage the AC power cord or display cable.
- Do not put anything heavy on the AC power cord or display cable. Do not pull the AC power cord or display cable.
- Keep the AC power cord or display cable away from heat sources.
- Be sure to grasp the plug when disconnecting the AC power cord.
- Refer to the operating instructions when disconnecting the display cable.

If the AC power cord or display cable is damaged, stop using it and ask your dealer or Sony service center to exchange it.

Cleaning

Unplug the AC power cord when cleaning this unit. If not, it may result in electric shock.

Object and Liquid Entry

Never push objects of any kind into the set through the cabinet slots as they may touch dangerous voltage points or short out parts that could result in a fire or electric shock. Never spill liquid of any kind on the set.

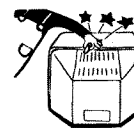

(Continued)

Ventilation holes

Do not insert anything in the ventilation holes. If metal or something flammable enters, it may result in fire or electric shock.



Notes on cleaning of the display

- Be sure to unplug the TV unit before cleaning.
- Minimize contact with the LCD screen surface since the special coating applied may be affected. Use a dry soft cloth when removing dust from the screen.
- Do not use alcohol, benzine, thinner, etc., as it may damage the coating or cause LCD screen deterioration.
- Always use commercially available chemical fibre cleaning cloths in accordance with their supplied instructions.
- Do not allow the LCD screen to come in contact with volatile compounds, such as insecticide. Also, never let the LCD screen come in contact with rubber or plastic products for an extended period of time. This type of contact may damage the coating, or cause the LCD screen to deteriorate.



Notes on cleaning of the chassis

- Wipe the chassis gently with a dry soft cloth. Stubborn stains may be removed with a cloth slightly dampened with a solution of mild soap, and then wiped dry.
- Never subject the chassis to volatile compounds such as alcohol, benzine, thinner or insecticide. Also, never let the chassis come in contact with rubber or plastic products for an extended period of time. This type of contact may damage the coating, and cause the chassis to deteriorate, or efface the printing on the chassis.

Attachments

Do not use attachments not recommended by the manufacturer, as they may cause hazards.

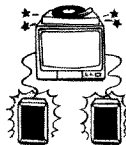

Installation

When installing the display unit on the wall, be sure to have assemblers install and keep away from the unit. If a person other than the assemblers install the display unit on the wall using a wall mount unit, the unit may fall and cause serious injury when an earthquake occurs or when the unit is not installed securely.



Carrying

Carrying the set requires two or more people.

If you carry the set in a manner other than that specified, it may drop and a serious injury may be caused. Be sure two or more people carry the set.

When transporting, do not subject the set to shocks or vibration excessive force. The set may fall and damage the set, causing serious injury.

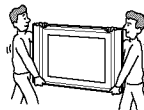

AC power cord

Unplug the AC power cord when moving the set.

Do not move the set with the AC power cord plugged in. It may damage the AC power cord and result in fire or electric shock.

Medical institution

Do not place this unit in a place where medical equipment is in use.

It may cause malfunction of medical instruments.



Water and Moisture

Do not use power-line operated sets near water — for example, near a bathtub, washbowl, kitchen sink, or laundry tub, in a wet basement, or near a swimming pool, etc. It may result in fire or electric shock.



Accessories

Do not place the set on an unstable cart, stand, table or shelf. The set may fall, causing serious injury to a child or an adult and serious damage to the set. Use only a cart or stand recommended by Sony for the specific model of TV. No part of the TV set should overhang any edge of the TV cart or stand; any overhanging edge is a safety hazard. An appliance and cart combination should be moved with care. Quick stops, excessive force, and uneven surfaces may cause the appliance and cart combination to overturn.



Installation and moving

Optional accessories

Observe the following when installing the display unit using a stand or wall mount unit. If not, the unit may fall and cause serious injury.

- Be sure to follow the operating instructions supplied with your stand when installing the unit.
- Be sure to attach the brackets supplied with your stand.



Protruding location

Do not install the display unit in protruding locations. If you install the unit in the following locations, injury may result.

- Do not install the unit in a location where the unit protrudes, such as pillars.
- Do not install the unit in a location that may cause facial injury.

Oils

Do not install this unit in restaurants where oily vapours occur. Dust absorbing oil may enter into the unit and damage the unit.

Corrosion

If you use this unit near the seashore, salt may corrode metal parts of the unit and cause internal damage or fire.

It may also shorten the life of the unit.

Accessories

Secure the display unit from falling down.

If the display unit is not secured properly, it may fall and cause injury. Take measures against it using a stand or other apparatus on the floor or wall in the specified manner, referring to the operating instructions supplied with your stand.

Recommended place for the Media receiver unit

Place the Media receiver unit on a stable, level surface. Otherwise, the Media receiver unit may fall and cause injury. Use an optional Sony stand, which has adequate strength.



Weight

Do not stand on the Media receiver unit. The unit may fall or break, causing injury. Pay special attention to little children.

Ventilation

The slots and openings in the media receiver unit and display unit are provided for necessary ventilation. To ensure reliable operation of the set, and to protect it from overheating, these slots and openings must never be blocked or covered.

Unless proper ventilation is provided, the unit may gather dust and get dirty. For proper ventilation, Observe the following:

- Do not install the unit turned backward or sideways.
- Do not install the unit turned over or upside down.
- Never cover the slots and openings with a cloth or other materials.
- Never block the slots and openings by placing the set on a bed, sofa, rug or other similar surface.
- Never place the set in a confined space, such as a bookcase or built-in cabinet, unless proper ventilation is provided.
- Do not place the set near or over a radiator or heat register, or where it is exposed to direct sunlight.

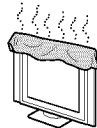

Never install the unit as follows:

Air circulation is blocked.

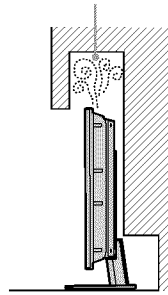

Air circulation is blocked.

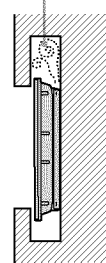

Media receiver unit: Front view

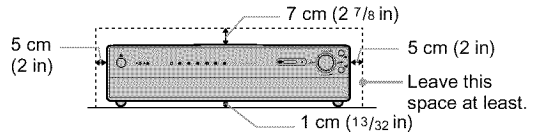

Place the Media receiver unit on a stable level surface so as not to block the inlets at the bottom of the Media receiver unit.

Media receiver unit: Top view

Never place the Media receiver unit in a confined space. It may cause overheating and result in fire, or damage the unit. Ensure reliable operation of the unit by ensuring proper ventilation of the exhaust fan.

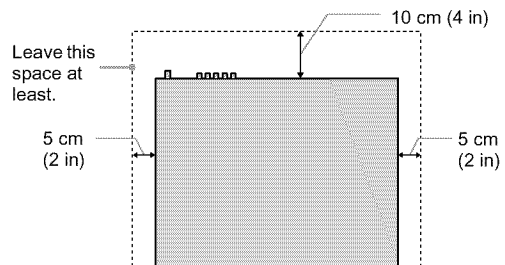

Ventilation

Leave some space around the unit. Otherwise, adequate air-circulation may be blocked causing overheating and cause fire or damage the unit.

When installing the unit on the wall

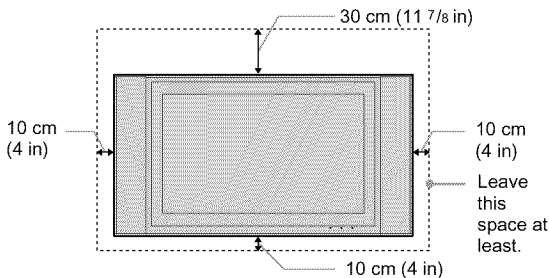

When installing the unit using a stand

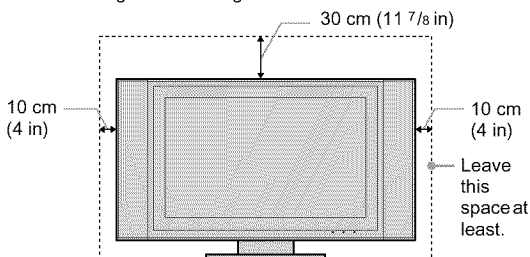

Outdoor use

Do not install this unit outdoors. If the unit is exposed to rain, it may result in fire or electric shock. If the unit is exposed to direct sunlight, the unit may heat up and it may damage the unit.

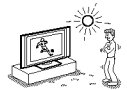

Vehicle and ceiling

Do not install this unit in a vehicle or hung from the ceiling.

Bumping of the vehicle may cause the set to fall down and cause injury.



(Continued)

Ship and vessel

Do not install this unit in a ship or vessel. If the unit is exposed to seawater, it may cause fire or damage the unit.

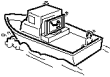

Fall

Do not hang anything on the unit.

The unit may fall from the stand or wall mount unit, causing damage or serious injury.



Power-Cord Protection

Do not allow anything to rest on or roll over the power cord, and do not place the set where the power cord is subject to wear or abuse.



Antennas

Outdoor Antenna Grounding

If an outdoor antenna is installed, follow the precautions below. An outdoor antenna system should not be located in the vicinity of overhead power lines or other electric light or power circuits, or where it can come in contact with such power lines or circuits.

WHEN INSTALLING AN OUTDOOR ANTENNA SYSTEM, EXTREME CARE SHOULD BE TAKEN TO KEEP FROM CONTACTING SUCH POWER LINES OR CIRCUITS AS CONTACT WITH THEM IS ALMOST INVARIABLY FATAL.

Be sure the antenna system is grounded so as to provide some protection against voltage surges and built-up static charges.

Section 810 of the National Electrical Code (NEC) in USA and Section 54 of the Canadian Electrical Code in Canada provides information with respect to proper grounding of the mast and supporting structure, grounding of the lead-in wire to an antenna discharge unit, size of grounding conductors, location of antenna discharge unit, connection to grounding electrodes, and requirements for the grounding electrode.

Antenna Grounding According to the National Electrical Code, ANSI/NFPA 70

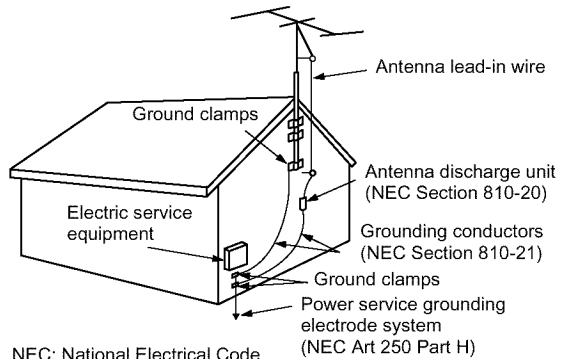

Lightning

For added protection for this television receiver during a lightning storm, or when it is left unattended and unused for long periods of time, unplug it from the wall outlet and disconnect the antenna. This will prevent damage to the receiver due to lightning and power-line surges.

Service

Damage Requiring Service

Unplug the set from the wall outlet and refer servicing to qualified service personnel under the following conditions:

- When the power cord or plug is damaged or frayed.
- If liquid has been spilled into the set.
- If the set has been exposed to rain or water.
- If the set has been subject to excessive shock by being dropped, or the cabinet has been damaged.
- If the set does not operate normally when following the operating instructions. Adjust only those controls that are specified in the operating instructions. Improper adjustment of other controls may result in damage and will often require extensive work by a qualified technician to restore the set to normal operation.
- When the set exhibits a distinct change in performance, it indicates a need for service.

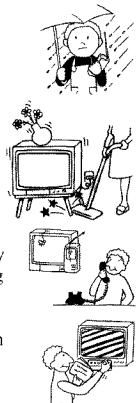

Servicing

Do not attempt to service the set yourself since opening the cabinet may expose you to dangerous voltage or other hazards. Refer all servicing to qualified service personnel.



Replacement Parts

When replacement parts are required, be sure the service technician certifies in writing that he has used replacement parts specified by the manufacturer that have the same characteristics as the original parts.

Unauthorized substitutions may result in fire, electric shock or other hazards.



Safety Check

Upon completion of any service or repairs to the set, ask the service technician to perform routine safety checks (as specified by the manufacturer) to determine that the set is in safe operating condition, and to so certify. When the set reaches the end of its useful life, improper disposal could result in a picture tube implosion. Ask a qualified service technician to dispose of the set.



For Safety

Be careful when moving the TV

When you place the TV in position, be careful not to drop it on your foot or fingers.

Watch your footing while installing the TV.

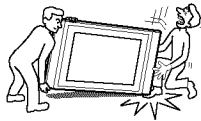

Carry the TV in the specified manner

If you carry the TV in a manner other than specified and without the specified number of persons, it may drop and a serious injury may be caused. Be sure to follow the instructions mentioned below.

- Carry the TV with the specified number of persons.
- Do not carry the TV holding the speaker grill.
- Hold the TV tightly when carrying it.

Others

Damage requiring service

If the surface of the display unit cracks, do not touch it until you unplug the AC power cord.

Otherwise electric shock may result.

Object placement

Do not place something heavy on the Media receiver unit.

It may damage the unit.

Liquid placement

Do not place objects containing liquid on the Media receiver unit.

It may result in electric shock or damage the unit.

Moisture

Do not let this unit get wet. It may result in electric shock or damage the unit.

Electric shock

Do not touch the unit with a wet hand.

Doing so may cause electric shock or damage to the unit.

Broken pieces

Do not throw anything at the unit.

The screen glass may explode by the impact and cause serious injury.

Cable wiring

Take care not to catch your feet on the cables. It may damage the unit.

Heat

Do not touch the surface of the display unit.

It remains hot, even for some time after the display unit is turned off.

Disposal of the display

- Do not dispose of displays with general household waste.
- The LCD contains a small amount of liquid crystal and mercury. The fluorescent tube used in this display also contains mercury. Follow your local ordinances and regulations for disposal.

Handling of broken glass and liquid crystal leakage

If the LCD panel gets damaged, crystalline liquid leakage may occur, or scattered broken glass may result. Do not touch broken glass or crystalline liquid (which is toxic), with bare hands as cuts or poisoning/skin irritation may occur. Also, do not let glass fragments or leaked crystalline liquid get into your eyes or mouth. Should either contact your eyes or mouth, rinse the contacted area thoroughly with water and consult your doctor.

(Continued)

Important Safety Instruction

- 1) Read these instructions.
- 2) Keep these instructions.
- 3) Heed all warnings.
- 4) Follow all instructions.
- 5) Do not use this apparatus near water.
- 6) Clean only with dry cloth.
- 7) Do not block any ventilation openings. Install in accordance with the manufacturer's instructions.
- 8) Do not install near any heat sources such as radiators, heat registers, stoves, or other apparatus (including amplifiers) that produce heat.
- 9) Do not defeat the safety purpose of the polarized or grounding-type plug. A polarized plug has two blades with one wider than the other. A grounding type plug has two blades and a third grounding prong. The wide blade or the third prong are provided for your safety. If the provided plug does not fit into your outlet, consult an electrician for replacement of the obsolete outlet.
- 10) Protect the power cord from being walked on or pinched particularly at plugs, convenience receptacles, and the point where they exit from the apparatus.
- 11) Only use attachments/accessories specified by the manufacturer.
- 12) Use only with the cart, stand, tripod, bracket, or table specified by the manufacturer, or sold with the apparatus. When a cart is used, use caution when moving the cart/apparatus combination to avoid injury from tip-over.



- 13) Unplug this apparatus during lightning storms or when unused for long periods of time.
- 14) Refer all servicing to qualified service personnel. Servicing is required when the apparatus has been damaged in any way, such as power-supply cord or plug is damaged, liquid has been spilled or objects have fallen into the apparatus, the apparatus has been exposed to rain or moisture, does not operate normally, or has been dropped.

LCD screen

- Although the LCD screen is made with high-precision technology and has effective pixels of 99.99% or more, black dots may appear or bright points of light (red, blue, or green) may appear constantly on the LCD screen. This is a structural property of the LCD panel and is not a malfunction.
- Do not expose the LCD screen surface to the sun. Doing so may damage the screen surface.
- Do not push or scratch the front filter, or place objects on top of the TV. The image may be uneven or the LCD panel may be damaged.
- If the TV is used in a cold place, a smear may occur in the picture or the picture may become dark. This does not indicate a failure. These phenomena improve as the temperature rises.
- Ghosting may occur when still pictures are displayed continuously. It may disappear after a few moments.
- The screen and cabinet get warm when the TV is in use. This is not a malfunction.

Fluorescent lamp

This TV uses a special fluorescent lamp as its light source. If the screen image becomes dark, flickers, or does not appear, the fluorescent lamp has run down and should be replaced. For replacement, consult qualified service personnel.

Cooling fan

This TV uses a cooling fan to avoid overheating. Note that the noise of the cooling fan may be heard from the TV, depending on where the TV is installed.

Contents

Contents

Introducing the TV

Setting Up the TV

Welcome.....	13
Package Contents.....	13
Features.....	13
Overview.....	15
TV Controls and Connectors.....	16
Display unit.....	16
Media receiver unit Front Panel.....	17
Media receiver unit Rear Panel.....	18
Installing the TV.....	20
Basic Connections: Connecting a Cable or Antenna.....	22
Cable or Antenna Only.....	23
Cable and Antenna Only.....	24
Cable Box and Cable Only.....	25
Cable Box Only.....	27
Connecting Optional Equipment.....	29
About Using S VIDEO.....	29
VCR and Cable.....	30
VCR and Cable Box.....	32
Two VCRs for Tape Editing.....	34
Satellite Receiver.....	36
Satellite Receiver and VCR.....	38
DVD Player with Component Video Connectors.....	40
DVD Player with S VIDEO and Audio Connectors.....	42
Digital TV Set-Top Box with Component Video Connectors.....	43
Digital Satellite Receiver with DVI-HDTV connector.....	44
Camcorder.....	45
Audio Receiver.....	46
Sub Woofer.....	47
Using the CONTROL S Feature.....	48
Setting Up the Channel List.....	49
Using Auto Setup.....	49

Using the Remote Control

Overview	51
Inserting Batteries	51
Button Descriptions	52
Programming the Remote Control	54
Using Other Equipment with Your TV Remote Control	56
All Equipment	56
Operating a VCR	56
Operating a Satellite Receiver	56
Operating a Cable Box	57
Operating a DVD Player	57
Operating an MDP (Laserdisc Player)	57

Using the Features

Overview	59
Watching TV	60
Using Wide Mode	61
Using Twin View	62
Displaying Twin Pictures	62
Activating the Picture	63
Changing the Picture Size	64
Using Favorite Channels	65
Creating a List of Favorite Channels	65
Displaying a List of Favorite Channels	65
Using the Freeze Function	66
Using Picture Off	67
Using the Memory Stick Picture Viewer	68
About Memory Stick	68
Supported Image Types	68
Unsupported Image Types	69
Inserting and Removing a Memory Stick	70
Displaying the Memory Stick Menu	72
Using the Memory Stick Index	73
Using the Memory Stick Slideshow	74
Changing the Memory Stick Setup Options	74
Using the Rotate Picture Screen	75

Using the Menus

Overview	77
Navigating Through Menus	77
Using the Video Menu	78
Selecting Video Options	78
Using the Audio Menu	80
Selecting Audio Options	80
Using the Screen Menu	82
Selecting Screen Mode Options	82
Using the Channel Menu	84
Selecting Channel Options	84
Using the Parent Menu	86
Selecting Parent Options	86
US Models: Selecting Custom Rating Options	87
Viewing Blocked Programs	87
Canadian Models: Selecting Custom Rating Options	88
Viewing Blocked Programs	88
Using the Setup Menu	89
Selecting Setup Options	89

Other Information

Overview	93
Glossary	94
Notes on Using Memory Stick Media	95
Memory Stick Precautions	95
Contacting Sony	96
Troubleshooting	96
Twin View	96
Remote Control	97
Memory Stick	97
Video	98
Audio	99
Channels	99
General	100
Specifications	101
Optional Accessories	103
Index	104

Introducing the TV

Welcome

Thank you for purchasing the Sony LCD Color TV. This manual is to be used with the following models:

- KLV30XBR900

Package Contents

The package contains the following:

- Display unit (LDM-3000)
- Media receiver unit (MBT-XBR900L)
- Remote control (RM-927Y) and two size AAA (LR03) batteries
- Two AC power cords
- Display interface cable
- Antenna cable
- Operating Instructions

These items are all you need to set up and operate the TV in its basic configuration.

Most components (VCRs, DVD players, etc.) come with the necessary cables to connect them. If you want to set up a complex system, you may need to buy extra cables, connectors, etc. Be sure to have these on hand before you start to connect your system.

Features

Some of the features that you will enjoy with your new TV include:

- WEGA Engine™**: Delivers superb picture quality from any video source by minimizing the signal deterioration caused by digital-to-analog conversion and stabilizing the signal processing. This engine features unique Sony technology, including:
 - **Composite Component Processor (CCP)**: The first step in the digital processing system which enhances input signal to noise ratio by chroma decoder digital processing.

(Continued)

- **DRC[®] (Digital Reality Creation) Multifunction V1:** Unlike conventional line doublers, the DRC Multifunction feature replaces the signal's NTSC waveform with the near-HD equivalent by digital mapping processing. The DRC Palette option lets you customize the level of detail (Reality) and smoothness (Clarity) to create up to three custom palettes.
- **Multi-Image Driver (MID[™] -XU):** (Twin View[™]) Allows you to watch two programs side by side. You can watch pictures from two different sources (1080i, 720p, 480p, and 480i) simultaneously. (Only the left Twin View window can display 1080i, 720p, and 480p sources.)
- **CineMotion[™]:** Provides an optimized display by automatically detecting film content and applying a reverse 3/2 pulldown process. Moving pictures will appear clearer and more natural-looking.
- **Newly developed LCD panel driver IC:** Developed to improve screen response time, using proprietary digital technology by Sony. By improving the response time in the middle luminance range, 'afterimage' in motion pictures is significantly reduced, resulting in smoother movement of images on the screen.
- Wide Screen Mode:** Watch conventional 4:3 aspect ratio broadcasts in wide screen mode.
- Favorite Channels:** Allows you to preview and select from eight of your favorite channels.
- Steady Sound[®]:** Equalizes volume levels so there is consistent output between programs and commercials.
- Memory Stick[®] Picture Viewer:** Allows you to view on your TV screen digital images that are stored on Memory Stick media.
- Component Video Inputs:** Offers the best video quality for DVD (480p, 480i), and digital set-top box (HD1080i, 720p) connections.
- HD Detailer[™]:** Wideband video amplifier has a high bandwidth frequency rating, which allows it to send more video information to the screen, resulting in finer picture quality, especially for HD sources.
- Parental Control:** V-Chip technology allows parents to block unsuitable programming from younger viewers.
- Digital Visual Interface (DVI-HDTV):** Can accommodate a copy-protected digital connection (HDCP^{*}) to other devices (such as digital set-top boxes) that have compatible interfaces. The DVI-HDTV input terminal is compliant with the EIA-861 standard and is not intended for use with personal computers.

* High-bandwidth Digital Content Protection

Setting Up the TV

Overview

This chapter includes illustrated instructions for setting up your TV.

<i>Topic</i>	<i>Page(s)</i>
TV Controls and Connectors	16-18
Installing the TV	20
Basic Connections: Connecting a Cable or Antenna	22-27
Connecting Optional Equipment	
VCR and Cable	30
VCR and Cable Box	32
Two VCRs for Tape Editing	34
Satellite Receiver	36
Satellite Receiver and VCR	38
DVD Player with Component Video Connectors	40
DVD Player with S VIDEO and Audio Connectors	42
Digital TV Set-Top Box with Component Video Connectors	43
Digital Satellite Receiver with DVI-HDTV connector	44
Camcorder	45
Audio Receiver	46
Sub woofer	47
Using the CONTROL S Feature	48
Setting Up the Channel List	49

Display unit

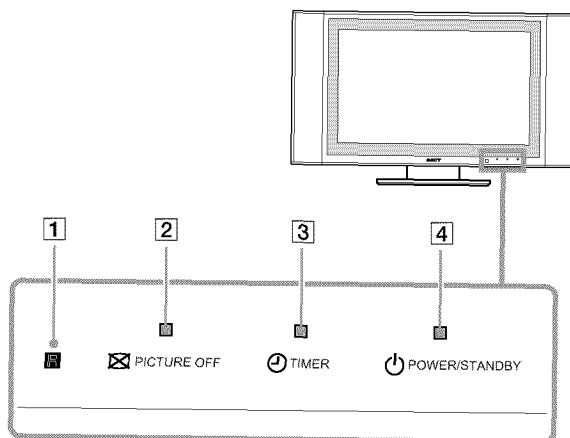

Item	Description
1	Infrared Receiver (IR) Receives IR signals from the TV's remote control.
2	☒ PICTURE OFF LED When lit, indicates that the Picture Off feature is activated. For details, see page 67.
3	🕒 TIMER LED When lit, indicates one of the timers is set. When the timer is set, this LED will remain lit even if the TV set is turned off. For details, see page 89.
4	🔌 POWER ON/STANDBY LED Lights up in green when the TV set is turned on. When in standby mode, the LED lights up in red. The LED does not light up when the main power is turned off. If the LED blinks continuously, this may indicate the display unit needs servicing (see "Contacting Sony" on page 96).

Media receiver unit Front Panel

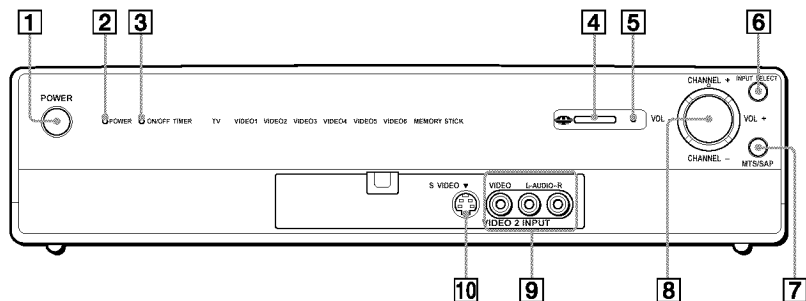

Item	Description
1	Main POWER Press to turn on and off the main power of the TV Set.
2	POWER LED Lights up in green when the TV set is turned on. The LED lights up in red when in standby mode. The LED does not light up when the main power is turned off. If the LED blinks continuously, this may indicate the Media receiver unit needs servicing (see “Contacting Sony” on page 96).
3	ON/OFF TIMER LED When lit, indicates one of the timers is set. When the timer is set, this LED will remain lit even if the TV set is turned off. For details, see page 89.
4	MEMORY STICK Memory Stick insertion slot. For details, see “Inserting and Removing a Memory Stick” on page 70.
5	MEMORY STICK ACCESS LED When lit, indicates that the Memory Stick is being read. (Do not remove the Memory Stick when the indicator is lit.)
6	INPUT SELECT Press repeatedly to cycle through the video equipment connected to the Media receiver unit’s video inputs.
7	MTS/SAP Press repeatedly to cycle through the Multi-channel TV Sound (MTS) options: Stereo, Auto SAP, and Mono. For details on each option, see page 80.
8	- CHANNEL + Press to scan through channels. To scan quickly through channels, press and hold down either CHANNEL - or CHANNEL +. - VOLUME + Press to adjust the volume.
9	VIDEO/ L-AUDIO-R (VIDEO 2 INPUT) Connects to the composite A/V output jacks on your camcorder or other video equipment.
10	S VIDEO (VIDEO 2 INPUT) Connects to the S VIDEO OUT jack on your camcorder or other video equipment that has S VIDEO. Provides better picture quality than composite video ([9]).

Media receiver unit Rear Panel

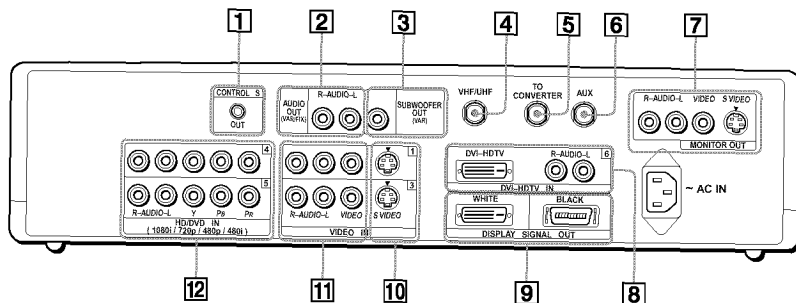

Jack	Description
1 CONTROL S OUT	Allows the TV to send remote control signals to other Sony infrared-controlled audio or video equipment that has the CONTROL S function.
2 AUDIO OUT (VAR/FIX) R-AUDIO-L	Connects to the left and right audio input jacks of your audio or video equipment. You can use these outputs to listen to your TV's audio through your stereo system.
3 SUB WOOFER OUT (VAR)	Connects to the input jack of your sub woofer.
4 VHF/UHF	Primary RF input that connects to your VHF/UHF antenna or cable.
5 TO CONVERTER	Connects to your cable box input jack. This VHF/UHF output jack lets you set up your TV to switch between scrambled channels (coming through a cable box) and unscrambled cable channels. Use this jack instead of a splitter to get better picture quality when you need to switch between scrambled and unscrambled cable channels. For details, see pages 24 and 25.
6 AUX	Auxiliary RF input that connects to your antenna, CATV cable, or cable box output jack. This is convenient if you are using two VHF/UHF sources (antenna, CATV cable, or cable box). For details, see pages 24 and 25.
7 MONITOR OUT S VIDEO/VIDEO/ R-AUDIO-L	Lets you record the program you are watching to a VCR. When two VCRs are connected, you can use the TV as a monitor for tape-to-tape editing (not available with 480p, 720p, or 1080i when the input is set to VIDEO 4-6).
8 DVI-HDTV IN DVI-HDTV/ R-AUDIO-L (VIDEO IN 6)	Can accommodate a copy-protected digital connection (HDCP*) to other devices (such as digital set-top boxes) that have compatible interfaces. The DVI-HDTV input terminal is compliant with the EIA-861 standard and is not intended for use with personal computers. See the instruction manual that came with your equipment for details about connecting and using it with the TV. Use a DVI-D single link cable.
9 DISPLAY SIGNAL OUT	Connects to the display input jack of the display unit by using the supplied display interface cable.
10 S VIDEO (VIDEO IN 1/3)	Connects to the S VIDEO OUT jack of your VCR or other video equipment that has S VIDEO. S VIDEO provides better picture quality than either composite video (11) or VHF/UHF (4) connections.
11 VIDEO/R-AUDIO-L (VIDEO IN 1/3)	Connect to the composite A/V output jacks on your VCR or other video component. A third component A/V input jack (VIDEO 2 INPUT) is located on the front panel of the Media receiver unit. These video connections provide better picture quality than the VHF/UHF (4) connections.

* High-bandwidth Digital Content Protection

Jack	Description
12 HD/DVD (1080i/720p/480p/ 480i) (VIDEO IN 4/5)	Connect to your DVD player's or digital set-top box's component video (Y, PB, PR) and audio (L/R) jacks. Component video provides better picture quality than 4, 10, or 11).



Installing the TV

- 1 Connect the display interface cable (supplied) to the display unit's DISPLAY SIGNAL IN jack, and connect the AC power cord (supplied) to the display unit's AC IN jack.

 **Disconnect all power sources before making any connections.**

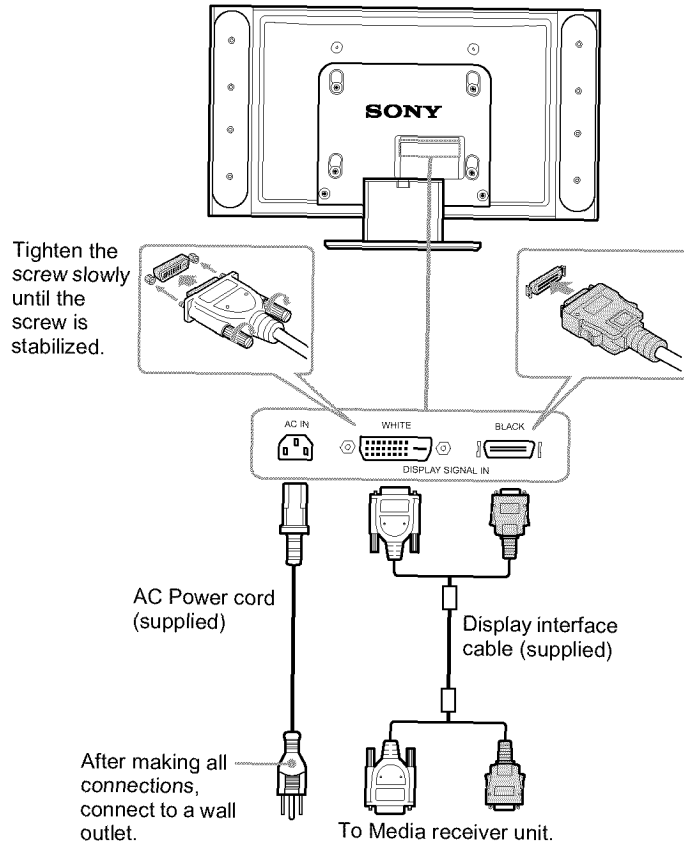

- 2 Install the display unit using an optional wall mount unit. For details, refer to the operating instructions supplied with your wall mount unit.

If not using wall mount unit, pass a wire through two holes to anchor it to the wall.

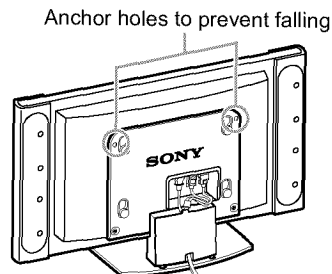

- 3 Connect the other end of display interface cable to the Media receiver unit's DISPLAY SIGNAL OUT jack, and connect the AC power cord (supplied) to the media receiver unit's AC IN jack.

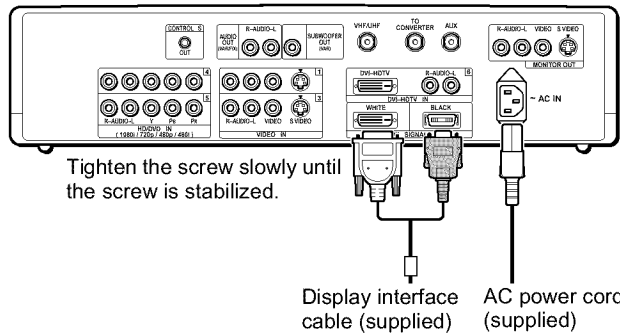

- 4 After making all connections, connect the AC power cords (supplied) to wall outlets.

 **Be sure to use the supplied AC power cords.**

When connecting optional components, do not connect the AC power cords to wall outlets until you have completed making all connections.

Do not tighten the screws too much. It may damage the screws.

Handle the display interface cable with care. If you pull the cable by catching your feet on the cable, this unit may fall and cause injury.

Do not use damaged cables, such as cables whose connectors are deformed.

Basic Connections: Connecting a Cable or Antenna

The way in which you will connect your TV varies, depending on how your home receives a signal (cable, cable box, antenna) and whether or not you plan to connect a VCR.

If You Are Connecting	See Page
Cable or Antenna Only	23
<input type="checkbox"/> No cable box or VCR	
Cable and Antenna Only	24
<input type="checkbox"/> No cable box or VCR	
Cable Box and Cable Only	25
<input type="checkbox"/> Cable box unscrambles only some channels (usually premium channels)	
<input type="checkbox"/> No VCR	
Cable Box Only	27
<input type="checkbox"/> Cable box unscrambles all channels	
<input type="checkbox"/> No VCR	
If you are connecting a VCR	30 and 32

Cable or Antenna Only

For best results, use one of the following connections if you are connecting a cable or an antenna and you:

- Do not need a cable box to unscramble channels. (If you have a cable box, see page 27.)
- Do not intend to connect a VCR. (If you have a VCR, see pages 30 and 32.)

For antenna connection, use the supplied antenna cable.

75-ohm coaxial cable (usually found in newer homes)

Cable Type	Connect As Shown
VHF Only or combined VHF/UHF or Cable	Antenna cable (supplied)  VHF/UHF



-  **When using an indoor antenna, such as rabbit-ear or dipole-antenna, keep the antenna away from the display unit. If not, noise may appear on the screen.**

Cable and Antenna Only

For best results, use this connection if you:

- Have a cable and an antenna.
(This is convenient if you are using a separate rooftop antenna to receive additional channels that are not provided by your cable company.)
- Do not have a cable box or VCR. (If you have a cable box, see pages 25 to 27. If you have a VCR, see pages 30 and 32.)

For antenna connection, use the supplied antenna cable.

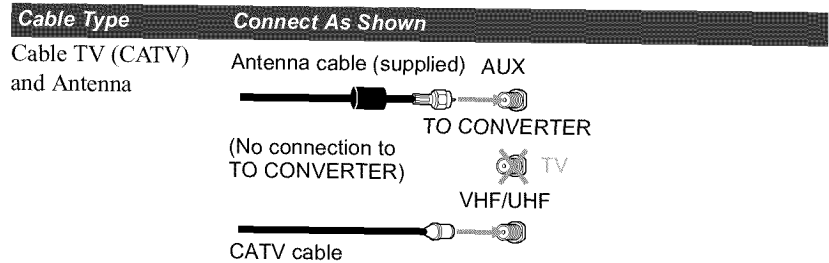

About Using This Connection with Dual Picture (Twin View, etc.) Features

With this connection, you cannot view antenna channels in the right dual picture window.

- When using an indoor antenna, such as rabbit-ear or dipole-antenna, keep the antenna away from the display unit. If not, noise may appear on the screen.**

Notes on Using This Connection

To Do This ...	Do This ...
Switch the TV's input between the cable and antenna	Press ANT to switch back and forth between the TV's VHF/UHF and AUX inputs.
Receive channels using an antenna, instead of the cable	<ol style="list-style-type: none"> 1 Press ANT to switch to the AUX input. 2 Set the Cable option to Off. For details, see "Selecting Channel Options" on page 84. 3 Run the Auto Setup program, as described in "Using Auto Setup" on page 49.

Cable Box and Cable Only

For best results, use this connection if:

- Your cable company scrambles some channels, such as premium channels (which requires you to use a cable box), but does not scramble all channels.
- You do not have a VCR. (If you have a VCR, see pages 30 and 32.)

With this connection you can:

- Use the TV remote control to change channels coming through the cable box to the TV's AUX input jack. (You must first program the remote control for your specific cable box; see "Programming the Remote Control" on page 54.)
- Use the TV remote control to change channels coming directly into the TV's VHF/UHF input. (The TV's tuner provides a better signal than the cable box.)

About Using This Connection with Dual Picture (Twin View, etc.) Features

With this connection, you can use all the dual picture features for unscrambled channels coming directly into the TV's VHF/UHF input jack.

However, you can use only some of the dual picture features for channels coming through the cable box to the TV's AUX input jack. For example, when you switch the TV's input to AUX — to select the cable box input — the picture displays only in the left window. For example, if you turn on Twin View, you can watch cable channels coming into the VHF/UHF jack in the right window, but you cannot swap the pictures between the left and right windows.

(Continued)

To connect the cable box and cable

- 1 Connect your cable company to the TV's VHF/UHF jack using the supplied antenna cable.
- 2 Use a coaxial cable to connect the TV's TO CONVERTER jack to the cable box's input jack. (The TV's internal converter lets you switch between unscrambled signals coming straight into the TV and scrambled signals coming in through the cable box, eliminating the need for an external splitter.)
- 3 Use a coaxial cable to connect the cable box's output jack to the TV's AUX jack.
- 4 Run the Auto Setup program, as described in "Setting Up the Channel List" on page 49.

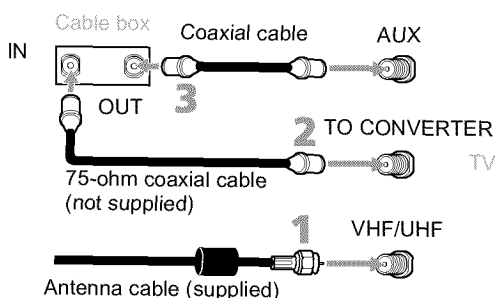

Notes on Using This Connection

To Do This ...	Do This ...
Use the cable box	Tune the TV to the channel the cable box is set to (usually channel 3 or 4) and then use the cable box to switch channels.
Set up the TV remote control to operate the cable box	Program the remote control. See "Programming the Remote Control" on page 54.
Activate the remote control to operate the cable box	Press SAT/CABLE FUNCTION repeatedly until the SAT/CABLE indicator lights up.
Prevent the accidental switching of TV channels	When using the cable box, you need the TV to stay on the channel the cable box is set to (usually channel 3 or 4). You can use the TV's Channel Fix feature to lock in a specific channel. For details, see "Using the Channel Menu" on page 84.
Switch the TV's input between the cable box and cable	Press ANT to switch back and forth between the TV's VHF/UHF (unscrambled channels) and AUX (scrambled) inputs.

Cable Box Only

For best results, use this connection if:

- Your cable company scrambles all channels, which requires you to use a cable box.
- You do not have a VCR. (If you have a VCR, see pages 30 and 32.)

With this connection you can:

- Use the TV remote control to change channels coming through the cable box to the TV's VHF/UHF jack. (You must first program the remote control for your specific cable box.)

About Using This Connection with Dual Picture (Twin View, etc.) Features

With this connection, all channels come into the TV through your cable box and only one unscrambled signal is sent to the TV, so you cannot use the dual picture features.

(Continued)

To connect the cable box

- 1 Connect the CATV cable to the cable box's input jack.
- 2 Use the supplied antenna cable to connect the cable box's output jack to the TV's VHF/UHF jack.
- 3 Run the Auto Setup program, as described in "Setting Up the Channel List" on page 49.

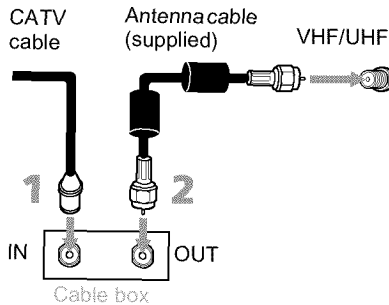

Notes on Using This Connection

To Do This ...	Do This ...
Use the cable box	Tune the TV to the channel the cable box is set to (usually channel 3 or 4) and then use the cable box to switch channels.
Set up the TV remote control to operate the cable box	Program the remote control. See "Programming the Remote Control" on page 54.
Activate the remote control to operate the cable box	Press FUNCTION repeatedly until the SAT/CABLE indicator lights up.
Prevent the accidental switching of TV channels	When using the cable box, you need the TV to stay on the channel the cable box is set to (usually channel 3 or 4). You can use the TV's Channel Fix feature to lock in a specific channel. For details, see "Using the Channel Menu" on page 84.

Connecting Optional Equipment

Use the directions in this section to connect the following optional equipment:

<i>If You Are Connecting</i>	<i>See Page</i>
VCR and Cable	30
VCR and Cable Box	32
Two VCRs for Tape Editing	34
Satellite Receiver	36
Satellite Receiver and VCR	38
DVD Player with Component Video Connectors	40
DVD Player with S VIDEO and Audio Connectors	42
Digital TV Set-Top Box with Component Video Connectors	43
Digital Satellite Receiver with DVI-HDTV connector	44
Camcorder	45
Audio Receiver	46
Sub Woofer	47

About Using S VIDEO



If the optional equipment you are connecting has an S VIDEO jack (shown at left), you can use an S VIDEO cable for improved picture quality (compared to an A/V cable). Because S VIDEO carries only the video signal, you also need to connect audio cables for sound, as shown below.

Example of an S VIDEO Connection

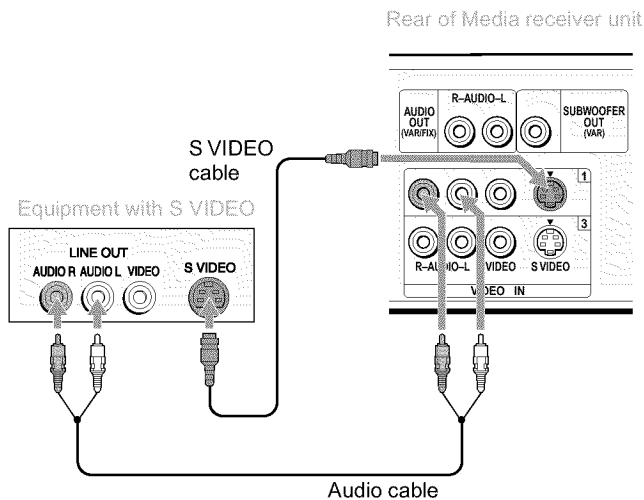

VCR and Cable

For best results, use this connection if:

- Your cable company does not require you to use a cable box.

About Using This Connection with Dual Picture (Twin View, etc.) Features

With this connection, you can use all the dual picture features.

To connect the VCR and cable

- 1 Connect the CATV cable to the VCR's VHF/UHF input jack.
- 2 Use the supplied antenna cable to connect the VCR's VHF/UHF output jack to the TV's VHF/UHF jack.
- 3 Use an A/V cable to connect the VCR's A/V output jacks to the TV's A/V input jacks.
- 4 Run the Auto Setup program, as described in "Setting Up the Channel List" on page 49.

 **Using S VIDEO jacks? See page 29.**

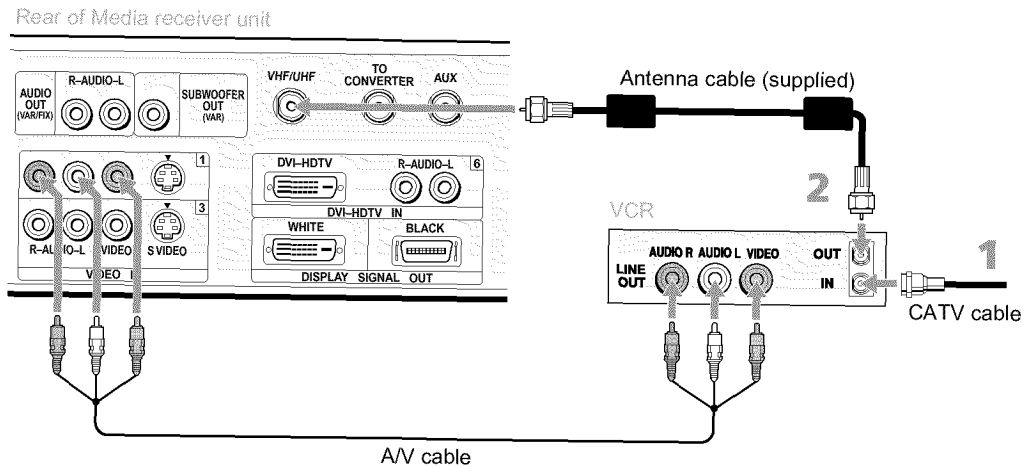

Notes on Using This Connection

To Do This ...	Do This ...
Watch the VCR	Press TV/VIDEO repeatedly to select the VCR input (VIDEO 1 in the illustration).
Watch cable channels	Press TV/VIDEO repeatedly to select the cable input (VHF/UHF in the illustration).
Set up the TV remote control to operate the VCR	If you have a non-Sony VCR, you must program the remote control. See “Programming the Remote Control” on page 54.
Activate the TV remote control to operate the VCR	Press FUNCTION repeatedly until the DVD/VCR indicator lights up.
Control VCR functions with the TV remote control	See “Operating a VCR” on page 56.
Label video inputs to easily identify equipment connected to the TV	See the instructions for setting up Video Labels on page 90.



VCR and Cable Box

For best results, use this connection if:

- Your cable company scrambles some channels, such as premium channels (which requires you to use a cable box), but does not scramble all channels.

About Using This Connection with Dual Picture (Twin View, etc.) Features

With this connection, you can use all the dual picture features.

With this connection you can:

- Use the TV remote control to change channels coming through the cable box. (You must first program the remote control for your specific cable box; see “Programming the Remote Control” on page 54.)
- Use the TV remote control to change channels coming directly into the TV’s VHF/UHF jack. (The TV’s tuner provides a better signal than the cable box.)
- Record channels coming through the cable box and channels coming directly into the TV.

To connect a VCR and cable box, you need:

- A splitter, which is a small, inexpensive device that you can purchase at your local electronics store.
- Three coaxial cables.
- One A/V cable or one S VIDEO cable with audio cables.

To connect the VCR and cable box

- 1 Connect the CATV cable to the single (input) jack of the splitter.
- 2 Use the supplied antenna cable to connect one of the splitter’s two output jacks to the TV’s VHF/UHF jack.
- 3 Use a coaxial cable to connect the splitter’s other output jack to the cable box’s input jack.
- 4 Use a coaxial cable to connect the cable box’s output jack to the VCR’s RF input jack.
- 5 Use an A/V cable to connect the VCR’s A/V output jacks to the TV’s A/V input jacks.
- 6 Run the Auto Setup program, as described in “Setting Up the Channel List” on page 49.

 **Using S VIDEO jacks? See page 29.**

Rear of Media receiver unit

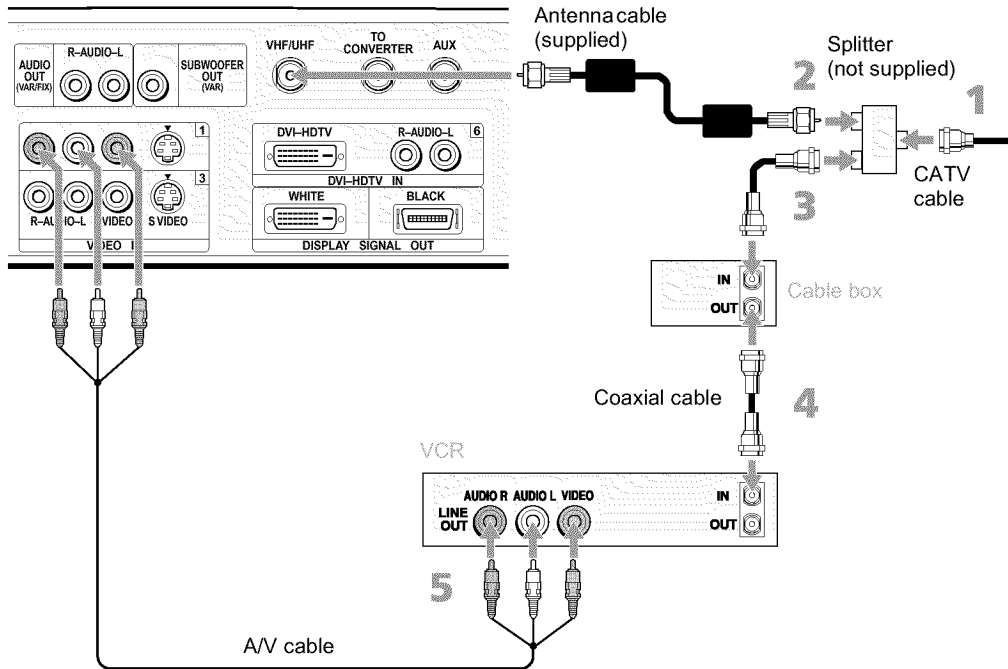

Notes on Using This Connection

To Do This ...	Do This ...
Watch cable (unscrambled) channels	Press TV/VIDEO repeatedly to select the cable input (UHF/VHF in the illustration).
Watch cable box (scrambled) channels	Turn on the VCR and tune it to the channel the cable box is set to (usually channel 3 or 4). Press TV/VIDEO repeatedly to select the VCR input (VIDEO 1 in the illustration). Use the cable box to change channels.
Watch the VCR	Press TV/VIDEO repeatedly to select the VCR input (VIDEO 1 in the illustration).
Set up the TV remote control to operate the cable box or VCR	If you have a non-Sony VCR, you must program the remote control. See “Programming the Remote Control” on page 54.
Activate the remote control to operate the cable box or VCR	For the cable box, press FUNCTION repeatedly until the SAT/CABLE indicator lights up. For the VCR, press FUNCTION repeatedly until the DVD/VCR indicator lights up.
Control specific cable box and VCR functions with the TV remote control	See “Operating a Cable Box” on page 57 and “Operating a VCR” on page 56.
Label video inputs to easily identify equipment connected to the TV	See the instructions for setting up Video Labels on page 90.

Two VCRs for Tape Editing

Connecting two VCRs lets you record from one VCR to the other. By connecting them as shown below, you can view (monitor) what is being recorded.

To connect two VCRs for tape editing

- 1 Use an A/V cable to connect the playback VCR's A/V output jacks to the TV's A/V input jacks.
- 2 Use an A/V cable to connect the recording VCR's A/V input jacks to the TV's MONITOR OUT jacks.

 **Using S VIDEO jacks? See page 29.**

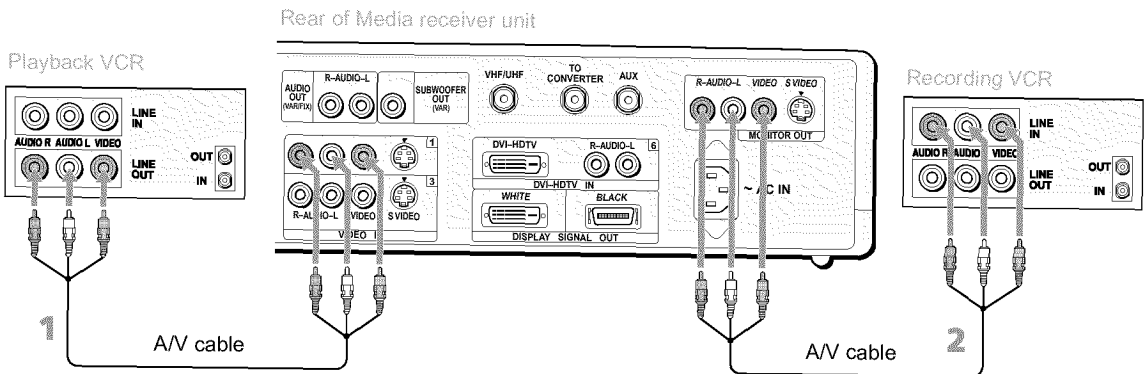

-  **When connecting two VCRs for tape editing;**
- you cannot edit a tape with copy protection.
 - do not connect the TV's A/V input jack and output jack to your VCRs at the same time to avoid looping the signal.

Notes on Using This Connection

To Do This ...	Do This ...
View (monitor) what is being recorded	Press TV/VIDEO repeatedly to select the VCR input (VIDEO 1 in the illustration above).
Set up the TV remote control to operate the VCR(s)	If you have a non-Sony VCR, you must program the remote control. See “Programming the Remote Control” on page 54.
Activate the TV remote control to operate the VCR(s)	Press FUNCTION repeatedly until the DVD/VCR indicator lights up.
Control VCR functions with the TV remote control	See “Operating a VCR” on page 56.
Label video inputs to easily identify equipment connected to the TV	See the instructions for setting up Video Labels on page 90.



Satellite Receiver

To connect a satellite receiver

- 1 Connect the satellite antenna cable to the satellite receiver's satellite input jack.
- 2 Use an A/V cable to connect the satellite receiver's A/V output jacks to the TV's A/V input jacks.
- 3 Connect the supplied antenna cable from your cable or antenna to the TV's VHF/UHF jack.
- 4 Run the Auto Setup program, as described in "Setting Up the Channel List" on page 49.

 Using S VIDEO jacks? See page 29.

Rear of Media receiver unit

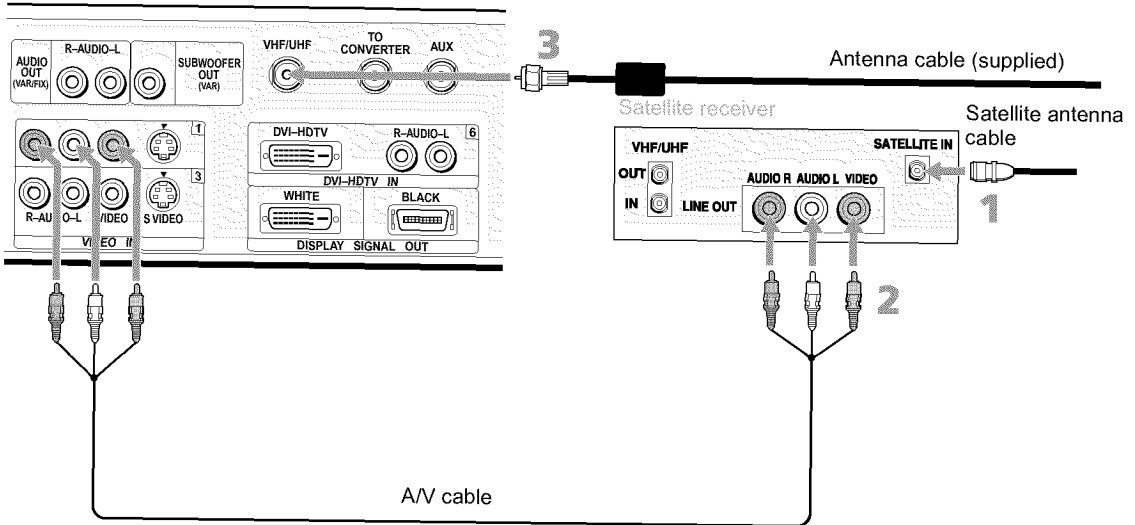

Notes on Using This Connection

<i>To Do This ...</i>	<i>Do This ...</i>
Watch the satellite receiver	Press TV/VIDEO repeatedly to select the satellite receiver input (VIDEO 1 in the illustration).
Set up the TV remote control to operate the satellite receiver	If you have a non-Sony satellite receiver, you must program the remote control. See “Programming the Remote Control” on page 54.
Activate the TV remote control to operate the satellite receiver	Press FUNCTION repeatedly until the SAT/CABLE indicator lights up.
Control satellite receiver functions with the TV remote control	See “Operating a Satellite Receiver” on page 56.
Label video inputs to easily identify equipment connected to the TV	See the instructions for setting up Video Labels on page 90.

Satellite Receiver and VCR

To connect a satellite receiver and VCR

- 1 Connect the satellite antenna cable to the satellite receiver's satellite input jack.
- 2 Connect the CATV cable to the VCR's VHF/UHF input jack.
- 3 Use the supplied antenna cable to connect the VCR's VHF/UHF output jack to the TV's VHF/UHF input jack.
- 4 Use an A/V cable to connect the satellite receiver's A/V output jacks to the VCR's A/V input jacks.
- 5 Use an A/V cable to connect the VCR's A/V output jacks to the TV's A/V input jacks.
- 6 Run the Auto Setup program, as described in "Setting Up the Channel List" on page 49.

 Using S VIDEO jacks? See page 29.

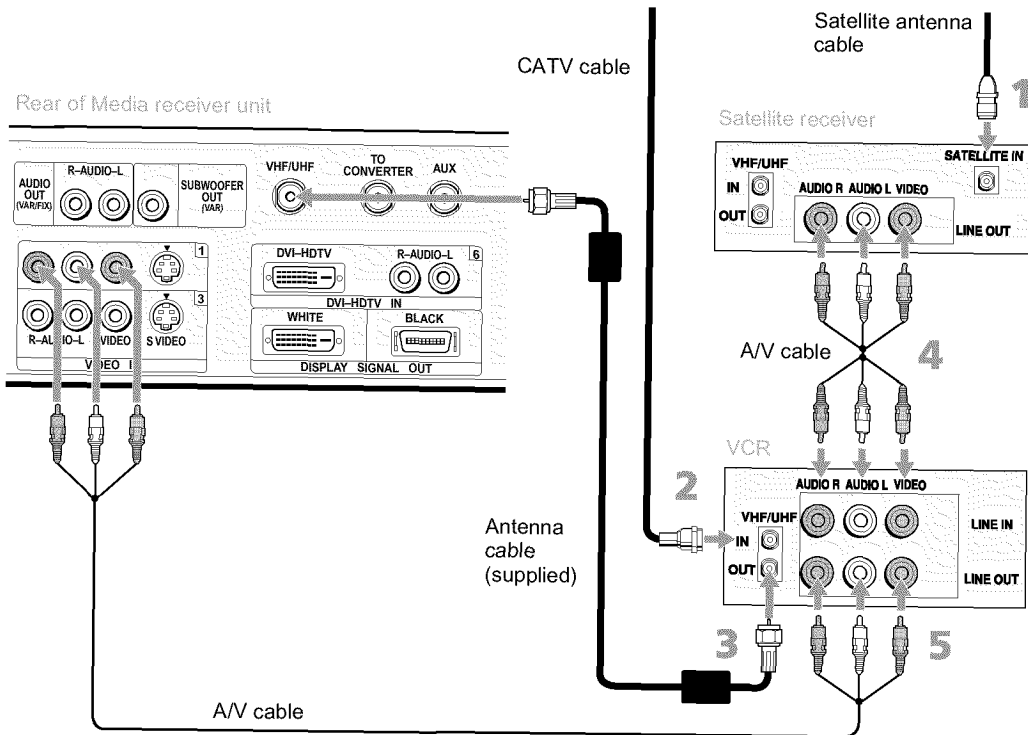

Notes on Using This Connection

To Do This ...	Do This ...
Watch the satellite receiver	Press TV/VIDEO repeatedly to select the VCR input (VIDEO 1 in the illustration). The VCR may need to be turned on and set to the satellite receiver input.
Watch the VCR	Press TV/VIDEO repeatedly to select the input to which the VCR is connected (VIDEO 1 in the illustration).
Set up the TV remote control to operate the satellite receiver or VCR	If you have a non-Sony VCR or satellite receiver, you must program the remote control. See “Programming the Remote Control” on page 54.
Activate the TV remote control to operate the satellite receiver or VCR	For the satellite receiver, press FUNCTION repeatedly until the SAT/CABLE indicator lights up. For the VCR, press FUNCTION repeatedly until the DVD/VCR indicator lights up.
Control satellite receiver and VCR functions with the TV remote control	See “Operating a Satellite Receiver” on page 56 and “Operating a VCR” on page 56.
Label video inputs to easily identify equipment connected to the TV	See the instructions for setting up Video Labels on page 90.

DVD Player with Component Video Connectors

For best results, use this connection if your DVD player has component video (Y, Pb, Pr) jacks.

To connect a DVD player with component video connectors

- 1 Use three separate component video cables to connect the DVD player's Y, Pb and Pr jacks to the Y, Pb and Pr jacks (VIDEO 4) on the TV.
-  **The Y, Pb and Pr jacks on your DVD player are sometimes labeled Y, CB and CR, or Y, B-Y and R-Y. If so, connect the cables to their matching color jacks.**
- 2 Use an audio cable to connect the DVD player's audio output jacks to the TV's VIDEO 4 audio input jacks.

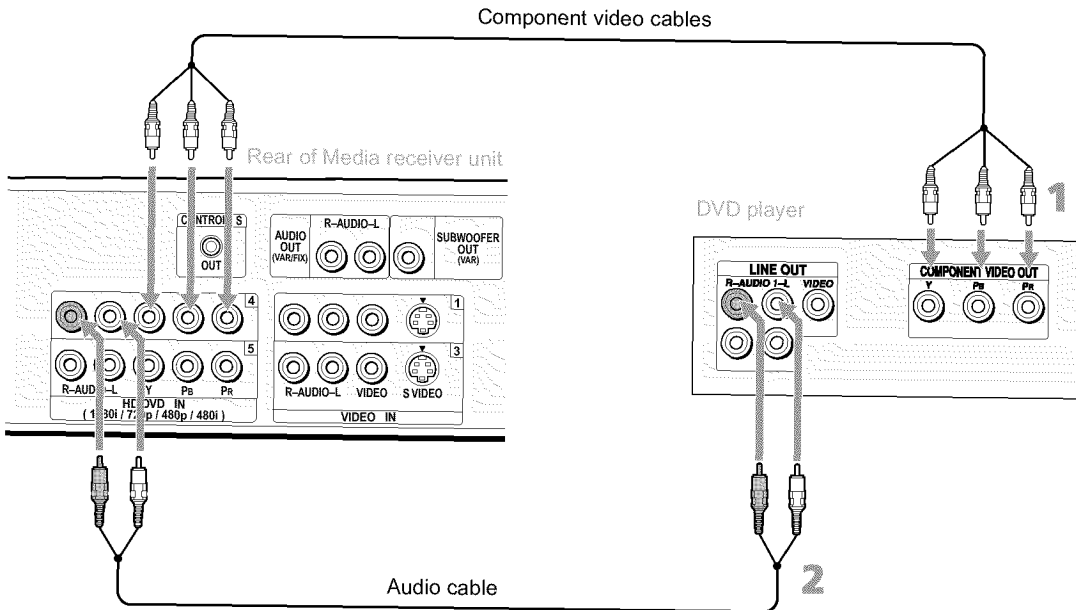

Notes on Using This Connection

To Do This ...	Do This ...
Watch the DVD player	Press TV/VIDEO repeatedly to select the DVD input (VIDEO 4 in the illustration).
Set up the TV remote control to operate the DVD player	If you have a non-Sony DVD player, you must program the remote control. See “Programming the Remote Control” on page 54.
Activate the TV remote control to operate the DVD player	Press FUNCTION repeatedly until the DVD/VCR indicator lights up.
Control DVD functions with the TV remote control	See “Operating a DVD Player” on page 57.
Label video inputs to easily identify equipment connected to the TV	See the instructions for setting up Video Labels on page 90.

 **You cannot record the signal from any equipment connected into the Y, PB, PR jacks.**

DVD Player with S VIDEO and Audio Connectors

Use this connection if your DVD player does not have component video (Y, PB, PR) jacks.

To connect a DVD player with A/V connectors

- 1 Use an audio cable to connect the DVD player's audio output jacks to the TV's audio input jacks.
- 2 Use an S VIDEO cable to connect the DVD player's S VIDEO jack to the TV's S VIDEO jack.

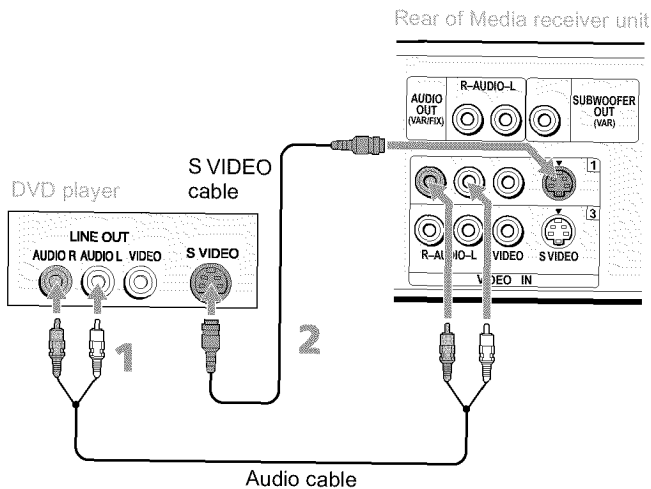

Notes on Using This Connection

To Do This ...	Do This ...
Watch the DVD player	Press TV/VIDEO repeatedly to select the DVD input (VIDEO 1 in the illustration).
Set up the TV remote control to operate the DVD player	If you have a non-Sony DVD player, you must program the remote control. See "Programming the Remote Control" on page 54.
Activate the TV remote control to operate the DVD player	Press FUNCTION repeatedly until the DVD/VCR indicator lights up.
Control DVD functions with the TV remote control	See "Operating a DVD Player" on page 57.
Label video inputs to easily identify equipment connected to the TV	See the instructions for setting up Video Labels on page 90.

Digital TV Set-Top Box with Component Video Connectors

To connect a digital TV set-top box with component video connectors

- 1 Use three separate component video cables to connect the set-top box's Y, PB and PR jacks to the Y, PB and PR jacks (VIDEO 4) on the TV.
 -  **The Y, PB and PR jacks on your set-top box are sometimes labeled Y, CB and CR, or Y, B-Y and R-Y. If so, connect the cables to their matching color jacks.**
- 2 Use an audio cable to connect the set-top box's audio output jacks to the TV's VIDEO 4 audio input jacks.

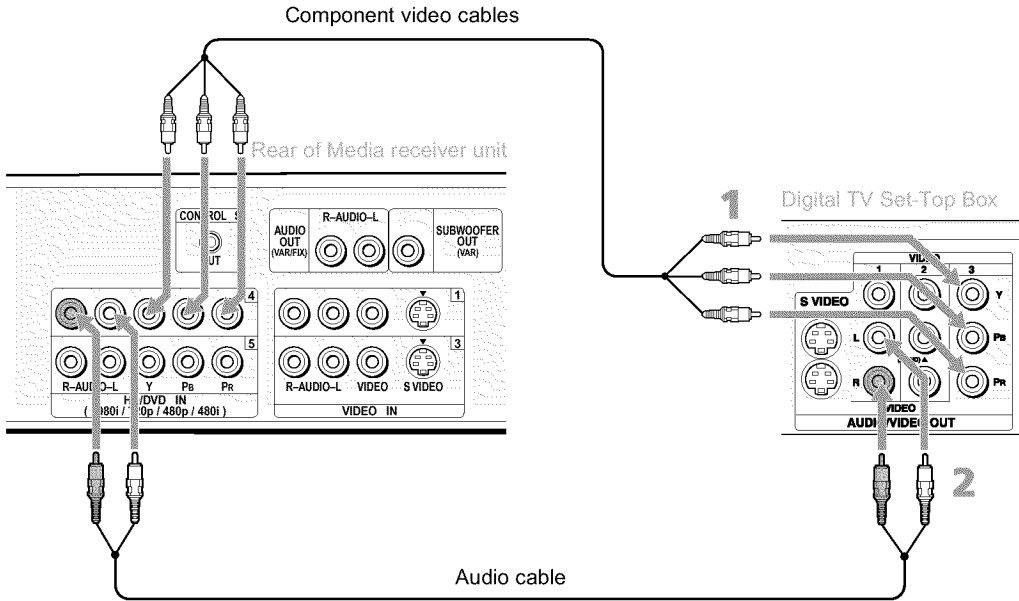

Notes on Using This Connection

To Do This ...	Do This ...
Watch the digital TV set-top box	Press TV/VIDEO repeatedly to select the digital TV set-top box input (VIDEO 4 in the illustration).
Label video inputs to easily identify equipment connected to the TV	See the instructions for setting up Video Labels on page 90.

 **You cannot record the signal from any equipment connected into the Y, PB, PR jacks.**

Digital Satellite Receiver with DVI-HDTV connector

To connect a digital Satellite Receiver with DVI-HDTV connector

- 1 Use a DVI-D single link cable to connect the Digital Satellite Receiver's DVI-HDTV connector to the TV's DVI-HDTV connector.
 -  **The DVI-HDTV VIDEO connector does not provide audio, so audio cables must be connected to provide sound.**
- 2 Use an audio cable to connect the Digital Satellite Receiver's audio output jacks to the TV's DVI-HDTV AUDIO jacks.

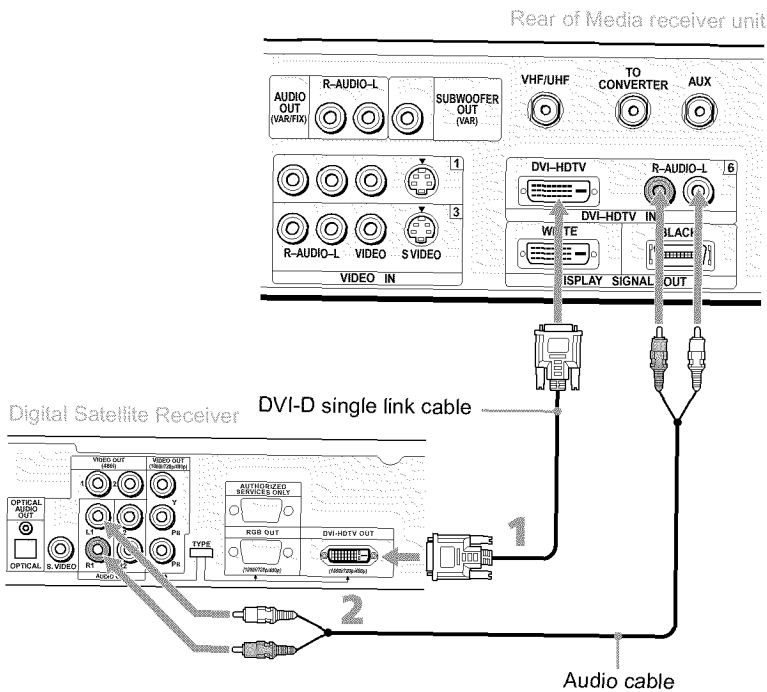

Notes on Using This Connection

To Do This ...

Watch the digital satellite receiver
Label video inputs to easily
identify equipment connected to
the TV

Do This ...

Press **TV/VIDEO** repeatedly to select the digital satellite receiver input (VIDEO 6 in the illustration).
See the instructions for setting up Video Labels on page 90.

Camcorder

For easy connection of a camcorder, the TV has front A/V input jacks. If you prefer, however, you can connect the camcorder to the TV's rear A/V input jacks.

To connect a camcorder

Use an A/V cable to connect the camcorder's A/V output jacks to the TV's A/V input jacks.

 **Using S VIDEO jacks? See page 29.**

Media receiver unit Front Video Panel

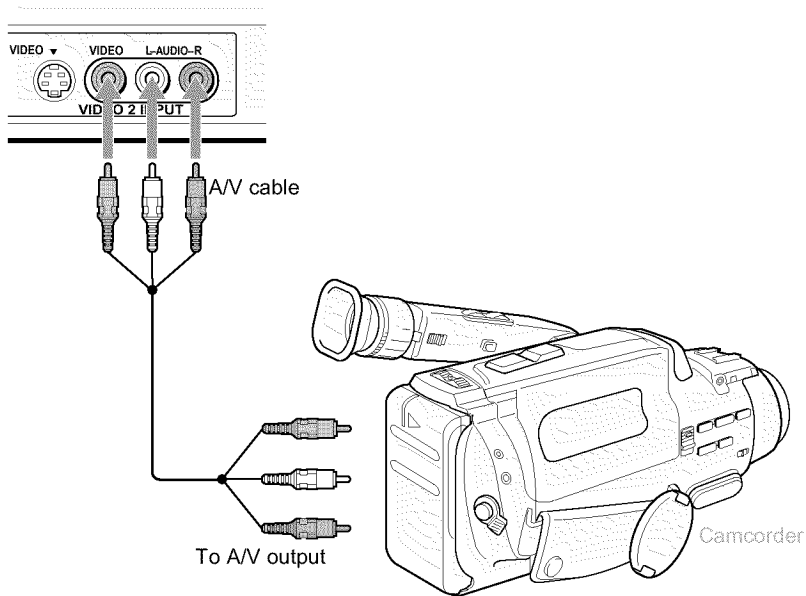

Notes on Using This Connection

To Do This ...	Do This ...
Watch the camcorder	Press TV/VIDEO repeatedly to select the camcorder input (VIDEO 2 INPUT in the illustration).
Label video inputs to easily identify equipment connected to the TV	See the instructions for setting up Video Labels on page 90.

Audio Receiver

For improved sound quality, you may want to play the TV's audio through your stereo system.

To connect an audio system

- 1 Use an audio cable to connect the TV's audio output jacks to the audio receiver's line input jacks.

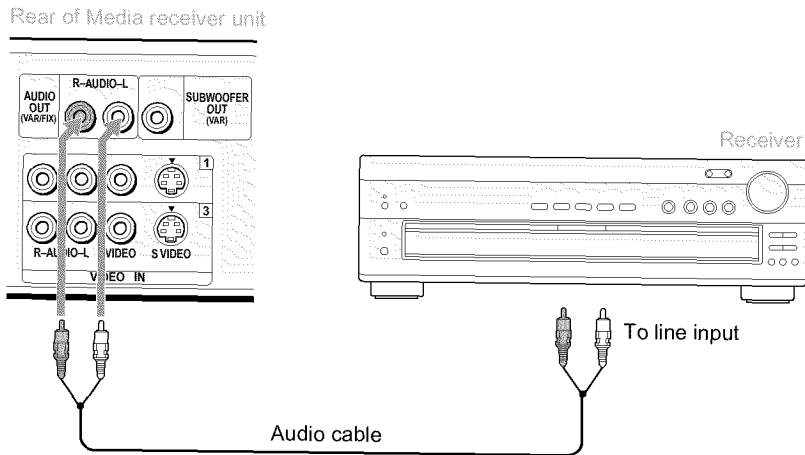

- 2 Using the TV's Audio Menu, set the **Speaker** option to **Off**. Then set the **Audio Out** option to **Fixed** or **Variable**, depending on how you want to control the volume. For details, see "Using the Audio Menu" on page 80.
- 3 Turn on the audio receiver, and then set the receiver's line input to the jack into which you connected the TV.

Sub Woofer

Use a monaural audio cable to connect the TV's SUB WOOFER OUT jack to the sub woofer's input jack.

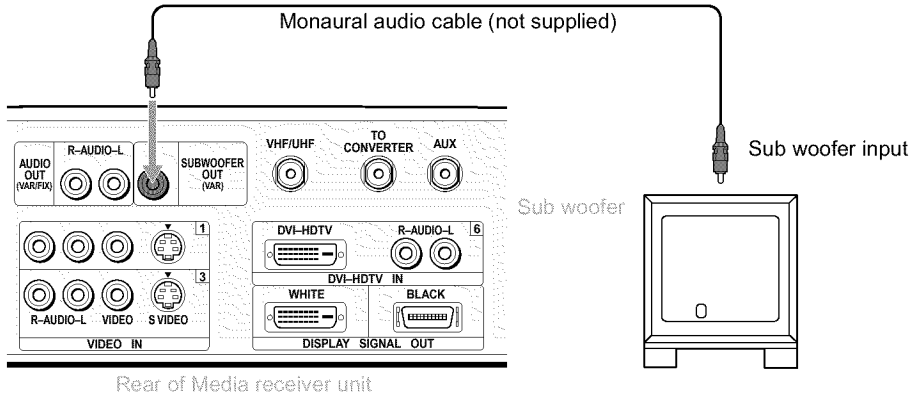

Using the CONTROL S Feature

CONTROL S allows you to control your system and other Sony equipment with one remote control. In addition to allowing you to control multiple devices with one remote control, the CONTROL S feature allows you to always point your remote control at your TV, instead of having to point it at the other equipment, which might be hidden or out of direct line of sight.

Use CONTROL S OUT to send signals to connected equipment.

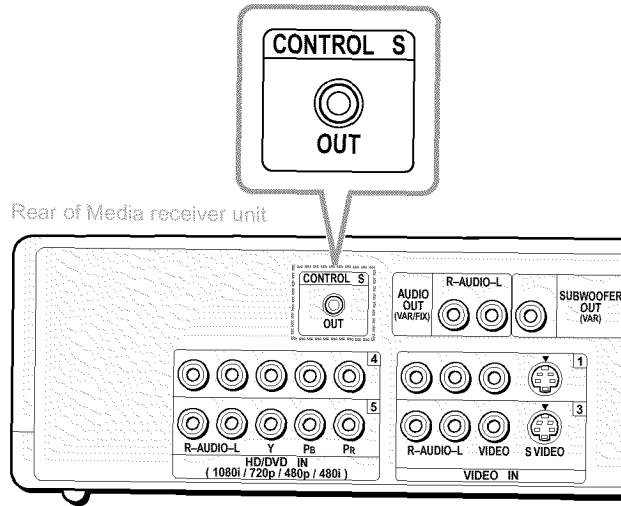

Setting Up the Channel List

After you finish connecting your TV, you need to run Auto Setup to set up your channels. The Auto Setup screen appears when you turn on your TV for the first time after hooking it up. If you do not want to set up the channels at this time, you can do it later by selecting the Auto Program option in the Channel Menu (see page 84).

 **The Auto Setup feature does not apply for installations that use a cable box for all channel selection.**

Using Auto Setup

- 1 Press **POWER** to turn on the TV.
- 2 Press **FUNCTION** on the remote control repeatedly until the **TV** indicator lights up.
- 3 To continue running Auto Setup, press **CH+**. To exit Auto Setup, press **CH-**.

Auto Setup automatically creates a list of receivable channels. When finished, the lowest numbered channel is displayed.



Using the Remote Control

Overview

This chapter describes how to set up, program, and use the TV's remote control.

Topic	Page
Inserting Batteries	51
Button Descriptions	52
Programming the Remote Control	54
Using Other Equipment with Your TV Remote Control	56

Inserting Batteries

- 1 Open the battery compartment as illustrated below.
- 2 Insert two size AAA (LR03) batteries (supplied) by matching the  and  terminals on the batteries to the diagram inside the battery compartment.
- 3 Close the battery compartment.

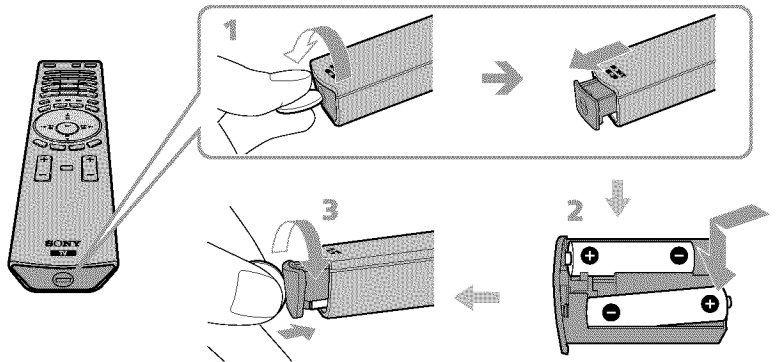

-  **Remove the batteries to avoid damage from possible battery leakage whenever you anticipate that the remote control will not be used for an extended period. Handle the remote control with care. Avoid dropping it, getting it wet, placing it in direct sunlight, near a heater, or where the humidity is high.**

Button Descriptions

Remote Control

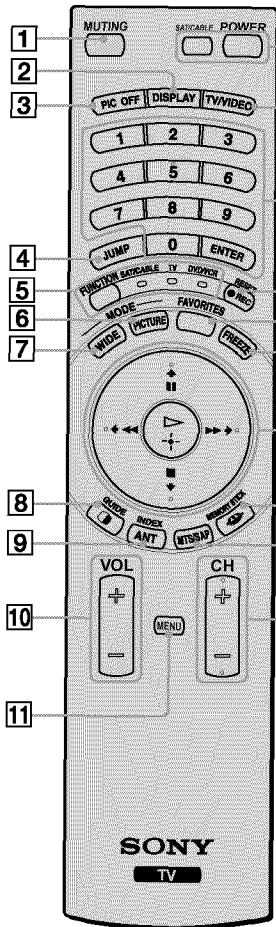









Button	Description
1 MUTING	Press to mute the sound. Press again or press VOL+ to restore the sound.
2 DISPLAY	Press once to display the current channel number, current time, and channel label. If set, the current channel number will display for 10 seconds.
3 PIC OFF	Press to have the TV screen turn off. For details, see page 67.
4 JUMP	Press to jump back and forth between two channels. The TV alternates between the current channel and the last channel that was selected.
5 FUNCTION button and indicators	Press to have the remote control operate the equipment you want. Press repeatedly until the indicator of the desired equipment lights up. For details, see "Programming the Remote Control" on page 54.
6 PICTURE	Press repeatedly to cycle through the available video picture modes: Vivid, Standard, Pro, Mild. Also available in the Video Menu. For details, see "Selecting Video Options" on page 78.
7 WIDE	Press repeatedly to step through the Wide Mode settings: Wide Zoom, Normal, Full, Zoom. Also available in the Screen menu. For details, see pages 61 and 82.
8  (Twin View)	Press to turn on and off Twin View. For details, see page 62.
GUIDE*	If FUNCTION is switched on SAT/CABLE Press to display the program guide of your satellite program provider.
9 ANT	Press to switch between the sources connected to the TV's VHF/UHF and AUX inputs.
INDEX*	If FUNCTION is switched on SAT/CABLE Press to display the index of your satellite program provider.
10 VOL +/-	Press to adjust the volume.
11 MENU	Press to display the Menu. Press again to exit from the Menu. For details, see page 77.
12 Power Buttons	SAT/CABLE*: Press to turn on and off the satellite receiver or cable box. POWER: Press to turn on and off the TV.
13 TV/VIDEO	Press repeatedly to cycle through the video equipment connected to the TV's video inputs.







* If not Sony brand, requires that you first program the remote control (page 54).

Button	Description
14 0 - 9 ENTER	Press 0 - 9 to select a channel; the channel changes after 3 seconds. Press ENTER to change channels immediately.
15 RESET	Press to reset the settings to the factory defaults. See pages 78 and 80. Also used to clear Favorite Channels (see page 65).

If FUNCTION is switched on DVD/VCR

 REC	Press together with  to record.
16 FAVORITES	Press to display the Favorite Channels list. For details, see page 65.
17 FREEZE	Press to freeze the picture. Press again to restore the picture. For details, see “Using the Freeze Function” on page 66.
18 	Press     to move the on-screen cursor. To select an item, press  .

If FUNCTION is switched on SAT/CABLE or DVD/VCR

Transport Buttons	 Rewind
	 Play
	 Stop
	 Fast forward
	 Pause
19 MEMORY STICK 	Press to display the Memory Stick Menu. For details, see “Using the Memory Stick Picture Viewer” on page 68.
20 MTS/SAP	Press repeatedly to cycle through the Multi-channel TV Sound (MTS) options: Stereo, Auto SAP, and Mono. For details on each option, see page 80.
21 CH +/-	Press to scan through channels. To scan quickly through channels, press and hold down either CH.

Programming the Remote Control

The remote control is preset to operate Sony brand video equipment.

Sony Equipment	Programmable Code Number
Beta, Ed Beta VCRs	303
8 mm VCR	302
VHS VCR	301
DVD player	751

If you have video equipment other than Sony brand that you want to control with the TV's remote control, use the following procedure to program the remote control.

 **The equipment must have infrared (IR) remote capability in order to be used with the remote control.**

- 1 Turn to the list of "Manufacturer's Codes" on page 55, and find the three-digit code number for the manufacturer of your equipment. (If more than one code number is listed, use the number listed first.)
- 2 Press **FUNCTION** repeatedly until the DVD/VCR or SAT/CABLE indicator lights up.
- 3 While the desired indicator is lit, enter the three-digit manufacturer's code number.
- 4 Press **ENTER**.

 **You must do step 4 within 10 seconds of step 3, or you must redo steps 3 through 4.**

- 5 To check if the code number works, aim the TV's remote control at the equipment and press **POWER** that corresponds with that equipment. If it responds, you are done. If not, try using another code listed for that manufacturer.

Notes

- If more than one code number is listed, try entering them one by one until you come to the correct code for your equipment.
- If you enter a new code number, the code number you previously entered at that setting is erased.
- In some cases, you may not be able to operate your equipment with the supplied remote control. In such cases, use the equipment's own remote control unit.
- Whenever you remove the batteries to replace them, the code numbers may revert to the factory setting and must be reset.

Manufacturer's Codes

VCRs

Manufacturer	Code
Sony	301, 302, 303
Admiral (M. Ward)	327
Aiwa	338, 344
Audio Dynamic	314, 337
Broksonic	319, 317
Canon	309, 308
Citizen	332
Craig	302, 332
Criterion	315
Curtis Mathes	304, 338, 309
Daewoo	341, 312, 309
DBX	314, 336, 337
Dimensia	304
Emerson	319, 320, 316, 317, 318, 341
Fisher	330, 335
Funai	338
General Electric	329, 304, 309
Go Video	322, 339, 340
Goldstar	332
Hitachi	306, 304, 305, 338
Instant Replay	309, 308
JC Penney	309, 305, 304, 330, 314, 336, 337
JVC	314, 336, 337, 345, 346, 347
Kenwood	314, 336, 332, 337
LG	332
LXI (Sears)	332, 305, 330, 335, 338
Magnavox	308, 309, 310
Marantz	314, 336, 337
Marta	332
Memorex	309, 335
Minolta	305, 304
Mitsubishi/ MGA	323, 324, 325, 326
Multitech	325, 338, 321
NEC	314, 336, 337

Manufacturer	Code
Olympic	309, 308
Optimus	327
Orion	317
Panasonic	308, 309, 306, 307
Pentax	305, 304
Philco	308, 309
Philips	308, 309, 310
Pioneer	308
Quasar	308, 309, 306
RCA/ PROSCAN	304, 305, 308, 309, 311, 312, 313, 310, 329
Realistic	309, 330, 328, 335, 324, 338
Sansui	314
Samsung	322, 313, 321
Sanyo	330, 335
Scott	312, 313, 321, 335, 323, 324, 325, 326
Sharp	327, 328
Signature 2000 (M. Ward)	338, 327
SV2000	338
Sylvania	308, 309, 338, 310
Symphonic	338
Tashiro	332
Tatung	314, 336, 337
Teac	314, 336, 338, 337
Technics	309, 308
Toshiba	312, 311
Wards	327, 328, 335, 331, 332
Yamaha	314, 330, 336, 337
Zenith	331

Laserdisc Players

Manufacturer	Code
Sony	701
Panasonic	704, 710
Pioneer	702

DVD Players

Manufacturer	Code
Sony	751
General Electric	755
Hitachi	758
JVC	756
Magnavox	757
Mitsubishi	761
Oritron	759
Panasonic	753
Philips	757
Pioneer	752
RCA/Proscan	755
Samsung	758
Toshiba	754
Zenith	760

Cable Boxes

Manufacturer	Code
Sony	230
Hamlin/Regal	222, 223, 224, 225, 226
Jerrold/G. I.	201, 202, 203, 204, 205, 206, 207, 208, 218
Oak	227, 228, 229
Panasonic	219, 220, 221
Pioneer	214, 215
Scientific Atlanta	209, 210, 211
Tocom	216, 217
Zenith	212, 213

Satellite Receivers

Manufacturer	Code
Sony	801
Dish Network	810
Echostar	810
General Electric	802
Hitachi	805
Hughes	804
Mitsubishi	809
Panasonic	803
RCA/ PROSCAN	802, 808
Toshiba	806, 807









Copyright © 2002
 by
 The McGraw-Hill Companies

Using Other Equipment with Your TV Remote Control



All Equipment

To Do This ...	Do This ...
Switch the TV's input to the VCR, DVD player, or other connected equipment	Press TV/VIDEO repeatedly to cycle through the video equipment connected to the TV's video inputs.
Set up the TV remote control to operate non-Sony equipment	You must program the remote control the first time you use it. See "Programming the Remote Control" on page 54.

Operating a VCR

To Do This ...	Press
Activate the remote control to operate the VCR	FUNCTION repeatedly until the DVD/VCR indicator lights up.
Change channels	CH +/-
Record	 and REC simultaneously
Play	
Stop	
Fast forward	
Rewind the tape	
Pause	
Search the picture forward or backward	 or  during playback (release to resume normal playback)











Operating a Satellite Receiver

To Do This ...	Press
Activate the remote control to operate the satellite receiver	FUNCTION repeatedly until the SAT/CABLE indicator lights up.
Turn on/off	SAT/CABLE
Select a channel	0-9, ENTER
Change channels	CH +/-
Back to previous channel	JUMP
Display channel number	DISPLAY
Display SAT Guide	GUIDE
Display SAT Menu	MENU
Move highlight (cursor)	
Select item	





Operating a Cable Box

To Do This ...	Press
Activate the remote control to operate the cable box	FUNCTION repeatedly until the SAT/CABLE indicator lights up.
Turn on/off	SAT/CABLE
Select a channel	0-9, ENTER
Change channels	CH +/-
Back to previous channel	JUMP

Operating a DVD Player

To Do This ...	Press
Activate the remote control to operate the DVD	FUNCTION repeatedly until the DVD/VCR indicator lights up.
Play	
Stop	
Pause	
Step through different tracks of the disc	 to step forward or  to step backward
Step through different chapters of a video disc	CH+ to step forward or CH- to step backward
Display the DVD player Menu (Setup)	MENU
Move highlight (cursor)	   
Select item	

Operating an MDP (Laserdisc Player)

To Do This ...	Press
Activate the remote control to operate the MDP	FUNCTION repeatedly until the indicator of the position you programmed for the MDP player lights up.
Play	
Stop	
Pause	
Search the picture forward or backward	 or  during playback (release to resume normal playback)
Search a chapter forward or backward	CH +/-

Using the Features

Overview

This chapter describes how to use the features of your TV.

<i>Topic</i>	<i>Page</i>
Watching TV	60
Using Wide Mode	61
Using Twin View	62
Using Favorite Channels	65
Using the Freeze Function	66
Using Picture Off	67
Using the Memory Stick Picture Viewer	68

Watching TV

💡 For a complete list of all the functions of the remote control, see page 52.

To Do This ...	Do This ...
Activate the remote control to operate the TV	Press FUNCTION repeatedly until the TV indicator lights up.
Turn on/off the TV	Press POWER
Tune directly to a channel	Press 0-9 and then ENTER (or wait 3 seconds) or Press CH+/-
Adjust the volume	Press VOL +/-
Mute the volume	Press MUTING (press again to unmute)
Alternate back and forth between two channels	Press JUMP The TV alternates between the current channel and the last channel tuned.
Display the current channel number (and other information)	Press DISPLAY once to display the channel number, current time, wide mode, and channel label (if set).
Switch the TV's input to the VCR, DVD player, or other connected equipment	Press TV/VIDEO repeatedly to cycle through the video equipment connected to the TV's video inputs.
Change video and audio options, customize the TV's setup, set parental controls, and more	Press MENU to display the Menu. For details, see "Using the Menus" on page 77.
Switch the TV's input between sources connected to the TV's VHF/UHF and AUX inputs	Press ANT to alternate between sources connected to the TV's VHF/UHF and AUX inputs.

Using Wide Mode

Wide Screen mode lets you watch 4:3 normal broadcasts in several Wide Screen modes.

💡 Wide Zoom is recommended for 4:3 picture to prevent image retention.

 **When viewing high-definition programs broadcast in 720p/1080i, it is not possible to change between Wide Screen modes.**

💡 You can also access the Wide Mode settings in the Screen menu. For details, see page 82.

- Press **WIDE** repeatedly to toggle through the following Wide Mode settings.



Wide Zoom

Wide Zoom enlarges the 4:3 picture, while the upper and lower parts of the picture are condensed to fit the wide screen.



Normal

Normal returns the 4:3 picture to its original size.



Full

Full Mode stretches the 4:3 picture horizontally only, to fill the wide screen.



Zoom

Zoom Mode enlarges the 4:3 picture horizontally and vertically to an equal aspect ratio that fills the wide screen. Useful for watching Letterbox movies.

💡 When you change channels or inputs, the Wide Mode settings revert to the 4:3 Default setting in the Screen menu. To retain the current Wide Mode setting as channels and inputs are changed, set 4:3 Default to Off. For details, see page 83.

Using Twin View

Twin View lets you see two pictures from two sources — from an antenna, VCR, DVD, etc. — on the screen at the same time. You hear the sound from only one of the sources at a time, but you can choose which source's sound is selected. You can also change the relative size of each of the pictures.



Displaying Twin Pictures

- 1 Tune the TV to a working channel.
- 2 Press .

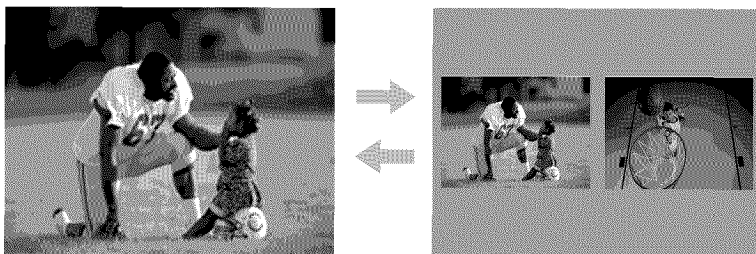
A second picture appears.



To cancel Twin View and watch the active picture

- Press  or .

Factors Affecting Twin View

- If you use a cable box to view all channels, the same channel appears in both windows because the cable box unscrambles only one channel at a time.
- If you use a cable box, you can view the cable box output in one window and view a different source (such as a VCR or DVD player) in the second window by using **TV/VIDEO**. For details, see “Connecting Optional Equipment” on page 29.
- Sources connected to the AUX, VIDEO 4, VIDEO 5, and VIDEO 6 inputs display in the left window, but not the right.
- If you are viewing a 4:3 source and a 16:9 enhanced source (such as a DVD) side by side, the 4:3 source appears larger.
- Twin View does not display channels that are blocked by parental settings (see page 86).

Activating the Picture

To activate the picture in the right window

□ Press **→**.

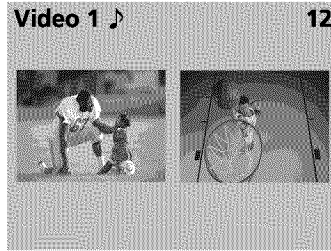

To activate the picture in the left window

□ Press **←**.

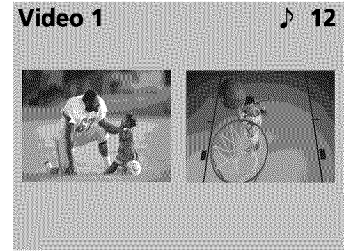

Functions Available in the Active Window

To Do This ...	Do This ...
Tune to a channel	Press 0-9 and then ENTER (or wait 3 seconds) or Press CH+/-
Adjust the volume	Press VOL +/-
Mute the volume	Press MUTING (press again to unmute)
Switch the TV's input between sources connected to the TV's A/V inputs	Press TV/VIDEO
Change the picture size	Press ↕ or ↔ . (For details, see "Changing the Picture Size" on page 64.)

Changing the Picture Size

The zoom feature lets you vary the relative size of the left and right pictures.

- 1 Press \leftarrow or \rightarrow to activate the picture that you want to resize.
- 2 Press \uparrow to enlarge the picture.
- 3 Press \downarrow to make the picture smaller.

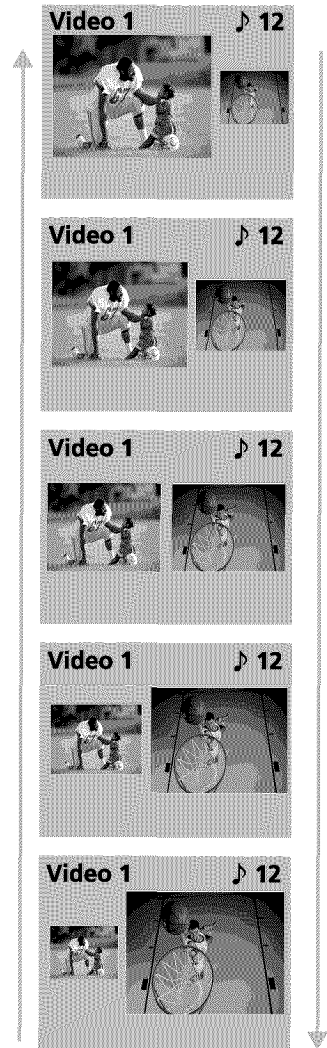

When you adjust the picture sizes, the TV memorizes the change. The next time you use the Twin View function, the memorized sizes appear.

Using Favorite Channels

The Favorite Channels feature lets you select programs from a list of up to eight favorite channels that you specify.

Creating a List of Favorite Channels

💡 For details on using the Channel Menu, see page 84.

- 1 Press **MENU** to display the Menu.
- 2 Press **←** or **→** to highlight the Channel icon and press **⏏**.
- 3 Press **⏏** to select **Favorite Channels**.
- 4 Press **⏏** to select **Program**.
- 5 Press **↑** or **↓** to highlight a Favorite Channel number (1-8) and press **⏏**.
- 6 Press **↑** or **↓** to highlight a channel you want to assign to the Favorite Channel number. A preview of the highlighted channel appears in the upper right of the screen. Press **⏏** to select that channel as a Favorite Channel.
- 7 To add more channels to your favorites list, repeat steps 5-6.
To clear a Favorite Channel, press **↑** or **↓** to highlight the channel you want to clear. Press **⏏** and then press **RESET**.
- 8 Press **MENU** to exit the Menu.

Displaying a List of Favorite Channels

💡 To assign Channel Labels (e.g., ABC, HBO, MTV, etc.) to channel numbers, as shown at right, use the Channel Label feature in the Channel Menu (see page 85).

- 1 Press **FAVORITES**. The Favorite Channels list appears.

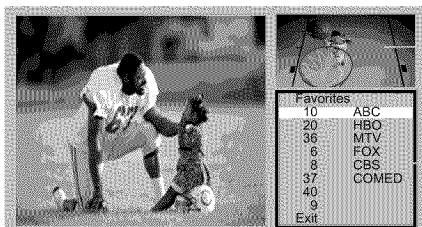

Preview of highlighted Favorite Channel

Favorite Channels

- 2 Press **↑** or **↓** to highlight the channel you want to watch.
A preview of the highlighted Favorite Channel appears.
- 3 Press **⏏** to select the channel you want to watch.
The Favorite Channels list disappears after 90 seconds if you do not operate the TV.

Using the Freeze Function

FREEZE allows you to temporarily capture a program's picture. You can use this feature to write down information such as phone numbers, recipes, etc.

 **The Freeze feature is not available while you are using the Twin View feature.**

- 1 When the program information you want to capture is displayed, press **FREEZE**.
- 2 The TV switches to Twin View mode and displays the "frozen" picture on the right, while the current program continues on the left.

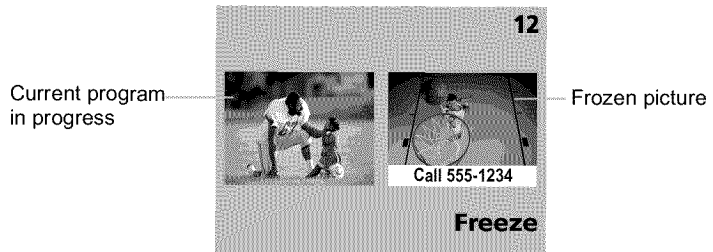

- 3 To cancel and return to normal viewing, press **FREEZE** (or just tune to another channel).

The "frozen" picture disappears automatically after 5 minutes.

Using Picture Off

The Picture Off feature lets you enjoy music from radio programs or digital broadcasts or DVDs with the TV screen turned off.

 **This feature turns off the display unit only.**

- 1 Press **PIC OFF**.

The **PICTURE OFF LED** lights up in blue and the screen turns off.

To cancel and return to normal viewing, press any button except for **VOL +/-**, **POWER**, **MUTING** and **MTS/SAP**.

About Memory Stick

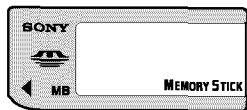

Memory Stick (sold separately) is a new, compact, portable, and versatile Integrated Circuit recording medium with a data capacity that exceeds that of a floppy disk. Memory Stick is specially designed for exchanging and sharing digital data among Memory Stick compatible products such as digital cameras and digital video cameras. Because it is removable, Memory Stick can also be used for external data storage.

You cannot write to Memory Stick media using the TV.

Memory Stick technology allows you to view on your TV screen digital (jpeg) images that are stored on Memory Stick media. You can choose from an index of the images stored on the Memory Stick, or you can run a slideshow of those images. You can also customize the features of the slideshow by selecting the length of time that each image is displayed, toggling the display of file information, and rotating each image.

For more information about the using Memory Stick media, see “Notes on Using Memory Stick Media” on page 95.

Supported Image Types

This TV’s Memory Stick viewer can display only still images that have been recorded on Memory Stick media by Sony brand digital still and video cameras.

The TV’s Memory Stick viewer is compatible with Memory Sticks up to and including 128MB. It is not compatible with Memory Sticks that exceed 128MB.

Recorded images must also meet the following specifications:

- Compression format: JPEG
- File name format: DCF compliant

 **JPEG stands for “Joint Photographic Experts Group,” which is the organization that implemented this format. DCF stands for “Design Rules for Camera File Systems,” which are specifications established by the Japan Electronic Industry Development Association (JEIDA).**

About DCF File Names

Most Sony brand digital still and video cameras automatically record still images using DCF compliant directory and file names, as shown in the following example:

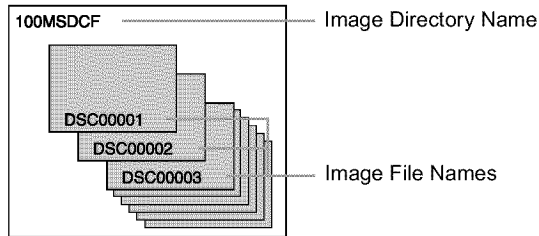

 **Do not rename directories. If the names are changed, the still images cannot be displayed on your TV.**

Unsupported Image Types

This TV's Memory Stick viewer cannot display any of the following:

- Images recorded on digital still cameras and digital video cameras that are not Sony brand
- Images recorded using products that are not DCF compliant, including the following Sony products:

Digital still cameras	DSC-D700, DSC-D770
Digital video cameras	DCR-TRV900/DSR-PD100A

- Images stored on a Memory Stick that have a capacity that exceeds 128MB
- Images stored in TIFF or any other non-JPEG compression format
- Images in directories that were modified or renamed on a computer
- Images with less than 16 horizontal and/or vertical lines per dot
- Images with more than 4096 horizontal and/or vertical lines per dot
- Movie clips

Inserting and Removing a Memory Stick

To insert a Memory Stick

- 1 Locate the Memory Stick slot (see page 17) and insert the Memory Stick into the Memory Stick slot as illustrated below. When inserted properly, it should slide in with little resistance and click into place.

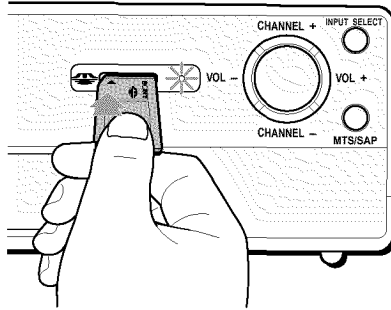

-  **Be sure to insert the Memory Stick in the correct direction. If the Memory Stick is forced in the wrong way, it may become damaged.**

Insert only Memory Stick media into the Memory Stick slot. Attempting to insert other objects into the slot may damage the TV.

To remove a Memory Stick

- 1 Check that the Memory Stick indicator is off. (When the light is on, this indicates that the TV is reading data from the Memory Stick.)
- 2 Push the Memory Stick gently into the slot, and then release it. The Memory Stick media is ejected.

 When removing the Memory Stick, do not attempt to just pull it from its slot. Follow steps 1-3 (right).

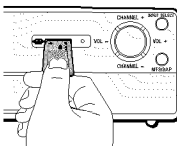
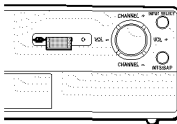
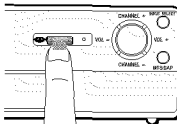
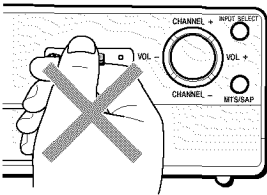

3 Pull the Memory Stick completely out of the slot.

 **To protect small children from injury from Memory Stick Media, remove all Memory Stick media from the TV's Memory Stick slot and store it in a safe location when it is not in use.**

Displaying the Memory Stick Menu

- 1 Insert a Memory Stick that contains the images you want to view. For details, see page 70.
- 2 Press MEMORY STICK on the remote control. The Memory Stick Menu appears.

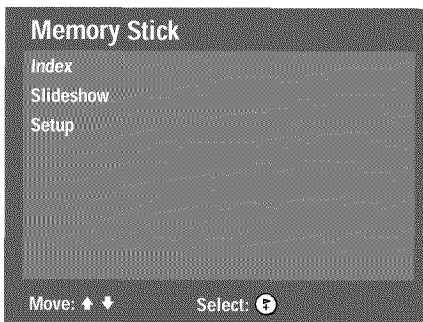



- 3 To select an option, press \uparrow or \downarrow to highlight the option and press \rightarrow .

Option	Description
Index	Displays an index of thumbnail images that are on the Memory Stick. For details, see “Using the Memory Stick Index” on page 73.
Slideshow	Displays a slideshow of images that are on the Memory Stick. For details, see “Using the Memory Stick Slideshow” on page 74.
Setup	Allows you to change slideshow options and rotate images. For details, see “Changing the Memory Stick Setup Options” on page 74.

- 4 To exit the Memory Stick Menu, press CH +/-, TV/VIDEO, ANT, MEMORY STICK again or use 0-9 and ENTER (or wait 3 seconds) to select a channel.

Memory Stick functions are not available while using Twin View, Freeze or Favorite Channel functions.





Using the Memory Stick Index

 The Page and folder () buttons are available only if the Memory Stick contains more images or folders than can be displayed on one screen.

 Larger images will take longer to display on screen.

The Memory Stick Index lets you view images that are on the Memory Stick in an index of thumbnail images.

 **There is no audio signal available while viewing images on Memory Stick.**





- 1 Insert a Memory Stick that contains the images you want to view. For details, see page 70.
- 2 Press MEMORY STICK on the remote control. The Memory Stick Menu appears.
- 3 Press     to highlight Index and press . The Memory Stick Index appears.







The selected image is highlighted in yellow

Information about the selected image

The Memory Stick Index disappears after 5 minutes if you do not operate the TV.

- 4 Press     to highlight an image and press  to select the image. Selecting an image displays that image at full size. While an image is displayed full size, you can do any of the following:

To Do This ...	Do This ...
Display the previous image	Press  .
Display the next image	Press  . If you press  while viewing the last image, the first image is displayed. If you press  while viewing the first image, the last image is displayed.
Display the Memory Stick Index	Press  .

- 5 To return to the Memory Stick Menu, press     to highlight Menu \rightarrow and press .

 **If a blank square appears instead of a thumbnail image, this indicates that the image does not support a thumbnail view. Selecting the icon, however, displays the full-size image on the screen. It could also indicate that both the thumbnail and full-size images are corrupted or not supported.**

Using the Memory Stick Slideshow

The Memory Stick Slideshow lets you watch a slideshow of the images that are on the Memory Stick.

- 1 Insert a Memory Stick that contains the images you want to view. For details, see page 70.
- 2 Press **MEMORY STICK** on the remote control. The Memory Stick Menu appears.
- 3 Press $\uparrow \downarrow \leftarrow \rightarrow$ to highlight **Slideshow** and press F . The slideshow starts.
- 4 To end the slideshow, press F . The Memory Stick Menu is displayed.

Changing the Memory Stick Setup Options

- 1 Press **MEMORY STICK** on the remote control. The Memory Stick Menu appears.
- 2 Press $\uparrow \downarrow \leftarrow \rightarrow$ to highlight **Setup** and press F . The Memory Stick Setup Menu appears.

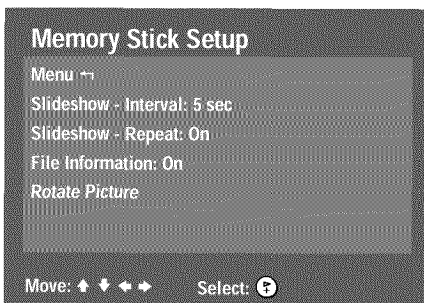

- 3 Press $\uparrow \downarrow \leftarrow \rightarrow$ to highlight an option and press F .





Option	Description
Menu	Returns to the Memory Stick Menu.
Slideshow – Interval	Decrease or increase the length of time that each image is displayed: 5 seconds, 10 seconds, 1 minute, 5 minutes, or 15 minutes.
Slideshow – Repeat	Select On to set the slideshow to repeat after displaying all the images recorded on the Memory Stick. Select Off to not repeat the slideshow.
File Information	Select On to show file information of each image while that image is being displayed.
Rotate Picture	Displays the Rotate Picture screen. For details, see “Using the Rotate Picture Screen” on page 75.



- 4 Press \rightarrow (or press F) to change settings. Press \leftarrow (or press F) to select the changed setting.
- 5 To exit the Memory Stick Setup Menu, press $\uparrow \downarrow \leftarrow \rightarrow$ to highlight **Menu-** and press F .

Using the Rotate Picture Screen









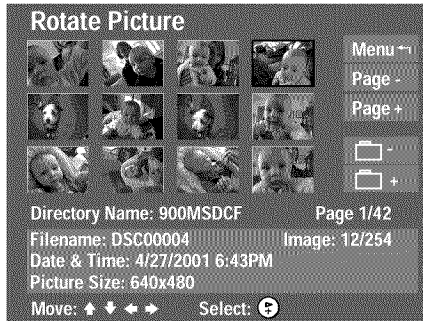

The Rotate Picture Screen lets you rotate an image from an index of thumbnails.

 **You cannot rotate images if the LOCK switch on the Memory Stick is on. To rotate the images, first set the LOCK switch to off.**

- 1 In the Memory Stick Setup Menu, press     to highlight **Rotate Picture** and press . The Rotate Picture screen appears.

 The Page and folder () buttons are available only if the Memory Stick contains more images or folders than can be displayed on one screen.









- 2 Press     to highlight an image that you want to rotate.
- 3 Press  to rotate an image 90 degrees in a clockwise direction.
- 4 To return to the Memory Stick Setup Menu, press     to highlight **Menu** and press .

 **If a blank square appears instead of the thumbnail image, this indicates that the image does not support a thumbnail view and cannot be rotated.**

Using the Menus



Overview

The Menu gives you access to the following features:

Menu Icon	Description	Page
	Allows you to make adjustments to your picture settings. It also allows you to customize the Picture Mode based on the type of program you are viewing, select Advanced Video options, and more.	78
	Offers enhanced audio options such as listening to second audio programming (SAP) or customizing the Effect of the sound on your TV.	80
	Allows you to make Wide Mode adjustments and make changes to the screen's vertical center.	82
	Allows you to set up a Favorite Channel list, run the Auto Program function, skip and label channels, and more.	84
	Lets you control the viewing of programs based on their ratings.	86
	Provides options for setting up your system, including setting the Timer, selecting closed caption modes, labeling video inputs, selecting the language of the on-screen menu, and more.	89

 Press **MENU** to enter and exit Menus.

Navigating Through Menus

To Do This ...	Press
Display the Menu	MENU
Move through the Menu	← →
Move through the Menu options	↑ ↓
Select an option to change	
Change an option's settings	↑ ↓ ← →
Select (confirm) changed setting	 or ←
Exit the Menu	MENU

 Menus include navigation help text that appears at the bottom of each Menu.



Using the Video Menu

To select the Video Menu

- 1 Press MENU.
- 2 Press \leftarrow or \rightarrow to highlight the Video icon and press \odot .
- 3 Press \uparrow \downarrow \leftarrow \rightarrow to highlight an option. Press \odot to select an option.
- 4 Press \uparrow \downarrow \leftarrow \rightarrow to change settings. Press \odot to select the changed setting.
- 5 Press MENU to exit the Menu.

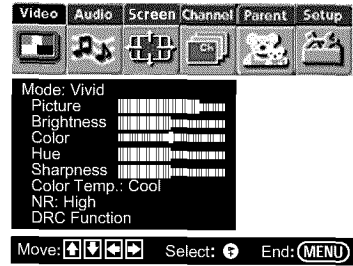

To restore the factory default settings for the Video settings (excluding Advanced Video) of the Mode (Vivid, Standard, etc.) the TV is set to:

- Press RESET on the remote control when in the Video Menu.

Selecting Video Options

To change from one Mode to another, use PICTURE on the remote control.

You can alter the Video Menu settings (Picture, Brightness, Color, etc.) for each Mode.

The Video Menu includes the following options:

Option	Description
Mode	Vivid Select for enhanced picture contrast and sharpness.
Customized picture viewing	Standard Select for standard picture settings.
	Pro Select for professional monitor like appearance settings.
	Mild Select for a natural, soft picture.
Picture	Adjust to increase picture contrast and deepen the color, or decrease picture contrast and soften the color.
Brightness	Adjust to brighten or darken the picture.
Color	Adjust to increase or decrease color intensity.
Hue	Adjust to increase or decrease the green tones.
Sharpness	Adjust to sharpen or soften the picture.
Color Temp.	Cool Select to give the white colors a blue tint.
White intensity adjustment	Neutral Select to give the white colors a neutral tint.
	Warm Select to give the white colors a red tint.

💡 DRC Function options are not available (grayed out) when watching 480p, 720p, and 1080i sources.

Option	Description
NR Noise Reduction	Select to reduce the noise level of connected equipment. It is also effective on the signal from the VHF/UHF jack. Select from High, Medium, Low, Off.
DRC Function	Select Program to choose among the DRC Mode and DRC Palette options while viewing NTSC sources.
DRC Mode	Creates a high-resolution picture with 4x density, for high quality sources (i.e., DVD player, satellite receiver).
High Dens.	Recommended for moving pictures.
Progressive	Recommended for still images and text.
CineMotion	Provides an optimized display by automatically detecting film content and applying a reverse 3/2 pulldown process. Moving pictures will appear clearer and more natural-looking.

DRC Palette Allows you to customize the level of detail (Reality) and smoothness (Clarity) for up to three input sources. For example, you can create one Custom setting to optimize your cable input's picture, and create another to optimize your DVD player's picture. You can switch among the three Custom settings in the menu.

- 1 Press $\uparrow \downarrow \leftarrow \rightarrow$ to highlight Custom 1, Custom 2, or Custom 3 and then press Enter . The DRC palette appears.

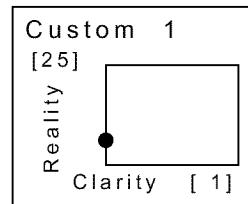

- 2 Press $\uparrow \downarrow \leftarrow \rightarrow$ to adjust the position of the marker (●). As you move the ● higher along the Reality axis, the picture becomes more detailed. As you move the ● to the right, along the Clarity axis, the picture becomes smoother.
- 3 To save the setting, press Enter .

To return the Custom options to the default factory settings, press **RESET**.

💡 For best results, adjust the Reality by pressing $\uparrow \downarrow$ until you are satisfied with the level of detail. Then adjust the Clarity by pressing $\leftarrow \rightarrow$ until you have a smooth image.

Adjusting backlight? See the instructions in "Using the Setup Menu" on page 91.



Using the Audio Menu

To select the Audio Menu

- 1 Press MENU.
- 2 Press ◀ or ▶ to highlight the Audio icon and press (⏏).
- 3 Press ↑ ↓ ◀ ▶ to highlight an option. Press (⏏) to select an option.
- 4 Press ↑ ↓ ◀ ▶ to change settings. Press (⏏) to select the changed setting.
- 5 Press MENU to exit the Menu.



To restore the factory default settings for Treble, Bass, and Balance

- Press RESET on the remote control when in the Audio Menu.

Selecting Audio Options

💡 To change quickly from one MTS to another, use MTS/SAP on the remote control.

The Audio Menu includes the following options:

Option	Description
Treble	Adjust to decrease or increase higher-pitched sounds.
Bass	Adjust to decrease or increase lower-pitched sounds.
Balance	Adjust to emphasize left or right speaker balance.
Steady Sound	Auto Select to stabilize the volume.
	Off Select to turn off Steady Sound.
Effect	TruSurround Select for surround sound (for stereo programs only).
	Simulated Adds a surround-like effect to mono programs.
	Off Normal stereo or mono reception.
MTS <i>Enjoy stereo, bilingual and mono programs</i>	Stereo Select for stereo reception when viewing a program broadcast in stereo.
	Auto SAP Select to automatically switch the TV to second audio programs when a signal is received. (If no SAP signal is present, the TV remains in Stereo mode.)
	Mono Select for mono reception. (Use to reduce noise during weak stereo broadcasts.)

<i>Option</i>	<i>Description</i>	
Speaker	On	Select to turn on the TV speakers.
	Off	Select to turn off the TV speakers and listen to the TV's sound only through your external audio system speakers.
Audio Out <i>Easy control of volume adjustments</i>	This option can be set only when the <i>Speaker</i> option is set to Off.	
	Variable	The TV's speakers are turned off, but the audio output from your audio system can still be controlled by the TV's remote control.
	Fixed	The TV's speakers are turned off and the audio output of the TV is fixed. Use your audio receiver's remote control to adjust the volume (and other audio settings) through your audio system.





To select the Screen Menu

- 1 Press MENU.
- 2 Press ◀ or ▶ to move to the Screen icon and press (⏏).
- 3 Press ↑ or ↓ to move to an option. Press (⏏) to select an option.
- 4 Press ◀▶↑↓ to change settings. Press (⏏) to select the changed setting.
- 5 Press MENU to exit the Menu.



Selecting Screen Mode Options

💡 To change from one Wide Mode to another, use WIDE on the remote control.

💡 Wide Zoom is recommended for 4:3 picture to prevent image retention.

💡 For Wide Zoom and Zoom modes, you can adjust the vertical position and size of the picture. For details, see page 83.

The Screen menu includes the following options:

Option	Description
Wide Mode <i>Select a Wide Mode to use for 4:3 sources.</i>	Wide Zoom Select to enlarge the 4:3 size picture, while the upper and lower parts of the picture are condensed to fit the wide screen.
Normal	Select to return the 4:3 picture to normal mode.
Full	Select to enlarge the 4:3 picture horizontally only, to fill the wide screen.
Zoom	Select to enlarge the 4:3 picture horizontally and vertically to an equal aspect ratio that fills the wide screen.

Wide Mode is unavailable while in Twin View, or when viewing HD (1080i, 720p) sources.

📌 In some cases, wide-screen programs will be shown in aspect ratios that require the display of black bands at the top and bottom of your wide screen. For more details, see page 98.

💡 If 4:3 Default is set to anything but Off, the Wide Mode setting changes only for the current channel. When you change channels (or inputs), Wide Mode is automatically replaced with the 4:3 Default setting. To retain the current Wide Mode setting as channels and inputs are changed, set 4:3 Default to Off.

Option	Description
4:3 Default	Wide Zoom
Select the default Screen Mode to use for 4:3 sources	Select to enlarge the 4:3 size picture, while the upper and lower parts of the picture are condensed to fit the wide screen.
	Normal
	Full
	Select to enlarge the 4:3 picture horizontally only, to fill the wide screen.
	Zoom
	Select to enlarge the 4:3 picture horizontally and vertically to an equal aspect ratio that fills the wide screen.
	Off
	Select to continue using the current Wide Mode setting when the channel or input is changed.
Vertical Center	Allows you to move the position of the picture up and down in the window. (Available only in Wide Zoom and Zoom modes.) Press \blacktriangle or \blacktriangledown and press ⏏ to choose a correction between +15 and -15 (Zoom mode), and +5 and -5 (Wide Zoom mode).
Vertical Size	Allows you to adjust the vertical size of the picture. (Available only in Wide Zoom and Zoom modes.) Press \blacktriangle or \blacktriangledown and press ⏏ to choose a correction between +7 and -7.



Using the Channel Menu

To select the Channel Menu

- 1 Press MENU.
- 2 Press ◀ or ▶ to highlight the Channel icon and press (ENTER).
- 3 Press ↑ ↓ ◀ ▶ to highlight an option. Press (ENTER) to select an option.
- 4 Press ↑ ↓ ◀ ▶ to change settings. Press (ENTER) to select the changed setting.
- 5 Press MENU to exit the Menu.





























Selecting Channel Options

The Channel Menu includes the following options:

Option	Description
Favorite Channels	Lets you set up a list of your favorite channels. For details, see “Using Favorite Channels” on page 65.
Cable	<p>On Select if you are receiving cable channels with a CATV cable.</p> <p>Off Select if you are using an antenna.</p>
 You should run Auto Program after changing this option.	
Channel Fix	Off Turns off Channel Fix.
<i>Useful when you have a cable box or satellite receiver connected</i>	2-6 “Fix” your TV’s channel setting to 2-6 and use the cable box or satellite receiver to change channels. Select one of these settings if you connected the equipment to the VHF/UHF jack.
	AUX 2-6 Same as 2-6, except you select one of these settings if you connected the equipment to the AUX jack (see page 18).
	Video 1 Use this setting if you have connected the equipment to the A/V input jacks.
Auto Program	Automatically sets up the channel list on the TV for all receivable channels.

 Channels that you set to be skipped can be accessed only with the 0-9 buttons.

 Channel Label is not available (grayed out) when watching 480p, 720p, and 1080i sources.

Option	Description
Channel Skip/Add	<p>Allows you to customize the channel list that appears when you use the CH+/- buttons.</p> <ol style="list-style-type: none"> 1 Press  or  to scroll through the channels until you find the channel you want to skip or add. Then press  to select it. 2 Press  or  to toggle between Add or Skip. Then press  to select. 3 To add or skip more channels, repeat steps 1 and 2. 4 Press  to return to the Channel Menu, or press MENU to exit the Menus. <p> Depending on reception condition, the digital TV broadcast channel may be presettable. In this case, set the channel to be skipped.</p>
Channel Label	<p>Allows you to assign labels (such as station call letters) to channel numbers. You can label up to 20 channels.</p> <ol style="list-style-type: none"> 1 Press     to highlight Channel and press . 2 Press  or  to scroll through the channel numbers (1-125). Then press  to select the channel number that you want to assign a label. 3 Press     to highlight Label and press . 4 Press  or  to scroll through the label characters (A-Z, 0-9, etc.). Then press  to select the highlighted character. 5 Repeat to add up to 5 characters to the label. 6 To assign labels to more channels, repeat steps 1-4. 7 Press  to return to the Channel Menu, or press MENU to exit the Menu.





Using the Parent Menu

The Parent Menu allows you to set up the TV to block programs according to their content and rating levels.



To select the Parent Menu

- 1 Press MENU.
- 2 Press \leftarrow or \rightarrow to highlight the Parent icon and press [Enter] .
- 3 Use 0-9 on the remote control to enter a four-digit password.
- 4 If this is the first time you are creating this password, confirm the password by entering it again. (The Parent Menu options appear.)
- 5 Press \uparrow \downarrow \leftarrow \rightarrow to change settings. Press [Enter] to select the changed setting.
- 6 Press MENU to exit the Menu.

You need your password for any future access into the Parent Menu. If you lose your password, see “Lost password” on page 100.

Selecting Parent Options

If you are not familiar with the Parental Guideline rating system, you should select Child, Youth, or Y. Adult to help simplify the rating selection. To set more specific ratings, select Custom.

For descriptions of Child, Youth, and Y. Adult ratings, see page 87.

The Parent Menu includes the following options:

Option	Description
Parental Lock	Off Parental lock is off. No programs are blocked from viewing.
Turn ratings on/off and select a rating system	<p>Child Maximum ratings permitted are: <input type="checkbox"/> US: TV-Y, TV-G, G <input type="checkbox"/> Canada: C, G, TV-Y</p> <p>Youth Maximum ratings permitted are: <input type="checkbox"/> US: TV-PG, PG <input type="checkbox"/> Canada: C8+, PG, 8 ans+, TV-PG</p> <p>Y. Adult Maximum ratings permitted are: <input type="checkbox"/> US: TV-14, PG-13 <input type="checkbox"/> Canada: 14+, 13 ans+, TV-14</p> <p>Custom Select to set ratings manually. <input type="checkbox"/> US: See page 87 for details. <input type="checkbox"/> Canada: See page 88 for details.</p>
Change Password	For changing your password.
Select Country	<p>U.S.A. Select to use USA ratings (see page 87).</p> <p>Canada Select to use Canadian ratings (see page 88).</p>

US Models: Selecting Custom Rating Options

💡 The Content-Based Ratings are linked to the level of the Age-Based Rating. For example, a program with an Age-Based Rating of **TV-PG V** (Violence) rating may contain moderate violence, while a **TV-14 V** (Violence) rating may contain more intense violence.

💡 To ensure maximum blocking capability, set the Age-Based Ratings.

💡 If you block unrated TV programs, be aware that the following types of programs may be blocked: programs broadcast from another country, emergency broadcasts, political programs, sports, news, public service announcements, religious programs and weather.

Viewing Blocked Programs

For US models, the Custom Rating Menu includes the following options. (For Canadian models, see page 88.)

Option	Description
Movie Rating	G All children and General Audience.
	PG Parental Guidance suggested.
	PG-13 Parental Guidance for children under 13.
	R Restricted viewing, parental guidance is suggested for children under 17.
	NC-17 and X No one 17 or under allowed.
TV Rating	Age-Based Ratings
<i>Block programs by their rating, content or both</i>	TV-Y All children.
	TV-Y7 Directed to children age 7 and older.
	TV-G General Audience.
	TV-PG Parental Guidance suggested.
	TV-14 Parents Strongly cautioned.
	TV-MA Mature Audience only.
	Content-Based Ratings
	FV Fantasy Violence.
	D Suggestive Dialogue.
	L Strong Language.
	S Sexual situations.
	V Violence.
Unrated <i>Block programs or movies that are broadcast without a rating</i>	Allow Allows programs and movies that are broadcast without a rating.
	Block Blocks all programs and movies that are broadcast without a rating.

You can view blocked programs by entering the password. Press **ENTER** when tuned to a blocked program, then enter the password. This temporarily switches off the Parental Lock. To reactivate the Parental Lock settings, turn off the TV. When the TV is turned on again, your Parental Lock settings are reactivated.

.....

Canadian Models: Selecting Custom Rating Options

For Canadian models, the Custom Rating Menu includes the following options. (For US models, see page 87.)

Option	Description	
English Rating	C	All children.
	C8+	Children 8 years and older.
	G	General programming.
	PG	Parental Guidance.
	14+	Viewers 14 and older.
	18+	Adult programming.
French Rating	G	General programming.
	8 ans+	Not recommended for young children.
	13 ans+	Not recommended for ages under 13.
	16 ans+	Not recommended for ages under 16.
	18 ans+	Programming restricted to adults.
U.S.A. Rating	See "US Models" on page 87 for details.	

.....

Viewing Blocked Programs

You can view blocked programs by entering the password. Press **ENTER** when tuned to a blocked program, then enter the password. This temporarily switches off the Parental Lock. To reactivate the Parental Lock settings, turn off the TV. When the TV is turned on again, your Parental Lock settings are reactivated.



Using the Setup Menu

To select the Setup Menu

- 1 Press MENU.
- 2 Press ◀ or ▶ to highlight the Setup icon and press (Enter).
- 3 Press ↑ ↓ ◀ ▶ to highlight an option. Press (Enter) to select an option.
- 4 Press ↑ ↓ ◀ ▶ to change settings. Press (Enter) to select the changed setting.
- 5 Press MENU to exit the Menu.





💡 To move from within one Menu to the main Menu of icons, press ◀.

Selecting Setup Options



The Setup Menu includes the following options:



















Option	Description	
Caption Vision	Allows you to select from three closed caption modes (for programs that are broadcast with closed caption).	
	Off	Turns off Caption Vision.
	CC1-CC4	Displays a printed version of the dialog or sound effects of a program. (Should be set to CC1 for most programs.)
	Text1-Text4	Displays network/station information presented using either half or the whole screen (if available). For closed captioning, set to CC1.
Info	Displays the program name and the time remaining in the program (if the broadcaster offers this service).	
	Displays when the channel is changed or DISPLAY is pressed.	
Illuminated	Allows you to illuminate the Sony logo on the front panel of the display unit.	
	Yes	Illuminates the Sony logo while the power is turned on.
	No	Illuminates the Sony logo only when the power is switched to on or off.

 When selecting **Game**, or **Web**, the TV decreases brightness to prevent image retention.

 The **Skip** label is useful for inputs that do not have equipment connected to them.

Option	Description				
Video Label	<p>Allows you to identify A/V equipment you connected to the TV, such as a VCR, DVD, etc. For example, if you have a DVD player connected to the VIDEO 4 jack, you can select the label DVD for the VIDEO 4 input. Then when you press TV/VIDEO to change inputs, the Video Label you assigned to that input appears on screen.</p> <ol style="list-style-type: none"> 1 Press ▲ or ▼ to highlight the video input (VIDEO 1-6) to which you want to assign a label. Then press ⏏ to select the input. 2 Press ▲ or ▼ to highlight one of the displayed labels. Then press ⏏ to select the label. <p>You can select from the following labels for each input:</p> <table border="1" data-bbox="618 526 1255 679"> <tr> <td data-bbox="618 526 860 553">Video 1-3</td> <td data-bbox="860 526 1255 614">VHS, DVD, Receiver, Satellite, Cable Box, 8mm, DTV, Game, LD, Web, Beta, Skip</td> </tr> <tr> <td data-bbox="618 621 860 649">Video 4-6</td> <td data-bbox="860 621 1255 679">DVD, Satellite, Cable Box, DTV, HD, Game, Skip</td> </tr> </table> <p> If you select Skip, your TV skips this input when you press the TV/VIDEO button.</p>	Video 1-3	VHS, DVD, Receiver, Satellite, Cable Box, 8mm, DTV, Game, LD, Web, Beta, Skip	Video 4-6	DVD, Satellite, Cable Box, DTV, HD, Game, Skip
Video 1-3	VHS, DVD, Receiver, Satellite, Cable Box, 8mm, DTV, Game, LD, Web, Beta, Skip				
Video 4-6	DVD, Satellite, Cable Box, DTV, HD, Game, Skip				
Game Picture	<p>Allows you to move the position of the picture left and right in the window. (Available for the picture of connected equipment.) Select while watching the picture to be adjusted. The TV stores the position in memory for each input.</p>				
Language	<p>Select to display all on-screen Menus in your language of choice.</p>				

💡 To go directly to programming Timer 1 or 2, press  instead of pressing .

Option	Description
Clock/Timers	Lets you set the clock on your TV and allows you to program your TV for scheduled viewing using the Timers.
Sleep	Allows you to select the time in minutes (15, 30, 45, 60, or 90) that you want the TV to remain on before shutting off automatically.
Timer 1 & 2	<p>You can use the Timers to program the TV to turn on and off and tune to a specific channel at two scheduled viewing times.</p> <p>Timer 1 & 2 are not available to be set until you set the Current Time.</p> <ol style="list-style-type: none"> 1 Press  or  to highlight Timer 1 or Timer 2. To set the timer, press . 2 Press  or  to highlight one of the following options, then press . <ul style="list-style-type: none"> Program: Select to set the Timer by day, time, duration, and channel. Off: Select to turn off the Timer. (Your previous settings are saved.) 3 If you selected Program in step 2, press  and  to set the day(s), hour, minute, duration, and channel number. Press  or press  to confirm each setting and move to the next setting. Press  to go back to the previous setting. 4 Press MENU to exit the Menu. An LED on the front panel will light, indicating the timer has been set.
Current Time	<ol style="list-style-type: none"> 1 Press  and  to highlight Current Time and then press . 2 Press  and  to set the current time (day, hour, and minute). Press  (or press ) to confirm each setting and move to the next setting. Press  to go back to the previous setting. 3 Press MENU to exit the Menu.
BackLight	Adjust to decrease or increase backlight luminance.

Other Information

Overview

This chapter includes the following topics:

<i>Topic</i>	<i>Page</i>
Glossary	94
Notes on Using Memory Stick Media	95
Contacting Sony	96
Troubleshooting	96
Specifications	101
Optional Accessories	103
Index	104

Glossary

analog signal A signaling method that uses continuous changes in the amplitude or frequency of an electronic transmission to convey information.

aspect ratio Refers to the ratio between the width and height of the screen. This TV has a wide screen, as opposed to a 4:3 aspect ratio.

4:3 aspect ratio



wide screen



component video



Component video is sent through three cables: two color shade (chrominance) signals and one brightness (luminance) signal. Component video achieves greater color accuracy than composite video or S VIDEO by splitting chrominance into two separate portions.

composite video



Composite video is sent through a single cable. Composite video combines the color shade (chrominance) and brightness (luminance) information into one video signal.

digital television (DTV)

A new technology for transmitting and receiving broadcast television signals. DTV provides higher resolution and improved sound quality over analog television.

National Television System Committee (NTSC)

A unit of the Federal Communications Commission, Washington, DC, that establishes television standards in the United States, such as NTSC Color, the standard used in this TV.

RF

Radio Frequency. That part of the frequency spectrum in which it is possible to radiate (transmit) electromagnetic waves.

S VIDEO



S VIDEO requires a single cable, which carries the brightness (luminance) and color (chrominance) signals of the picture separately. S VIDEO provides better resolution than composite video, which carries the signals together.

VHF/UHF

VHF (Very High Frequency) is the part of the radio spectrum from 30 to 300 megahertz. UHF (Ultra High Frequency) is the part of the radio spectrum from 300 to 3,000 megahertz.

480i

Provides 480 lines of resolution. Displays images using interlaced scanning, which first transmits all the odd lines on the TV screen and then the even lines.

480p

Provides 480 lines of resolution. Displays images using progressive scanning, which transmits each line from top to bottom.

720p

Provides 720 lines of resolution. Displays images using progressive scanning, which transmits each line from top to bottom.

1080i

Provides 1080 lines of resolution. Displays images using interlaced scanning, which first transmits all the odd lines on the TV screen and then the even lines. 1080i is one of the formats used by HDTV (High Definition TV).

Notes on Using Memory Stick Media

Memory Stick Precautions

When using Memory Stick media, follow these precautions:

- To avoid permanent damage to still image data, do not turn off the TV or remove Memory Stick media from the insertion slot while data is being read (as indicated by the Memory Stick indicator light being on).
- Avoid touching the terminal of Memory Stick media or bringing it into contact with a metal object.
- Do not drop, bend, or submit Memory Stick media to external shock.
- Do not disassemble or modify Memory Stick media.
- Avoid getting liquid on Memory Stick media.
- Apply labels only within the designated label area.

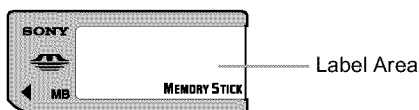

- To avoid permanent damage to still image data, do not use or store Memory Stick media in a location subject to:
 - High temperature (such as near a heater or inside a hot car)
 - High humidity
 - Direct sunlight
 - Corrosive substances
 - Magnetic fields
 - Excessive dust
 - Static electricity or electric noise
- Store and carry Memory Stick media in its original case to ensure protection of stored data.
- Save a backup of stored data.

Contacting Sony

If, after reading these operating instructions, you have additional questions related to the use of your Sony television, please call our Customer Information Services Center at 1-800-222-SONY (7669) (US residents only) or (416) 499-SONY (7669) (Canadian residents only).

Troubleshooting

Twin View

Problem	Possible Remedies
I cannot get Twin View to work	<ul style="list-style-type: none"><input type="checkbox"/> If you are using a cable box to unscramble all channels (as shown on page 27), you cannot use the Twin View feature. This is because the cable box can unscramble only one channel at a time.<input type="checkbox"/> You can use Twin View to view a signal from a different source that is connected to the TV's A/V jacks (such as a VCR or DVD player) in the second window by pressing TV/VIDEO while in Twin View.<input type="checkbox"/> Sources connected to the AUX, VIDEO 4, VIDEO 5, and VIDEO 6 inputs display in the left Twin View window, but not the right.
There is no Twin View window, or it is just static	<ul style="list-style-type: none"><input type="checkbox"/> Be sure the Twin View window is set to a video input or channel that has a signal airing.<input type="checkbox"/> You might be tuned to a video input with nothing connected to it. Try cycling through the video inputs by pressing TV/VIDEO.
Twin View cannot display anything but TV channels	<ul style="list-style-type: none"><input type="checkbox"/> Try cycling through the video inputs by pressing TV/VIDEO. Check that the Video Label option is not set to Skip. (See the Setup Menu on page 90.)
Twin View displays the same program in both windows	<ul style="list-style-type: none"><input type="checkbox"/> Both Twin View windows might be set to the same channel. Try changing channels in either window.

Remote Control

Problem	Possible Remedies
Remote control does not operate	<ul style="list-style-type: none"> <input type="checkbox"/> The batteries could be weak. Replace the batteries. <input type="checkbox"/> Check the orientation of the batteries. <input type="checkbox"/> Press FUNCTION repeatedly until the TV indicator lights up. You may have inadvertently pressed FUNCTION, which changes the remote control to SAT or CABLE mode. <input type="checkbox"/> Make sure this unit's power cord is connected securely to the wall outlet. <input type="checkbox"/> Locate the unit at least 3-4 feet away from fluorescent lights.
Cannot change channels with the remote control	<ul style="list-style-type: none"> <input type="checkbox"/> If you are using the TV to change channels, first press FUNCTION repeatedly until the TV indicator lights up. <input type="checkbox"/> If you are using another device to change channels, be sure you have not inadvertently switched your TV from the channel 3 or 4 setting. Use the Channel Fix option to "fix" the channel based on the hookup you used (see page 84). <input type="checkbox"/> If you are using another device to change channels, be sure to press FUNCTION for that device. For example, if you are using your cable box to change channels, be sure to press FUNCTION repeatedly until the SAT/CABLE indicator lights up.
Remote control does not operate non-Sony video equipment	<ul style="list-style-type: none"> <input type="checkbox"/> If you replaced the batteries to the remote recently, the code numbers for the video equipment may need to be reset. <input type="checkbox"/> There may be more than one code for the equipment that you are attempting to operate. <input type="checkbox"/> There is a possibility that some non-Sony equipment cannot be operated by your Sony TV remote. You may need to use the equipment's original remote control.

Memory Stick

Problem	Possible Remedies
Image does not display	<ul style="list-style-type: none"> <input type="checkbox"/> Make sure the image is supported by the TV (see page 68). <input type="checkbox"/> Make sure the Memory Stick is inserted properly (see page 70). <input type="checkbox"/> Memory Stick functions are not available while using Twin View, Freeze or Favorite Channel functions.
Blank square appears instead of a thumbnail image	<ul style="list-style-type: none"> <input type="checkbox"/> This indicates that the image does not support a thumbnail view. Selecting the icon, however, displays the full-size image on the screen. It could also indicate that both the thumbnail and full-size images are corrupted or not supported.
Cannot rotate image, no thumbnail appears	<ul style="list-style-type: none"> <input type="checkbox"/> Be sure the LOCK switch on the Memory Stick is set to off. <input type="checkbox"/> If a blank square appears instead of the thumbnail image, this indicates that the image does not support a thumbnail view and cannot be rotated.
Cannot hear audio while using Memory Stick	<ul style="list-style-type: none"> <input type="checkbox"/> There is no audio available while using Memory Stick.
Image file name does not appear; instead, dashes (---) appear	<ul style="list-style-type: none"> <input type="checkbox"/> Dashes appear instead of the file name if the image was recorded using equipment that is not DCF-compliant. Dashes also appear if a DCF-compliant file was renamed.

Video

Problem	Possible Remedies
No picture (screen not lit), no sound	<ul style="list-style-type: none"> <input type="checkbox"/> If your TV does not turn on, and a red light keeps flashing, your TV may need service. Call your local Sony Service Center. <input type="checkbox"/> Make sure the power cord is plugged in. <input type="checkbox"/> Press POWER on the front of the media receiver unit. <input type="checkbox"/> Press TV/VIDEO to cycle through the connected video sources. <input type="checkbox"/> Try another channel; it could be station trouble. <input type="checkbox"/> Press PIC OFF so that the PICUTRE OFF LED on the display unit goes off. <input type="checkbox"/> Make sure the display interface cable is connected to the display unit and media receiver unit.
Dark, poor or no picture (screen lit), good sound	<ul style="list-style-type: none"> <input type="checkbox"/> Adjust the Picture option in the Video Menu (see page 78). <input type="checkbox"/> Adjust the Brightness option in the Video Menu (see page 78). <input type="checkbox"/> Check the antenna/cable connections.
No color	<ul style="list-style-type: none"> <input type="checkbox"/> Adjust the Color option in the Video Menu (see page 78).
Only snow and noise appear on the screen	<ul style="list-style-type: none"> <input type="checkbox"/> Check the antenna/cable connections. <input type="checkbox"/> Try another channel; it could be station trouble. <input type="checkbox"/> Press ANT to change the input mode (see page 52).
Dotted lines or stripes	<ul style="list-style-type: none"> <input type="checkbox"/> Adjust the antenna. <input type="checkbox"/> Move the TV away from noise sources such as cars, neon signs, or hair-dryers.
Double images or ghosts	<ul style="list-style-type: none"> <input type="checkbox"/> Using a highly directional outdoor antenna or a cable may solve the problem.
“Black box” on screen	<ul style="list-style-type: none"> <input type="checkbox"/> You have selected a text option in the Setup Menu and no text is available. (See page 89 to reset Setup selections.) To turn off this feature, set the Caption Vision option to Off. If you were trying to select closed captioning, select CC1 instead of Text 1-4.
Black bands appear at the top and bottom of the screen	<ul style="list-style-type: none"> <input type="checkbox"/> Some wide-screen programs are filmed in aspect ratios that are greater than 16:9 (this is especially common with theatrical releases). Your TV will show these programs with black bands at the top and bottom of the screen. For more details, check the documentation that came with your DVD (or contact your program provider).
Certain programs on DVD or other digital sources display a loss of detail, especially during fast-motion or dark scenes	<ul style="list-style-type: none"> <input type="checkbox"/> The compression used by certain digital broadcasts and DVDs may cause your TV’s screen to display less detail than usual, or cause artifacts (small blocks or dots, pixelations) to appear on your screen. This is due to your TV’s large screen and ability to show very fine detail, and is normal for certain digitally recorded programs. Adjust the reality/clarity in the DRC Palette menu (see page 79) to optimize the picture while viewing these sources.

Audio

Problem	Possible Remedies
Good picture, no sound	<ul style="list-style-type: none"> <input type="checkbox"/> Press MUTING so that Muting disappears from the screen (see page 52). <input type="checkbox"/> Make sure the Speaker option is set to On in the Audio Menu (see page 81).
Audio noise	<ul style="list-style-type: none"> <input type="checkbox"/> Communication problems may occur if the infrared communication equipment (e.g., infrared cordless headphones) is used near the TV. Please use headphones other than infrared cordless headphones. Also, if you use the infrared communication equipment other than infrared cordless headphones, move the infrared transceiver away from the TV until the noise is eliminated, or move the transmitter and receiver of the infrared communication equipment closer together.
Cannot gain enough volume when using a cable box	<ul style="list-style-type: none"> <input type="checkbox"/> Increase the volume of the cable box using the cable box's remote control. Then press FUNCTION repeatedly until the TV indicator lights up and adjust the TV's volume.
Sound seems weak or insufficient	<ul style="list-style-type: none"> <input type="checkbox"/> The TV's audio might be set to Auto SAP or Mono, when it might be better set to Stereo. In the Audio Menu (see page 80), set the MTS setting to Stereo. If already set to Stereo, switch to Mono (which may reduce background noise during weak stereo broadcasts).
Cannot raise the volume on external speakers	<ul style="list-style-type: none"> <input type="checkbox"/> If the Speaker option is set to Off and the Audio Out option is set to Fixed (in order to output the sound to your audio system) use your audio receiver to adjust the sound (see page 81). Or, to use the TV remote control, set the Audio Out option to Variable. <input type="checkbox"/> To turn on the TV speakers, set the Speaker option to On (see page 81).

Channels

Problem	Possible Remedies
Cannot receive upper channels (UHF) when using an antenna	<ul style="list-style-type: none"> <input type="checkbox"/> Change the Cable option to Off (see page 84). <input type="checkbox"/> Use Auto Program in the Channel Menu to add receivable channels that are not presently in the TV's memory (see page 84).
TV is fixed to one channel	<ul style="list-style-type: none"> <input type="checkbox"/> Use Auto Program in the Channel Menu to add receivable channels that are not presently in the TV's memory (see page 84). <input type="checkbox"/> Check your Channel Fix settings (see page 84).
Cannot receive any channels when using cable TV	<ul style="list-style-type: none"> <input type="checkbox"/> Use Auto Program in the Channel Menu to add receivable channels that are not presently in the TV's memory (see page 84). <input type="checkbox"/> Make sure the Cable option is set to On in the Channel Menu (see page 84).
Cannot receive or select channels	<ul style="list-style-type: none"> <input type="checkbox"/> Use Auto Program in the Channel Menu to add receivable TV channels that are not presently in TV memory (see page 84).

.....

General

<i>Problem</i>	<i>Possible Remedies</i>
How to restore Video settings to factory settings	<input type="checkbox"/> Press RESET on the remote control while in the Video Menu (see page 78).
How to restore Audio settings to factory settings	<input type="checkbox"/> Press RESET on the remote control while in the Audio Menu (see page 80).
Cannot cycle through the other video equipment connected to the TV	<input type="checkbox"/> Be sure the Video Label option is not set to Skip (see page 90).
Cannot operate Menu	<input type="checkbox"/> If a menu option appears in gray, this indicates that the menu option is not available.
Lost password	<input type="checkbox"/> In the password screen (see page 86), enter the following master password: 4357 . The master password clears your previous password; it cannot be used to temporarily unblock channels.
LED on the display unit is lit	<input type="checkbox"/> The POWER ON/STAND BY LED (see page 16) lights up when the TV is turned on. If the LED blinks continuously, this may indicate the TV needs a service. <input type="checkbox"/> The TIMER LED (see page 16) indicates that the timer is set. When the timer is set, this LED will remain lit even when the TV is turned off.

Specifications

Panel System	Liquid Crystal Display panel	
Display resolution	Display resolution: 1280 pixels (horizontal) × 768 pixels (vertical)	
Antenna	75 ohm external terminal for VHF/UHF	
Television System	NTSC, American TV Standard	
Channel Coverage	VHF	2-13
	UHF	14-69
	CATV	1-125
Power Requirements	120 V, 60 Hz	
Inputs/Outputs		
DVI-HDTV	1 terminal, 3.3V T.M.D.S., 50 ohms The DVI-HDTV input terminal is compliant with the EIA-861 standard and is not intended for use with personal computers.	
Video (IN)	3 total (1 on front panel)	1 Vp-p, 75 ohms unbalanced, sync negative
S Video (IN)	3 total (1 on front panel)	Y: 1 Vp-p, 75 ohms unbalanced, sync negative C: 0.286 Vp-p (Burst signal), 75 ohms
Audio (IN)	6 total (1 on front panel)	500 mVrms (100% modulation) Impedance: 47 kilohm
Component Video Input	2 (Y, PB, PR)	Y: 1.0 Vp-p, 75 ohms unbalanced, sync negative; PB: 0.7 Vp-p, 75 ohms PR: 0.7 Vp-p, 75 ohms
CONTROL S (OUT)	1	
Variable/Fixed Audio (OUT)	1	More than 408 mVrms at the maximum volume setting (Variable) More than 408 mVrms (Fixed) Impedance (output): 2 kilohms
Monitor/Fixed Audio (OUT)	×1	
Sub woofer (OUT)	1	phono jack
RF Inputs	2	
Converter	1	
Screen Size (measured diagonally)	30 inches	
Speaker Output	10 w × 2, 4 ohms	
Dimensions (W × H × D)	Display unit	
	LDM-3000: 971.2 × 594.4 × 229 mm (38 1/4 × 23 1/2 × 9 1/8 in) - with stand 971.2 × 524.3 × 93.4 mm (38 1/4 × 20 3/4 × 3 3/4 in) - without stand	
Mass	Media receiver unit	
	MBT-XBR900L: 430 × 105 × 360 mm (17 × 4 1/4 × 14 1/4 in)	
Mass	Display unit	
	LDM-3000: 27 Kg (59 lbs 60ozs) - with stand 20 Kg (44 lbs) - without stand	
Mass	Media receiver unit	
	MBT-XBR900L: 7.5 Kg (16 lbs)	

(Continued)



Power Consumption	In Use	Display unit
		LDM-3000: 150 W
Supplied Accessories	In Standby	Media receiver unit
		MBT-XBR900L: 36 W
		Under 1.5 W
		Remote Control (1)
		RM-927Y
		AAA (LR03) Batteries (2)
		AC power code (2)
		Display interface cable (1)
		Antenna cable (1)

Design and specifications are subject to change without notice.



Optional Accessories

- A/V Cable (VMC-810/820/830 HG)
- Audio Cable (RKC-515HG)
- Component Video Cable (VMC-10/30 HG)
- Control S Cable (RK-G69HG)
- 10M display interface cable (VMC-P10)
- Memory Stick media: 8 MB (MSA-8A); 16 MB (MSA-16A); 32 MB (MSA-32A); 64 MB (MSA-64A); 128 MB (MSA-128A)
- Wall mount unit: SU-PW1



Index

0-9 buttons 53, 60
16:9 aspect ratio 61
4:3 aspect ratio 61
4:3 Default settings 83

A

ANT button 52, 60
antenna, connecting 22-24
Audio Menu 77, 80
Audio Out 81
audio receiver, connecting 46
Auto Program (channel setup) 49, 84
Auto SAP, MTS setting 80
AUX jack, described 18

B

BackLight 91
balance, adjusting 80
bass, adjusting 80
batteries, inserting in remote 51
bilingual audio 80
blocking programs. *See ratings.*
brightness, adjusting 78

C

cable
 connecting 23
 setting On/Off 84
 with VCR, connecting 30
cable box
 connecting with VCR 32
 Twin View issues 62
 using with TV remote control 57
Caption Vision 89
CATV. *See cable*
CH buttons 17, 53, 60
changing picture size, in Twin View 64
Channel Menu 77, 84
Channel Skip/Add 85
channels
 creating labels 85

 setting up 49
CineMotion 14, 79
clearing, Favorite Channels 65
Clock/Timers 91
closed caption modes 77, 89
color, adjusting 78
CONTROL S 48
CONTROL S OUT jack, described 18
Cool, Color Temperature 78

D

Digital Reality Creation 14
Digital Visual Interface (DVI) 14, 18
DISPLAY button 52, 60
DISPLAY SIGNAL OUT, described 18
Display unit
 connecting 20
 controls 16
DRC Function 79
DRC Mode 79
DRC Palette 79
DRC. *See Digital Reality Creation.*
DVD player
 using with TV remote control 57
 with A/V connectors, connecting 42
DVI. *See Digital Visual Interface.*
DVI-HDTV 18, 101

E

ENTER button 53, 60

F

Fast-forward button 53
Favorite Channels
 clearing 65
 in Channel Menu 84
 using 65
FAVORITES button 53
features 13
Fixed audio setting 81
FREEZE button 53, 66
Freeze, using 66
Full mode, setting 82

FUNCTION button and indicators 52

G

Game Picture 90
GUIDE button 52

H

HD/DVD IN (1080i/720p/480p/480i) jacks,
described 19
hue, adjusting 78

I

INPUT SELECT button 17
interlaced 94

J, K

JUMP button 52, 60

L

label
channels 85
Language, setting 90
LOCK switch, Memory Stick 75

M

MDP, using with TV remote control 57
Media receiver unit
connecting 21
front panel 17
rear panel 18
Memory Stick
Index 73
indicator (LED) 17
inserting 70
insertion slot 17
Menu 72
precautions 95
Rotate Picture 75
Setup options 74
Slideshow 74
supported and unsupported images 68
troubleshooting 97
using 68–75
Memory Stick button 53
MENU button 52, 60, 77
Menus
Audio 77, 80
Channel 77, 84
Parent 77, 86
Screen 77, 82

Setup 89
Video 77, 78
Mild mode 78
Mono, MTS setting 80
MTS 80
MTS/SAP button 53
MUTING button 52, 60

N

Neutral, Color Temperature 78
Normal mode, setting 82
NR 79

O

off, turning off the TV 17, 52
on, turning on the TV 17, 52

P, Q

Parent Menu 77, 86
parental control, described 14
password, changing 86
Pause button 53
PIC OFF button 52
PICTURE button 52
picture contrast, adjusting 78
Picture in Picture. *See Twin View.*
Play button 53
POWER button 17, 52, 60
POWER LED 16, 17, 100
POWER ON/STAND BY indicator 16, 17
powering on/off, the TV 17, 52
presetting channels 84
Pro (Video) mode 78
problems, troubleshooting 96–100
progressive 94

R

ratings, setting 86–88
ratings, viewing blocked programs 87, 88
Record buttons 53
remote control
inserting batteries 51
programming 54–55
removing, Favorite Channels 65
RESET button 53
resetting
Audio options 80
Rewind button 53

(Continued)

rotate picture, Memory Stick 75

S

S VIDEO jack, described 17, 18
SAT/CABLE indicator 52
SAT/CABLE power button 52
satellite receiver, using with TV remote control 56
setting up channels 49
Setup Menu 89
sharpness, adjusting 78
Simulated, Effect 80
sizing, picture in Twin View 64
slideshow 74
speakers
 turning on/off 81
 using external speakers 81
specifications 101
Standard mode 78
Steady Sound, described 14
Steady Sound, setting 80
Stereo, MTS setting 80
Stop button 53
SUBWOOFER OUT jack, described 18
surround sound 80

T, U

TIMER indicator 16, 17, 100
transport buttons 53
treble, adjusting 80
troubleshooting 96–100
TruSurround 80
TruSurround, Effect 80
turning on/off the TV 16, 17
TV indicator 52, 60
TV/VIDEO button 52, 60
Twin View
 described 14
 using 62–64
Twin View button 52

V

Variable audio setting 81
VCR
 using with TV remote control 56
 with cable box, connecting 32
 with cable, connecting 30
 with satellite receiver, connecting 38

Vertical Center, adjusting 83
Vertical Size 83
VHF/UHF jack, described 18
VIDEO (L/R)/AUDIO jacks, described 18
Video Menu 77, 78
Video modes, selecting 78
Vivid mode 78
VOL buttons 17, 52, 60

W, X, Y

Warm, Color Temperature 78
WIDE button 52
Wide Mode 82
Wide Screen, described 14
Wide Zoom mode, setting 82

Z

zoom feature, with Twin View 64
Zoom mode, setting 82

<http://www.sony.net/>



Printed on 100% recycled paper.

Printed in Japan