

JVC

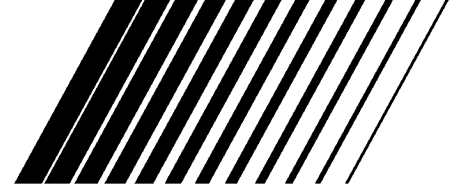

DVD DIGITAL THEATER SYSTEM

TH-A35

Consists of XV-THA35 and SP-THA35

TH-A32

Consists of XV-THA32 and SP-THA35

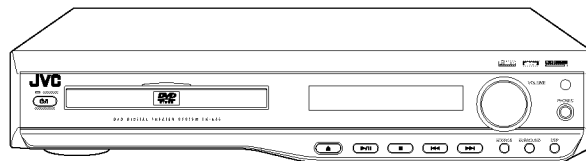
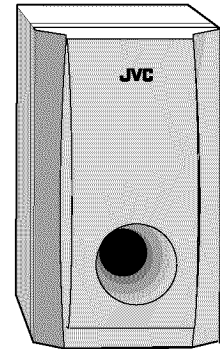

XV-THA35

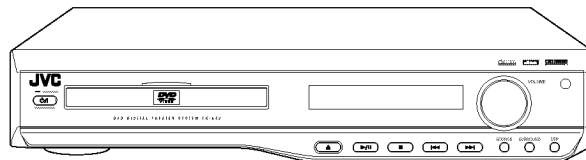

XV-THA32



INSTRUCTIONS

For Customer Use:

Enter below the Model No. and Serial No. which are located either on the rear, bottom or side of the cabinet. Retain this information for future reference.

Model No. _____

Serial No. _____

LVT1009-001C

[J]

Warnings, Cautions and Others

CAUTION

RISK OF ELECTRIC SHOCK
DO NOT OPEN

CAUTION: TO REDUCE THE RISK OF ELECTRIC SHOCK,
DO NOT REMOVE COVER (OR BACK)
NO USER SERVICEABLE PARTS INSIDE.
REFER SERVICING TO QUALIFIED SERVICE PERSONNEL.



The lightning flash with arrowhead symbol, within an equilateral triangle is intended to alert the user to the presence of uninsulated "dangerous voltage" within the product's enclosure that may be of sufficient magnitude to constitute a risk of electric shock to persons.



The exclamation point within an equilateral triangle is intended to alert the user to the presence of important operating and maintenance (servicing) instructions in the literature accompanying the appliance.

WARNING: TO REDUCE THE RISK OF FIRE OR ELECTRIC SHOCK, DO NOT EXPOSE THIS APPLIANCE TO RAIN OR MOISTURE.

CAUTION

To reduce the risk of electrical shocks, fire, etc.:

1. Do not remove screws, covers or cabinet.
2. Do not expose this appliance to rain or moisture.

Caution — STANDBY/ON switch!

Disconnect the mains plug to shut the power off completely. The STANDBY/ON switch in any position does not disconnect.

Note to CATV system installer:

This reminder is provided to call the CATV system installer's attention to Section 820-40 of the NEC which provides guidelines for proper grounding and, in particular, specifies that the cable ground shall be connected to the grounding system of the building, as close to the point of cable entry as practical.

For U.S.A.

This equipment has been tested and found to comply with the limits for a Class B digital device, pursuant to part 15 of the FCC Rules. These limits are designed to provide reasonable protection against harmful interference in a residential installation.

This equipment generates, uses and can radiate radio frequency energy and, if not installed and used in accordance with the instructions, may cause harmful interference to radio communications. However, there is no guarantee that interference will not occur in a particular installation. If this equipment does cause harmful interference to radio or television reception, which can be determined by turning the equipment off and on, the user is encouraged to try to correct the interference by one or more of the following measures:

- Reorient or relocate the receiving antenna.
 - Increase the separation between the equipment and receiver.
 - Connect the equipment into an outlet on a circuit different from that to which the receiver is connected.
 - Consult the dealer or an experienced radio/TV technician for help.

IMPORTANT FOR LASER PRODUCTS

1. CLASS 1 LASER PRODUCT
 2. **CAUTION:** Visible laser radiation when open and interlock failed or defeated. Avoid direct exposure to beam.
 3. **CAUTION:** Do not open the top cover. There are no user serviceable parts inside the Unit; leave all servicing to qualified service personnel.

Caution: Proper Ventilation

To avoid risk of electric shock and fire and to protect from damage.

Locate the apparatus as follows:

- Front: No obstructions open spacing.
 - Sides: No obstructions in 10 cm from the sides.
 - Top: No obstructions in 10 cm from the top.
 - Back: No obstructions in 15 cm from the back
 - Bottom: No obstructions, place on the level surface.

In addition, maintain the best possible air circulation as illustrated.

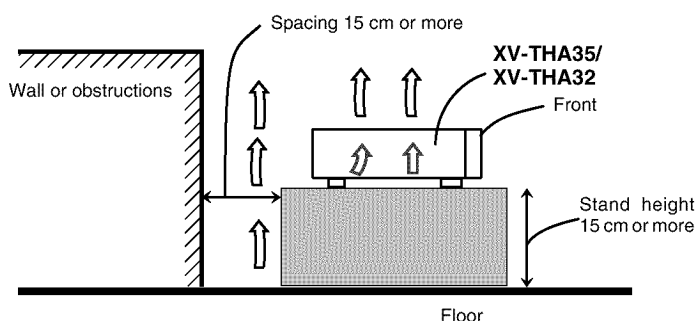
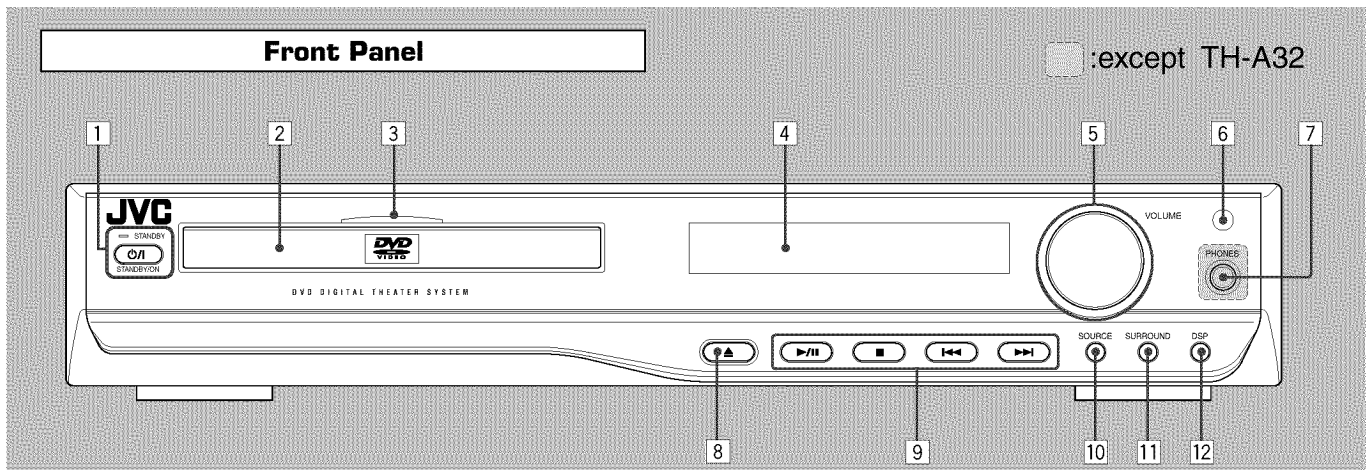

Table of Contents

Parts Identification	2	Moving to a Particular Portion Directly	28
Center Unit	2	Searching for a Particular Point	29
Remote Control	3	Repeating Playback	29
Getting Started	4	■ Repeat Play	29
Before Installation	4	■ A-B Repeat	29
Checking the Supplied Accessories	4	Playing Back Chapters in Random Order—Shuffle Play	30
Putting Batteries in the Remote Control	4	Programming the Playing Order of the Chapters	
Connecting the FM and AM Antennas	5	—Program Play	31
Speaker Layout Diagram	6	DVD Special Effect Playback	32
Connecting the Speakers	7	■ Still Picture/Frame-by-Frame Playback	32
Connecting Audio/Video Component	8	■ Slow Motion Playback	33
TV Setting	10	■ Zoom	33
Changing the Scanning Mode	11	VCD/CD Playback	34
Adjusting the Pictures	11	Showing the On-Screen Menu	34
Basic DVD Operations	12	Showing the Information on the TV Screen	34
1 Turn On the Power	12	Disc Menu-Driven Playback (Only for VCD)	35
2 Select the Source	12	Selecting Playback Channel	35
3 Load a DVD	12	Moving to a Particular Portion Directly	35
4 Start Playback	12	Searching for a Particular Point	36
5 Adjust the Volume	12	Repeating Playback	36
6 Activate Surround or DSP Mode	13	■ Repeat Play	36
7 Stop Playback	13	■ A-B Repeat	37
Basic VCD/CD Operations	14	Playing Back Tracks in Random Order—Shuffle Play	37
1 Turn On the Power	14	Programming the Playing Order of the Tracks	
2 Select the Source	14	—Program Play	38
3 Load a VCD/CD	14	VCD Special Effect Playback	39
4 Start Playback	14	■ Still Picture/Frame-by-Frame Playback	39
5 Adjust the Volume	14	■ Slow Motion Playback	39
6 Activate Surround or DSP Mode	15	■ Zoom	39
7 Stop Playback	15	MP3 Playback	40
Basic Tuner Operations	16	Starting Playback	41
1 Turn On the Power	16	Operations Using the On-Screen Display	42
2 Select the Band	16	Moving to a Particular Track Directly	42
3 Adjust the Volume	16	Programming the Playing Order of the Tracks	
4 Tune into a Station	16	—Program Play	42
5 Activate Surround or DSP Mode	17	JPEG Playback	44
Other Basic Operations	18	Loading the Disc	44
Enjoying Sounds from the External Component	18	Operations Using the On-Screen Display	45
Listening with the Headphones		Moving to a Particular File Directly	46
(not available with TH-A32)	19	Programming the Playing Order of the Files	
Adjusting the Brightness	19	—Program Play	46
Turning Off the Power with the Timer	20	Tuner Operations	48
Creating Realistic Sound Fields	21	Tuning in Stations	48
■ Dolby Surround	21	Using Preset Tuning	49
■ Dolby Digital	21	Selecting the FM Reception Mode	49
■ DTS Digital Surround	21	Setting up the DVD Preferences	50
■ DSP (Digital Signal Processor) Modes	22	Using the Choice Menus	50
Activating the Surround Mode	22	Language Menu	51
Adjusting the Sound	23	Picture Menu	52
Disc Introduction—DVD/VCD/CD	24	Audio Menu	53
Basic Disc Operations	25	Setting Menu	53
DVD Playback	26	Setting the Parental (Rating) Level	54
Showing the On-Screen Menu	26	Operating JVC's Components	56
Showing the Information on the TV Screen	26	Operating Other Manufacturers' TV	57
Selecting the Subtitles	27	Maintenance	58
Selecting the Audio Languages	27	Troubleshooting	59
Selecting the Multi-Angle Views	27	Specifications	60
Disc Menu-Driven Playback	28		

Parts Identification

Center Unit



See pages in the parentheses for details.

Front Panel

- | | |
|--------------------------------------------------------------------------------------------------------------------------------------------------------------------------------------------------------------------------------------------------------------------------------------------------------------------------------------------------------------------------------------------------------------------------------------------------------------------------------------------------------------------------------------------------------|---------------------------------------------------------------------------------------------------------------------------------------------------------------------------------------------------------------------------------------------------------------------------------------------------------------------------------------------------------------------------------------------------------------------------------------------------------------------------------------------------------------------------------|
| <ul style="list-style-type: none"> 1 STANDBY/ON \odot/I button and STANDBY lamp (12 – 17) 2 Disc tray (12, 14) 3 Illumination lamp 4 Display window 5 VOLUME control (12, 14, 16) 6 Remote sensor 7 PHONES jack (19) (except TH-A32) 8 \blacktriangle (open/close) button (12 – 15, 25, 41) <ul style="list-style-type: none"> • Pressing this button also turns on the power and changes the source to the DVD player. | <ul style="list-style-type: none"> 9 $\blacktriangleright/\text{II}$, \blacksquare, \blacktriangleleft, and \blacktriangleright buttons <ul style="list-style-type: none"> • Pressing $\blacktriangleright/\text{II}$ also turns on the power and changes the source to the DVD player. 10 SOURCE button (12, 14, 16, 18, 48) 11 SURROUND button (13, 15, 17, 19, 22) 12 DSP button (13, 15, 17, 19, 22) |
|--------------------------------------------------------------------------------------------------------------------------------------------------------------------------------------------------------------------------------------------------------------------------------------------------------------------------------------------------------------------------------------------------------------------------------------------------------------------------------------------------------------------------------------------------------|---------------------------------------------------------------------------------------------------------------------------------------------------------------------------------------------------------------------------------------------------------------------------------------------------------------------------------------------------------------------------------------------------------------------------------------------------------------------------------------------------------------------------------|

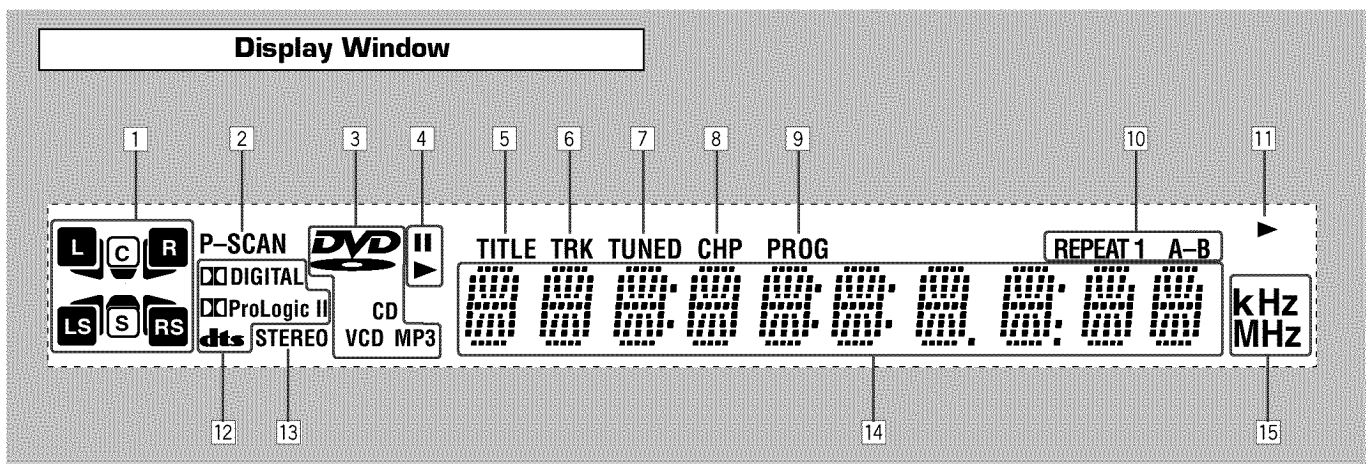

See pages in the parentheses for details.

Display Window

- | | |
|--------------------------------------------------------------------------------------------------------------------------------------------------------------------------------------------------------------------------------------------------------------------------------------------------------------------------------------------------------------------------------------------------------------------------------------------------------------------------------------------------------------------------------------------------------------------------------------------------------------------------------------------------|---------------------------------------------------------------------------------------------------------------------------------------------------------------------------------------------------------------------------------------------------------------------------------------------------------------------------------------------------------------------------------------------------------------------------------------------------------------------------------------------------------------------------------------------------------------------------------------------------------------------------------|
| <ul style="list-style-type: none"> 1 Audio channel indicators <ul style="list-style-type: none"> • Indicates audio channels currently source signal. 2 P-SCAN indicator (11) 3 Disc indicators (25) <ul style="list-style-type: none"> • DVD, CD, VCD, and MP3 4 Playback indicators <ul style="list-style-type: none"> • \blacktriangleright (play) and II (pause) 5 TITLE indicator (25) 6 TRK (track) indicator (25) 7 TUNED indicator (16, 48) 8 CHP (chapter) indicator (25) | <ul style="list-style-type: none"> 9 PROG (program) indicator (31, 38) 10 Repeat mode indicators (29, 30, 36, 37) <ul style="list-style-type: none"> • REPEAT, 1, and A-B 11 Sleep indicator (20) 12 Sound signal indicators (21, 22) <ul style="list-style-type: none"> • DIGITAL, PRO LOGIC II, and DTS 13 STEREO indicator (49) 14 Main display 15 Frequency unit indicators <ul style="list-style-type: none"> • MHz (for FM station) and kHz (for AM station) |
|--------------------------------------------------------------------------------------------------------------------------------------------------------------------------------------------------------------------------------------------------------------------------------------------------------------------------------------------------------------------------------------------------------------------------------------------------------------------------------------------------------------------------------------------------------------------------------------------------------------------------------------------------|---------------------------------------------------------------------------------------------------------------------------------------------------------------------------------------------------------------------------------------------------------------------------------------------------------------------------------------------------------------------------------------------------------------------------------------------------------------------------------------------------------------------------------------------------------------------------------------------------------------------------------|

Remote Control

Remote Control

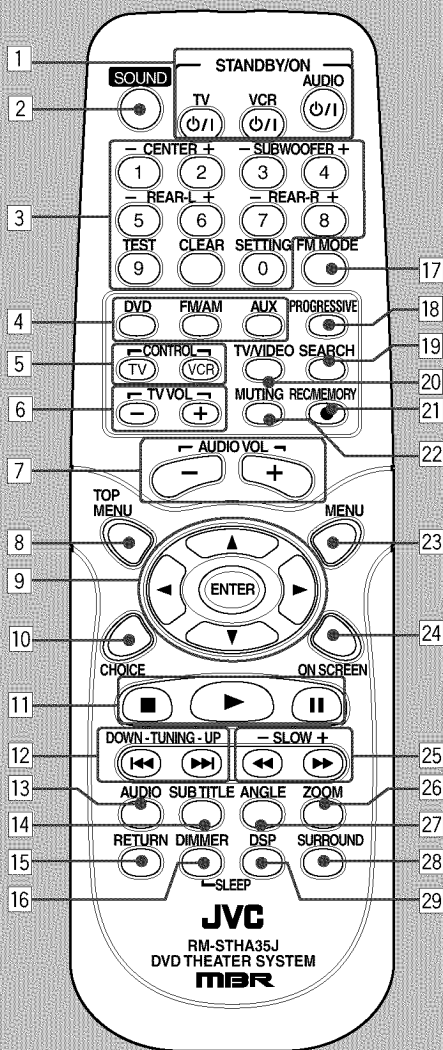

See pages in the parentheses for details.

- 1 STANDBY/ON buttons
 - TV \odot/I button (12, 14, 56, 57)
 - VCR \odot/I button (56)
 - AUDIO \odot/I button (12 – 17)
- 2 SOUND button (23)
- 3
 - Number buttons (25, 28, 30, 35, 38, 42, 43, 46, 47, 49, 55–57)
 - CLEAR button (28, 32, 35, 39, 52)
 - Sound setting buttons (23)
 - CENTER + and – buttons
 - SUBWOOFER + and – buttons
 - REAR-L + and – buttons
 - REAR-R + and – buttons
 - TEST button
 - SETTING button
- 4 Source selecting buttons (12, 14, 16, 18, 23, 48, 49)
 - DVD, FM/AM, AUX
 - *Pressing one of these buttons also turns on the power.*
- 5 CONTROL buttons
 - TV CONTROL button (56, 57)
 - VCR CONTROL button (56)
- 6 TV VOL + and – buttons (56, 57)
- 7 AUDIO VOL + and – buttons (12, 14, 16, 18)
- 8 TOP MENU button (28)
- 9 Menu operation buttons
 - cursor \blacktriangleright , \blacktriangleleft , \blacktriangleup , and \blacktriangledown buttons
 - ENTER button
- 10 CHOICE button (11, 50–54)
- 11 \blacksquare , \blacktriangleright , and II buttons
- 12 $\blacktriangleleft\blacktriangleleft$ and $\blacktriangleright\blacktriangleright$ buttons (25, 35, 41, 43, 45, 47, 56)
- 13 TUNING UP and DOWN buttons (16, 48)
- 14 AUDIO button (27)
- 15 SUB TITLE button (27)
- 16 RETURN button (35)
- 17 DIMMER button (19)
- 18 SLEEP button (20)
- 19 FM MODE button (49)
- 20 PROGRESSIVE button (11)
- 21 SEARCH button (28, 35)
- 22 TV/VIDEO button (56, 57)
- 23 REC/MEMORY button (49, 56)
- 24 MUTING button (13, 15, 16, 18)
- 25 MENU button (28, 35)
- 26 ON SCREEN button (26, 29– 32, 34, 36–39)
- 27 $\blacktriangleleft\blacktriangleleft$ and $\blacktriangleright\blacktriangleright$ buttons (29, 33, 36, 39, 49, 56, 57)
- 28 SLOW + and – buttons (33, 39)
- 29 ZOOM button (33, 39, 45, 47)
- 30 ANGLE button (27)
- 31 SURROUND button (13, 15, 17, 19, 22)
- 32 DSP button (13, 15, 17, 19, 22)

Getting Started

Before Installation

General Precautions

- DO NOT insert any metal object into the center unit.
- DO NOT disassemble the center unit or remove screws, covers, or cabinet.
- DO NOT expose the center unit to rain or moisture.

Locations

- Install the center unit in a location that is level and protected from moisture.
- The temperature around the center unit must be between 5°C and 35°C (41°F and 95°F).
- Make sure there is good ventilation around the center unit. Poor ventilation could cause overheating and damage the center unit.

Handling the center unit

- DO NOT touch the power cord with wet hands.
- DO NOT pull on the power cord to unplug the cord. When unplugging the cord, always grasp the plug so as not to damage the cord.
- Keep the power cord away from the connecting cords and the antennas. The power cord may cause noise or screen interference. It is recommended to use a coaxial cable for antenna connection, since it is well-shielded against interference.
- When a power failure occurs, or when you unplug the power cord, the preset settings such as preset FM/AM channels and sound adjustments may be erased in a few days.

Checking the Supplied Accessories

Check to be sure you have all of the following supplied accessories. The number in the parentheses indicates the quantity of the pieces supplied.

- **Remote Control (1)**
- **Batteries (2)**
- **AM Loop Antenna (1)**
- **FM Antenna (1)**
- **Video cord (1)**
- **Speaker cords**
 - 6 m (4)*: For left front speaker, right front speaker, center speaker, and subwoofer
 - 10 m (2)*: For left rear speaker and right rear speaker

* The lengths of the speaker cords above are approximate.

If anything is missing, contact your dealer immediately.

Putting Batteries in the Remote Control

Before using the remote control, put two supplied batteries first.

- When using the remote control, aim the remote control directly at the remote sensor on the center unit.

1. On the back of the remote control, remove the battery cover.

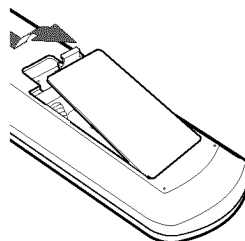

2. Insert batteries. Make sure to match the polarity: (+) to (+) and (-) to (-).

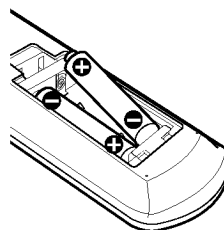

3. Replace the cover.

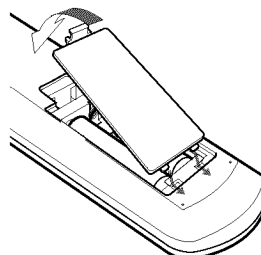

If the range or effectiveness of the remote control decreases, replace the batteries. Use two R6P (SUM-3)/AA(15F) type dry-cell batteries.

CAUTION:

Follow these precautions to avoid leaking or cracking cells:

- Place batteries in the remote control so they match the polarity: (+) to (+) and (-) to (-).
- Use the correct type of batteries. Batteries that look similar may differ in voltage.
- Always replace both batteries at the same time.
- Do not expose batteries to heat or flame.

Connecting the FM and AM Antennas

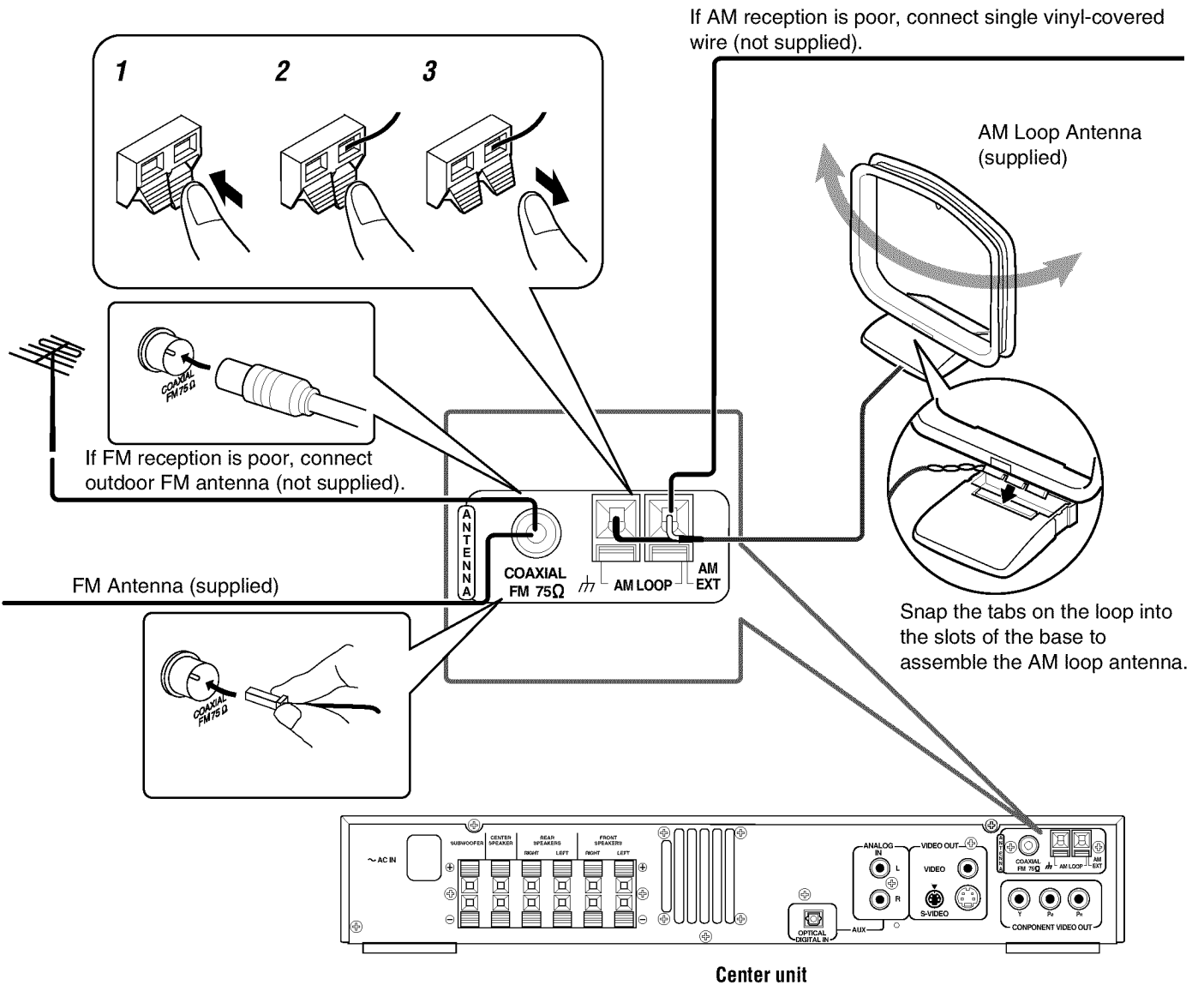

FM antenna connection

Connect the supplied FM antenna to the COAXIAL FM 75 Ω terminal as temporary measure.

Extend the supplied FM antenna horizontally.

- If reception is poor, connect an outdoor antenna.
Before attaching a 75 Ω coaxial cable (with a standard type connector), disconnect the supplied FM antenna.

AM antenna connection

Connect the supplied AM loop antenna to the AM LOOP terminals. Connect the white cord to the AM EXT terminal, and the black cord to \hbar terminal.

Turn the loop until you have the best reception.

- If reception is poor, connect an outdoor single vinyl-covered wire to the AM EXT terminal. (Keep the AM loop antenna connected.)

Note:

If the AM loop antenna wire is covered with vinyl, remove the vinyl by twisting it as shown in the diagram.



Getting Started

Speaker Layout Diagram

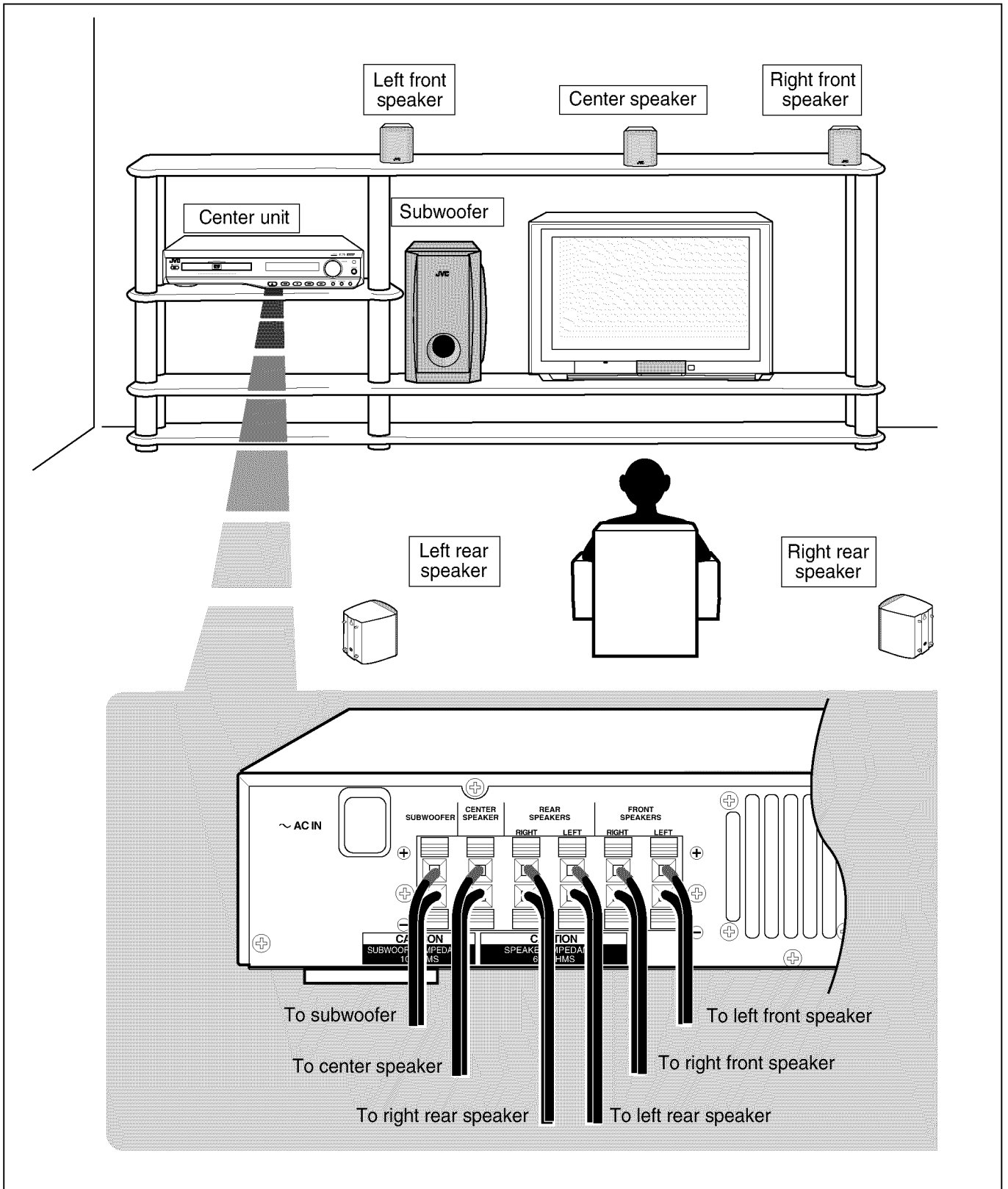

Connecting the Speakers

Connect the satellite speakers and subwoofer to the terminals on the rear panel using speaker cords supplied.

Color labels are attached to the speaker cords to indicate the speaker and the terminal to which each is to be connected.

- The five satellite speakers can be used for any positions—center, front left and right, and rear left and right.
- Connect the color labeled cord to the color (+) terminal, and the other cord to the black (–) terminal respectively.

CAUTION:

Use speakers with the SPEAKER IMPEDANCE indicated by the speaker terminals.

Connecting speaker cords to the terminals

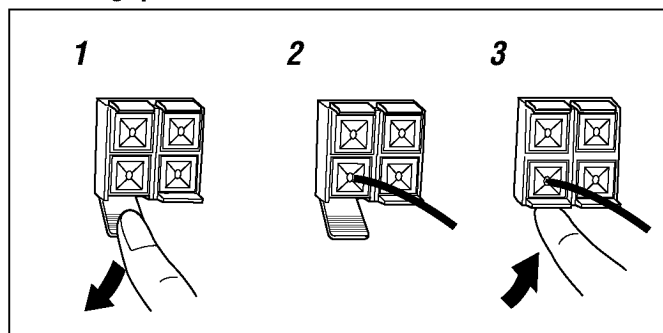

1 Open the terminal clamp.

2 Insert the speaker cord.

3 Close the clamp.

Notes:

- If the speaker cord is covered with vinyl, remove the vinyl by twisting it as shown in the diagram.
- Make sure the core wire of speaker cords do not expose to out of the terminals. This could cause short-circuit.



When setting the speakers

To obtain the best possible sound from this system, you need to place all the speakers except the subwoofer at the same distance from the listening position with each front faced toward the listener. Since bass sound is less-directional, but normally place it in between right and left front speaker shown as below.

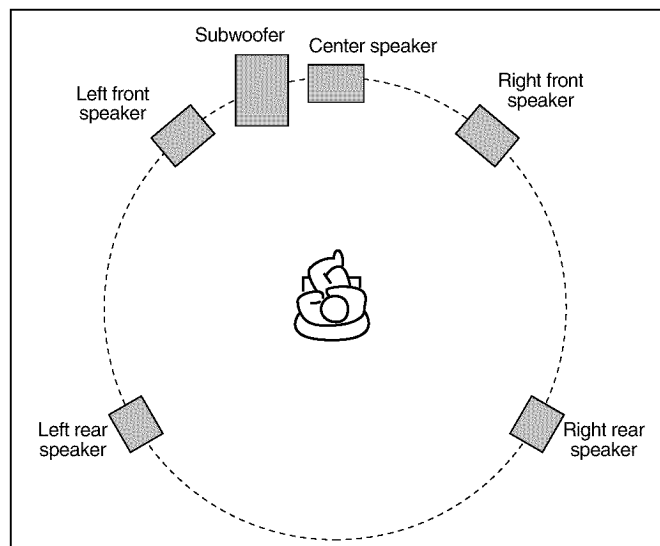

If your speakers cannot be placed at the same distance from the listening position

You can adjust the delay time of the center speaker and rear speakers. For in-depth information about adjusting the delay time, see “Setting Menu” on pages 53 and 54.

Note:

Subwoofer phase is closely related with the distance from the listening position to the front speakers and subwoofer. You can change the phase to obtain better bass sound by connecting the speaker cords to the terminals of the subwoofer inversely—the color labeled cord to the black terminal, and the black cord to the color terminal.

CAUTION:

- When attaching the satellite speakers on the wall, have them attached to the wall by a qualified person.
DO NOT attach the satellite speakers on the wall by yourself to avoid an unexpected damage of their falling from the wall, caused by incorrect attachment or weakness in the wall.
- Care is required in selecting a location for attaching speakers to the wall. Injury to personnel, or damage to equipment, may result if the speakers are attached in a location which interferes with daily activities.

Getting Started

Connecting Audio/Video Component

Turn the power off to all components before connections.

Audio Component connection

Connect the other component to the center unit with the audio cord.

Use the cords supplied with the other component or purchase them at an electric appliance store.

A Optical digital cord (not supplied)

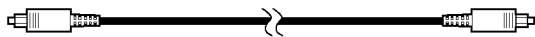

B Audio cord (not supplied)

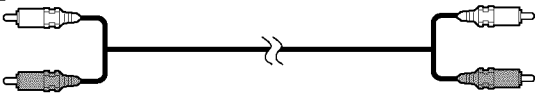

Illustrations of the input/output terminals below are typical examples.

When you connect the other component, refer also to its manuals since the terminal name actually printed on the rear vary among the components.

If you connect a sound-enhancing device such as a graphic equalizer between the source component and the center unit, the sound output through this system may be distorted.

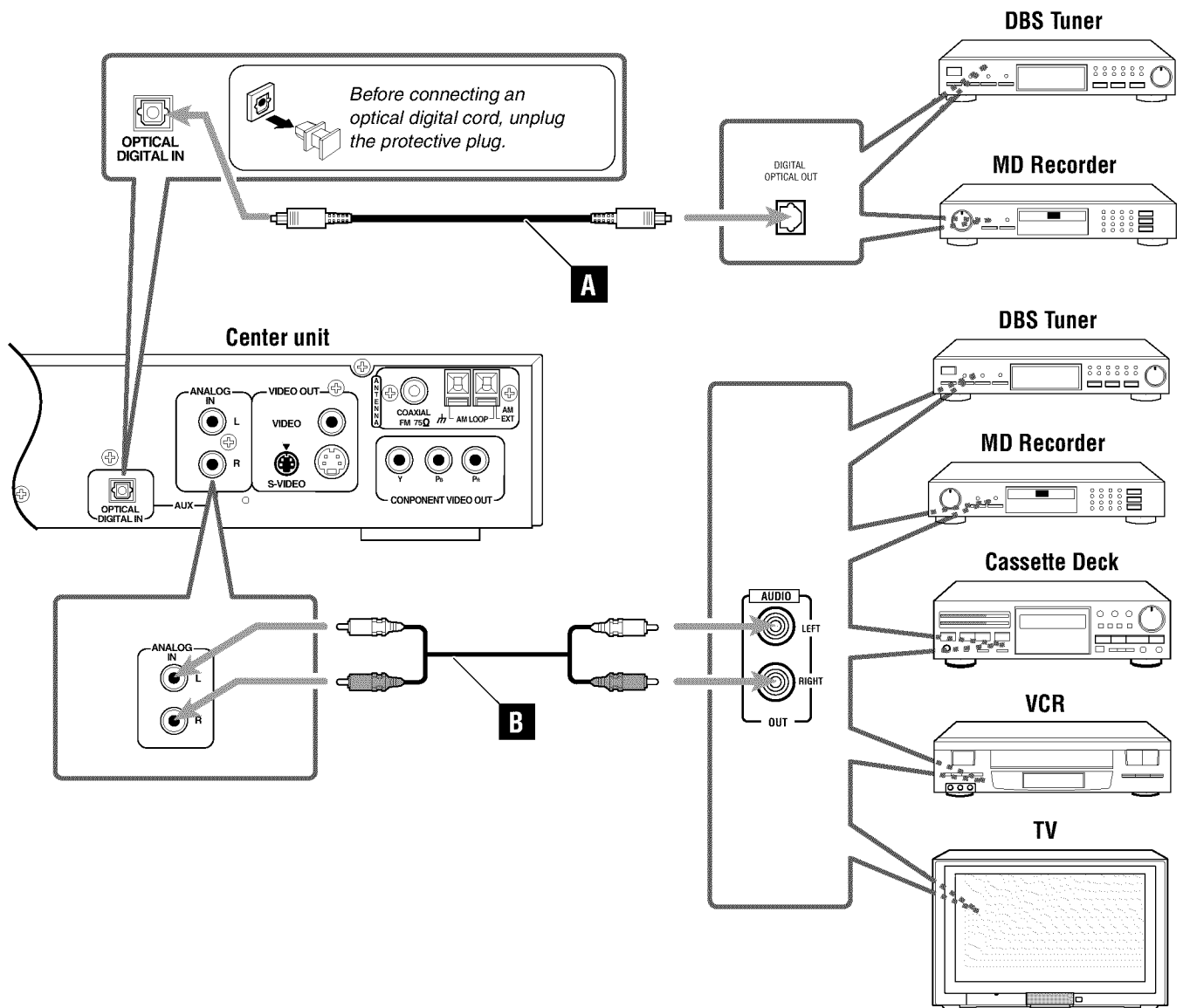

TV connection

The S-video cord and the component video cord are not supplied with this system.
Use the cords supplied with another components or purchase them at an electric appliance store.

A Video cord (supplied)



B S-video cord (not supplied)

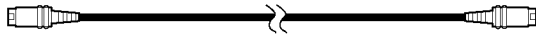

C Component video cord (not supplied)

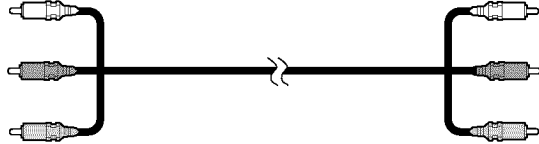

You can select one of three connection types—**A**, **B**, and **C**.

- If your TV has S-video (Y/C-separation) and/or component video (Y, Pb, Pr) jacks, connect them using an S-video cord (not supplied) **B** and/or component video cord (not supplied) **C**. By using these jacks, you can get a better picture quality—in the order : Component video > S-video > Composite video.
- If you use the S-video cord to connect the TV, you select the video signal type correctly. See "Picture Menu" on page 52.

- If your TV supports the progressive video input, you can enjoy a high quality picture by making the progressive scanning mode active (see page 11.)

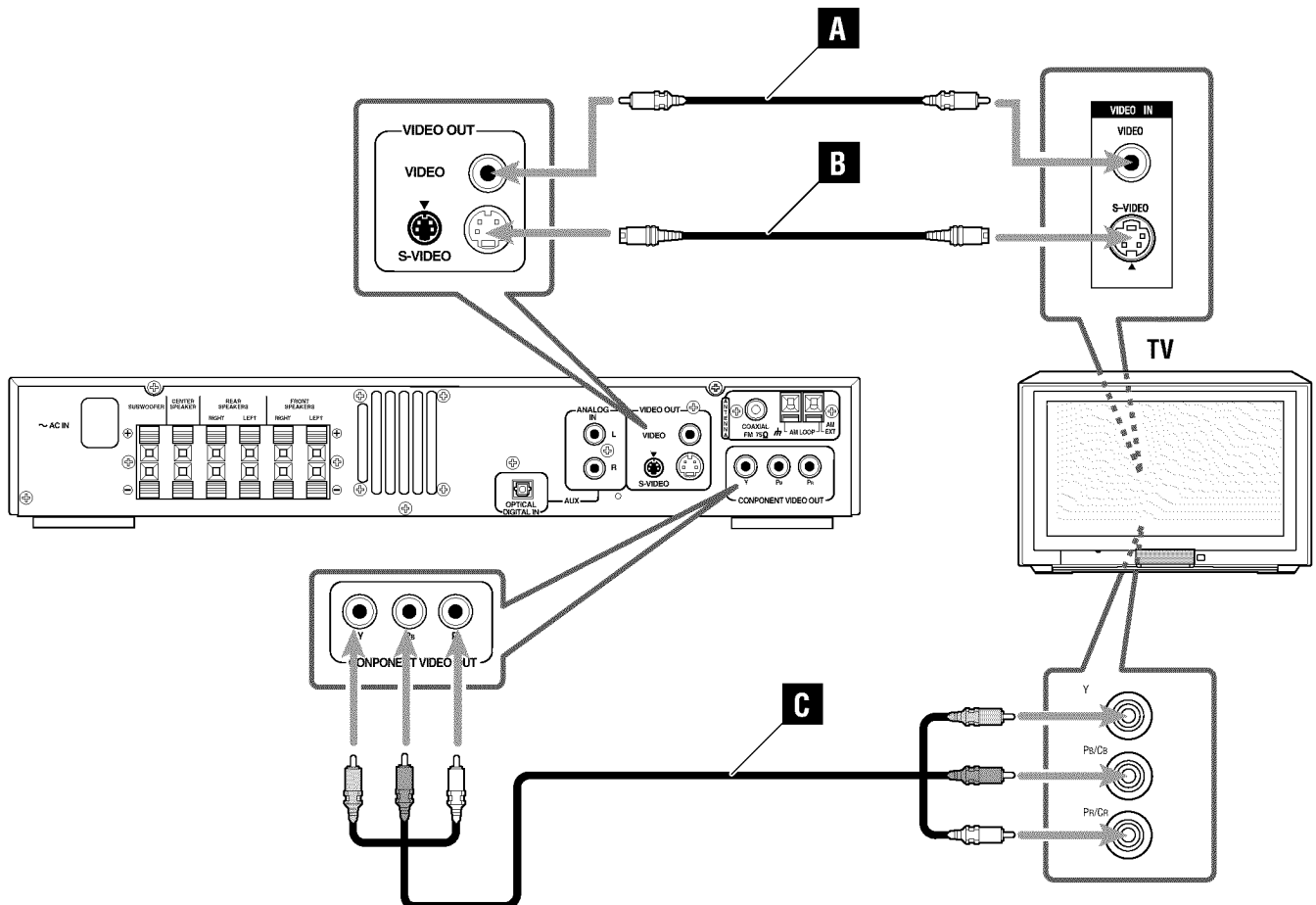

Now, you can plug the power cord of the center unit into the AC outlet.

Notes:

- Keep the power cord away from the connecting cords and the antenna cords. The power cord may cause noise or screen interference.
- Connecting to a TV through a VCR, or to a TV with a built-in VCR, may cause distortion of picture.

TV Setting

This system supports the progressive scanning system (480p*) as well as the conventional interlaced scanning system (480i*).

If your TV equipped with component video jacks supports the progressive video input, you can enjoy a high quality picture by activating the progressive scanning mode.

- Refer also to the instruction manuals supplied with your TV.
- If your TV equipped with component video jacks does not support the progressive video input, do not change the scanning mode to the progressive scanning mode (P-SCAN MODE.)

* 480p and 480i indicate the number of scanning lines and scanning format of a video signal.

- 480p indicates 480 scanning lines with progressive format.
- 480i indicates 480 scanning lines with interlaced format.

About scanning system

The conventional scanning method to display video signals on the TV screen is called "Interlaced scanning." With this method, only half of the horizontal lines (called a "field") are displayed at a time. So two fields complete a single picture (frame); i.e., the first field, containing all the odd-numbered lines, is followed by the second field, containing all the even-numbered lines.

On the other hand, the Progressive scanning system scans all horizontal lines at a time, so you can double the number of scanning lines displayed at a time, resulting in a flicker-free, high-density picture.

To enjoy the progressive scanned picture, a monitor (or TV or projector) connected to the system must support the progressive video inputs.

Depending on the material source format, DVD video can be classified into two types; film source and video source (note that some DVD video contain both film source and video source). Film sources are recorded as 24-frame-per-second data, while (NTSC) video sources are recorded as 30-frame-per-second (60-field-per-second interlaced).

When this system plays back a film source data, uninterlaced progressive output signals are created using the original data. When a video source is played back, the unit interleaves lines between the interlaced lines to create the pseudo uninterlaced picture and outputs as the progressive signals.

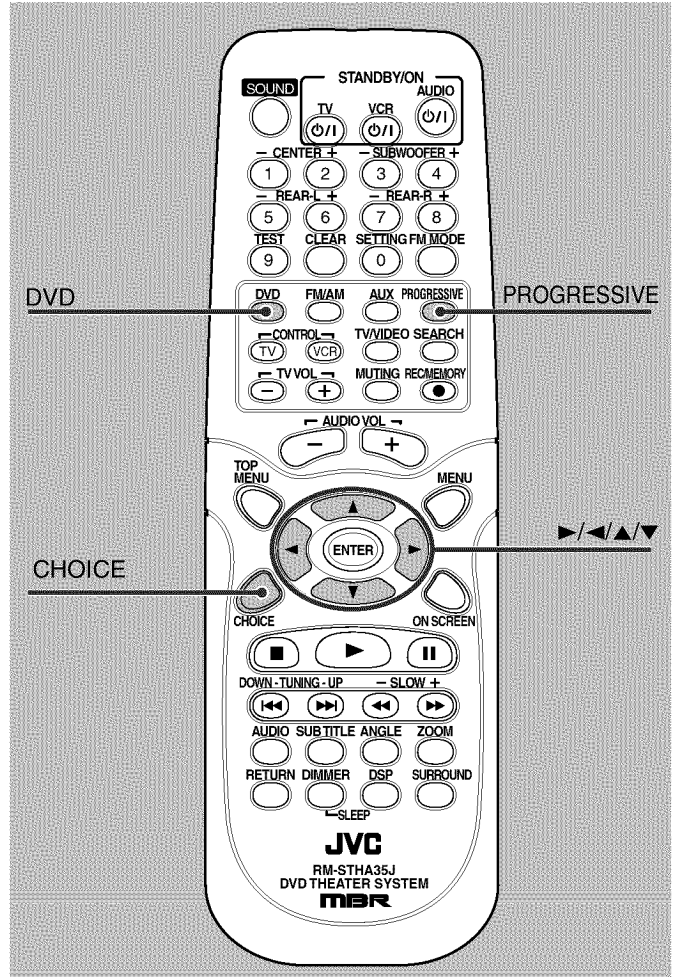

Changing the Scanning Mode

You can select the scanning mode if your TV equipped with component video jacks supports the progressive video input.

From the remote control ONLY:

1 Press DVD.



2 Press PROGRESSIVE.

- Each time you press the button, the scanning mode alternates between "INTERLACE" and "P-SCAN."



INTERLACE:

Select this if your TV does not support the progressive video input (conventional TV).

P (Progressive)–SCAN:

Select this if your TV equipped with component video jacks supports the progressive video input.

When you select the "P-SCAN", P-SCAN indicator lights up on the display.

Notes:

- If you press *PROGRESSIVE* while playing back a disc, playing back stops.
- Some progressive TVs and High-Definition TVs are not fully compatible with this system, resulting in the unnatural picture when playing back a DVD in the progressive scanning mode. In such a case, change the scanning mode to "INTERLACE." To check the compatibility of your TV, contact your local JVC customer service center.
- All JVC progressive TVs and High-Definition TVs are fully compatible with this system.

Adjusting the Pictures

You can adjust parameters that affect the appearance of picture.

From the remote control ONLY:

1 Press CHOICE while playing back a disc.

Video Enhance menu appears on TV-screen.



2 Press cursor ▲/▼ repeatedly to select a parameter you want to adjust.

- Adjust gradually to show preferable appearance by confirming the picture.

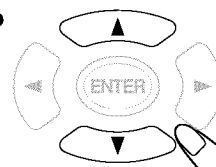

Brightness: Controls the brightness of the screen.

Edges: Controls the sharpness of the screen.

Color: Controls the color of the screen.

Contrast: Controls the contrast of the screen.

3 Press cursor ►/◄ repeatedly to change the setting.

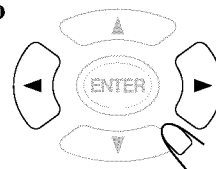

4 Press CHOICE.

Video Enhance menu disappears.



Note:

If you turn off the unit, the video enhance setting return to initial setting.

Basic DVD Operations

This manual mainly explains operations using the buttons on the remote control. You can also use the buttons on the center unit if they have the similar names (or marks) as those on the remote control. If operations using the center unit are different from those using the remote control, they are then explained.

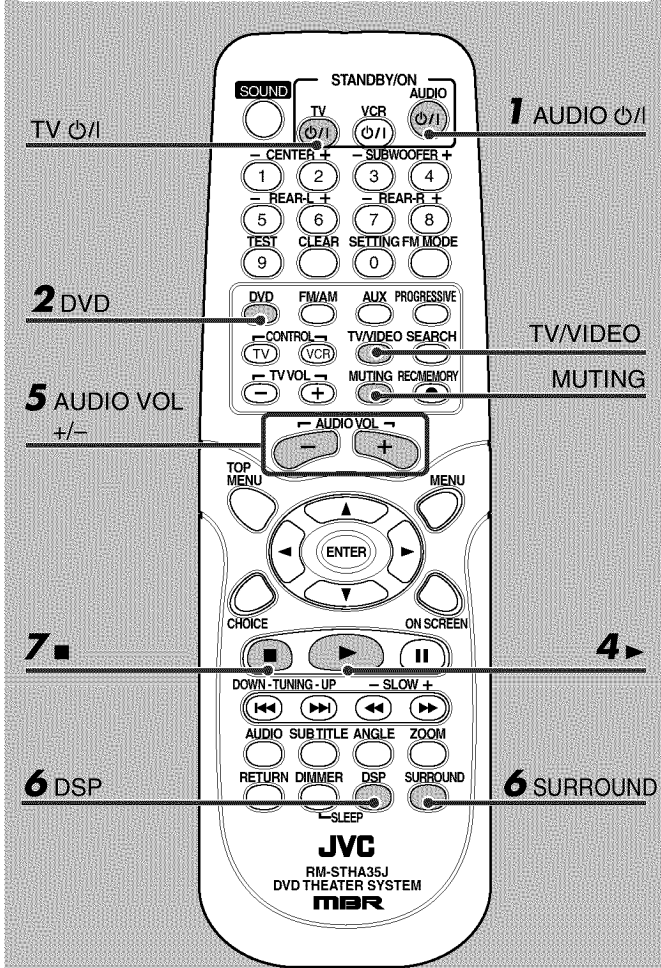

• For in-depth information about DVD operations, see pages 24 to 33.

1 Turn On the Power

Before turning on the system, turn on your TV and select the correct video input. (See the manual supplied with your TV.)

- When you use a JVC's TV, you can turn on your TV by pressing TV $\odot/|$ on the remote control, and select the video input by pressing TV/VIDEO. (If your TV is not a JVC's, see "Operating Other Manufacturers' TV" on page 57.)
- For changing the OSD messages—the information on the TV screen—into the desired language, see "Language Menu" on pages 51.

Press AUDIO $\odot/|$ (or $\odot/|$ STANDBY/ON on the front panel).

The STANDBY lamp goes off and the illumination lamp on the center unit lights up. The source indication selected previously appears on the display.



2 Select the Source

Press DVD.

The source changes to DVD.



3 Load a DVD

On the front panel ONLY:

Press \blacktriangle to open the disc tray, then place a DVD correctly with its label side up.

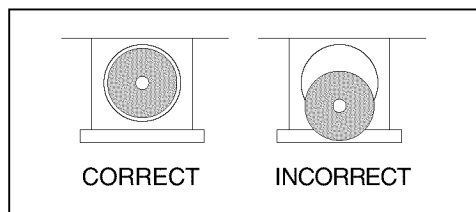

- DO NOT use the disc stabilizer.

4 Start Playback

Press \blacktriangleright .

The disc tray closes. "READING" appears for a while.



- You can also start playback by closing the disc tray using \blacktriangle on the front panel.

5 Adjust the Volume

From the remote control :

To increase the volume, press and hold AUDIO VOL +.

To decrease the volume, press and hold AUDIO VOL -.



On the front panel :

To increase the volume, turn VOLUME control clockwise.

To decrease the volume, turn VOLUME control counterclockwise.



CAUTION:

Always set the volume to the minimum before starting any source. If the volume is set at its high level, the sudden blast of sound energy can permanently damage your hearing and/or ruin your speakers.

Notes:

- By pressing AUDIO VOL + or - repeatedly, you can adjust the volume level step by step.
- The volume level can be adjusted within 64 steps—"MIN (minimum)," 01 to 62, and "MAX (maximum)."
- If you have turned off the unit with the volume level set at more than level "25," the volume level will be automatically set at level "25" next time you turn on the unit.

To turn off the sounds temporarily

From the remote control ONLY:

Press **MUTING**.



To restore the sound, press **MUTING** again.

- Pressing **AUDIO VOL +** or **-** also restores the sound.

6 Activate Surround or DSP Mode

You can enjoy three kinds of surround—Digital Multichannel Surround (Dolby Digital and DTS Digital Surround), Dolby Pro Logic II and DSP modes.

Digital Multichannel Surround—Dolby Digital and DTS Digital Surround

Dolby Digital or DTS Digital Surround takes effect only when you enjoy a disc encoded with its signals.

To activate Dolby Digital or DTS Digital Surround

When a disc encoded with the Dolby Digital or DTS Digital Surround is loaded, the system detects it and starts playing the disc automatically with Multichannel Surround activated.

- For in-depth information about surround modes, see “Creating Realistic Sound Fields” on pages 21 to 22.

Dolby Pro Logic II—Pro Logic II Music and Pro Logic II Movie

To activate Pro Logic II modes

Press **SURROUND**.

The current Pro Logic II mode appears on the display for a while.

- Each time you press the button, Pro Logic II mode changes as follows:

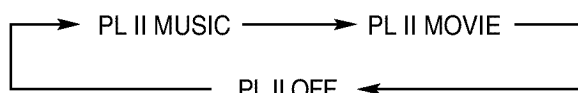

- When Dolby Pro Logic II mode is activated, the **PRO LOGIC II** indicator lights up on the display.

- For in-depth information about Dolby Pro Logic II modes, see “Creating Realistic Sound Fields” on pages 21 to 22.

DSP modes—CONCERT, STADIUM, HALL, THEATER, LIVE HOUSE

To activate DSP modes

Press **DSP**.

The current DSP mode appears on the display for a while.

- Each time you press the button, DSP mode changes as follows:

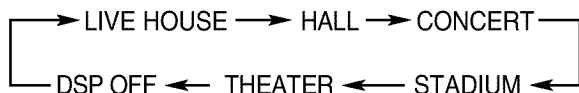

- For in-depth information about DSP modes, see “Creating Realistic Sound Fields” on pages 21 to 22.

Note:

Before activating the Surround or DSP mode, adjust the speaker setting to bring out the best performance from this system.

For in-depth information about adjusting the speaker setting, see “Setting Menu” on pages 53.

7 Stop Playback

Press **■** twice.

Playback stops completely.

- This system can memorize the end point even when you press **■** once. When you start playback again by pressing **▶**, playback begins from where it has been stopped—Resume play.



To remove the loaded disc

Press **▲**.

“OPEN” appears on the display and the disc tray comes out.



To close the disc tray, press **▲** again.

To prohibit disc ejection

On the front panel ONLY:

Press and hold **▶/||** and **◀◀** for more than 3 seconds.

“LOCKED” appears on the display, and the disc tray is locked.



To cancel the prohibition, press and hold **▶/||** and **◀◀** for more than 3 seconds.

“UNLOCK” appears on the display, and the disc tray is unlocked.



To turn off the power (into standby)

Press **AUDIO** (or **○/I** **STANDBY/ON** on the front panel).

The illumination lamp goes off and the **STANDBY** lamp lights up.

- If you press **AUDIO** (or **○/I** **STANDBY/ON** on the front panel) while the disc tray is kept open, the disc tray closes automatically, then the system is turned off.
- A small amount of power is consumed even in standby mode. To turn the power off completely, unplug the AC power cord.



Basic VCD/CD Operations

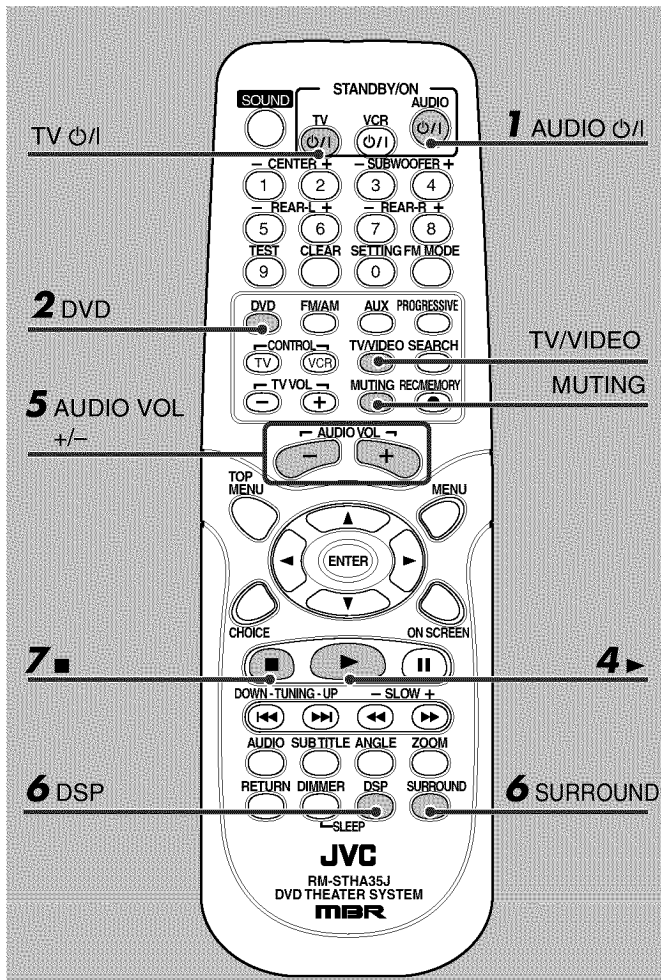

- SVCD can be operated by using the VCD operation procedure.
- For in-depth information about VCD/CD operations, see pages 24, 25, and 34 to 39.

1 Turn On the Power

Before turning on the system, turn on your TV if necessary and select the correct video input. (See the manual supplied with your TV.)

- When you use a JVC's TV, you can turn on your TV by pressing TV \odot/I on the remote control, and select the video input by pressing TV/VIDEO. (If your TV is not a JVC's, see "Operating Other Manufacturers' TV" on page 57.)
- For changing the OSD messages—the information on the TV screen—into the desired language, see "Language Menu" on pages 51.

Press AUDIO \odot/I

(or \odot/I /STANDBY/ON on the front panel).

The STANDBY lamp goes off and the illumination lamp on the center unit lights up. The source indication selected previously appears on the display.



2 Select the Source

Press DVD.



3 Load a VCD/CD

On the front panel ONLY:

Press \blacktriangle to open the disc tray, then place a disc correctly with its label side up.

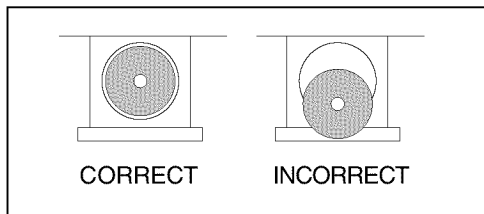

- When using a CD single (8 cm), place it on the inner circle of the disc tray.
- Continued use of irregular shape CDs (heart-shape, octagonal, etc.) can damage the center unit.
- DO NOT use the disc stabilizer.

4 Start Playback

Press \blacktriangleright .

The disc tray closes. "READING" appears for a while.

- You can also start playback by closing the disc tray using \blacktriangle on the front panel.



5 Adjust the Volume

From the remote control :

To increase the volume, press and hold AUDIO VOL +.

To decrease the volume, press and hold AUDIO VOL -.



On the front panel :

To increase the volume, turn VOLUME control clockwise.

To decrease the volume, turn VOLUME control counterclockwise.



CAUTION:

Always set the volume to the minimum before starting any source. If the volume is set at its high level, the sudden blast of sound energy can permanently damage your hearing and/or ruin your speakers.

Notes:

- By pressing AUDIO VOL + or - repeatedly, you can adjust the volume level step by step.
- The volume level can be adjusted within 64 steps—"MIN (minimum)," 01 to 62 and "MAX (maximum)."
- If you have turned off the unit with the volume level set at more than level "25," the volume level will be automatically set at level "25" next time you turn on the unit.

To turn off the sounds temporarily

From the remote control ONLY:

Press **MUTING**.



To restore the sound, press **MUTING** again.

- Pressing **AUDIO VOL +** or **-** also restores the sound.

6 Activate Surround or DSP Mode

You can enjoy Dolby Pro Logic II mode and DSP modes.

Dolby Pro Logic II—Pro Logic II Movie and Pro Logic II Music

To activate Pro Logic II modes

Press **SURROUND**.

The current Pro Logic II mode appears on the display for a while.



- Each time you press the button, Pro Logic II mode changes as follows:

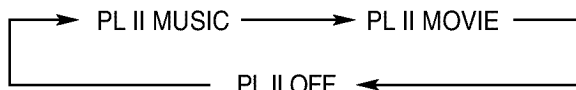

- When Dolby Pro Logic II mode is activated, the **PRO LOGIC II** indicator lights up on the display.

– For in-depth information about Dolby Pro Logic II modes, see “Creating Realistic Sound Fields” on pages 21 to 22.

DSP modes—CONCERT, STADIUM, HALL, THEATER, LIVE HOUSE

DSP modes take effect only when you enjoy a disc recorded using Linear PCM.

To activate DSP modes

Press **DSP**.

The current DSP mode appears on the display for a while.



- Each time you press the button, DSP mode changes as follows:

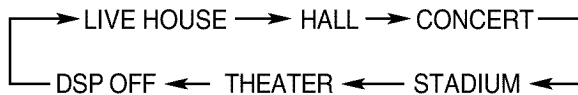

– For in-depth information about DSP modes, see “Creating Realistic Sound Fields” on pages 21 to 22.

Note:

Before activating the Surround or DSP mode, adjust the speaker setting to bring out the best performance from this system. For in-depth information about adjusting the speaker setting, see “Setting Menu” on pages 53.

7 Stop Playback

Press **■** twice.

Playback stops completely.



- This system can memorize the end point even when you press **■** once. When you start playback again by pressing **▶**, playback begins from where it has been stopped—Resume play.

To remove the loaded disc

Press **▲**.

“OPEN” appears on the display and the disc tray comes out.



To close the disc tray, press **▲** again.

To prohibit disc ejection

On the front panel ONLY:

Press and hold **▶/||** and **◀◀** for more than 3 seconds.



“LOCKED” appears on the display, and the disc tray is locked.

To cancel the prohibition, press and hold **▶/||** and **◀◀** for more than 3 seconds.



“UNLOCK” appears on the display, and the disc tray is unlocked.

To turn off the power (into standby)

Press **AUDIO** (or

○/| STANDBY/ON on the front panel).



The illumination lamp goes off and the **STANDBY** lamp lights up.

- If you press **AUDIO** (or **○/| STANDBY/ON** on the front panel) while the disc tray is kept open, the disc tray closes automatically, then the system is turned off.
- A small amount of power is consumed even in standby mode. To turn the power off completely, unplug the AC power cord.

Basic Tuner Operations

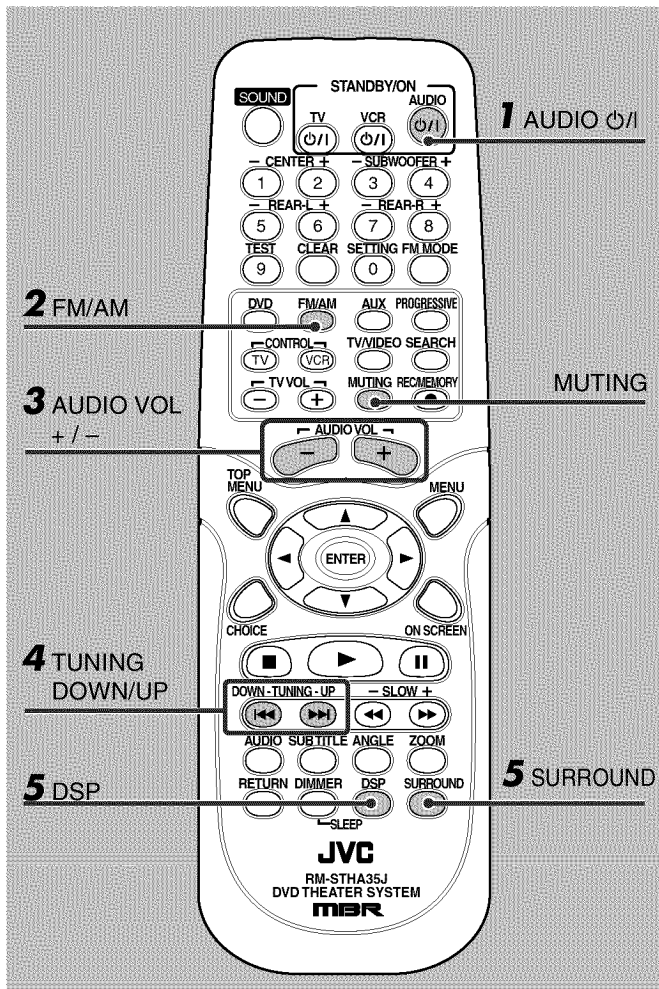

For in-depth information about tuner operations, see "Tuner Operations" on pages 48 to 49.

1 Turn On the Power

Press **AUDIO ON/OFF** (or **ON/OFF/STANDBY/ON** on the front panel).
The **STANDBY** lamp goes off and the illumination lamp lights up on the center unit.
The source indication selected previously appears on the display.



2 Select the Band

From the remote control:

Press **FM/AM**.

The last received station of the selected band is tuned into.

- Each time you press the button, the band alternates between FM and AM.



On the front panel:

Press **SOURCE** repeatedly until the desired band (**TUNER FM** or **TUNER AM**) appears on the display.

The last received station of the selected band is tuned into.

- Each time you press the button, the source changes as follows:



3 Adjust the Volume

From the remote control:

To increase the volume, press and hold **AUDIO VOL +**.

To decrease the volume, press and hold **AUDIO VOL -**.



On the front panel:

To increase the volume, turn **VOLUME** control clockwise.

To decrease the volume, turn **VOLUME** control counterclockwise.

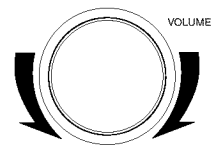

CAUTION:

Always set the volume to the minimum before starting any source. If the volume is set at its high level, the sudden blast of sound energy can permanently damage your hearing and/or ruin your speakers.

Notes:

- By pressing **AUDIO VOL +** or **-** repeatedly, you can adjust the volume level step by step.
- The volume level can be adjusted within 64 steps— "MIN (minimum)," 01 to 62 and "MAX (maximum)."
- If you have turned off the unit with the volume level set at more than level "25," the volume level will be automatically set at level "25" next time you turn on the unit.

To turn off the sounds temporarily

From the remote control ONLY:

Press **MUTING**.

To restore the sound, press **MUTING** again.

- Pressing **AUDIO VOL +** or **-** also restores the sound.



4 Tune into a Station

From the remote control:

Press and hold **TUNING UP** or **DOWN** until the station frequency starts changing continuously on the display.



The system starts searching for a station.

When a station of sufficient signal strength is tuned in, the system stops searching, and the **TUNED** indicator lights up on the display.

On the front panel:

Press and hold **◀◀** or **▶▶** until the station frequency starts changing continuously on the display.

Notes:

- When an FM stereo program is received, the STEREO indicator also lights up.
- When you press the button repeatedly, the frequency changes step by step.

5 Activate Surround or DSP Mode

You can enjoy Dolby Pro Logic II mode and DSP modes.

Dolby Pro Logic II—Pro Logic II Movie and Pro Logic II Music

To activate Pro Logic II modes

Press **SURROUND**.

The current Pro Logic II mode appears on the display for a while.



- Each time you press the button, Pro Logic II mode changes as follows:

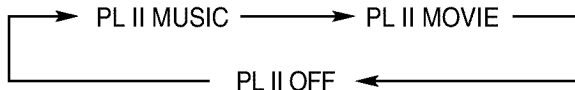

- When Dolby Pro Logic II mode is activated, the **PRO LOGIC II** indicator lights up on the display.

– For in-depth information about Dolby Pro Logic II modes, see “Creating Realistic Sound Fields” on pages 21 to 22.

DSP modes—CONCERT, STADIUM, HALL, THEATER, LIVE HOUSE

To activate DSP modes

Press **DSP**.

The current DSP mode appears on the display for a while.



- Each time you press the button, DSP mode changes as follows:

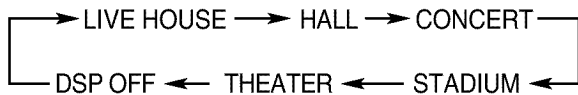

– For in-depth information about DSP modes, see “Creating Realistic Sound Fields” on pages 21 to 22.

Note:

Before activating the Surround or DSP mode, adjust the speaker setting to bring out the best performance from this system. For in-depth information about adjusting the speaker setting, see “Setting Menu” on pages 53.

To turn off the power (into standby)



Press **AUDIO**  (or **STANDBY/ON** on the front panel) again.

The illumination lamp goes off and the STANDBY lamp lights up.

- A small amount of power is consumed even in standby mode. To turn the power off completely, unplug the AC power cord.

Other Basic Operations

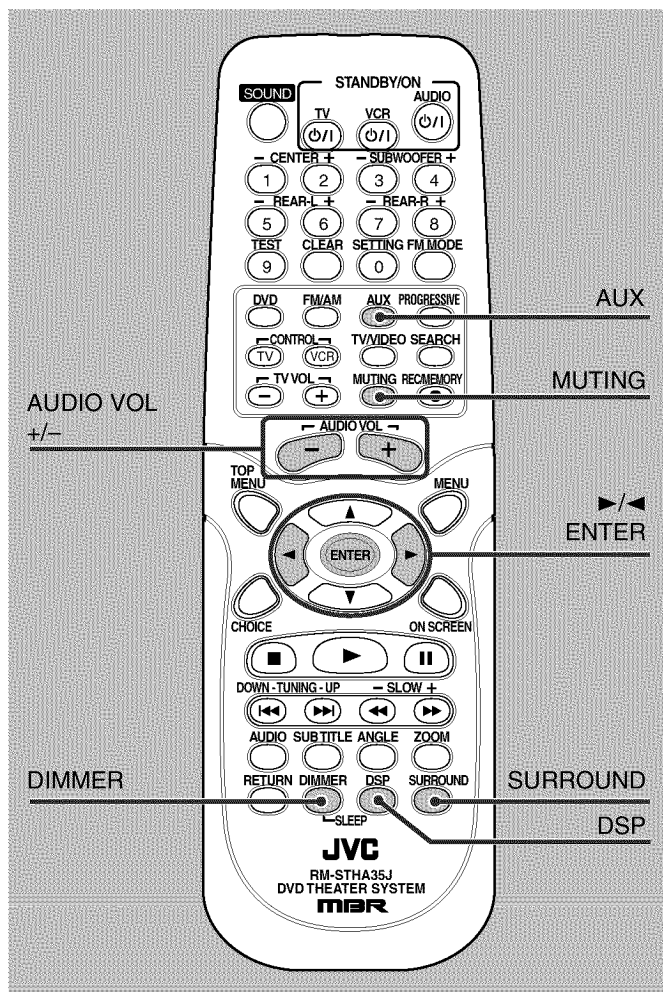

Enjoying Sounds from the External Component

You can enjoy sounds from the external equipment connected to the OPTICAL DIGITAL IN terminal or ANALOG IN jacks on the rear panel of the center unit.

1 Select AUX as the source.

From the remote control:

Press **AUX**.

- Each time you press the button, the source changes as follows:

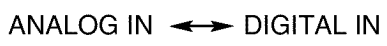

ANALOG IN : Select this to enjoy the external equipment connected to the ANALOG IN jacks.

DIGITAL IN : Select this to enjoy the external equipment connected to the OPTICAL DIGITAL IN terminal.

On the front panel:

Press **SOURCE** repeatedly until “ANALOG IN” or “DIGITAL IN” appears on the display.

- Each time you press the button, the source changes as follows:

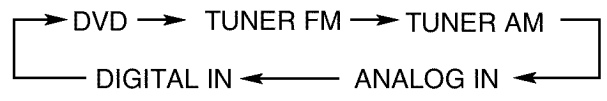
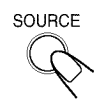

2 Start playback on the external equipment.

- For in-depth information about the external equipment, see the manual supplied for it

3 Adjust the Volume

From the remote control :

To increase the volume, press and hold **AUDIO VOL +**.

To decrease the volume, press and hold **AUDIO VOL -**.

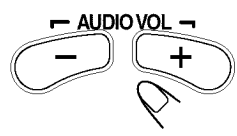

On the front panel :

To increase the volume, turn **VOLUME** control clockwise.

To decrease the volume, turn **VOLUME** control counterclockwise.

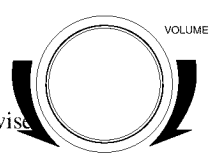

CAUTION:

Always set the volume to the minimum before starting any source. If the volume is set at its high level, the sudden blast of sound energy can permanently damage your hearing and/or ruin your speakers.

Notes:

- By pressing **AUDIO VOL +** or **-** repeatedly, you can adjust the volume level step by step.
- The volume level can be adjusted within 64 steps—“MIN (minimum),” 01 to 62 and “MAX (maximum).”
- If you have turned off the unit with the volume level set at more than level “25,” the volume level will be automatically set at level “25” next time you turn on the unit.

To turn off the sounds temporarily

From the remote control ONLY:

Press **MUTING**.



To restore the sound, press **MUTING** again.

- Pressing **AUDIO VOL +** or **-** also restores the sound.

4 Activate Surround or DSP Mode

You can enjoy three kinds of surround—Digital Multichannel Surround (Dolby Digital and DTS Digital Surround), Dolby Pro Logic II and DSP modes.

Digital Multichannel Surround—Dolby Digital and DTS Digital Surround

You can enjoy Dolby Digital or DTS Digital Surround when you playback Multichannel source on the external equipment.

To activate Dolby Digital or DTS Digital Surround

When playback source is encoded with Dolby Digital or DTS Digital Surround, the system detects it and activate Multichannel Surround automatically.

– For in-depth information about surround modes, see “Creating Realistic Sound Fields” on pages 21 to 22.

Dolby Pro Logic II—Pro Logic II Music and Pro Logic II Movie

To activate Pro Logic II modes

Press **SURROUND**.

The current Pro Logic II mode appears on the display for a while.

- Each time you press the button, Pro Logic II mode changes as follows:

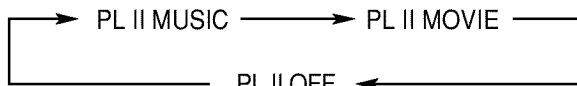

- When Dolby Pro Logic II mode is activated, the  PRO LOGIC II indicator lights up on the display.

– For in-depth information about Dolby Pro Logic II modes, see “Creating Realistic Sound Fields” on pages 21 to 22.

DSP modes—CONCERT, STADIUM, HALL, THEATER, LIVE HOUSE

To activate DSP modes

Press **DSP**.

The current DSP mode appears on the display for a while.

- Each time you press the button, DSP mode changes as follows:

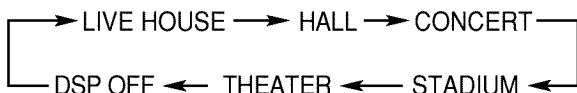

– For in-depth information about DSP modes, see “Creating Realistic Sound Fields” on pages 21 to 22.

Notes:

- On some source signals, no sounds come out from the subwoofer.
- Before activating the Surround or DSP mode, adjust the speaker setting to bring out the best performance from this system. For in-depth information about adjusting the speaker setting, see “Setting Menu” on pages 53.

Listening with the Headphones (not available with TH-A32)

You can enjoy the sound with headphones.

Connect a pair of headphones to the PHONES jack on the front panel. The speakers are deactivated and you can listen the sound with the headphones.

- Disconnecting a pair of headphones from the PHONES jack activate speakers.

CAUTION:

Be sure to turn down the volume:

- Before connecting or putting on headphones, as high volume can damage both the headphones and hearing.
- Before removing headphones, as high volume may output from the speakers.

Adjusting the Brightness

You can dim the indications on the display window and the illumination lamps on the center unit.

There is a time limit in doing the following steps. If the setting is canceled before you finish, start from step 1 again.

From the remote control ONLY:

- 1 Press **DIMMER** repeatedly until “DIMMER (with the current setting)” appears on the display.

- Each time you press the button, the indication in the main display changes as follows:

DIMMER* ← → SLEEP**

* With the current level is shown.

** With the remaining time is shown.

- 2 Press cursor **▶/◀** to adjust the brightness level.

- The brightness level changes as follows:

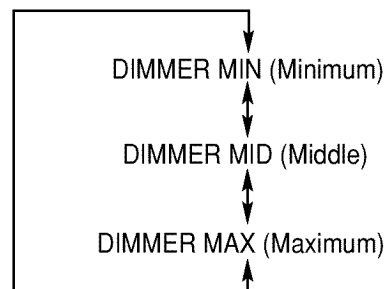

- 3 Press **ENTER**.

“OK” appears on the display and the brightness level changes.

Other Basic Operations

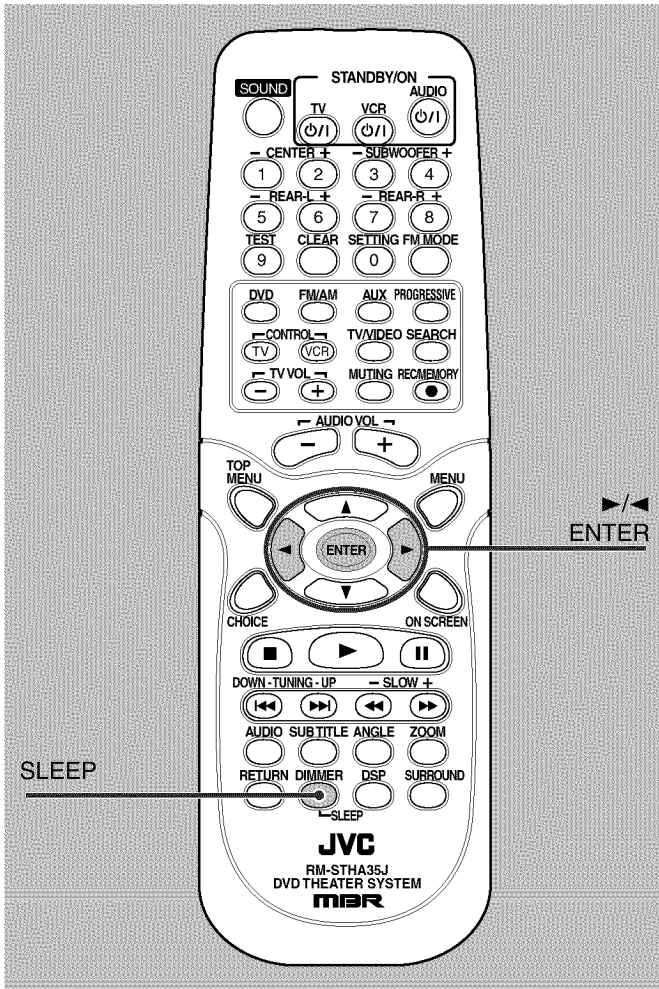

2 Press cursor **▶/◀** to select the shut-off time.

- The shut-off time changes as follows:

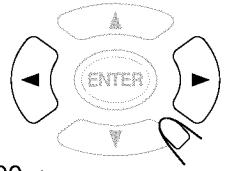
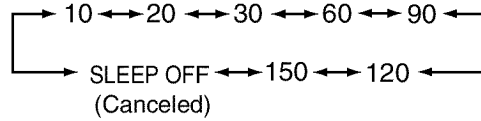

3 Press **ENTER**.

- “OK” appears on the display and the sleep indicator lights up.

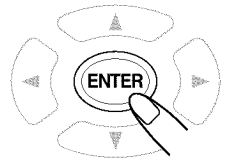

When the shut-off time comes, the system turns off automatically.

To check or change the time remaining until the shut-off time

Press **SLEEP** repeatedly until “**SLEEP (with the remaining time)**” appears on the display.

- You can change the shut-off time by pressing cursor **▶/◀** then **ENTER**.



To cancel the Sleep Timer

Press cursor **▶/◀** repeatedly until “**SLEEP OFF**” appears on the display in procedure above, then **ENTER**.

- Turning off the power also cancels the Sleep Timer.

Turning Off the Power with the Timer

You can fall asleep while listening to music—Sleep Timer.

There is a time limit in doing the following steps. If the setting is canceled before you finish, start from step **1** again.

From the remote control ONLY:

1 Press **SLEEP** repeatedly until “**SLEEP (with the remaining time)**” appears on the display.



- Each time you press the button, the indication in the main display changes as follows:

DIMMER* ↔ **SLEEP****

* With the current level is shown.

** With the remaining time is shown.

Creating Realistic Sound Fields

You can use the following surround to reproduce a realistic sound field.

- Dolby Surround
 - Dolby Pro Logic II
- Dolby Digital
- DTS Digital Surround
- DSP modes

■ Dolby Surround

Dolby Pro Logic II*

Dolby Pro Logic II has newly developed multichannel playback format to decode the 2 channel sources—stereo analog source, Linear PCM digital source, and Dolby Surround encoded source—into 5.1 channel.

Matrix-based encoding/decoding method for Dolby Pro Logic II makes no limitation for the cutoff frequency of the rear treble and enables stereo rear sound compared to conventional Dolby Pro Logic.

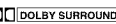
Dolby Pro Logic II enables to reproduce spacious sound from original sound without adding any new sounds and tonal colorations. Dolby Pro Logic II has two modes—**Movie mode** and **Music mode**: **Pro Logic II Movie (PL II MOVIE)**—suitable for reproduction of Dolby Surround encoded sources bearing the mark . You can enjoy sound field very close to the one created with discrete 5.1 channel sounds.

Pro Logic II Music (PL II MUSIC)—suitable for reproduction of any 2 channel stereo music sources. You can enjoy wide and deep sound by using this mode.

- When Dolby Pro Logic II is activated, the  PRO LOGIC II indicator lights up on the display window.

■ Dolby Digital*

Used to reproduce multichannel soundtracks of the software encoded with Dolby Digital ().

Dolby Digital 5.1 ch (DOLBY D) encoding method (so-called discrete multichannel digital audio format) records and digitally compresses the left front channel, right front channel, center channel, left rear channel, right rear channel, and LFE channel signals.

Since each channel is completely independent from the other channel signals to avoid interference, you can obtain much better sound quality with much stereo and surround effects.

When the system detects Dolby Digital signals, the  DIGITAL indicator lights up on the display.

Note:

Dolby Digital software can be roughly grouped into two categories—multichannel (up to “5.1” channel) and 2 channel software. To enjoy surround sounds while playing Dolby Digital 2 ch software, you can use Dolby Pro Logic II.

■ DTS Digital Surround**

Used to reproduce multichannel sound tracks of the software encoded with DTS Digital Surround ().

DTS Digital Surround is another discrete 5.1 channel digital audio format available on CD, LD, and DVD software.

Compared to Dolby Digital, audio compression rate is relatively low. This fact allows DTS Digital Surround format to add breadth and depth to the reproduced sounds. As a result, DTS Digital Surround features natural, solid and clear sound.

When the system detects DTS Digital Surround signals, the **dts** indicator lights up on the display.

Example: Indications on the display for each surround

• Dolby Digital

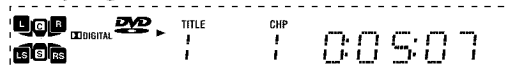

• DTS Digital Surround

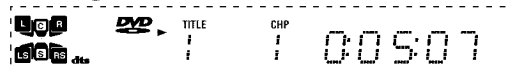

• Dolby Pro Logic II Music



• Dolby Pro Logic II Movie

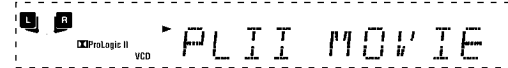

• DSP

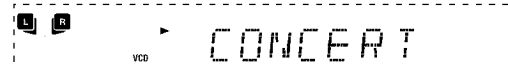

* Manufactured under license from Dolby Laboratories. “Dolby,” “Pro Logic,” and the double-D symbol are trademarks of Dolby Laboratories. Confidential unpublished works. ©1992–1997 Dolby Laboratories. All rights reserved.

** “DTS” and “DTS Digital Surround” are registered trademarks of Digital Theater Systems, Inc.

Creating Realistic Sound Fields

DSP (Digital Signal Processor) Modes

DSP modes have been designed to create important acoustic surround elements.

The sound heard in a live house, a hall, a concert, a stadium, or a theater consists of direct sound and indirect sound—early reflections and reflections from behind. Direct sounds reach the listener directly without any reflection. On the other hand, indirect sounds are delayed by the distances of the ceiling and walls.

These indirect sounds are important elements of the acoustic surround effects.

The following DSP modes are provided with this unit.

LIVE HOUSE	: Gives the feeling of a live music house with a low ceiling.
HALL	: Gives clear vocal and the feeling of a concert hall.
CONCERT	: Gives the feeling of a large hall designated primarily for classical concert.
STADIUM	: Gives feeling of an outdoor stadium.
THEATER	: Gives the feeling of a theater.

These DSP modes can be used to add the acoustic surround effects while reproducing stereo analog software, Linear PCM digital software, or Dolby Surround encoded source and can give you a real “being there” feeling.

Note:

On some source signals, DSP mode may not work sufficiently. In that case, select another preferred DSP mode.

Activating the Surround Mode

You can enjoy three kinds of surround—Digital Multichannel Surround (Dolby Digital and DTS Digital Surround), Dolby Pro Logic II and DSP modes.

- If you activate the surround mode not available, “INVALID” appears on the display.

For Dolby Digital or DTS Digital Surround

When playback source is encoded with Dolby Digital or DTS Digital Surround, the system detects it and activate Multichannel Surround automatically.

- When Dolby Digital is activated, the **DD** DIGITAL indicator lights up on the display.
- When DTS Digital Surround is activated, the **dts** indicator lights up on the display.

For Pro Logic II modes

Press **SURROUND**.

The current Pro Logic II mode appears on the display for a while.



- Each time you press the button, Pro Logic II mode changes as follows:

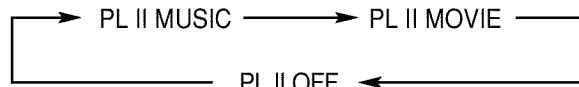

- When Dolby Pro Logic II mode is activated, the **PL II** PRO LOGIC II indicator lights up on the display.

For DSP modes

Press **DSP**.

The current DSP mode appears on the display for a while.

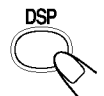

- Each time you press the button, DSP mode changes as follows:

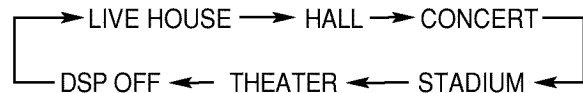

Available surround according to the input signal format

○: Possible ×: Impossible

Surround	Multichannel Surround	Pro Logic II		DSP					PL II OFF and DSP OFF (canceled)	
		PLII Movie	PLII Music	LIVE HOUSE	HALL	CONCERT	STADIUM	THEATER		
Input Signal format	Analog	×	○	○	○	○	○	○	○	○
	Linear PCM	×	○	○	○	○	○	○	○	○
	Dolby Digital Multichannel	○	×	×	×	×	×	×	×	—
	Dolby 2ch	×	○	○	○	○	○	○	○	○
	DTS Digital Surround	○	×	×	×	×	×	×	×	—
	DTS 2ch	×	×	×	×	×	×	×	×	○
	MP3	×	×	×	×	×	×	×	×	○

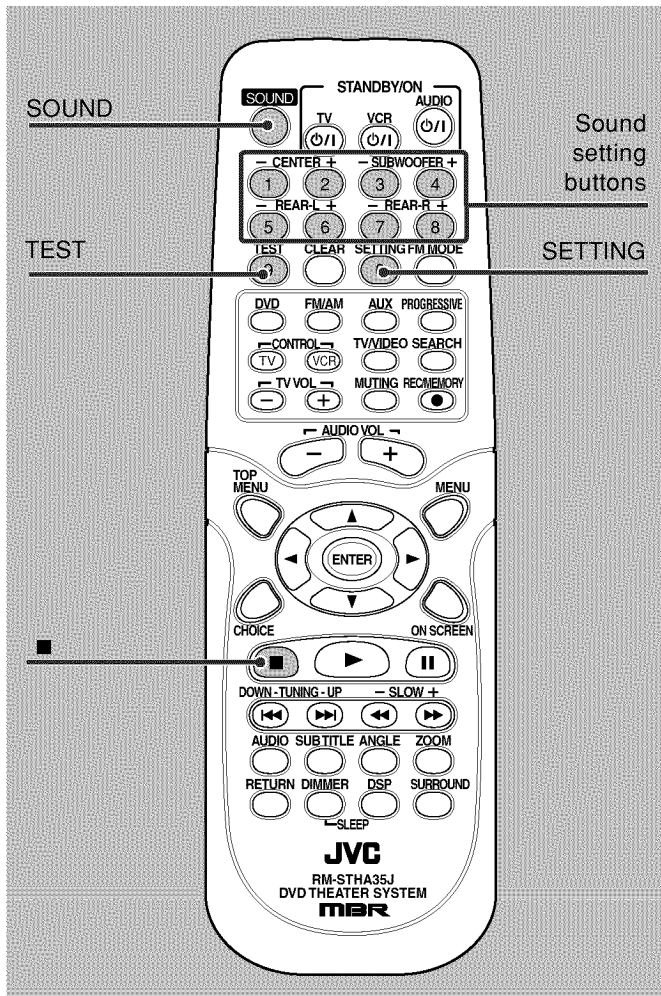

- The test tone comes out of the speakers in the following order:

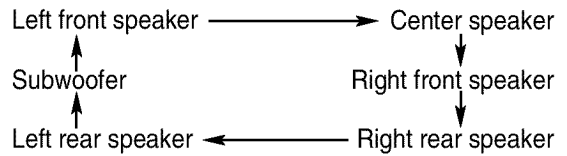

There is a time limit in doing the following steps. If the setting is canceled before you finish, press **SOUND** and start from step **4** again.

4 Adjust the speaker output levels (-6 dB to +6 dB).

Adjust the center speaker, rear speakers and subwoofer levels comparing to the sound from the front speakers.

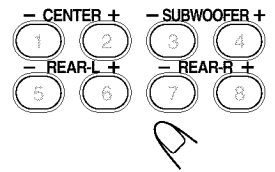

- To adjust the center speaker level, press CENTER +/-.
- To adjust the left rear speaker level, press REAR-L +/-.
- To adjust the right rear speaker level, press REAR-R +/-.
- To adjust the subwoofer level, press SUBWOOFER +/-.

5 Press STOP to stop the test tone.



6 Press SOUND again.

“SOUND OFF” appears on the display.



Adjusting the Sound

You can adjust the following settings.
It is recommended that you make adjustments from your actual listening point.

- Output level for the center speaker
- Output level for the rear speakers
- Output level for the subwoofer

1 Load a disc, and Press STOP.

The source changes to DVD and playback stops.



2 Press SOUND.

“SOUND” appears on the display and the 10 keys are activated for sound adjustments.



3 Press TEST to check if you can hear the sounds through all the speakers at the equal level.

Test tone menu appears on the TV.

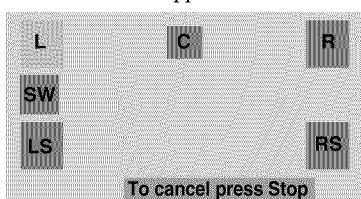

Notes:

- If a disc is no loaded, you cannot adjust the settings.
- You can adjust the speaker output levels without outputting the test tone.
- If there is a speaker from which no sounds comes out, check the speaker's connection (see pages 6 and 7) and setting (see pages 53 and 54).
- If you press SETTING while adjusting sound, speaker settings alternate between 5.1ch (use all satellite speakers and subwoofer) and 2.1ch (use only front speakers and subwoofer.)
- You can output the test tone in any surround mode, or even when surround mode is not activated.
- When an MP3 disc is loaded, you cannot adjust the subwoofer output level.

Disc Introduction—DVD/VCD/CD

This system has been designed to play back the following discs: DVD, Video CD, Super Video CD (SVCD), Audio CD, CD-R, and CD-RW.

- This system can also play back MP3 and JPEG files recorded on CD-Rs and CD-RWs. For in-depth information about MP3, see “MP3 Playback” on page 40, and about JPEG, see “JPEG Playback” on page 44.

Discs you can play:

Disc Type	Mark (Logo)	Video Format	Region Code Number*
DVD Video		NTSC PAL	1 ALL
Video CD			_____
Super Video CD			_____
Audio CD			_____
CD-R			_____
CD-RW			_____

- On some DVD or VCD/SVCD discs, their actual operations may be different from what is explained in this manual. This is due to the disc programming and disc structure, but not a malfunction of this system.
- DVD-R discs recorded with the DVD VIDEO format can be played back. However, some discs may not be played back because of the disc characteristics or recording conditions. Note that unfinalized disc cannot be played back.
- The following discs cannot be played back:
 - DVD-Audio, DVD-ROM, DVD-RAM, DVD-RW, DVD+RW, CD-ROM, CD-I, (CD-I Ready), Photo CD, etc. Playing back these discs will generate noise and damage the speakers.

* Note on Region Code

DVD players and DVD Video discs have their own Region Code numbers. This system only can play back DVD discs whose Region Code numbers include “1.”

Examples:



If a DVD with the inadequate Region Code numbers is loaded, “Invalid Region” appears on the TV and playback cannot start.

IMPORTANT: Before performing any operations, make sure of the following...

- Check the connection with the TV.
- Turn on the TV and select the correct input on the TV to view the pictures or on-screen indications on the TV screen.
- For DVD playback, you can change the Setup menu setting to your preference. (See pages 50 to 55.)

If “⊗” appears on the TV screen when pressing a button, the disc cannot accept an operation you have tried to do, or information required for that operation is not recorded in the disc.
NOTICE : In some cases, without showing “⊗,” operations will not be accepted.

Disc structure—DVD, Video CD (VCD/SVCD) and Audio CD (CD)

A DVD disc consists of **Titles**, and each title may be divided into some **Chapters**. (See Example 1.)

For example, if a DVD disc contains some movies, each movie may have its own title number, and it may be further divided into some chapters.

On the other hand, a VCD/SVCD or CD consists of **Tracks**. (See Example 2.)

In general, each song has its own track number. (On some discs, each track may also be divided by Indexes.)

When playing back a VCD/SVCD with Playback Control (PBC) function, you can select what to view using the menu shown on the TV screen. (While operating a Video CD using the menu, some of the functions such as Repeat and Track Search may not work.)

Example 1: DVD disc

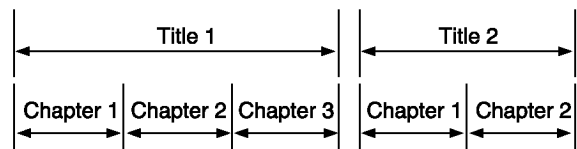

Example 2 : Video CD/Audio CD



Notes on CD-R and CD-RW

User-edited CD-Rs (Recordable) and CD-RWs (Rewritable) can be played back only if they are already “**finalized**.”

- The system can play back CD-Rs or CD-RWs recorded on a personal computer if they have been recorded in the audio CD format or recorded in MP3 format (see page 38). However, they may not be played back depending on their characteristics or recording conditions.
- Before playing back CD-Rs or CD-RWs, read their instructions or cautions carefully.
- Some CD-Rs or CD-RWs may not be played back on this unit because of their disc characteristics, damage or stain on them.
- CD-RWs may require a longer readout time. This is caused by the fact that the reflectance of CD-RWs is lower than for regular CDs.

Basic Disc Operations

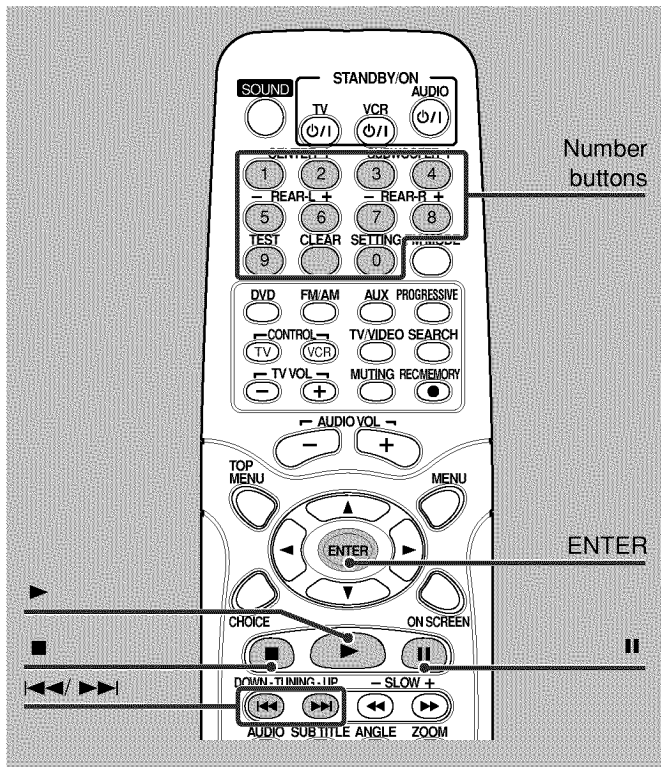

SVCD can be operated by using the VCD operation procedure.

To start playback

Press ►.

The source is automatically changed to the DVD player. "READING" appears on the display for a while, then the detected disc type appears—DVD, VCD, CD, MP3 or JPEG. (If your TV is turned on, the detected disc type appears on the TV screen.)

- When a disc is not loaded, "NO DISC" appears on the display.

Example: Playback information on the display

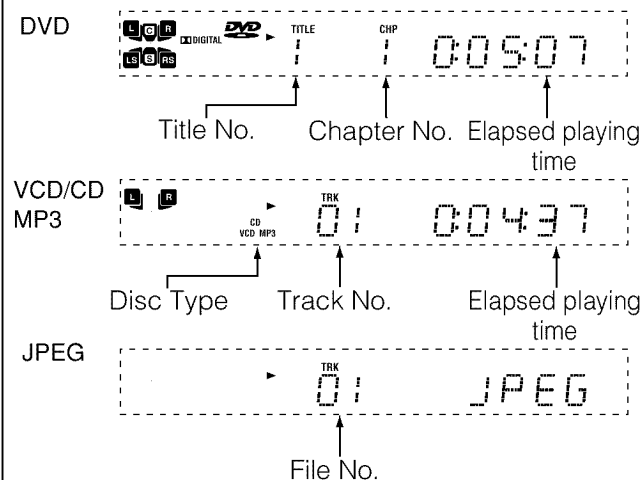

Disc play starts from the first chapter or track of the selected disc.

- If a menu appears while playing a DVD or VCD with PBC function, see "Disc Menu-Driven Playback" (for DVD) on page 28 or "Disc Menu-Driven Playback (Only for VCD)" on page 35.

Note:

If "Password ----" and "Parental Locked" appear on the TV screen, Parental Lock is in use. You cannot play back a DVD containing violent scenes or those not suitable for your family members. To play back such a disc, cancel the Parental Lock. (See page 55.)

To stop playback for a moment

Press ■.

- To resume play, press ►.



To go to another chapter or track

Press ►► or ◀◀ repeatedly during playback.

- ►► : Skips to the beginning of the next or succeeding chapter or track.
- ◀◀ : **While an MP3 is played back**
Goes back to the beginning of the previous track.
While a DVD, a CD, or a VCD is played back
Goes back to the beginning of the current or previous chapter or track.

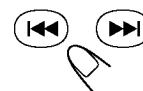

To go to another track (only possible on a CD and VCD without PBC) directly using the number buttons

Pressing the number buttons during play allows you to start playing the track number you want.

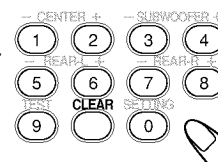

- To select number 1 to 9, press the corresponding number button, then press ENTER.
- To select number 15, press 1, 5, then press ENTER.
- To cancel a mis-entry, press CLEAR.



To stop during playback

Press ■.



When a DVD, a VCD, or a CD is played back

Playback stops (If your TV is turned on, "■ Resume Stop" appears on the TV screen.)

- This system can memorize the end point even when you press ■. When you start playback again by pressing ►, playback begins from where it has been stopped—Resume play.
- To stop completely, press ■ twice. ("■ Stop" appears on the TV screen.) The disc type appears on the display.

When an MP3 disc or JPEG disc is played back

Playback stops.

- This system can memorize the end point even when you press ■. When you start playback again by pressing ►, playback begins from the beginning of the stopped track—Resume play.

Note:

If you open the disc tray or turn off the unit, the resume play is canceled.

To remove the disc

Press ▲ on the front panel.

The disc tray comes out.



To close the disc tray, press ▲ again.

DVD Playback

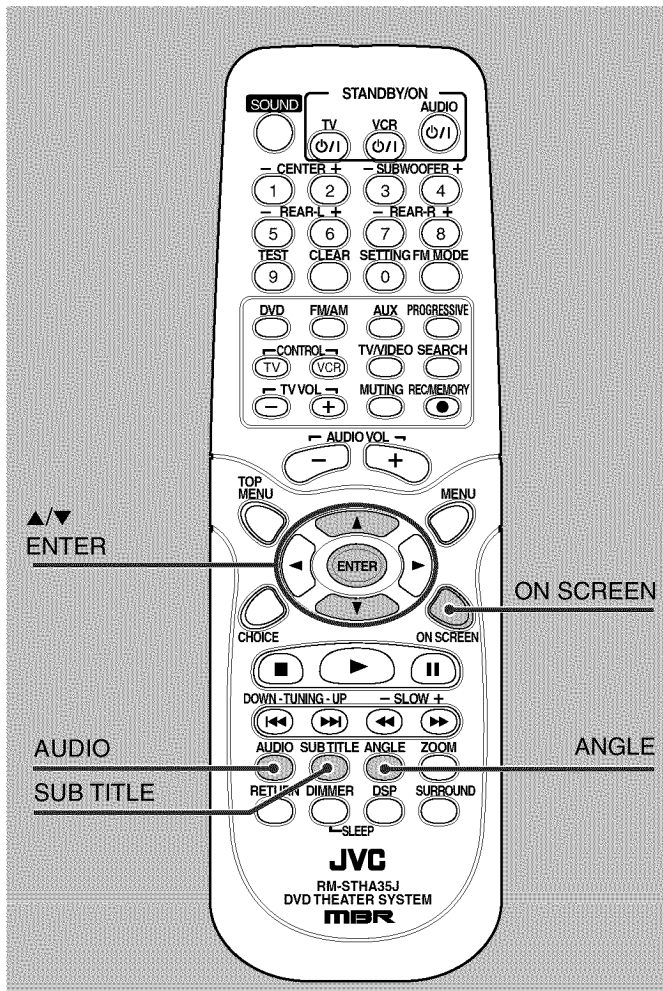

Some DVDs contain several audio languages, subtitles, and multi-angle views. When you find the following marks on the DVD or its package, you can select these elements recorded on the DVD.

	Subtitles are recorded on the disc. The number inside the mark indicates the total number of the recorded subtitles.
	Several audio languages are recorded on the disc. The number inside the mark indicates the total number of the recorded audio languages.
	Multi-angle views are recorded on the disc. The number inside the mark indicates the total number of the recorded multi-angle views.

If you cannot find out whether your disc contains these features listed above, you can check it by showing the on-screen display (OSD.)

For basic disc operations such as inserting a disc, starting playback, and moving to another chapters, see "Basic DVD Operations" on pages 12, 13, and "Basic Disc Operations" on page 25.

Showing the On-screen Menu

You can use some functions through the on-screen menu.

From the remote control ONLY:

■ Whenever a disc is loaded.

Press ON SCREEN.

On-screen menu appears on the TV.

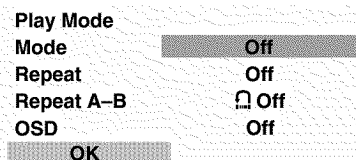

To turn off the on-screen menu

Press ON SCREEN again.

Showing the Information on the TV Screen

You can show the following information on the TV screen while a disc is loaded.

From the remote control ONLY:

1 Press ON SCREEN.

The on-screen menu appears on TV-screen.

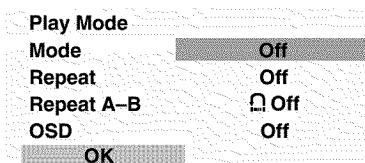

2 Press cursor ▲/▼ repeatedly to select "OSD."

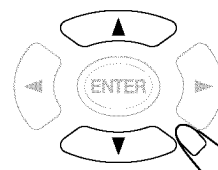
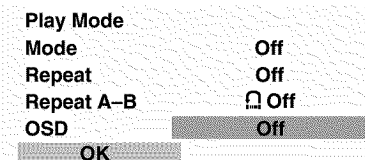

3 Press ENTER repeatedly to select the disc information.

- Each time you press the button, OSD changes as following:

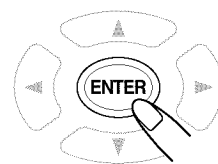
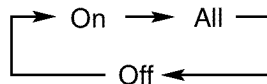

4 Press cursor ▲/▼ repeatedly to select "OK," then ENTER.

The on-screen menu disappears and the information appears on the TV.

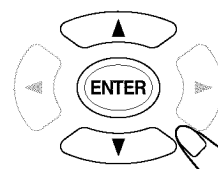

To turn off the disc information

- 1) Press ENTER repeatedly to select "Off" in step 3.
- 2) Press cursor ▲/▼ to select "OK", then press ENTER.

Disc information

OSD: On	① 00:01:16 01:40:45
OSD: All	① DVD ② ③ ④ ⑤ 00:01:16 01:40:45 Title 1/15 Chapter 2/10 Angle 1/1 Audio ⑥ 1/3 Eng ⑦ 5.1ch 48KHz Subtitle ⑧ Off
① : Elapsed playing time and remaining time	
② : Disc type	
③ : Current title and total number of the titles on the disc • Ex.: 1st title is playing out of 15 titles recorded.	
④ : Audio language indication • Ex.: English is selected out of 3 audio languages recorded. See right column.	
⑤ : Current chapter and total number of the chapters in the current title • Ex.: 2nd chapter is playing out of 10 chapters recorded.	
⑥ : Subtitle language indication • Ex.: When no subtitle is displayed on the TV screen. See below.	
⑦ : Signal format indicator • Signal format type—Linear PCM (stereo), Dolby Digital, and DTS Digital Surround—and bit rate will be indicated. Ex.: When the disc is encoded with Dolby Digital 5.1 ch.	
⑧ : Multi-angle view indicator • Ex.: When only a single angle-view is recorded on the disc. See right column.	

Selecting the Subtitles

While playing back a DVD containing subtitles in different languages, you can select the subtitle to be displayed on the TV screen.

- You can set your favorite subtitle language as the initial language shown on the screen. (See page 51.)

From the remote control ONLY:

Press **SUB TITLE**.

Subtitle language indicator appears on the TV screen for a while.

- Each time you press the button while the indicator appears on the TV screen, the subtitle language changes as follows:

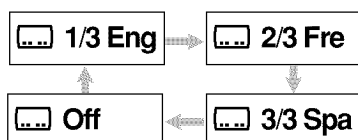

Ex.: When the disc has 3 selections—English, French, Spanish and no subtitle (OFF)

Selecting the Audio Languages

While playing back a DVD containing audio languages (sound track), you can select the language (sound track) to listen to.

- You can set your favorite audio language as the initial audio language. (See page 53.)

From the remote control ONLY:

Press **AUDIO**.

Audio language indicator appears on the TV screen for a while.

- Each time you press the button while the indicator appears on the TV screen, the audio language changes as follows:

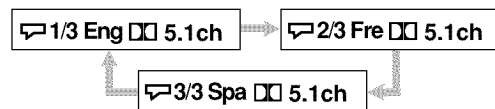

Ex.: When the disc has 3 selections—English, French, and Spanish

Selecting the Multi-Angle Views

While playing back a DVD containing multi-angle views, you can view the same scene at different angles.

From the remote control ONLY:

Press **ANGLE**.

The angle indicator appears on the TV screen for a while.

- Each time you press the button while the angle indicator appears on the TV screen, the view angle changes.

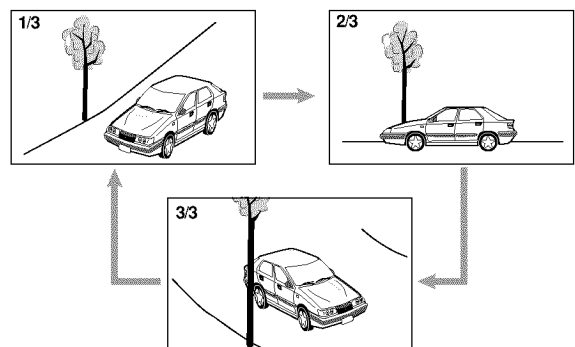

Ex.: When the disc has 3 multi-angle views

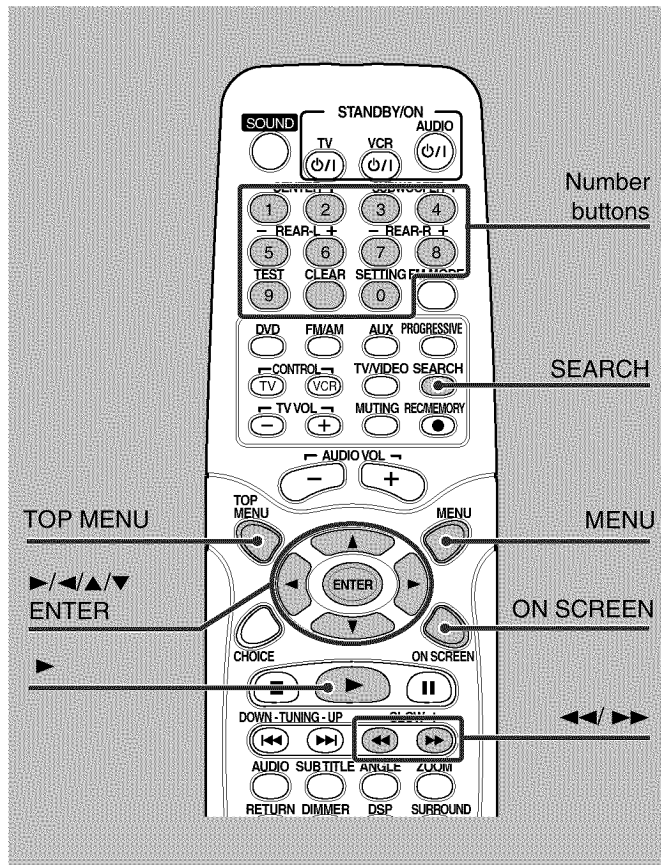

Moving to a Particular Portion Directly

You can move to another title, chapter, or particular scene in the chapter directly.

From the remote control ONLY:

1 Press SEARCH.

The search menu appears on the TV.

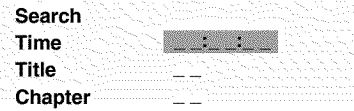

2 Press cursor ▲/▼ to select the item.

Time : Select this to move to a particular scene.

Title: Select this to move to another title.

Chapter: Select this to move to another chapter.

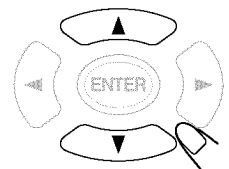

3 Press the number buttons to select a desired title, chapter, or playing time.

The unit starts playback of the selected item.

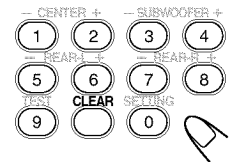

Disc Menu-Driven Playback

Disc menu-driven playback is possible while playing back a DVD with menu (menu may be still pictures or moving pictures depending on the disc).

- When operating a disc using the disc menu, refer also to the instructions supplied for the disc.

DVD discs generally have their own menus or title lists. A menu usually contains various information about the disc and playback selections. On the other hand, a title list usually contains titles of movies and songs recorded.

From the remote control ONLY:

1 Press MENU or TOP MENU.

A menu or title list will appear on the screen.

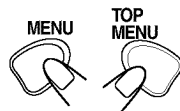

- On some DVDs, a menu will automatically appear on the screen after playback starts.

2 Select a desired item on the menu or on the title list, using cursor ►/◄/▲/▼ and ENTER.

The unit starts playback of the selected item.

- On some discs, you can also select items by pressing the number buttons corresponding to the item numbers listed.

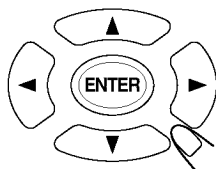

How to input the title and chapter number

Press the number buttons corresponding to the number, then press ENTER to start playback.

- To select number 5, press 5, then ENTER.
- To select number 12, press 1, 2, then ENTER.
- To select number 22, press 2, 2, then ENTER.
- To cancel a mis-entry, press CLEAR.

How to input the playing time

Press the number buttons to input the playing time, then press ENTER to start playback at the selected elapsed playing time.

- To input time "00:45:23," press 4, 5, 2, 3, then ENTER.
- To input time "01:23:45," press 1, 2, 3, 4, 5, then ENTER.
- To cancel a mis-entry, press CLEAR.

Searching for a Particular Point

You can search for a particular portion while playing a disc—Variable Speed Forward/Reverse Search.

- No sound comes out during Variable Speed Forward/Reverse Search.

To fast-forward the chapter—Variable Speed Forward Search

From the remote control ONLY:

Press **▶▶** during playback.

- Each time you press the button, the search speed changes as follows:

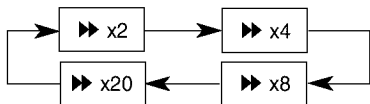

To resume normal play

Press **▶**.



To reverse the chapter—Variable Speed Reverse Search

From the remote control ONLY:

Press **◀◀** during playback.

- Each time you press the button, the search speed changes as follows:

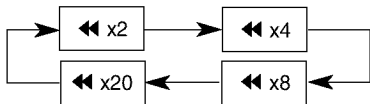

To resume normal play

Press **▶**.

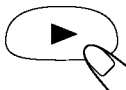

Repeating Playback

Repeat play cannot be used in the following cases:

- When you enjoy program play

Repeat Play

From the remote control ONLY:

1 Press **ON SCREEN**.

The on-screen menu appears on the TV.

Play Mode	
Mode	Off
Repeat	Off
Repeat A-B	Off
OSD	Off
OK	



2 Press cursor **▲/▼** to select “Repeat.”

Play Mode	
Mode	Off
Repeat	Off
Repeat A-B	Off
OSD	Off
OK	

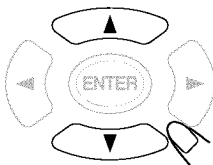

3 Press **ENTER** repeatedly to select the repeat mode.

- Each time you press the button, Repeat mode changes as follows:

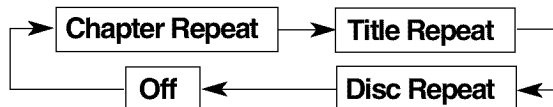

Chapter Repeat:

Current chapter will be repeated. (the REPEAT 1 indicator lights up.)

Title Repeat:

Current title will be repeated. (the REPEAT indicator lights up.)

Disc Repeat:

Disc will be repeated. (the REPEAT indicator lights up.)

Off:

Repeat play is canceled. (Normal play is resumed.)

4 Press cursor **▲/▼** to select “OK,” then **ENTER**.

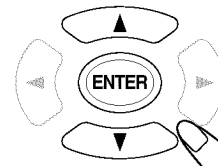

To cancel repeat play

- 1) Press **ENTER** repeatedly to select “Off” in step 3.
- 2) Press cursor **▲/▼** to select “OK,” then press **ENTER**.

A-B Repeat

While playing, you can also select a portion you want to repeat.

- A-B repeat is not performed between different titles.

Example:

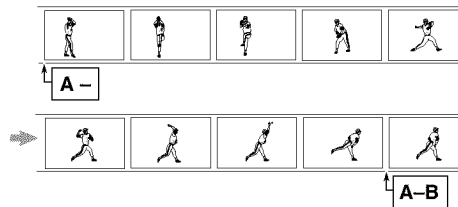

From the remote control ONLY:

1 Press **ON SCREEN**.

The on-screen menu appears on the TV.

Play Mode	
Mode	Off
Repeat	Off
Repeat A-B	Off
OSD	Off
OK	



TO BE CONTINUED ON THE NEXT PAGE

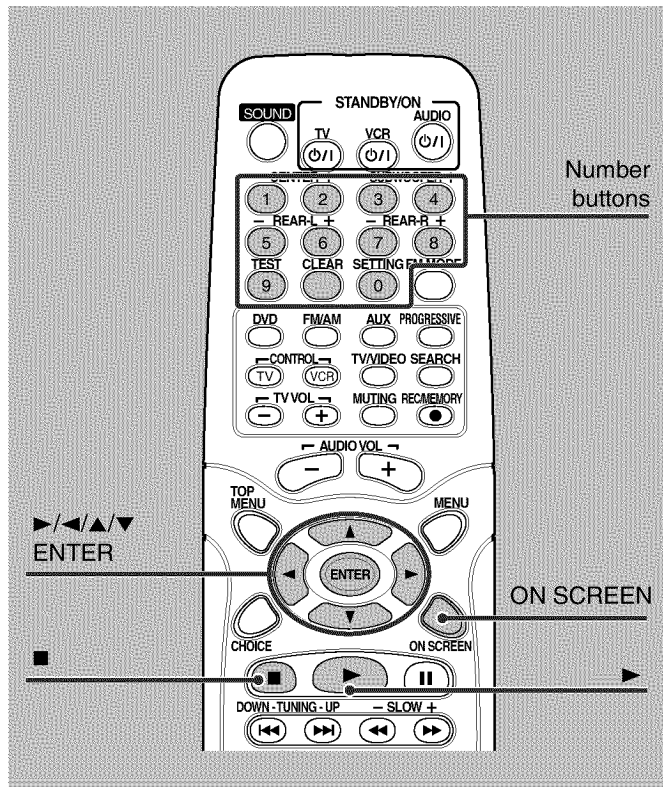

Playing Back Chapters in Random Order — Shuffle Play

You can playback chapters in random order.

From the remote control ONLY:

1 Press ON SCREEN.

The on-screen menu appears on the TV.

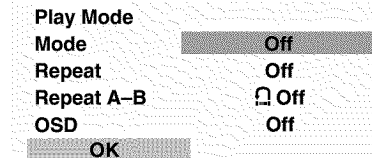

2 Press cursor ▲/▼ to select “Mode.”

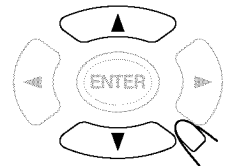
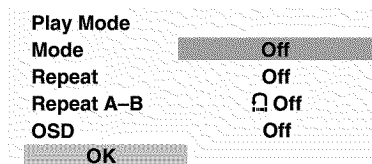

3 Press ENTER repeatedly to select “Shuffle.”

- Each time you press the button, play mode changes as follows:

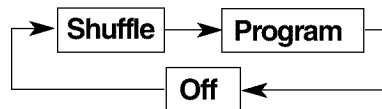

2 Press cursor ▲/▼ to select “Repeat A–B.”

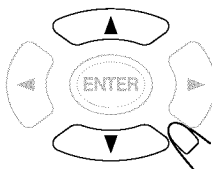
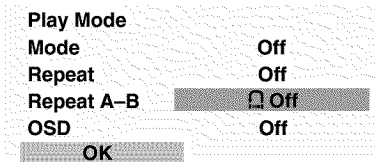

3 Press ENTER to select the start point.

“A–” appears on the display and “ A–” appears on the TV.

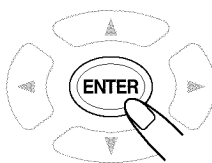

4 Press ENTER again to select the end point.

“A–” changes to “A–B”, then A–B repeat begins.
The unit automatically locates point A and starts repeated playback between points A and B.



5 Press ON SCREEN again.

The on-screen menu disappears.



4 Press cursor ▲/▼ to select “OK”, then press ENTER.

The on-screen menu disappears.

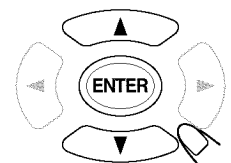

5 Press ►.

Playback starts in random order.



To cancel shuffle play

- 1) Press ENTER repeatedly to select “Off” in step 3.
- 2) Press cursor ▲/▼ to select “OK”, then press ENTER.

Notes:

- When all chapters in the current title have been played once, shuffle play ends.
- The same chapter will not be played more than once during shuffle play.

To cancel A–B Repeat

- 1) Press ENTER repeatedly to select “Off” in step 3.
 - 2) Press cursor ▲/▼ to select “OK”, then press ENTER.
- “A–B” disappears, and resume normal playback.

Programming the Playing Order of the Chapters — Program Play

You can arrange the chapter playback order before you start playing. You can program up to 12 steps.

From the remote control ONLY:

1 Press ON SCREEN.

The on-screen menu appears on the TV.

Play Mode	
Mode	Off
Repeat	Off
Repeat A-B	Off
OSD	Off
OK	



2 Press cursor ▲/▼ to select “Mode.”

Play Mode	
Mode	Off
Repeat	Off
Repeat A-B	Off
OSD	Off
OK	

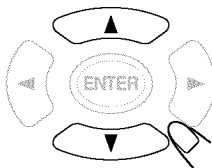

3 Press ENTER repeatedly to select “Program.”

- Each time you press the button, play mode changes as follows:

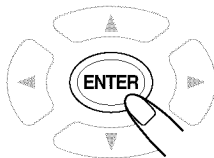
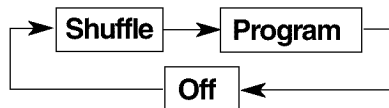

4 Press cursor ▲/▼ to select “OK”, then press ENTER.

The Program menu appears on the TV.

Title Number		Chapter Number	
Program	Title/Chapter		
1	4	7	10
2	5	8	11
3	6	9	12
Play Program	Clear All		

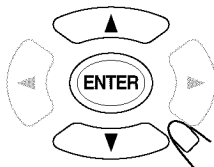

5 Press the number button to enter a title number.

Program	Title/Chapter		
1	2	4	7
2	5	8	11
3	6	9	12
Play Program	Clear All		

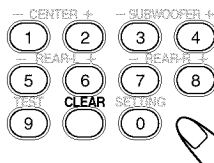

- To select number 5, press 5.
- To select number 12, press 1, 2.
- To cancel a mis-entry, press CLEAR.

6 Press cursor ► to select the chapter number.

Program	Title/Chapter		
1	2	4	7
2	5	8	11
3	6	9	12
Play Program	Clear All		

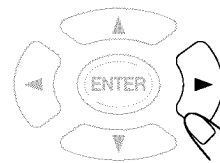

7 Press the number button to enter the chapter number.

Program	Title/Chapter		
1	2	3	4
2	5	8	11
3	6	9	12
Play Program	Clear All		

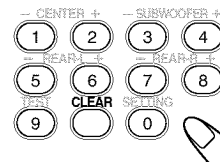

- To select number 5, press 5.
- To select number 12, press 1, 2.
- To cancel a mis-entry, press CLEAR.

8 Press cursor ►/◀/▲/▼ to select next program step number.

Program	Title/Chapter		
1	2	3	4
2	5	8	11
3	6	9	12
Play Program	Clear All		

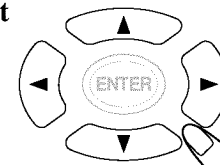

9 Repeat steps 5 to 8 to program other chapters you want.

10 Press cursor ►/◀/▲/▼ to select “Play Program”, then press ENTER.

The Program menu disappears and PROG indicator appears on the display. The chapters are played in the order you have programmed.

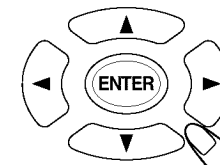

To stop during playback

Press ■.



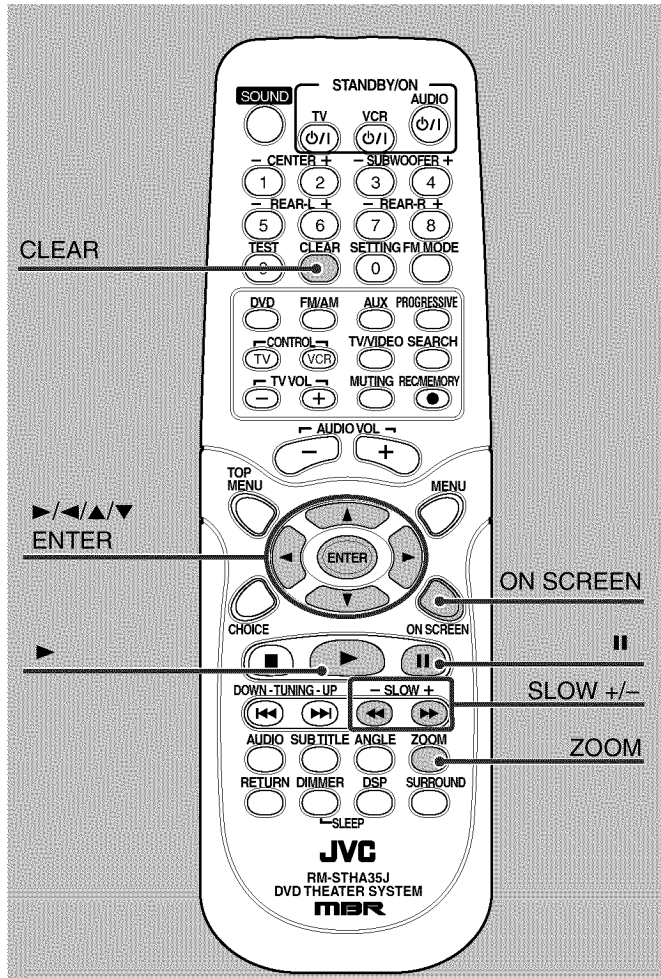

To exit from program play

From the remote control ONLY:

- 1) Press ENTER repeatedly to select "Off" in step 3 on page 31.
- 2) Press cursor ▲/▼ to select "OK", then ENTER.

To check the program contents

- 1) Press ON SCREEN.
 - 2) Press cursor ▲/▼ to select "Mode."
 - 3) Press ENTER repeatedly to select "Program" again even though "Program" is selected in Step 2.
 - 4) Press cursor ▲/▼ to select "OK", then ENTER.
- The program menu appears on the TV.

To disappear program contents, press ON SCREEN twice.

To erase the stored program

- 1) Repeat steps 1 to 4 on page 31.
- 2) Press cursor ►/◄/▲/▼ to select "Clear All", then ENTER.

To modify the program

You can modify the program while the program menu screen is shown on the TV screen.

- **To erase a step:** Press cursor ►/◄/▲/▼ to select (highlight) an title or chapter in unwanted step, then press CLEAR.
- **To modify a step:** Press cursor ►/◄/▲/▼ to select (highlight) a title or chapter you want to modify, then perform steps 5 to 8 on page 31. (Before entering a new number, press CLEAR)
- **To add a step:** Press cursor ►/◄/▲/▼ to select (highlight) an empty program step, then perform steps 5 to 8 on page 31.

DVD Special Effect Playback

■ Still Picture/Frame-by-Frame Playback

You can advance the still picture frame by frame while playing a DVD.

From the remote control ONLY:

1 Press II once during playback.

A still picture appears on the TV screen.

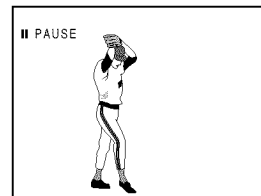

2 Press II repeatedly to advance the picture frame by frame.

- Each time you press the button, the picture advances frame by frame.

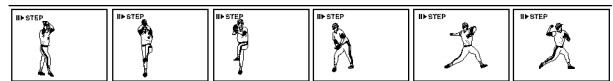

To resume normal play

Press ►.



■ Slow Motion Playback

You can enjoy slow motion playback while playing a DVD.

From the remote control ONLY:

1 Press **II** at the point where you want to start playback in slow-motion.



A still picture appears on the TV screen.

2 Press **SLOW +** or **SLOW -**.

- Each time you press the button, slow motion speed changes as follows.

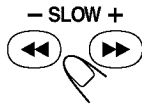

Forward:

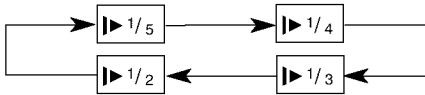

Reverse:

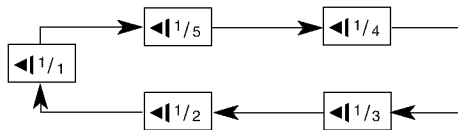

■ Zoom

You can zoom on the picture while playing back a DVD.

From the remote control ONLY:

1 Press **ZOOM**.



The zoom indicator appears on the TV.

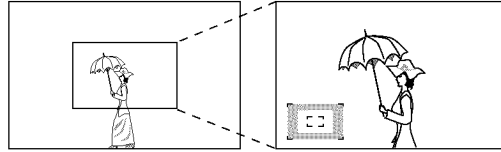

- Each time you press the button while the indicator appears, the magnification changes as follows:

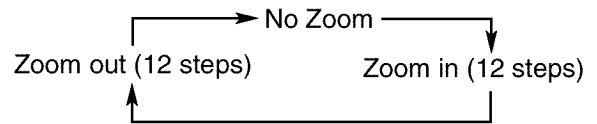

2 Press cursor **▶/◀/▲/▼** to move the portion you want to watch.

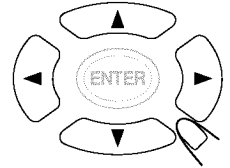

To cancel the zoom

Press **▶**.



VCD/CD Playback

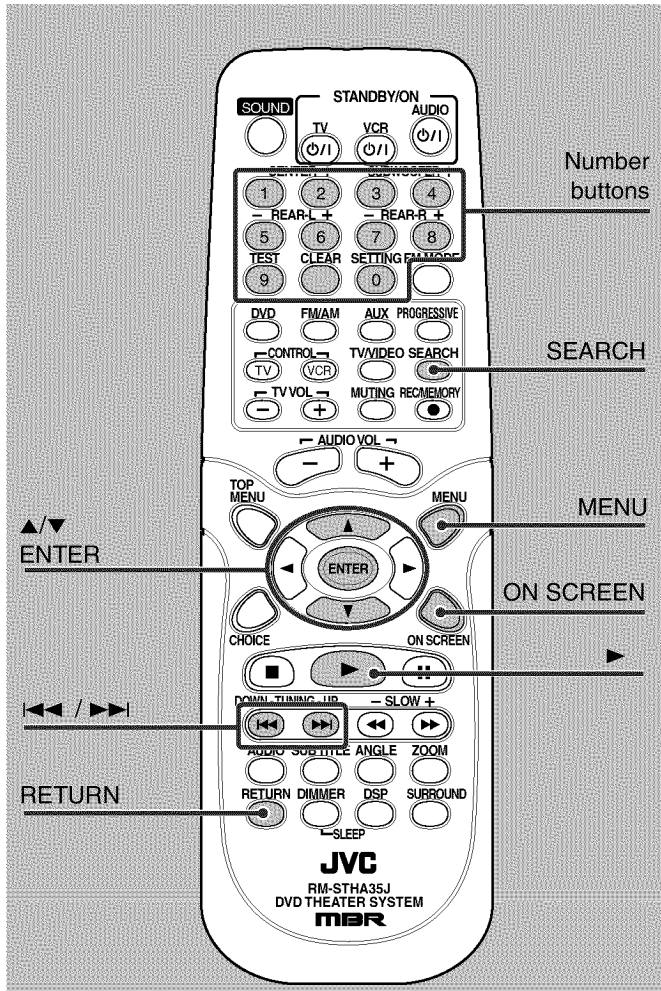

- SVCD can be operated by using the VCD operation procedure.
- For basic disc operations such as inserting a disc, starting playback, and moving to another tracks, see “Basic VCD/CD Operations” on pages 14, 15, and “Basic Disc Operations” on page 25.

Showing the On-screen Menu

You can use some functions through the on-screen menu.

- Whenever a disc is loaded. Press ON SCREEN.

The on-screen menu appears on the TV.

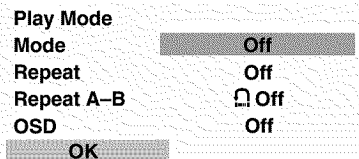

To turn off the on-screen menu

Press ON SCREEN again.

Showing the Information on the TV Screen

You can show the following information on the TV screen while a disc is loaded.

From the remote control ONLY:

1 Press ON SCREEN.

The on-screen menu appears on TV-screen.

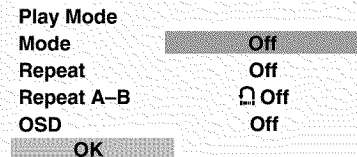

2 Press cursor ▲/▼ repeatedly to select “OSD.”

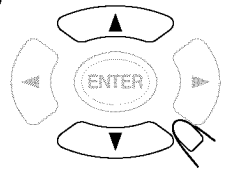
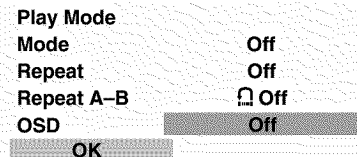

3 Press ENTER repeatedly to select the disc information.

- Each time you press the button, OSD changes as following:

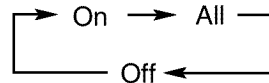
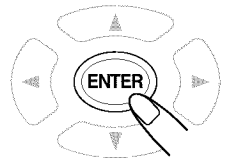

4 Press cursor ▲/▼ repeatedly to select “OK,” then ENTER.

The on-screen menu disappears and the information appears on the screen.

To turn off the disc information

- 1) Press ENTER repeatedly to select “Off” in step 3.
- 2) Press cursor ▲/▼ to select “OK”, then press ENTER.

Disc information

OSD: On	①	00:01:16 01:06:35
OSD: All	② ③	VCD 2.0 Track 1/15
	①	00:01:16 01:06:35
①: Elapsed playing time and remaining time		
②: Disc type and VCD version number		
• VCD version number appears when only VCD is loaded (On some VCD, the version number is not shown).		
③: Current track and total number of the tracks on the disc		
• Ex.: 1st track is playing out of 15 tracks recorded.		

Disc Menu-Driven Playback (Only for VCD)

The Play Back Control function (PBC) allows you to operate the VCD using menus.

When you start playing a VCD with PBC function, a menu will automatically appear on the TV screen.

- A menu may be a list of items, divided screens, or some moving pictures. (See “PBC operation concept” below.)

When a menu appears, you can select a desired item on the menu.

- When a list of items is displayed on the TV screen, press the number buttons to select an item.
- When “▶” or “SELECT” is displayed on the TV screen, press ▶ to start playback.

From the remote control ONLY:

To go to the next submenu

Press ▶▶.

To return to the previous submenu

Press ◀◀.



PBC operation concept

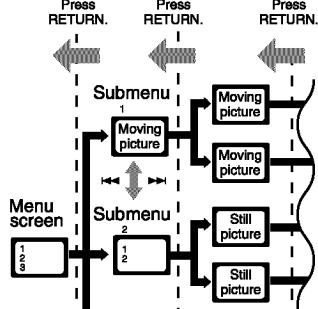

From the remote control ONLY:

To cancel the PBC playback

You can turn on and off the PBC function by pressing MENU on the remote control. Each time you press the button, the PBC function turns on and off.



Note:

If you select shuffle play, program play, or repeat play, the PBC function is canceled.

To activate the PBC function

- 1) Press ON SCREEN.
- 2) Press cursor ▲/▼ to select “Mode.”
- 3) Press ENTER repeatedly to select “PBC.”
- 4) Press cursor ▲/▼ to select “OK,” then press ENTER.

Selecting Playback Channel

When you play back VCD or CD, you can only select either the left channel or right channel to listen to.

Press AUDIO repeatedly.

Each time you press the button, the sound mode changes as follows:



Stereo → Left channel → Right channel
→ (back to the beginning)

Notes:

- While activating Surround mode or DSP mode, this function does not work.
- On some discs, this function does not work.

Moving to a Particular Portion Directly

You can move to a particular portion (scene) on the track directly.

- PBC function is canceled when you use this function.

From the remote control ONLY:

1 Press SEARCH during playback or pause.

- Each time you press the button, the following indication appears on the TV screen.

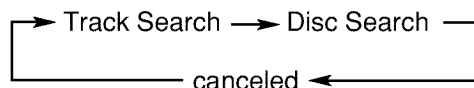

2 Press cursor ▲/▼ to select the item (only for Disc search.)

Track Search:

Time : Select this to move to a particular portion on the current track.

Disc Search:

Time : Select this to move to a particular portion on the current disc.

Track: Select this to move to a particular track on the current disc.

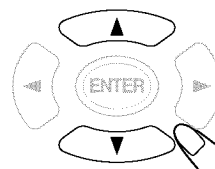

3 Press number buttons to select a desired track or playing time.

The unit starts playback of the selected item.

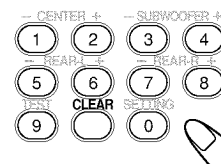

How to input the playing time

- To input time “09:45,” press 9, 4, 5, then ENTER.
- To input time “45:23,” press 4, 5, 2, 3, then ENTER.
- To cancel a misentry, press CLEAR.

How to input the track number

Press the number buttons corresponding to the number, then press ENTER to start playback.

- To select number 5, press 5, then ENTER.
- To select number 12, press 1, 2, then ENTER.
- To cancel a misentry, press CLEAR.

Note:

When playing back is stopped, you can use only Disc Search.

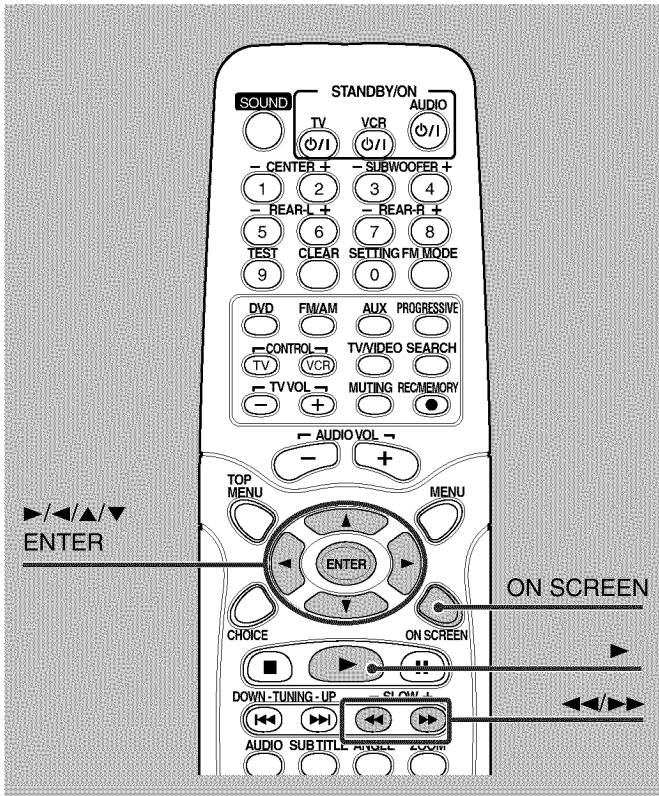

Searching for a Particular Point

You can search for a particular portion while playing a disc—Variable Speed Forward/Reverse Search.

- No sound comes out during Variable Speed Forward/Reverse Search on a VCD.

To fast-forward the tracks—Variable Speed Forward Search

From the remote control ONLY:

Press **▶▶** during playback.

- Each time you press the button, the search speed changes as follows:

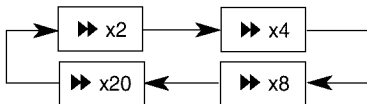

To resume normal play

Press **▶**.

To reverse the tracks—Variable Speed Reverse Search

From the remote control ONLY:

Press **◀◀** during playback.

- Each time you press the button, the search speed changes as follows:

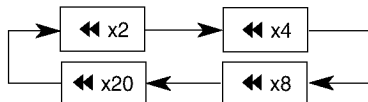

To resume normal play

Press **▶**.

Repeating Playback

Repeat play cannot be used in the following cases:

- When you enjoy program play

Repeat Play

From the remote control ONLY:

1 Press ON SCREEN.

The on-screen menu appears on the TV.

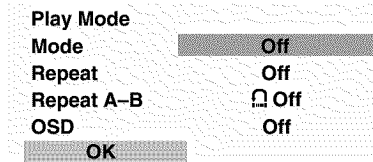

2 Press cursor ▲/▼ to select “Repeat.”

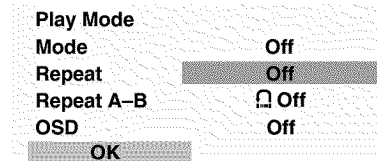

3 Press ENTER repeatedly to select the repeat mode.

- Each time you press the button, Repeat mode changes as follows:

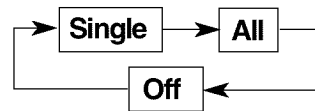

Single:

Current track be repeated. (REPEAT 1 indicator lights up.)

All:

Disc will be repeated. (REPEAT indicator lights up.)

Off:

Repeat play is canceled. (Normal play is resumed.)

4 Press cursor ▲/▼ to select “OK,” then ENTER.

The on-screen menu disappears and repeat playback starts.

To cancel repeat play

- 1) Press ENTER repeatedly to select “Off” in step 3.
- 2) Press cursor ▲/▼ to select “OK”, then press ENTER.

■ A-B Repeat

While playing, you can also select a portion you want to repeat.

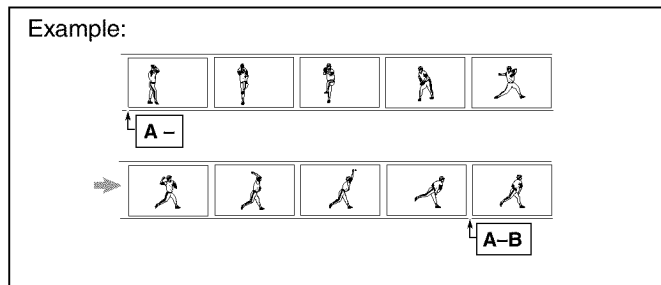

From the remote control ONLY:

1 Press ON SCREEN.

The on-screen menu appears on the TV.

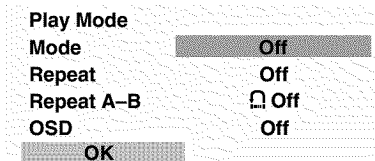

2 Press cursor ▲/▼ to select “Repeat A-B.”

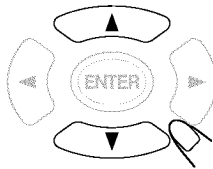
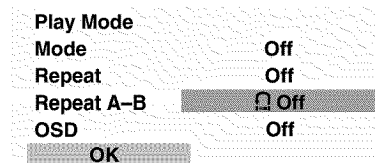

3 Press ENTER to select the start point.

“A-” appears on the display and “A-” appears on the TV.



4 Press ENTER again to select the end point.

“A-” changes to “A-B”, then A-B repeat begins. The unit automatically locates point A and starts repeated playback between points A and B.



5 Press ON SCREEN again.

The on-screen menu disappears.



To cancel A-B Repeat

- 1) Press ENTER repeatedly to select “Off” in step 3.
- 2) Press cursor ▲/▼ to select “OK”, then press ENTER. “A-B” disappears, and resume normal playback.

Playing Back Tracks in Random Order — Shuffle Play

You can playback chapters in random order.

From the remote control ONLY:

1 Press ON SCREEN.

The on-screen menu appears on the TV.

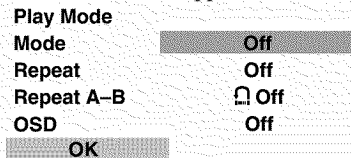

2 Press cursor ▲/▼ to select “Mode.”

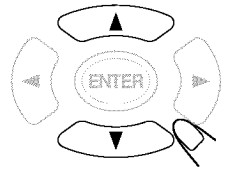
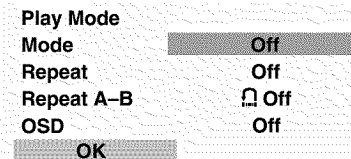

3 Press ENTER repeatedly to select “Shuffle.”

- Each time you press the button, play mode changes as follows:

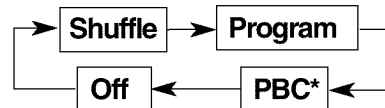

* Appears when only VCD with PBC is loaded

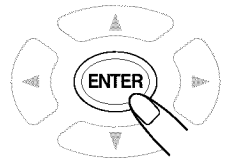

4 Press cursor ▲/▼ to select “OK”, then press ENTER.

The on-screen menu disappears.

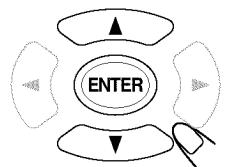

5 Press ►.

playback starts in random order.

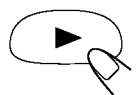

To cancel shuffle play

- 1) Press ENTER repeatedly to select “Off” in step 3.
- 2) Press cursor ▲/▼ to select “OK”, then press ENTER.

Notes:

- When all tracks have been played once, shuffle play ends.
- The same track will not be played more than once during shuffle play.

VCD/CD Playback

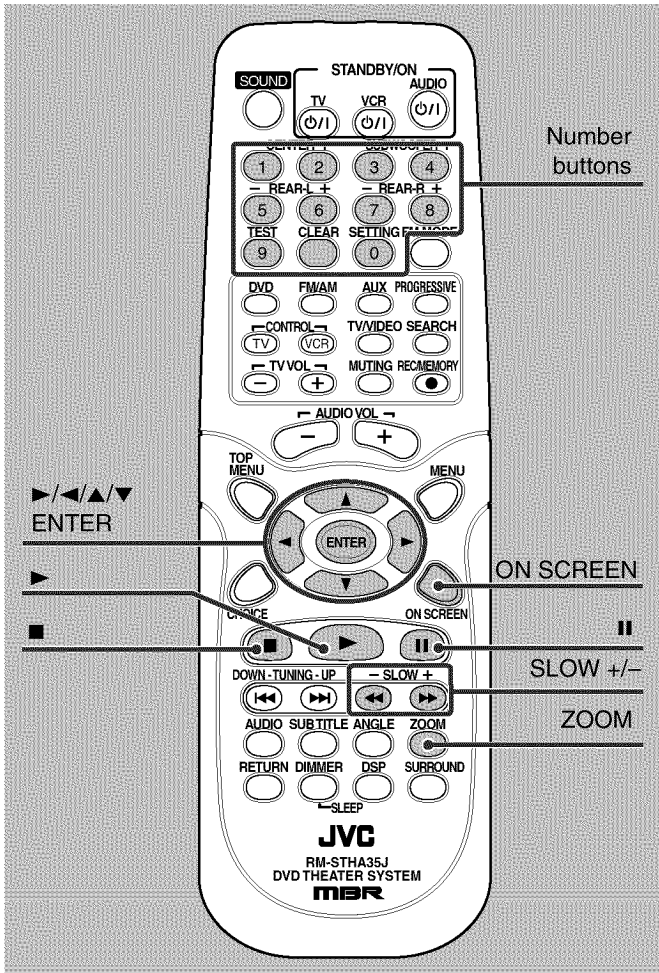

Programming the Playing Order of the Tracks — Program Play

You can arrange the track playback order before you start playing. You can program up to 12 steps.

From the remote control ONLY:

1 Press ON SCREEN.

The on-screen menu appears on the TV.

Play Mode	
Mode	Off
Repeat	Off
Repeat A-B	Off
OSD	Off
OK	



2 Press cursor ▲/▼ to select “Mode.”

Play Mode	
Mode	Off
Repeat	Off
Repeat A-B	Off
OSD	Off
OK	

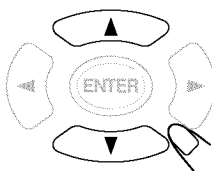

3 Press ENTER repeatedly to select “Program.”

- Each time you press the button, play mode changes as follows:

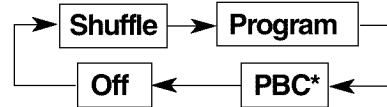

* Appears when only VCD with PBC is loaded

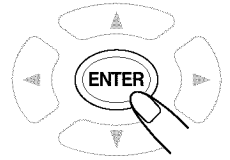

4 Press cursor ▲/▼ to select “OK”, then press ENTER.

The Program menu appears on the TV.

Track Number

Program			
1	4	7	10
2	5	8	11
3	6	9	12
Play Program Clear All			

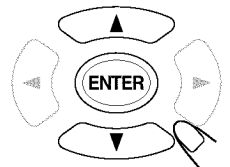

5 Press the number button to enter a track number.

Program				
1	12	4	7	10
2	5	8	11	
3	6	9	12	
Play Program Clear All				

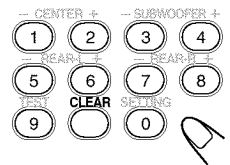

- To select number 5, press 5.
- To select number 12, press 1, 2.
- To cancel a mis-entry, press CLEAR.

6 Press cursor ►/◄/▲/▼ to select next program step.

Program				
1	12	4	7	10
2	5	8	11	
3	6	9	12	
Play Program Clear All				

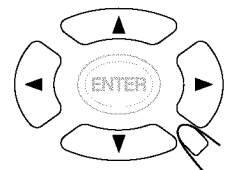

7 Repeat steps 5 to 6 to program other tracks you want.

8 Press cursor ►/◄/▲/▼ to select “Play Program”, then press ENTER.

The Program menu disappears and the PROG indicator appears on the display.

The tracks are played in the order you have programmed.

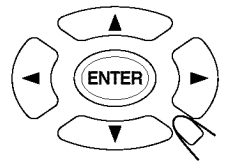

To stop during playback

Press ■.



To exit from program play

From the remote control ONLY:

- 1) Press ENTER repeatedly to select "Off" in step 3 on page 38.
 - 2) Press cursor ▲/▼ to select "OK", then press ENTER.
- Playback changes to normal play and the stored program is cleared.

To check the program contents

- 1) Press ON SCREEN.
- 2) Press cursor ▲/▼ to select "Mode."
- 3) Press ENTER repeatedly to select "Program" again even though "Program" is selected in Step 2.
- 4) Press cursor ▲/▼ to select "OK", then ENTER.

The program menu appears on the TV.

To disappear program contents, press ON SCREEN twice.

To erase the stored program

- 1) Repeat steps 1 to 4 on page 38.
- 2) Press cursor ►/◄/▲/▼ to select "Clear All", then ENTER.

To modify the program

You can modify the program while the program menu screen is shown on the TV.

- **To erase a step:** Press cursor ►/◄/▲/▼ to select (highlight) an unwanted track, then press CLEAR.
- **To modify a step:** Press cursor ►/◄/▲/▼ to select (highlight) a track you want to modify, then perform steps 5 to 6 on page 38 (Before entering a new number, press CLEAR).
- **To add a step:** Press cursor ►/◄/▲/▼ to select (highlight) an empty program step, then perform steps 5 to 6 on page 38.

VCD Special Effect Playback

■ Still Picture/Frame-by-Frame Playback

You can advance the still picture frame by frame while playing a VCD.

From the remote control ONLY:

1 Press II once during playback.

A still picture appears on the TV screen.

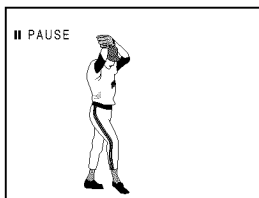

2 Press II repeatedly to advance the picture frame by frame.

- Each time you press the button, the picture advances frame by frame.



To resume normal play

Press ►.

■ Slow Motion Playback

You can enjoy slow motion playback while playing a VCD.

From the remote control ONLY:

1 Press II at the point where you want to start playback in slow-motion.

A still picture appears on the TV screen.



2 Press SLOW +.

- Each time you press the button, slow motion speed changes as follows.

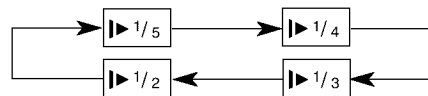

To resume normal play

Press ►.

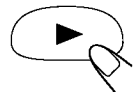

■ Zoom

You can zoom on the picture while playing back a VCD.

From the remote control ONLY:

1 Press ZOOM.

The zoom indicator appears on the TV.

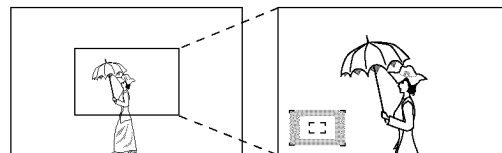

- Each time you press the button while the indicator appears, the magnification changes as follows:

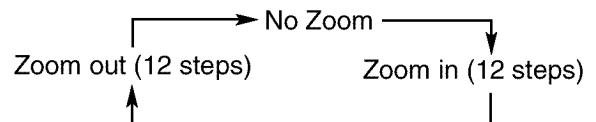

2 Press cursor ►/◄/▲/▼ to move the portion you want to watch.

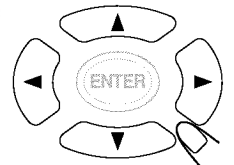

To cancel the zoom

Press ►.

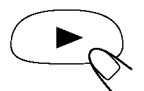

MP3 Playback

This system is incorporated with an MP3 decoder. You can playback MP3 tracks (files) recorded on CD-Rs, CD-RWs, and CD-ROMs.

- Notice that “files” and “tracks” are used interchangeably.

What is MP3?

MP3 is an abbreviation of Motion Picture Experts Group (or MPEG) Audio Layer 3. MP3 is simply a file format with a data compression ratio of 1:10 (128 Kbps*). That means, by using MP3 format, one CD-R or CD-RW can contain 10 times as much data volume as a regular CD can.

* Bit rate is the average number of bits that one second of audio data will consume. The measuring unit used is Kbps (1000 bits per second).

To get a better audio quality, choose a higher bit rate. The most popular bit rate for encoding (recording) is 128 Kbps.

MP3 File Compatibility

- This system can only read MP3 files that are recorded in the format that is compliant with ISO 9660 Level 1 or Level 2.
- The system can play MP3 files only with the following file extensions: “.MP3,” “.Mp3,” “.mp3,” and “.mp3.”
- This unit can show ID3v1* tags on the TV-screen.
- * An MP3 file can contain file information called “ID3 Tag” where its album name, performer, track title, etc. are recorded. There are two versions—ID3v1 (ID3 Tag version 1) and ID3v2 (ID3 Tag version 2).
- This unit is not compatible with ID3v2.

Disc structure—How are MP3 files recorded and played back?

“MP3 files (tracks)” can be recorded in “folders,” in PC terminology.

During recording, the files and folders can be arranged in a way similar to arranging files and folders of computer data.

“Root” is similar to the root of a tree. Every file and directory can be linked to the root.

In compliance with ISO 9660, the maximum allowable depth of nested folders—so-called “hierarchy”—is eight (inclusive of the root).

Playback order, files search order, and folder search order of the MP3 files recorded on a disc are determined by the writing (or encoding) application; therefore, playback order may be different from the one you have intended while recording the folders and the files.

NOTES for MP3 disc

- MP3 discs (either CD-R or CD-RW) require a longer readout time. (It differs due to the complexity of the folder/file configuration.)
- When an MP3 disc is loaded, you cannot adjust the subwoofer output level.

Example: MP3 disc structure and playback order

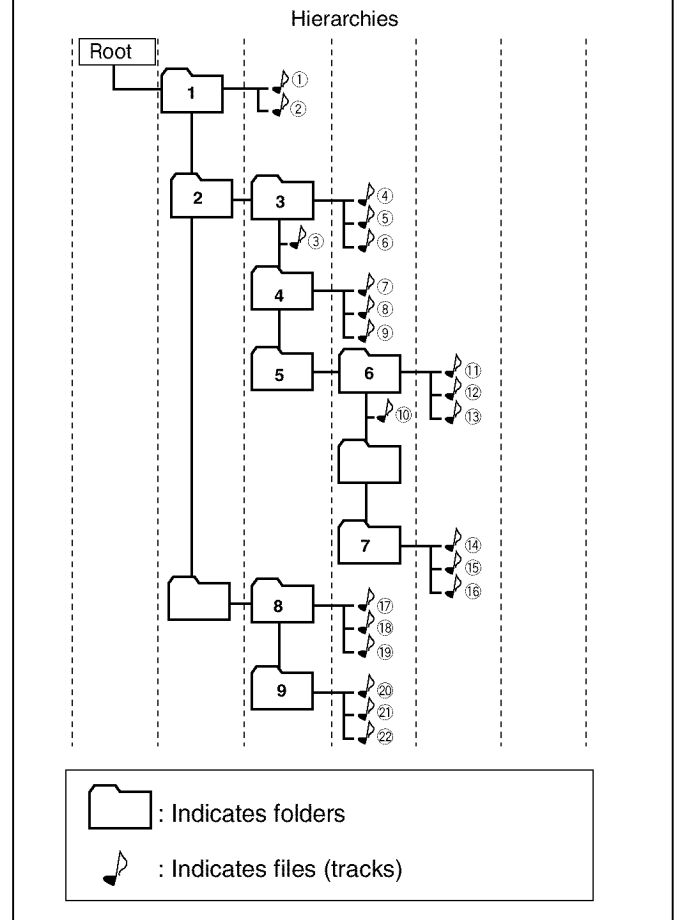

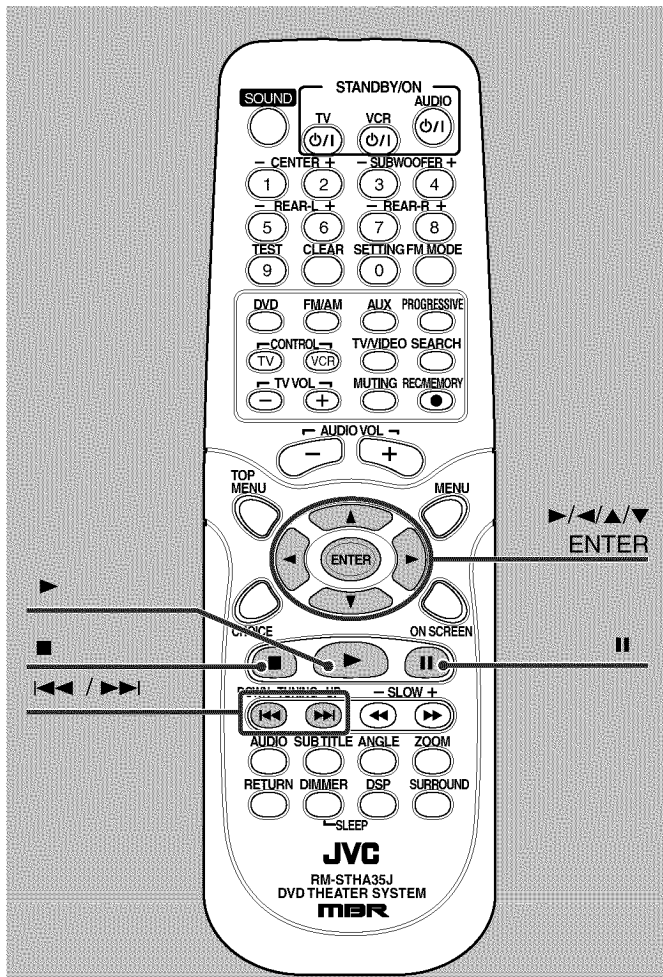

The on-screen display

①	Track number
②	Current folder name
③	Current track (file) and total number of the tracks in the current folder • Ex.: 1st track is playing out of 28 tracks recorded.
④	Play mode
⑤	Elapsed playing time
⑥	Playback track (highlight)
⑦	File information • If the MP3 file has ID3v1 tag, file information appears.

For in-depth information about a disc to be played back, see "Disc Introduction—DVD/VCD/CD" on page 24.

Starting Playback

It is recommended to turn on your TV when playing back an MP3 disc.

1 Insert an MP3 disc.

After detecting the disc, on-screen display appears on the TV.



2 Press cursor $\blacktriangleright/\blacktriangleleft/\blacktriangleup/\blacktriangledown$ to select the track, then press ENTER.

Playback starts.

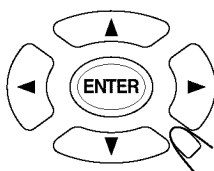

Note:

If the loaded disc is not recorded in the audio CD format, MP3 format, or JPEG format, "Error" appears on the TV screen.

To go to another track

Press $\blacktriangleright\blacktriangleright$ or $\blacktriangleleft\blacktriangleleft$ during playback.

- $\blacktriangleright\blacktriangleright$: Skip to the beginning of the next track.



- $\blacktriangleleft\blacktriangleleft$: Skip to the beginning of the previous track.



To stop playback for a moment

Press \parallel .



To resume play, press \blacktriangleright .

To stop during playback

Press \blacksquare .



To start playback again

Press \blacktriangleright .

The marked (highlight) track starts playback.



To remove the disc

Press \blacktriangleup on the front panel.

The disc tray comes out.



To close the disc tray, press \blacktriangleup again.

MP3 Playback

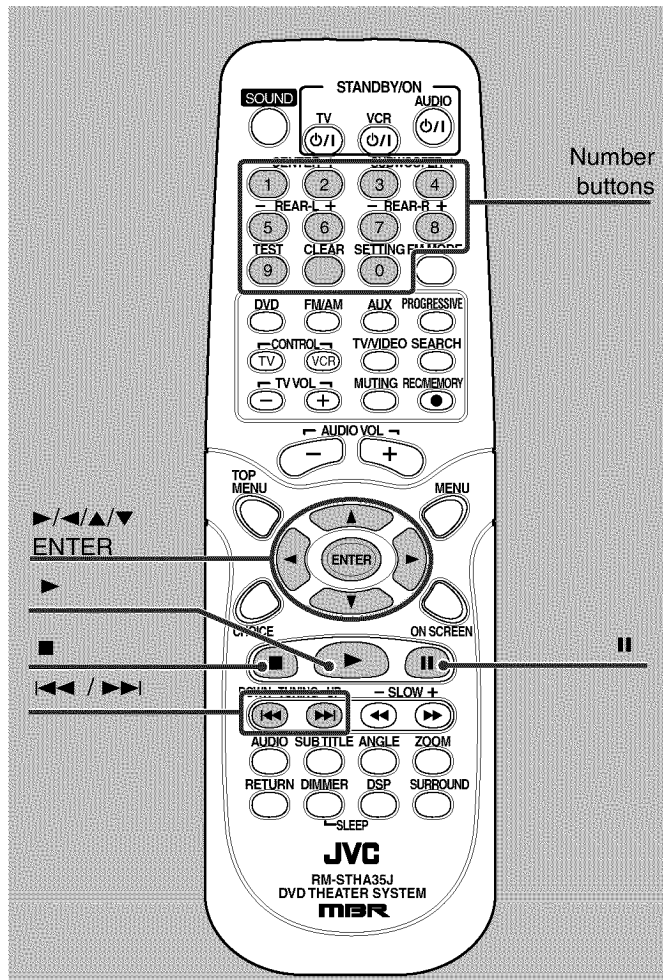

To start playback of the selected track

Press cursor **▶/◀/▲/▼** to select the track, then press ENTER.

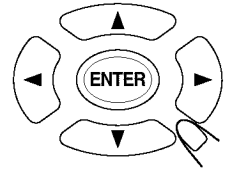

Notes:

- Only 10 tracks can be shown on the TV. To move to next 10 tracks, press cursor **▶** repeatedly. To move to previous 10 tracks, press cursor **◀** repeatedly.
- If you move to another folder, playing back stops.

Moving to a Particular Track Directly

You can move to a particular track on the current folder directly.

From the remote control ONLY:

Press the number buttons to select a track number you want.

The system starts playback from the selected track.

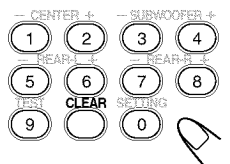

- To select number 5, press 5 then press ENTER.
- To select number 10, press 1, 0 then press ENTER.
- To select number 23, press 2, 3 then press ENTER.
- To select number 123, press 1, 2, 3 then press ENTER.

Operations Using the On-Screen Display

It is recommended to turn on your TV when playing back an MP3 disc.

When the loaded MP3 disc is recognized, the following on-screen display appears on the TV screen. (The contents of this on-screen display varies according to the disc—the way MP3 tracks were recorded on the disc.)

From the remote control ONLY:

Button	To do
ENTER	Start playback or go into a folder.
▶ / ◀ / ▲ / ▼	Select a track or folder.

Programming the Playing Order of the Tracks — Program Play

You can arrange the track playback order before you start playing.

From the remote control ONLY:

1 Press cursor **▶/◀/▲/▼** to select “Brow Disc,” then press ENTER.

“Brow Disc (Browse Disc)” changes to “Crea Prog (Create Program).”

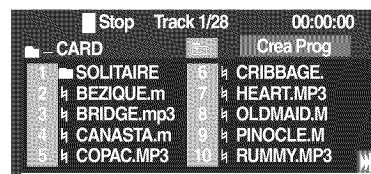
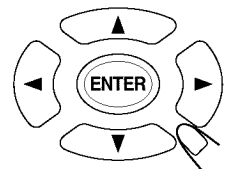

2 Press cursor **▶/◀/▲/▼** to select the track.

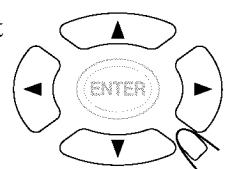

3 Press ENTER.

The selected track is marked (highlight).

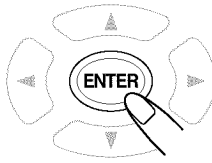

- If you press ENTER again, the marked track is canceled.

4 Repeat steps 2 to 3 to program other tracks you want.



- You can select the track in another folders.
- You cannot select same track more than once during program play.

5 Press cursor >/</▲/▼ to select "Crea Prog," then press ENTER.

"Crea Prog (Create Program)" changes to "Brow Prog (Browse Program)," and selected tracks appear on the TV.

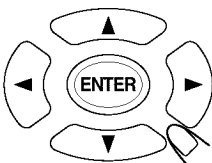
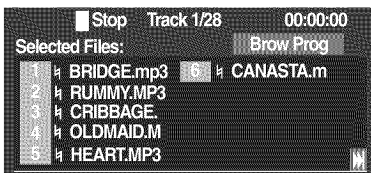

6 Press cursor >/</▲/▼ to select the start track, then press ENTER.

The tracks are played in the order you have programmed.

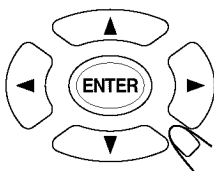

To exit from program play

From the remote control ONLY:

Press cursor >/</▲/▼ to select "Brow Prog," then press ENTER.

"Brow Prog (Browse Program)" changes to "Brow Disc (Browse disc)."

Playback stops and the stored program is cleared.

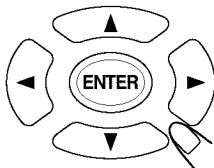

You can perform following operation same as in normal playback.

To go to another track

Press >>> or <<< during playback.

- >>> : Skip to the beginning of the next track.



- <<< : Skip to the beginning of the previous track.



To stop playback for a moment

Press II.



To resume play, press >.

To stop during playback

Press ■.



To start playback again

Press >.

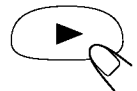

To start playback of the selected track

Press cursor >/</▲/▼ to select the track, then press ENTER.

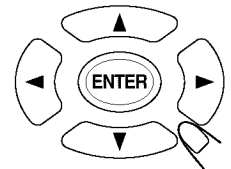

To move to a particular track directly

Press the number buttons to select a track number you want.

- To select number 5, press 5 then press ENTER.
- To select number 10, press 1, 0 then press ENTER.
- To select number 23, press 2, 3 then press ENTER.
- To select number 123, press 1, 2, 3 then press ENTER.

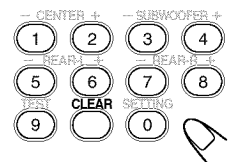

JPEG Playback

What is JPEG?

A still-picture data compression system proposed by the Joint Photographic Expert Group, which features small decrease in image quality in spite of its high compression ratio.

Disc structure

On a JPEG disc, each still picture (material) is recorded as a file. Files are usually grouped into a folder. Folders can also include another folders, creating hierarchical folder layers.

This system simplifies the hierarchical construction of a disc and manages folders by "groups."

This system can recognize up to 999 items in one folder, items including subfolders and files.

- If there is any type of files other than JPEG files in a folder, those files are also counted in the total number of 999.

NOTES for JPEG disc

- JPEG discs (either CD-R or CD-RW) require a longer readout time. (It differs due to the complexity of the directory/file configuration.)
 - When making a JPEG disc, select ISO 9660 Level 1 or Level 2 as the disc format.
 - This system supports "multi-session" discs (up to 5 sessions).
 - This system cannot play "packet write" discs.
 - The system can play JPEG files only with the following file extensions: ".jpg," ".jpeg," ".JPG," ".JPEG" and any uppercase and lowercase combination (such as ".Jpg").
 - We recommend to record a file at 640 x 480 resolution. (If a file has been recorded at a resolution of more than 640 x 480, it will take a longer time to be shown.)
 - This system can play only baseline JPEG files*. Progressive JPEG files* or lossless JPEG files* cannot be played.
 - Some JPEG discs may not be played back because of their disc characteristics or recording conditions.
- * • Baseline JPEG format: Used for digital cameras, web, etc.
• Progressive JPEG format: Used for web.
• Lossless JPEG format: An old type and rarely used now.

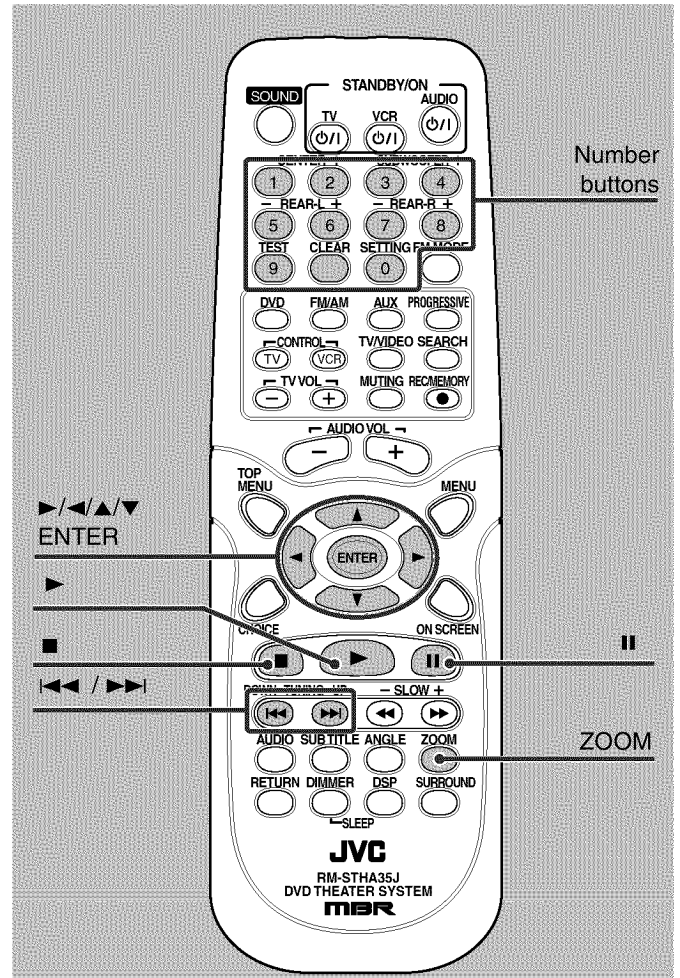

Loading the Disc

Insert a JPEG disc.

After detecting the disc, on-screen display appears on the TV.

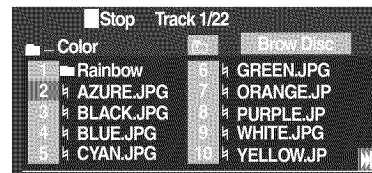

Operations Using the On-Screen Display

The on-screen display

①	File number
②	Current folder name
③	Current file and total number of the files in the current folder • Ex.: 1st file is playing out of 22 files recorded.
④	Play mode
⑤	Playback file (highlight) • When press ► to start playback slide-show, playback starts this (highlight) file.

From the remote control ONLY:

Button	To do
ENTER	Start playback or go into a folder.
► / ◀ / ▲ / ▼	Select a file or folder.

To select the file.

Press cursor ►/◀/▲/▼.

Note:

Only 10 files can be shown on the TV.
To move to next 10 files, press cursor ► repeatedly.
To move to previous 10 files, press cursor ◀ repeatedly.

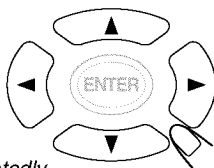

To show the selected file only

Press ENTER.

The selected file (still picture) is shown on the TV.

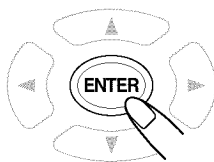

Notes

The picture size changes automatically to fit the TV-screen.

To start the slide-show playback

Press ►.

Each file (still picture) is shown on the TV for about few seconds, then changed to the next file one after another.

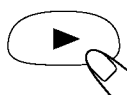

- The showing time varies depending on the file size or other factor.

To stop the slide-show playback temporarily

Press **||** on the remote control.



To resume the slide-show playback

Press ►.



To stop the slide-show playback completely

Press ■.



To skip files forward

Press ►►.



To skip files backward

Press ◀◀.



To rotate a still picture

Press cursor ►/◀/▲/▼.

When the slide-show stops and the picture is rotated on the TV.

- : ANGLE 90
- ▼: ANGLE 180
- ◀: ANGLE 270
- ▲: ANGLE 0

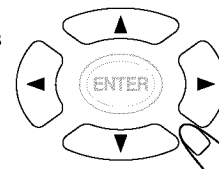

To return to normal angle, press the button again or press ▲.

To zoom in a still picture

Press ZOOM.

The zoom indicator appears on the TV.

- Each time you press the button while the indicator appears, the magnification changes as follows:

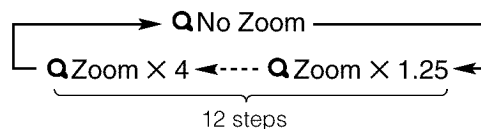

- While the picture is zoomed in, press cursor ►/◀/▲/▼ to move the portion you want to watch.

To cancel the zoom, press ►.

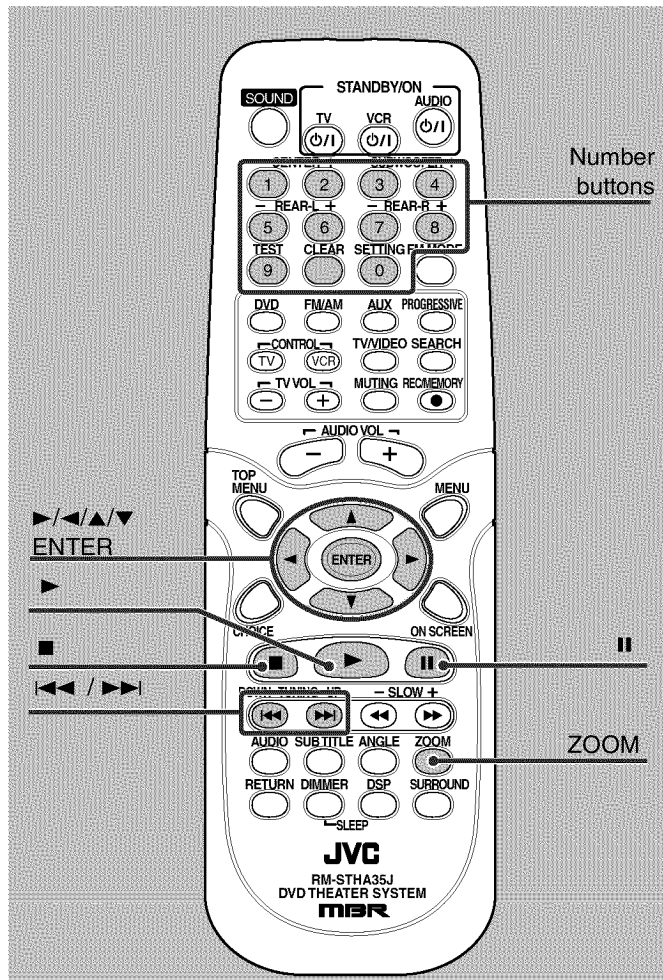

Moving to a Particular File Directly

You can move to a particular file on the current folder directly.

From the remote control ONLY:

Press the number buttons to select a file number you want.

The system starts playback from the selected file.

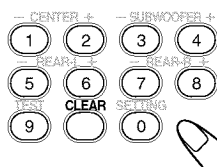

- To select number 5, press 5 then press ENTER.
- To select number 10, press 1, 0 then press ENTER.
- To select number 23, press 2, 3 then press ENTER.
- To select number 123, press 1, 2, 3 then press ENTER.

Programming the Playing Order of the Files — Program Play

You can arrange the file playback order before you start playing.

From the remote control ONLY:

- 1** Press cursor $\blacktriangleright/\blacktriangleleft/\blacktriangleup/\blacktriangledown$ to select “Brow Disc,” then press ENTER.

“Brow Disc (Browse Disc)” changes to “Crea Prog (Create Program).”

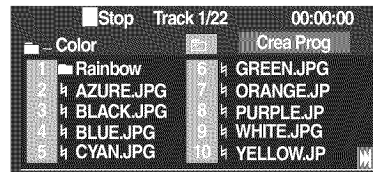
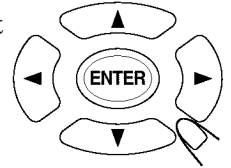

- 2** Press cursor $\blacktriangleright/\blacktriangleleft/\blacktriangleup/\blacktriangledown$ to select the file.

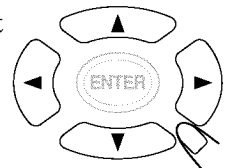
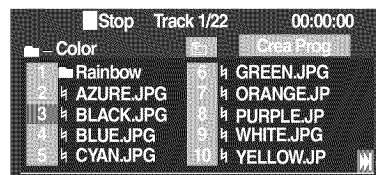

- 3** Press ENTER.

The selected file is marked (highlight).

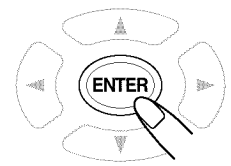

- If you press ENTER again, the marked file is canceled.

- 4** Repeat steps 2 to 3 to program other files you want.

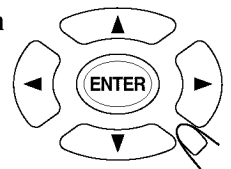

- You can select the files in another folders.
- You cannot select same file more than once during program play.

5 Press cursor ►/◄/▲/▼ to select “Crea Prog,” then press ENTER.

“Crea Prog (Create Program)” changes to “Brow Prog (Browse Program),” and selected files appear on the TV.

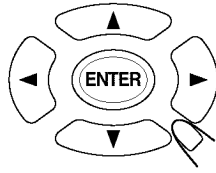
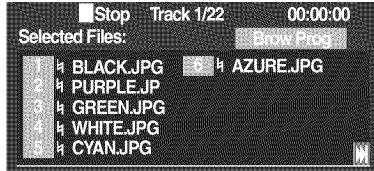

To stop during playback

Press ■.



To start playback again

Press ►.



To rotate a still picture

Press cursor ►/◄/▲/▼.

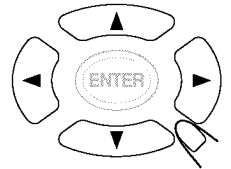

6 Press cursor ►/◄/▲/▼ to select the start file.

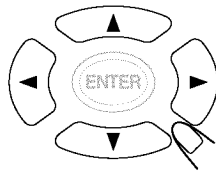

7 Press ► or ENTER.

The selected files are played in the order you have programmed.

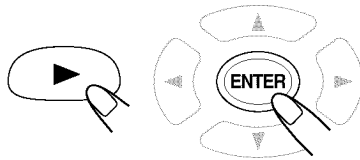

To zoom in a still picture

Press ZOOM.



To start playback of the selected file

Press cursor ►/◄/▲/▼ to select the file, then press ENTER.

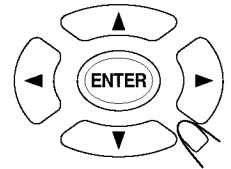

To exit from program play

From the remote control ONLY:

Press cursor ►/◄/▲/▼ to select “Brow Prog,” then press ENTER.

“Brow Prog (Browse Program)” changes to “Brow Disc (Browse disc).”

Playback stops and the stored program is cleared.

To move to a particular track directly

Press the number buttons to select a file number you want.

- To select number 5, press 5 then press ENTER.
- To select number 10, press 1, 0 then press ENTER.
- To select number 23, press 2, 3 then press ENTER.
- To select number 123, press 1, 2, 3 then press ENTER.

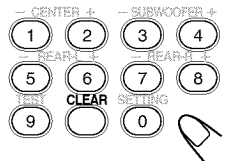

You can perform following operation same as in normal playback.

To go to another file

Press ►► or ◄◄ during playback.

- ►► : Skip to the beginning of the next file.



- ◄◄ : Skip to the beginning of the previous file.



To stop playback for a moment

Press II.



To resume play, press ►.

Tuner Operations

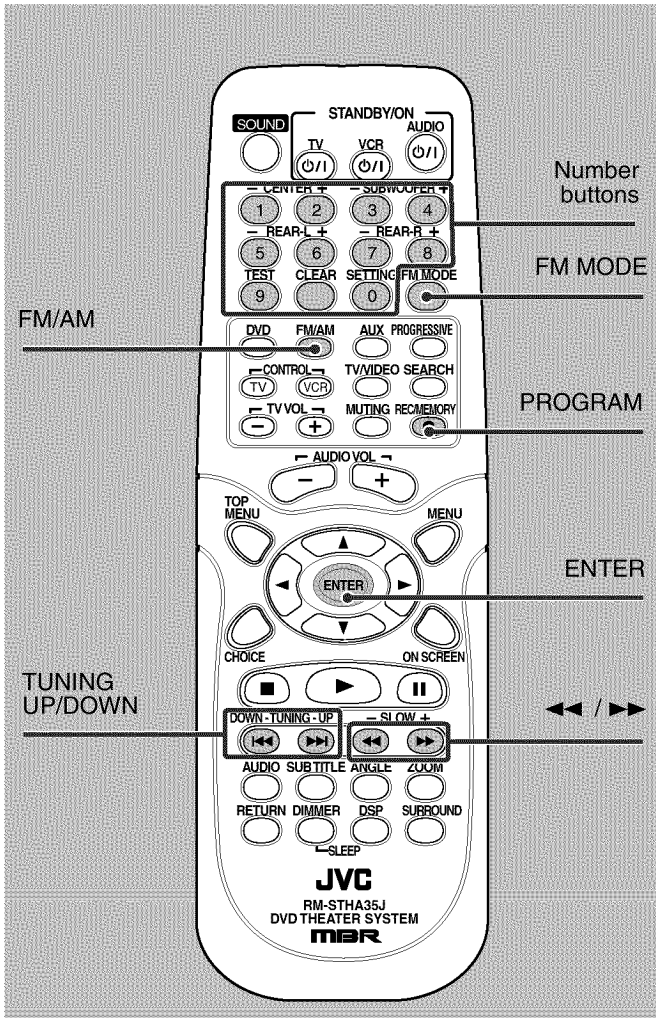

For basic tuner operations, see "Basic Tuner Operations" on page 16.

Tuning in Stations

From the remote control:

1 Press FM/AM repeatedly to select the band.

The last received station of the selected band is tuned in.

- Each time you press the button, the band alternates between FM and AM.



2 Press and hold TUNING UP or DOWN until you find the frequency you want.

- TUNING UP : Increases the frequency.
- TUNING DOWN : Decreases the frequency.

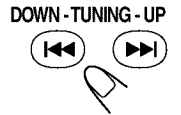

The system starts searching for stations and stops when a station of sufficient signal strength is tuned in.

- You can use the number button to enter the station frequency directly

On the front panel:

1 Press SOURCE repeatedly until the desired band appears on the display.

The last received station of the selected band is tuned in.

- Each time you press the button, the source changes as follows:

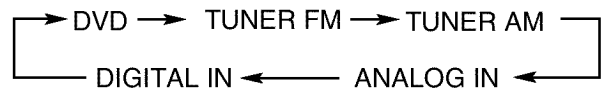

2 Press and hold >>> or <<< until you find the frequency you want.

- >>> : Increases the frequency.
- <<< : Decreases the frequency.



The system starts searching for stations and stops when a station of sufficient signal strength is tuned in.

Notes:

- When a station of sufficient signal strength is tuned in, the TUNED indicator lights up on the display.
- When an FM stereo program is received, the STEREO indicator also lights up.
- When you press the button repeatedly, the frequency changes step by step.

Using Preset Tuning

Once a station is assigned to a channel number, the station can be quickly tuned. You can preset up to 30 FM and 15 AM stations.

To store the preset stations automatically

From the remote control ONLY:

Press and hold MEMORY for a while.

“AUTO SAVE” appears on the display, and automatic preset starts.

Local stations with the strong signals are searched for and stored automatically in the band. When FM preset is over, the band changes to AM and automatic preset starts.



To store the preset stations

From the remote control ONLY:

1 Tune in the station you want to preset (see “Tuning in Stations”).



2 Press MEMORY.

“SAVE TO” appears on the display.

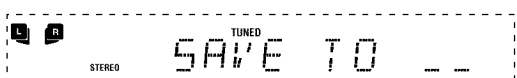

3 Press the number button to select a preset number.

- To select number 1 to 9, press the corresponding number button.
- To select number 15, press 1, 5.
- To cancel a mis-entry, press CLEAR.

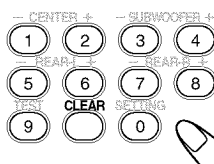

4 Press ENTER to store the preset station.

“SAVED” appears on the display and the station is assigned to the selected preset number.

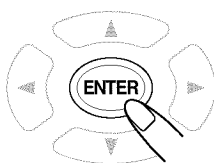

5 Repeat steps 1 to 4 until you store all the stations you want.

To erase a stored preset station

Storing a new station on a used number erases the previously stored one.

To tune in a preset station

From the remote control ONLY:

1 Press FM/AM repeatedly to select the band.

The last received station of the selected band is tuned in.

- Each time you press the button, the band alternates between FM and AM.



2 Press the number button to select a preset station.

- To select number 1 to 9, press the corresponding number button, then press ENTER.
- To select number 15, press 1, 5 then press ENTER.
- To cancel a mis-entry, press CLEAR.

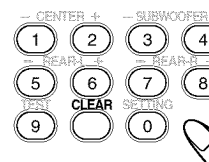

- You can press ►►/◄◄ to select the preset station.

- : Increases the preset number.
- ◄◄: Decreases the preset number.

Selecting the FM Reception Mode

When an stereo FM program tuned currently is noisy, you can change the FM reception mode to improve the reception.

From the remote control ONLY:

Press FM MODE.

The STEREO indicator goes off from the display and the program loses the stereo effect.



To resume the stereo effect, press FM MODE again. The stereo effect resumes.



Note:

The FM reception mode will also resumes in the following cases:

- When you change the frequency, the preset number, or the band
- When you change the source (If you use SOURCE button on the unit, the FM reception mode is memoried.)
- When you turn off the system

Setting up the DVD Preferences

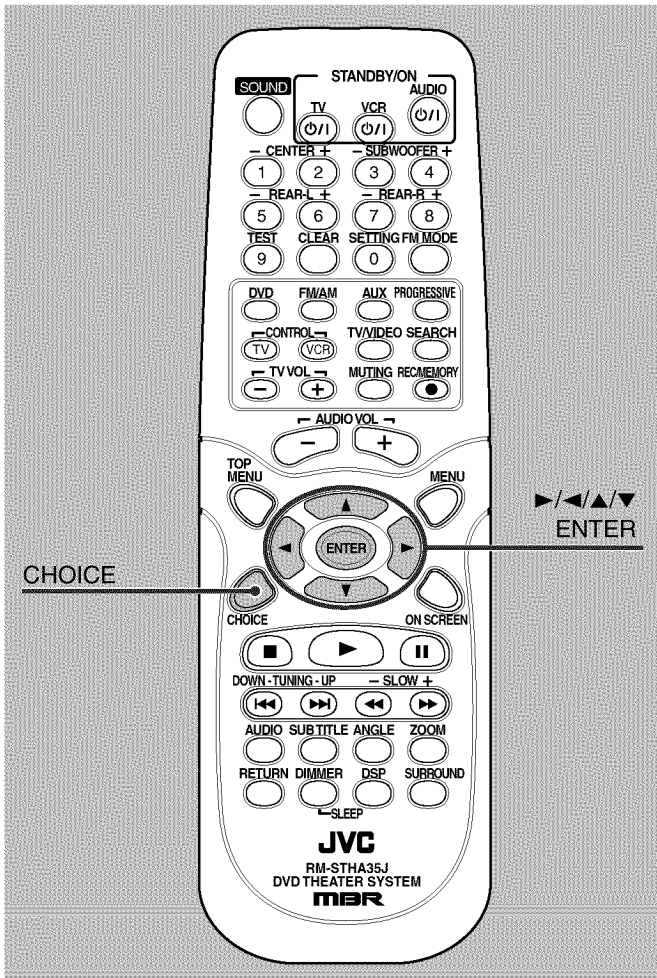

Using the Choice Menus

You can adjust the initial setting of DVD playback according to your preference or needs through five choice menus.

- You need to turn on your TV and select the correct input mode on the TV.
- You can select the choice menu only when DVD is selected as the source and playback stops.
- You can only use the remote control for the choice menu operations.
- You can change the language used in the choice menus. See page 53.

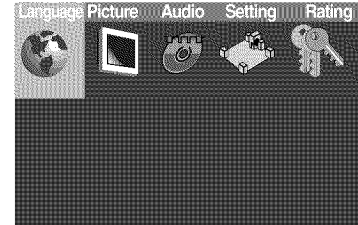

Language:	You can select the initial languages for the disc menu, audio, and subtitle. You can also select the language used on the TV screen while operating this system.
Picture:	You can select the desired options concerning a picture or monitor screen.
Audio:	The Audio menu is not used for this system.
Setting:	You can make the speaker settings according to the layout of your speakers.
Rating:	You can change the setting the parental lock. See "Setting the Parental (Rating) Level" on page 54.

Basic procedure through the choice menus

1 Press CHOICE.

The choice menu appears on the TV.

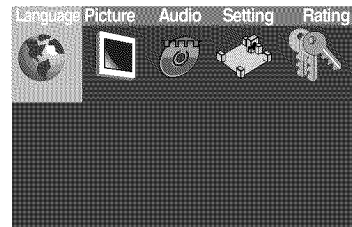

2 Press cursor ►/◄ repeatedly to select one of the choice menus—Language, Picture, Audio, Setting, or Rating.

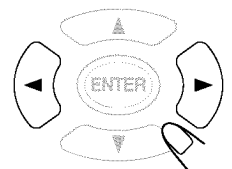

3 Press ENTER

The selected menu appears on the TV.

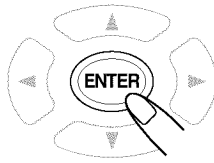
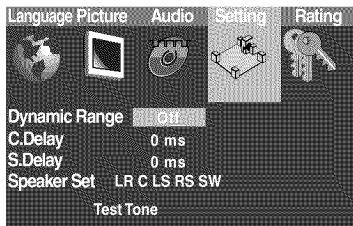

Example: When the Setting menu is selected.

4 Press cursor ▲/▼ repeatedly to select the item you want to set up.

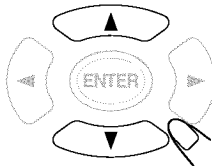

5 Press ENTER

- Each time you press the button, the setting of the item changes.

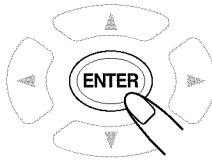
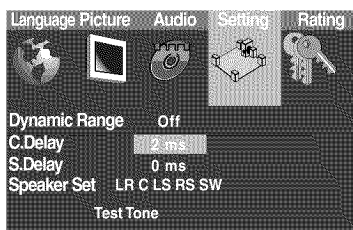

Example: When the C.Delay is selected.

Notes:

- Some choice menus consist of two pages. Selecting "Next Page" and pressing ENTER makes its next menu appear on the TV.
- Some items in the choice menus consist of sub-menus to set up. Selecting them and pressing ENTER makes its sub-menu appear on the TV. You can set them using cursor ▲/▼ and ENTER (as explained in this basic procedure). To return from the sub-menu, cursor ◀.

To move to another choice menu

Press cursor ▲ when the top of the items in the menu is selected.

Language Menu

You can select your favorite language you listen to or read on the TV screen.

When you operate this system or watch a DVD, you will be able to operate the system or to enjoy a DVD in the language you have selected and stored.

On the Language menu, you can select the following:

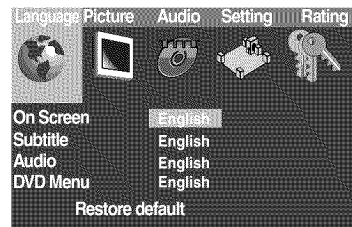

On Screen:	Select the indication language shown on the TV screen while operating the system. (ex. PLAY, STOP, PAUSE, etc.)
Subtitle:	Select the subtitle language you read while watching a DVD.
Audio:	Select the language you listen to while watching a DVD.
DVD Menu:	Select the menu language recorded on a DVD which you use while operating the DVD's own menu.
Restore default:	All choice menu settings (except for "Interlace" setting in the Picture menu, Rating level and the password in the Rating menu) return to initial setting. If you select this item and press ENTER, "System Reset" appears on the TV. To reset the settings, select "OK" and press ENTER. All choice menu settings return to initial setting, the choice menu disappears and the disc is loaded again.

Languages you can select on this menu

You can select the following languages separately for each listed item on the menu.

- For "On screen," "Audio," and "DVD Menu": English, French, and Spanish.
- For "Subtitle": English, French, Spanish, Auto and Off.

Note:

The original language will be selected as the initial language regardless of your setting in the following cases:

- If the language you have selected is not recorded on the disc.
- If the disc is programmed to be played back in the original language.

Setting up the DVD Preferences

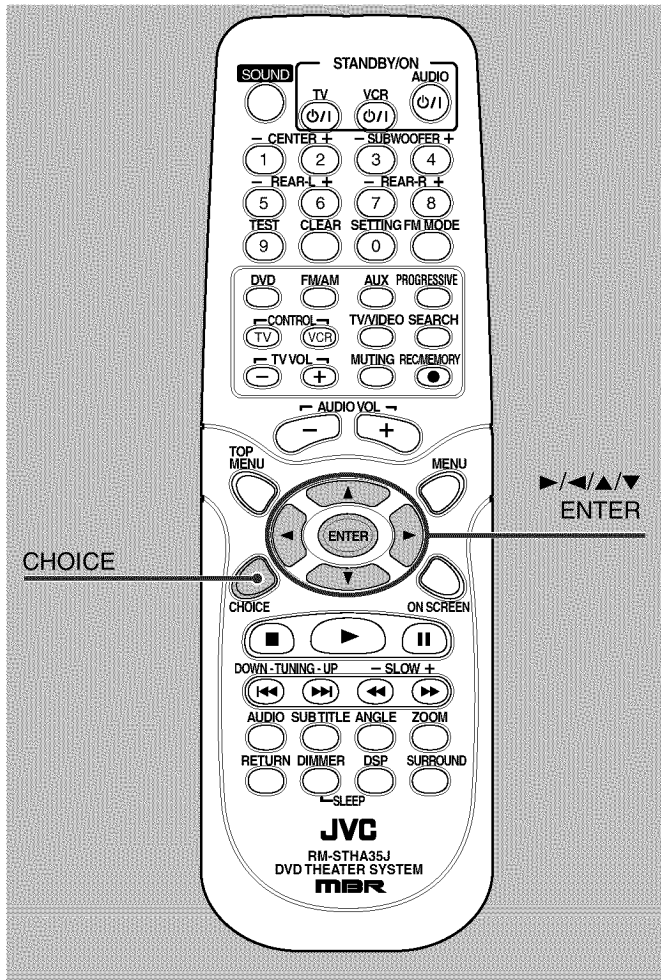

Picture Menu

You can select the desired options concerning a picture or monitor screen.

On the Picture menu, you can set the following:

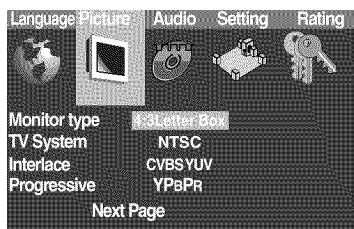

Monitor Type: Select the TV screen size for playing back a DVD recorded with 16:9 wide screen video signal.

- **4:3 Letter Box:** Select "4:3 Letter Box" when the aspect ratio of your TV is 4:3. While viewing a wide screen picture, the black bars appear on the top and the bottom of the screen.

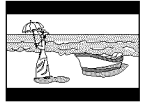

- **4:3 Pan-Scan:** Select "4:3 Pan-Scan" when the aspect ratio of your TV is 4:3. While viewing a wide screen picture, the black bars do not appear, however, the left and right edge sides of the pictures will not be shown on the screen.

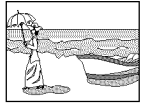

- **16:9 Wide:** Select "16:9 Wide" when the aspect ratio of the TV is 16:9. (Set the screen size to full on your TV.)

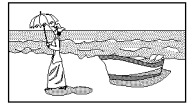

TV System: You cannot select this item.

Interlace: Select the video signal type.

- **CVBS S_Video:** Select this when you use the S-Video cord to connect a TV.
- **CVBS YUV:** Select this when you do not use the S-Video cord to connect a TV.

Progressive: You cannot select this item.

TE Mode: You can select the TE (Transition Effect) mode.

- **On:** When the picture changes and appears on the TV, the picture appears with transition effect.
- **Off:** The picture appears without effect.

Pause/Still: You can change this mode to get better pictures when the picture is unclear or noisy. Normally select "AUTO." If the picture on a disc is unclear or noisy, select "Frame" or "Field."

- **Frame:** Select this when the small text or fine patterns cannot be seen clearly.
- **Field:** Select this when the moving picture is noisy.
- **Auto:** Normally select this mode. The system selects the appropriate mode automatically.

Audio Menu

The Audio menu is not used for this system.

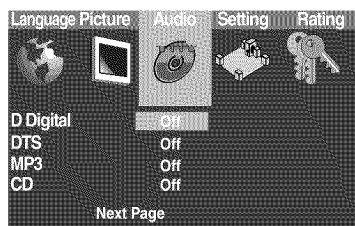

D Digital / DTS / MP3 / CD / PCM / DownSampling :
• Off

Setting Menu

You can make the speaker settings according to the layout of your speakers.

On the Setting menu, you can set the following:

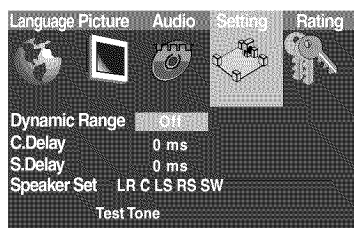

Dynamic Range: You can enjoy a powerful sound at night even at a low volume level when listening to the sound with Dolby Digital.

- **On:** Select this when you want to apply the compression effect fully (useful at midnight.)
- **Off:** Select this when you want to enjoy surround with its full dynamic range (no effect applied.)

C.Delay: To register delay time for center speaker—from 0 msec to 5 msec. See “Setting the delay time” on right column.

R.Delay: To register delay time for rear speakers—from 0 msec to 15 msec. See “Setting the delay time” on right column.

Speaker Set: Enters Speaker setting sub-menu. See “Speaker setting” on right column.

Test Tone: The test tone menu appears on the TV and the test tone comes out from the speakers in the order. See “Adjusting the Sound” on page 23.

- If a disc is not loaded, the test tone does not come out.
- If there is a speaker from which no sounds comes out, check the speaker’s connection (see pages 6 and 7.)

Setting the delay time

Adjust the delay time of the sounds from the center speaker and the rear speakers, comparing to that of the sounds from the front speakers. If the distance to the center speaker and/or the rear speakers from your listening point is almost the same as from the front speakers, select “0 ms (msec).”

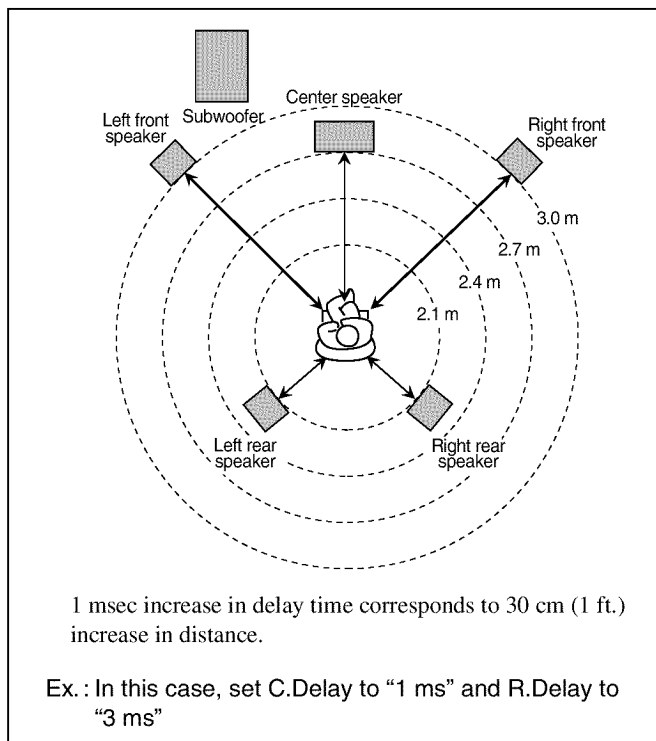

Speaker setting

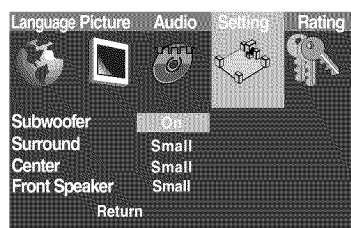

Subwoofer: You cannot select this item.

Surround / Center / Front Speaker:

Select the speaker setting according to the layout of your speakers. (You cannot select “Off” for the front speakers.)

- **Small:** Select this when the cone speaker unit built in the speaker is smaller than 12 cm (4³/₄ inches). (Select this when using the supplied speakers.)
- **Off:** Select this when the center speaker and/or rear speakers are not connected or not in use. If you want to enjoy monaural source with the front speakers, select “Off” for the center speaker.

Return: Return to the Setting menu.

Setting up the DVD Preferences

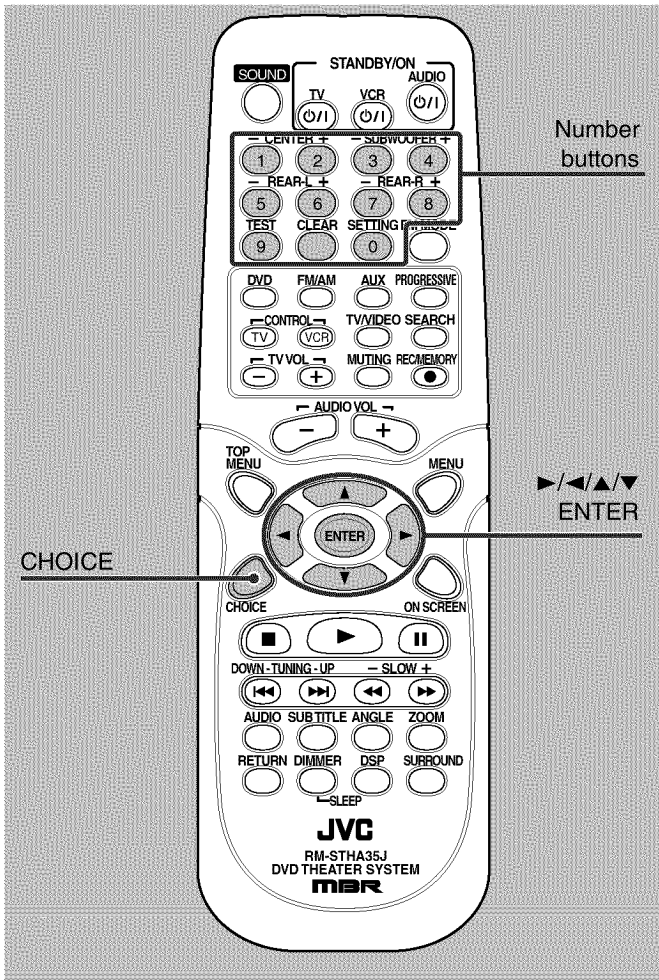

From the remote control ONLY:

1 Press CHOICE.

The choice menu appears on the TV.



2 Press cursor ► repeatedly to select “Rating.”

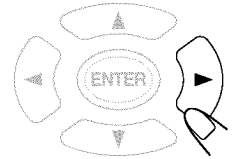

3 Press ENTER.

The Rating menu appears on the TV.

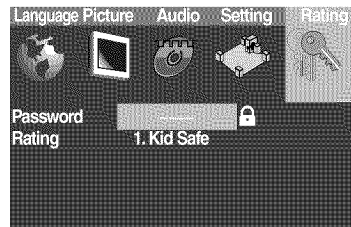
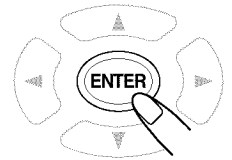

4 Press the number buttons to enter the password (4 digits), then ENTER.

“” changes to “” on the menu.

- If you forget your password, enter “1987”

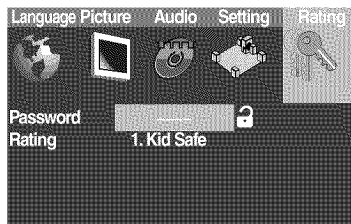
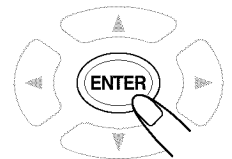
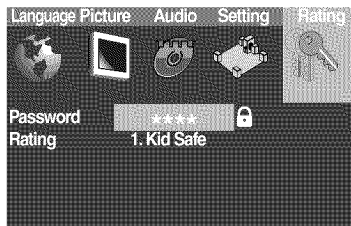
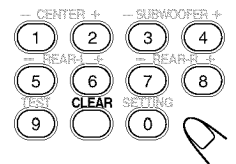

Setting the Parental (Rating) Level

Using this function, you can restrict playback of DVD containing violent scenes and those not suitable for your family members. Nobody can play such a disc unless this function is canceled (See “To release the parental lock temporarily” below.)

- This setting takes effect only for the DVDs containing the rating level information—“1. Kid Safe” (most restrictive) to “8. Adult” (least restrictive).

5 Press cursor ▼ to select “Rating.”

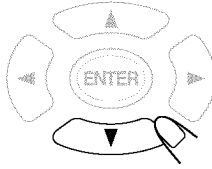
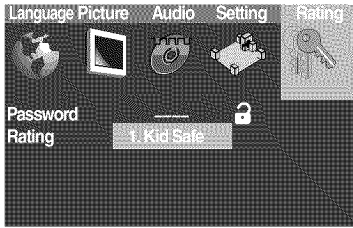

■ To change the password

1 Repeat steps 1 to 4 of “Setting the Parental (Rating) Level” procedure.

2 Press the number buttons to enter a new password (4 digits), then ENTER.

“” changes to “” on the menu. Your new password is now stored.

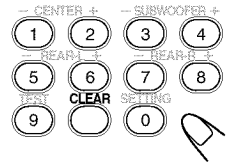

- If you do not release the parental lock (“” appears on the TV), cannot select “Rating.”

6 Press ENTER repeatedly to select the level you want.

- Each time you press the button, the parental (rating) level changes.

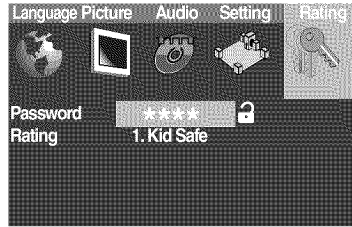
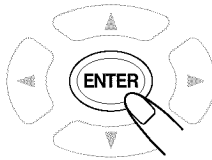

7 Press cursor ▲ to select “Password”, then press the number buttons to enter the password (4 digits) and ENTER.

“” changes to “” on the menu, and the parental level changes.

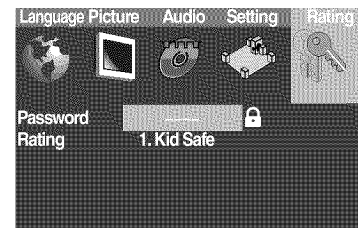
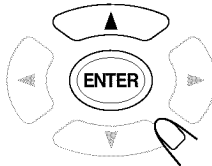
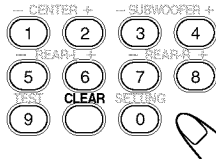

■ To release the parental lock temporarily

When you set a strict parental level, some discs may not be played back at all.

If you try to playback such a disc, you need to input the password to release parental lock temporarily (“Password ----” and “Parental Locked” appear on the TV.)

You cannot play the disc before you enter the correct password.

When you enter wrong passwords more than three times, “Parental Lock” appears on the TV and playback stops.

Operating JVC's Components

You can use the remote control to operate not only this unit but also other JVC products.

- Refer also to the manuals supplied for the other products.
 - This remote control can operate a VCR whose remote control code is set to A code.
- To operate the other products, aim the remote control directly at the remote sensor on the target product.

□ To operate a JVC's TV

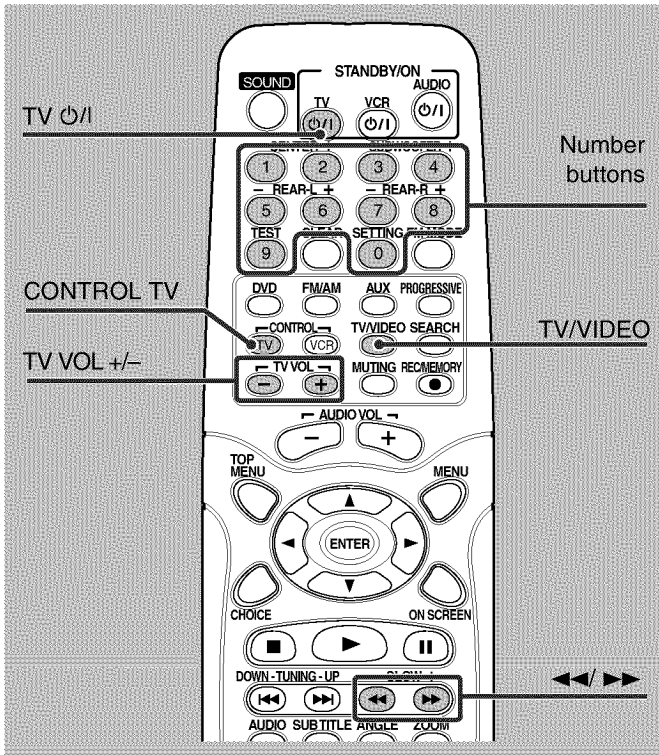

After pressing **CONTROL TV** on the remote control, you can perform the following operations on the TV.

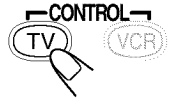

TV $\phi/1$:	Turn on or off the TV.
TV VOL +/-:	Adjust the volume.
TV/VIDEO:	Set the input mode (either TV or VIDEO).
1 – 9, 0:	Select the channel.
\leftarrow/\rightarrow:	Change the channels.

□ To operate a JVC's VCR

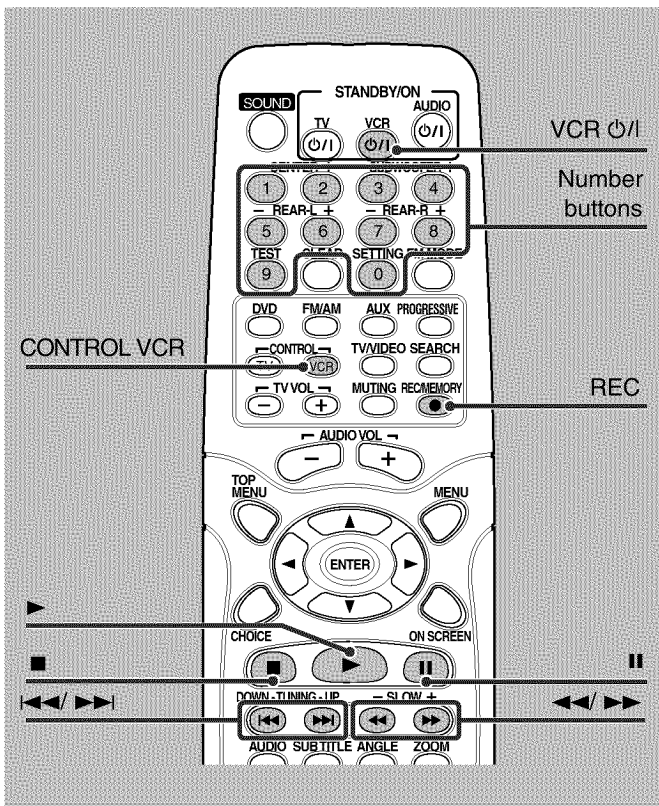

After pressing **CONTROL VCR** on the remote control, you can perform the following operations on the VCR.

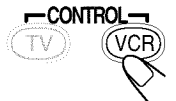

VCR $\phi/1$:	Turn on or off the VCR.
\leftarrow/\rightarrow:	Change the channels.
1 – 9, 0:	Select TV channel on the VCR.
\blacktriangleright:	Start playback.
\blacksquare:	Stop operation.
\parallel:	Pause playback. To release it, press \blacktriangleright .
REC(\bullet):	Press this button with \blacktriangleright to start recording. Press this button and \parallel , to enter recording pause. To release it, Press \parallel .
$\blacktriangleright\blacktriangleright$:	Fast-wind a tape.
$\blacktriangleleft\blacktriangleleft$:	Rewind a tape.

IMPORTANT:

When you press **CONTROL TV** or **CONTROL VCR**, some buttons on the remote control cannot work for operating the system.

To operate the system, press **DVD, FM/AM** or **AUX**.

Operating Other Manufacturers' TV

You can use the remote control to operate other manufacturers' TV.

- Refer also to the manuals supplied for the other products.
- To operate the other products, aim the remote control directly at the remote sensor on the target product.

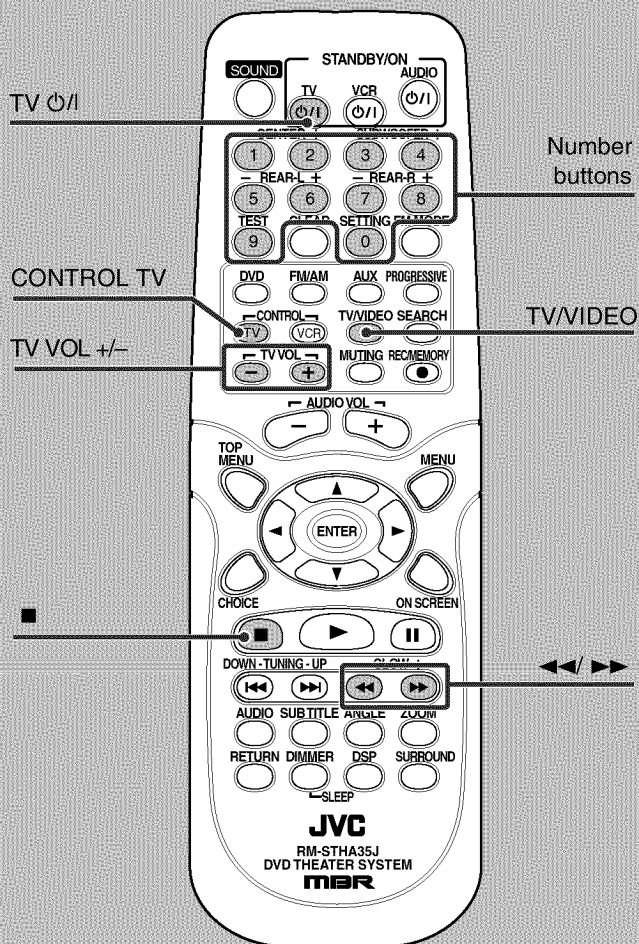

□ To change the transmittable signals for operating a TV

1. Press **CONTROL TV**.
2. Press and hold **TV On/Off**.
3. Enter manufacturer's code using buttons **1-9**, and **0**.
4. Press **■**.
5. Release **TV On/Off**.

Now, you can perform the following operations on the TV.

TV On/Off:	Turn on or off the TV.
TV VOL +/-:	Adjust the volume.
TV/VIDEO:	Set the input mode (either TV or VIDEO)
1 - 9, 0:	Select the channel.
Left/Right Arrow:	Change the channels.

6. Try to operate your TV by pressing **TV On/Off**.
When your TV turns on or off, you have entered the correct code.

If there are more than one code listed for your brand of TV, try each one until the correct one is entered.

Manufacturers' codes for TV

Manufacturer	Codes
JVC	01, 23, 24, 25
FUNAI	32
GRUNDIG	19
HITACHI	10
LG (GOLDSTAR)	18
MAGNAVOX	02
MITSUBISHI	03
NEC	20
NOKIA	31
PANASONIC	04, 11
PHILIPS	02
RCA	05
SAMSUNG	12, 33, 34, 35
SANYO	13, 16
SHARP	06
SONY	07
THOMSON	26
TOSHIBA	08, 14
ZENITH	09

Manufacturers' codes are subject to change without notice. If they are changed, this remote control cannot operate the equipment.

Maintenance

To get the best performance of the unit, keep your discs and mechanism clean.

General Notes

In general, you will have the best performance by keeping your discs, and the mechanism clean.

- Store discs in their cases, and keep them in cabinets or on shelves.
- Keep the disc tray closed when not in use.

Handling Discs



- Remove the disc from its case by holding it at the edge while pressing the center hole lightly.
- Do not touch the shiny surface of the disc, or bend the disc.
- Put the disc back in its case after use to prevent warping.

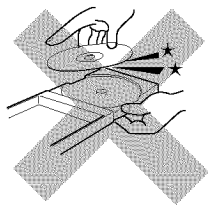

- Be careful not to scratch the surface of the disc when placing it back in its case.
- Avoid exposure to direct sunlight, temperature extremes, and moisture.



To clean the disc

Wipe the disc with a soft cloth in a straight line from center to edge.

DO NOT use any solvent—such as conventional record cleaner, spray, thinner, or benzine—to clean the disc.

Cleaning the unit

• Stains on the unit

Should be wiped off with a soft cloth. If the unit is heavily stained, wipe it with a cloth soaked in water-diluted neutral detergent and wrung well, then wipe clean with a dry cloth.

• Since the unit may deteriorate in quality, become damaged or get its paint peeled off, be careful about the following.

- DO NOT wipe it with a hard cloth.
- DO NOT wipe it strong.
- DO NOT wipe it with thinner or benzine.
- DO NOT apply any volatile substance such as insecticides to it.
- DO NOT allow any rubber or plastic to remain in contact with it for a long time.

Troubleshooting

Use this chart to help you solve daily operational problems. If there is any problem you cannot solve, contact your JVC service center.

PROBLEM	POSSIBLE CAUSE	SOLUTION
Power does not come on.	The power cord is not plugged in.	Insert the plug into the socket.
The remote control does not work.	<ul style="list-style-type: none"> • It is too far from the center unit, or is not facing the center unit. • There is something obstructing the remote sensor. • The CONTROL VCR or CONTROL TV button has been pressed. • The battery is flat. • The battery has been inserted the wrong way round (+/-). • Sunlight is falling directly on the detector. 	<ul style="list-style-type: none"> • Come close to the center unit. • Avoid any obstacles. • Press DVD, FM/AM or AUX to operate the system. (See page 56) • Replace the battery. • Insert the battery correctly. • Shade the remote control from direct sunlight.
No sound.	<ul style="list-style-type: none"> • There is a short in the speaker cord. • The audio cord is not connected properly. • An incorrect source has been selected. • Muting is on. • The disc is copy-protected CD. 	<ul style="list-style-type: none"> • Reconnect the speaker cord. • Connect the cord properly. (See page 8.) • Select the correct source. (See pages 12 to 18.) • Press MUTING to cancel muting. • Replace the disc.
Sound is emitted from only one speaker.	<ul style="list-style-type: none"> • The speaker cord is not connected correctly. 	<ul style="list-style-type: none"> • Connect the cord properly. (See page 7.)
No video.	<ul style="list-style-type: none"> • The video cord is not connected properly. • TV input selection is incorrect. 	<ul style="list-style-type: none"> • Connect the cord properly. (See page 9.) • Select the correct input.
A disc cannot be played.	<ul style="list-style-type: none"> • The system and disc region code numbers are incompatible. • The disc causes the parental (rating) error. 	<ul style="list-style-type: none"> • Replace the disc. (See page 24.) • Enter password to change the parental (rating) level. (See page 54.)
"Error" appears on the TV screen.	<ul style="list-style-type: none"> • The CD-R/RW is not recorded in the audio CD format, MP3 format, or JPEG format. 	<ul style="list-style-type: none"> • Replace the disc.
Video and audio are distorted.	<ul style="list-style-type: none"> • The disc is dirty. • A VCR is connected between the center unit and the TV. 	<ul style="list-style-type: none"> • Clean the disc. • Connect the center unit and TV directly.
The moving picture is noisy.	<ul style="list-style-type: none"> • "Pause/Still" mode may not be set appropriately for the current disc. 	<ul style="list-style-type: none"> • Select "Field" on "Pause/Still" mode. (See page 52.)
The edge is missing on the video image.	<ul style="list-style-type: none"> • Initial setup (Monitor Type) was incorrect. 	<ul style="list-style-type: none"> • Set Monitor Type correctly. (See page 52.)
No picture is displayed on the TV screen, the picture is blurred, or the picture is divided into two parts.	<ul style="list-style-type: none"> • The scanning mode is set to "P-SCAN" though the system is connected to the TV which does not support the progressive video input such a conventional TV. 	<ul style="list-style-type: none"> • Change the scanning mode to "INTERLACE." (See page 11.)
Continuous static during FM broadcasts.	<ul style="list-style-type: none"> • The received signal is too weak. • The station is too far away. • The antenna is not connected correctly. 	<ul style="list-style-type: none"> • Connect an external FM antenna (see page 5), or contact your dealer. • Select another station. • Check the connection. (See page 5.)
The system does not work correctly.	<ul style="list-style-type: none"> • Lightning or electronic noise interferes with operation of the microcomputer. • Immediately after beginning to heat the room, the unit was moved to a cold location causing condensation to form inside. 	<ul style="list-style-type: none"> • Switch power off, and remove and re-insert the power plug in the socket. • Switch power off and leave the unit a few hours before switching power on again.
The VCR cannot be operated using this remote control.	<ul style="list-style-type: none"> • The remote control is not set for VCR operations. • The VCR is not a JVC's product. 	<ul style="list-style-type: none"> • Press CONTROL VCR to operate the VCR. (See page 56.) • This remote control can operate a JVC's VCR whose remote control code is set to A code.

Specifications

Center unit (XV-THA35)

Amplifier section

Front/Center/Rear:

45 watts per channel, min. RMS at 6 ohms as 1 kHz, with no more than 10 % total harmonic distortion.

Subwoofer:

100 watts, min. RMS at 10 ohms as 100 Hz, with no more than 10 % total harmonic distortion.

Audio section

Audio input sensitivity/Impedance (at 1 kHz)

Analog input:

AUX ("AUX IN"): 500 mV/47 k Ω

Digital input*:

DIGITAL IN (OPTICAL):

-21 dBm to -15 dBm (660 nm \pm 30 nm)

* Corresponding to Linear PCM, Dolby Digital, and DTS Digital Surround (with sampling frequency — 32 kHz, 44.1 kHz, 48 kHz)

Video section

Color System: NTSC

Horizontal Resolution: 480 lines

Signal-to-Noise Ratio: 68 dB

Output Level

VIDEO(Composite): 1.0 V(p-p)/75 Ω

S-VIDEO(Y): 1.0 V(p-p)/75 Ω

(C): 0.286 V(p-p)/75 Ω

COMPONENT VIDEO OUT

Y: 1.0 V(p-p)/75 Ω

P_B/P_R: 0.7 V(p-p)/75 Ω

Tuner section

Tuning Range FM: 87.5 MHz – 108.0 MHz

AM: 530 kHz – 1 710 kHz

General

Readable Discs: DVD VIDEO, Video CD, Super Video CD, Audio CD, CD-R/RW (Audio CD, Video CD, Super Video CD, MP3 disc, and JPEG disc), DVD-R (Video format)

Power Requirements: AC 120 V \sim , 60 Hz

Power Consumption: 180 W (at operation)
2 W (in standby mode)

Dimensions (W \times H \times D): 360 mm \times 65 mm \times 360 mm
(14 ³/₁₆ in. \times 2 ⁹/₁₆ in. \times 14 ³/₁₆ in.)

Mass: 6.6 kg (14.6 lbs)

Center unit (XV-THA32)

Amplifier section

Front/Center/Rear:

40 watts per channel, min. RMS at 6 ohms as 1 kHz, with no more than 10 % total harmonic distortion.

Subwoofer:

100 watts, min. RMS at 10 ohms as 100 Hz, with no more than 10 % total harmonic distortion.

Audio section

Audio input sensitivity/Impedance (at 1 kHz)

Analog input:

AUX ("AUX IN"): 500 mV/47 k Ω

Digital input*:

DIGITAL IN (OPTICAL):

-21 dBm to -15 dBm (660 nm \pm 30 nm)

* Corresponding to Linear PCM, Dolby Digital, and DTS Digital Surround (with sampling frequency — 32 kHz, 44.1 kHz, 48 kHz)

Video section

Color System: NTSC

Horizontal Resolution: 480 lines

Signal-to-Noise Ratio: 68 dB

Output Level

VIDEO(Composite): 1.0 V(p-p)/75 Ω

S-VIDEO(Y): 1.0 V(p-p)/75 Ω

(C): 0.286 V(p-p)/75 Ω

COMPONENT VIDEO OUT

Y: 1.0 V(p-p)/75 Ω

P_B/P_R: 0.7 V(p-p)/75 Ω

Tuner section

Tuning Range FM: 87.5 MHz – 108.0 MHz

AM: 530 kHz – 1 710 kHz

General

Readable Discs: DVD VIDEO, Video CD, Super Video CD, Audio CD, CD-R/RW (Audio CD, Video CD, Super Video CD, MP3 disc, and JPEG disc), DVD-R (Video format)

Power Requirements: AC 120 V \sim , 60 Hz

Power Consumption: 180 W (at operation)
2 W (in standby mode)

Dimensions (W \times H \times D): 360 mm \times 65 mm \times 360 mm
(14 ³/₁₆ in. \times 2 ⁹/₁₆ in. \times 14 ³/₁₆ in.)

Mass: 6.6 kg (14.6 lbs)

Subwoofer (SP-WA35)

Speaker: 16 cm (6 ⁵/₁₆ in.)
Bass-reflex, Magnetically Shielded

Power Handling Capacity: 100 W

Impedance: 10 Ω (min)

Frequency Range: 25 Hz to 200 Hz

Dimensions (W \times H \times D): 202 mm \times 330 mm \times 341 mm
(8 in. \times 13 in. \times 13 ⁷/₁₆ in.)

Mass: 4.8 kg (10.6 lbs)

Satellite Speakers (SP-THA35F)

Speakers: 8 cm (3 ¹/₁₆ in.)
Bass-reflex, Magnetically Shielded

Power Handling Capacity: 45 W

Impedance: 6 Ω (min)

Frequency Range: 90 Hz to 20 kHz

Dimensions (W \times H \times D): 92 mm \times 97.5 mm \times 92 mm
(3 ⁵/₈ in. \times 3 ⁷/₈ in. \times 3 ⁵/₈ in.)

Mass: 650 g (1.5 lbs)

Designs & specifications are subject to change without notice.

Authorized Service Centers

QUALITY **JVC**[®] SERVICE

HOW TO LOCATE YOUR JVC SERVICE CENTER

TOLL FREE: 1 (800) 537-5722

<http://www.jvc.com>

Dear Customer,

In order to receive the most satisfaction from your purchase, please read the instruction booklet before operating the unit. In the event that repairs are necessary, please call 1 (800)537-5722 for your nearest authorized servicer or visit our website at **www.JVC.com**

Remember to retain your Bill of Sale for Warranty Service.

Do not service the television yourself

Caution

To prevent electrical shock, do not open the cabinet. There are no user serviceable parts inside. Please refer to qualified service personnel for repairs.

Accessories

To purchase accessories for your JVC product, please call toll free: 1 (800)882-2345 or on the web at **www.JVC.com**

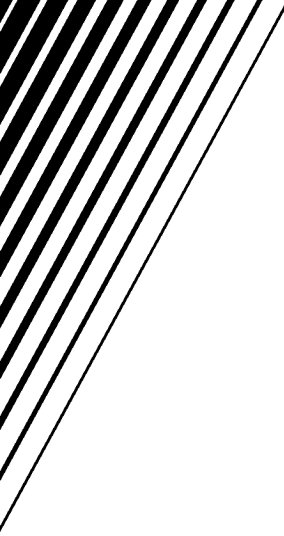

JVC
VICTOR COMPANY OF JAPAN, LIMITED