



Dual Fuel Range

Use & Care Guide

Estufa de fuel dual

Guía para el Uso y Cuidado

Models, Modelos **790.7991***

*= color number, número de color

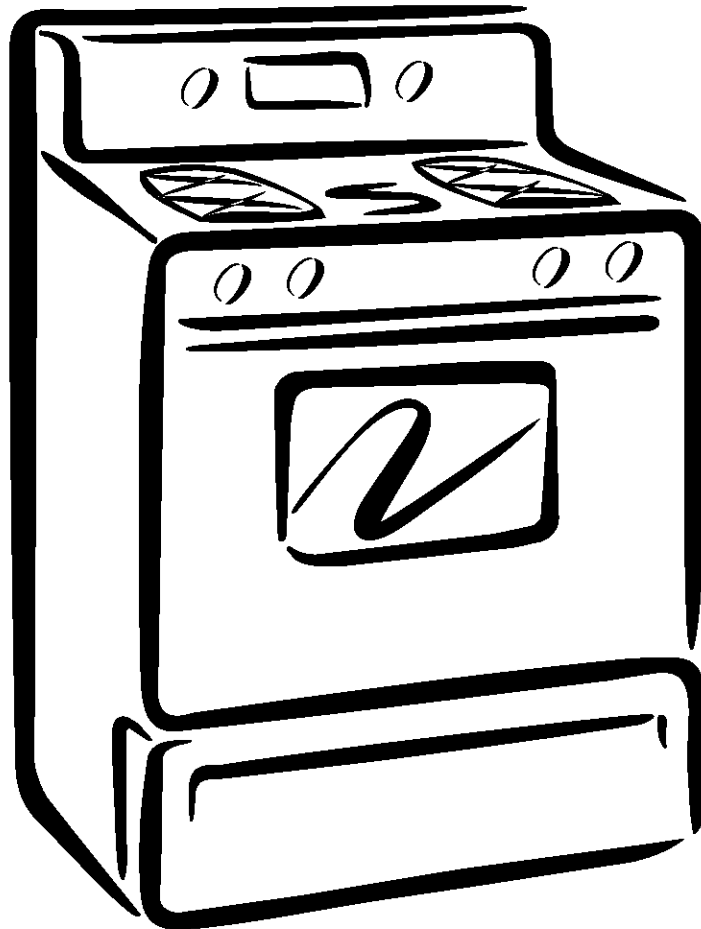

ENGLISH

ESPAÑOL

Table of Contents

Freestanding Range Warranty / Product Record	2	Setting Oven Controls	19-25
IMPORTANT SAFETY INSTRUCTIONS	3-5	• Preheat	19
Grounding Instructions / L. P. Conversion	5	• Bake	20
Range Features	6	• Timed Bake	21
Setting Surface Controls	7-8	• Delayed Timed Bake	22
• Sizes and Assembly of Gas Burners	7	• Broil & Searing Grill	23
• Locations and Operation of Surface Gas Controls	8	• Food Categories (Meats, Cakes & Breads)	24
Surface Cooking	9-11	• Convection Bake	25
• Flame Size	9	• Serve Warm	26
• Using the Wok Stand	9-10	Oven Cleaning	27-30
Setting Warmer Zone Controls	11-12	• Preparing for the Self-Clean Cycle	27
Before Setting Oven Controls	13	• Self-Clean Cycle	28
Air Circulation in the Oven	13	• Delayed Self-Clean Cycle	29-30
Control Pad Features	14	Adjusting Oven Temperature	30
Minimum & Maximum Control Settings	14	General Care & Cleaning	31-35
Setting the Clock	15	Oven Lights	35
• Setting the Clock	15	Before You Call for Service	36-37
• Changing between 12 or 24 Hour Display	15	Cooking Tables	38
• Continuous Bake or Twelve Hour Energy Saving Mode ..	16	Protection Agreements	39
• Kitchen Timer	16	Sears Service	back cover
Consumer Defined Control Features	17-18		
• Oven Lockout	17		
• Silent Control Operation	18		

Free-Standing Range Warranty

FULL ONE YEAR WARRANTY ON ALL PARTS

If, within one year from the date of installation, any part fails to function properly due to a defect in material or workmanship, Sears will repair or replace it, at our option, free of charge.

Your ceramic glass smoothtop is covered by an additional 2nd through 5th year limited warranty. This warranty provides for replacement for any defective surface heating element, deteriorated rubberized-silicone seal, or glass smoothtop that cracks due to thermal breakage. Damage or breakage due to customer abuse is not covered by this warranty.

If the product is subjected to other than private residential use, the above warranty is effective for only 90 days.

WARRANTY SERVICE IS AVAILABLE BY CONTACTING SEARS AT **1-800-4-MY-HOME®**.

This warranty gives you specific legal rights, and you may also have other rights which vary from state to state.

Sears Roebuck and Co., Dept. 817WA Hoffman Estates, IL 60179

Serial Plate Location

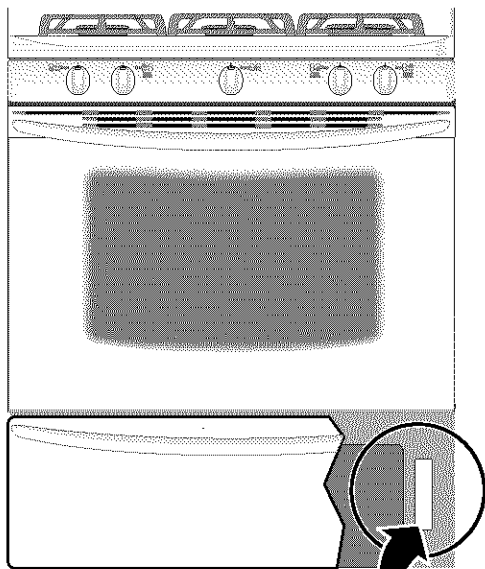

Open Warmer Drawer - serial plate is located here

Product Record

In this space below record the date of purchase, model and serial number of your product. You will find the model and serial number printed on an identification plate. This serial plate is located on the right side of the oven front frame in the storage or warmer drawer compartment. **See illustration at left** for the serial plate location.

Model No. 790.

Serial No. _____

Date of Purchase _____

Save these instructions and your sales receipt for future reference.

Important Safety Instructions

Read all instructions before using this appliance.
Save these instructions for future reference.

This manual contains important safety symbols and instructions. Please pay attention to these symbols and follow all instructions given.

⚠ WARNING This symbol will help alert you to situations that may cause serious bodily harm, death or property damage.

⚠ CAUTION This symbol will help alert you to situations that may cause bodily injury or property damage.

⚠ WARNING If the information in this manual is not followed exactly, a fire or explosion may result causing property damage, personal injury or death.

FOR YOUR SAFETY:

- Do not store or use gasoline or other flammable vapors and liquids in the vicinity of this or any other appliance.
 - **WHAT TO DO IF YOU SMELL GAS:**
 - Do not try to light any appliance.
 - Do not touch any electrical switch; do not use any phone in your building.
 - Immediately call your gas supplier from a neighbor's phone. Follow the gas supplier's instructions.
 - If you cannot reach your gas supplier, call the fire department.
 - Installation and service must be performed by a qualified installer, servicer or the gas supplier.
-
- Remove all tape and packaging before using the range. Destroy the carton and plastic bags after unpacking the range. Never allow children to play with packaging material.
 - **Proper Installation**—Be sure your appliance is properly installed and grounded by a qualified technician in accordance with the National Fuel Gas Code ANSI Z223.-latest edition, or in Canada CAN/CGA B149.1, and CAN/CGA B149.2, and the National Electrical Code ANSI/NFPA No.70-latest edition, or in Canada CSA Standard C22.1, Canadian Electrical Code, Part 1, and local code requirements. Install only per installation instructions provided in the literature package for this range.
Ask your dealer to recommend a qualified technician and an authorized repair service. Know how to disconnect the power to the range at the circuit breaker or fuse box in case of an emergency.
 - **User servicing**—Do not repair or replace any part of the appliance unless specifically recommended in the manuals. All other servicing should be done only by a qualified technician. This may reduce the risk of personal injury and damage to the range.
 - **Never modify or alter the construction of a range by removing leveling legs, panels, wire covers, anti-tip brackets/screws, or any other part of the product.**

⚠ WARNING

- All ranges can tip.
- Injury to persons could result.
- Install anti-tip device packed with range.
- See Installation Instructions.



⚠ WARNING To reduce the risk of tipping, the range must be secured by properly installed anti-tip bracket provided with the range. To check if the bracket is installed properly, visually check that rear leveling leg is inserted into and fully secured by the anti-tip bracket by removing lower panel or storage drawer. For models with a warmer drawer, grasp the top rear edge of the range and carefully attempt to tilt it forward. Refer to the installation instructions for proper anti-tip bracket installation.

⚠ WARNING Stepping, leaning or sitting on the doors or drawers of this range can result in serious injuries and also cause damage to the range. Do not allow children to climb or play around the range. The weight of a child on an open door may cause the range to tip, resulting in serious burns or other injury.

⚠ WARNING Do not use the oven or Warmer Drawer (if equipped) for storage.

⚠ CAUTION Do not store items of interest to children in the cabinets above a range or on the backguard of a range. Children climbing on the range to reach items could be seriously injured.

⚠ WARNING Never Use Your Appliance for Warming or Heating the Room.

- **Storage in or on Appliance**—Flammable materials should not be stored in an oven, warmer drawer, near surface burners or in the storage drawer. This includes paper, plastic and cloth items, such as cookbooks, plasticware and towels, as well as flammable liquids. Do not store explosives, such as aerosol cans, on or near the range.

Important Safety Instructions

- **Do Not Leave Children Alone**—Children should not be left alone or unattended in the area where appliance is in use. They should never be allowed to sit or stand on any part of the appliance.
- **DO NOT TOUCH SURFACE BURNERS OR WARMER ZONE, AREAS NEAR THESE BURNERS, OVEN BURNERS OR INTERIOR SURFACES OF THE OVEN.** Both surface and oven burners may be hot even though flames are not visible. Areas near surface burners may become hot enough to cause burns. During and after use, do not touch, or let clothing or other flammable materials touch these areas until they have had sufficient time to cool. Among these areas are the cook top, surfaces facing the cook top, the oven vent openings and surfaces near these openings, oven door and window.
- **Wear Proper Apparel**—Loose-fitting or hanging garments should never be worn while using the appliance. Do not let clothing or other flammable materials contact hot surfaces.
- **Do Not Use Water or Flour on Grease Fires**—Smother the fire with a pan lid, or use baking soda, a dry chemical or foam-type extinguisher.
- **When heating fat or grease, watch it closely.** Fat or grease may catch fire if allowed to become too hot.
- **Use Only Dry Potholders**—Moist or damp potholders on hot surfaces may result in burns from steam. Do not let potholders touch hot heating burners. Do not use a towel or other bulky cloth instead of a potholder.
- **Do Not Heat Unopened Food Containers**—Buildup of pressure may cause container to burst and result in injury.
- **Remove the oven door from any unused range if it is to be stored or discarded.**
- **Protective Liners**—Do not use aluminum foil to line surface burner pans, or oven bottom, except as suggested in this manual. Improper installation of these liners may result in risk of electric shock, or fire.
- **Glazed Cooking Utensils**—Only certain types of glass, glass/ceramic, ceramic, earthenware, or other glazed utensils are suitable for cooktop service without breaking due to sudden change in temperatures. Check the manufacturer's recommendations for cooktop use.
- **Do not use Searing Grill on the cooktop.** The Searing Grill is not designed for use on the cooktop. Doing so may result in a fire.

IMPORTANT INSTRUCTIONS FOR USING YOUR OVEN

- **Use Care When Opening Oven Door or Warmer Drawer**—Stand to the side of the range when opening the door of a hot oven. Let hot air or steam escape before you remove or replace food in the oven.
- **Keep Oven Vent Ducts Unobstructed.** The oven vent is located below the backguard. Touching the surfaces in this area when the oven is operating may cause severe burns. Also, do not place plastic or heat-sensitive items on or near the oven vent. These items could melt or ignite.
- **Placement of Oven Racks.** Always place oven racks in desired location while oven is cool. If rack must be moved while oven is hot use extreme caution. Use potholders and grasp the rack with both hands to reposition. Do not let potholders contact the hot heating elements in the oven. Remove all utensils from the rack before moving.
- **Do not use the broiler pan without its insert.** The broiler pan and its insert allow dripping fat to drain and be kept away from the high heat of the broiler.
- **Do not cover the broiler insert with aluminum foil. Exposed fat and grease could ignite.**
- Cold temperatures can damage the electronic control. When using the appliance for the first time, or when the appliance has not been used for an extended period of time, be certain the unit has been in temperatures above 32°F (0°C) for at least 3 hours before turning on the power to the appliance.

FOR CERAMIC-GLASS COOK TOP MODELS

- **Do Not Cook on Broken Cook Top**—If cook top should break, cleaning solutions and spillovers may penetrate the broken cook top and create a risk of electric shock. Contact a qualified technician immediately.
- **Clean Cook Top with Caution**—If a wet sponge or cloth is used to wipe spills on a hot cooking area, be careful to avoid a steam burn. Some cleaners can produce noxious fumes if applied to a hot surface.

IMPORTANT INSTRUCTIONS FOR CLEANING YOUR RANGE

- **Clean the range regularly to keep all parts free of grease that could catch fire.** Pay particular attention to the area underneath each surface element. Do not allow grease to accumulate. Refer to the range manufacturer's instructions for cleaning.
- **Kitchen cleaners and aerosols**—Always follow the manufacturer's recommended directions for use. Be aware that excess residue from cleaners and aerosols may ignite causing damage and injury.

IMPORTANT—ELECTRIC IGNITION MODELS ONLY: Do not attempt to operate the oven during a power failure. If the power fails, always turn off the oven. If the oven is not turned off and the power resumes, the oven will begin to operate again. Once the power resumes, reset the clock and oven function.

IMPORTANT INSTRUCTIONS FOR USING YOUR COOKTOP

- **⚠ WARNING Use Proper Flame Size**—Adjust flame size so it does not extend beyond the edge of the utensil. The use of undersized utensils will expose a portion of the burner flame to direct contact and may result in ignition of clothing. Proper relationship of utensil to flame will also improve efficiency.
- **Know which knob controls each surface burner.** Place a pan of food on the burner before turning it on, and turn the burner off before removing the pan.
- **Always turn knob to the full LITE position when igniting top burners.** Visually check that burner has lit. Then adjust the flame so it does not extend beyond the edge of the utensil.
- **Utensil Handles Should Be Turned Inward and Not Extend Over Adjacent Surface Burners**—To reduce the risk of burns, ignition of flammable materials, and spillage due to unintentional contact with the utensil, the handle of the utensil should be positioned so that it is turned inward, and does not extend over adjacent surface burners.
- **Never Leave Surface Burners Unattended at High Heat Settings**—Boilovers cause smoking and greasy spillovers that may ignite, or a pan that has boiled dry may melt.

Important Safety Instructions

SELF-CLEANING OVENS

- **Clean in the self-cleaning cycle only the parts listed in this Use & Care Guide.** Before self-cleaning the oven, remove the broiler pan and any utensils or foods from the oven.
- **Do Not Use Oven Cleaners**—No commercial oven cleaner or oven liner protective coating of any kind should be used in or around any part of the oven.
- **Do Not Clean Door Gasket**—The door gasket is essential for a good seal. Care should be taken not to rub, damage or move the gasket.

GROUNDING INSTRUCTIONS

See the INSTALLATION INSTRUCTIONS packaged with this range for complete installation and grounding instructions.

For personal safety, the range must be properly grounded. For maximum safety, the power cord must be plugged into an electrical outlet that is correctly polarized and properly grounded.

Important Safety Notice

The California Safe Drinking Water and Toxic Enforcement Act requires the Governor of California to publish a list of substances known to the state to cause cancer, birth defects or other reproductive harm, and requires businesses to warn customers of potential exposure to such substances.

Conversion to Liquefied Petroleum Gas (or L.P. Gas)

The natural gas range is designed to allow for conversion to Liquefied Petroleum (L.P.) Gas.

If L.P. conversion is needed, contact **1-800-4-MY-HOME®** for assistance. The L.P. Conversion Kit is provided with this range and is located on the left lower REAR (back side) panel of the range. Before installing the kit be sure to follow the L.P. Installation Instructions carefully.

⚠ WARNING Personal injury or death from electrical shock may occur if the range is not installed by a qualified installer or electrician.

⚠ WARNING Any additions, changes or conversions required in order for this appliance to satisfactorily meet the application needs must be made by Sears Service.

SEARS

Dual Fuel Range Features

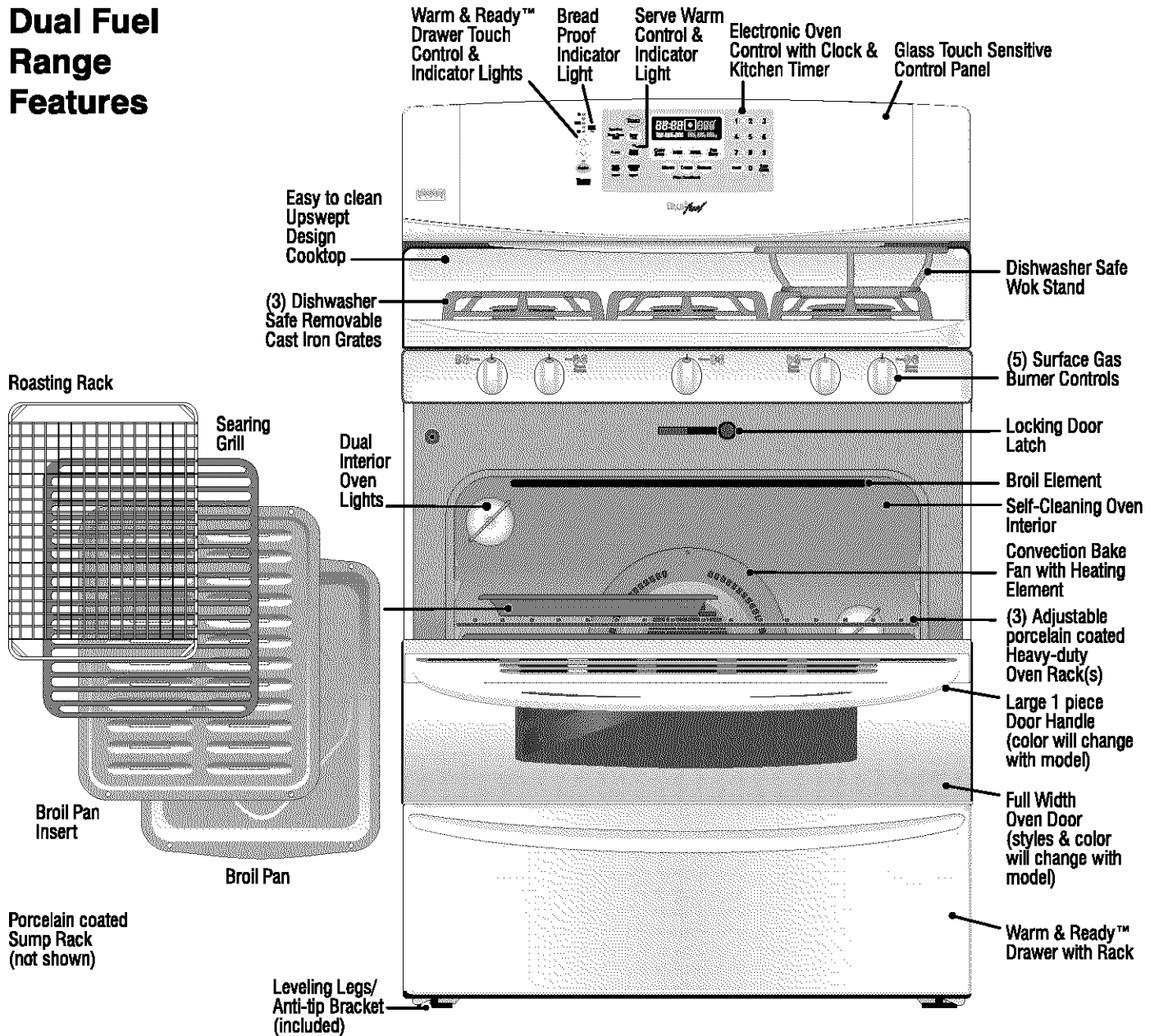

Ceramic Glass 5 Burner Gas Cooktop

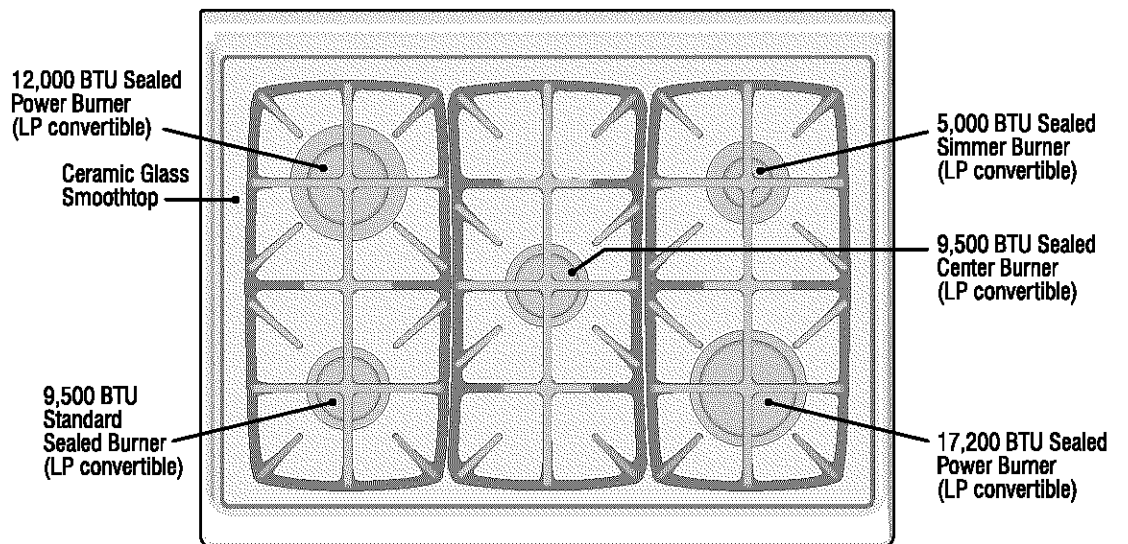

Setting Surface Controls

FEATURE OVERVIEW

- Sizes & assembly of Surface Burners

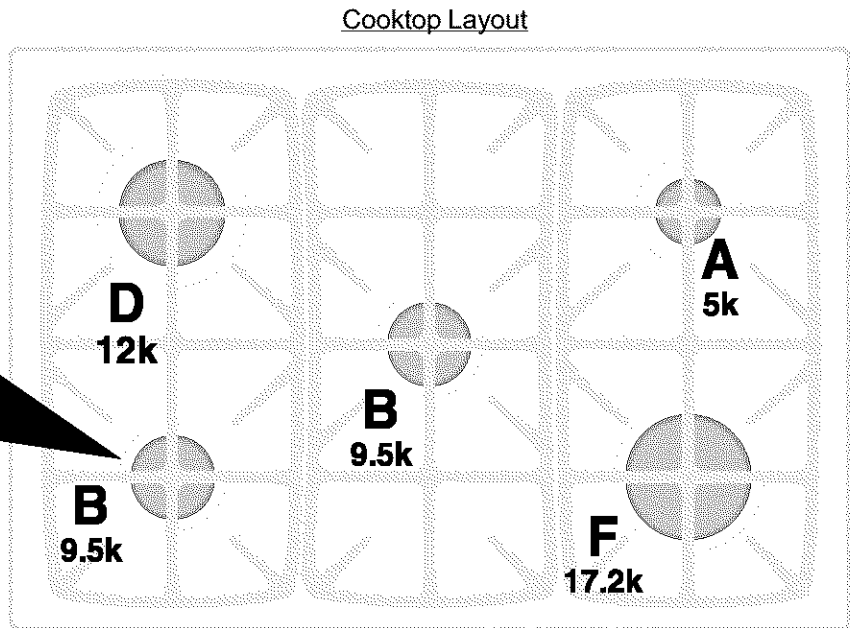
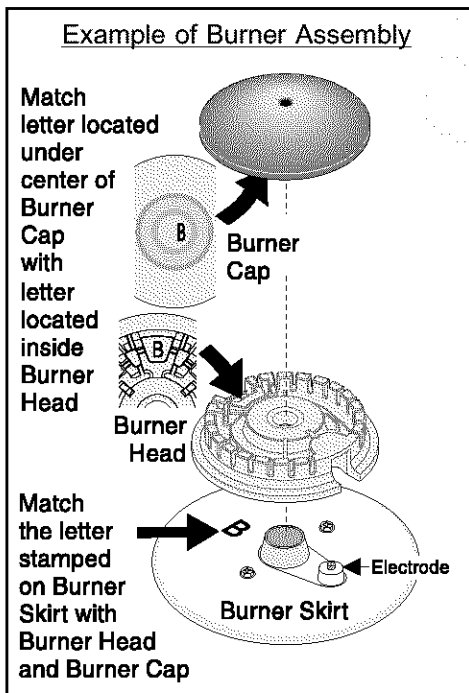

Fig. 1

Front of range cooktop

Sizes of the Surface Gas Burners

Your gas range is supplied with the following 5 surface gas burners rated at;

- **Simmer Burner** (5,000 BTU)
- **2 Standard Burners** (9,500 BTU)
- **Power Burner** (12,000 BTU)
- **Power Burner** (17,200 BTU)

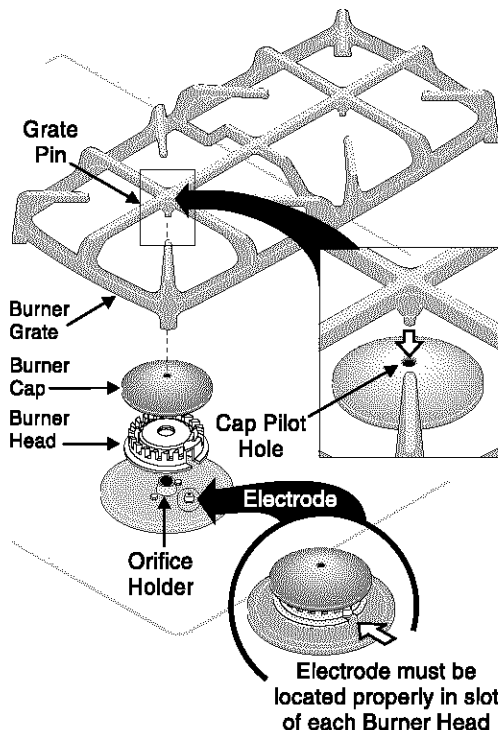

Fig. 2

Assembly of the Surface Burner Heads, Burner Caps and Burner Grates

It is very important to make sure that all of the Burner Heads, Burner Caps & Burner Grates are installed correctly and at the correct locations (Note: The gas burners are factory installed in their correct locations).

1. Match the letter located under the center of each Burner Cap with letter located inside each Burner Head (See Fig. 1).
2. Match the letter stamped on the Burner Skirt with the Burner Head and Burner Cap. Each of the five Burner Heads **MUST** have a Burner Cap installed to insure proper ignition and gas flame size. The Caps must be in place with the Pilot Hole facing up **BEFORE** placing the Burner Grates (See Fig. 2). Note: The Burner Electrodes must be located properly in the slot of each Burner Head (See Fig. 2).
3. Carefully line-up the two outer Grates with the Cap Pilot Holes in the 2 Burner Caps on each side of the range (The outer Grates have two Grate Pins each).
4. Repeat for the center Grate with 1 grate pin (The center Grate has only ONE grate pin).

DO NOT force the Burner Grates onto the Burner Caps. Forcing the grates down onto improperly installed Burner Heads and Burner Caps may damage the gas burners. Visually check that **ALL** the Grate Pins line up into the Burner Cap Pilot Holes (See Fig. 2). A properly installed Burner Grate should rest with all four Grate legs on the cooktop.

REMEMBER — DO NOT ALLOW SPILLS, FOOD, CLEANING AGENTS OR ANY OTHER MATERIAL TO ENTER THE GAS ORIFICE HOLDER OPENING. Always keep the Burner Caps and Burner Heads in place whenever the surface burners are in use. If burner orifice becomes blocked with food spillage, service would be required.

Setting Surface Controls

FEATURE OVERVIEW

- Control Locations of Gas Surface Burners
- Operating Gas Surface Controls

Control Locations of the Gas Surface Burners

Your range is equipped with five gas surface burners with 4 different BTU ratings. The ability to heat food quicker and in larger volumes increases as the burner size increases.

The smaller **SIMMER** burner is best used for simmering delicate sauces, etc. This burner is located at the right rear burner position on the cooktop (See Fig. 1).

The **STANDARD** burners can be used for most surface cooking needs. These burners are located at the center and the left front burner positions on the cooktop (See Fig. 1).

The larger 2 **POWER** burners are best used for bringing large quantities of liquid rapidly up to temperature or when preparing larger quantities of food. The two **POWER** Burners are located at the left rear and right front burner positions on the cooktop (See Fig. 1).

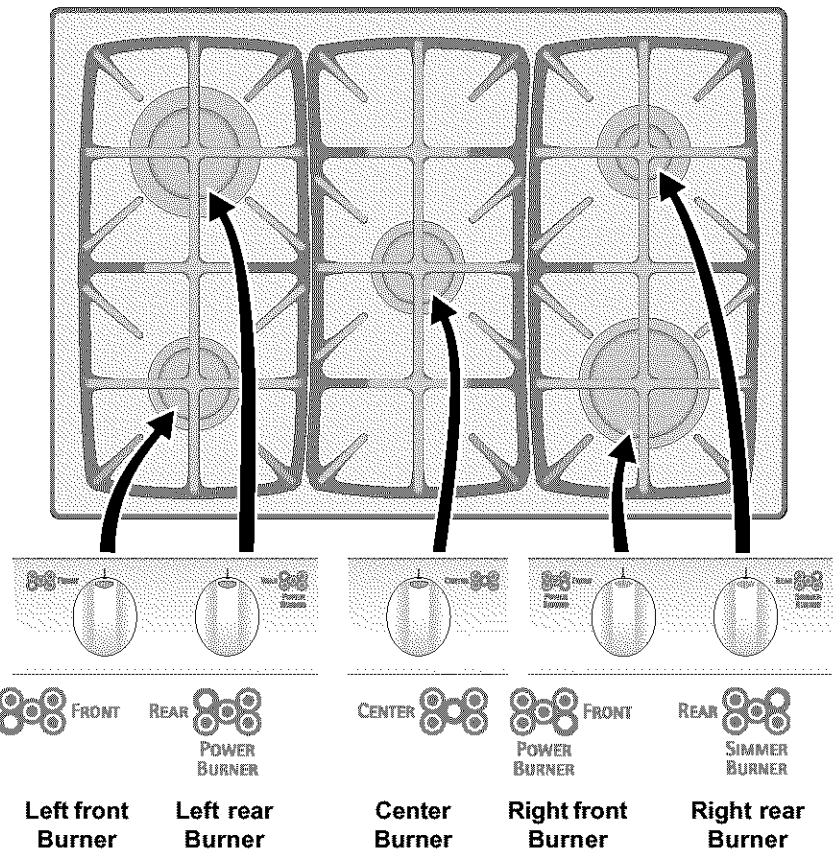

Fig. 1

Operating the Gas Surface Controls:

1. Place cooking utensil on surface burner.
2. Push the surface control knob in and turn **counterclockwise** out of the OFF position (See Fig. 2).
3. Release the knob and rotate to the LITE position. Note: All five electronic surface igniters will spark at the same time. However, only the burner you are turning on will ignite.
4. Visually check that the burner has a flame.
5. Turn the control knob **counterclockwise** to the desired flame size. The control knobs do not have to be set at a particular setting. Use the knob indicator settings to adjust the flame as needed. **DO NOT** cook with the surface control knob in the LITE position. (The electronic ignitor will continue to spark if the knob is left in the LITE position.)

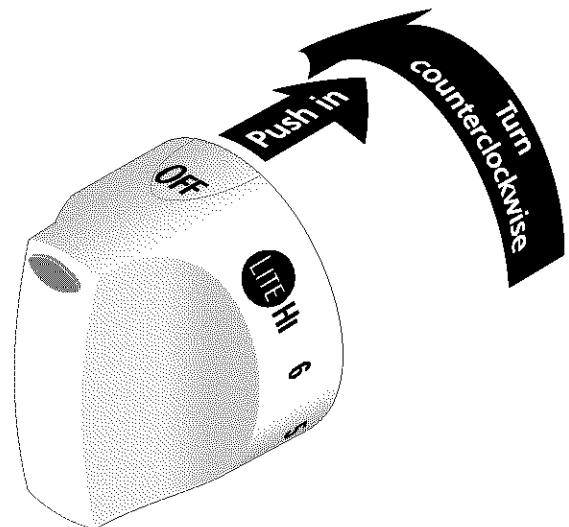

Fig. 2

CAUTION Do not allow aluminum foil, or ANY material that can melt to make contact with the ceramic glass cooktop. If these items melt on the cooktop they will damage the ceramic cooktop.

CAUTION Do not place plastic items such as salt and pepper shakers, spoon holders or plastic wrappings on top of the range when it is in use. These items could melt or ignite. Potholders, towels or wood spoons could catch fire if placed too close to a flame.

Surface Cooking

FEATURE OVERVIEW

- Setting Proper Flame Size
- Using the Wok Stand

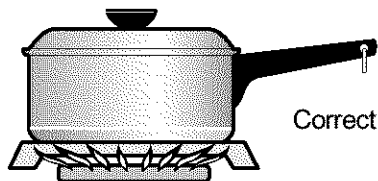

Never extend the flame beyond the outer edge of the utensil. A higher flame simply wastes heat and energy, and increases the risk of being burned by the gas flame.

Setting Proper Surface Burner Flame Size

For most cooking - start on the highest control setting and then turn to a lower one to complete the process. Use the recommendations below as a guide for determining proper flame size for various types of cooking. The size and type of utensil used and the amount of food being cooked will influence the setting needed.

*Flame Size	Type of Cooking
High Flame	Start most foods; bring water to a boil; pan broiling.
Medium Flame	Maintain a slow boil; thicken sauces, gravies; steaming.
Low Flame	Keep foods cooking; poach; stewing.

For deep fat frying - use a thermometer and adjust the surface control knob accordingly. If the fat is too cool, the food will absorb the fat and be greasy. If the fat is too hot, the food will brown so quickly that the center will be undercooked. Do not attempt to deep fat fry too much food at once as the food will neither brown nor cook properly.

***Note: Settings are based on using medium-weight metal or aluminum pans. Settings may vary when using other types of pans.** The color of the flame is the key to proper burner adjustment. A good flame is clear, blue and hardly visible in a well-lighted room. Each cone of flame should be steady and sharp. Adjust or clean burner if flame is yellow-orange.

Using the Wok Stand

The Wok Stand provided with your range is designed to allow round-bottomed woks to be used. **It is recommended that you use a 14 inch maximum diameter (35.5 cm) Wok.** The Wok Stand **MUST** be used on either the right or left **FRONT** burner positions. Cooking with a Wok using the Wok Stand on the rear burner positions may damage the control panel of the range. And it is recommended that you use the right front **POWER** burner for best performance. If properly positioned, the Wok Stand will not slide off the grate.

To Properly Position the Wok Stand:

With the grate in position over the burner, set the Wok Stand on top of the grate positioning the angled notch in the Wok Stand towards the rear of the range (See Fig 1). Turn the Wok Stand, as shown, until the grate fingers fit into the slots on the bottom of the stand (See Fig. 2).

CAUTION Always use potholders to remove the wok stand from the grate. Allow the wok stand to cool before removing. Do not set hot wok stand on surfaces that cannot withstand high heat; such as countertops.

CAUTION Be sure the Wok Stand is positioned correctly and stable before use to prevent hot spills and possible burns.

Position Wok Stand centered over right front burner grate with angled notch in lower ring of Wok Stand as shown. Lower Wok on top of grate.

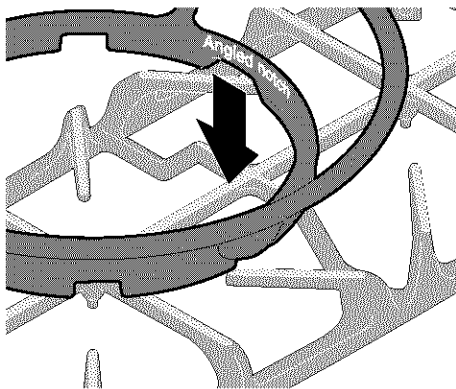
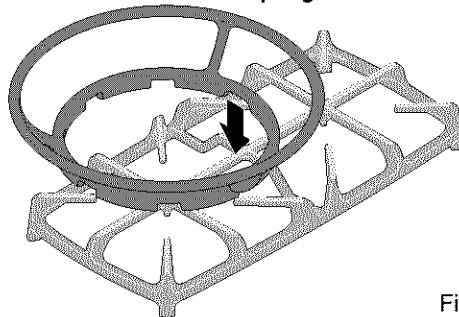

Fig. 1

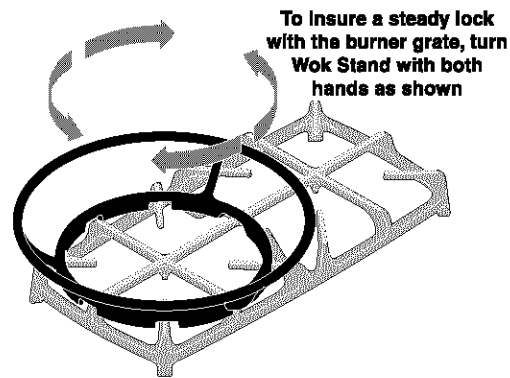

Fig. 2

Surface Cooking FEATURE OVERVIEW

- Using the Wok Stand (cont'd)
- Using cookware on the Warm & Ready Zone

CAUTION Be sure to ALWAYS use the Wok Stand if the stability of the wok is uncertain. If cooking large amounts of liquid food without the Wok Stand, the wok may tip and spill over causing burns (See Fig. 1)

Notes: The Wok Stand should ONLY be used with the front and center gas surface burners as shown in Figs. 4 & 5. The Wok cooking performance is best on the right front POWER burner position.

When using the Wok Stand on the front surface burners, DO NOT use the burner located directly behind the Wok Stand (See Fig. 4).

When using the Wok Stand on the center grate DO NOT USE any other surface burner (See Fig 5).

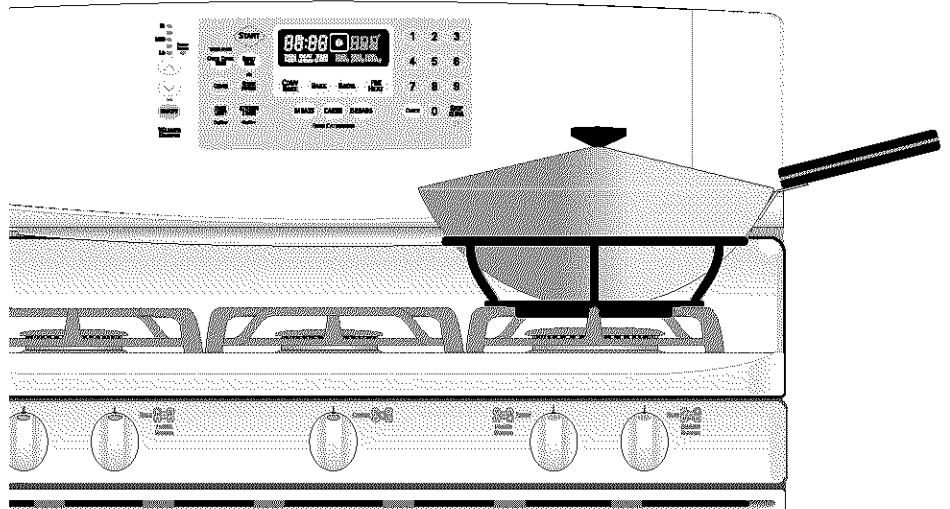
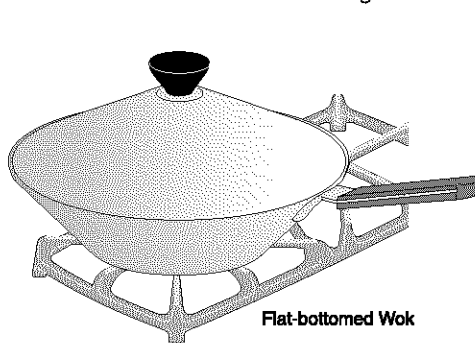

Fig. 1



Flat-bottomed Wok

Proper use of flat-bottom wok on Surface Burner Grate

Fig. 2

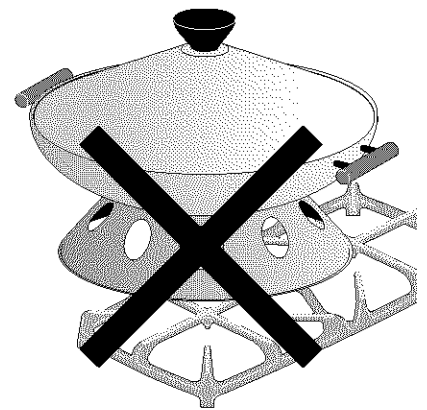

Improper use of round-bottom wok on Surface Burner Grate

Fig. 3

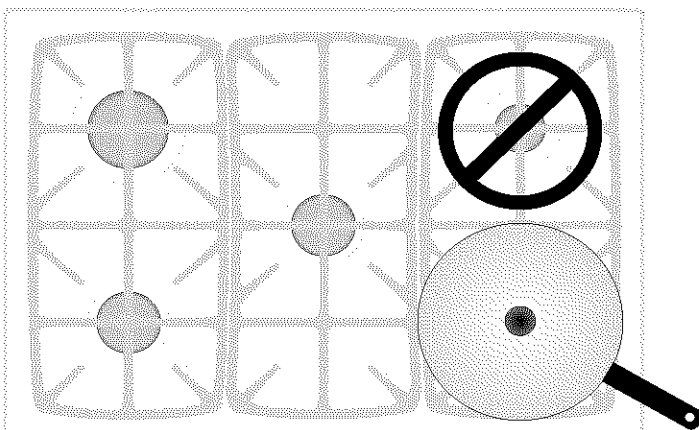

Fig. 4

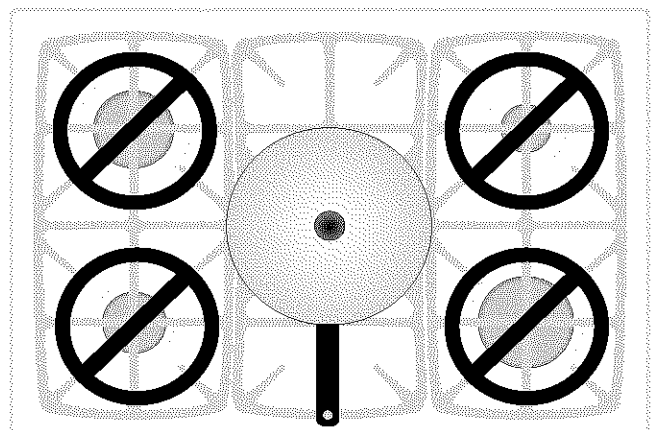

Fig. 5

Flat-bottom woks with large flat bottoms may also be used on your cooktop Surface Burner Grates without the Wok Stand (See Fig. 2). Insure the stability of the flat-bottom wok before cooking without the Wok Stand. If unstable, DO NOT use the flat-bottom wok without the Wok Stand.

Round-bottom woks (with a support ring) should NOT be used without the Wok Stand . (See Fig. 3). The supporting ring was not designed for proper or stable use on the Surface Burner Grates.

Setting Warmer Drawer Controls

FEATURE OVERVIEW

- Arranging Warmer Drawer Racks
- Operating & Setting Warmer Drawer Controls

Arranging Warmer (Warm & Ready™) Drawer Rack Positions

The rack can be used in two ways:

- In the **upward position** (Fig. 1) to allow low profile food items to be placed both under and on top of the rack (for example, rolls or biscuits on top of the rack and a casserole dish underneath).
- In the **downward position** (Fig. 2) to allow you to place light weight food items and empty dishware (for example, rolls or pastries and dinner plates) on the rack.

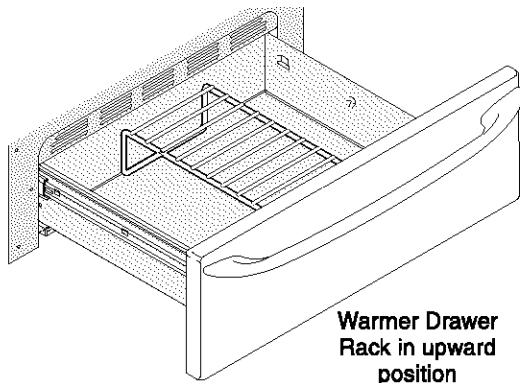

Fig. 1

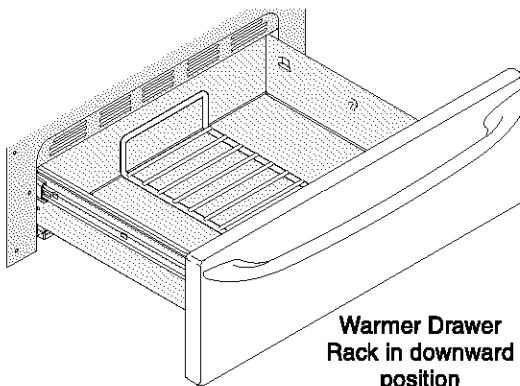

Fig. 2

Operating the Warmer Drawer

The purpose of the Warmer Drawer is to keep hot cooked foods at serving temperature. Always start with hot food. It is not recommended to heat cold food in the Warmer Drawer. All food placed in the Warmer Drawer should be covered with a lid or aluminum foil to maintain quality. **Do not use plastic wrap to cover food. Plastic may melt onto the drawer and be very difficult to clean.** Use only utensils and cookware recommended for oven use in the Warmer Drawer.

CAUTION Always use potholders or oven mitts when removing food from the Warmer Drawer as cookware and plates will be hot and you can be burned.

Warmer Drawer Recommended Food Settings Table

Food Item	Setting
Bacon	HI
Hamburger Patties	HI
Poultry	HI
Pork Chops	HI
Fried Foods	HI
Pizza	HI
Gravies	MED
Casseroles	MED
Eggs	MED
Roasts (Beef, Pork, Lamb)	MED
Vegetables	MED
Biscuits	MED
Rolls, hard	MED
Pastries	MED
Rolls (soft)	LO
Empty Dinner Plates	LO

Fig. 3







Setting Warmer Drawer Controls

FEATURE OVERVIEW

- Operating & Setting Warmer Drawer & Bread Proofing Features
- Preparing Bread Dough for the Warmer Drawer

The control and indicator lights for the Warmer Drawer and Bread Proofing features are located on the control panel. The temperatures are approximate, and are designated by **HI** (high), **MED** (medium), **LO** (low) and **PROOF BREAD**.

To Set the Warmer Drawer & Bread Proofing Controls:

1. Touch the **ON/OFF** pad at the Warmer Drawer control position. The Warmer Drawer indicator light will flash. Note: If no further pads are touched within 25 seconds the request to power the Warmer Drawer ON will clear.
2. Set the desired power level. Touch **HI**  once to turn ON the power level for **HI** (Fig. 2) or **LO**  to turn ON the power level for **LO** (Fig. 4). The Warmer Drawer indicator light will glow steady indicating the Warmer Drawer is ON.
3. Each touch of the **LO**  or **HI**  pads will decrease or increase through 6 power levels from **HI** (Fig. 2) to **MED** (Fig. 3) to **LO** (Fig. 4) and to the **Bread Proofing** feature (Fig. 5). If the Warmer Drawer is set at the **LO** setting and the **LO**  pad is touched again the Bread Proofing feature will be turned ON (The Bread Proof indicator light will glow steady indicating the Bread Proofing feature in ON (See Fig. 5 & bread dough preparation instructions on this page). To return to standard Warmer Drawer settings touch **HI**  pad at least once. Note: For best results, preheat the Warmer Drawer before adding the food or bread dough. An empty drawer will preheat in approximately 15 minutes.
3. When the food or dough is ready for removal, touch the **ON/OFF** pad once to turn the Warmer Drawer or Bread Proof feature OFF. The Warmer Drawer indicator light will turn OFF.

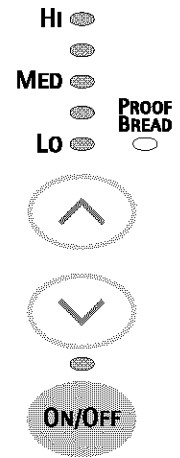

WARMER DRAWER

Fig. 1

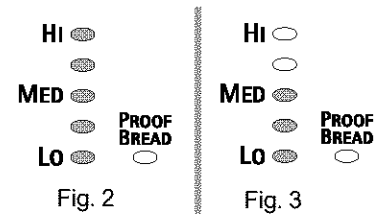

Fig. 2

Fig. 3

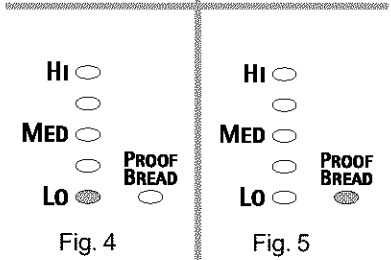

Fig. 4

Fig. 5

Warmer Drawer Food Temperature Settings

Use the recommended Warmer Drawer food temperature settings table (See page 11, Fig. 3). If a particular food is not listed, start with the **MED** setting. If more crispness is desired, remove the lid or aluminum foil from the food. Most foods can be kept at serving temperatures on the **MED** setting. When a combination of foods are to be kept warm (for instance, a meat with 2 vegetables and rolls), use the **HI** setting. To avoid heat loss, do not open the Warmer Drawer repeatedly while in use.

Preparing Bread Dough for the Warmer Drawer

The Warmer Drawer has a "Proof Bread" feature that can be used to help prepare bread dough. The recommended length of time to keep the bread dough in the Warmer Drawer is about 45-60 minutes. Be sure however to follow the recipe's recommended times.

The prepared bread dough should be placed in a large bowl because the dough will nearly double in volume. Arrange the Warmer Drawer Rack in the downward position (See Fig. 6). Place the bowl on the rack in the Warmer Drawer and follow the Warmer Drawer and Bread Proof Control setting instructions at the top of this page.

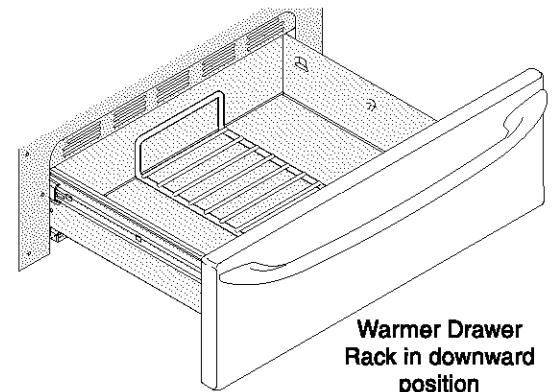

Warmer Drawer Rack in downward position

Fig. 6

Note: The Warmer Drawer will not operate during the Self-Clean cycle.

Before Setting Oven Controls

Arranging Oven Racks

ALWAYS ARRANGE OVEN RACKS WHEN THE OVEN IS COOL (PRIOR TO OPERATING THE OVEN). Always use oven mitts when the oven is hot.

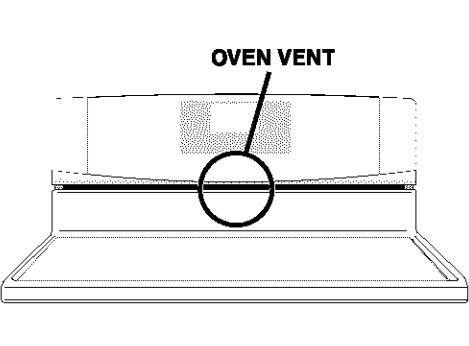
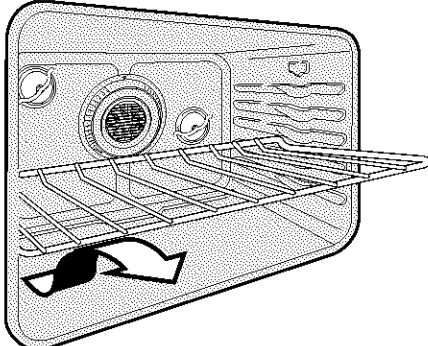
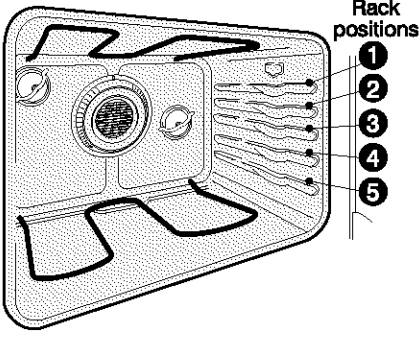
Oven Vent Location	Removing & Replacing Oven Racks	Arranging Oven Racks
The oven vent is located below the backguard . When the oven is on, hot air is released through the vent. This venting is necessary for proper air circulation in the oven and good baking results.	To remove , pull the rack forward until it stops. Lift up front of rack and slide out. To replace , fit the rack onto the guides on the oven walls. Tilt the front of the rack upward and slide the rack back into place.	To bake on a single rack , place the rack in position 4. To bake on 2 racks , place the racks in positions 2 and 4. To bake on 3 racks, place the racks in positions 1, 3 and 5.
 A line drawing of the oven's backguard with a circle highlighting the vent area below it, labeled "OVEN VENT".	 A perspective view of the oven interior showing a rack being pulled out. An arrow indicates the direction of movement.	 A perspective view of the oven interior with five rack positions marked with numbers 1 through 5 on the right side. Position 1 is the top, 2 is below it, 3 is below 2, 4 is below 3, and 5 is the bottom.

Recommended Oven Rack Positions for Broiling, Baking and Roasting

FOOD ITEM	RACK POSITION
Broiling meats, chicken or fish	1, 2 or 3
Cookies, cakes, pies, biscuits & muffins	3 or 4
Frozen pies, angel food cakes, yeast, bread, casseroles, small cuts of meat or poultry	5
Turkey, roast or ham	5

Note: Always use caution when removing food from the lower rack positions.

Air Circulation in the Oven

If you plan to bake only one food item using one rack, place in center of oven. If baking 2 food items using only one rack space the items on the rack as shown in Fig. 1.

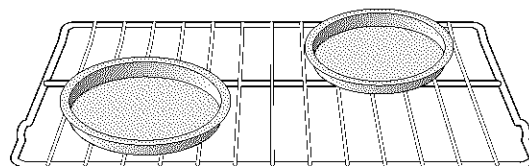

Fig. 1 - using one oven rack

If you place 3 or more food items on more than one rack, stagger the cookware as shown in Fig. 2.

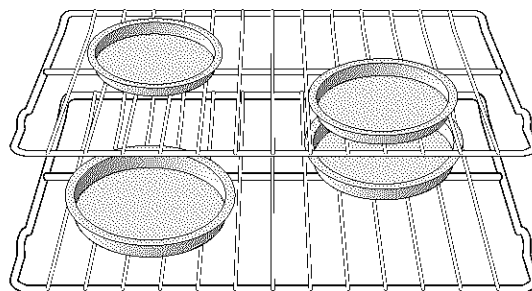

Fig. 2 - using multiple oven racks

For best air circulation and baking results allow 2-4" (5-10 cm) around the cookware for proper air circulation and be sure pans and cookware do not touch each other, the oven door, sides or back of the oven cavity. The hot air must be able to circulate around the pans and cookware in the oven for even heat to reach around the food.

Electronic Oven Control Pad Features

READ THE INSTRUCTIONS CAREFULLY BEFORE USING THE OVEN. For satisfactory use of your oven, become familiar with the various features and functions of the oven as described below. **Detailed instructions for each feature and function follow later in this Use & Care Guide.**

START TIME— Use with **BAKE, OVEN COOK TIME, and CLEAN** to program a Delayed Time Bake or Delayed Self-Cleaning cycle start time.

START — Use to start all oven features (not used with Oven Light).

BROIL— Use to select variable Broil feature (See page 23).

PREHEAT— Use with normal Bake pad (See page 19).

0 THRU 9 NUMBER PADS — Use to enter temperature and times.

OVEN COOK TIME— Use to enter the length of the baking time.

SERVE WARM — Use to select the Oven Serve Warm feature (See page 26).

CLEAN— Use to select the Self-Cleaning feature (See page 27).

OVEN LIGHT ON/OFF — Use to turn the oven lights on and off (See page 35).

KITCHEN TIMER ON/OFF— Use to set or cancel the Kitchen Timer. The Kitchen Timer does not start or stop cooking (See page 16).

CONVECTION BAKE— Use to select the Convection Bake feature (See page 25).

BAKE— Use to enter the normal Bake feature. (See page 20).

MEATS, CAKES & BREADS— Use to select the Meats, Cakes and Breads cooking feature. (See page 24).

STOP/CLEAR — Use to cancel any oven mode previously entered except the time of day and minute timer. Press **STOP/CLEAR** to stop cooking. Press **STOP/CLEAR** and hold for 3 seconds to activate the Oven Lockout feature. Press and hold again for 3 seconds to disable the Oven Lockout (See page 17).

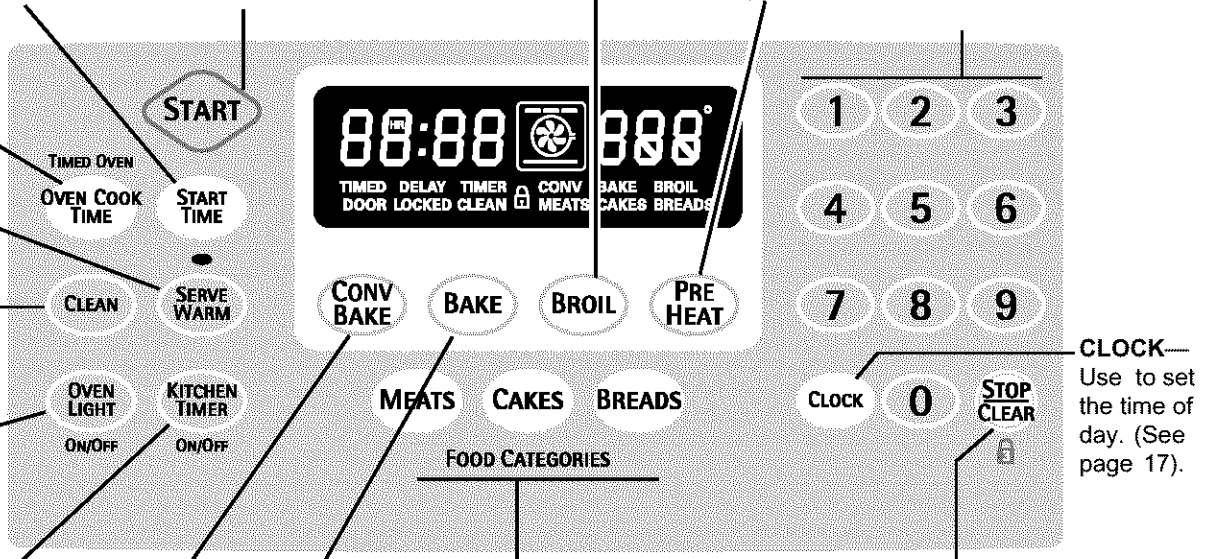

Minimum and Maximum Control Pad Settings

All of the features listed have minimum and maximum time or temperature settings that may be entered into the control. An ENTRY acceptance beep will sound each time a control pad is touched (the Oven Lockout pad is delayed by 3 seconds).

An ENTRY ERROR tone (3 short beeps) will sound if the entry of the temperature or time is below the minimum or above the maximum settings for the feature.

FEATURE		MIN. TEMP. /TIME	MAX. TEMP. /TIME
PREHEAT TEMP.		170°F / 77°C	550°F / 288°C
BAKE TEMP.		170°F / 77°C	550°F / 288°C
BROIL TEMP.		400°F / 205°C	HI-550°F / 288°C
KITCHEN TIMER	12 Hr.	0:01 Min.	11:59 Hr./ Min.
	24 Hr.	0:01 Min.	11:59 Hr./ Min.
CLOCK TIME	12 Hr.	1:00 Hr./ Min.	12:59 Hr./ Min.
	24 Hr.	0:00 Hr./ Min.	11:59 Hr./ Min.
OVEN COOK TIME	12 Hr.	0:01 Min.	11:59 Hr./ Min.
	24 Hr.	0:01 Min.	23:59 Hr./ Min.
CLEAN TIME		2 hours	4 hours
CONVECTION BAKE		300°F / 149°C	550°F / 288°C

Setting the Clock

FEATURE OVERVIEW

- Setting the Clock
- Changing between 12 or 24 hour display



Setting the Clock

The **CLOCK** (CLOCK) pad is used to set the clock. The clock may be set for 12 or 24 hour time of day operation. The clock has been preset at the factory for the 12 hour operation. When the range is first plugged in, or when the power supply to the range has been interrupted, the timer in the display will flash with "PF" (power failure, See Fig. 1).

INSTRUCTIONS

To set the clock (example below for 1:30):

1. Press (CLOCK). "CLO" will appear in the display (Fig. 2).
2. Press (1) (3) (0) pads to set the time of day to 1:30 (Fig. 3). "CLO" will appear in the display. Press (START). "CLO" will disappear and the clock will start (Fig. 4).

PRESS

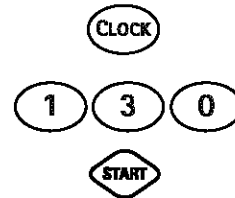

Fig. 1

DISPLAY



Fig. 2



Fig. 3

Changing between 12 or 24 hour time of day display:

1. Press and hold (CLOCK) for 6 seconds (Fig. 3). While holding the pad down the current time of day will remain and "CLO" will disappear from the display (Fig. 4). CONTINUE holding the pad until a beep is heard.
2. The display will show either "12Hr"(Fig. 5) or "24Hr"(Fig. 6).
3. Press (CLEAN) to switch between the 12 and 24 hour time of day display. The display will show either "12Hr" (Fig. 5) or "24Hr" (Fig. 6).
4. Press (START) to accept the desired change or press (STOP Clear) to reject the change.
5. Reset the correct time as described in **To set the Clock** above. Please note that if the 24 hour time of day mode was chosen, the clock will now display time from 0:00 through 23:59 hours.

(CLOCK) for 6 seconds



Fig. 4



Fig. 5



Fig. 6



ENGLISH

Setting the Clock

FEATURE OVERVIEW





- Continuous Bake or Twelve Hour Energy Saving Mode
- Kitchen Timer

Setting Continuous Bake or 12 Hour Energy Saving

The **KITCHEN TIMER**  and **CLEAN**  pads control the Continuous Bake or 12 Hour Energy Saving features. The oven control has a factory preset built-in 12 Hour Energy Saving feature that will shut off the oven if the oven control is left on for more than 11 hours and 59 minutes. The oven can be programmed to override this feature for Continuous Baking.

INSTRUCTIONS

To set the control for Continuous Bake or 12 Hour Energy Saving features:

1. Press and hold  for 6 seconds (Fig. 1). "12Hr" or "- -Hr" will appear in the display and the control will beep once.
2. Press  to switch between the 12 Hour Energy Saving and continuous bake features. Note: "12Hr" (Fig. 2) in the display indicates the control is set for 12 Hour Energy Saving feature and "- -Hr" (Fig. 3) indicates the control is set for the Continuous Bake feature.
3. Press  to accept the change (Fig. 4; display will return to time of day) or press  to reject the change.

PRESS

DISPLAY

 for 6 seconds



Fig. 1





Fig. 2

 or 



Fig. 3







Fig. 4

Setting Kitchen Timer

The **KITCHEN TIMER**  pad controls the Kitchen Timer feature. The Kitchen Timer serves as an extra timer in the kitchen that will beep when the set time has run out. It does not start or stop cooking. The Kitchen Timer feature can be used during any of the other oven control functions. Refer to "Minimum and Maximum Control Pad Settings" on page 14 for time amount settings.

INSTRUCTIONS

To set the Kitchen Timer (example for 5 minutes):

1. Press . "0:00" will appear and "TIMER" will flash in the display (Fig. 5).
2. Press the number pads to set the desired time in the display (example ). Press . The time will count down with "5:00" and "TIMER" will show in the display (Fig. 6).
Note: If  is not pressed the timer will return to the time of day.
3. When the set time has run out, "End" and "TIMER" will show in the display (Fig. 7). The clock will sound with 3 beeps every 15 seconds until  is pressed.

PRESS

DISPLAY





Fig. 5



Fig. 6





Fig. 7

To cancel the Kitchen Timer before the set time has run out:

Press . The display will return to the time of day.



Consumer Defined Control Features

FEATURE OVERVIEW

- Oven Lockout
- Temperature Display



Note: The Consumer Defined Control features are adjustments to the control that will not affect cooking results. These include the  Oven Lockout, Temperature Display and Silent Control Operation features.

Setting Oven Lockout Feature

The  pad controls the Oven Lockout feature. The Oven Lockout feature automatically locks the oven door and prevents the Warmer Drawer, cooktop and most oven controls from being turned ON. It does not disable the clock, Kitchen Timer or the interior oven lights.

INSTRUCTIONS

To activate the Oven Lockout feature:

1. Press and hold  for 3 seconds (Fig. 1).
2. After 3 seconds the lock icon light () will appear, a beep will sound and "DOOR LOCKED" will flash in the display. Once the oven door is locked the "DOOR LOCKED" indicator will stop flashing and remain on along with the lock icon light.

PRESS



 for 3 seconds

DISPLAY



Fig. 1

To reactivate normal oven operation:

1. Press and hold  for 3 seconds. A beep will sound. The "DOOR LOCKED" will continue to flash until the oven door has completely unlocked and the lock icon light () will clear (See Fig. 2).
2. The range is again fully operational.



 for 3 seconds







Fig. 2

Setting Temperature Display — Fahrenheit or Celsius

The **BROIL**  and **CLEAN**  pads control the Fahrenheit or Celsius temperature display modes. The oven control can be programmed to display temperatures in Fahrenheit or Celsius. The oven has been preset at the factory to display in Fahrenheit.

INSTRUCTIONS

To change display from Fahrenheit to Celsius or Celsius to Fahrenheit:

1. To tell if the display is set for Fahrenheit or Celsius press  (Fig. 3) and hold for 7 seconds; "550°" will first appear in the display and then a beep will sound. If "F" appears, the display is set to show temperatures in Fahrenheit (Fig. 4). If "C" appears, the display is set to show temperatures in Celsius (Fig. 5).
2. Press  to switch between Fahrenheit or Celsius display modes. The display will show either "F" (Fig. 4) or "C" (Fig. 5).
3. Press  to accept the change or press  to reject the change.

PRESS

 for 7seconds

DISPLAY



Fig. 3



Fig. 4



Fig. 5

Consumer Defined Control Features

FEATURE OVERVIEW

- Silent Control Operation



Setting Silent Control Operation

The **START TIME** (START TIME) and **CLEAN** (CLEAN) pads control the Silent Control operation feature. The Silent Control operation feature allows the oven control to be operated without sounds or beeps whenever necessary. If desired the control can be programmed for silent operation and later returned to operating with all the normal sounds and beeps.

INSTRUCTIONS

PRESS

DISPLAY

To change control from normal sound operation to silent control operation:

1. To tell if your range is set for normal or silent operation press and hold (START TIME) for 7 seconds. "0:00" will appear and "DELAY" will flash in the display (Fig. 1).

(START TIME) for 7seconds



Fig. 1

2. Press (CLEAN) to switch between normal sound operation and silent operation mode. The display will show either ":SP" (Fig. 2) or ":-" (Fig. 3).

(CLEAN)



Fig. 2

If ":SP" appears (Fig. 2), the control will operate with normal sounds and beeps. If ":-" appears (Fig.3), the control is in the silent operation mode.

4. Press (START) to accept the change or press (STOP Clear) to reject the change.

(START) or (STOP Clear)



Fig. 3

Setting Oven Controls

FEATURE OVERVIEW





- Preheat for Electric Ranges

Setting Preheat

The **PREHEAT**  pad controls the Preheat feature. The Preheat feature will bring the oven up to temperature and then indicate when to place the food in the oven. Use this feature in combination with the Bake pad when recipes call for preheating. Preheating is not necessary when roasting or cooking casseroles. The oven can be programmed to preheat at any temperature between 170°F to 550°F.

INSTRUCTIONS

To set the Preheat temperature for 350°F:







1. Arrange the interior oven racks.
2. Press . "- - - °" and "BAKE" will appear in the display (See Fig. 1).
3. Press   . "350°" will appear in the display (See Fig. 2).
4. Press . "PRE" and "BAKE" will appear in the display as the oven heats and reaches 350°F (Fig 3).

Note: After the oven has reached the desired temperature (this example, 350°F) the control will sound a long beep, the "PRE" light will turn off and oven temperature will be displayed (Fig. 4). If the beep was missed, a quick glance at the display with oven temperature showing in the oven display is a good way to check that the oven has already reached the preheat temperature. Once the oven has preheated, **PLACE FOOD IN THE OVEN**. The "BAKE" light will stay on.

Press  when baking is complete or to cancel the Preheat feature.

To change Preheat temperature while oven is preheating (example changing from 350 to 425°F):

If it is necessary to change the preheat temperature while the oven is preheating to the original temperature:

1. While preheating, press . "- - - °" and "BAKE" will appear in the display (Fig. 5)
2. Enter the new preheat temperature. Press   . "425°" and "BAKE" will appear in the display (Fig. 6).
3. Press . "PRE" and "BAKE" will appear in the display as the oven heats to 425°F (Fig. 7). A long beep will sound once the oven temperature reaches 425°F and the display will show "425°" and "BAKE" (See Fig. 8).
4. When baking is complete press .

PRESS

DISPLAY

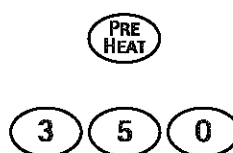

Fig. 1



Fig. 2



Fig. 3



Fig. 4

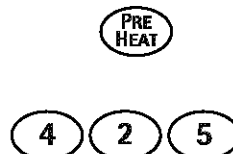

Fig. 5



Fig. 6



Fig. 7

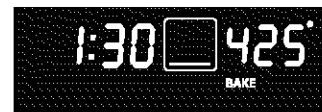
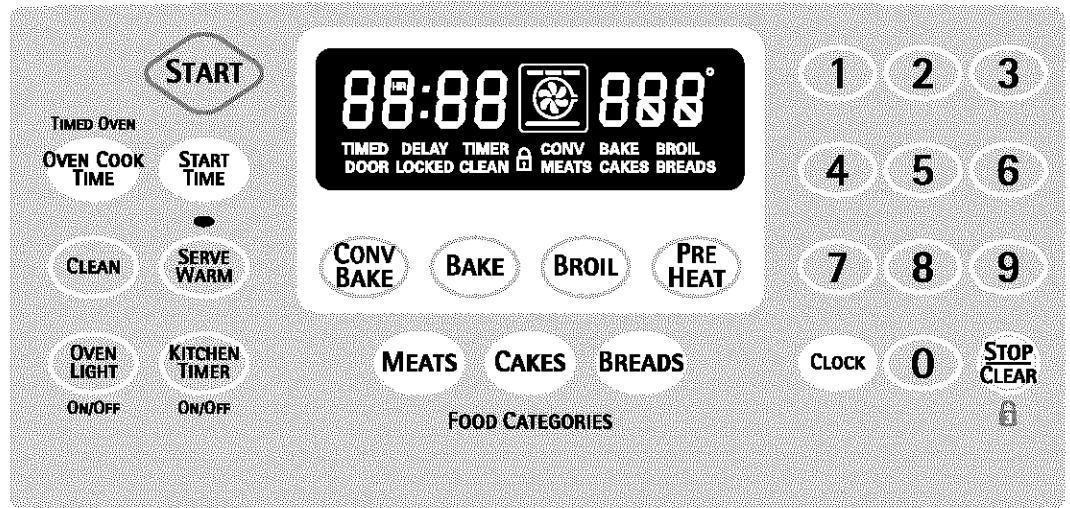

Fig. 8

www.hobart.com

Setting Oven Controls FEATURE OVERVIEW

- Bake



Setting Bake

The **BAKE** (BAKE) pad controls normal baking. If preheating is necessary, refer to the **PREHEAT** (PRE HEAT) feature for instructions. The oven can be programmed to bake at any temperature from 170°F to 550°F (The sample shown below is for 350°F).

INSTRUCTIONS

To set the Bake Temperature to 350°F:

1. Arrange interior oven racks and place food in oven.
2. Press (BAKE), "-- - °" will appear in the display (Fig. 1).
3. Press (3) (5) (0) (Fig. 2). "BAKE" will flash and "350°" will appear in the display.
4. Press (START). A long beep will sound once the oven temperature reaches 350° F and the display will show "350°" and "BAKE" (Fig. 3).

Pressing (STOP Clear) will cancel the Bake feature at any time.

To change the Bake Temperature (example changing from 350° to 425°F):

1. After the oven has already been set to bake at 350°F and the oven temperature needs to be changed to 425°F, press (BAKE) (Fig. 4) and "-- - °" will show in the display.
2. Press (4) (2) (5) (Fig. 5). "BAKE" flashes and "425°" will appear in the display.
3. Press (START). "BAKE" and "425°" will appear in the display (See Fig. 6).

Note: If the oven was recently heated from prior cooking and has remaining heat, the bake element symbol may not show in the display immediately.

PRESS

DISPLAY

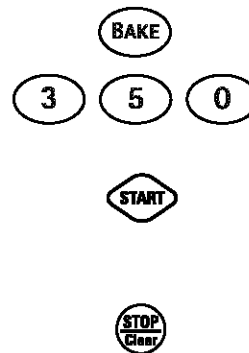

Fig. 1



Fig. 2



Fig. 3



Fig. 4



Fig. 5





Fig. 6

Setting Oven Controls

FEATURE OVERVIEW









- Timed Bake

Setting Timed Bake

The **BAKE**  and **OVEN COOK TIME**  pads control the Timed Bake feature. The automatic timer of the Timed Bake feature will turn the oven OFF after cooking for the desired amount of time you selected.

INSTRUCTIONS

To program the oven to begin baking immediately and to shut off automatically: (example below to bake at 350°F for 50 minutes):

1. Be sure the clock is set for the correct time of day.
2. Arrange interior oven rack(s) and place the food in the oven.
3. Press , " - - - °" will appear in the display (Fig. 1).
4. Press    (Fig. 2). "BAKE" will flash and "350°" will appear in the display.
5. Press . "BAKE" and "350°" will appear in the display (See Fig. 3).
6. Press . "TIMED" will flash; "BAKE", "0:00" and "350°" will appear in the display (Fig.4).
7. Enter the desired baking time by pressing  . "TIMED" will flash and "BAKE", "50:00" and "350°" will appear in the display (Fig. 5). Note: Baking time can be set for any amount of time between 1 minute to 11 hours and 59 minutes.
8. Press . Both "TIMED" and "BAKE" will remain on in the display (Fig. 6). Once the Timed Bake feature has started, the current time of day will appear in the display.

Note: After the Timed Bake feature has activated, press  to display the bake time remaining in the Timed Bake mode. Once Timed Bake has started baking, a long beep will sound when the oven temperature reaches the set temperature.

Press  when baking has finished or at any time to cancel the Timed Bake feature.

When the Timed Bake finishes:

1. "End" and the time of day will show in the display. The oven will shut off automatically (Fig. 7).
2. The control will beep 3 times. The control will continue to beep 3 times every 30 seconds until  is pressed.

PRESS

DISPLAY



Fig. 1



Fig. 2



Fig. 3



Fig. 4



Fig. 5



Fig. 6



Fig. 7

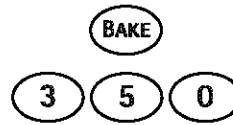



CAUTION Use caution with the **TIMED BAKE** or **DELAYED TIME BAKE** features. Use the automatic timer when cooking cured or frozen meats and most fruits and vegetables. Foods that can easily spoil such as milk, eggs, fish, meat or poultry, should be chilled in the refrigerator first. Even when chilled, they should not stand in the oven for more than 1 hour before cooking begins, and should be removed promptly when cooking is completed. Eating spoiled food can result in sickness from food poisoning.

Setting Oven Controls Setting Delayed Time Bake















FEATURE OVERVIEW

- Delayed Time Bake

The **BAKE** , **OVEN COOK TIME**  and **START TIME**  pads control the Delayed Time Bake feature. The automatic timer of the Delayed Time Bake will turn the oven ON and OFF at the time you select in advance.

INSTRUCTIONS

To program the oven for a delayed bake start time and to shut off automatically (example for baking at 350°F for 50 minutes and starting at 5:30):

- Be sure that the clock is set with the correct time of day.
- Arrange interior oven rack(s) and place the food in the oven.
- Press . "---°" will appear in the display (Fig. 1).
- Press    (Fig. 2). "BAKE" will flash and "350°" will appear in the display.
- Press . "BAKE" and "350°" will appear in the display (See Fig. 3).
- Press . "TIMED" will flash; "BAKE", "0:00" and "350°" will appear in the display (Fig.4).
- Enter the desired baking time using the number pads by pressing  . "TIMED" will flash; "BAKE", "50:00" and "350°" will appear in the display (Fig. 5). Note: Baking time can be set for any amount of time from 1 minute to 11 hours and 59 minutes.
- Press . "TIMED", "BAKE" and "350°" will be displayed (Fig. 6).
- Press . Enter the desired start time using the number pads    (Fig. 7).
- Press . When Delayed Time Bake starts, the set oven temperature will disappear, "TIMED DELAY", "BAKE" and the current time of time of day will appear in the display (Fig. 8).

Note: Once Delayed Time Bake has started, press  to display the bake time remaining. Once the Delayed Timed Bake has started baking, a long beep will sound when the oven temperature reaches the set temperature.

Press  when baking has finished or at any time to cancel the Delayed Time Bake feature.

When the set bake time runs out:

- "End" and the time of day will show in the display. The oven will shut off automatically (Fig. 9).
- The control will beep 3 times. The control will continue to beep 3 times every 30 seconds until  is pressed.

NOTE: If your clock is set for normal 12 hour display mode the Delayed Time Bake feature can never be set to start more than 12 hours in advance. To set the Delayed Time Bake 12-24 hours in advance see page 15 for instructions to set the control for the 24 hour time of day display mode.

PRESS

DISPLAY



Fig. 1



Fig. 2



Fig. 3



Fig. 4



Fig. 5



Fig. 6



Fig. 7



Fig. 8



Fig. 9

Setting Oven Controls

FEATURE OVERVIEW

- Broil (Electric Range)

Setting Broil - The **BROIL** pad controls the Broil feature. When broiling, heat radiates downward from the oven broiler for even coverage. The Broil feature is preset to start broiling at 550°F however, the Broil feature temperature may be set between 400°F and 550°F. This range includes a Searing Grill for searing meats (see Fig. 6).

The broil pan and broil pan insert used together allow dripping grease to drain and be kept away from the high heat of the oven broiler. **DO NOT** use the broil pan without the insert (See Fig. 5). **DO NOT cover the broil pan insert with foil.** The exposed grease could catch fire.

⚠ WARNING Should an oven fire occur, leave the oven door closed and turn the oven OFF. If the fire continues, throw baking soda on the fire or use a fire extinguisher. **DO NOT** put water or flour on the fire. Flour may be explosive and water can cause a grease fire to spread and cause personal injury.

INSTRUCTIONS

To set the oven to broil at the default setting (550°F):

1. Place the broiler pan insert on the broiler pan. Then place the food on the broiler pan insert. **DO NOT** use the broiler pan without the insert. **DO NOT** cover the broiler insert with foil. The exposed grease could ignite.
2. Arrange the interior oven rack and place the broiler pan on the rack. Be sure to center the broiler pan directly under the broiler element. **Make sure the oven door is in the broil stop position (See Fig. 4).**
3. Press **BROIL**. "BROIL" will flash and "550°" will appear (Fig. 1).
4. If a lower broil temperature is desired (minimum broil temperature setting is 400°F), press the desired temperature before continuing to step 5.
5. Press **START**. The oven will begin to broil. "BROIL" and "550°" will appear in the display (Fig. 2).
6. Broil on one side until food is browned; turn and cook on the second side. Season and serve. **Note:** Always pull the rack out to the stop position before turning or removing food.
7. To cancel broiling or if finished broiling press **STOP/Clean** (Fig. 3).

PRESS



DISPLAY



Fig. 1



Fig. 2



Fig. 3

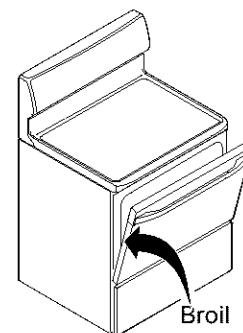

Fig. 4 Broil Stop Position

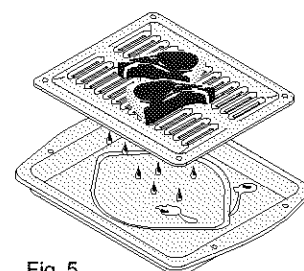

Fig. 5

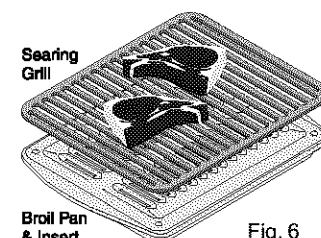

Fig. 6 Searing Grill Broil Pan & Insert

Broiling Times and Searing Grill

Use the following table for approximate broiling times. Increase or decrease broiling times, or move the broiling pan to a different rack position to suit for doneness. If the food you are broiling is not listed in the table, follow the instructions provided in your cookbook and watch the item closely. Use the Searing Grill for meats and steaks if desired. Before placing the meat, be sure to heat the Searing Grill using Broil for 10 minutes. Cook times should be reduced 1-2 minutes per side when cooking with the Searing Grill. Place Searing Grill on top of Broiler Pan and insert for meats and steaks (See Fig. 6).

Broiling Table Recommendations



Food Item	Rack Position	Temp Setting	Cook Time		Doneness
			1st side	2nd side	
Steak 1" thick	2nd	550° F	8:00	6:00	Rare
	2nd	550° F	10:00	8:00	Medium
Pork Chops 3/4" thick	2nd	550° F	12:00	8:00	Well
Chicken - Bone In	3rd	450° F	25:00	15:00	Well
Chicken - Boneless	2nd	450° F	10:00	8:00	Well
Fish	2nd	500° F	as directed	as directed	Well
Shrimp	3rd	550° F	as directed	as directed	Well
Hamburger 1" thick	2nd	550° F	10:00	8:00	Medium
	3rd	550° F	12:00	10:00	Well

Setting Oven Controls

FEATURE OVERVIEW

- Food Categories (Meats/Cakes/Breads)
- Roasting Instructions for Meat Pad

Setting the Food Categories Features

The **MEATS** , **CAKES**  and **BREADS**  pads in the Food Categories feature are used when cooking certain food items. These pads have been designed to give optimum cook performance for the foods selected in each category.





The **MEATS** pad combines a cook cycle with the convection fan and element to roast meats and poultry. Preheating is not necessary for meats and poultry. Heated air circulates around the food from all sides, sealing in juices and flavors. Foods are crispy brown on the outside while staying moist on the inside.

The **CAKES** pad provides a preheat with a gentle cycling of heat giving cakes more volume and allowing delicate foods to cook more evenly.

The **BREADS** pad adds a preheat feature to the bake cycle to thoroughly heat the oven from top to bottom to give more evenly browned foods. Refer to Fig. 4 for foods to cook in each category.

INSTRUCTIONS

To set the Food Categories feature (example for Meats to cook at 350°F):

1. Arrange interior oven racks and place food in oven.
2. Press . "MEATS" will flash and "---°" will be displayed (See Fig. 1).
3. Press   . "MEATS" will flash and "350°" will appear in the display (See Fig. 2).
4. Press . "MEATS" and "350°" will appear in the display (See Fig. 3). The convection fan icon will come on.

Press  to stop cooking Meats, Cakes or Breads, or to cancel cooking Meats, Cakes or Breads at any time.

PRESS



DISPLAY



Fig. 1



Fig. 2



Fig. 3

Recommended foods to be cooked in each category

Meats	Cakes	Breads
Meat Poultry	Cakes Brownies Pies (fresh & frozen) Baked Custards Cheesecake	Breads Rolls Biscuits Muffins Cornbread
Fig. 4		

Roasting Instructions for Meat Pad

When using the Meat pad for roasting, use the broiler pan and insert along with the roasting rack. The broiler pan will catch grease spills and the insert will help prevent grease splatters. The roasting rack will allow the heat to circulate around the meat.

⚠ WARNING To prevent food from contacting the broil element and to prevent grease splattering, **DO NOT** use the roasting rack when broiling.

1. Place oven rack on bottom or next to the bottom rack position. See Arranging Oven Racks in the **Before Setting Oven Controls** section.
2. Place the insert in the broiler pan. The roasting rack fits on the insert allowing the heated air to circulate under the food for even cooking and helps to increase browning on the underside. Make sure the roasting rack is securely seated on the insert in the broiler pan. **DO NOT** use the broiler pan without the insert. **DO NOT** cover the insert with aluminum foil.
3. Position food (fat side up) on the roasting rack (See Fig. 5).
4. Place the broiler pan on the oven rack.

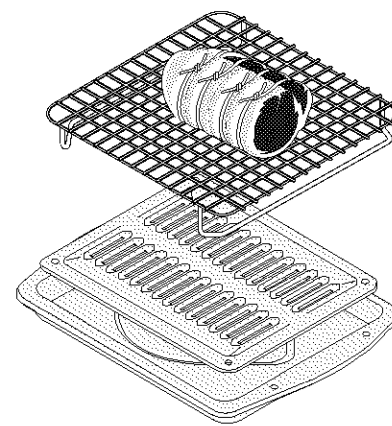



Fig. 5

Setting Oven Controls

FEATURE OVERVIEW

- Convection Bake
- Setting Convection Bake

Setting Convection Bake

The **CONVECTION BAKE**  pad controls the Convection Bake feature.

Use the Convection Bake feature when cooking speed is desired. The oven can be programmed for Convection baking at any temperature between 300° F (149° C) to 550° F (288° C).

Convection baking uses a fan to circulate the oven's heat evenly and continuously within the oven (See Fig. 1). This improved heat distribution allows for fast, even cooking and browning results. It also gives better baking results when using 2 or 3 racks at the same time. Breads and pastries brown more evenly. Most foods cooked in a standard oven will cook faster and more evenly with Convection Bake.

Benefits of Convection Bake:

- Some foods cook up to 30% faster, saving time and energy.
- Multiple rack baking.
- No special pans or bakeware needed.

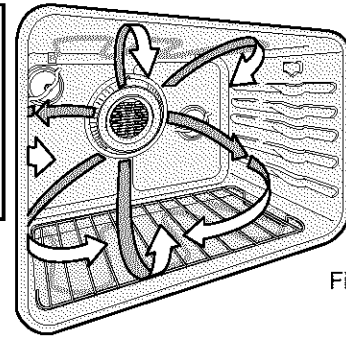

Air circulation during Convection Bake

Fig. 1

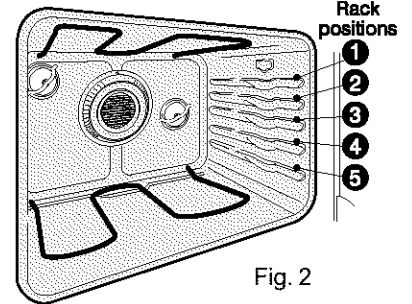







Fig. 2

General Convection Bake Instructions

1. When using Convection Bake, decrease your normal cooking times as shown in the Cooking Tables on page 38. Adjust the cook time for desired doneness as needed. Time reductions will vary depending on the amount and type of food to be cooked. Cookies and biscuits should be baked on pans with no sides or very low sides to allow heated air to circulate around the food. Food baked on pans with a dark finish will cook faster.
2. Preheating is not necessary when cooking casseroles with Convection Bake.
3. When using Convection Bake with a single rack, place oven rack in position 3 or 4. If cooking on multiple racks, place the oven racks in positions 1, 3 and 5 (for 3 racks) and positions 2 and 4 (for 2 racks; See Fig. 2).
4. Cakes have better results when baked with the Cake pad in the Food Categories feature.

INSTRUCTIONS

To set the oven for Convection Bake and temperature to 350°F:

1. Arrange interior oven racks and place food in oven.
2. Press . "CONV BAKE" will flash and "- - -°" will appear in the display (Fig. 3).
3. Press   . "CONV BAKE" and "350°" will appear in the display (See Fig. 4).
4. Press . "CONV BAKE" and "PRE" will appear in the display (Fig. 5) until the oven reaches 350° F. A beep will sound once the oven temperature reaches 350° F and the display will show "350°", "CONV BAKE" and the fan icon (Fig. 6).

Note: The oven icon will show a rotating fan within the square. This rotating fan icon indicates when the Convection Fan is operating (See rotating fan in Fig. 6).

Press  to stop Convection Bake or cancel Convection Bake at any time.

PRESS

DISPLAY



Fig. 3



Fig. 4



Fig. 5



Fig. 6

Setting Oven

Controls

FEATURE OVERVIEW

- Serve Warm



The **SERVE WARM**  pad turns ON the Serve Warm feature and will maintain an oven temperature of 170° F. The **SERVE WARM** feature will keep oven baked foods warm for serving up to 3 hours after cooking has finished. After 3 hours the Serve Warm feature will shut the oven OFF. The Serve Warm feature may be used without any other cooking operations or can be used after cooking has finished using **BAKE**, **CONVECTION BAKE** or **MEATS**.

The Serve Warm feature may be used with **TIMED BAKE** or **DELAYED TIMED BAKE** if you wish to have the Serve Warm feature turn ON automatically when cooking has finished. The Timed Bake and Delayed Timed Bake features require you to set a start time and the amount of cooking time. With this information the control can calculate the time when cooking will complete and can then start the Serve Warm feature automatically.

INSTRUCTIONS

PRESS

To set Serve Warm:

1. Arrange interior oven racks and place baked food in oven. If the food is already in the oven go to step 2.
2. Press . The Serve Warm indicator light will flash.
Note: If no further pads are touched within 25 seconds the request to turn ON Serve Warm will be cleared.
3. Press . The Serve Warm indicator light will glow steady indicating Serve Warm is ON (See Fig. 1).
4. To turn the Serve Warm OFF at any time press  again.
The Serve Warm indicator light will turn OFF (See Fig. 2).
Note: The Serve Warm feature will automatically turn OFF after 3 hours.

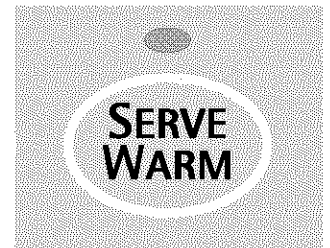

Fig. 1

INSTRUCTIONS

PRESS

To set Serve Warm to turn ON automatically:





1. Arrange interior oven racks and place food in oven. Set the oven properly for **Timed Bake** or **Delayed Timed Bake**.
2. Press . The Serve Warm indicator light will flash.
Note: If no further pads are touched within 25 seconds the request to turn ON Serve Warm will be cleared.
3. Press . The Serve Warm indicator light will glow steady indicating Serve Warm is set to turn ON automatically after Timed Bake or Delayed Timed Bake has finished (See Fig. 1).
4. To turn the Serve Warm OFF at any time press  again.
The Serve Warm indicator light will turn OFF (See Fig. 2).
Note: The Serve Warm feature will automatically turn OFF after 3 hours.



Fig. 2

Pressing  at any time will stop all oven baking operations.

Oven Cleaning

FEATURE OVERVIEW

- Preparing for the Self-Clean Cycle

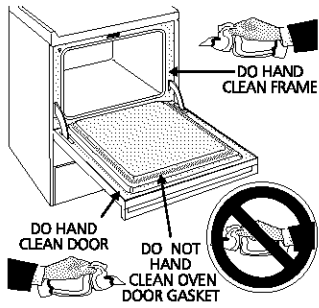

CAUTION The health of some birds is extremely sensitive to the fumes given off during the self-cleaning cycle of any range. Move birds to another well-ventilated room.

Preparing for the Self-Clean Cycle:

A Self-Cleaning oven cleans itself with high temperatures which eliminates soil completely or reduce it to a fine powdered ash you can wipe away with a damp cloth. These temperatures are well ABOVE normal cooking temperatures.

1. Adhere to the following cleaning precautions:

- Allow the oven to cool before pre-cleaning.
- Wear rubber gloves when pre-cleaning and while wiping up the residue after the Self-Clean cycle.
- **DO NOT** use oven cleaners or oven protective coatings in or around any part of the Self-Cleaning oven interior.
- **DO NOT** clean the oven door gasket. The woven material of the oven door gasket is essential for a good seal. Care should be taken not to rub, damage or remove the gasket.
- **DO NOT** use any cleaning materials on the oven door gasket. Doing so could cause damage.

2. Remove the Searing Grill, Broiler Pan and Broiler Pan Insert, all utensils and any aluminum foil. These items cannot withstand high cleaning temperatures.

CAUTION **DO NOT** line the oven walls, racks, bottom or any other part of the range with aluminum foil. Doing so will destroy heat distribution, produce poor baking results and cause permanent damage to the oven interior (aluminum foil will melt to the interior surface of the oven).

3. The porcelain oven racks can remain in the oven during the Self-Clean cycle. If they do go through the Self-Clean cycle, wait until the oven has cooled, then remove the racks and rub their sides with wax paper or a cloth containing a small amount of vegetable oil (this will make the racks glide easier back into their positions).
4. Remove any excess spillovers in the oven cavity before starting the Self-Cleaning cycle. To clean, use hot, soapy water and a cloth. Large spillovers can cause heavy smoke or fire when subjected to high temperatures. **DO NOT** allow food spills with a high sugar or acid content (such as milk, tomatoes, sauerkraut, fruit juices or pie filling) to remain on the surface as they may cause a dull spot even after cleaning.
5. Clean any soil from the oven frame, the door liner outside the oven door gasket, and the small area at the front center of the oven bottom. These areas heat sufficiently to burn soil on. Clean with soap and water.



Fig. 1

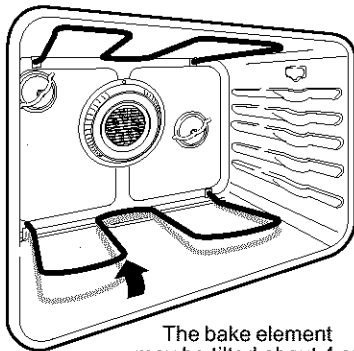

The bake element may be tilted about 4 or 5 inches to clean oven bottom

Fig. 2

If at any time when setting the oven for Self-Cleaning, the oven control continuously beeps and the display shows "dr"; close the oven door (See Fig. 1).

NOTE: Prior to setting the Self-Clean cycle, any spills remaining on the oven bottom should be removed. The bake element is designed to be tilted up using your hand from the front of the bake element (See Fig. 2). This will allow easier access to the oven bottom for cleaning. Be careful not to raise the element more than 4 or 5 inches from the resting position.

Oven Cleaning

FEATURE OVERVIEW

- Starting the Self-Clean Cycle

To Start the Self-Clean Cycle

The **CLEAN**  pad controls the Self-Cleaning feature. If you are planning to use the oven directly after a Self-Clean cycle remember to allow time for the oven to cool down and the oven door to unlock. This normally takes about one hour. So to Self-Clean for 3 hours will actually take about 4 hours to complete.





*It is recommend to use a 2 hour Self-Clean cycle for **light soil**, a 3 hour cycle for **average soil**, and a 4 hour cycle for **heavy soil** (to assure satisfactory results).

⚠ WARNING During the Self-Cleaning cycle, the outside of the range can become very hot to the touch. **DO NOT** leave small children unattended near the appliance; they may be burned if they touch the hot oven door surfaces.

⚠ CAUTION **DO NOT** force the oven door open. This can damage the automatic door locking system. Use care when opening the oven door after the Self-Cleaning cycle. Stand to the side of the oven when opening the door to allow hot air or steam to escape. The oven may still be VERY HOT.

INSTRUCTIONS

To set the controls for a 3 hour Self-Cleaning cycle to start immediately and shut off automatically:

- Be sure the clock is set with the correct time of day and the oven door is closed.
- Press . "**CLEAN**" will flash and "**3:00**" (hours) will show in the display (Fig. 1). The control will clean for a 3 hour period (default Self-Cleaning cycle time). Note: If a 2 or 4 hour clean time is desired, press  for 2 hour or press  for a 4 hour clean time. Set the cleaning time based on the amount of soil; light, medium or heavy (*See above).
- Press . The "**DOOR LOCKED**" icon will flash; "**CLEAN**" icon and the letters "**CLn**" will remain on in the display (Fig. 2).
- As soon as the control is set, the motor driven oven door lock will begin to close automatically. Once the door has been locked the "**DOOR LOCKED**" indicator light will stop flashing and remain on. Also, the oven icon will appear in the display (See Fig. 3).

Note: Allow about 15 seconds for the oven door lock to close.

When the Self-Clean cycle is done:

- The time of day, "**DOOR LOCKED**" and "**CLn**" icon will remain in the display (Fig. 4).
- Once the oven has cooled down for approximately 1 HOUR, and the "**DOOR LOCKED**" icon is no longer displayed, the oven door can then be opened (Fig. 5).

Stopping or Interrupting a Self-Cleaning cycle:

If it becomes necessary to stop or interrupt a Self-Cleaning cycle due to excessive smoke or fire in the oven:

- Press .
- Once the oven has cooled down for approximately 1 HOUR and the "**DOOR LOCKED**" icon is no longer displayed, the oven door can then be opened (Fig. 5).

PRESS

DISPLAY

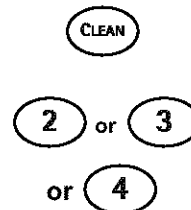

Fig. 1



Fig. 2



Fig. 3



Fig. 4



Fig. 5





NOTE: The Self-Clean feature will not operate whenever a radiant surface element is ON.

Oven Cleaning

FEATURE OVERVIEW

- Delayed Self-Clean Cycle

To Start the Delayed Self-Clean Cycle









The **CLEAN** , **START TIME**  pads and length of clean cycle, controls the Delayed Self-Clean operation. The automatic timer will turn the oven **on and off** at the time you select in advance. Be sure to review **TO START THE SELF-CLEAN CYCLE** for recommended clean times.

⚠ WARNING During the Self-Cleaning cycle, the outside of the range can become very hot to the touch. **DO NOT** leave small children unattended near the appliance.

⚠ CAUTION **DO NOT** force the oven door open. This can damage the automatic door locking system. Use care when opening the oven door after the self-cleaning cycle. Stand to the side of the oven when opening the door to allow hot air or steam to escape. The oven may still be **VERY HOT**.

INSTRUCTIONS

To set the control for the Self-Cleaning cycle to start at a delayed time and shut off automatically: (example 3 hour Self-Clean cycle to start at 9:00 o'clock):

1. Be sure the clock is set with the correct time of day and the oven door is closed.
2. Press . "CLEAN" will flash and "3:00" (hours) will show in the display (Fig. 1). The control will clean for a 3 hour period (default Self-Cleaning cycle time). Note: If a 2 or 4 hour clean time is desired, press  for 2 hour or press  for a 4 hour clean time. Set the cleaning time based on the amount of soil — light, medium or heavy (*See page 28).
3. Press . The "DOOR LOCKED" icon will flash; "CLEAN" icon and the letters "CLn" will remain on in the display (Fig. 2).
4. Press  (Fig. 3). Enter the desired Self-Clean starting time using the number pads    (Fig. 4).
5. Press . The "CLn" icon will turn off; "DELAY", "DOOR LOCKED" and "CLEAN" icons will remain on.
6. As soon as the control is set, the motor driven oven door lock will begin to close automatically and once the door has been locked the "DOOR LOCKED" indicator light will quit flashing and remain on (Fig. 5).
7. The control will calculate forward from the set start time to determine when the self-cleaning cycle should end. The Self-Cleaning cycle will turn on automatically at the set time. At that time the icon "DELAY" will go out; the oven icon will come on, the start time, "CLEAN" and "CLn" will appear in the display (See Fig. 6).

When the Self-Clean cycle is done:

1. The time of day, "DOOR LOCKED" and "CLEAN" icon will remain in the display (Fig. 7).
2. Once the oven has cooled down for approximately 1 HOUR, and the "DOOR LOCKED" icon is no longer displayed, the oven door can then be opened (Fig. 8).

PRESS

DISPLAY

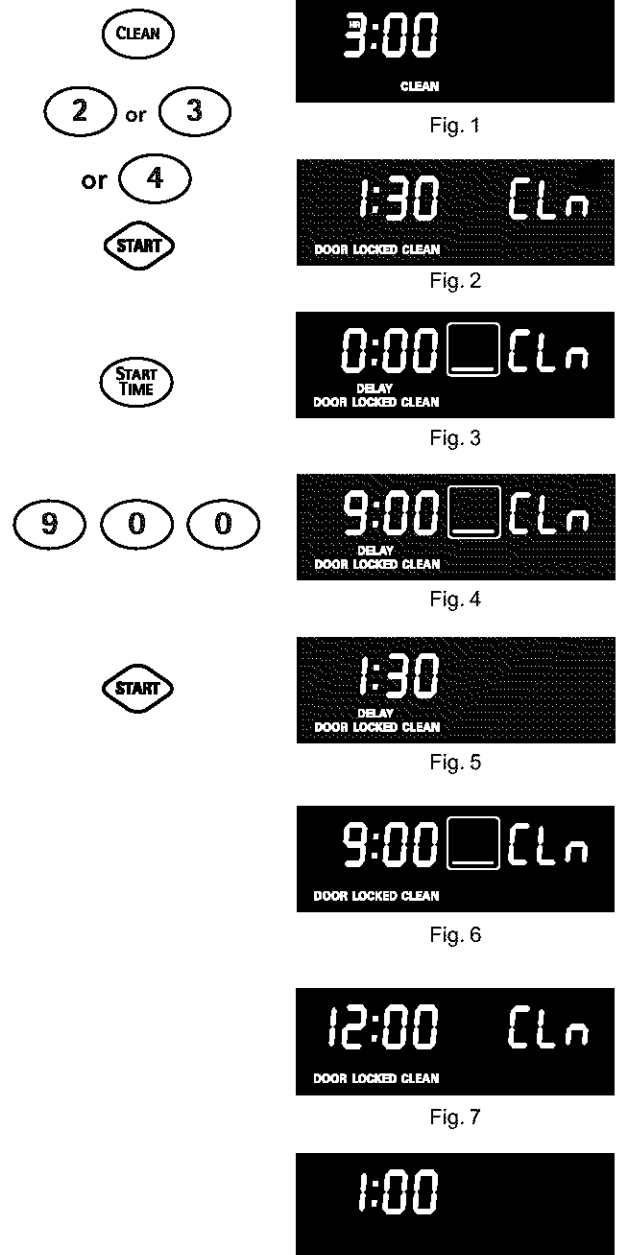

The diagram illustrates the sequence of button presses and corresponding display changes for the delayed self-clean cycle. It includes icons for the following buttons: CLEAN, 2, 3, 4, START, START TIME, 9, 0, 0, and START. The display screens are labeled as follows:

- Fig. 1:** Shows "3:00" and "CLEAN".
- Fig. 2:** Shows "1:30" and "CLn".
- Fig. 3:** Shows "0:00" and "CLn".
- Fig. 4:** Shows "9:00" and "CLn".
- Fig. 5:** Shows "1:30" and "CLn".
- Fig. 6:** Shows "9:00" and "CLn".
- Fig. 7:** Shows "12:00" and "CLn".
- Fig. 8:** Shows "1:00".



Oven Cleaning

FEATURE OVERVIEW

- Delayed Self-Clean Cycle (Cont'd.)

INSTRUCTIONS

PRESS

DISPLAY

Stopping or Interrupting a Self-Cleaning cycle:

If it becomes necessary to stop or interrupt a Self-Cleaning cycle due to excessive smoke or fire in the oven:

1. Press .
2. Once the oven has cooled down for approximately 1 HOUR and the "DOOR LOCKED" icon is no longer displayed, the oven door can then be opened (Fig. A).



Fig. A

NOTE: If your clock is set for normal 12 hour display mode the Delayed Self-Clean cycle can never be set to start more than 12 hours in advance. To set for Delayed Self-Clean 12-24 hours in advance see page 15 for instructions to set the control for the 24 hour time of day display mode.

Adjusting Oven Temperature

FEATURE OVERVIEW

The temperature in the oven has been pre-set at the factory. When first using the oven, be sure to follow recipe times and temperatures. If you think the oven is too hot or too cool, the temperature in the oven can be adjusted. Before adjusting, test a recipe by using a temperature setting that is higher or lower than the recommended temperature. The baking results should help you to decide how much of an adjustment is needed.

Note: The oven temperature adjustments made with this feature will not change the Self-Clean cycle temperature.

INSTRUCTIONS

PRESS

DISPLAY

To adjust the oven temperature higher:





1. Press  for 6 seconds (Fig. 1).
2. To increase the temperature use the number pads to enter the desired change. (Example 30°F)   (Fig. 2). The temperature may be increased as much as 35°F (17°C).
3. Press  to accept the temperature change and the display will return to the time of day (Fig. 3). Press  to reject the change if necessary.



Fig. 1



Fig. 2



Fig. 3

To adjust the oven temperature lower:







1. Press  for 6 seconds (Fig. 4).
2. To decrease the temperature use the number pads to enter the desired change. (Example -30°F)   and then press  (Fig. 5). The temperature may be decreased as much as 35°F (17°C).
3. Press  to accept the temperature change and the display will return to the time of day (Fig. 6). Press  to reject the change if necessary.



Fig. 4



Figure 5

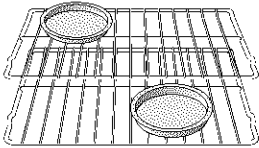
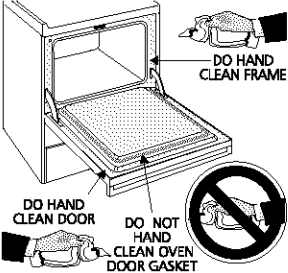

Figure 6

General Care & Cleaning

FEATURE OVERVIEW

- Care & Cleaning Table

Surfaces:	How to Clean:
Aluminum & Vinyl	Use hot, soapy water and a cloth. Dry with a clean cloth.
Painted & plastic control panel parts, knobs & decorative trims	<i>For general cleaning</i> , use hot, soapy water and a cloth. <i>For more difficult soil and built-up grease</i> , apply a liquid detergent directly onto the soil. Leave on soil for 30 to 60 minutes. Rinse with a damp cloth and dry. DO NOT use abrasive cleaners on any of these materials; they can scratch. To remove control knobs, turn to the OFF position; grasp firmly and pull straight off the shaft. To replace knobs after cleaning, line up the flat sides of both the knob and the shaft; then push the knob into place.
Glass control panel	<i>Before cleaning the control panel</i> make sure all cooktop controls are set to OFF and turn the Oven Lockout feature ON . Clean using hot, soapy water and a dishcloth then rinse with clean water. Be sure to squeeze excess water from the cloth before wiping the panel; especially when wiping around the controls. Excess water in or around the controls may cause damage to the appliance. To finish cleaning or for lighter soil use a typical household glass cleaner and paper towels. DO NOT use abrasive cleaners on any of these materials; they can scratch.
Stainless Steel , chrome control panel & metal decorative trims	Clean Stainless Steel with hot, soapy water and a dishcloth. Rinse with clean water and a cloth. Do not use cleaners with high concentrations of chlorides or chlorines . Do not use harsh scrubbing cleaners. Only use kitchen cleaners that are especially made for cleaning Stainless Steel. Always be sure to rinse the cleaners from the surface as bluish stains may occur during heating that cannot be removed.
Porcelain enamel broiler pan & insert, door liner, body parts & interior Warmer Drawer area	Gentle scouring with a soapy scouring pad will remove most spots. Rinse with a 1:1 solution of clear water and ammonia. <i>If necessary</i> , cover difficult spots with an ammonia-soaked paper towel for 30 to 40 minutes. Rinse with clean water and a damp cloth, and then scrub with a soap-filled scouring pad. Rinse and wipe dry with a clean cloth. Remove all cleaners or the porcelain may become damaged during future heating. DO NOT use spray oven cleaners on the cooktop.
Porcelain oven racks 	Porcelain oven racks may be left in the oven during the Self-Clean cycle. If further cleaning is required, remove the racks after the oven has cooled & clean using a mild non-abrasive cleaner following manufacturer's instructions. Rinse with clean water and let dry. After the Self-Clean cycle is done and the oven has cooled, rub the sides of the oven racks with wax paper or a cloth containing a small amount of vegetable oil. This will make the racks glide easier into the oven rack positions.
Oven door 	To clean oven door remove following the door removal instructions in this Use & Care Guide. Wash soiled areas with hot, soapy water and a clean cloth. DO NOT immerse the door in water. DO NOT clean the oven door gasket. On Self-Cleaning models the oven door gasket is made of a woven material which is essential for a good seal. Care should be taken not to rub, damage or remove this gasket.
Ceramic Cooktop	Follow the instructions the "Cooktop Cleaning & Maintenance" in this Use & Care Guide.

General Care & Cleaning

FEATURE OVERVIEW

- Cleaning Grates, Burner Caps, Burner Heads and Wok Stand

Cleaning the Burner Grates, Burner Caps, Burner Heads and Wok Stand

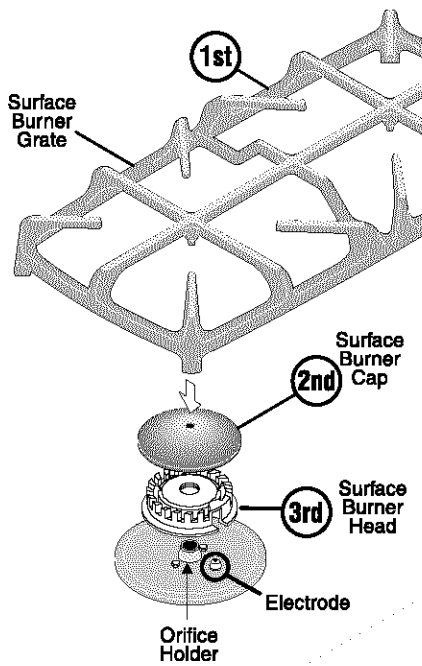

Fig. 1

The Burner Grates, Burner Caps, Burner Heads and Wok Stand should be routinely cleaned. Keeping the burner ports clean will prevent improper ignition and an uneven flame at each burner position. Refer to the following instructions:

To Remove and Replace the Surface Burner Grate, Surface Burner Cap and Surface Burner Head - Remove in the following order; (1st) Surface Burner Grate, (2nd) Surface Burner Cap, (3rd) Surface Burner Head (See Fig. 1).

Reverse the procedure above to replace the Surface Burner Cap, Surface Burner Head and Surface Burner Grate. **Do not remove any burner parts from the cooktop until the burner parts have completely cooled and are safe to handle. Do not operate the surface burners without the Surface Burner Caps, Surface Burner Heads and Surface Burner Grates in their proper locations** (See page 7 for instructions).

To Clean the Burner Caps, Burner Heads, Grates and Wok Stand - Use a soap-filled scouring pad or a mild abrasive cleanser to clean the surface burner caps and surface burner heads. The Grates and Wok Stand are designed to be Dishwasher safe for cleaning. The ports (or slots) around the burner heads must be routinely cleaned. If residue still remains in these ports, use a small-gauge wire or needle to clean the slots or holes. For proper flow of gas and ignition of the burner—**DO NOT ALLOW SPILLS, FOOD, CLEANING AGENTS OR ANY OTHER MATERIAL TO ENTER THE GAS ORIFICE HOLDER OPENING.** **ALWAYS** keep the surface burner cap and surface burner head in place whenever a surface burner is in use.

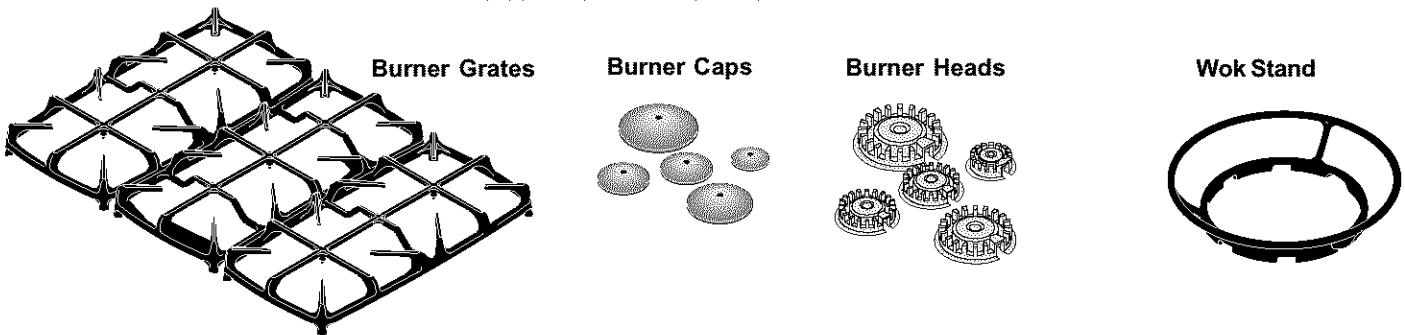

THE COOKTOP IS NOT REMOVABLE. Do not attempt to remove or lift the cooktop.

CAUTION Use caution when replacing the burner cap so the electrode is not damaged. This may cause a delayed ignition or prevent the burner from igniting.

CAUTION Any additions, changes or conversions required in order for this appliance to perform satisfactorily must be made by Sears Service. Call **1-800-4-MY-HOME®** (See back cover).

General Care & Cleaning

FEATURE OVERVIEW

- Cooktop Cleaning & Maintenance

Cooktop Cleaning and Maintenance

Consistent and proper cleaning is essential to maintaining your ceramic glass cooktop.

Prior to using your cooktop for the first time, apply the recommended CookTop® Cleaning Creme (P/N 22-40079) to the ceramic surface. Buff with a non-abrasive cloth or pad. This will make cleaning easier when soiled from cooking. The special cooktop cleaning cream leaves a protective finish on the glass to help prevent scratches and abrasions.

Sliding aluminum or copper clad bottom pans on the cooktop can cause metal markings on the cooktop surface. These marks should be removed **immediately** after the cooktop has cooled using the cooktop cleaning cream. Metal marks can become permanent if not removed prior to future use.

Cookware (cast iron, metal, ceramic or glass) with rough bottoms can mark or scratch the cooktop surface. **Do not slide anything metal or glass** across the cooktop. **Do not** use your cooktop as a cutting board or work surface in the kitchen. **Do not** cook foods directly on the cooktop surface without a pan. **Do not** drop heavy or hard objects on the glass cooktop, they may cause it to crack.

Cleaning Recommendations for the Ceramic Glass Cooktop

CAUTION Before cleaning the cooktop, be sure the controls are turned to **OFF** and the cooktop is **COOL**.

WARNING DO NOT use a cooktop cleaner on a hot cooktop. The fumes can be hazardous to your health, and can chemically damage the ceramic-glass surface.

For light to moderate soil:

Apply a few drops of CookTop® Cleaning Creme directly to the cooktop. Use a paper towel or a 3M Scotch-Brite® Blue Multi-Purpose No Scratch Scrub Sponge to clean the entire cooktop surface. Make sure the cooktop is cleaned thoroughly, leaving no residue.

For heavy, burned on soil:

Apply a few drops of CookTop® Cleaning Creme directly to the soiled area. Rub the soiled area using a 3M Scotch-Brite® Blue Multi-Purpose No Scratch Scrub Sponge, applying pressure as needed. Do not use the sponge you use to clean the cooktop for any other purpose.

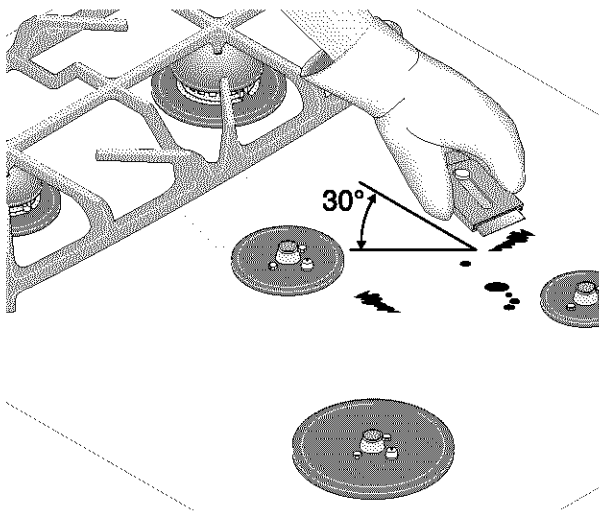

If soil remain, carefully scrape soil with a metal razor blade scraper, holding scraper at a 30 degree angle to the surface. Remove loosened soil with cooktop cleaning cream and buff the cooktop surface clean.

CAUTION Damage to the ceramic glass cooktop may occur if you use any scrub pad other than a 3M Scotch-Brite® Blue Multi-Purpose No Scratch Scrub Sponge.

Plastic or foods with a high sugar content:

These types of soils need be removed immediately if spilled or melted onto the ceramic cooktop surface. Permanent damage (such as pitting of the cooktop surface) may occur if not removed **immediately**. After turning the surface elements **OFF**, use a razor blade scraper or a metal spatula with a mitt and scrape the soil from the hot surface (as illustrated). Allow the cooktop to cool, and use the same method for heavy or burned on soil.

General Care & Cleaning

FEATURE OVERVIEW

- Cleaning Recommendations for Ceramic Glass Cooktops (cont'd.)
- Care & Cleaning of Stainless Steel / Removing & Replacing Oven Door

Do not use the following on the ceramic glass cooktop:

- Do not use abrasive cleaners and scouring pads, such as metal and some nylon pads. They may scratch the cooktop, making it more difficult to clean.
- Do not use harsh cleaners, such as chlorine bleach, ammonia or oven cleaners, as they may etch or discolor the cooktop.
- Do not use dirty sponges, cloths or paper towels, as they can leave soil or lint on the cooktop which can burn and later cause discoloration.



Special Caution for Aluminum Foil and Aluminum cooking utensils:

- **Aluminum Foil** - Use of aluminum foil will damage the ceramic cooktop. Do not use thin aluminum cooking utensils or allow aluminum foil to touch the ceramic cooktop under ANY circumstances.
- **Aluminum utensils** - The melting point of aluminum is much lower than that of other metals. Care must be taken when aluminum pots or pans are used on the cooktop. If allowed to boil dry, not only will the utensil be destroyed, but it may fuse to, break or mark the ceramic glass surface, permanently damaging the cooktop surface.

Care and Cleaning of Stainless Steel (some models)

Some models are equipped with Stainless Steel exterior parts. Special care and cleaning are **required** for maintaining the appearance of Stainless Steel parts. Please refer to the Care & Cleaning Table provided at the beginning of the **Care & Cleaning** section in this Use & Care Guide.

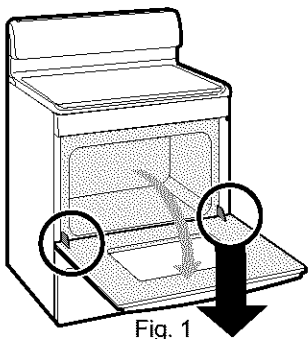

Fig. 1

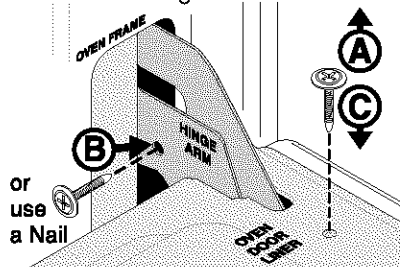

Fig. 2

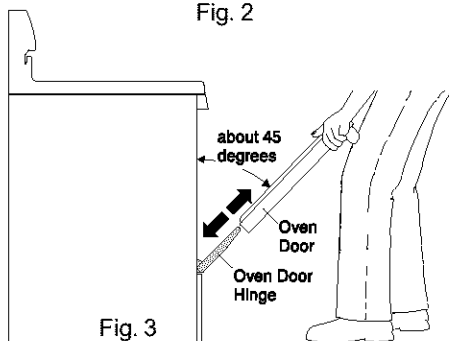

Fig. 3

Removing and Replacing the Oven Door

CAUTION The door is heavy. For safe, temporary storage, lay the door flat with the inside of the door facing down.

To Remove Oven Door:

1. Open oven door completely (horizontal with floor - See Fig. 1).
2. Remove 2 screws located on the inside of the door liner (See A Fig. 2)
3. Insert the 2 screws into the door hinge holes located on the side of the hinge arm, one into each hinge (See B Fig. 2).
4. Close oven door until the door stops, (Do not force the door to close any further). The placement of these screws should keep door open in about a 45 degree position.
5. Grasp oven door firmly on both sides and slide door up and off hinges at the same angle. (See Fig. 3)
6. To clean oven door follow the instructions in the **Care & Cleaning Table**.

To Replace Oven Door:

1. Be sure the hinge arms remain at the 45 degree angle position. Be sure the screws are still locking the hinge arms from moving. If the screws fall out of the hinge holes, the hinge(s) may snap back against the oven frame and could pinch fingers or chip the porcelain finish on the oven front frame.
2. Hold door at the sides near the top while resting the lower front of door on your knee. Insert the door channels at the bottom of door over the door hinges, (See Fig. 3).
3. Allow the door to slide down into the door hinges evenly at the same 45 degree angle. The hinge arms should be inserted into the bottom corners as far as they can go.
4. Open door completely (horizontal with floor) and remove both screws from holes in door hinges.
5. Reinstall the 2 screws into the door liner (See C Fig. 2).
6. If the door is not in alignment with the oven frame, remove door and repeat the above steps.

General Care & Cleaning

FEATURE OVERVIEW

- Removing & Replacing Warmer Drawer

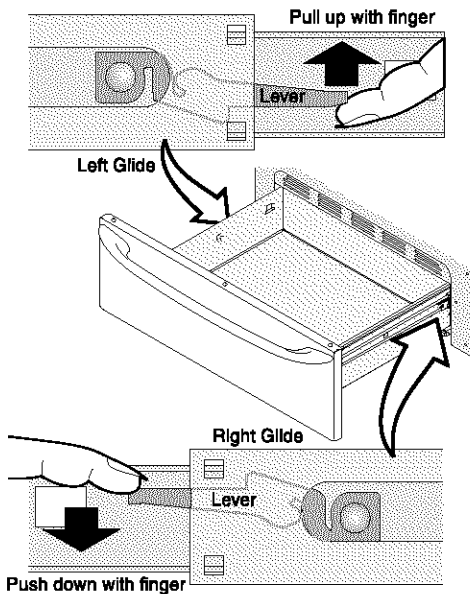

Fig. 1

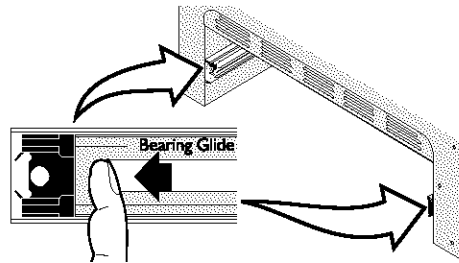

Fig. 2

To Remove and Replace Warmer (Warm & Ready™) Drawer

To Remove Warmer Drawer:

1. **CAUTION** Turn power off before removing the Warmer Drawer.
2. Open the drawer to the fully opened position.
3. Locate glide lever on each side of drawer, pull up on the left glide lever and push down on the right glide lever.
4. Pull the Warmer Drawer away from the range.

To Replace Warmer Drawer:

1. **Pull the bearing glides to the front** of the chassis glide (See Fig. 2).
2. Align the glide on each side of the drawer with the glide slots on the range.
3. Push the Warmer Drawer into the range until levers “click” (approximately 2”). Pull the drawer open again to seat bearing glides into position. **If you do not hear the levers “click” or the bearing glides do not feel seated remove the drawer and repeat steps 1-3.** This will minimize possible damage to the bearing glides.

NOTE: The Warmer Drawer will **NOT** operate while in the Self-Clean and “Oven Lockout” modes



WARNING Electrical Shock Hazard can occur and result in serious injury or death. Disconnect appliance from electric power before cleaning and servicing the warmer drawer.

Oven Lights

FEATURE OVERVIEW

- Operating Oven Lights
- Replacing Oven Light

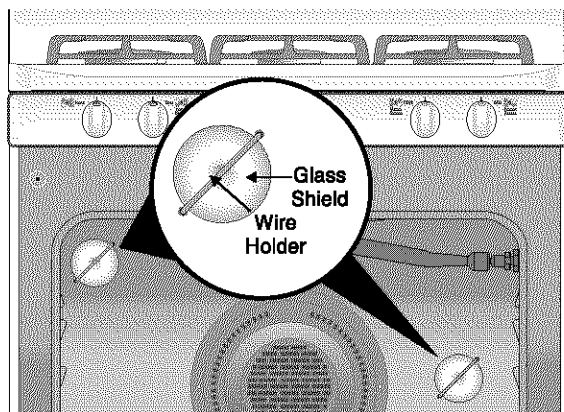

Fig. 3

CAUTION Be sure the range is unplugged and all parts are COOL before replacing oven light(s). Wear a leather-faced glove for protection against possible broken glass.

To Operate the Oven Lights

Both of the interior oven lights automatically turn on when the oven door is opened. Press **OVEN LIGHT** to turn the lights ON and OFF when the oven door is closed. Each oven light is located at the rear wall of the oven interior and is covered with a glass shield held by a wire holder (See Fig. 3). The Glass Shields must be in place whenever the oven is in use.

To Replace the Oven Light(s):

1. Turn electrical power off at the main source and unplug the range.
2. Press wire holder to one side to release the glass shield.
3. Replace the old bulb with a new 40 watt appliance bulb.
4. Replace glass shield over bulb and snap wire holder into place.
5. Turn power back on again at the main source (or plug in the range).
6. The clock will then need to be reset. To reset, see **Setting the Clock** in this Use & Care Guide.

Before You Call

Solutions to Common Problems

Before you call for service, review this list. It may save you time and expense. The list includes common occurrences that are not the result of defective workmanship or materials in this appliance.

OCCURRENCE	POSSIBLE CAUSE/SOLUTION
Range is not level.	<p>Poor installation. Place oven rack in center of oven. Place a level on the oven rack. Adjust leveling legs at base of range until the rack is level. When range is level, cooktop may appear out of alignment if countertop is not level (See the Range Installation Instructions).</p> <p>Weak, unstable floor. Be sure floor is level and can adequately support range. Contact a carpenter to correct sagging or sloping floor.</p> <p>Kitchen cabinet misalignment may make range appear to be unlevel. Be sure cabinets are square and have sufficient room for range clearance.</p>
Cannot move appliance easily. Appliance must be accessible for service.	<p>Cabinets not square or are built in too tight. Contact a cabinet maker to correct the problem.</p> <p>Contact builder or installer to make appliance accessible.</p> <p>Carpeting interferes with range. Provide sufficient space so range can be lifted over carpet.</p> <p>Gas line is hard-plumbed. Have a flexible C.S.A. International approved metal appliance connector installed.</p>
Surface burners do not light.	<p>Surface Control knob has not been completely turned to LITE. Push in and turn the Surface Control knob to LITE until burner ignites and then turn control knob to desired flame size.</p> <p>Burner ports are clogged. See "Cleaning the Burner Grates, Burner Caps, Burner Heads and Wok Stand" on page 31 for additional cleaning instructions.</p> <p>Range power cord is disconnected from outlet (electric ignition models only). Be sure cord is securely plugged into the outlet.</p> <p>Electrical power outage (electric ignition models only). Be sure the gas supply to the range is turned "ON."</p>
Surface burner flame burns half way around.	<p>Burner ports are clogged. See "Cleaning the Burner Grates, Burner Caps, Burner Heads and Wok Stand" on page 31 for additional cleaning instructions.</p> <p>Moisture is present after cleaning. Lightly fan the flame and allow burner to operate until flame is full. Dry the burners thoroughly following instructions in the "General Care & Cleaning" section.</p>
Surface burner flame is orange.	<p>Dust particles in main line. Allow the burner to operate a few minutes until flame turns blue.</p> <p>In coastal areas, a slightly orange flame is unavoidable due to salt air.</p>
Oven does not operate.	<p>No electrical power to the appliance. See steps under "Entire Appliance Does Not Operate" in the "Before You Call" checklist (this section).</p> <p>Be sure the oven controls are set correctly for the desired function. See "Setting Oven Controls" section or "Entire appliance does not operate" in this table.</p> <p>The time of day must first be set on the clock in order to operate the oven.</p>
Entire appliance does not operate.	<p>Make sure electrical cord/plug is plugged tightly into outlet.</p> <p>Service wiring is not complete. Call 1-800-4-MY-HOME® (See back cover).</p> <p>Electrical power outage (electric ignition models only). Check house lights to be sure. Call your local electric company for service. Surface burners can be lit manually.</p>
Oven light or lights do not work.	<p>Burned-out or loose bulb. See "Replacing Oven Light" section in this Use & Care Guide to replace or tighten the bulb(s).</p> <p>Electrical power outage. Check house lights to be sure. Call your local electric company for service.</p>

Before You Call

Solutions to Common Problems

OCCURRENCE	POSSIBLE CAUSE/SOLUTION
Oven smokes excessively during broiling.	<p>Meat is too close to the broil element. Reposition the rack to provide more clearance between the meat and the oven broil element.</p> <p>Meat is not properly prepared. Remove excess fat from meat. Remove remaining fatty edges to prevent the meat from curling, but do not cut into the lean of the meat.</p> <p>Broiler Pan used without the Broiler Pan Insert or insert is covered with foil. DO NOT use the Broiler Pan without the Broiler Pan Insert or cover the insert with foil.</p> <p>Broiler Pan or Broiler Pan Insert needs to be cleaned. Excessive smoking is caused by a build-up of grease or food spatters. Clean the Broiler Pan and insert on a regular basis.</p> <p>Oven door is closed. Oven door should be opened to broil stop position when broiling.</p>
Oven electronic control beeps and displays "F1, F3" or "F9".	<p>This oven is equipped with a state of the art electronic oven controller. Among the many features is a full time oven circuit diagnostics system. The controller constantly monitors the internal circuitry as well as several crucial oven circuits to insure they are all operating correctly. If at any time one of these systems fails, the controller will immediately stop the current operation and beep continuously (flashing an error code of "F1, F3" or "F9" in the controller display window.</p> <p>Electronic control has detected a fault condition. Press STOP/CLEAR to clear the display and stop beeping. Reprogram oven. If fault remains, record fault number. Press STOP/CLEAR and call 1-800-4-MY-HOME® (See back cover).</p>
Oven control beeps when you try to enter times or temperatures	<p>The oven control will only accept correct responses and/or the minimum number of allowable entries for the appropriate feature. The oven control is designed to prevent accidental entries. Review the instructions in this Use & Care Guide for the feature you are trying to use. Also review the minimum and maximum temperature entries for the feature you are trying to set on page 14 in this Use & Care Guide.</p>
Poor baking results.	<p>Many factors affect baking results. Make sure the proper rack position is being used. Center food in the oven and space pans to allow air to circulate. Allow the oven to preheat to the set temperature before placing food in the oven. Try adjusting the recipe's recommended temperature or baking time. If you feel the oven is cooking too hot or cool. See "Adjusting the Oven Temperature" in this Use & Care Guide.</p>
Self-Cleaning cycle does not work.	<p>Controls are not set properly. Follow instructions in the Self-Cleaning section.</p> <p>Self-cleaning cycle was interrupted. Stop time must be set 2 to 4 hours past the start time. Follow steps under "Stopping or Interrupting a Self-Clean Cycle" in the Oven Cleaning section.</p>
Soil is not completely removed.	<p>Set Self-Clean cycle for a longer cleaning time.</p> <p>Failure to clean bottom front, top of oven or door areas outside oven seal. These areas are not in the Self-Cleaning area, but get hot enough to burn on food residue. Clean these areas before starting the Self-Clean cycle. Burned-on residue may be cleaned with a stiff nylon brush and water or a nylon scrubber. Be careful not to damage the oven gasket.</p>
Excessive smoking from oven vent.	<p>Excessive spillovers in oven, especially for pie spillovers or large amounts of grease on the oven bottom. Wipe up excessive spillovers before starting the Self-Clean cycle. If flames or excessive smoke are present, stop the self-clean cycle and follow the steps under "Stopping or Interrupting the Self-Clean Cycle" in the Oven Cleaning section.</p>

ME
G
S

Cooking Tables

Foods for CONV BAKE CONVECTION BAKE pad *Decrease normal cook time by:	
Frozen foods, pies, pastries and pizza	15-25 %
Refrigerator cookies	15-35 %
Refrigerator biscuits	15-30 %
Rolls & Breads	20-25%
Fresh Pies/Pastries	10-20 %
Begin with the maximum reduction in cook times and adjust as needed.	
*Recommended reduction in cook times based on brands of food items tested. Cook times may vary with your specific brand of food item.	

Foods for MEATS MEATS pad in Food Categories *Decrease normal cook time by:	
Meats	15-30 %
Poultry (unstuffed)	20-30 %
Begin with the maximum reduction in cook times and adjust as needed.	
*Recommended reduction in cook times based on brands of food items tested. Cook times may vary with your specific brand of food item.	

PROTECTION AGREEMENTS

In the U.S.A.

Master Protection Agreements

Congratulations on making a smart purchase. Your new Kenmore® product is designed and manufactured for years of dependable operation. But like all products, it may require preventive maintenance or repair from time to time. That's when having a Master Protection Agreement can save you money and aggravation.

Purchase a Master Protection Agreement now and protect yourself from unexpected hassle and expense.

The Master Protection Agreement also helps extend the life of your new product. Here's what's included in the Agreement:

- ☑ **Expert service** by our 12,000 professional repair specialists
- ☑ **Unlimited service and no charge** for parts and labor on all covered repairs
- ☑ **"No-lemon" guarantee** – replacement of your covered product if four or more product failures occur within twelve months
- ☑ **Product replacement** if your covered product can't be fixed
- ☑ **Annual Preventive Maintenance Check** at your request – no extra charge
- ☑ **Fast help by phone** – phone support from a Sears technician on products requiring in-home repair, plus convenient repair scheduling
- ☑ **Power surge protection** against electrical damage due to power fluctuations
- ☑ **Rental reimbursement** if repair of your covered product takes longer than promised

Once you purchase the Agreement, a simple phone call is all that it takes for you to schedule service. You can call anytime day or night, or schedule a service appointment online.

Sears has over 12,000 professional repair specialists, who have access to over 4.5 million quality parts and accessories. That's the kind of professionalism you can count on to help prolong the life of your new purchase for years to come. Purchase your Master Protection Agreement today!

Some limitations and exclusions apply. For prices and additional information call 1-800-827-6655.

Sears Installation Service

For Sears professional installation of home appliances, garage door openers, water heaters, and other major home items, in the U.S.A. call 1-800-4-MY-HOME®

In Canada

Maintenance Agreements

Your purchase has added value because you can depend on Sears HomeCentral® for service. With over 2400 Service Technicians and more than a million parts and accessories, we have the tools, parts, knowledge and skills to ensure our pledge: We Service What We Sell.

Your Kenmore® product is designed, manufactured and tested to provide years of dependable operation. But like all products, it may require service from time to time. The Sears Maintenance Agreement offers you an outstanding service program, affordably priced.

The Sears Maintenance Agreement:

- Is your way to buy tomorrow's service at today's price
- Eliminates repair bills resulting from normal wear and tear
- Provides phone support from a Sears technician on products requiring in-home repair
- Even if you don't need repairs, provides an annual Preventive Maintenance Check, at your request, to ensure that your product is in proper running condition.

Some limitations apply. For more information about Sears Canada Maintenance Agreements, call 1-800-361-6665

M
E
S
S
A
G
E

Get it fixed, at your home or ours!

Your Home

For repair – **in your home** – of **all** major brand appliances, lawn and garden equipment, or heating and cooling systems, **no matter who made it, no matter who sold it!**

For the replacement parts, accessories and owner's manuals that you need to do-it-yourself.

For Sears professional installation of home appliances and items like garage door openers and water heaters.

1-800-4-MY-HOME® (1-800-469-4663)

Call anytime, day or night (U.S.A. and Canada)

www.sears.com www.sears.ca

Our Home

For repair of carry-in items like vacuums, lawn equipment, and electronics, call or go on-line for the location of your nearest **Sears Parts & Repair Center.**

1-800-488-1222

Call anytime, day or night (U.S.A. only)

www.sears.com

To purchase a protection agreement (U.S.A.) or maintenance agreement (Canada) on a product serviced by Sears:

1-800-827-6655 (U.S.A.)

1-800-361-6665 (Canada)

Para pedir servicio de reparación a domicilio, y para ordenar piezas:

1-888-SU-HOGARSM

(1-888-784-6427)

Au Canada pour service en français:

1-800-LE-FOYER^{MC}

(1-800-533-6937)

www.sears.ca

SEARS