

Panasonic®

LCD TV Operating Instructions

Model No. **TC-14LA1**
TC-17LA1
TC-20LA1

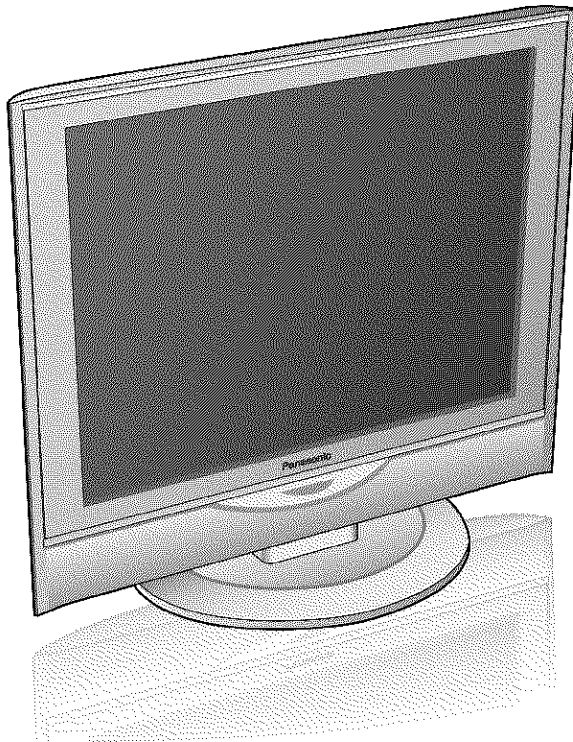

For assistance, please call : 1-800-211-PANA (7262)
or send e-mail to : consumerproducts@panasonic.com
or visit us at www.panasonic.com (U.S.A)

For assistance, please call : 787-750-4300
or visit us at www.panasonic.com (Puerto Rico)

For assistance, please call : 1-800-561-5505
or visit us at www.panasonic.ca (Canada)

Before connecting, operating or adjusting this product, please read these instructions completely.
Please keep this manual for future reference.

English

TQBC0543

Important Safety Instructions

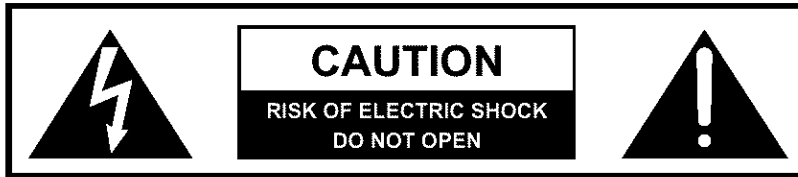

The lightning flash with arrow head within a triangle is intended to tell the user that parts inside the product are a risk of electric shock to persons.



The exclamation point within a triangle is intended to tell the user that important operating and servicing instructions are in the papers with the appliance.

■ **Note to CATV System Installer:** This reminder is provided to direct the CATV system installer's attention to Article 820–40 of the NEC that provides guidelines for proper grounding and, in particular, specifies that the cable ground shall be connected to the grounding system of the building, as close to the point of cable entry as practical.

■ Important Safety Instructions for LCD TV

- 1) Read these instructions and apply them with your LCD TV.
- 2) Keep these instructions.
- 3) Heed all warnings.
- 4) Follow all instructions.
- 5) Do not use this apparatus near water. For example: Avoid placing it near a bathtub, washbowl, kitchen sink, or laundry tub, in a wet basement, or near a swimming pool, etc.
- 6) Clean only with dry cloth. Unplug this LCD TV from the wall outlet before cleaning. Do not use liquid or aerosol cleaners.
- 7) Do not block any ventilation openings. Install in accordance with the manufacturer's instructions. Slots and openings in the cabinet and the back or bottom are provided for ventilation, and to ensure reliable operation of the LCD TV and to protect it from overheating. These openings must not be blocked or covered. There should be at least 10 cm of space from these openings. The openings should never be blocked by placing the LCD TV on a bed, sofa, rug or other similar surface. This LCD TV should not be placed in a built-in installation such as a bookcase unless proper ventilation is provided.
- 8) Do not install near any heat sources such as radiators, heat registers, stoves, or other apparatus (including amplifiers) that produce heat.
- 9) Protect the power cord from being walked on or pinched particularly at plugs, convenience receptacles, and the point where they exit from the apparatus.
- 10) Only use attachments/accessories specified by the manufacturer. Otherwise it may cause hazards.
- 11) Use only with the cart, stand, tripod, bracket, or table specified by the manufacturer, or sold with the apparatus. When a cart is used, use caution when moving the cart/apparatus combination to avoid injury from tip-over.
- 12) Unplug this apparatus during lightning storms or when unused for long periods of time. This will prevent damage to the receiver due to lightning and power-line surges.
- 13) Refer all servicing to qualified service personnel. Servicing is required when the apparatus has been damaged in any way, such as power-supply cord or plug is damaged, liquid has been spilled or objects have fallen into the apparatus, the apparatus has been exposed to rain or moisture, does not operate normally, or has been dropped.
Upon completion of any service or repairs to this LCD TV, ask the service technician to perform routine safety checks to determine that the television is in safe operating condition.
- 14) Operate only from the type of power source indicated on the marking label. If you are not sure of the type of power supplied to your home consult your television dealer or local power company.
- 15) Follow all warnings and instructions marked on the LCD TV.
- 16) Never push objects of any kind into this LCD TV through cabinet slots as they may touch dangerous voltage points or short out parts that could result in a fire or electric shock. Never spill liquid of any kind on the LCD TV.



Important Safety Instructions

17) If an outside antenna is connected to the television equipment, be sure the antenna system is grounded so as to provide some protection against voltage surges and built up static charges. In the U.S. Selection 810-21 of the National Electrical Code provides information with respect to proper grounding of the mast and supporting structure, grounding of the lead-in wire to an antenna discharge unit, size of grounding conductors, location of antenna discharge unit, connection to grounding electrodes, and requirements for the grounding electrode.

**EXAMPLE OF ANTENNA
GROUNDING AS PER (NEC)
NATIONAL ELECTRICAL
CODE**

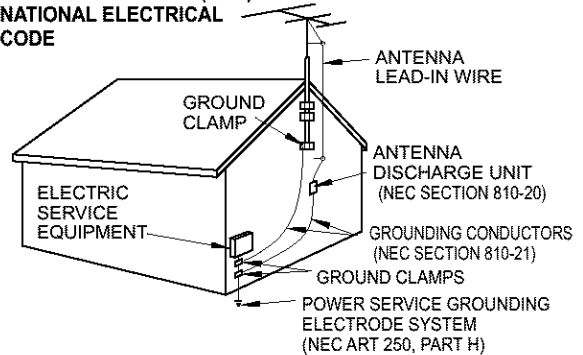

18) An outside antenna system should not be located in the vicinity of overhead power lines or other electric light or power circuits, or where it can fall into such power lines or circuits. When installing an outside antenna system extreme care should be taken to keep from touching such power lines or circuits as contact with them might be fatal.

19) Unplug this LCD TV from the wall outlet, and refer servicing to qualified service personnel under the following conditions:

- When the power cord or plug is damaged or frayed.
- If liquid has been spilled into the LCD TV.
- If the LCD TV has been exposed to rain or water.
- If the LCD TV does not operate normally by following the operating instructions.

Adjust only those controls that are covered by the operating instructions as improper adjustment of other controls may result in damage and will often require extensive work by a qualified technician to restore the LCD TV to normal operation.

e. If the LCD TV has been dropped or the cabinet has been damaged.

f. When the LCD TV exhibits a distinct change in performance - this indicates a need for service.

20) When replacement parts are required, be sure the service technician to use replacement parts specified by the manufacturer that have the same characteristics as the original part. Unauthorized substitutions may result in fire, electric shock, or other hazards.

21) **WARNING: TO REDUCE THE RISK OF FIRE OR ELECTRIC SHOCK, DO NOT EXPOSE THIS APPARATUS TO RAIN OR MOISTURE.**

22) **CAUTION: TO PREVENT ELECTRIC SHOCK DO NOT USE THIS PLUG WITH A RECEPTACLE OR OTHER OUTLET UNLESS THE BLADES CAN BE FULLY INSERTED TO PREVENT BLADE EXPOSURE.**

23) **CAUTION: USE WITH OTHER STAND MAY RESULT IN INSTABILITY CAUSING POSSIBLE INJURY.**

24) **CAUTION: DANGER OF EXPLOSION IF BATTERY IS INCORRECTLY REPLACED. REPLACE ONLY WITH THE SAME OR EQUIVALENT TYPE.**

NOTE: ● This equipment is designed to operate in the U.S.A. and other countries where the broadcasting system and AC house current is exactly the same as in the U.S.A.

- The marking or retained image on the LCD panel resulting from fixed image use is not an operating defect and as such is not covered by Warranty. This product is not designed to display fixed image patterns for extended periods of time.

■ Important Information Regarding Use of Video Games, Computers, Captions or Other Fixed Image Displays.

The extended use of fixed image program material can cause a permanent "shadow image" on the LCD panel. This background image is viewable on normal programs in the form of a stationary fixed image. This type of irreversible LCD panel deterioration can be limited by observing the following steps:

- Reduce the brightness/contrast setting to a minimum viewing level.
- Do not display the fixed image for extended periods of time.
- Turn the power off when not in actual use.

■ This product utilizes tin-lead solder, and has a fluorescent lamp containing a small amount of mercury. Disposal of these materials may be regulated in your community due to environmental considerations. For disposal or recycling information please contact your local authorities, or the Electronics Industries Alliance: www.eiae.org.

Dear Panasonic Customer

Welcome to the Panasonic family of customers.

We hope that you will have many years of enjoyment from your new LCD TV.

To obtain maximum benefit from your set, please read these instructions before making any adjustments, and retain them for future reference.

Retain your purchase receipt, and record the model number and serial number of your set in the space provided on the rear cover of these instructions.

For assistance, please call : 1-800-211-PANA (7262) or send e-mail to : consumerproducts@panasonic.com or visit us at www.panasonic.com (U.S.A)
For assistance, please call : 787-750-4300 or visit us at www.panasonic.com (Puerto Rico)
For assistance, please call : 1-800-561-5505 or visit us at www.panasonic.ca (Canada)

Federal Communication Commission Information
--

This equipment has been tested and found to comply with the limits for a TV Broadcast Receiver, pursuant to Part 15 of the FCC Rules. These limits are designed to provide reasonable protection against harmful interference in a residential installation. This equipment generates, uses and can radiate radio frequency energy and, if not installed and used in accordance with the instructions, may cause harmful interference to radio communications. If this equipment does cause or receive interference, which can be determined by turning equipment off and on, the user is encouraged to try to correct the interference by one of the following measures:

- Reorient or relocate the TV antenna.
- Increase the separation between TV and other equipment.
- Connect TV into separate outlet from other equipment.
- Consult the dealer or an experienced radio/TV technician for help.

FCC Caution: Any changes or modifications not expressly approved by the party responsible for compliance could void the user's authority to operate this equipment.

Table of Contents

Important Safety Instructions	2	3D Y/C FILTER / COLOR MATRIX	27
Table of Contents	5	ASPECT Controls	28
Installation	6		
SUPPLIED ACCESSORIES	6		
Remote control battery installation	7		
Maintenance	7		
Connections	8		
Connecting the Antenna Cable to the Antenna Terminal ...	8		
Antenna cover removal and fitting	8		
Antenna / Cable Connection	8		
How to connect the input terminals	10		
Cable cover removal and fitting	12		
Connecting Headphones / Earphones	12		
Power ON / OFF	13		
Connecting the Plug to the Wall Outlet	13		
How to Turn the Power On	13		
Playing a VCR or other peripheral equipment ...	14		
Basic Controls	15		
Flow Chart of MENU	16		
Tuning channels			
(Automatic channel programming)	18		
Tuning channels			
(Manual channel programming)	19		
Picture Adjustments	20		
Audio Adjustments	21		
Lock Feature	22		
Closed Captions	26		
Customizing the VIDEO INPUT labels	27		
		Manual de instrucciones [Resumen]	
		Preparación	29
		Instalación de las pilas del mando a distancia	29
		Conexión del cable de antena al terminal	
		de entrada de RF	30
		Conexión de antena / cable	30
		Para quitar y colocar la cubierta del cable	30
		Conexión de auriculares	30
		Conexión/desconexión de la alimentación ...	31
		Conexión de la clavija a la toma de corriente	31
		Cómo conectar la alimentación	31
		Reproducción en una videograbadora o en	
		otro equipo periférico	32
		Controles básicos	33
		Organigrama de menús de televisión	34
		Sintonización de canales	
		(Programación automática de canales)	36
		Sintonización de canales	
		(Programación manual de canales)	37
		Ajuste el soporte con el ángulo deseado ...	38
		Para quitar y colocar la cubierta de la antena ...	38
		Troubleshooting	39
		Specifications	40

Installation

Receiver Location

Locate for comfortable viewing. Avoid placing where sunlight or other bright light (including reflections) will fall on the screen. Use of some types of fluorescent lighting can reduce remote control transmitter range.

Adequate ventilation is essential to prevent internal component failure. Keep away from areas of excessive heat or moisture.

Optional External Equipment

The Video/Audio connection between components can be made with shielded video and audio cables. For best performance, Antenna cables should utilize 75 ohm coaxial shielded wire. Cables are available from your dealer or electronic supply store.

Before you purchase any cables, be sure you know what type of output and input connectors your various components require. Also determine the length of cable you'll need.

For optimum quality picture

When the LCD is exposed to light from outdoors or lighting fixtures, high-contrast pictures may not be displayed clearly. Turn off florescent lamps near the LCD and place in a location not exposed to outdoor light.

How to use the LCD stand

Adjust the stand to your desired angle. The stand angle can be adjusted between 5 ° forward to 15 ° back.

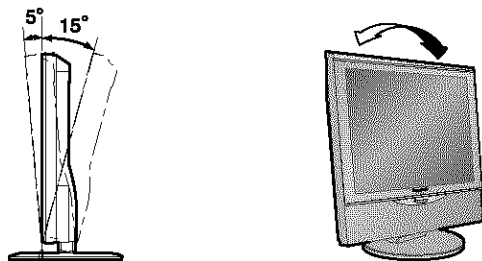

SUPPLIED ACCESSORIES

Check the accessories before installations.

- Operating Instruction book

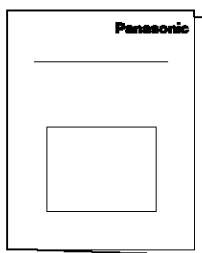

- Remote Control Transmitter



- Batteries for the Remote Control Transmitter (2 × AA size)

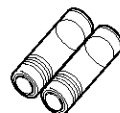

- Tuner Cable Cover

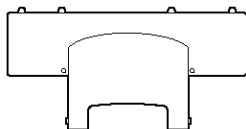

- AC Adaptor & AC Cord

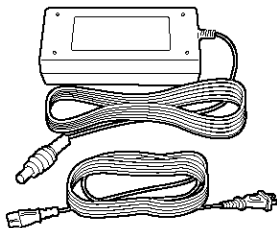

- Warranty Card

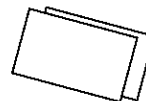

- Service Center List



- Customer Card



[The illustration shows only a basic view; actual appearance may differ.]

Remote control battery installation

Replacing batteries

Replace batteries by following the steps below:

Requires two AA batteries.

1. Open the battery cover.
2. Install the batteries as shown in the battery compartment. (Polarity + or – must match the markings in the compartment).
3. Replace the cover.

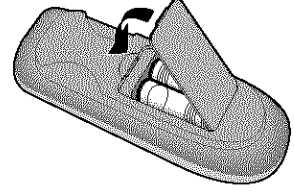
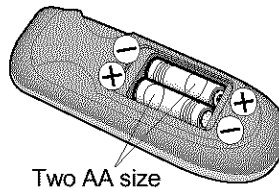
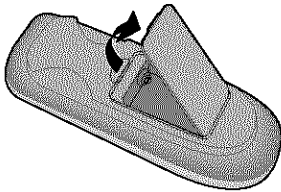

⚠ Precaution on battery use

Incorrect installation can cause battery leakage and corrosion that will damage the remote control transmitter.

Observe the following precautions:

1. Always use new batteries when replacing the old set.
2. Do not attempt to charge, short-circuit, disassemble, heat or burn used batteries.
3. Battery replacement is necessary when remote control acts sporadically or stops operating this unit.

Notes:

- Do not drop, apply shock to or step on the remote control.
- Do not spill water on the remote control.
- Do not place objects between the remote control and remote control receiver.
- Do not use remote controls for other equipment at the same time.
- If the TV does not operate even when operating the remote control from a close range, it is time to replace the batteries.

Refer to the label on back of the remote control for directions on replacing batteries.

Maintenance

To clean this unit, wipe with a soft, dry cloth.

If the surfaces are extremely dirty, use a soft cloth dipped in a soap and water solution or a weak detergent solution.

- Use eyeglass cleaner to remove stubborn dirt from the LCD.
- Never use alcohol, paint thinner or benzine to clean this unit.
- Before using a chemically treated cloth, read the instructions that came with the cloth carefully.

CAUTION :

If water or similar substances get inside the monitor via the liquid crystal panel surface, a malfunction may result.

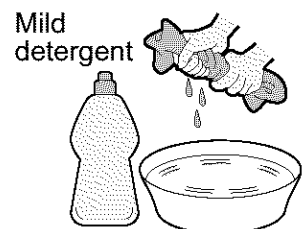

Connections

Connecting the Antenna Cable to the Antenna Terminal

Antenna Connection - For proper reception of VHF/UHF channels, an external antenna is required. For best reception an outdoor antenna is recommended. Antenna Mode must be set to TV.

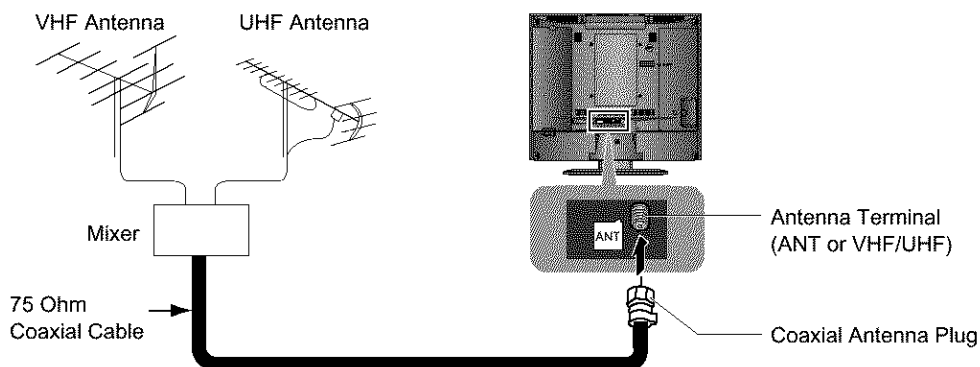

Antenna cover removal and fitting

TC-14LA1/TC-17LA1

Removal

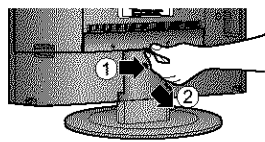

1. Grasp the cover at the bottom end and initially remove by pulling slightly toward yourself.
2. Slowly pull out in the downward direction.

Fitting

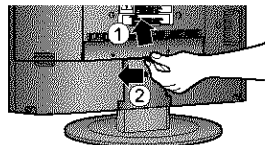

1. Insert the claws (at 4 points) at the top end.
2. Push the claws in (at 4 points) at the bottom end.

TC-20LA1

Removal

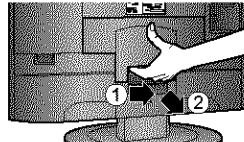

1. Grasp the opening and initially pull the cover slightly towards yourself to disengage the claws (at 2 points on both the left and right).
2. Slowly pull out in the downward direction.

Fitting

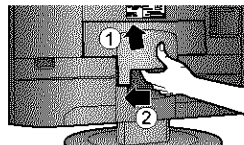

1. Insert the claws (at 4 points) at the top end.
2. Push the claws in (at 4 points) at the bottom end.

Note: To avoid interference appearing on the screen, do not bundle the antenna wire and AC adapter wire together.

Antenna / Cable Connection

Incoming 75 Ohm Cable from Home Antenna / Cable Company

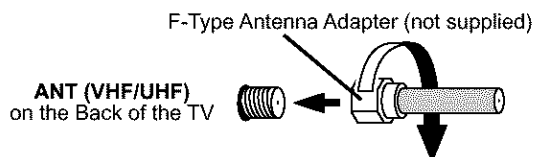

Cable Connection - For reception of cable channels (01 - 125) connect the cable supplied by your local cable company. Antenna Mode must be set to CABLE. (Refer to Antenna Mode section.)

Note:

Certain cable systems offset some channels to reduce interference or have Premium (scrambled) channels. A cable converter box is required for proper reception. Check with your local Cable company for its compatibility requirements.

Antenna Connection (Cable Box, no VCR)

Use this configuration when connecting the TV to a cable TV system using a Cable Box.

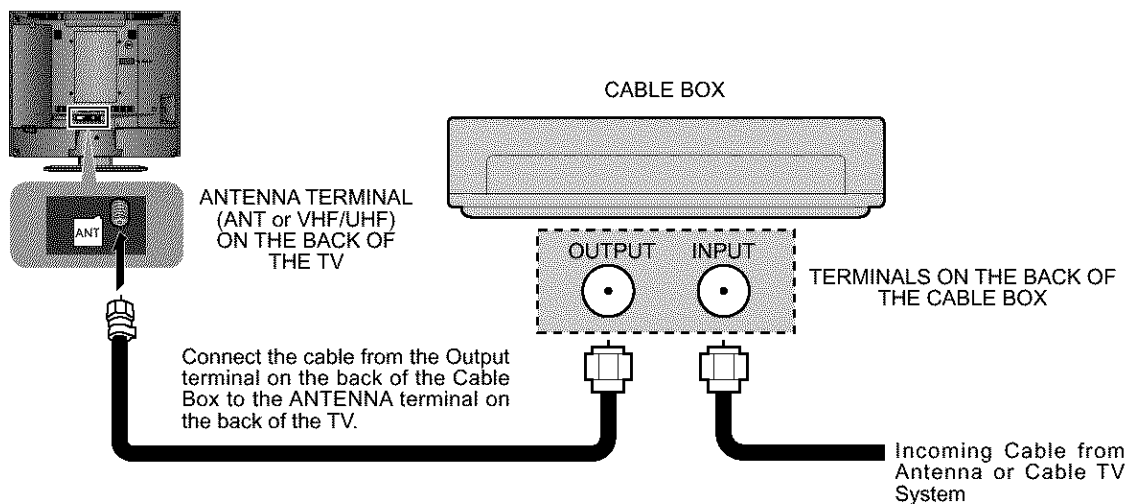

Antenna Connection (Cable Box, and VCR)

Use this configuration when connecting the TV to a cable TV system using a Cable Box and VCR.

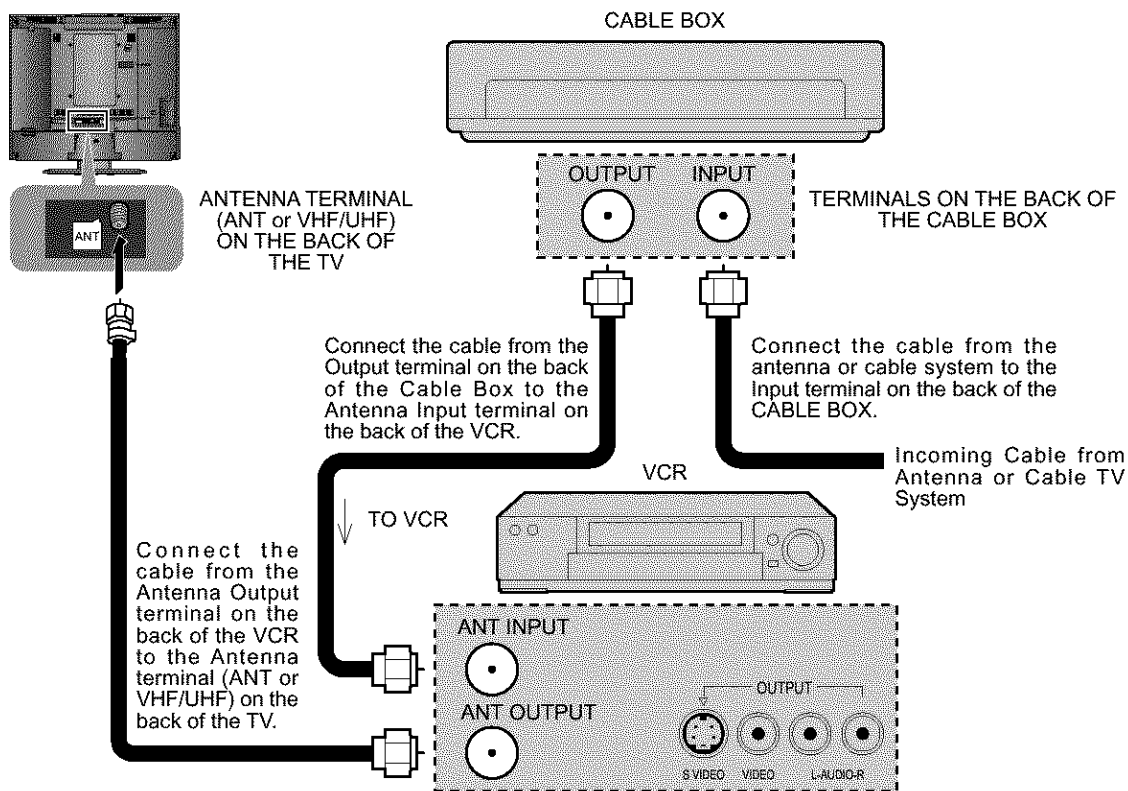

Note: When the antenna cable is connected to the TV antenna terminal via a cable box or VCR, set the TV channel to CH3 or CH4, cable. This does not apply when signal is input from VIDEO INPUT.

How to connect the input terminals

Connect VCR and other peripheral equipment

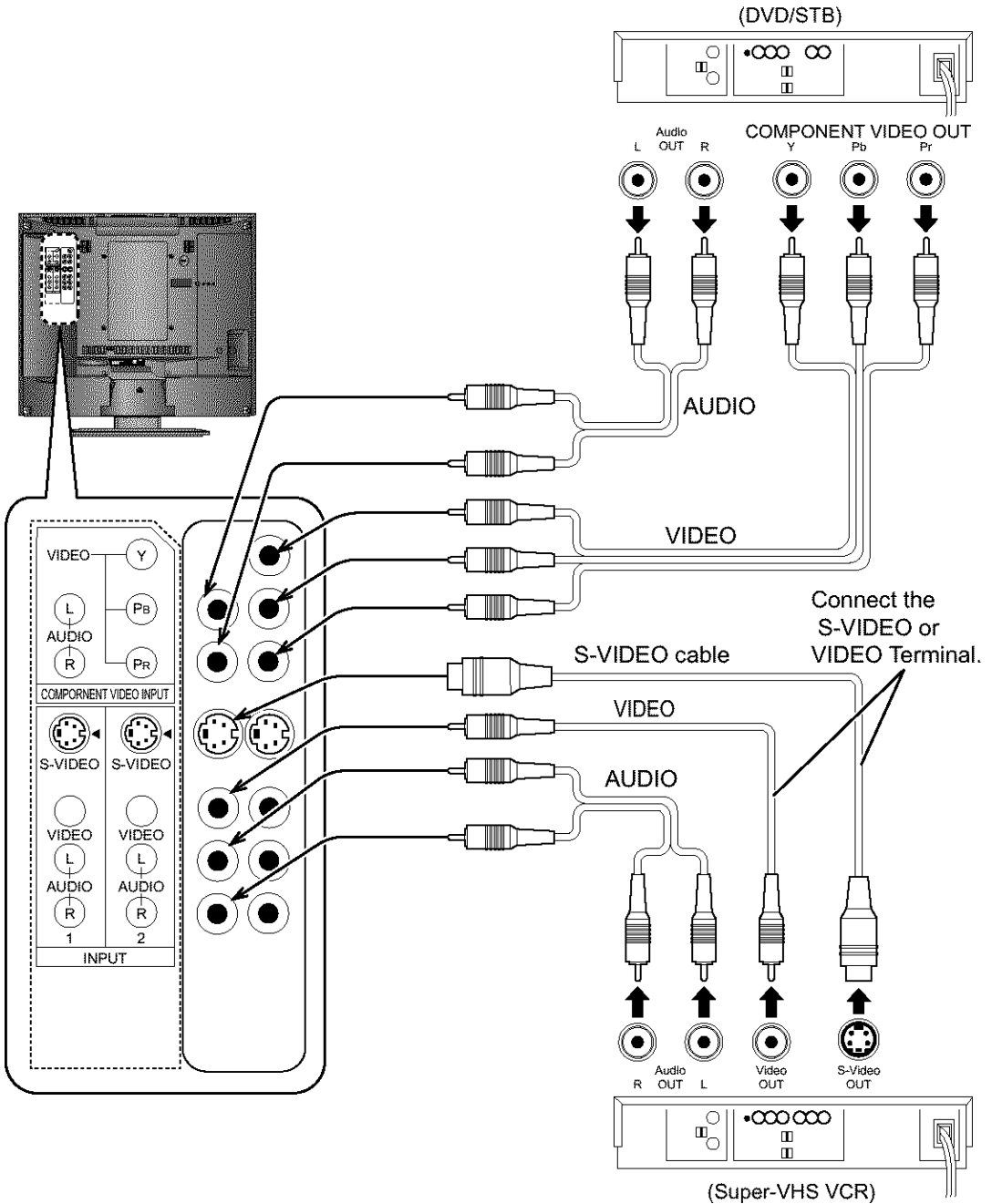

Notes:

- (1) When a monaural VCR is used, connect the monaural audio cable to the AUDIO-L (Left) terminal.
- (2) Similar connections are available at the INPUT terminals.
Select the desired VIDEO input position by pushing the TV/VIDEO button. (See page 14)
- (3) When connecting VCRs, priority is given to the S- Video cable when the S- Video input terminal and the video input terminal are connected at the same time.

Connect CAMCORDER and VIDEO GAME CONSOLE

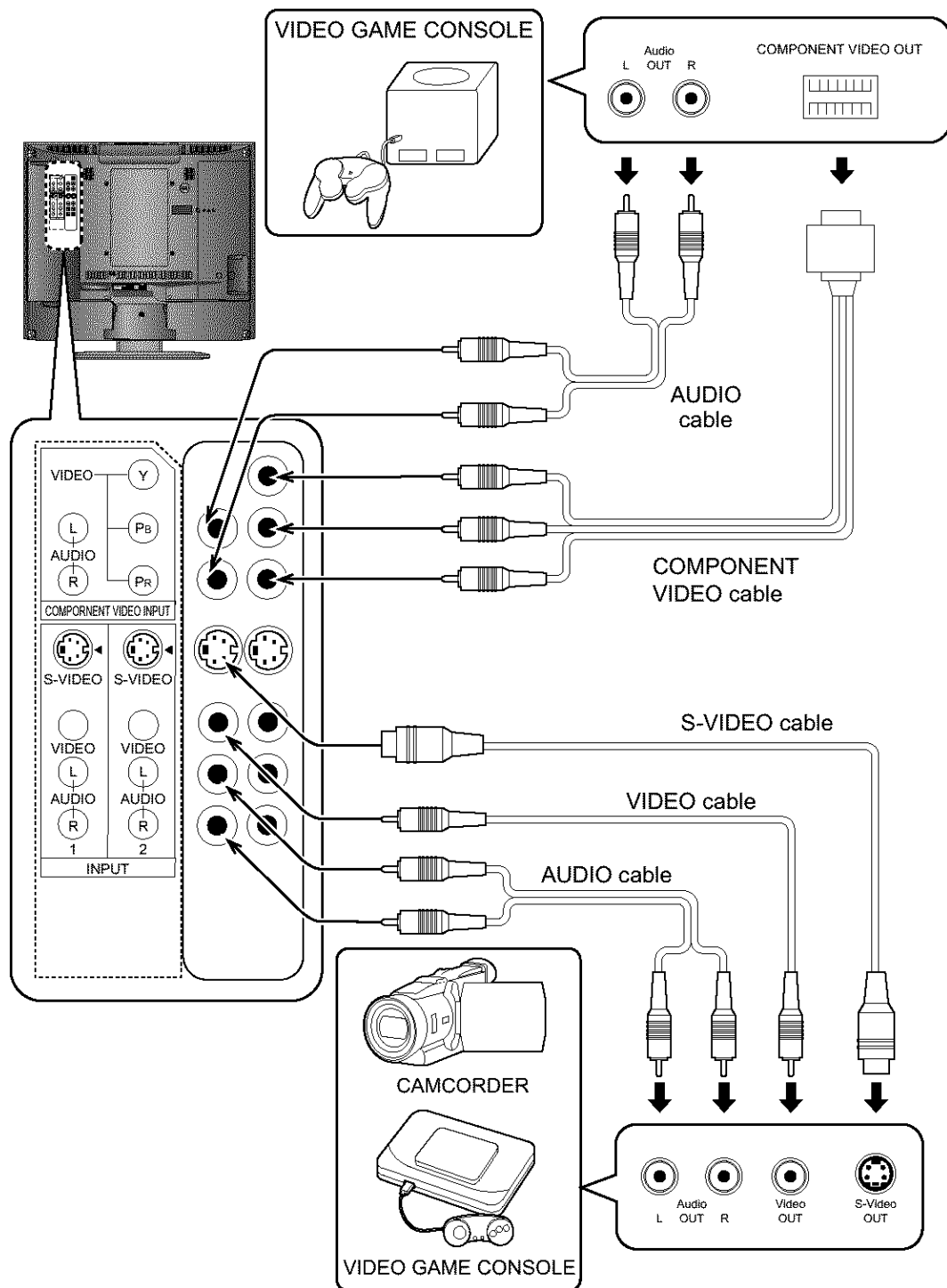

Notes:

- When connecting video cables, priority is given to the S-Video cable when the S-Video input terminal and the video input terminal are connected at the same time.
- Please make inquiries to the VIDEO GAME PLAYER manufacture concerning component cables to connect with video games.

Cable cover removal and fitting

Removal



1. Disengage the claws at the uppermost end.
2. Slowly pull out in the upward direction.

Fitting

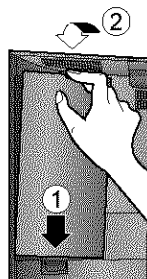



1. Insert the claws (at 2 points) at the bottom.
2. Push in the TOP.

Note: Depending on the type of cable used it may not be possible to close the cover. In such cases the cable may be routed through the antenna cover.

Connecting Headphones / Earphones

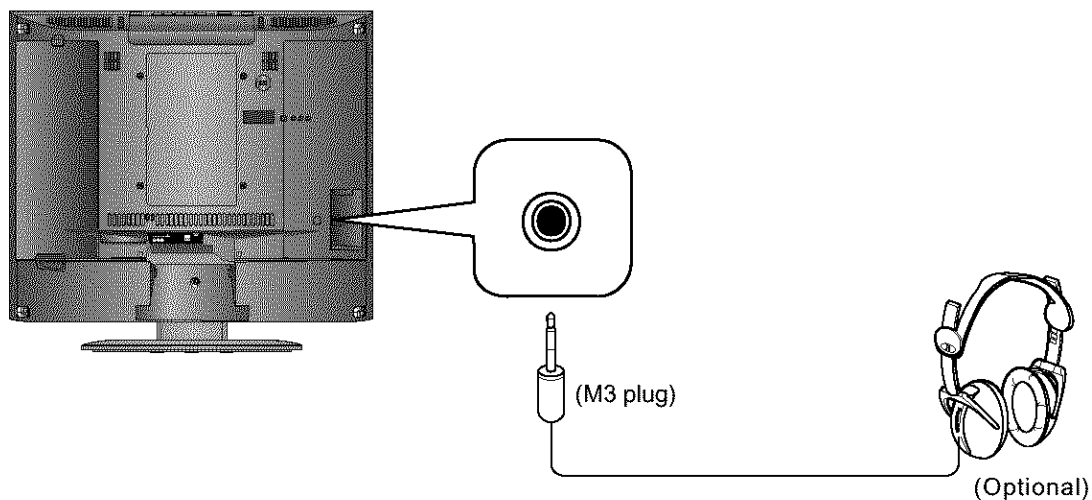
Connect headphones / earphones as follows.



Use Volume Up  or Down  button to control volume level. (See page 15)

Power ON / OFF

Connecting the Plug to the Wall Outlet

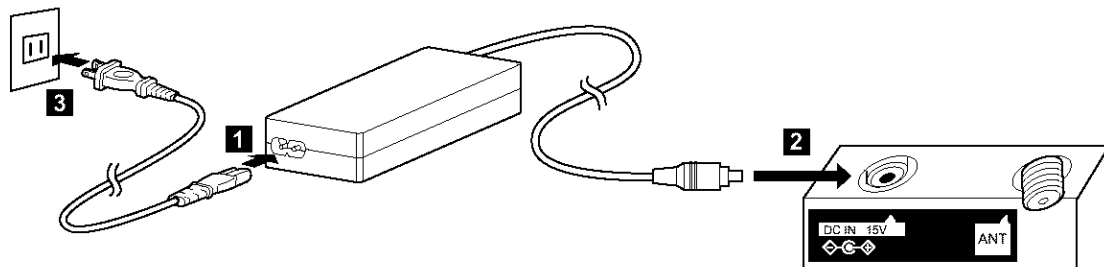

Note:

- The TV and AC adaptor will still consume some power as long as the power cord is still inserted into the wall outlet.
- Be sure to use the power cord and AC adaptor included in the accessories.
- Usage of AC adapters other than specified may cause malfunctions.

How to Turn the Power On

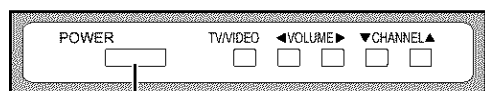

Main Power switch

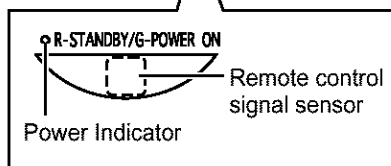
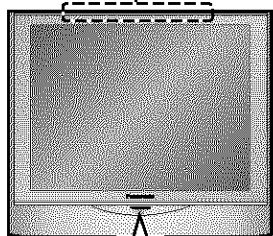

Power Indicator

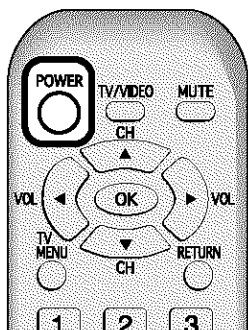

Press the Main POWER switch on the TV to turn the set on.
POWER-ON: Green

When the set is on or in standby mode press the Main POWER switch on the TV to turn the set off.
POWER-OFF: No light

Example: The screen below is displayed for a while after the TV is turned on. (setting condition is an example.)

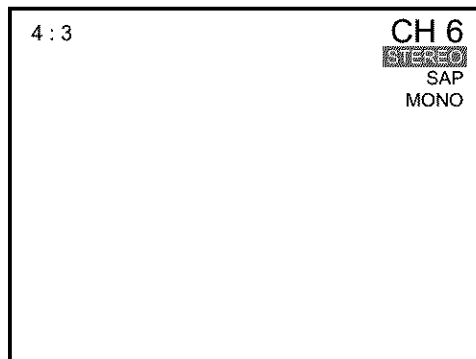

POWER



Press the POWER button on the remote control to turn the TV off: Red (standby)

Press the POWER button on the remote control to turn the TV on: Green

Playing a VCR or other peripheral equipment

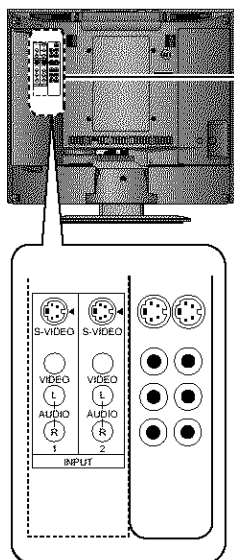

Confirming connections

Confirm that the TV is in standby mode.

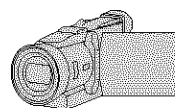
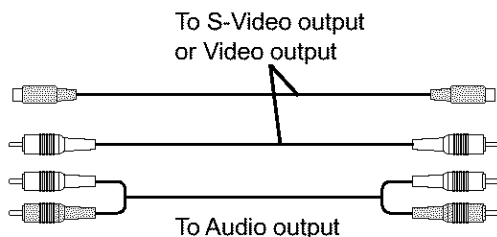

Camcorder

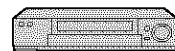

VCR



Laser Disc Player

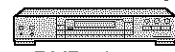

DVD player

This equipment can also be connected to the rear terminals. (See page 10,11)

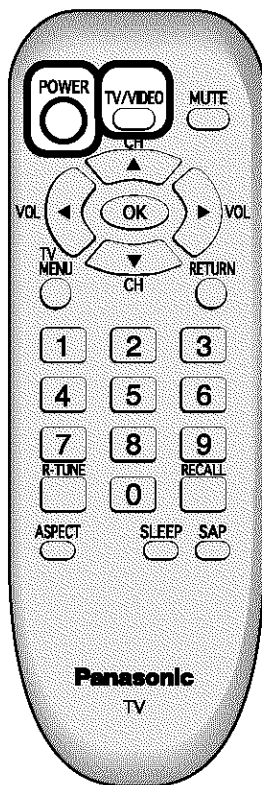

Turning the power on and switching input modes

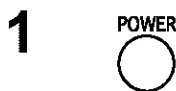

Turn the TV on.



The input mode changes each time this button is pressed.

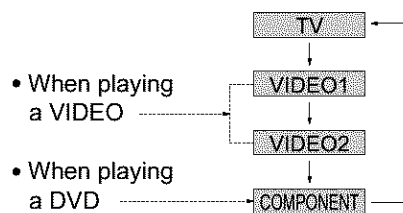

Note:

When the remote control is unavailable, input modes can also be switched using the TV/VIDEO button on the TV set.



Basic Controls

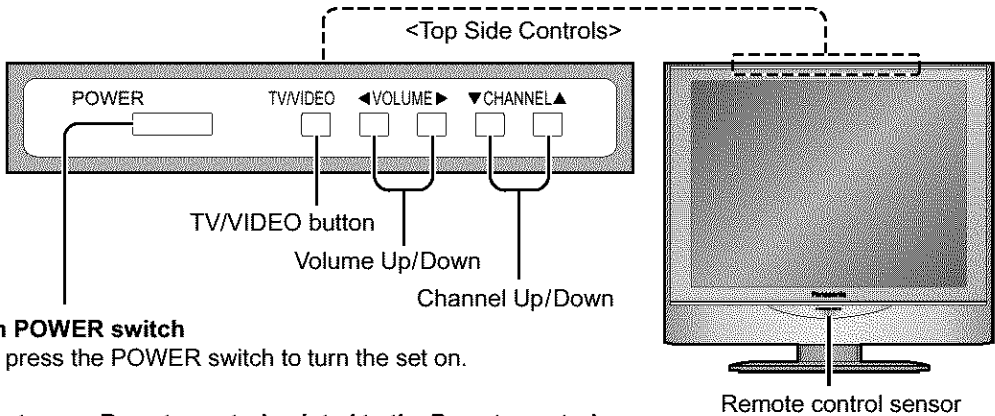

Main POWER switch

First press the POWER switch to turn the set on.

Operate your Remote control pointed to the Remote control sensor (Within about 6 meters in front of the TV set.)

Power button

Press to turn this set ON or OFF. (See page 13)

Note:

The LCD TV's power cord must first be plugged into the wall outlet and then turned on at the Main POWER switch.

Changes to the next channel up
Moves cursor upward during menu mode.

Reduces volume
Moves cursor to the left during menu mode.

Increases volume
Moves cursor to the right during menu mode.

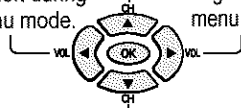

Changes to the next channel down
Moves cursor downward during menu mode.

MENU button

Press to display MENU screen, press again to clear.



Direct program number Selection buttons

R-TUNE button

Switches to previously viewed channel or video mode.

ASPECT button

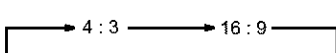

TV/VIDEO button

The input mode changes each time this button is pressed.

MUTE button

Press to mute the sound. Press again to reactivate sound. Sound is also reactivated when power is turned off or volume level is changed.

RETURN button

Press to return to the previous screen.

RECALL button

Press to display time, channel, sleep timer and other options.

SAP button

Selects Audio mode (See page 21).



SLEEP button

The LCD TV may be preset to switch to stand-by after a fixed period. The setting changes to 30 minutes, 60 minutes, 90 minutes and 0 minutes (SLEEP timer cancelled) each time this button is pressed.

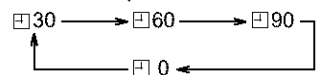

When 3 minutes remain, "3" will flash. The SLEEP timer is cancelled if a power interruption occurs. Before the timer automatically turns the power off, the remaining time will blink on the screen ("3" for 3 minutes, "2" for 2 minutes and "1" for 1 minute before the power goes off).

Flow Chart of MENU

All adjustments and setting functions equipped in this set can be made using the menu buttons. The menu screen is composed of 2 menus, the ADJUST menu and the SET UP menu.

1

Press to display MENU screen, press again to clear.

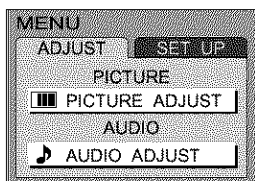

2

MENU selection

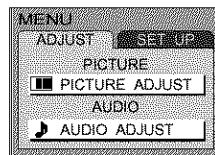

OR

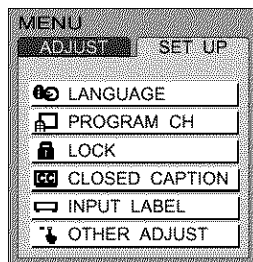
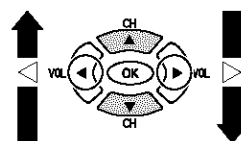
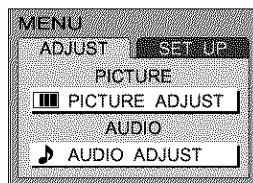
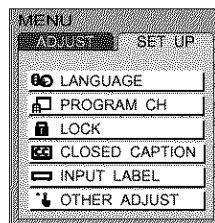

Please refer to the On Screen Help

An On Screen Help box is displayed whenever a menu is displayed on the TV. This Help box indicates which keys on the remote control are used to navigate the menu shown, see above for descriptions of button functions.

ON SCREEN HELP
'Instruction' box

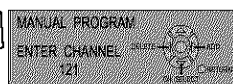

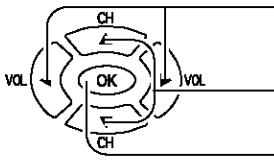

Press to select the desired MENU (ADJUST or SET UP).

Press to select each item.

Press to display each adjustment screen.



Proceed to the adjustment.

- To return to previous screen :

RETURN



Press to return.

- To end adjustments :



Press to exit from the MENU screen.

This returns the set to the normal viewing condition.

Press to display each adjustment screen.

OK

RETURN



Press the RETURN button to return to previous screen.

TO PICTURE ADJUST menu

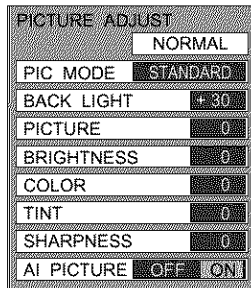

(See page 20)

TO AUDIO ADJUST menu

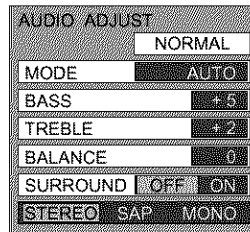

(See page 21)

TO LOCK selection screen

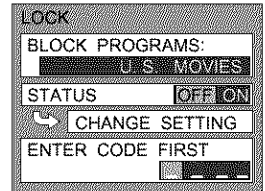

(See page 22 - 25)

Press to display each adjustment screen.

OK

RETURN



Press the RETURN button to return to previous screen.

TO LANGUAGE

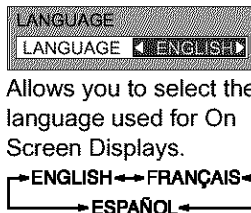

Allows you to select the language used for On Screen Displays.

TO CLOSED CAPTION

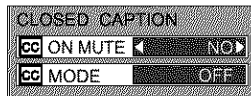

(See page 26)

TO PROGRAM CHANNELS

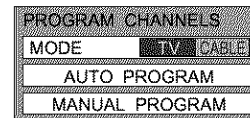

(See page 18,19)

TO INPUT LABEL selection screen

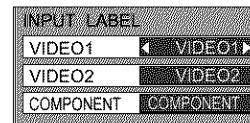

(See page 27)

TO OTHER ADJUST screen

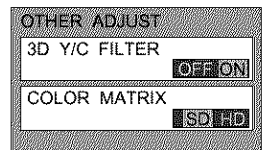

[for TC-17LA1 and TC-20LA1]

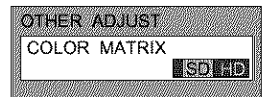

[for TC-14LA1]

(See page 27)

Tuning channels (Automatic channel programming)

Automatically scans all TV channels and stores them in memory.

1 Turn the Power on and press the TV/VIDEO button to display the TV channel.

2 Press the MENU button to display the MENU screen and select SET UP.

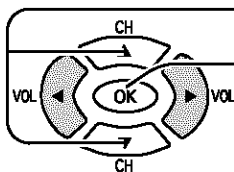

Press to select PROGRAM CH.

Press to display the PROGRAM CHANNELS screen.

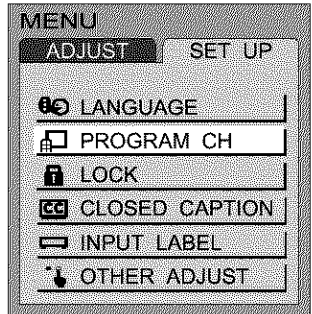

3 Press to select MODE.

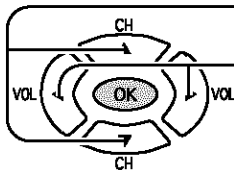

Press to select TV or CABLE.

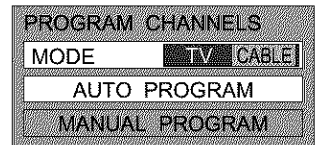

4 Press to select AUTO PROGRAM.

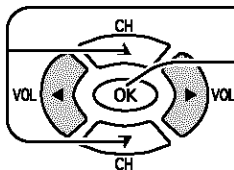

Press to display the confirmation screen.

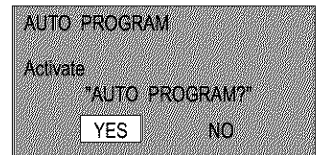

5 Press to select YES.

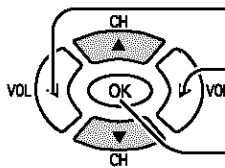

Press to select NO.

If YES selection press to run AUTO PROGRAM.

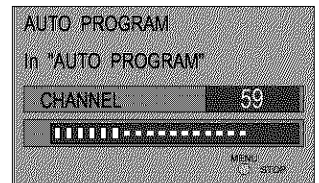

Channels will automatically advance until all channels have been scanned. Channel numbers with a video signal present will be stored in the Channel Scan Memory.



Press to exit from the MENU screen.

This returns the set to the normal viewing condition.

Notes:

- When buttons are pressed with AUTO PROGRAM running, the TV set will return to normal viewing. (Channels searched up to this point are added.)
- After AUTO PROGRAM is finished, the lowest channel number added will be received.
- When there are no receivable channels, channel 69 is displayed for TV and channel 125 is displayed for cable TV.

Tuning channels (Manual channel programming)

Use this setting when changing setting of receiving channels or changing the channel display.

Turn the TV on and select the broadcast channel. Follow the steps on the previous page to display the PROGRAM CHANNELS screen.

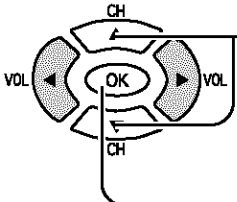
- 1**
- 
- Press to select MANUAL PROGRAM.
- Press to display the MANUAL PROGRAM screen.

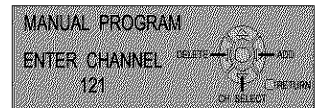
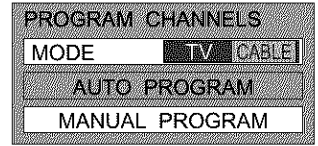

Adding or deleting channels

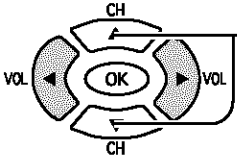
- 2**
- 
- Press to select channel (or number keys).

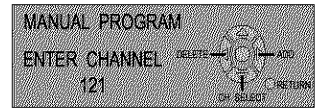

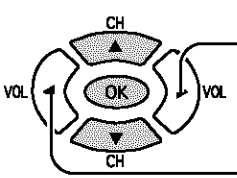
- 3**
- 
- Press to add channels to memory (Channel number turns blue).
- Press to delete channels from memory (Channel number turns yellow).

- 4** Repeat steps 2 and 3 to continue adding or deleting channels.



Press to exit from the MENU screen.
This returns the set to the normal viewing condition.

Picture Adjustments

- 1** Press the MENU button to display the MENU screen and select ADJUST.

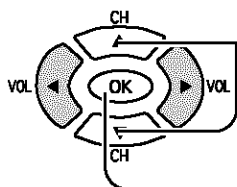

Press to select PICTURE ADJUST.

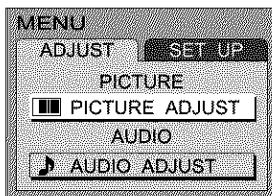

Press to display the PICTURE ADJUST screen.

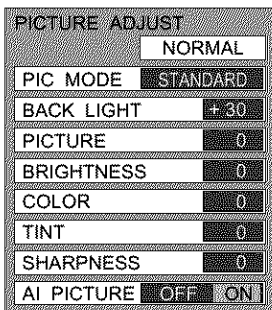

- 2**

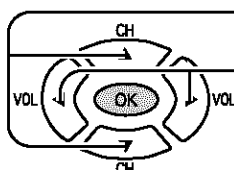

Press to select the menu to adjust.

Select the desired level by looking at the picture behind the menu.

NORMAL is displayed at default.

PIC MODE

PICTURE MODE is stored for TV, VIDEO1, VIDEO2 and COMPONENT individually.

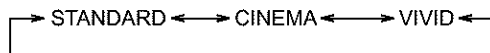

MODE	Function
STANDARD	Displays standard image.
CINEMA	Ideal for watching movies in a dark room.
VIVID	Displays a clear screen with contrast of light and dark.

BACK LIGHT, PICTURE, BRIGHTNESS, COLOR, TINT, SHARPNESS, AI PICTURE

You can change the level of each Item (BACK LIGHT, PICTURE, BRIGHTNESS, COLOR, TINT, SHARPNESS and AI PICTURE) for each MENU (STANDARD, CINEMA, and VIVID) according to your personal preference.

Item	Function
BACK LIGHT	Luminance of the back light is adjusted.
PICTURE	Selects proper brightness and density for the room.
BRIGHTNESS	Adjusts for easier viewing of dark pictures such as night scenes.
COLOR	Adjusts the level of color.
TINT	Adjusts for flesh tone color.
SHARPNESS	Adjusts the degree of sharpness.
AI PICTURE	Displays black and white colors more clearly when turned ON.

- To reset to standard setting :

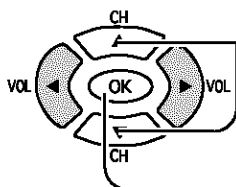

Press to Select NORMALIZE.

Press OK.

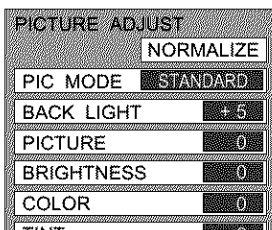

Audio Adjustments

1 Press the MENU button to display the MENU screen and select ADJUST.

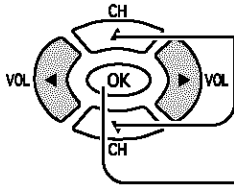

Press to select AUDIO ADJUST.

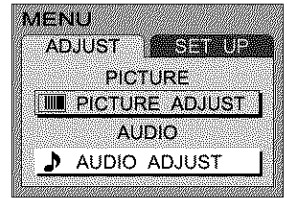

Press to display the AUDIO ADJUST screen.

2

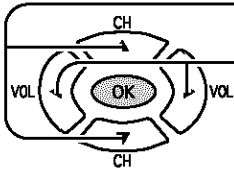

Press to select the menu to adjust.

Select the desired level by listening to the sound.

NORMAL is displayed at default.

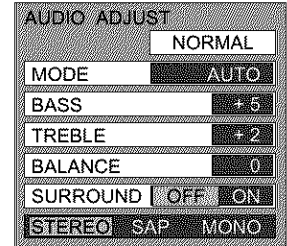

MODE

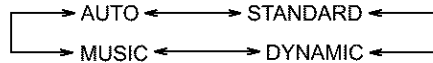

MODE	Function
AUTO	Automatically adjusts quiet sound and loud sound for ease of listening.
STANDARD	Emits the original sound.
DYNAMIC	Gives contrast to sound.
MUSIC	For programs consisting mainly of music. Enhances high sounds (around 4 kHz).

BASS, TREBLE, BALANCE, SURROUND

You can change the level of each Item (BASS, TREBLE, BALANCE and SURROUND) for each MODE (AUTO, STANDARD, DYNAMIC and MUSIC) according to your personal preference.

Item	Function
BASS	Adjusts low sounds
TREBLE	Adjusts high sounds
BALANCE	Adjust left and right volume
SURROUND	To enjoy a concert hall effect, turn SURROUND to ON when stereo is playing.

Selecting STEREO/SAP/MONO

STEREO ↔ SAP ↔ MONO

Note:

Red display : With signal
 White display : No signal
 White display : MONO

MODE	Function
STEREO	Two channel Audio reception.
SAP	Second Audio Programming (typically used for bilingual audio).
MONO	Use when stereo signal is weak.

● To reset to standard setting : See previous page.

Lock Feature

In the United States, the V-CHIP consists of two rating systems, which are MPAA (MOTION PICTURE) and TV PARENTAL GUIDELINES. Its function is to block programs by the rating data in the XDS data packets sent from broadcasting stations. The user can select which rating programs should be blocked by the LOCK MENU options.

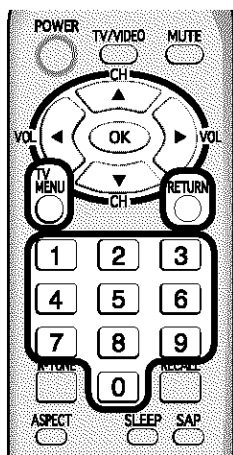

Press the MENU button to display the MENU screen and select SET UP.

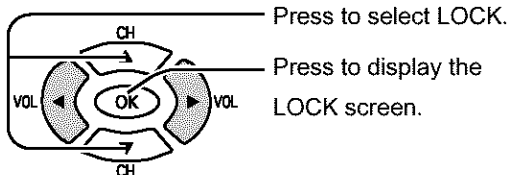

Input code

Enter any 4-digit number as a password. These numbers will be needed when deactivating the LOCK function.

While entering a code, by pressing the up or down buttons you can input a new code again.

After entering your secret code for the first time, the onscreen display will change to CHANGE CODE. And you can change the Input code.

Note: Use a code that is easy to remember and record it in a safe place.

1 Selecting broadcasts to lock.

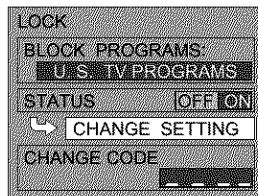
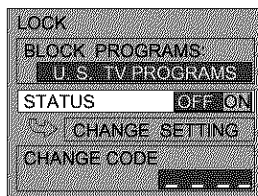
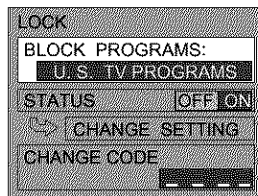
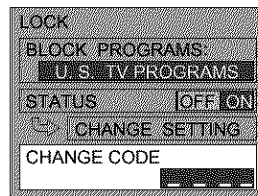
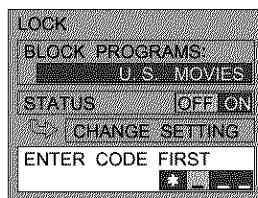
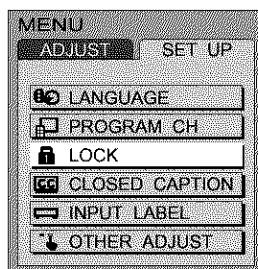
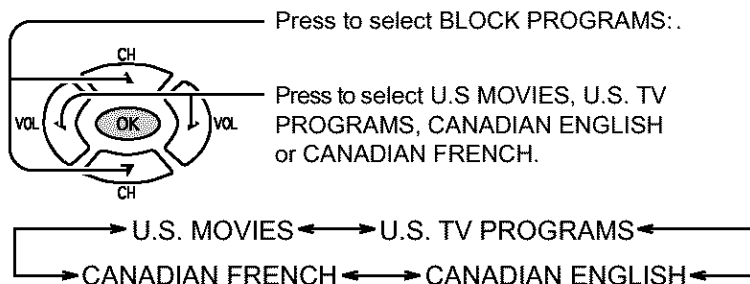

2 Press to select STATUS.

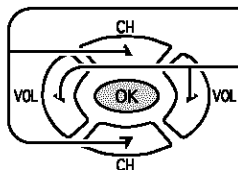

3 Press to select CHANGE SETTING.

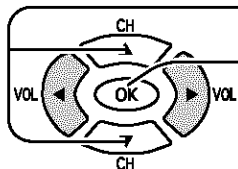

for U.S.TV PROGRAM to lock

1

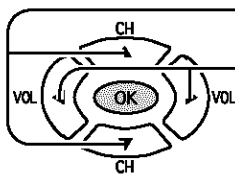

Press to select VIEW NR PROGRAMS?.

Press to select NO or YES.

NO : Cannot view programs with NR signals.
YES : Can view programs with NR signal.

2

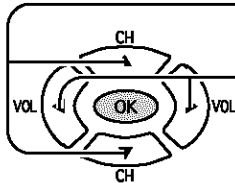

Press to select SETTING.

Press to select BASIC or DETAILED.

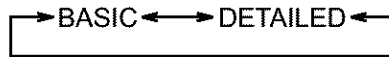

3

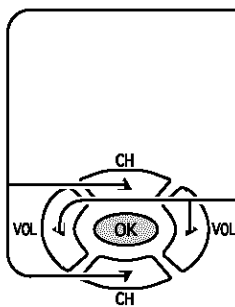

Press to select rating.

BASIC : Change the selected title.
DETAILED : The cursor selecting the title can be moved to select options displayed on the right.

Press to lock or unlock the rating.

Lock : Red
Unlock : Green

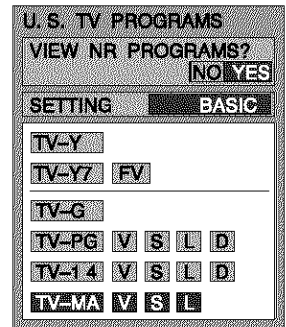
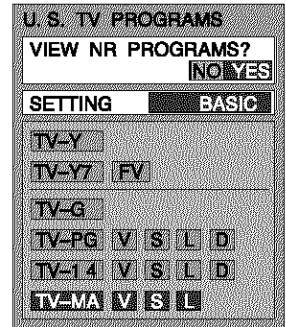

Locking and unlocking

- When a title field is selected, all ratings below this rating are selected.
 - When options within an option field are selected, ratings below this rating within the same field are selected.
 - Ratings displayed in green are unlocked and those displayed in red are blocked programs.
1. Ratings for children: These ratings are divided into ranks as follows.

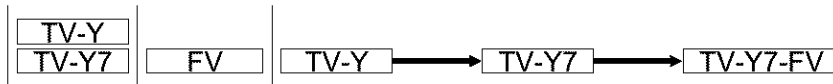

2. Ratings for teenagers: These ratings can be created out of these major categories to form various combinations. These combinations are described in the below diagram. Ratings for all ages are on top and ratings for adults are on the bottom.

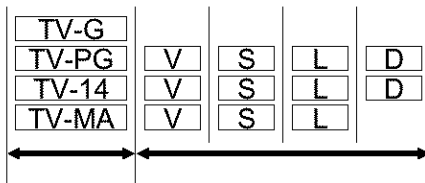

- To return to previous screen :

RETURN Press to return.

- To end adjustments :

TV MENU Press to exit from the MENU screen.
This returns the set to the normal viewing condition.

Lock Feature

for U.S.MOVIES to lock

1

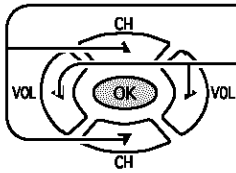

Press to select VIEW NR PROGRAMS?.

Press to select NO or YES.

NO : Cannot view programs with NR signals.
YES : Can view programs with NR signal.

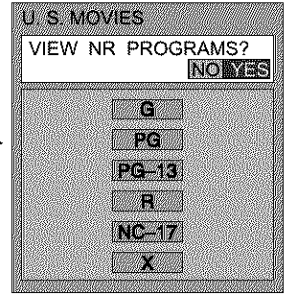

2

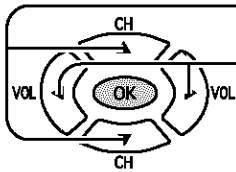

Press to select rating.

Press to lock or unlock the rating.

Lock: Red
Unlock : Green

Rating

G : General audience
PG : Parental guidance suggested
PG-13 : Parental guidance needed
under 13 years old
R : Restricted
NC17 : No one under 17 is admitted
X : Pornography

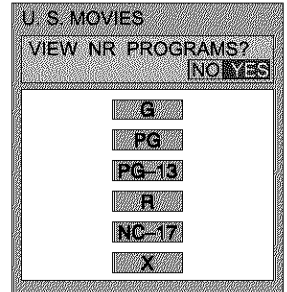

for CANADIAN ENGLISH / CANADIAN FRENCH to lock

1

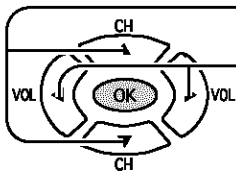

Press to select VIEW E PROGRAMS?.

Press to select NO or YES.

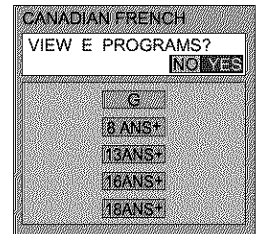
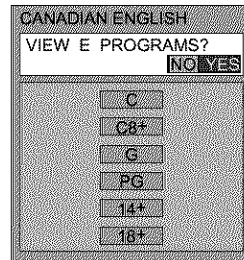

2

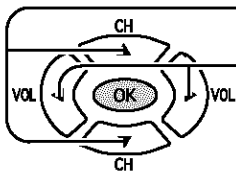

Press to select rating.

Press to lock or unlock the rating.

Lock: Red
Unlock : Green

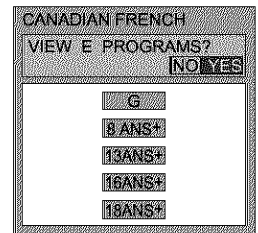
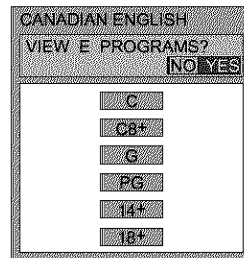



CANADIAN ENGLISH RATINGS CHART

E	Exempt - Exempt programming includes: news, sports, documentaries and other information programming, talk shows, music videos, and variety programming.
C	Programming intended for children under age 8. No offensive language, nudity or sexual content.
C8+	Programming generally considered acceptable for children 8 years and over. No profanity, nudity or sexual content.
G	General programming, suitable for all audiences.
PG	Parental Guidance suggested. Some material may not be suitable for children.
14+	Programming contains themes or content which may not be suitable for viewers under the age of 14. Parents are strongly cautioned to exercise discretion in permitting viewing by pre-teens and early teens.
18+	General programming, suitable for all audiences.

CANADIAN FRENCH RATINGS CHART

E	Exempt - Exempt programming.
G	General - Programming intended for audience of all ages. Contains no violence, or the violence content is minimal or is depicted appropriately.
8 ANS+	8+ General - Not recommended for young children. Programming intended for a broad audience but contains light or occasional violence. Adult supervision recommended.
13ANS+	Programming may not be suitable for children under the age of 13 - Contains either a few violent scenes or one or more sufficiently violent scenes to affect them. Adult supervision strongly suggested.
16ANS+	Programming may not be suitable for children under the age of 16 - Contains frequent scenes of violence or intense violence.
18ANS+	18+ ans Programming restricted to adults. Contains constant violence or scenes of extreme violence.

- To return to previous screen :  Press to return.
- To end adjustments :  Press to exit from the MENU screen.
This returns the set to the normal viewing condition.

Closed Captions

This unit has a built in decoder that provides a visual depiction of the audio portion of a television program in the form of written words across the screen (white or colored letters on a black background). It allows the viewer to read the dialogue of a television program or other information.

1 Press the MENU button to display the MENU screen and select SET UP.

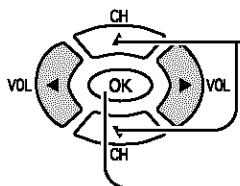

Press to select CLOSED CAPTION.

Press to display the CLOSED CAPTION screen.

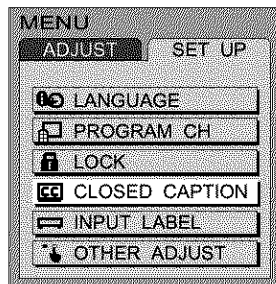

2 CC ON MUTE

Activates the On-Screen Closed Caption feature, when the MUTE button on the Remote Control is pressed. To deactivate, press the MUTE button again.

Note:

This feature functions when the Closed Caption Mode is in the "OFF" position. The program being viewed must be broadcast with Closed Caption.

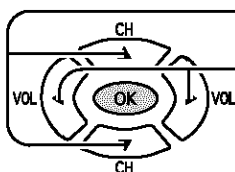

Press to select **CC ON MUTE**.

Press to select from the following:

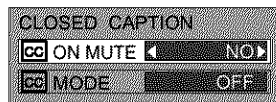
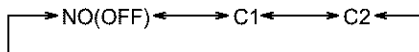

3 CC MODE

Activates the On-Screen Closed Caption feature. When activated this feature will remain on until OFF is selected in this menu.

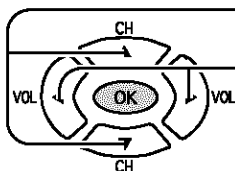

Press to select **CC MODE**.

Press to select from the following:

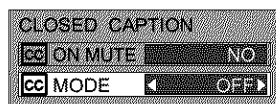
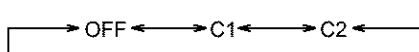

- **CAPTION OFF** - Recommended mode when Closed Caption is not being used.
- **CAPTION C1** - For video related information that can be displayed (up to 4 lines of script strategically placed on the television screen so that it does not obstruct relevant parts of the picture).
- **CAPTION C2** - Another mode used for video related information.

- To return to previous screen :

RETURN



Press to return.

- To end adjustments :

TV MENU



Press to exit from the MENU screen.

This returns the set to the normal viewing condition.

Customizing the VIDEO INPUT labels

Display for each VIDEO INPUT can be changed to match with the connected device (VCR, DVD Player etc.).

1 Press the MENU button to display the MENU screen and select SET UP.

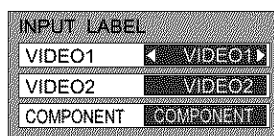
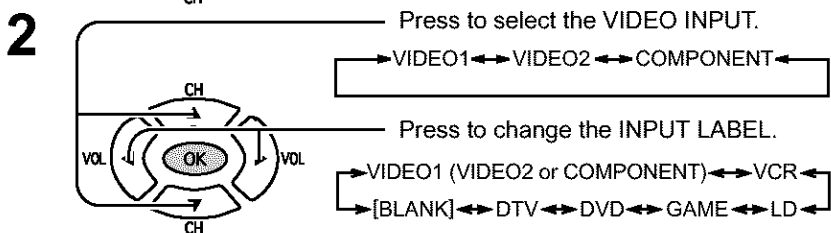
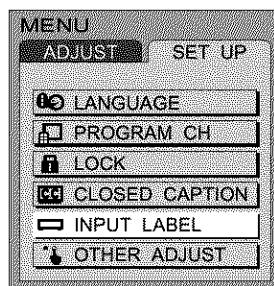
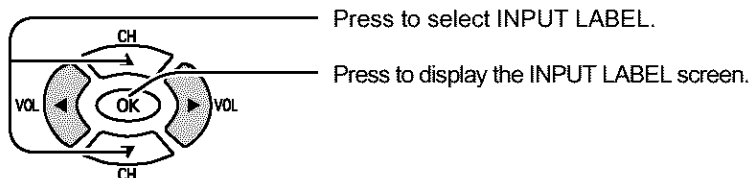

3D Y/C FILTER / COLOR MATRIX

1 Press the MENU button to display the MENU screen and select SET UP.

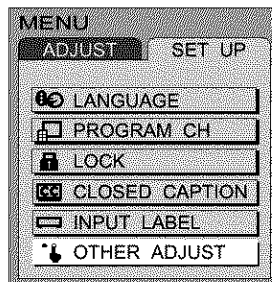
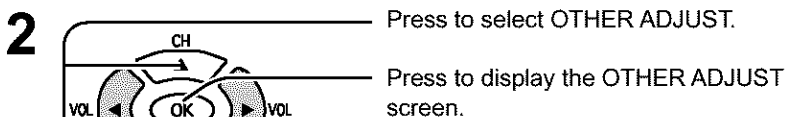

3 Press to select 3D Y/C FILTER / COLOR MATRIX.

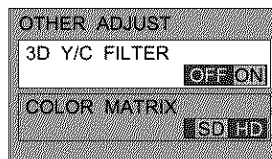
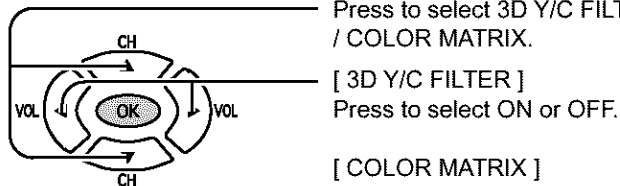

SD : When the input signal is a normal TV system (NTSC).

HD : When the input signal is a High-Definition system (ATSC).

[for TC-17LA1 and TC-20LA1]

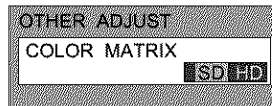

[for TC-14LA1]

Note: ●3D Y/C FILTER is not available for TC-14LA1.

Item	Mode	Explanations
3D Y/C FILTER [for TC-17LA1 and TC-20LA1]	ON ↔ OFF	Minimizes noise and cross color in the picture. Not available for COMPONENT VIDEO.
COLOR MATRIX	SD ↔ HD	Displays input signals (480p signals) in a natural color. Automatically adjusts color parameters for HD (high definition) and SD (standard definition).

ASPECT Controls

The TV will allow you to enjoy viewing the picture at its maximum size, including wide screen cinema format picture.

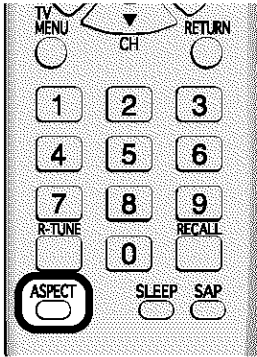

ASPECT button

The aspect mode changes each time the ASPECT button is pressed.

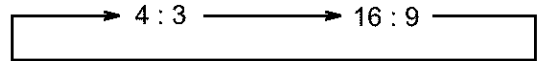

Notes:

- In TV mode, the aspect mode is set to 4:3, and ASPECT controls are not available.
- The ASPECT mode settings are stored for VIDEO1, VIDEO2 and COMPONENT individually.

Mode	Picture	Explanation
4 : 3		4:3 mode will display a 4:3 picture at its standard 4:3 size without any stretching.
16 : 9 (not available in TV mode)		16:9 mode will display 16:9 aspect ratio picture. Bars can be seen at the top and bottom of the image.

Manual de instrucciones [Resumen]

Estimado cliente de Panasonic

Bienvenido a la familia de clientes de Panasonic.

Esperamos sinceramente que disfrute durante muchos años de su nuevo Esperamos sinceramente que disfrute durante muchos años de su nuevo televisor LCD.

Para obtener el máximo beneficio de su aparato, lea estas instrucciones antes de hacer cualquier ajuste, y guárdelas para poder utilizarlas como referencia en el futuro.

Guarde también el recibo de su compra, y anote el número del modelo y el número de serie de su aparato en el espacio provisto en la cubierta posterior de estas instrucciones.

Preparación

Instalación de las pilas del mando a distancia

Cambio de las pilas

Cambie las pilas siguiendo los pasos indicados más abajo:

Se necesitan dos pilas AA.

1. Abra la cubierta de las pilas.
2. Instale las pilas como se muestra en el compartimiento de las pilas. (Las polaridades + y - deben coincidir con las marcas correspondientes del compartimiento).
3. Vuelva a colocar la cubierta.

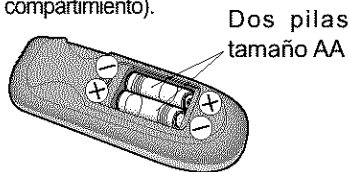

⚠ Precauciones relacionadas con la utilización de las pilas

La instalación incorrecta de las pilas puede causar fugas en las mismas que podrían estropear el transmisor de mando a distancia.

Tome las precauciones siguientes:

1. Utilice siempre pilas nuevas cuando reemplace las viejas.
2. No intente cargar, cortocircuitar, desarmar, calentar o quemar las pilas usadas.
3. Las pilas deberán cambiarse cuando el mando a distancia funcione esporádicamente o no pueda controlar esta unidad.

Conexión del cable de antena al terminal de entrada de RF

Conexión de antena - Para recibir correctamente los canales de VHF/UHF se requiere una antena externa. Para obtener la mejor recepción se recomienda utilizar una antena para exteriores. El modo de antena debe ajustarse a TV.

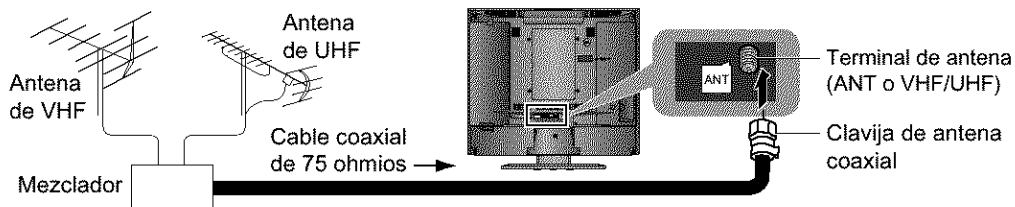

Conexión de antena / cable

Cable entrante de 75 ohmios procedente de la antena del hogar/compañía de televisión por cable

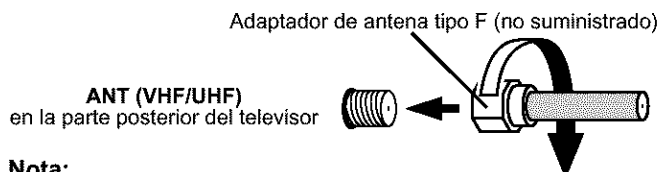

Conexión de cable - Para recibir los canales de televisión por cable (01 - 125) conecte el cable suministrado por su compañía de televisión por cable. El modo de antena debe ajustarse a CABLE. (Consulte la sección Modo de la antena.)

Nota:

Ciertos sistemas de televisión por cable neutralizan algunos canales para reducir interferencias o tienen canales especiales (codificados). Para recibir correctamente estos canales se necesita un sintonizador de conversión de televisión por cable. Póngase en contacto con su compañía de televisión por cable para conocer los requerimientos de compatibilidad.

Para quitar y colocar la cubierta del cable

Para quitarla

1. Suelte los ganchos del extremo más alto.
2. Sáquela lentamente hacia arriba.



Para colocarla

1. Inserte los ganchos (en 2 puntos) en el extremo más bajo.
2. Empújela hacia adentro en el extremo más alto.

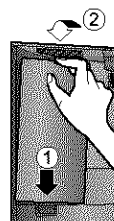

Nota: Dependiendo del tipo de cable utilizado, tal vez no sea posible cerrar la cubierta. En tales casos, el cable podrá instalarse a través de la cubierta de la antena.

Conexión de auriculares

Conecte los auriculares de la forma siguiente.

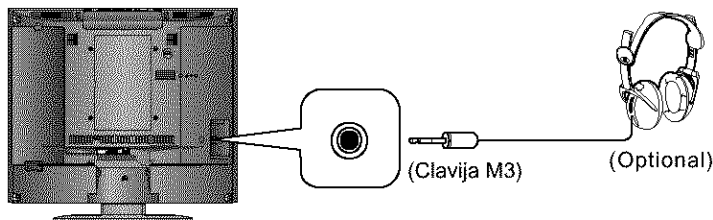

Utilice el botón de aumento  o reducción  del volumen.

Conexión/desconexión de la alimentación

Conexión de la clavija a la toma de corriente

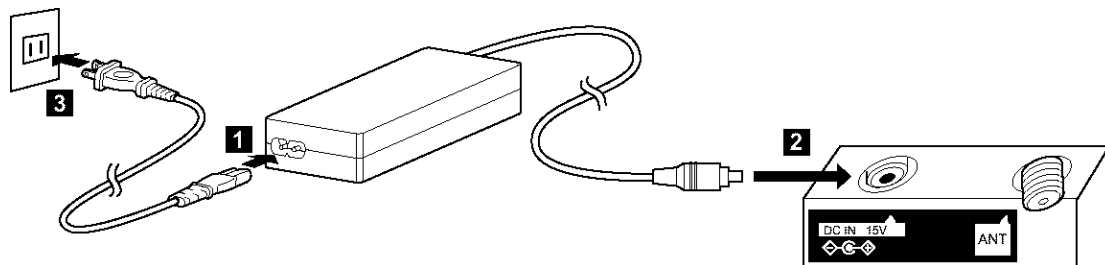

Nota:

El televisor y el adaptador de CA consumirán algo de energía siempre que el cable de alimentación esté conectado a la toma de corriente.

Cómo conectar la alimentación

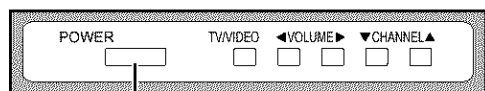

Interruptor POWER principal

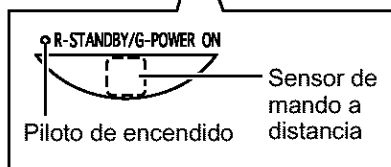
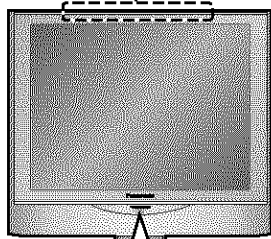

Piloto de encendido

Sensor de mando a distancia

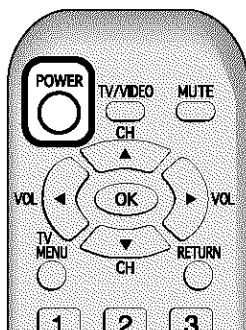

Presione el interruptor POWER principal del televisor para encenderlo.

POWER-ON: Verde

Cuando el aparato esté en el modo de alimentación conectada o en espera, pulse el interruptor POWER principal del televisor para apagarlo.

POWER OFF: Apagado

Ejemplo: La pantalla de abajo se visualiza durante un rato después de encenderse el televisor. (La condición de ajuste es un ejemplo.)

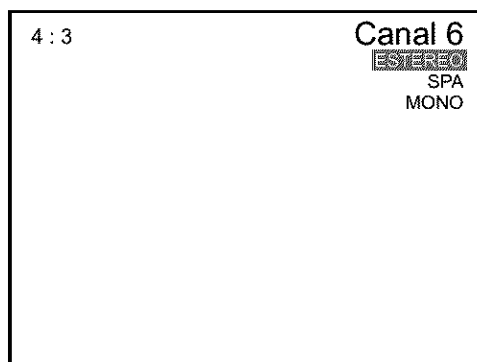

POWER



Pulse el botón POWER del mando a distancia para apagar el televisor: Rojo (espera)

Pulse el botón POWER del mando a distancia para encender el televisor: Verde

Reproducción en una videograbadora o en otro equipo periférico

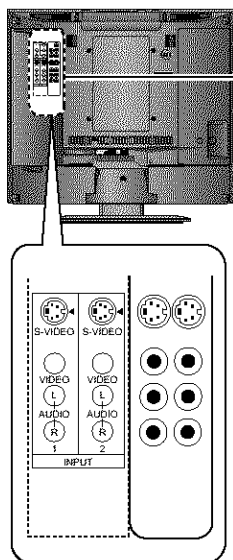

Confirmación de las conexiones

Confirme que el televisor esté en el modo de espera.

A la salida de S-video o a la salida de Vídeo

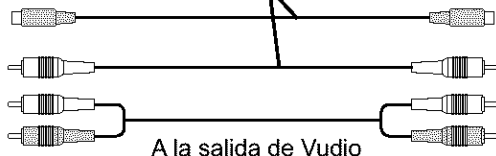

A la salida de Vudio

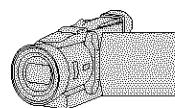

Videocámara

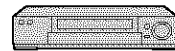

Videograbadora

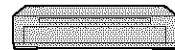

Reproductor de discos láser

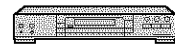

Reproductor DVD

Este equipo también se puede conectar a los terminales traseros. Consulte Conexiones para conocer más detalles. (Consulte la página 10 - 11)

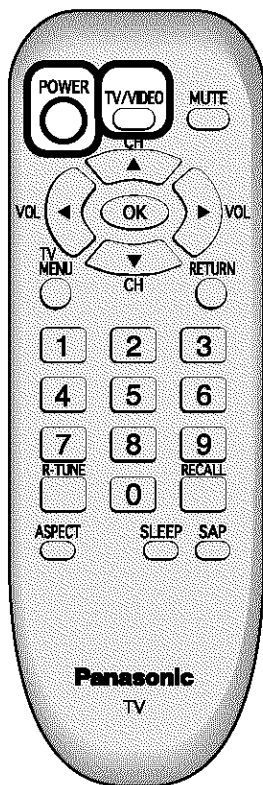

Conexión de la alimentación y cambio de modos de entrada

1 POWER

Encienda el televisor.

2 TV/VIDEO

El modo de entrada cambia cada vez que se pulsa el botón.

- Cuando se reproduce una fuente de VIDEO
- Cuando se reproduce un DVD

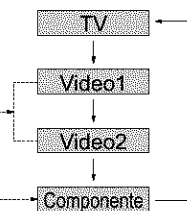

Nota:

Cuando no se puede utilizar el mando a distancia, los modos de entrada también pueden activarse en el televisor utilizando el botón TV/VIDEO.

3 Utilice el equipo conectado.

Controles básicos

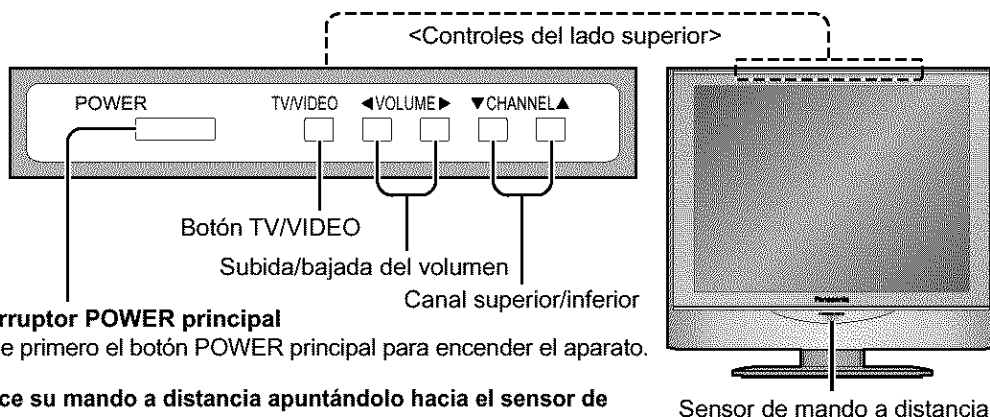

Interruptor POWER principal

Pulse primero el botón POWER principal para encender el aparato.

Utilice su mando a distancia apuntándolo hacia el sensor de mando a distancia.

(Dentro de 6 metros a partir del panel delantero del televisor.)

Botón de la alimentación

Púlselo para encender o apagar esta unidad. (Consulte la página 31.)

Nota:

El cable de alimentación del televisor con LCD deberá enchufarse primero a la toma de corriente, y la alimentación deberá conectarse luego con el interruptor POWER principal.

Tecla TV/VIDEO

El modo de entrada cambia cada vez que se pulsa este botón.

Botón MUTE

Púlselo para silenciar el sonido. Púlselo de nuevo para reactivar el sonido. El sonido también se reactiva cuando se desconecta la alimentación o se cambia el nivel del volumen.

Botón RETURN

Púlselo para volver a la pantalla anterior.

Botón RECALL

Presione para visualizar la hora, el canal, el cronometrado de apagado y otras opciones.

Botón SAP

Selecciona el modo de audio.

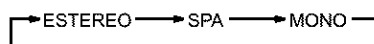

Botón SLEEP

El televisor de LCD puede preajustarse para cambiar al modo de espera después de transcurrir un periodo establecido. El ajuste puede cambiar a 30, 60, 90 y 0 minutos (temporizador de cancelado) cada vez que se pulsa el botón.

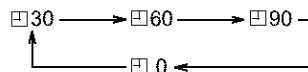

Cuando queden 3 minutos, parpadeará "3". El temporizador se cancelará si se produce una interrupción en el suministro de alimentación.

Antes de que el temporizador desconecte automáticamente la alimentación, el tiempo restante parpadeará en la pantalla ("3" para 3 minutos, "2" para 2 minutos y "1" para 1 minuto antes de desconectarse la alimentación).

Cambia al siguiente canal superior
Mueve el cursor hacia arriba durante el modo del menú.

Reduce el volumen
Mueve el cursor hacia la izquierda durante el modo del menú.

Aumenta el volumen
Mueve el cursor hacia la derecha durante el modo del menú.



Cambia al siguiente canal inferior
Mueve el cursor hacia abajo durante el modo del menú.

Botón MENU

Púlselo para visualizar la pantalla MENU, y púlselo de nuevo para cancelarla.



Botones de selección directa de números de programas

Botón R-TUNE

Para cambiar a un canal o modo de vídeo anterior.

Botón ASPECT

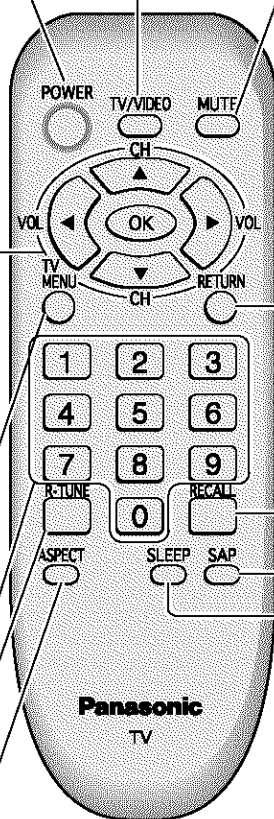
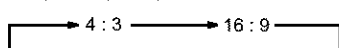

Organigrama de menús de televisión

Utilizando los botones del menú se pueden hacer todos los ajustes y configuraciones que este aparato es capaz de realizar. La pantalla de menú está compuesta de 2 menús, el menú Ajuste y el menú Configu..

1

Púlselo para visualizar la pantalla MENU, y púlselo de nuevo para cancelarla.

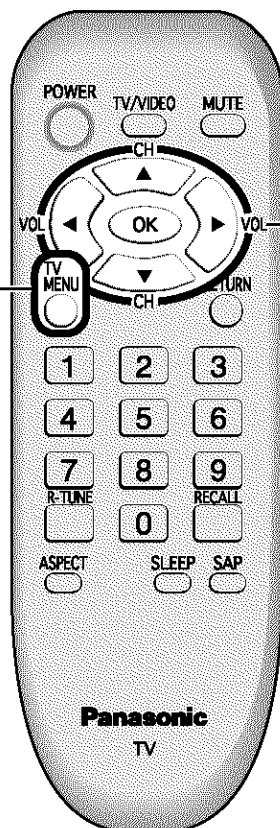
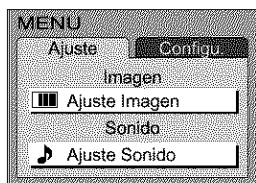

2

Selección de MENÚ

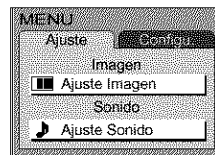

O

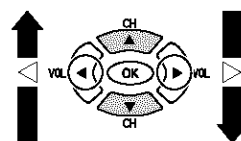
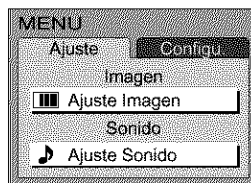

Consulte la ayuda en pantalla

El cuadro de ayuda en pantalla se visualiza siempre que aparece un menú en la pantalla. Este cuadro de ayuda indica qué teclas del mando a distancia se utilizan para desplazarse por el menú mostrado. Consulte más arriba las descripciones de las funciones de los botones.

Cuadro de instrucciones de ayuda en pantalla

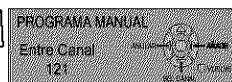

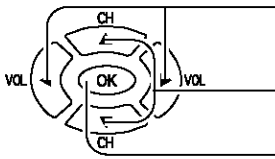

Pulse para seleccionar el MENÚ deseado (Ajuste o Configu.).

Pulse para seleccionar cada elemento.

Pulse para visualizar cada pantalla de ajuste.



Prosiga con el ajuste.

- Para volver a la pantalla anterior :



Pulse para volver.

- Para finalizar el ajuste :



Pulse para salir de la pantalla MENU.

Esto hace que el aparato vuelva a la condición de visión normal.

Pulse para visualizar cada pantalla de ajuste.

OK

RETURN

Pulse el botón RETURN para volver a la pantalla anterior.

Menú Ajuste Imagen

Ajuste Imagen	
Normal	
Imagen	Normal
Luz de Atras	+ 30
CONTRASTE	0
BRILLO	0
COLOR	0
TINTE	0
NITIDEZ	0
Imagen IA	No Si

Menú Ajuste Sonido

Ajuste Sonido	
Normal	
Sonido	Dinamico
BAJOS	+ 6
ALTOS	+ 8
BALANCE	0
SON. ENVOL	No Si
ESTEREO	SPA MONO

Pantalla de selección Bloqueo

Bloqueo	
Programas:	
Películas de EEUU	
Activado	No Si
Modificar	
INGRESAR CLAVE	

Pulse para visualizar cada pantalla de ajuste.

OK

RETURN

Pulse el botón RETURN para volver a la pantalla anterior.

Menú Idioma

Idioma	
Idioma	ESPAÑOL

Le permite seleccionar el idioma seleccionado en las visualizaciones en pantalla.

ENGLISH ← → FRANÇAIS
← → ESPAÑOL

Menú Prog. Canales

Prog. Canales	
MODO	TV CABLE
PROGRAMA AUTO	
PROGRAMA MANUAL	

Menú Otro Ajuste

Otro Ajuste	
3D Y/C Filtro	No Si
Matriz Color	DS HD

[para TC-17LA1 y TC-20LA1]

Pantalla e ajuste Subtítulos

Subtítulos	
EN MUDO	No
MODO	No

Menú Ponga Títulos

Ponga Títulos	
Video1	Video1
Video2	Video2
Componente	Componente

[para TC-14LA1]

Sintonización de canales (Programación automática de canales)

Explora automáticamente todos los canales de TV y los almacena en la memoria.

1 Conecte la alimentación y pulse el botón TV/VIDEO para visualizar el canal de televisión.

2 Pulse el botón MENU para visualizar la pantalla MENU y seleccione Configu..

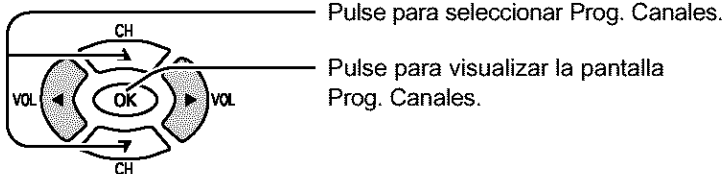

3 Pulse para seleccionar MODO.

Pulse para seleccionar TV o CABLE.

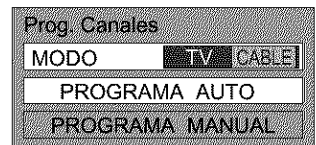
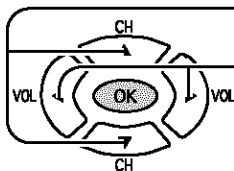

4 Pulse para seleccionar PROGRAMA AUTO.

Pulse para visualizar la pantalla de confirmación.

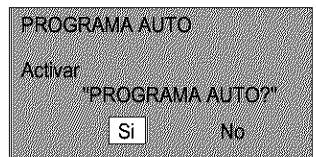
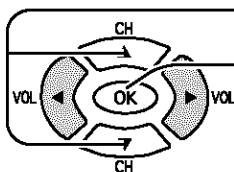

5 Pulse para seleccionar Si.

Pulse para seleccionar No.

Pulse para ejecutar PROGRAMA AUTO.

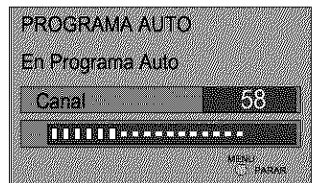
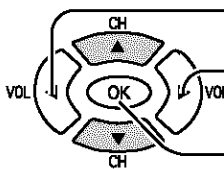

Los canales avanzarán automáticamente hasta que todos hayan sido explorados. Los números de canales con una videoseñal se almacenarán en la memoria de exploración de canales.



Pulse para salir de la pantalla MENU.
Esto hace que el aparato vuelva a la condición de visión normal.

Notas:

- Cuando se pulsen botones mientras se ejecute PROGRAMA AUTO, el televisor volverá al modo de visión normal. (Los canales encontrados hasta este punto se añadirán.)
- Después de terminar PROGRAMA AUTO, se recibirá el canal con el número más bajo que haya sido añadido.
- Cuando no haya canales que puedan ser recibidos se visualizará el canal 69 (canal 125 para la televisión por cable).

Sintonización de canales (Programación manual de canales)

Utilice este ajuste cuando cambie ajustes de los canales de recepción o cuando cambie la visualización de los canales.

Encienda el televisor y seleccione el canal de emisión. Siga los pasos de la página anterior para visualizar la pantalla Prog. Canales.

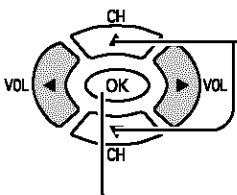
- 1**
- 
- Pulse para seleccionar PROGRAMA MANUAL.
- Pulse para visualizar la pantalla PROGRAMA MANUAL.

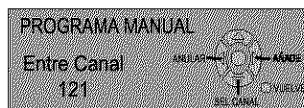
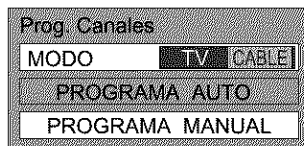

Adición o borrado de canales

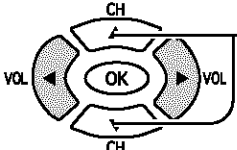
- 2**
- 
- Pulse para seleccionar canal (o teclas de números).

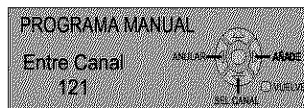

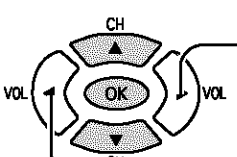
- 3**
- 
- Pulse para añadir canales a la memoria (el número del canal se pone de color azul).
- Pulse para borrar canales de la memoria (el número del canal se pone de color amarillo).

- 4** Repita los pasos 2 y 3 para continuar añadiendo o borrando canales.



Pulse para salir de la pantalla MENU.
Esto hace que el aparato vuelva a la condición de visión normal.

Ajuste el soporte con el ángulo deseado

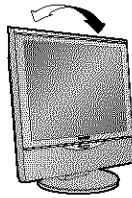
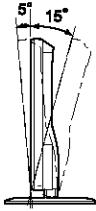

El ángulo del soporte se puede ajustar hacia atrás dentro de un margen de 5 ° a 15 °.

Para quitar y colocar la cubierta de la antena

TC-14LA1/ TC-17LA1

Para quitarla

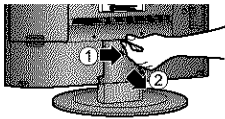

1. Sujete la cubierta en el extremo más bajo y empiece a quitarla tirando ligeramente de ella hacia usted.
2. Sáquela lentamente hacia abajo.

Para colocarla

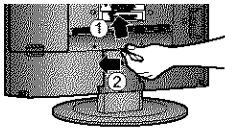

1. Inserte los ganchos (en 4 puntos) en el extremo más alto.
2. Empuje los ganchos hacia adentro (en 4 puntos) en el extremo más abajo.

Nota:

Para evitar que aparezcan interferencias en la pantalla, no una el cable de la antena y el cable del adaptador de CA.

TC-20LA1

Para quitarla

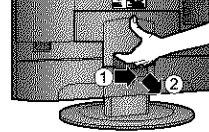

1. Sujete la abertura y empiece a tirar ligeramente de la cubierta hacia usted para soltar los ganchos (en 2 puntos de la derecha y la izquierda).
2. Sáquela lentamente hacia abajo.

Para colocarla

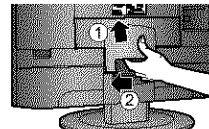

1. Inserte los ganchos (en 4 puntos) en el extremo más alto.
2. Empuje los ganchos hacia adentro (en 4 puntos) en el extremo más abajo.

Troubleshooting

Before requesting service for this LCD TV, check the chart below for a possible cause of the problem you are experiencing. Some simple checks or a minor adjustment on your part may eliminate the problem and restore proper operation. If you are in doubt about some of the check points, or if the remedies indicated in the chart do not solve the problem, consult your dealer for instructions.

Symptom	Cause and remedy	Page
Power supply does not go on	<ul style="list-style-type: none"> • Is power supply plug unplugged from the outlet? • If power will not go on with the remote control, is the power supply of the TV "Off"? 	— 13
Remote control cannot be operated	<ul style="list-style-type: none"> • Is battery exhausted, or is battery polarity wrong? • Is the remote control receiver illuminated with strong light from a fluorescent lamp etc.? • Are you using the special-purpose remote control for this equipment? (The unit will not operate with another remote control.) 	7 — —
Image shakes, or image is unclear	<ul style="list-style-type: none"> • Is there deterioration, breakage or disconnection of the antenna or antenna wire? • Is the antenna wire connected correctly? 	— 8, 9
There are spots on the picture, or the screen shakes	<ul style="list-style-type: none"> • Is the system affected (by radio wave interference or induced electromagnetic waves) by external sources (automobiles or trains, high-voltage wires, neon, motors, magnetized steel frame, or iron rain shutters, etc.)? <ul style="list-style-type: none"> ➡ Turn off the power supply, and try changing the equipment setup location. If that has no effect, separate magnet-proofing will be required. 	—
The image appears doubled or tripled	<ul style="list-style-type: none"> • Is the antenna direction shifted? • Are reflected electromagnetic waves being received from mountains or buildings? 	—
A color pattern appears, or colors disappear	<ul style="list-style-type: none"> • Is the equipment being affected by another TV (electromagnetic interference)? <ul style="list-style-type: none"> ➡ Changing the TV setup location may lead to improvement. 	—
The channel number disappears from the screen	<ul style="list-style-type: none"> • Has the RECALL button been pressed? <ul style="list-style-type: none"> ➡ Press the "RECALL button" again. If the system is switched to external input and there is no external signal video, the number will disappear. 	15
When the image is not stable, the screen turns completely white for a moment	<ul style="list-style-type: none"> • This occurs when the signal driving the liquid crystal is lost, and is not a malfunction. 	—
The screen goes dark momentarily when the channel is changed.	<ul style="list-style-type: none"> • The screen is darkened for a moment to conceal noise generated when changing channels. 	—
The TV makes a hissing noise occasionally	<ul style="list-style-type: none"> • If the screen and audio are not abnormal, this sound is caused by slight expansion and contraction of the cabinet due to changes in room temperature. It has no effect on performance. 	—
The screen display shakes with video input	<ul style="list-style-type: none"> • When input is switched to "video input", this may occur if there is no signal at the video/audio input terminal. 	10, 11
A black band appears momentarily when selecting channels with video	<ul style="list-style-type: none"> • This is due to noise generated when changing channels. 	—
Both edges of the screen, or columns or window frames, appear bent	<ul style="list-style-type: none"> • They may appear bent due to the received channel or some DVD software. This is not a malfunction. 	—
The image from the connected equipment does not appear	<ul style="list-style-type: none"> • Are plugs securely inserted into each terminal? <ul style="list-style-type: none"> ➡ Securely insert plugs all the way. 	10, 11
The main unit is hot to the touch	<ul style="list-style-type: none"> • The main unit radiates heat, so some parts of the console reach a high temperature. This is not a problem for performance or quality. • Set up at a location with good ventilation. Do not cover the ventilation holes of the console with a tablecloth, etc., and do not place on top of other equipment (like a video deck). 	—

Specifications

	TC-14LA1	TC-17LA1	TC-20LA1	
Power Source	AC 120 V, 60 Hz			
Power Consumption	Average use : 48W Stand-by condition : 0.6 W TV set DC 15 V, 2.8 A max.	Average use : 60 W Stand-by condition : 0.8 W TV set DC 15 V, 3.6 A max.	Average use : 67 W Stand-by condition : 0.8 W TV set DC 15 V, 3.8 A max.	
LCD	14-inch (356 mm), 4 : 3 aspect ratio LCD panel	17-inch (432 mm), 4 : 3 aspect ratio LCD panel	20-inch (510 mm), 4 : 3 aspect ratio LCD panel	
Screen Size	11.23 " (285.1 mm) (W) × 8.42 " (213.8 mm) (H)	13.53 " (343.7 mm) (W) × 10.30 " (261.6 mm) (H)	16.06 " (408.0 mm) (W) × 12.05 " (306.0 mm) (H)	
Channel Capability	VHF-12 : UHF-56 : Cable-125			
Sound				
Speaker	φ 4 cm, 2pcs, 16 Ω			
Headphones	M3 (3.5 mm) Jack × 1			
FEATURES	3D Y/C Digital Comb Filter			
	CLOSED CAPTION V-Chip			
Operating Conditions	Temperature : 41 °F - 95 °F (5 °C - 35 °C) Humidity : 5 % - 90 % RH (non-condensing)			
Connection Terminals				
INPUT	VIDEO (RCA PIN Type × 1) × 2	1.0 Vp-p (75 Ω)		
	S-VIDEO (MINI DIN 4pin × 1) × 2	Y : 1 Vp-p (75 Ω), C : 0.286 Vp-p (75 Ω)		
	AUDIO L-R (RCA PIN Type × 2) × 2	0.5 Vrms		
COMPONENT VIDEO INPUT	Y	1.0 Vp-p (including synchronization)		
	P _B / P _R	±0.35 Vp-p		
	AUDIO L-R (RCA PIN Type × 2)	0.5 Vrms		
Dimensions (W × H × D)				
Including TV Stand	14.37 " (365 mm) × 14.34 " (364.2 mm) × 8.46 " (215 mm)	16.69 " (424 mm) × 16.35 " (415.2 mm) × 8.46 " (215 mm)	19.45 " (494 mm) × 18.17 " (461.4 mm) × 10.04 " (255 mm)	
	TV Set Only	14.37 " (365 mm) × 13.01 " (330.5 mm) × 2.51 " (63.7 mm)	16.69 " (424 mm) × 15.02 " (381.5 mm) × 2.52 " (64.1 mm)	19.45 " (494 mm) × 16.63 " (422.3 mm) × 3.21 " (81.5 mm)
		Mass (Weight)	9.701 lb. (4.4 kg) Net	11.46 lb. (5.2 kg) Net

Note: ●Design and Specifications are subject to change without notice. Weight and Dimensions shown are approximate.

Customer' Record

The model number and serial number of this product can be found on its rear panel. You should note this serial number in the space provided below and retain this book, plus your purchase receipt, as a permanent record of your purchase to aid in identification in the event of theft or loss, and for Warranty Service purposes.

Model Number _____

Serial Number _____

Panasonic Consumer Electronics Company, Division of Matsushita Electric Corporation of America
One Panasonic Way Secaucus
New Jersey 07094

Panasonic Sales Company, Division of Matsushita Electric of Puerto Rico Inc. ("PSC")
Ave. 65 de Infanteria, Km 9.5
San Gabriel Industrial Park,
Carolina, Puerto Rico 00985

Panasonic Canada Inc.
5770 Ambler Drive
Mississauga, Ontario
L4W 2T3

Printed in Japan
SS0303S0(MBS)