



Top-Mount Refrigerator

Use & Care Guide

Refrigerador con montaje superior

Manual de uso y cuidado

Réfrigérateur superposé

Guide d'utilisation et d'entretien

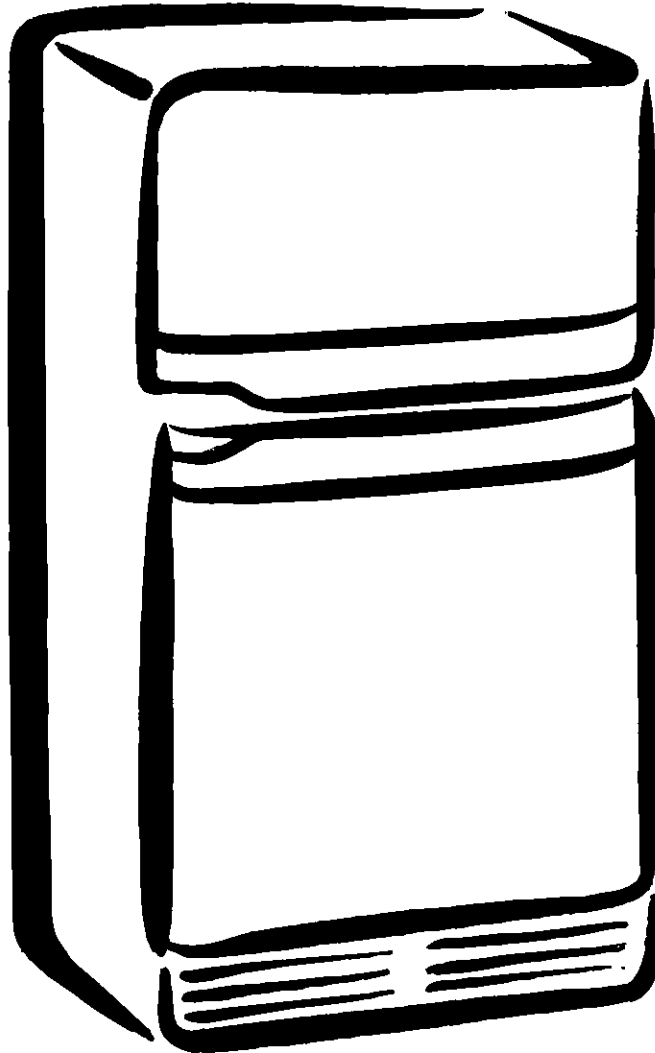

ENGLISH | ESPAÑOL | FRANÇAIS

TABLE OF CONTENTS

WARRANTY	2
REFRIGERATOR SAFETY	3
Proper Disposal of Your Old Refrigerator	3
REFRIGERATOR INSTALLATION	4
Unpacking	4
Location Requirements	4
Electrical Requirements.....	5
Water Supply Connection	5
Refrigerator Doors: Removing, Reversing (optional) & Replacing	6
Door Closing and Alignment	8
Water System Preparation	8
Normal Sounds.....	9
REFRIGERATOR USE	9
Ensuring Proper Air Circulation	9
Using the Control(s).....	9
Water Dispenser	10
Interior Water Filtration System.....	10
Ice Maker	11
REFRIGERATOR FEATURES	12
Refrigerator Shelves	12
Lateral Adjustable Shelf.....	12
Crispers and Meat Drawers	12
Crisper Humidity Control.....	13
Chilled Meat Drawer.....	13
Wine or Can/Bottle Rack.....	13
Utility or Egg Bin.....	14
FREEZER FEATURES	14
Freezer Shelf.....	14
Adjustable Half-width Freezer Shelf.....	14
Pull-out Freezer Floor	14
DOOR FEATURES	14
Door Rails	14
Can Racks and Door Bins.....	15
Adjustable Utility Compartment & Tray.....	15
Flip-up Door Shelf	15
REFRIGERATOR CARE	15
Cleaning.....	15
Changing the Light Bulbs.....	16
Power Interruptions	16
Vacation and Moving Care	16
TROUBLESHOOTING	17
PROTECTION AGREEMENTS	18
In the U.S.A.....	18
In Canada	19
Accessories	19
WATER FILTER CERTIFICATIONS	19
PRODUCT DATA SHEETS	20
SERVICE NUMBERS	BACK COVER

WARRANTY

ONE-YEAR FULL WARRANTY ON REFRIGERATOR

For one year from the date of purchase, when this refrigerator is operated and maintained according to instructions attached to or furnished with the product, Sears will repair this refrigerator, free of charge, if defective in material or workmanship.

FIVE-YEAR FULL WARRANTY ON SEALED REFRIGERATION SYSTEM

For five years from the date of purchase, when this refrigerator is operated and maintained according to owner's instructions attached to or furnished with the product, Sears will repair the sealed system (consisting of refrigeration, connecting tubing, and compressor), free of charge, if defective in materials or workmanship.

The above warranty coverage applies only to refrigerators which are used for storage of food for private household purposes and excludes original and replacement Kenmore Filtered Ice & Water filter cartridges (if equipped with the filter system). Original and replacement cartridges are warranted for 30 days, parts only, against defects in material or workmanship.

WARRANTY SERVICE IS AVAILABLE BY CONTACTING THE NEAREST SEARS SERVICE CENTER IN THE UNITED STATES OR CANADA.

This warranty applies only while this product is in use in the United States or Canada. This warranty gives you specific legal rights, and you may also have other rights which vary from state to state or province to province.

Warranty terms may vary in Canada. Contact your local Sears Service Center for complete details.

Sears, Roebuck and Co.

Dept. 817WA, Hoffman Estates, IL 60179

Sears Canada, Inc., Toronto, Ontario, Canada M5B 2B8

Product Record

In the space below, record your complete model number, serial number, and purchase date. You can find this information on the model and serial number label located on the inside wall of the refrigerator compartment.

Have this information available to help you obtain assistance or service more quickly whenever you contact Sears concerning your refrigerator.

Model number 106. _____

Serial number _____

Purchase date _____

Save these instructions and your sales receipt for future reference.

REFRIGERATOR SAFETY

Your safety and the safety of others are very important.

We have provided many important safety messages in this manual and on your appliance. Always read and obey all safety messages.



This is the safety alert symbol.

This symbol alerts you to potential hazards that can kill or hurt you and others.

All safety messages will follow the safety alert symbol and either the word "DANGER" or "WARNING." These words mean:

⚠ DANGER

You can be killed or seriously injured if you don't immediately follow instructions.

⚠ WARNING

You can be killed or seriously injured if you don't follow instructions.

All safety messages will tell you what the potential hazard is, tell you how to reduce the chance of injury, and tell you what can happen if the instructions are not followed.

IMPORTANT SAFETY INSTRUCTIONS

WARNING: To reduce the risk of fire, electric shock, or injury when using your refrigerator, follow these basic precautions:

- Plug into a grounded 3 prong outlet.
- Do not remove ground prong.
- Do not use an adapter.
- Do not use an extension cord.
- Disconnect power before servicing.
- Replace all panels before operating.
- Remove doors from your old refrigerator.
- Use nonflammable cleaner.
- Keep flammable materials and vapors, such as gasoline, away from refrigerator.
- Use two or more people to move and install refrigerator.
- Disconnect power before installing ice maker (on ice maker kit ready models only).
- Use a sturdy glass when dispensing ice or water (on some models).

SAVE THESE INSTRUCTIONS

Proper Disposal of Your Old Refrigerator

⚠ WARNING

Suffocation Hazard

Remove doors from your old refrigerator.

Failure to do so can result in death or brain damage.

IMPORTANT: Child entrapment and suffocation are not problems of the past. Junked or abandoned refrigerators are still dangerous – even if they will sit for "just a few days." If you are getting rid of your old refrigerator, please follow these instructions to help prevent accidents.

Before you throw away your old refrigerator or freezer

- Take off the doors.
- Leave the shelves in place so that children may not easily climb inside.

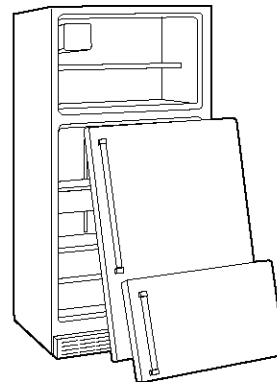

REFRIGERATOR INSTALLATION

Unpacking

⚠️ WARNING

Excessive Weight Hazard

Use two or more people to move and install refrigerator.

Failure to do so can result in back or other injury.

Removing packaging materials

- Remove tape and glue residue from surfaces before turning on the refrigerator. Rub a small amount of liquid dish soap over the adhesive with your fingers. Wipe with warm water and dry.
- Do not use sharp instruments, rubbing alcohol, flammable fluids, or abrasive cleaners to remove tape or glue. These products can damage the surface of your refrigerator. For more information, see the "Refrigerator Safety" section.
- On some models, shelves, bins, door shelf rails, and other feature parts may be packaged in the Interior FeaturePak. Follow the instructions contained in the package for proper assembly.
- Depending on your model, to remove the protective (transparent) film that is on the nameplate, which is located on the freezer handle, use your fingernail and peel off the film, starting from one side and peeling to the other.

IMPORTANT: Do not remove the white foam air return insert that is located behind the control panel on the ceiling of the refrigerator (on some models). The insert is part of the refrigerator and not part of the packing material. If the insert is removed, ice may migrate down from the freezer and cause icicles to form.

When Moving Your Refrigerator:

Your refrigerator is heavy. When moving the refrigerator for cleaning or service, be sure to protect the floor. Always pull the refrigerator straight out when moving it. Do not wiggle or "walk" the refrigerator when trying to move it, as floor damage could occur.

Cleaning before use

After you remove all of the package materials, clean the inside of your refrigerator before using it. See the cleaning instructions in the "Refrigerator Care" section.

Important information to know about glass shelves and covers:

Do not clean glass shelves or covers with warm water when they are cold. Shelves and covers may break if exposed to sudden temperature changes or impact, such as bumping. For your protection, tempered glass is designed to shatter into many small, pebble-size pieces. This is normal. Glass shelves and covers are heavy. Use special care when removing them to avoid impact from dropping.

Location Requirements

⚠️ WARNING



Explosion Hazard

Keep flammable materials and vapors, such as gasoline, away from refrigerator.

Failure to do so can result in death, explosion, or fire.

To ensure proper ventilation for your refrigerator, allow for ½ in. (1.25 cm) space on each side and at the top. When installing your refrigerator next to a fixed wall, leave 2 in. (5.08 cm) minimum on each side (depending on your model) to allow for the door to swing open. If your refrigerator has an ice maker, allow extra space at the back for the water line connections.

NOTE: Do not install the refrigerator near an oven, radiator, or other heat source, nor in a location where the temperature will fall below 55°F (13°C).

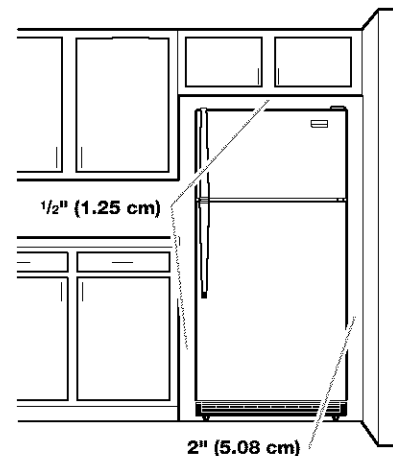

Electrical Requirements

⚠ WARNING



Electrical Shock Hazard

Plug into a grounded 3 prong outlet.

Do not remove ground prong.

Do not use an adapter.

Do not use an extension cord.

Failure to follow these instructions can result in death, fire, or electrical shock.

Before you move your refrigerator into its final location, it is important to make sure you have the proper electrical connection:

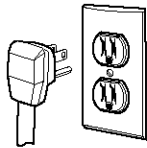

Recommended grounding method

A 115 Volt, 60 Hz., AC only 15 or 20 ampere fused, grounded electrical supply is required. It is recommended that a separate circuit serving only your refrigerator be provided. Use an outlet that cannot be turned off by a switch. Do not use an extension cord.

NOTE: Before performing any type of installation, cleaning, or removing a light bulb, turn the control (Thermostat, Refrigerator or Freezer Control depending on the model) to OFF and then disconnect the refrigerator from the electrical source. When you are finished, reconnect the refrigerator to the electrical source and reset the control (Thermostat, Refrigerator or Freezer Control depending on the model) to the desired setting.

Water Supply Connection

Read all directions carefully before you begin.

IMPORTANT:

- If you turn the refrigerator on before the water line is connected, turn the ice maker OFF.
- All installations must meet local plumbing code requirements.
- Use copper tubing and check for leaks. Install copper tubing only in areas where temperatures will remain above freezing.

Tools required: Standard screwdriver, $\frac{7}{16}$ in. and $\frac{1}{2}$ in. open-end wrenches or two adjustable wrenches, $\frac{1}{4}$ in. nut driver and drill bit, hand drill or electric drill (properly grounded).

NOTE: Your refrigerator dealer has a kit available with a $\frac{1}{4}$ in. (6.35 mm) saddle-type shutoff valve, a union, and copper tubing. Before purchasing, make sure a saddle-type valve complies with your local plumbing codes. Do not use a piercing-type or $\frac{3}{16}$ in. (4.76 mm) saddle valve which reduces water flow and clogs more easily.

Cold water supply

Connect the ice maker to a cold water line with water pressure between 30 and 120 psi. If you have questions about your water pressure, call your utility company.

Connecting to Water Line

1. Unplug refrigerator or disconnect power.
2. Turn OFF main water supply. Turn ON nearest faucet long enough to clear line of water.
3. Locate a $\frac{1}{2}$ in. to $1\frac{1}{4}$ in. (1.25 cm to 3.18 cm) vertical COLD water pipe near the refrigerator.
NOTE: Horizontal pipe will work, but drill on the top side of the pipe, not the bottom. This will help keep water away from the drill and normal sediment from collecting in the valve.
4. Determine the length of copper tubing you need. Measure from the connection on the lower left rear of refrigerator to the water pipe. Add 7 ft. (2.1 m) to allow for cleaning. Use $\frac{1}{4}$ in. (6.35 mm) O.D. (outside diameter) copper tubing. Be sure both ends of copper tubing are cut square.
5. Using a grounded drill, drill a $\frac{1}{4}$ in. hole in the cold water pipe you have selected.

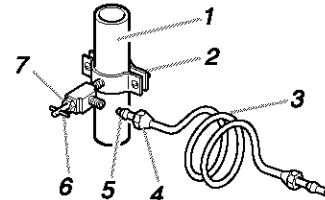

1. Cold Water Pipe
2. Pipe Clamp
3. Copper Tubing
4. Compression Nut
5. Compression Sleeve
6. Shutoff Valve
7. Packing Nut

6. Fasten the shutoff valve to the cold water pipe with the pipe clamp. Be sure the outlet end is solidly in the $\frac{1}{4}$ in. drilled hole in the water pipe and that the washer is under the pipe clamp. Tighten the packing nut. Tighten the pipe clamp screws carefully and evenly so washer makes a watertight seal. Do not overtighten or you may crush the copper tubing.
7. Slip the compression sleeve and compression nut on the copper tubing as shown. Insert the end of the tubing into the outlet end squarely as far as it will go. Screw compression nut onto outlet end with adjustable wrench. Do not overtighten.
8. Place the free end of the tubing in a container or sink, and turn ON the main water supply. Flush the tubing until water is clear. Turn OFF the shutoff valve on the water pipe. Coil the copper tubing.

Connecting to Refrigerator

1. Attach the copper tube to the valve inlet using a compression nut and sleeve as shown. Tighten the compression nut. Do not overtighten. Use the tube clamp on the back of the refrigerator to secure the tubing to the refrigerator as shown. This will help prevent damage to the tubing when the refrigerator is pushed back against the wall.
2. Turn shutoff valve ON.

3. Check for leaks. Tighten any connections (including connections at the valve) or nuts that leak.

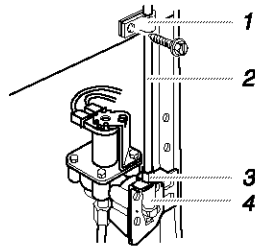

1. Tube Clamp
2. Copper Tubing
3. Compression Nut
4. Valve Inlet

4. The ice maker is equipped with a built-in water strainer. If your water conditions require a second water strainer, install it in the 1/4 in. (6.35 mm) water line at either tube connection. Obtain a water strainer from your nearest appliance dealer.
5. Plug in refrigerator or reconnect power.

Refrigerator Doors: Removing, Reversing (optional) & Replacing

Tools needed: 5/16 in. hex-head socket wrench, No. 2 Phillips screwdriver, flat-head screwdriver, 5/16 in. open-end wrench, flat 2 in. putty knife.

IMPORTANT:

- Before you begin, turn the refrigerator control OFF, unplug refrigerator or disconnect power. Remove food and any adjustable door or utility bins from doors.
- If you only want to remove and replace the doors, see the “Door and Hinge Removal” and “Door and Hinge Replacement” sections.

Door and Hinge Removal



5/16" Hex-Head Hinge Screw

1. Unplug refrigerator or disconnect power.
2. Open the refrigerator door and remove the base grille from the bottom front of the refrigerator as shown in Base Grille graphic.
3. Close the refrigerator door and keep both doors closed until you are ready to lift them free from the cabinet.
NOTE: Provide additional support for the doors while the hinges are being moved. Do not depend on the door magnets to hold the doors in place while you are working.
4. Remove the parts for the top hinge as shown in Top Hinge graphic. Lift the freezer door free from the cabinet.
5. Remove the parts for the center hinge as shown in the Center Hinge graphic. Lift the refrigerator door free from the cabinet.
6. Remove the parts for the bottom hinge as shown in the Bottom Hinge graphic.

IMPORTANT: If you want to reverse your doors so that they swing in the opposite direction, follow these steps. If you are not reversing the doors, see “Door and Hinge Replacement.”

Door Reversal (optional)

(Graphics follow these instructions.)



Round-Head
Handle Screw



Door Handle
Screw Hole Plug



Door Hinge
Hole Plug

Cabinet

1. Remove 5/16 in. hex-head hinge screws from handle side and move them to opposite side (see Graphic 1-1).
2. Remove cabinet hinge hole plugs from the cabinet top and move them to opposite side hinge holes as shown (see Graphic 1-2).

Doors

1. Remove door hinge hole plug from top of freezer door. Move to opposite side as shown (see Graphic 2).
2. Remove door stop from both the freezer and refrigerator door (see Graphic 3).

NOTE: When reversing the door, the freezer handle becomes the refrigerator door handle and the refrigerator door handle becomes the freezer handle (see Door Handle Reversal graphic).

3. Remove freezer handle assembly as shown. Keep all parts together (see Graphic 4).
4. Remove refrigerator handle assembly as shown. Keep all parts together (see Graphic 5).
5. Rotate and position handle from refrigerator door onto freezer door and assemble as shown (see Graphic 6).
6. Rotate and position handle from freezer door onto refrigerator door and assemble as shown (see Graphic 7).
7. Reinstall door stops to opposite side (see Graphic 8).

Door and Hinge Replacement

NOTE: Graphic may be reversed if door swing is reversed.

1. Assemble the parts for the bottom hinge as shown. Tighten screws (see Bottom Hinge graphic). Replace the refrigerator door.
NOTE: Provide additional support for the doors while the hinges are being moved. Do not depend on the door magnets to hold the doors in place while you are working.
2. Assemble the parts for the center hinge as shown (see Center Hinge graphic). Tighten all screws. Replace the freezer door.
3. Assemble the parts for the top hinge as shown. Do not tighten completely (see Top Hinge graphic).
4. Line up the doors so that the bottom of the freezer door aligns evenly with the top of the refrigerator door. Tighten all screws.

Final Steps

1. Check all holes to make sure that hole plugs and screws are in place. Reinstall top hinge cover (see Top Hinge graphic).
2. Replace the base grille (see the Base Grille graphic).
3. Plug in refrigerator or reconnect power.
4. Reset the controls (see “Using the Controls” section).
5. Return all removable door parts to doors and food to product.

Door Removal & Replacement

Base Grille

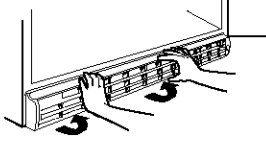

Top Hinge

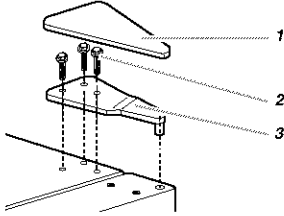

1. Top Hinge Cover
2. $\frac{5}{16}$ " Hex-Head Hinge Screws
3. Top Hinge

Center Hinge

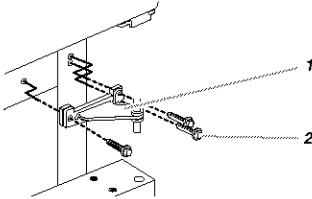

1. Center Hinge
2. $\frac{5}{16}$ " Hex-Head Hinge Screws

Bottom Hinge

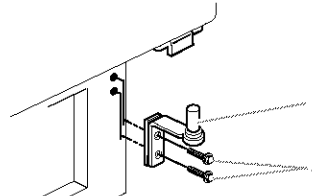

1. Bottom Hinge
2. $\frac{5}{16}$ " Hex-Head Hinge Screws

1-1

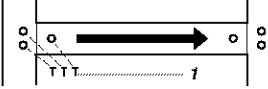

1. $\frac{1}{8}$ " Hex-Head Hinge Screws

1-2

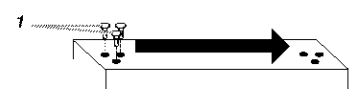

1. Cabinet Hinge Hole Plugs

2

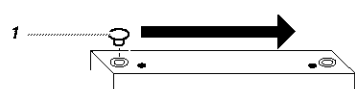

1. Door Hinge Hole Plug

3

Removal of Door Stops

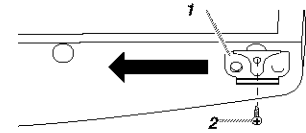

1. Door Stop
2. Door Stop Screw

4

Freezer Door

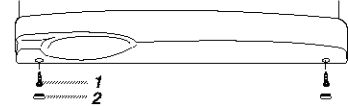

1. Door Handle Sealing Screws
2. Door Handle Screw Hole Plugs

5

Refrigerator Door

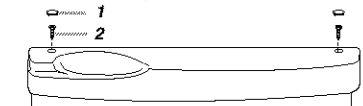

1. Door Handle Screw Hole Plugs
2. Door Handle Sealing Screws

6

Freezer Door

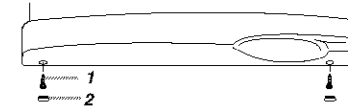

1. Door Handle Sealing Screws
2. Door Handle Screw Hole Plugs

7

Refrigerator Door

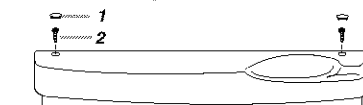

1. Door Handle Screw Hole Plugs
2. Door Handle Sealing Screws

Door Handle Reversal

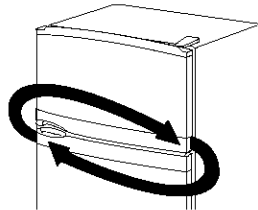

8 Re-installation of Door Stops

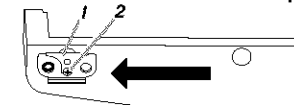

1. Door Stop
2. Door Stop Screw

Door Closing and Alignment

Door Closing

Your refrigerator has two front adjustable rollers – one on the right and one on the left. If your refrigerator seems unsteady or you want the doors to close easier, adjust the refrigerator's tilt using the instructions below:

1. Plug into a grounded 3 prong outlet.
2. Move the refrigerator into its final position.
3. Remove the base grille (see "Base Grille" earlier in this section). The two leveling screws are part of the front roller assemblies which are at the base of the refrigerator on either side.
4. Use a screwdriver to adjust the leveling screws. Turn the leveling screw to the right to raise that side of the refrigerator or turn the leveling screw to the left to lower that side. It may take several turns of the leveling screws to adjust the tilt of the refrigerator.

NOTE: Having someone push against the top of the refrigerator takes some weight off the leveling screws and rollers. This makes it easier to adjust the screws.

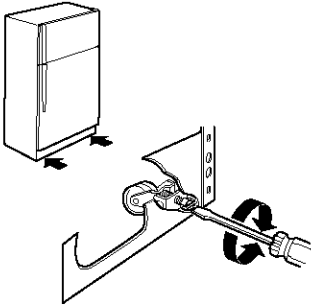

5. Open both doors again and check to make sure that they close as easily as you like. If not, tilt the refrigerator slightly more to the rear by turning both leveling screws to the right. It may take several more turns, and you should turn both leveling screws the same amount.
6. Replace the base grille.

Door Alignment

If the space between your doors looks uneven, you can adjust it using the instructions below:

1. Pry off the top hinge cover.
2. Loosen the top hinge screws using a $\frac{5}{16}$ in. socket or wrench.
3. Have someone hold the door in place or put a spacer between the doors while you tighten the top hinge screws.
4. Replace the top hinge cover.

Water System Preparation

(on some models)

Please read before using the water system.

Immediately after installation, follow the steps below to make sure that the water system is properly cleaned.

1. Turn off the ice maker by opening the freezer door and lifting up the wire shutoff arm as shown.

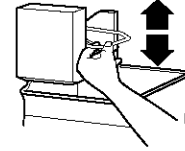

2. Install the interior water filter cartridge (on some models). The interior water filter mounting bracket is located in the upper corner of the fresh food compartment of the refrigerator.

NOTE: Do not use with water that is microbiologically unsafe or of unknown quality without adequate disinfection before or after the system.

- Carefully remove the interior water filter cartridge from its packaging. Remove the red cap from the cartridge.
- Apply the appropriate month sticker to the cartridge as a reminder to replace the cartridge within six months. Then apply the "Water Filter Replacement Reminder" sticker to your calendar.
- Line up the INSTALL mark on the water filter label with the indicator line that is molded into the filter mounting bracket cover. Push the cartridge into the filter mounting bracket. Twist the cartridge $\frac{1}{4}$ turn to the right to lock it into place. The REMOVE mark should be lined up with the indicator line located on the front cover.

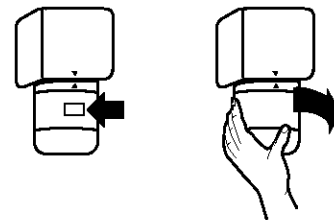

3. Use a sturdy container to depress the water dispenser bar until the water begins to flow. Flush the water system by dispensing and discarding 2 to 3 gal. (8 to 12 L) of water. Cleaning the system will take approximately 6 to 7 minutes and will help clear air from the line. Additional flushing may be required in some households.

NOTE: As air is cleared from the system, water may spurt out of the dispenser.

4. Inspect the filter system for water leaks. If you see water leaks, see the "Troubleshooting" section.

5. Turn on the ice maker by opening the freezer door and lowering the wire shutoff arm as shown. Please refer to the "Ice Maker" section for further instructions on the operation of your ice maker.

- Allow 24 hours to produce the first batch of ice.
- Discard the first three batches of ice produced.
- Depending on your model, you may want to select the maximum ice feature to increase the production of ice.

NOTE: The ice maker and water dispenser feature of this new refrigerator may make sounds that your old refrigerator didn't make. The following describes some of the normal sounds and what may be making them:

- You may hear a buzzing sound when the water valve opens to flow water to the dispenser or to fill the ice maker for each cycle.
- Rattling noises may come from the water line immediately after dispensing water.

Normal Sounds

Your new refrigerator may make sounds that your old one didn't make. Because the sounds are new to you, you might be concerned about them. Most of the new sounds are normal. Hard surfaces, such as the floor, walls, and cabinets, can make the sounds seem louder. The following describes the kinds of sounds and what may be making them.

- If your product is equipped with an ice maker, you will hear a buzzing sound when the water valve opens to fill the ice maker for each cycle.
- Your refrigerator is designed to run more efficiently to keep your food items at the desired temperatures and to minimize energy usage. The high efficiency compressor and fans may cause your refrigerator to run longer than your old one. You may also hear a pulsating or high-pitched sound from the compressor or fans adjusting to optimize performance.
- You may hear the evaporator fan motor circulating air through the refrigerator and freezer compartments. The fan speed may increase as you open the doors or add warm food.
- Rattling noises may come from the flow of refrigerant, the water line, or items stored on top of the refrigerator.
- Water dripping on the defrost heater during a defrost cycle may cause a sizzling sound.
- As each cycle ends, you may hear a gurgling sound due to the refrigerant flowing in your refrigerator.
- Contraction and expansion of the inside walls may cause a popping noise.
- You may hear air being forced over the condenser by the condenser fan.
- You may hear water running into the drain pan during the defrost cycle.

REFRIGERATOR USE

Ensuring Proper Air Circulation

In order to ensure proper temperatures, you need to permit airflow between the refrigerator and freezer sections. As shown in the illustration, cool air enters through the bottom of the freezer section and moves up. Most of the air then flows through the freezer section vents and recirculates under the freezer floor. The rest of the air enters the refrigerator section through the top vent.

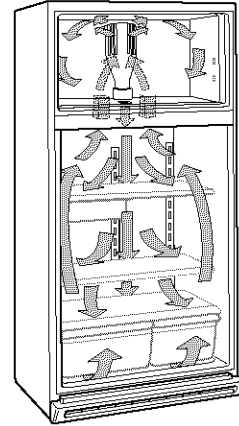

Do not block any of these vents with food packages. If the vents are blocked, airflow will be prevented and temperature and moisture problems may occur.

IMPORTANT: Because air circulates between both sections, any odors formed in one section will transfer to the other. You must thoroughly clean both sections to eliminate odors. To prevent odor transfer and drying out of food, wrap or cover foods tightly.

Using the Control(s)

For your convenience, your refrigerator control(s) are preset at the factory. When you first install your refrigerator, make sure that the control(s) are still preset to the mid-settings as shown.

NOTE: To turn your refrigerator off, turn the refrigerator control to the word OFF or until the word OFF appears. Your product will not cool when the refrigerator control is set to OFF.

Mid-setting "3"

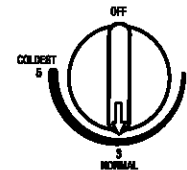

Mid-setting "3"

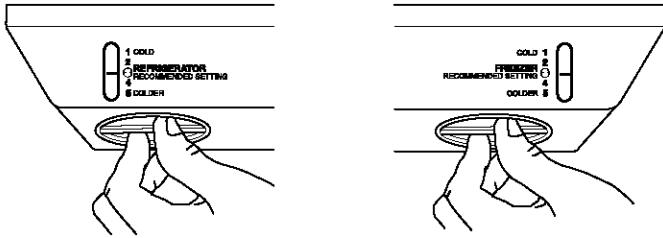

Mid-setting "4"

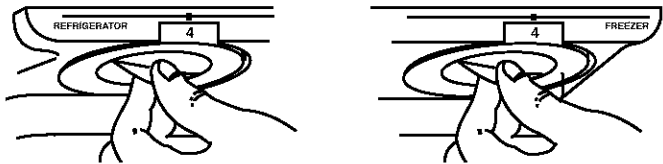

IMPORTANT:

- Give your refrigerator time to cool down completely before adding food. It is best to wait 24 hours before you put food into the refrigerator.
- If you add food before the refrigerator has cooled completely, your food may spoil. Adjusting the Refrigerator and Freezer Controls to a higher (colder) than recommended setting will not cool the compartments any faster.

Adjusting Controls

The mid-setting(s) indicated in the previous section should be correct for normal household usage. The controls are set correctly when milk or juice is as cold as you like and when ice cream is firm.

If the temperature is too warm or too cold in the refrigerator or freezer, first check the air vents to be sure they are not blocked. If you need to adjust temperatures, use the settings listed in the chart below as a guide. On models with two controls, adjust the refrigerator temperature first. Wait at least 24 hours between adjustments and then recheck the temperatures.

CONDITION/REASON:	ADJUSTMENT:
REFRIGERATOR section too warm <ul style="list-style-type: none"> ■ Door opened often, large amount of food added or room temperature very warm 	Adjust REFRIGERATOR or TEMPERATURE Control one setting higher
FREEZER section too warm/ice not made fast enough <ul style="list-style-type: none"> ■ Door opened often, or large amount of food added or very cold room temperature (can't cycle often enough) ■ Heavy ice usage 	Adjust FREEZER or TEMPERATURE Control one setting higher
REFRIGERATOR section too cold <ul style="list-style-type: none"> ■ Controls not set correctly for your conditions 	Adjust REFRIGERATOR or TEMPERATURE Control one setting lower
FREEZER section too cold <ul style="list-style-type: none"> ■ Controls not set correctly for your conditions 	Adjust FREEZER or TEMPERATURE Control one setting lower

Water Dispenser (on some models)

⚠ WARNING



Cut Hazard

Use a sturdy glass when dispensing ice or water.
Failure to do so can result in cuts.

If you did not flush the water system when the refrigerator was first installed, dispense water into a container until you draw and discard 2 to 3 gal. (8 to 12 L) or for approximately 6 to 7 minutes after the water begins dispensing. The water you draw and discard rinses the pipes. Allow several hours for the refrigerator to cool down and chill water.

Dispensing Water

There are two water dispenser buttons as shown for use with different sizes of containers.

1. Press a glass against the back button or hold a container under the dispenser while pressing the front button.
2. Remove the glass or release the front button to stop dispensing.

NOTE: Dispense enough water every week to maintain a fresh supply.

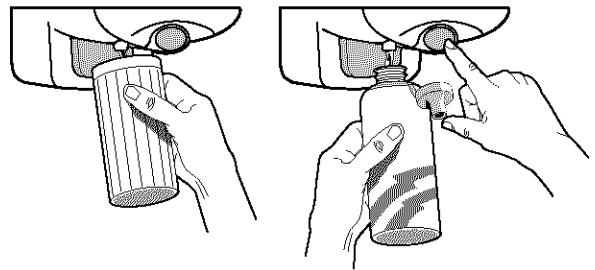

Interior Water Filtration System (on some models)

The water filter status light (on some models)

The water filter status light will help you know when to change your water filter cartridge. The light is located at the top of the refrigerator compartment on the control box. The light will change from green to yellow. This tells you that it is almost time to change the water filter cartridge (90% of the filter life has been used). It is recommended that you replace the water filter cartridge when the water filter indicator light changes to red OR water flow to your water dispenser or ice maker decreases noticeably. (See "Replacing the interior water filter cartridge" later in this section.)

NOTE: Do not use with water that is microbiologically unsafe or of unknown quality without adequate disinfection before or after the system.

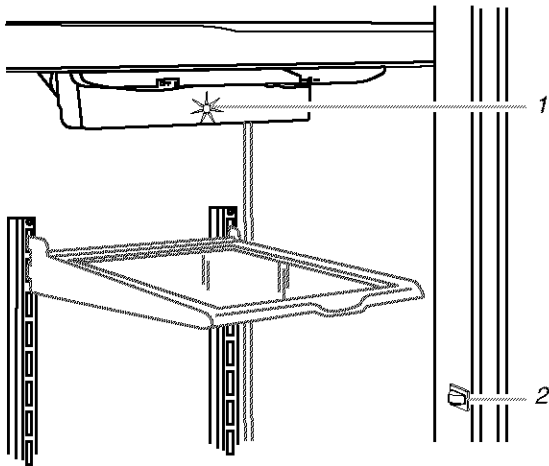

1. Water filter status light
2. Refrigerator light switch

After changing the water filter cartridge, reset the water filter status light by pushing the refrigerator light switch back and forth 5 times within 10 seconds. The status light will change from red to green when the system is reset.

Non-indicator water filter (on some models)

If your refrigerator does not have the water filter status light, you should change the water filter cartridge every 6 to 9 months depending on your usage. If the water flow to the water dispenser or ice maker decreases noticeably before 6 months have passed, replace the water filter cartridge more often.

Replacing the interior water filter cartridge

The interior water filter cartridge is located in the upper corner of the fresh food compartment of the refrigerator.

1. Twist the interior water filter cartridge $\frac{1}{4}$ turn to the left. The **INSTALL** mark will be lined up with the indicator line located on the filter mounting bracket cover.
2. Gently pull down on the cartridge to remove it from the filter mounting bracket assembly. To prevent water from spilling inside the refrigerator, **DO NOT TIP** the cartridge. Dispose of the cartridge.
3. Install the new interior water filter cartridge. You can run the dispenser without a water filter cartridge, but your water will not be filtered.
 - Carefully remove the interior water filter cartridge from its packaging. Remove the red cap from the cartridge.
 - Apply the appropriate month sticker to the cartridge as a reminder to replace the cartridge within six months. Then apply the “Water Filter Replacement Reminder” sticker to your calendar as a reminder to replace the cartridge in six months.

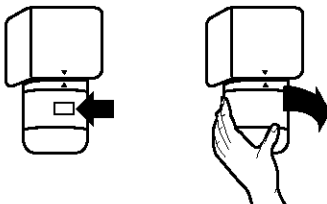

4. Line up the **INSTALL** mark on the water filter label with the indicator line that is molded into the filter mounting bracket cover. Push the cartridge into the filter mounting bracket. Twist the cartridge $\frac{1}{4}$ turn to the right to lock it into place. The **REMOVE** mark should be lined up with the indicator line located on the front cover.

5. Use a sturdy container to depress the water dispenser bar until the water begins to flow. Flush the water system by dispensing and discarding 2 to 3 gal. (8 to 12 L) of water. Cleaning the system will take approximately 6 to 7 minutes and will help clear air from the line. Additional flushing may be required in some households.

NOTE: As air is cleared from the system, water may spurt out of the dispenser.

6. Inspect the filter system for water leaks. If you see water leaks, see the “Troubleshooting” section.

Ice Maker (on some models - Accessory)

Turning the ice maker on/off

NOTE: Do not force the wire shutoff arm up or down.

- To turn the ice maker on, simply lower the wire shutoff arm.

NOTE: Your ice maker has an automatic shutoff. As ice is made, the ice cubes will fill the ice storage bin and the ice cubes will raise the wire shutoff arm to the OFF (arm up) position.

- To manually turn the ice maker off, lift the wire shutoff arm to the OFF (arm up) position and listen for the click to make sure the ice maker will not continue to operate.

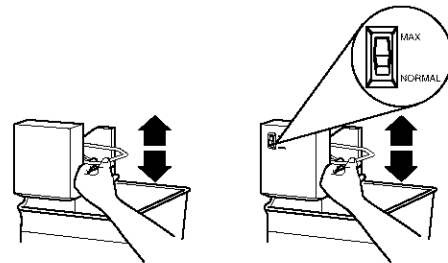

Increasing ice production rate

- **NORMAL Ice Production:** In Normal ice production mode, the ice maker should produce approximately 8 to 12 batches of ice in a 24-hour period. If ice is not being made fast enough, turn the Freezer Control toward a higher (colder) number in half number steps. (For example, if the control is at 3, move it to between 3 and 4.) Wait 24 hours and, if necessary, gradually turn the Freezer Control to the highest setting, waiting 24 hours between each increase.
- **MAXIMUM Ice Production (on some models):** In Maximum ice production, the ice maker should produce approximately 16 to 20 batches of ice in a 24-hour period. If your refrigerator has the maximum ice production feature, push the switch to **MAX**.

REMEMBER:

- Allow 24 hours to produce the first batch of ice. Discard the first three batches of ice produced.
- The quality of your ice will be only as good as the quality of the water supplied to your ice maker. Avoid connecting the ice maker to a softened water supply. Water softener chemicals (such as salt) can damage parts of the ice maker and lead to poor quality ice. If a softened water supply cannot be avoided, make sure the water softener is operating properly and is well maintained.
- Do not store anything on top of the ice maker or in the ice storage bin.

REFRIGERATOR FEATURES

Your model may have some or all of these features. Features that can be purchased separately as product accessories are labeled with the word "Accessory." Not all accessories will fit all models. If you are interested in purchasing one of the accessories, please call the toll-free number on the cover or in the "Assistance or Service" section.

Important information to know about glass shelves and covers:

Do not clean glass shelves or covers with warm water when they are cold. Shelves and covers may break if exposed to sudden temperature changes or impact, such as bumping. For your protection, tempered glass is designed to shatter into many small, pebble-size pieces. This is normal. Glass shelves and covers are heavy. Use special care when removing them to avoid impact from dropping.

Refrigerator Shelves

Your model may have glass or wire shelves. Store similar foods together and adjust the shelves to fit different heights. This reduces the time the refrigerator door is open and saves energy.

Slide-out Shelves (on some models)

To remove and replace a shelf in a metal frame:

1. Pull the shelf forward to the stop. Tilt the front of the shelf up and lift it slightly as you pull the shelf from the frame.
2. Replace the shelf by guiding it back into the slots on the frame and pushing the shelf in past the stop.

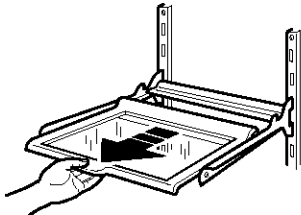

Shelves and Shelf Frames

To remove and replace a shelf/frame:

1. Remove the shelf/frame by tilting it up at the front and lifting it out of the shelf supports.
2. Replace the shelf/frame by guiding the rear shelf hooks into the shelf supports. Tilt the front of the shelf up until rear shelf hooks drop into the shelf supports. Check to make sure that the shelf is securely in position.

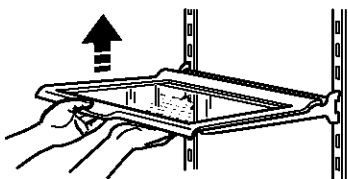

Lateral Adjustable Shelf

(on some models)

To slide the shelf from side to side, lift up on the front of shelf and slide to the desired location. Lower shelf to the level position.

NOTE: You do not have to remove small items from the shelf before moving it from side to side. You may need to remove larger items.

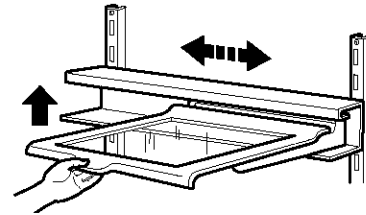

To remove the shelf:

NOTE: The shelf is heavy and must be removed using both hands.

1. Hold the back of the shelf with one hand.
2. Lift the front of the shelf with the other hand to a 45° angle and lower it slightly to release it from the upper channel of the track. Pull the shelf straight out.

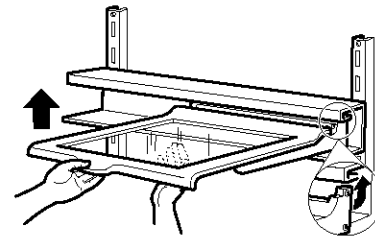

To remove and replace the shelf track:

1. Remove the shelf track by lifting both sides of the track slightly and pulling the track straight out.
2. Replace the track by guiding the track hooks into the shelf support slots on the back wall.

NOTE: Make sure that both sets of track hooks are in the slots and that the slots are parallel with each other.

3. Push the track back and down securely into the shelf supports.

To replace the shelf:

NOTE: Make sure that both of the rear shelf slides are securely in the track before letting go of the shelf. The lateral shelf may be difficult to install if the track is placed too close to the refrigerator ceiling. Reposition the track on a lower rung until the shelf can be tilted enough to easily slide into the track.

1. Hold the shelf at the front and tip the front at a 45° angle to the track.
2. Insert both of the rear shelf slides into the upper channel of the track, and lower the front of the shelf into place.

Crispers and Meat Drawers

(on some models)

Drawers

To remove and replace a drawer:

1. Slide drawer straight out to the stop. Lift the front of the drawer and slide it out the rest of the way.
2. Replace a drawer by sliding it back in fully past the stop.

Crisper Cover

To remove the crisper(s) cover:

1. Remove crisper(s). Hold the glass insert firmly with one hand and press up in the center of the glass insert until it rises above the plastic frame. Carefully slide the glass insert forward to remove.
2. Lift the cover frame and remove it.

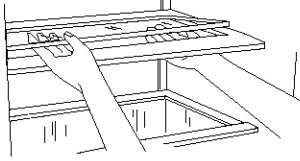

To replace the crisper cover:

NOTE: Before reinstalling the cover, make sure the U-shaped reinforcement bar is reinstalled in the front edge of the crisper cover.

1. Fit back of cover frame into supports on side walls of the refrigerator and lower the front of the cover frame into place.
2. Slide rear of glass insert into cover frame and lower front into place.

Meat Drawer Cover

To remove and replace the meat drawer cover (Style 1 glass):

1. Remove the meat drawer. Tilt up the front of the cover and lift at the back. Pull the cover straight out.
2. Replace the cover by guiding the rear hooks into the shelf supports. Tilt the cover up at the front until the rear hooks drop into the slots. Lower the front of the cover to a level position and replace the meat drawer.

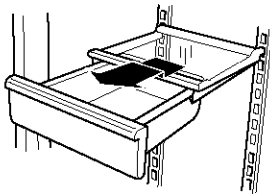

To remove and replace the meat drawer cover (Style 2 plastic):

1. Remove the meat drawer. Tilt the cover up at the front and pull it forward and out.
2. Replace the meat drawer cover by fitting the notches and rear edge of the cover over rear and center crossbars on the shelf. Lower cover into place and replace the meat drawer.

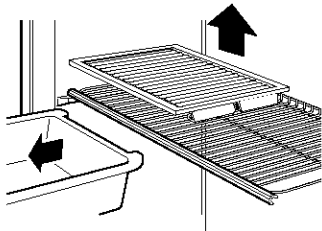

Crisper Humidity Control (on some models)

You can adjust the amount of humidity in the moisture-sealed crisper using the settings between HIGH and LOW.

LOW (open) lets moist air out of the crisper for best storage of fruits and vegetables with skins.

- Fruit: Wash, let dry and store in refrigerator in plastic bag in crisper. Do not wash or hull berries until they are ready to use. Sort and keep berries in original container in crisper.
 - Vegetables with skins: Place in plastic bag or plastic container and store in crisper.
- HIGH (closed) keeps moist air in the crisper for best storage of fresh, leafy vegetables.
- Leafy vegetables: Wash in cold water, drain and trim or tear off bruised and discolored areas. Place in plastic bag or plastic container and store in crisper.

Humidity Control Location

- Humidity Control on crisper drawer (Style 1 - on left/Style 2 - on right)

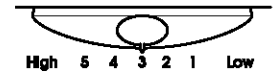
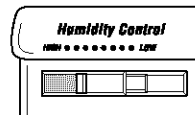

Chilled Meat Drawer (on some models)

Slide the meat drawer temperature control forward to make the meat drawer less cold or backward to make the drawer more cold.

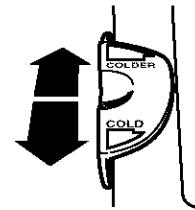

Meat Storage Guide

Store most meat in original wrapping as long as it is airtight and moisture-proof. Rewrap if necessary. See the following chart for storage times. When storing meat longer than the times given, freeze the meat.

Fresh fish or shellfish	use same day as purchased
Chicken, ground beef, variety meats (liver).....	1-2 days
Cold cuts, steaks/roasts	3-5 days
Cured meats	7-10 days
Leftovers - Cover leftovers with plastic wrap, aluminum foil, or plastic containers with tight lids.	

Wine or Can/Bottle Rack (on some models - Accessory)

To remove and replace the wine rack (left) or can/bottle rack (right):

1. Remove the rack by pulling it straight out from the shelf.
2. Replace the rack by sliding it in between the shelf and the wall of the refrigerator.

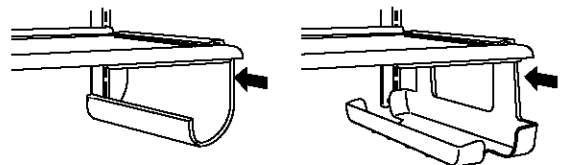

Utility or Egg Bin

(on some models - Accessory)

Depending on your model, you may have a one, two or three piece bin. Eggs may be stored in the egg tray or loose in the bin.

NOTE: Store eggs in a covered container for long-term storage. If your model does not have an egg storage bin, store eggs in their original carton on an interior shelf.

FREEZER FEATURES

Your model may have some or all of these features. Features that can be purchased separately as product accessories are labeled with the word "Accessory." Not all accessories will fit all models. If you are interested in purchasing one of the accessories, please call the toll-free number on the cover or in the "Assistance or Service" section.

Freezer Shelf

(on some models)

To remove and replace the shelf:

1. Remove the shelf by lifting the entire shelf slightly and move it all the way to one side. Tilt the other side up and out of the shelf supports.
2. Replace the shelf by inserting one end all the way into the center of the shelf supports. Then, lower the other end of the shelf and insert it into the shelf supports.

NOTE: The shelf should lower slightly and lock into place. If the shelf does not appear stable, make sure both ends of the shelf are inserted into the shelf supports.

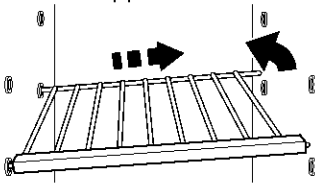

Frozen Food Storage Guide

Storage times will vary according to the quality and type of food, the type of packaging or wrap used (should be airtight and moisture-proof), and the storage temperature. Seal the package or container securely to prevent taste and odor transfer throughout the product. Ice crystals inside a sealed package are normal.

Put no more unfrozen food into the freezer than will freeze within 24 hours (no more than 2 to 3 lbs. of food per cubic foot [907-1,350 g per L] of freezer space). Leave enough space in the freezer for air to circulate around packages. The freezer door must close tightly. For more information on preparing food for freezing, check a freezer guide or reliable cookbook.

Adjustable Half-width Freezer Shelf

(on some models)

To remove and replace the shelf:

1. Remove the shelf by lifting the shelf up and pulling straight out.
2. Replace the shelf over the supports and lower it into place.

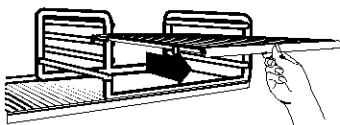

Pull-out Freezer Floor

(on some models)

To remove and replace the freezer floor:

1. Lift both back "fences" up and out.
2. Remove the freezer floor by pulling it out about 1 in. (2.5 cm) with one hand around the air tower section (center back) and one hand at center front.
3. Lift up floor at rear until hooks release from cabinet and pull the floor out the rest of the way.
4. Replace the freezer floor by sliding the floor straight in until the hooks drop into place at rear of cabinet.
5. Replace "fences" by aligning pins with socket in the floor, and pushing down until they snap into place.

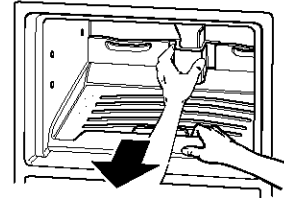

DOOR FEATURES

Your model may have some or all of these features. Features that can be purchased separately as product accessories are labeled with the word "Accessory." Not all accessories will fit all models. If you are interested in purchasing one of the accessories, please call the toll-free number on the cover or in the "Assistance or Service" section.

Door Rails

The door rails may be removed for easier cleaning.

Snap-on Door Rails

To remove and replace the rails:

1. Remove the rails by pushing in slightly on the front of the bracket while pulling out on the inside tab. Repeat these steps for the other end of the rail.
2. Replace the rails by aligning the ends of the brackets with the buttons on the sides of the door liner. Firmly snap bracket and rail assembly onto the tabs above the shelf as shown.

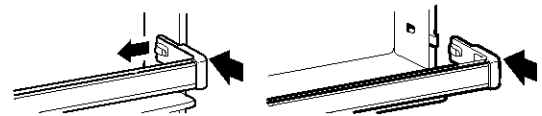

Drop-in Door Rails

To remove and replace the rails:

1. Remove the rails by pulling straight up on each end of the rail.
2. Replace the rails by sliding the shelf rail into the slots on the door and pushing the rail straight down until it stops.

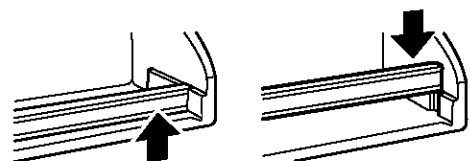

Can Racks and Door Bins

(on some models)

NOTE: Can racks may be purchased as an Accessory for some models.

To remove and replace the racks/bins:

1. Remove the rack/bin by lifting it and pulling it straight out.
2. Replace the rack/bin by sliding it in above the desired support and pushing it down until it stops.

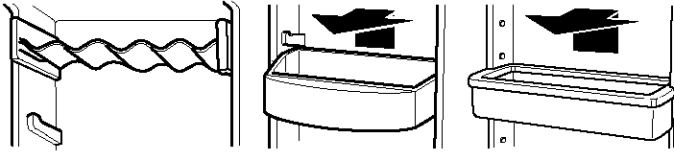

Adjustable Utility Compartment & Tray

(on some models)

The utility compartment and tray slide from one side to the other for more flexible storage. The tray fits on either side of the utility compartment or partially underneath it. Try moving it to different positions to find the option that works best for you.

To install and adjust the utility compartment and tray:

1. Insert the front of the utility tray into the slot on the back of the shelf rail. Lower the back of the tray into position.
2. Place the front of the utility compartment on top of the shelf rail. Lower the back of the compartment onto the ribs on the refrigerator door.

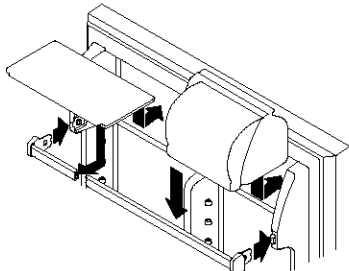

3. Adjust the utility compartment by lifting the front slightly and sliding it to the desired position. Lower the front to lock it into place.

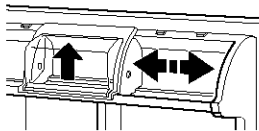

Flip-up Door Shelf

(on some models)

The shelf bottom flips up so you can store taller items in the door shelf below. When in the down position, the shelf is strong enough to hold up to 10 lbs. (4.5 kg).

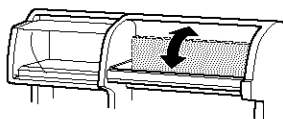

REFRIGERATOR CARE

Cleaning

⚠ WARNING



Explosion Hazard

Use nonflammable cleaner.

Failure to do so can result in death, explosion, or fire.

Both the refrigerator and freezer sections defrost automatically. However, clean both sections about once a month to prevent odors from building up. Wipe up spills immediately.

Cleaning your refrigerator

1. Unplug refrigerator or disconnect power.
2. Remove all removable parts from inside, such as shelves, crispers, etc.
3. Hand wash, rinse, and dry removable parts and interior surfaces thoroughly. Use a clean sponge or soft cloth and a mild detergent in warm water.
 - Do not use abrasive or harsh cleaners such as window sprays, scouring cleansers, flammable fluids, cleaning waxes, concentrated detergents, bleaches or cleansers containing petroleum products on plastic parts, interior and door liners or gaskets. Do not use paper towels, scouring pads, or other harsh cleaning tools. These can scratch or damage materials.
 - To help remove odors, you can wash interior walls with a mixture of warm water and baking soda (2 tbs. to 1 qt. [26 g to .95 L] of water).
4. Wash stainless steel and painted metal exteriors with a clean sponge or soft cloth and a mild detergent in warm water. Do not use abrasive or harsh cleaners. Dry thoroughly with a soft cloth. For additional protection against damage to painted metal exteriors, apply appliance wax (or auto paste wax) with a clean, soft cloth. Do not wax plastic parts.

NOTE: To keep your Stainless Steel refrigerator looking like new and to remove minor scuffs or marks, it is suggested that you use the manufacturer's approved Stainless Steel Cleaner & Polish.

IMPORTANT: This cleaner is for Stainless Steel parts only!

Do not allow the Stainless Steel Cleaner & Polish to come into contact with any plastic parts such as the trim pieces, dispenser covers or door gaskets. If accidental contact does occur, clean plastic part with a sponge and mild detergent in warm water. Dry thoroughly with a soft cloth. To order the cleaner, see the "Accessories" section.

5. There is no need for routine condenser cleaning in normal home operating environments. If the environment is particularly greasy or dusty, or there is significant pet traffic in the home, the condenser should be cleaned every two to three months to ensure maximum efficiency.

If you need to clean the condenser:

- Remove the base grille (see “Base Grille” or “Door Removal” section).
 - Use a vacuum with a soft brush to clean the grille, the open areas behind the grille and the front surface area of the condenser.
 - Replace the base grille when finished.
6. Plug in refrigerator or reconnect power.

Changing the Light Bulbs

NOTE: Not all appliance bulbs will fit your refrigerator. Be sure to replace the bulb with one of the same size, shape, and wattage.

1. Unplug refrigerator or disconnect power.
2. Remove the bulb from behind the control panel in the refrigerator or from behind the light shield in the freezer (on some models). Replace it with an appliance bulb of the same wattage.
3. Plug in refrigerator or reconnect power.

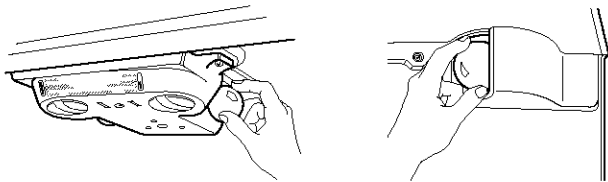

Power Interruptions

If the power will be out for 24 hours or less, keep both refrigerator doors closed to help food stay cold and frozen.

If the power will be out for more than 24 hours, do one of the following:

- Remove all frozen food and store it in a frozen food locker.
- Place 2 lbs. (907 g) of dry ice in the freezer for every cubic foot (28 L) of freezer space. This will keep the food frozen for two to four days.
- If neither a food locker nor dry ice is available, consume or can perishable food at once.

REMEMBER: A full freezer stays cold longer than a partially filled one. A freezer full of meat stays cold longer than a freezer full of baked goods. If you see that food contains ice crystals, it may be refrozen, although the quality and flavor may be affected. If the condition of the food is poor, dispose of it.

Vacation and Moving Care

Vacations

If you choose to leave the refrigerator on while you're away:

1. Use up any perishables and freeze other items.
2. If your refrigerator has an automatic ice maker:
 - Raise wire shutoff arm to OFF (up) position or move the switch to the OFF (right) setting.
 - Shut off water supply to the ice maker.
3. Empty the ice bin.

If you choose to turn the refrigerator off before you leave:

1. Remove all food from the refrigerator.
2. If your refrigerator has an automatic ice maker:
 - Turn off the water supply to the ice maker at least one day ahead of time.
 - When the last load of ice drops, raise the wire shutoff arm to the OFF (up) position or move the switch to the OFF (right) setting.
3. Depending on your model, turn the Thermostat Control or Refrigerator Control to OFF. See the “Using the Control(s)” section.
4. Clean refrigerator, wipe it, and dry well.
5. Tape rubber or wood blocks to the tops of both doors to prop them open far enough for air to get in. This stops odor and mold from building up.

Moving

When you are moving your refrigerator to a new home, follow these steps to prepare it for the move.

1. If your refrigerator has an automatic ice maker:
 - Turn off the water supply to the ice maker at least one day ahead of time.
 - Disconnect the water line from the back of the refrigerator.
 - When the last load of ice drops, raise the wire shutoff arm to the OFF (up) position or move the switch to the OFF (right) setting.
2. Remove all food from the refrigerator and pack all frozen food in dry ice.
3. Empty the ice bin.
4. Depending on your model, turn the Thermostat Control or Refrigerator Control to OFF. See the “Using the Control(s)” section.
5. Unplug the refrigerator.
6. Empty water from the defrost pan.
7. Clean, wipe, and dry thoroughly.
8. Take out all removable parts, wrap them well, and tape them together so they don't shift and rattle during the move.
9. Depending on the model, raise the front of the refrigerator so it rolls more easily OR screw in the leveling legs so they don't scrape the floor. See the “Door Closing” or “Leveling Your Refrigerator” section.
10. Tape the doors shut and the power cord to the refrigerator cabinet.

When you get to your new home, put everything back and refer to the “Refrigerator Installation” section for preparation instructions. Also, if your refrigerator has an automatic ice maker, remember to reconnect the water supply to the refrigerator.

TROUBLESHOOTING

Try the solutions suggested here first in order to avoid the cost of an unnecessary service call.

Your refrigerator will not operate

- **Is the power cord unplugged?** Plug into a grounded 3 prong outlet.
- **Has a household fuse or circuit breaker tripped?** Replace the fuse or reset the circuit breaker.
- **Is the Refrigerator Control turned to the OFF position?** See the "Using the Control(s)" section.
- **Is the refrigerator defrosting?** Recheck to see if the refrigerator is operating in 30 minutes. Your refrigerator will regularly run an automatic defrost cycle.

The lights do not work

- **Is the power cord unplugged?** Plug into a grounded 3 prong outlet.
- **Is a light bulb loose in the socket or burned out?** See the "Changing the Light Bulb(s)" section.

There is water in the defrost drain pan

- **Is the refrigerator defrosting?** The water will evaporate. It is normal for water to drip into the defrost pan.
- **Is it more humid than normal?** When it is humid, expect that the water in the defrost pan will take longer to evaporate.

The motor seems to run too much

- **Is the room temperature hotter than normal?** The motor will run longer under warm conditions. At normal room temperatures, your motor will run about 40% to 80% of the time. Under warmer conditions, it will run even more.
- **Has a large amount of food just been added to the refrigerator?** Adding a large amount of food warms the refrigerator. The motor normally will run longer to cool the refrigerator back down.
- **Are the doors opened often?** The motor will run longer when this occurs. Conserve energy by getting all items out at one time, keeping food organized, and closing the door as soon as possible.
- **Is the control set correctly for the surrounding conditions?** See the "Using the Control(s)" section.
- **Are the doors closed completely?** Close the doors firmly. If they do not close completely, see "The doors will not close completely" later in this section.
- **Are the condenser coils dirty?** This prevents air transfer and makes the motor work harder. Clean the condenser coils. See the "Cleaning" section.

NOTE: Your new refrigerator will run longer than your old one due to its high-efficiency motor.

The refrigerator seems to make too much noise

- **The sounds may be normal for your refrigerator.** See the "Normal Sounds" section.

The ice maker is not producing ice or not enough ice.

- **Has the ice maker just been installed?** Wait 72 hours for full ice production to begin. Once your refrigerator is cooled, the ice maker should produce 70-120 cubes every 24 hours.
 - **Is the freezer temperature cold enough to produce ice?** Wait 24 hours after hook-up for ice production. See the "Using the Control(s)" section.
 - **Is the wire shutoff arm in the OFF (arm up) position?** Lower the wire shutoff arm to the ON (arm down) position. See the "Ice Maker" section.
 - **Is the water line shutoff valve to the refrigerator turned on?** Turn on the water valve. See the "Water Supply Connection" section.
 - **Does the ice maker mold have water in it or has no ice been produced?** Be sure your refrigerator has been connected to a water supply and the supply shutoff valve is turned on. See the "Water Supply Connection" section.
 - **Is an ice cube jammed in the ejector arm?** Remove the ice from the ejector arm with a plastic utensil. See the "Ice Maker" section.
 - **Has a large amount of ice just been removed?** Allow 24 hours for ice maker to produce more ice.
 - **Is the control set correctly?** If too little ice is produced, see the "Using the Control(s)" section.
 - **Is there a water filter installed on the refrigerator?** The filter may be full or incorrectly installed. Depending on your model, remove the water filter cartridge (see the "Interior Water Filtration System" section). Operate the dispenser. If the water flow increases noticeably, your filter is full and needs to be replaced.
- NOTE:** If not due to any of the above, there may be a problem with the water line. Call for service.

Off-taste, odor or gray color in the ice

- **Are the plumbing connections new, causing discolored or off-flavored ice?** Discard the first few batches of ice.
- **Have the ice cubes been stored too long?** Throw old ice away and make a new supply.
- **Has food in the refrigerator been wrapped properly?** See the "Refrigerator Features" section.
- **Do the freezer and ice bin need to be cleaned?** See the "Cleaning" section.
- **Does the water contain minerals (such as sulfur)?** A filter may need to be installed to remove the minerals.
- **Is there a water filter installed on the refrigerator?** Gray or dark discoloration in ice indicates that the water filtration system needs additional flushing. Run additional water through the water dispenser to flush the water filtration system more thoroughly, at least 2 to 3 gal. (8 to 12 L) or 6 to 7 minutes initially. Discard discolored ice.

The water dispenser will not operate properly

- **Has the water system not filled?** The water system needs to be filled the first time it is used. Use a sturdy container to depress the water dispenser until water begins to flow. Dispense and discard 2 to 3 gal. (8 to 12 L) of water. This will take approximately 6 to 7 minutes and will help clear air from the line. Additional flushing may be required in some households. See the "Water Dispenser" section.

- **Is the water shutoff valve not turned on or the water line connected at the source?** Be sure the water shutoff valve is turned on and the water source is connected to the refrigerator. See the “Water Supply Connection” section.
- **Is the water shutoff valve clogged or incorrectly installed?** See the “Water Supply Connection” section. If clogging or installation is not a problem, call for service or contact a plumber.
- **Is there a kink in the home water source line?** If you find or suspect a kink in the water line, call for service.

Water flow from the dispenser decreases noticeably

- **Is there a water filter installed on the refrigerator?** The filter may be full or incorrectly installed. Depending on your model, remove the water filter cartridge (see the “Interior Water Filtration System” section). Operate the dispenser. If the water flow increases noticeably, your filter is full and needs to be replaced.

Water leaking from the dispenser

- **Is the glass not being held under the water dispenser long enough?** Hold the container under the water dispenser two to three seconds after releasing the dispenser lever. Water may continue to dispense during this time.
- **Is there a water filter installed on the refrigerator?** The water filtration system may have air in the lines, causing water to drip. Additional flushing may help clear air from the lines. Normal dispenser use should flush air from the lines within 24 to 72 hours.

The dispenser water is not cool enough

- **Has the refrigerator been newly installed?** Allow 24 hours for the refrigerator to cool completely.
- **Has a large amount of water been recently dispensed?** Allow 24 hours for the water to cool completely.
- **Has water not been recently dispensed?** The first glass of water may not be cool. Discard the first glass of water.

The divider between the two compartments is warm

The warmth is probably due to normal operation of the automatic exterior moisture control.

Temperature is too warm

- **Are the air vents blocked in either compartment?** This prevents cold air movement between the compartments. Move objects away from the air vents. See the “Ensuring Proper Air Circulation” section for air vent locations.
- **Are the door(s) opened often?** The refrigerator will warm when this occurs. Keep the refrigerator cool by getting all items out at one time, keeping food organized, and closing the door as soon as possible.
- **Has a large amount of food just been added to the refrigerator or freezer?** Adding a large amount of food warms the refrigerator. It can take several hours for the refrigerator to return to the normal temperature.
- **Are the controls set correctly for the surrounding conditions?** See the “Using the Control(s)” section.

There is interior moisture buildup

- **Are the air vents blocked in the refrigerator?** Remove any objects from in front of the air vents. See the “Ensuring Proper Air Circulation” section for air vent locations.
- **Are the door(s) opened often?** Avoid humidity buildup by getting all items out at one time, keeping food organized, and closing the door as soon as possible.
- **Is the room humid?** It is normal for moisture to build up inside the refrigerator when the room air is humid.
- **Is the food packaged correctly?** Check that all food is securely wrapped. Wipe off damp food containers before placing them in the refrigerator.
- **Is the control set correctly for the surrounding conditions?** See the “Using the Control(s)” section.
- **Was a self-defrost cycle completed?** It is normal for droplets to form after the refrigerator self-defrosts.

The doors are difficult to open

- **Are the gaskets dirty or sticky?** Clean gaskets and the surface that they touch. Rub a thin coat of paraffin wax on the gaskets following cleaning.

The doors will not close completely

- **Are food packages blocking the door open?** Rearrange containers so that they fit more tightly.
- **Is the ice bin out of position?** Push the ice bin in all the way.
- **Are the crisper cover, pans, shelves, bins, or baskets out of position?** Put these items into their correct positions. See the “Refrigerator Features” section for more information.
- **Are the gaskets sticking?** Clean gaskets and the surface that they touch. Rub a thin coat of paraffin wax on the gaskets following cleaning.
- **Does the refrigerator wobble or seem unstable?** Level the refrigerator. See the “Door Closing and Alignment” section.
- **Were the doors removed during product installation and not properly replaced?** Remove and replace the doors according to the “Refrigerator Doors” section, or call a qualified service technician.

PROTECTION AGREEMENTS

In the U.S.A.

Master Protection Agreements

Congratulations on making a smart purchase. Your new Kenmore® appliance is designed and manufactured for years of dependable operation. But like all products, it may require preventive maintenance or repair from time to time. That's when having a Master Protection Agreement can save you money and aggravation.

Purchase a Master Protection Agreement now and protect yourself from unexpected hassle and expense.

The Master Protection Agreement also helps extend the life of your new appliance. Here's what's included in the Agreement:

- ✓ **Expert service** by our 12,000 professional repair specialists
- ✓ **Unlimited service and no charge** for parts and labor on all covered repairs
- ✓ **"No-lemon" guarantee** – replacement of your covered product if more than three product failures occur within twelve months
- ✓ **Product replacement** if your covered product can't be fixed
- ✓ **Annual Preventive Maintenance Check** at your request – no extra charge
- ✓ **Fast help by phone** – non-technical and instructional assistance on products repaired in your home, plus convenient repair scheduling
- ✓ **Power surge protection** against electrical damage due to power fluctuations
- ✓ **Rental reimbursement** if repair of your covered product takes longer than promised

Once you purchase the Agreement, a simple phone call is all that it takes for you to schedule service. You can call anytime day or night, or schedule a service appointment online.

Sears has over 12,000 professional repair specialists, who have access to over 4.5 million quality parts and accessories. That's the kind of professionalism you can count on to help prolong the life of your new purchase for years to come. Purchase your Master Protection Agreement today!

Some limitations and exclusions apply. For prices and information call **1-800-827-6655**.

Sears Installation Service

For Sears guaranteed professional installation of home appliances and items like garage door openers and water heaters, in the U.S.A. call **1-800-4-MY-HOME®**.

In Canada

Maintenance Agreements

Your purchase has added value because you can depend on Sears HomeCentral® for service. With over 2,400 Service Technicians and access to over 900,000 parts and accessories, we have the tools, parts, knowledge and skills to back our pledge: We Service What We Sell.

Your Kenmore® appliance is designed, manufactured and tested to provide years of dependable operation. Yet any major appliance may require service from time to time. The Sears Maintenance Agreement offers you an outstanding service program, affordably priced.

The Sears Maintenance Agreement

- Guarantees tomorrow's service at today's price.
- Eliminates repair bills resulting from normal wear and tear.
- Covers non-technical and instructional service calls.
- Provides an annual Preventive Maintenance Check, at your request, to ensure that your appliance is in proper running condition.

Some limitations apply. For information concerning Sears Home Central® Maintenance Agreements, call **1-800-361-6665**.

Accessories

Replacement Parts

To order stainless steel cleaner or replacement filters, please call **1-800-4-MY-HOME®** and ask for the appropriate part number listed below or contact your authorized Kenmore dealer.

Stainless Steel Cleaner & Polish:

Order Part #D22 M40083 R

Interior water filter cartridge:

NOTE: Do not use with water that is microbiologically unsafe or of unknown quality without adequate disinfection before or after the system.

Cyst Cartridge:

Order Part #9002 (NLCS200)

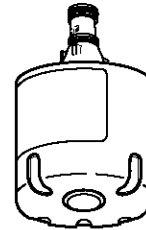

WATER FILTER CERTIFICATIONS

State of California
Department of Health Services
Water Treatment Device
Certificate Number
99-1410

Date Issued: December 14, 1999

Trademark/Model Designation
WF1-NLCS200

Replacement Elements
NLCS200

Manufacturer: Sears Roebuck and Company

The water treatment device(s) listed on this certificate have met the testing requirements pursuant to Section 116830 of the Health and Safety Code for the following health related contaminants:

Microbiological Contaminants and Turbidity

Cysts (protozoan)
Turbidity

Inorganic/Radiological Contaminants

Lead

Organic Contaminants

None

Rated Service Capacity: 200 gallons

Rated Service Flow: 0.5 gpm

Do not use where water is microbiologically unsafe or with water of unknown quality, except that systems claiming cyst reduction may be used on water containing cysts.

PRODUCT DATA SHEETS

Cyst Interior Water Filtration System Model WFI-NLCS200/NLCS200



Tested and certified by NSF International against ANSI/NSF Standard 42 for the reduction of Chlorine (Class I) Taste and Odor and against ANSI/NSF Standard 53 for the reduction of Lead, Cysts and Turbidity.

Capacity: 200 gallons (757 liters),
Service flow rate: 0.5 GPM (1.89 L/min.) @ 60 psi.

Substance Reduction	U.S. EPA MCL	Average Influent	Maximum Effluent	Average Effluent	Minimum % Reduction	Average % Reduction	NSF Test Number
Aesthetic Effects							
Chlorine Taste/Odor	N/A	1.9 mg/L	N/A	0.06 mg/L	N/A	97%	994707
Particulate	N/A	108,667/mL*	N/A	45/mL	N/A	99.96%	994711
Contaminant Reduction	U.S. EPA MCL	Average Influent	Maximum Effluent	Average Effluent	Minimum % Reduction	Average % Reduction	NSF Test Number
Cyst	99.95%**	157,750/mL	55/mL	1.0/mL	99.9987%	99.9996%	994710
Turbidity	N/A	26 NTU	0.5 NTU	0.1 NTU	98.9%	99.5%	994710
Lead: @ pH 6.5	0.015 mg/L	0.160 mg/L***	0.011 mg/L	0.001 mg/L	93.5%	99.4%	994708
Lead: @ pH 8.5	0.015 mg/L	0.158 mg/L***	0.011 mg/L	0.001 mg/L	92.1%	99.3%	994709

- It is essential that operational, maintenance, and filter replacement requirements be carried out for this product to perform as advertised.
- Model NLCS200** Change the cartridge at least every 6-9 months. Use replacement cartridge NLCS200, part# 9002. 2002 suggested retail price of \$39.95 U.S.A./\$49.95 Canada. Prices are subject to change without notice.
- The product is for cold water use only.
- Do not use with water that is microbiologically unsafe or of unknown quality without adequate disinfection before or after the system. Systems certified for cyst reduction may be used on disinfected water that may contain filterable cysts.**
- Refer to the front cover or "Assistance or Service" section for the Manufacturer's name, address and telephone number.
- Refer to the "Warranty" section for the Manufacturer's limited warranty.

Application Guidelines/Water Supply Parameters

Water Supply	City or Well
Water Pressure	30 - 120 psi (207 - 827 kPa)
Water Temperature	33° - 100°F (0.6° - 37.8° C)

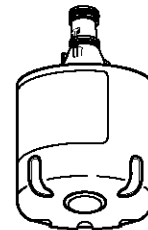

* Test requirement is at least 100,000 particles/ml of AC Fine Test Dust.

** Cyst performance is % reduction based on NSF Standard 53.

*** Test requirement is 0.15 mg/L ± 10%. These contaminants are not necessarily in your water supply. Performance may vary based on local water conditions.

Get it fixed, at your home or ours!

Your Home

For repair—in your home—of all major brand appliances, lawn and garden equipment, or heating and cooling systems, **no matter who made it, no matter who sold it!**

For the replacement parts, accessories and owner's manuals that you need to do-it-yourself.

For Sears professional installation of home appliances and items like garage door openers and water heaters.

1-800-4-MY-HOME® (1-800-469-4663)

Call anytime, day or night (U.S.A. and Canada)

www.sears.com www.sears.ca

Our Home

For repair of carry-in items like vacuums, lawn equipment, and electronics, call or go on-line for the location of your nearest **Sears Parts & Repair Center.**

1-800-488-1222

Call anytime, day or night (U.S.A. only)

www.sears.com

To purchase a protection agreement (U.S.A.) or maintenance agreement (Canada) on a product serviced by Sears:

1-800-827-6655 (U.S.A.)

1-800-361-6665 (Canada)

Para pedir servicio de reparación a domicilio, y para ordenar piezas:

1-888-SU-HOGARSM

(1-888-784-6427)

Au Canada pour service en français:

1-800-LE-FOYER^{MC}

(1-800-533-6937)

www.sears.ca

SEARS