

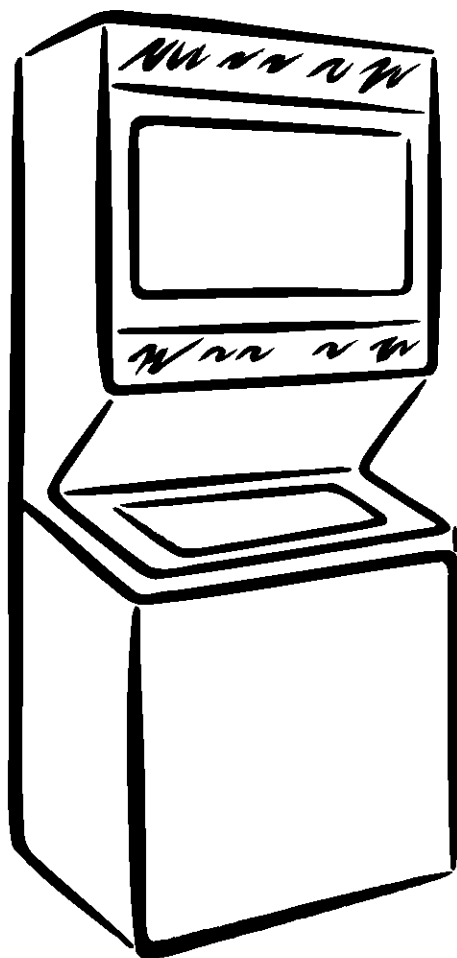

**24-Inch Wide/120-Volt
LAUNDRY CENTER**
Washer - Electric Dryer
Use and Care Guide

CENTRO DE LAVANDERÍA
de 24 pulg. (61 cm) de ancho/120-Voltios
Lavadora - Secadora eléctrica
Manual de Uso y Cuidado



ENGLISH ESPAÑOL

TABLE OF CONTENTS

WE SERVICE WHAT WE SELL	3
WARRANTY	3
WASHER/DRYER SAFETY	4
INSTALLATION INSTRUCTIONS	5
Tools and Parts	5
Alternate Parts.....	5
Location Requirements	5
Drain System.....	6
Electrical Requirements	7
Venting Requirements.....	8
Install Leveling Legs.....	8
Remove Foam Packing.....	8
Connect Drain Hose.....	9
Connect Inlet Hoses.....	9
Secure Drain Hose	10
Plan Vent System.....	10
Install Vent System.....	12
Level Laundry Center	12
Connect Vent.....	12
Complete Installation	13
FEATURES AND BENEFITS	13
DUAL-ACTION™ Plus Agitator.....	13
Porcelain Wash Basket	13
4-way Venting	13
WASHER USE	14
Starting Your Washer	14
Cycles.....	15
Rinse and Spin	15
Drain and Spin.....	15
Understanding Washer Cycles	16
Normal Sounds	16
LAUNDRY TIPS	16
Loading.....	16
DRYER USE	17
Starting Your Dryer.....	17
Stopping and Restarting	17
Loading.....	18
Drying, Cycle and Temperature Tips	18
Cycles.....	18
LAUNDRY CENTER CARE	19
Cleaning Your Washer	19
Water Inlet Hoses.....	19
Cleaning the Lint Screen.....	19
Cleaning the Dryer Interior.....	20
Removing Accumulated Lint.....	20
Vacation, Storage, and Moving Care.....	20
TROUBLESHOOTING WASHER	21
TROUBLESHOOTING DRYER	23

WE SERVICE WHAT WE SELL

Your purchase has added value because you can depend on Sears HomeCentral® for service. With over 12,000 trained repair specialists and access to over 4.2 million parts and accessories, we have the tools, parts, knowledge and skills to ensure our pledge: We Service What We Sell.

Sears Maintenance Agreements

Your Kenmore® appliance is designed, manufactured and tested to provide years of dependable operation. Yet any major appliance may require service from time to time. The Sears Maintenance Agreement offers you an outstanding service program, affordably priced.

The Sears Maintenance Agreement

- Is your way to buy tomorrow's service at today's price.
- Eliminates repair bills resulting from normal wear and tear.
- Provides for non-technical and instructional assistance.
- Even if you don't need repairs, provides an annual Preventive Maintenance Check, at your request, to ensure that your appliance is in proper running condition.

Some limitations apply. For more information, call 1-800-827-6655.

WARRANTY

Full One-Year Warranty on mechanical and electrical parts

For one year from the date of purchase, when this laundry center is installed and operated according to the instructions provided in this Use and Care Guide, Sears will repair this laundry center, free of charge, if defective in material or workmanship.

NOTE: Exhausting your laundry center with a plastic vent can void this warranty. See "Installation Instructions" for the complete exhaust requirements for this laundry center.

Limited Five-Year Warranty on Gearcase Parts

For the second through fifth years from the date of purchase, Sears will replace any gearcase parts that are defective in material or workmanship. You will be charged for labor after the first year.

Limited Ten-Year Warranty on Plastic Tub

For the second through tenth years from the date of purchase, Sears will replace the plastic tub if defective in material or workmanship. You will be charged for labor after the first year.

Warranty Restriction

If the laundry center is subject to other than private family use, the above warranty coverage is effective for only 90 days.

Warranty Service

Warranty service is available by contacting the nearest Sears Service Center. This warranty applies only while the product is in use in the United States.

This warranty gives you specific legal rights and you may also have other rights which vary from state to state.

For Sears warranty information or to contact a Sears Service Center, please reference the service numbers located on the back page of this manual.

**Sears, Roebuck and Co.
D/817WA, Hoffman Estates, IL 60179**

Product Record

In the space below, record your complete model number, serial number, and purchase date. You can find this information on the model and serial number label, located at the top inside dryer door well.

Have this information available to help you quickly obtain assistance or service when you contact Sears concerning your appliance.

Model number _____

Serial number _____

Purchase date _____

Save these instructions and your sales receipt for future reference.

WASHER/DRYER SAFETY

Your safety and the safety of others are very important.

We have provided many important safety messages in this manual and on your appliance. Always read and obey all safety messages.



This is the safety alert symbol.

This symbol alerts you to potential hazards that can kill or hurt you and others.

All safety messages will follow the safety alert symbol and either the word "DANGER" or "WARNING." These words mean:

! DANGER

You can be killed or seriously injured if you don't immediately follow instructions.

! WARNING

You can be killed or seriously injured if you don't follow instructions.

All safety messages will tell you what the potential hazard is, tell you how to reduce the chance of injury, and tell you what can happen if the instructions are not followed.

IMPORTANT SAFETY INSTRUCTIONS

WARNING: To reduce the risk of fire, electric shock, or injury to persons when using the washer/dryer, follow basic precautions, including the following:

- Read all instructions before using the washer/dryer.
- Do not place items exposed to cooking oils in your dryer. Items contaminated with cooking oils may contribute to a chemical reaction that could cause a load to catch fire.
- Do not wash or dry articles that have been previously cleaned in, washed in, soaked in, or spotted with gasoline, dry-cleaning solvents, other flammable, or explosive substances as they give off vapors that could ignite or explode.
- Do not add gasoline, dry-cleaning solvents, or other flammable, or explosive substances to the wash water. These substances give off vapors that could ignite or explode.
- Do not allow children to play on or in the washer/dryer. Close supervision of children is necessary when the washer/dryer is used near children.
- Before the washer/dryer is removed from service or discarded, remove the doors to the washer/dryer compartments.
- Do not reach into the washer/dryer if the tub, agitator or drum is moving.
- Do not install or store the washer/dryer where it will be exposed to the weather.
- Do not tamper with controls.
- Clean dryer lint screen before or after each load.
- Under certain conditions, hydrogen gas may be produced in a hot water system that has not been used for 2 weeks or more. **HYDROGEN GAS IS EXPLOSIVE.** If the hot water system has not been used for such a period, before using the washing machine, turn on all hot water faucets and let the water flow from each for several minutes. This will release any accumulated hydrogen gas. As the gas is flammable, do not smoke or use an open flame during this time.
- Do not repair or replace any part of the washer/dryer or attempt any servicing unless specifically recommended in this Use and Care Guide or in published user-repair instructions that you understand and have the skills to carry out.
- Do not use fabric softeners or products to eliminate static unless recommended by the manufacturer of the fabric softener or product.
- Do not use heat to dry articles containing foam rubber or similarly textured rubber-like materials.
- Keep area around the exhaust opening and adjacent surrounding areas free from the accumulation of lint, dust, and dirt.
- The interior of the machine and dryer exhaust vent should be cleaned periodically by qualified service personnel.
- See "Electrical Requirements" section for grounding instructions.

SAVE THESE INSTRUCTIONS

INSTALLATION INSTRUCTIONS

Tools and Parts

Check that you have everything necessary for correct installation. Proper installation is your responsibility.

Tools needed:

- Flat-blade screwdriver
- Adjustable wrench that opens to 1 in. (2.5 cm) or 5/16 in. open-end wrench (for adjusting dryer feet)
- Level
- 1/4 in. nut driver or socket wrench
- Wood block (for leveling)
- Tin snips (new vent installations)
- Knife
- Safety glasses
- Duct tape
- Caulking gun and compound (for installing new exhaust vent)
- Gloves
- Pliers that open to 1 5/16 in. (3.95 cm)

Parts supplied

Remove parts package from the washer basket. Check that all parts were included.

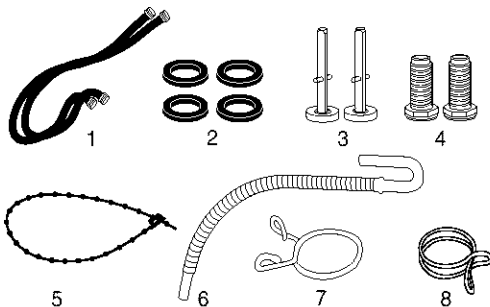

1. Water inlet hoses (2)
2. Inlet hose flat washers (4)
3. Rear leveling legs (2)
4. Front leveling legs (2)
5. Plastic strap
6. Drain hose
7. Yellow, single wire hose clamp
8. Silver, double-wire hose clamp

Parts needed

Check local codes, electrical supply and venting, and read "Electrical Requirements" and "Venting Requirements" before purchasing parts.

Mobile home installations require

- Metal exhaust system hardware available for purchase from your local Sears store or Sears Service Center.

Alternate Parts

Parts listed are available from your local Sears store or Sears Service Center. For more information, please reference the service numbers located on the back page of this manual.

If You Have	You Will Need to Buy
Laundry tub or standpipe taller than 96 in. (2.4 m)	Sump pump system (if not already available)
1 in. (2.5 cm) diameter standpipe	2 in. (5 cm) diameter to 1 in. (2.5 cm) diameter standpipe adapter, Part Number 3363920
Overhead sewer	Standard 20 gal. (76 L) 34 in. (86.4 cm) tall drain tub or utility sink and sump pump (available from local plumbing suppliers)
Floor drain	Siphon break, Part Number 285320, additional drain hose, Part Number 285702 and connector kit, Part Number 285442
Drain hose too short	Drain hose, Part Number 285664 and connector kit, Part Number 285442
Lint clogged drain	Drain protector, Part Number 367031
Water faucets beyond reach of fill hoses	2 longer water fill hoses: 6 ft (1.8 m) Part Number 76314, 10 ft (3.0 m) Part Number 350008

Location Requirements

⚠ WARNING



Explosion Hazard

Keep flammable materials and vapors, such as gasoline, away from dryer.

Failure to do so can result in death, explosion, or fire.

You will need

- A location that allows for proper exhaust installation. See "Venting Requirements."
- A 120-volt, 60-Hz., AC-only, 15- or 20-amp circuit.
- A grounded electrical outlet located within 2 ft (61 cm) of either side of the laundry center. See "Electrical Requirements."
- A sturdy floor to support the laundry center weight (laundry center, water and load) of 500 lbs (226.8 kg).

- A level floor with a maximum slope of 1 in. (2.5 cm) under entire laundry center. Clothes may not tumble properly and automatic sensor cycles may not operate correctly if dryer is not level. Installing on carpet is not recommended.
- A water heater set to deliver 120°F (49°C) water to the washer.
- Hot and cold water faucets located within 4 ft (1.2 m) of the hot and cold water fill valves, and water pressure of 5-100 psi (34.5-689.6 kPa).

Install the laundry center where it is protected from water and/or weather.

Do not operate your washer in temperatures at or below 32°F (0°C). Some water can remain in the washer and can cause damage in low temperatures. See "Vacation, Storage, and Moving Care" for winterizing information.

Do not operate your dryer at temperatures below 45°F (7°C). At lower temperatures, the dryer might not shut off at the end of an automatic cycle. This can result in longer drying times.

Check code requirements. Some codes limit, or do not permit, installation of the laundry center in garages, closets, mobile homes, or sleeping quarters. Contact your local building inspector.

Installation Clearances

The location must be large enough to fully open the dryer door.

Laundry Center Dimensions

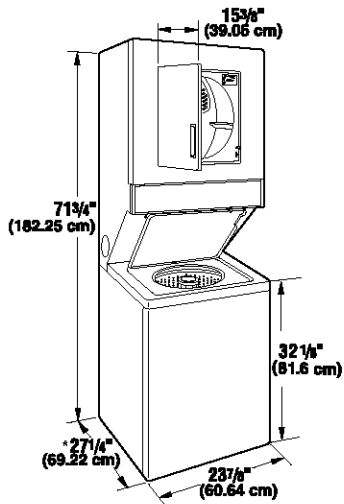

*Most installations require a minimum 5½ in. (14 cm) clearance behind the dryer for the exhaust vent with elbow. See "Venting Requirements."

Minimum installation spacing for recessed area or closet installation

The following dimensions shown are for the minimum spacings allowed.

- Additional spacing should be considered for ease of installation and servicing.
- Additional clearances might be required for wall, door and floor moldings.
- Additional spacing of 1 in. (2.5 cm) on all sides of the dryer is recommended to reduce noise transfer.

- For closet installation, with a door, minimum ventilation openings in the top and bottom of the door are required. Louvered doors with equivalent ventilation openings are acceptable.
- Rear clearance may be 0 in. when house exhaust system is lined up directly with dryer exhaust.

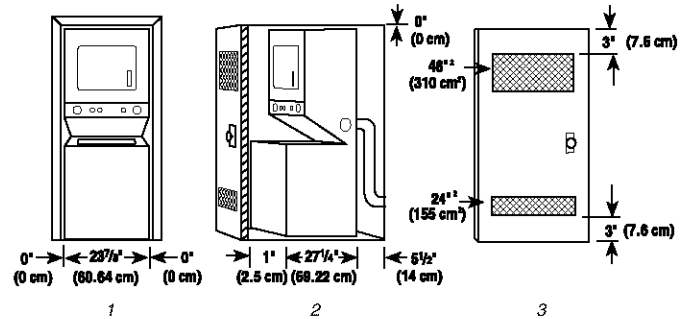

1. Recessed Area
2. Side view - closet or confined area
3. Closet door with vents

Mobile Home-Additional Installation Requirements

This laundry center is suitable for mobile home installations. The installation must conform to the Manufactured Home Construction and Safety Standard, Title 24 CFR, Part 3280 (formerly the Federal Standard for Mobile Home Construction and Safety, Title 24, HUD Part 280).

Mobile home installations require:

- Metal exhaust system hardware which is available for purchase from your local Sears store or Sears Service Center.
- Special provisions must be made in mobile homes to introduce outside air into the dryer. The opening (such as a nearby window) should be at least twice as large as the dryer exhaust opening.

Drain System

The laundry center can be installed using the standpipe drain system (floor or wall), the laundry tub drain system, or the floor drain system. Select the drain hose installation method you need (see "Alternate Parts").

Standpipe drain system - wall or floor (view 1 & 2)

The standpipe drain requires a minimum diameter standpipe of 2 in. (5 cm). The minimum carry-away capacity can be no less than 17 gal. (64 L) per minute. A 2 in. (5 cm) diameter to 1 in. (2.5 cm) diameter standpipe adapter kit is available (see "Alternate Parts").

The top of the standpipe must be at least 39 in. (99 cm) high and no higher than 96 in. (2.4 m) from the bottom of the washer.

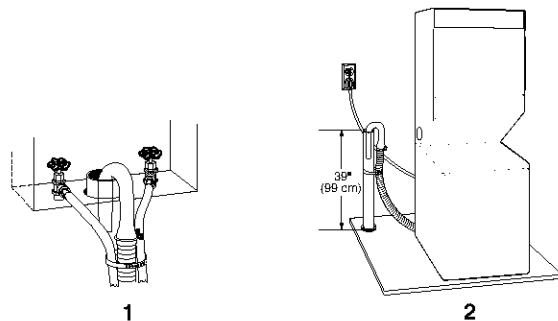

Laundry tub drain system (view 3)

The laundry tub needs a minimum 20 gal. (76 L) capacity. The top of the laundry tub must be at least 34 in. (86.4 cm) above the floor and no higher than 96 in. (2.4 m) from the bottom of the washer.

Floor drain system (view 4)

The floor drain system requires a siphon break that may be purchased separately (see "Alternate Parts").

The siphon break must be a minimum of 28 in. (71 cm) from the bottom of the washer. Additional hoses might be needed.

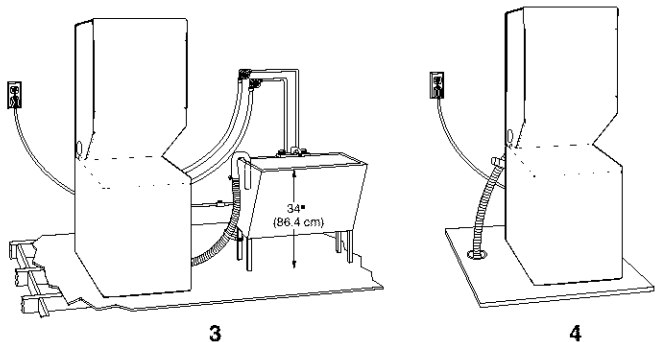

Electrical Requirements

⚠ WARNING



Electrical Shock Hazard

Plug into a grounded 3 prong outlet.

Do not remove ground prong.

Do not use an adapter.

Do not use an extension cord.

Failure to follow these instructions can result in death, fire, or electrical shock.

- A 120-volt, 60-Hz., AC-only, 15- or 20-amp fused electrical supply is required.
- This laundry center is equipped with a power supply cord having a 3 prong ground plug.
- Be sure that the electrical connection is adequate and in conformance with the National Electrical Code, ANSI/NFPA 70-latest edition and all local codes and ordinances.

A copy of the above code standards can be obtained from:
National Fire Protection Association, Batterymarch Park,
Quincy, MA 02269.

- A time-delay fuse or circuit breaker is recommended. Be sure fuse or circuit breaker matches the rating of your line.

- Use a separate circuit serving only your dryer.
- To minimize possible shock hazard, the cord must be plugged into a mating, 3 prong, ground-type outlet, grounded in accordance with local codes and ordinances. If a mating outlet is not available, it is the personal responsibility and obligation of the customer to have the properly grounded outlet installed by a qualified electrician.
- If codes permit and a separate ground wire is used, it is recommended that a qualified electrician determine that the ground path is adequate.
- Do not ground to a gas pipe.
- Do not use an extension cord.
- Do not have a fuse in the neutral or ground circuit
- Check with a qualified electrician if you are not sure the laundry center is properly grounded.

GROUNDING INSTRUCTIONS

- **For a grounded, cord-connected washer/dryer:**
This washer/dryer must be grounded. In the event of malfunction or breakdown, grounding will reduce the risk of electric shock by providing a path of least resistance for electric current. This washer/dryer uses a cord having an equipment-grounding conductor and a grounding plug. The plug must be plugged into an appropriate outlet that is properly installed and grounded in accordance with all local codes and ordinances.

WARNING: Improper connection of the equipment-grounding conductor can result in a risk of electric shock. Check with a qualified electrician or service representative or personnel if you are in doubt as to whether the washer/dryer is properly grounded. Do not modify the plug on the power cord: if it will not fit the outlet, have a proper outlet installed by a qualified electrician.

SAVE THESE INSTRUCTIONS

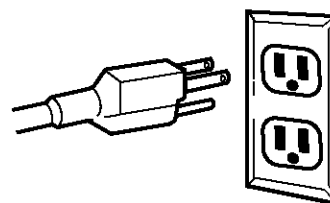

Venting Requirements

⚠ WARNING



Fire Hazard

- Use a heavy metal vent.**
- Do not use a plastic vent.**
- Do not use a metal foil vent.**
- Failure to follow these instructions can result in death or fire.**

WARNING: To reduce the risk of fire, this laundry center **MUST BE EXHAUSTED OUTDOORS.**

4 in. (10.2 cm) heavy metal exhaust vent and clamps must be used. DURASAFE™ venting products are recommended and are available from your local Sears store or Sears Service Center. DURASAFE™ vent products can be purchased from your dealer. For further information, please reference the service number located on the back page of this manual, or visit our Internet site at: www.sears.com.

- Do not exhaust the dryer into any gas vent, chimney, wall, ceiling, or a concealed space of a building.
- Do not use an exhaust hood with a magnetic latch.
- Do not install flexible metal vent in enclosed walls, ceilings or floors.
- Do not use screws or other fastening devices that extend into the interior of the vent to secure vent.

IMPORTANT: Observe all governing codes and ordinances.

Improper venting can cause moisture and lint to collect indoors, which may result in:

- Moisture damage to woodwork, furniture, paint, wall-paper, carpets, etc.
- Housecleaning problems and health problems.

Use a heavy metal vent. Do not use plastic or metal foil vent. Rigid metal vent is recommended to prevent crushing and kinking. Flexible metal vent must be fully extended and supported when the laundry center is in its final position. Remove excess flexible metal vent to avoid sagging and kinking that may result in reduced airflow.

An exhaust hood should cap the vent to prevent rodents and insects from entering the home.

Exhaust hood must be at least 12 in. (30.5 cm) from the ground or any object that may be in the path of the exhaust (such as flowers, rocks or bushes, etc.).

If using an existing vent system, clean lint from the entire length of the system and make sure exhaust hood is not plugged with lint. Replace any plastic or metal foil vent with rigid metal or flexible metal vent.

Use duct tape to seal all joints.

Install Leveling Legs

⚠ WARNING

- Excessive Weight Hazard**
- Use two or more people to move and install washer/dryer.**
- Failure to do so can result in back or other injury.**

To protect the floor, use a large flat piece of cardboard from the shipping carton. Gently place the laundry center on its side, on the cardboard.

Install the rear leveling legs

1. Push legs into holes in rear corners until they snap into place.

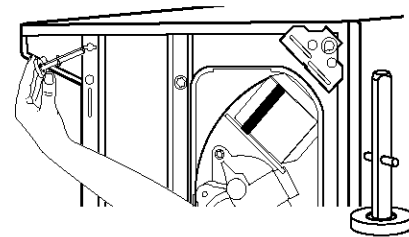

2. Check adjustability of rear legs by pushing in one leg. The other leg should come out. Check both legs. If they do not move freely, repeat step 1.

Install the front leveling legs

1. Examine the front leveling legs. Find the diamond marking.
2. Screw front legs by hand, into the holes in the triangular braces in the front corners. Use wrench to finish turning the legs until the diamond marking is no longer visible.

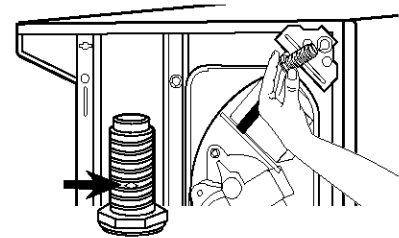

3. Carefully stand the laundry center upright.

Remove Foam Packing

1. Open the washer lid. The latch under the dryer will keep the lid open.
2. Pull the foam packing ring out of the washer.

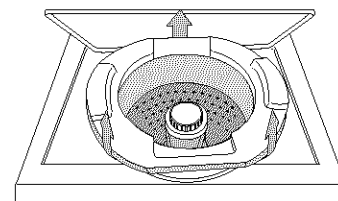

NOTE: Keep the foam ring and use it when transporting your laundry center. This packing material is used to keep the washer tub stable during transport.

Connect Drain Hose

Proper connection of the drain hose protects your floors from damage due to water leakage. Carefully read and follow these instructions.

1. Wet the inside of the straight end of the drain hose with tap water. Do not use any other lubricant.
2. Squeeze ears of the silver, double-wire clamp with pliers to open. Place clamp over the straight end of the drain hose $\frac{1}{4}$ in. (6.4 mm) from the end.

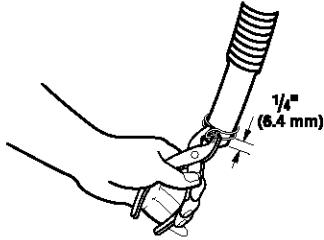

3. Open clamp. Twist hose back and forth while pushing onto drain connector on the side of the laundry center. Continue until hose contacts the ribbed stops on the cabinet.

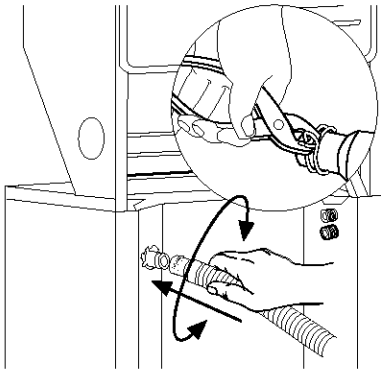

4. Place clamp over the area marked "CLAMP." Release clamp.

For laundry tub or standpipe drain systems

Connecting the drain hose "hook" to the corrugated drain hose:

1. Wet the outside end of the drain hose with tap water. Do not use any other lubricant.
2. Twist and push the "hook" back and forth while pushing down onto the drain hose. Continue until the "hook" is down to the enlarged diameter of the drain hose.

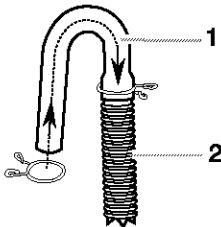

1. Hooked end
2. Drain hose

3. Open the yellow single-wire clamp and slide over the end of the drain hose "hook" to secure the sections together (pliers optional).
4. Put the hooked end of drain hose into laundry tub or standpipe. Rotate "hook" to eliminate kinks.

To prevent drain water from going back into the washer:

- Do not straighten hooked end of the drain hose and force excess drain hose into standpipe. Hose should be secure but loose enough to provide a gap for air.
- Do not lay excess hose on the bottom of the laundry tub.

For use with floor drain

Do not install the drain hose "hook" on to the corrugated drain hose. You may need additional parts (see "Floor Drain" under "Alternate Parts").

Connect Inlet Hoses

1. Insert a new flat washer (supplied) into each end of the inlet hoses. Firmly seat the washers in the couplings.

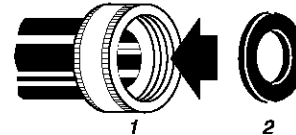

1. Coupling
2. Washer

Connect the inlet hoses to the water faucets

Make sure the washer basket is empty.

2. Attach the hose with the red coupling to the hot water faucet. Screw on coupling by hand until seated on the washer.
3. Attach the hose with the blue coupling to the cold water faucet. Screw on coupling by hand until seated on the washer.
4. Using pliers, tighten the couplings with an additional two-thirds turn. Do not overtighten. Damage to the valves can result.

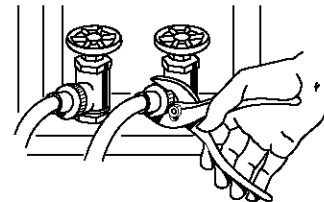

Clear the water lines

5. Run water through both faucets and inlet hoses, into a bucket or laundry tub, to get rid of particles in the water lines that might clog the inlet valve screens.

Connect the inlet hoses to the washer

6. Attach the hose with the blue coupling to the cold (top) inlet valve. Screw on coupling by hand until seated on the washer.

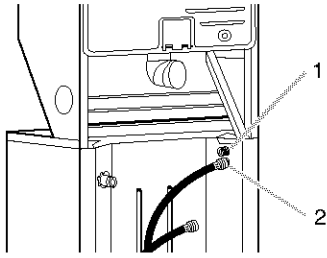

1. Cold water inlet valve (blue)
2. Hot water inlet valve (red)

7. Attach the hose with the red coupling to the hot water (bottom) inlet valve. Screw on coupling by hand until seated on the washer.
8. Using pliers, tighten the couplings with an additional two-thirds turn. Do not overtighten. Damage to the valves can result.

If you are working in a closet or recessed area

Move the laundry center into its final position and remove cardboard from under laundry center. Remove the access panel by removing two Phillips-head screws located at the top of the access panel. Set panel and screws aside. Complete hook-up of water hoses, exhaust vent, and (on gas models) the flexible gas connector through the access area. Replace access panel upon completion of laundry center installation.

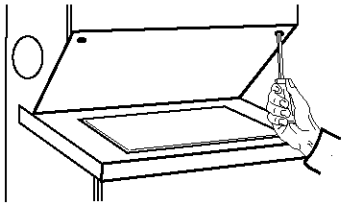

Check for leaks

9. Turn on the water faucets and check for leaks. A small amount of water might enter the washer. You will drain this later.

Secure Drain Hose

1. Move the laundry center to its final location and remove any cardboard used to move the laundry center.
2. Locate the plastic strap included in the parts package.

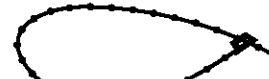

Beaded tie strap

3. Wrap the drain hose to the laundry tub leg or standpipe with the plastic strap (1 or 2 below) and secure.

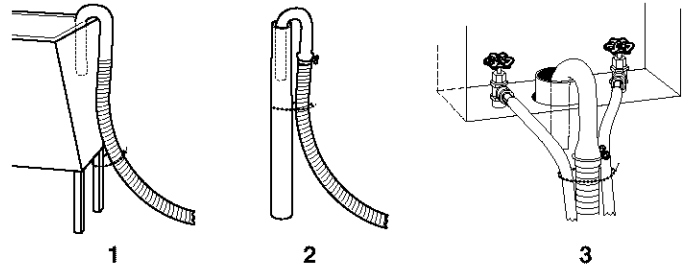

If the water faucets and the drain standpipe are recessed, put the hooked end of the drain hose in the standpipe. Tightly wrap the plastic strap around the water inlet hoses and the drain hose (3 above).

Do not force excess drain hose back into the rear of the laundry center.

Plan Vent System

Typical exhaust installations

Typical installations vent the dryer from rear of the laundry center. Other installations are possible.

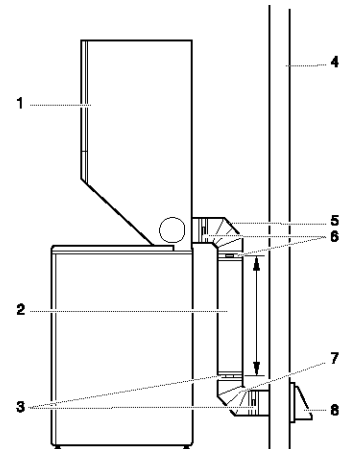

1. Dryer
2. Heavy metal vent
3. Duct tape & clamps
4. Wall
5. Elbow
6. Duct tape & clamps
7. Elbow
8. Exhaust hood

Optional exhaust installations

This laundry center can be converted to exhaust out the right or left side. To convert the laundry center, use Side Exhaust Kit Part Number 279823. If your laundry center was previously exhausted from the right or left side, it can be converted to rear exhaust by using standard offset connections. To cover the hole in the side, one of the following plugs can be added:

692790 (white)
3979370 (graphite)
3977784 (biscuit)

Follow the instructions in the kit to install. Kits are available from your local Sears store or Sears Service Center.

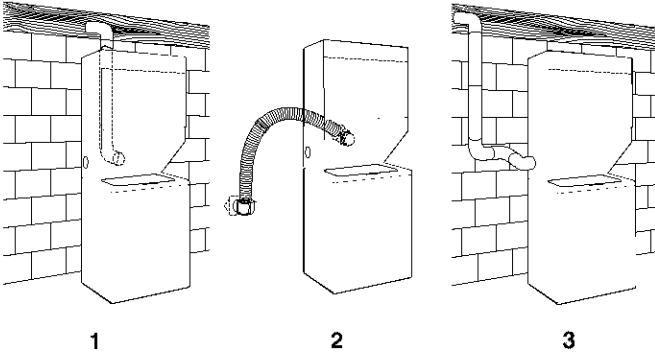

1. Standard rear offset exhaust installation
2. Rear exhaust for offset close clearance connection
3. Left or right side exhaust installation

Alternate installations for close clearances

Venting systems come in many varieties. Select the type best for your installation. Three close-clearance installations are shown. Refer to the manufacturer's instructions provided with the vent system.

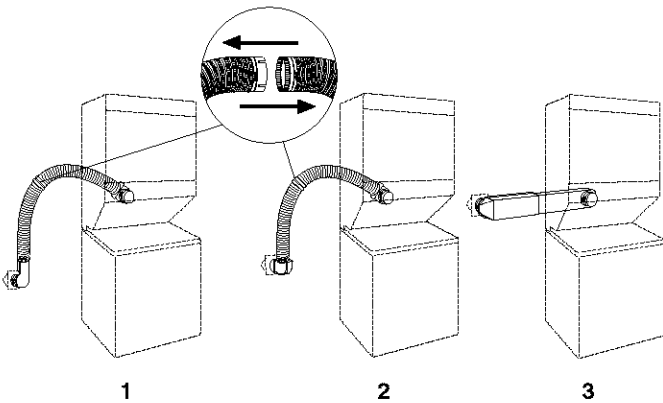

1. Loop system with standard elbows
2. Loop system with one offset & one standard elbow
3. Vent system with one periscope [2 in. (5 cm) clearance]

NOTE: The following kits for close clearance alternate installations are available for purchase. Please see the service number located on the back page of this manual to order.

- Over-The-Top Installation:
Part Number 26-49900
- Periscope Installation (For use with dryer vent to wall vent mismatch):
Part Number 26-49901 - Less than 5 in. (12.7 cm) mismatch
Part Number 26-49908 - 5 in. (12.7 cm) to 18 in. (45.7 cm) mismatch
Part Number 26-49904 - 18 in. (45.7 cm) to 29 in. (73.7 cm) mismatch
Part Number 26-49905 - 29 in. (73.7 cm) to 50 in. (127 cm) mismatch

Special provisions for mobile home installations

The exhaust vent must be securely fastened to a noncombustible portion of the mobile home structure. Do not use screws or other fastening devices that extend into the interior of the vent to secure vent.

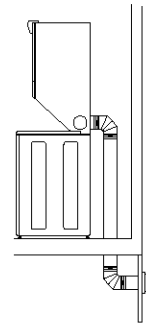

Terminate the exhaust vent outside. The exhaust vent must not terminate beneath the mobile home and must not be connected to any other duct, vent or chimney.

Determine Vent Length

1. Select the route that will provide the straightest and most direct path outdoors. Plan the installation to use the fewest number of elbows and turns. When using elbows or making turns, allow as much room as possible. Bend vent gradually to avoid kinking. Avoid 90° turns.

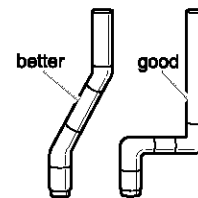

2. Determine vent length.

The maximum length of the exhaust system depends upon:

- The type of vent (rigid metal or flexible metal).
- The number of elbows used.
- Type of hood.

Recommended hood styles are shown here.

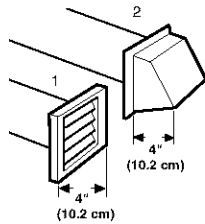

1. Louvered hood style
2. Box hood style

The angled hood style (shown following) is acceptable.

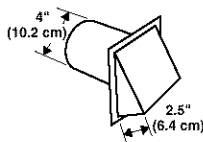

See the exhaust vent length chart that matches your hood type for the maximum vent lengths you can use.

Exhaust systems longer than specified will:

- Shorten the life of the dryer.
- Reduce performance, resulting in longer drying times and increased energy usage.

3. Determine the number of elbows you will need.

IMPORTANT: Do not use vent runs longer than those specified in the Vent Length Chart.

The following Vent Length Chart helps you determine your maximum vent length based on the number of 90° turns or elbows you will need and the type of vent (rigid metal or flexible metal) and hood that you will use.

Vent Length Chart

Number of 90° turns or elbows	Type of Vent	Box or Louvered hoods	Angled hoods
0	Rigid metal	34 ft (12.2 m)	29 ft (10.7 m)
	Flexible metal	21 ft (7.6 m)	16 ft (6.1 m)
1	Rigid metal	24 ft (9.7 m)	20 ft (8.2 m)
	Flexible metal	15 ft (6.4 m)	10 ft (4.9 m)
2	Rigid metal	14 ft (7.3 m)	12 ft (5.8 m)
	Flexible metal	7 ft (4.6 m)	2 ft (3.0 m)

NOTE: Side exhaust adds a 90° turn inside the laundry center. To determine maximum exhaust length, add 1 90° turn to the chart.

Install Vent System

1. (Optional) Put on safety glasses and gloves.
2. Install exhaust hood. Use caulking compound to seal exterior wall opening around exhaust hood.
3. Connect vent to exhaust hood. Vent must fit inside exhaust hood. Secure vent to exhaust hood with 4 in. (10.2 cm) clamp.
4. Run vent to dryer location. Use the straightest path possible (see “Determine Vent Length”). Avoid 90° turns. Use duct tape to seal all joints.

Level Laundry Center

Properly leveling your laundry center prevents excessive noise and vibration.

1. Check the levelness of the laundry center by placing a level on the top edge of the washer, first side-to-side, then front-to-back.

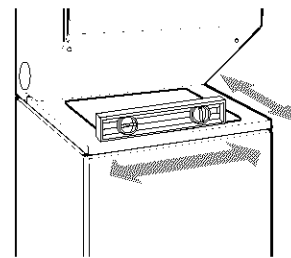

2. If the laundry center is not level, prop up the front with a wood block and adjust the feet up or down as necessary. Remove wood block and lower laundry center. Repeat this step until the laundry center is level.

Connect Vent

1. Using a 4 in. (10.2 cm) clamp, connect vent to exhaust outlet in laundry center. If connecting to existing vent, make sure the vent is clean. The vent must fit over the exhaust outlet and inside the exhaust hood. Make sure the vent is secured to exhaust hood with a 4 in. (10.2 cm) clamp.
2. Move laundry center into final position. Do not crush or kink vent. Make sure laundry center is level.

Complete Installation

1. Check to be sure all parts are now installed. If there is an extra part, go back through the steps to see which step was skipped.
 2. Check to be sure you have all of your tools.
 3. Dispose/recycle all packaging materials. Keep the plastic foam for use if the laundry center should be transported.
 4. Check the laundry center's final location. Be sure the vent is not crushed or kinked.
 5. Check to be sure the laundry center is level and front leveling feet are tight. See "Level Laundry Center."
 6. Plug into a grounded 3 prong outlet. Turn power on.
 7. Check to be sure the water faucets are on.
 8. Check for leaks around faucets and inlet hoses.
 9. Remove the blue protective film on the console and any tape remaining on the laundry center.
 10. Read "Washer Use" and "Dryer Use."
 11. Wipe the dryer drum interior thoroughly with a damp cloth to remove any dust.
 12. To test the washer, measure $\frac{1}{2}$ the normal recommended amount of detergent and pour it into the washer. Close the lid. Select HEAVY DUTY and pull out the Cycle Control knob. Allow the washer to complete one whole cycle.
 13. To test the dryer, set the dryer on a full heat cycle (not an air cycle) for 20 minutes and start the dryer.
If the dryer will not start, check the following:
 - Controls are set in a running or "On" position.
 - Start button has been firmly pushed.
 - Laundry Center is plugged into a grounded 3 prong outlet.
 - Electrical supply is connected.
 - House fuse is intact and tight; or circuit breaker has not tripped.
 - Dryer door is closed.
 14. When the dryer has been running for 5 minutes, open the dryer door and feel for heat.
If you do not feel heat, check the following:
 - Controls are set on a heated cycle, not an air cycle.
- NOTE:** You may notice a burning odor when dryer is first heated. This odor is common when the heating element is first used. The odor will go away.

FEATURES AND BENEFITS

DUAL-ACTION™ Plus Agitator

The DUAL-ACTION™ Plus Agitator is a uniquely designed agitator that helps push clothes that are on top down to the bottom of the washer where the best cleaning action takes place.

Porcelain Wash Basket

Durable finish resists scratching, staining and odors for long-lasting quality. Fabrics are protected by the smooth wash basket.

4-way Venting

This laundry center features 4 different ways to vent your dryer. A properly exhausted laundry center will give you the shortest drying time, lower your utility bill and extend the life of the laundry center.

WASHER USE

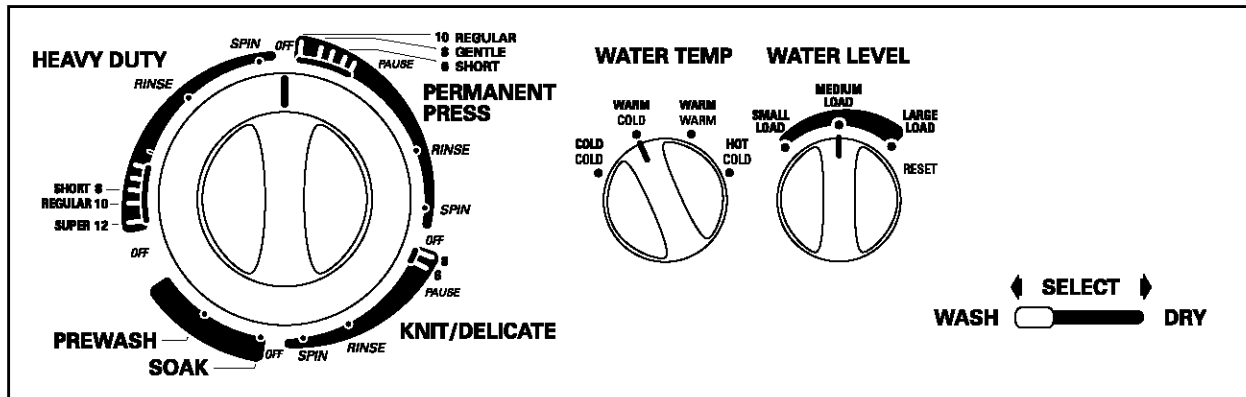

Starting Your Washer

! WARNING



Fire Hazard

Never place items in the washer that are dampened with gasoline or other flammable fluids.

No washer can completely remove oil.

Do not dry anything that has ever had any type of oil on it (including cooking oils).

Doing so can result in death, explosion, or fire.

NOTE: This Kenmore Laundry Center operates on a 120-volt current. Therefore, you cannot operate the washer and dryer at the same time.

The following is a guide to starting your washer. Periodic references to other sections of this manual provide more detailed information.

1. Set WASH/DRY selector switch to WASH.



2. Pour measured powdered or liquid detergent into the washer. If desired, add powdered or liquid color safe bleach.
3. Place a load of sorted clothes in the washer.
 - Load evenly to maintain washer balance. Mix large and small items. See "Loading."
 - Items should move easily through the wash water. Overloading can cause poor cleaning.
4. Close the washer lid.

5. Turn the WATER LEVEL selector knob to the correct setting for your wash load and the type of fabric being washed.

WATER LEVEL

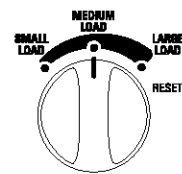

- Choose a load size that allows the load to move freely for best fabric care. See "Loading."
- You may change the load size selection after the washer has started filling by turning the selector to a different setting.

6. Set the WATER TEMP selector to the correct setting for the type of fabric and soils being washed.

WATER TEMP

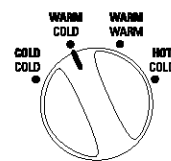

Use the warmest water safe for the fabric. Follow garment label instructions.

Water Temp	Use For
Hot 111°F (44°C) or above	Whites and pastels Heavy soils
Warm 90°- 110°F (32°- 43°C)	Bright colors Moderate to light soils
Cold 70°- 90°F (21°- 32°C)	Colors that bleed or fade Light soils

NOTE: In wash water temperatures colder than 70°F (21°C), detergents do not dissolve well. Soils can be difficult to remove. Some fabrics can retain wear wrinkles and have increased pilling (the formation of small lint-like balls on the surface of garments).

- Push in the Cycle Control knob and turn it clockwise to the wash cycle you want. Pull out the Cycle Control knob to start the washer.

To stop or restart your washer:

- To stop the washer at any time, push in the Cycle Control knob.
- To restart the washer, close the lid (if open) and pull out the Cycle Control knob.

Cycles

This section describes the available wash cycles and will help you make the best cycle selections for your wash loads. Each cycle is designed for different types of fabric and soil levels.

- The washer pauses briefly throughout each cycle. These pauses are normal. Refer to “Normal Sounds” for sounds you may hear during a wash cycle.
- Refer to “Understanding Washer Cycles” to learn what happens during a wash cycle.

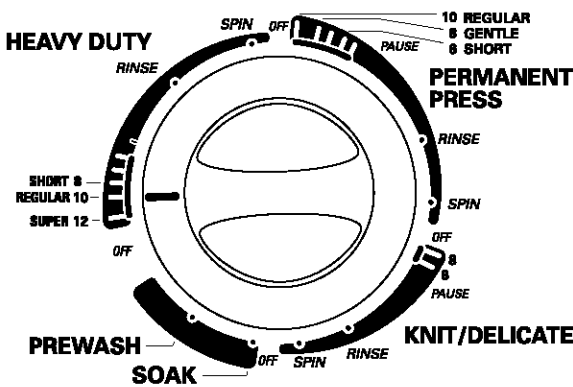

Heavy Duty

Use this cycle for sturdy or heavily soiled loads. Wash combines fast speed agitation and fast spin speeds.

- Use the Super or Regular settings for heavily soiled and sturdy fabrics.
- Use the Short setting for light soil and delicate fabrics.

Permanent Press

The Permanent Press Cycle includes a load cooling process that reduces wrinkling. Wash combines fast and slow speed agitation and slow spin speeds.

When the timer reaches Pause, the washer will drain and pause for approximately 2 minutes while some of the wash water is drained and replaced with rinse water.

Knit/Delicate

Use this cycle for lingerie and loosely knit items. Partway through the cycle, the washer pauses and soaks the load for more gentle care of lightly soiled delicate items. Wash combines slow speed agitation for gentle soil removal and slow spin speeds to reduce wrinkling.

Soak

The Soak cycle features 4 minutes of agitation followed by an unlimited soak time to help remove heavy soils and stains that need pretreatment. You will need to reset the washer to a SPIN setting to remove water.

- The Soak cycle should be followed by the Heavy Duty or Permanent Press or Prewash cycle with additional detergent.

NOTE: Hot water is not recommended for soaking. It may set some stains.

Prewash

Use this cycle to get up to 4 minutes of agitation to help remove heavy soils and stains that need pretreatment.

- The Prewash cycle should be followed by the Heavy Duty or Permanent Press cycle with additional detergent.

Rinse and Spin

When using extra detergent for heavily soiled clothes, or washing special-care items, you may find an extra rinse and spin is needed.

- Push in the Cycle Control knob and turn it clockwise to any of the RINSE settings.
 - For fast agitation and spin, use the Heavy Duty cycle.
 - For slow agitation and spin, use the Permanent Press cycle.
- Set the WATER LEVEL and WATER TEMP controls to the desired setting.
- Pull out the Cycle Control knob. The washer fills to the selected load size, agitates, drains, and spins.

Drain and Spin

A drain and spin may help shorten drying times for some heavy fabrics or special-care items by removing excess water.

- Push in the Cycle Control knob and turn it clockwise to any of the SPIN settings.
 - For a fast spin, use the Heavy Duty cycle.
 - For a slow spin, use the Permanent Press cycle.
- Pull out the Cycle Control knob. The washer drains, then spins.

Understanding Washer Cycles





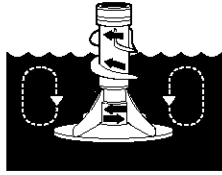





When the Cycle Control knob is set to a number and pulled out, the washer fills (to the selected load size) before agitation and timing start. The washer begins agitating immediately after filling; agitation occurs with the washer lid up or down.

During agitation, the agitator creates a continuous rollover action that provides a thorough cleaning of the wash load.



After agitation starts, the Cycle Control knob turns clockwise until it points to an Off area and the cycle ends.

NOTE: The washer pauses briefly throughout each cycle. These pauses are normal for washer operation.

WASH	RINSE
 1. Fill	 1. Fill
 2. Wash selected time	 2. Rinse
 3. Drain* No agitation	 3. Drain No agitation
 4. Spin	 4. Spin-Spray rinse
	 5. Spin
	 6. Off

*The Permanent Press cycle partially drains, fills, agitates briefly, and drains.

Normal Sounds

As with any new product, you will hear sounds that you are not accustomed to. You may hear various sounds occurring during the washing, rinsing, and spinning process. Between changes in wash actions, there will be momentary pauses. You will hear water spraying and splashing during the wash and rinse cycles. You may hear air being pulled through the pump during the end of draining or gears changing when the cycle changes. These sounds are part of normal washer operation.

LAUNDRY TIPS

Preparing clothes for washing

Follow these recommendations to help you prolong the life of your garments.

- Close zippers, snaps, and hooks to avoid snagging other items. Remove pins, buckles, and other hard objects to avoid scratching the washer interior. Remove non-washable trim and ornaments.
- Empty pockets and turn them inside out.
- Turn down cuffs, brush away lint and dirt.
- Turn synthetic knits inside out to avoid pilling.
- Tie strings and sashes so they will not tangle.
- Mend tears, loose hems, and seams.
- Treat spots and stains.
- Stained or wet garments should be washed promptly for best results.

Sorting

- Separate heavily soiled items from lightly soiled ones, even if they would normally be washed together. Separate lint givers (towels, chenille) from lint takers (corduroy, synthetics, permanent press). When possible, turn lint givers inside out.
- Separate dark colors from light colors, colorfast items from non-colorfast items.
- Sort by fabric and construction (sturdy cottons, knits, delicate items).

Loading

Loading suggestions (maximum size loads)

Laundry Center

Heavy Work Clothes

2 pair pants
3 work shirts

Towels

9 bath towels or
6 bath towels, 3 hand towels &
6 wash cloths

Permanent Press

6 shirts or
2 double sheets &
2 pillowcases
or 2 single sheets &
2 pillowcases

Mixed Load

1 pair pants
2 pillowcases
2 shirts
1 T-shirt

Knits

2 pair pants & 2 shirts
or 3 dresses

Delicates

1 camisole
2 slips
4 undergarments
1 set of sleepwear
1 half slip

DRYER USE

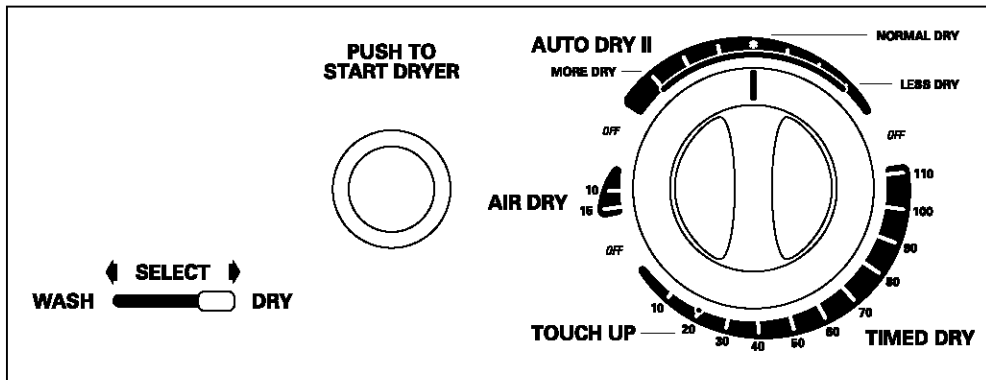

Starting Your Dryer

! WARNING



Explosion Hazard

Keep flammable materials and vapors, such as gasoline, away from dryer.

Do not dry anything that has ever had anything flammable on it (even after washing).

Failure to follow these instructions can result in death, explosion, or fire.

! WARNING



Fire Hazard

No washer can completely remove oil.

Do not dry anything that has ever had any type of oil on it (including cooking oils).

Items containing foam, rubber, or plastic must be dried on a clothesline or by using an Air Cycle.

Failure to follow these instructions can result in death or fire.

NOTE: This Kenmore Laundry Center operates on a 120-volt current. Therefore, you cannot operate the washer and the dryer at the same time.

Before using your dryer, wipe the dryer drum with a damp cloth to remove dust from storing and shipping.

1. Check the lint screen, clean if needed. See "Cleaning the Lint Screen."
2. Load clothes loosely into the dryer and close the door. Do not pack the dryer. Allow space for clothes to tumble freely.
3. Slide the SELECT indicator to DRY.



4. Turn the Cycle Control knob to the recommended cycle and temperature for the type of load being dried. See "Drying, Cycle and Temperature Tips."
5. Press the PUSH TO START DRYER button.

PUSH TO START DRYER

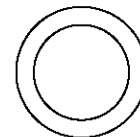

Stopping and Restarting

You can stop your dryer anytime during a cycle.

To stop your dryer

Open the dryer door or turn the Cycle Control knob to OFF.

NOTE: The Cycle Control knob should point to an Off area when the dryer is not in use.

To restart your dryer

1. Close the door.
2. Select a new cycle and temperature (if desired).
3. Press the PUSH TO START DRYER button.

Loading

Load clothes loosely into the dryer. Do not pack the dryer. Allow space for clothes to tumble freely. The following chart shows examples of balanced loads that would allow for proper tumbling.

Heavy work clothes	2 pair pants, 3 work shirts
Delicates	1 camisole, 2 slips, 4 undergarments, 1 set of sleepwear, 1 half slip
Towels	9 bath towels; or 6 bath towels, 3 hand towels, 6 wash cloths
Mixed Load	2 pillowcases, 1 T-shirt, 2 shirts, 1 pair pants
Knits	2 slacks, 2 shirts; or 3 dresses
Perm. Press	6 shirts; or 2 double sheets & 2 pillowcases; or 2 single sheets & 2 pillowcases

Drying, Cycle and Temperature Tips

Select the correct cycle and temperature for your load.

Drying tips

- Follow care label directions when they are available.
- If you use fabric softener sheets, use only ones labeled as dryer safe. Follow package instructions.
- Remove the load from the dryer as soon as tumbling stops to reduce wrinkling. This is especially important for permanent press, knits, and synthetic fabrics.

Cycle and temperature tips

- Dry most loads using the Normal Dry setting (*).
- Use a More Dry setting for drying heavyweight items such as towels and work clothes.
- Use a Normal Dry setting for drying medium weight items, such as sheets, underwear, permanent press fabrics, and some knits.
- Use a Less Dry setting for drying lightweight items such as lingerie, blouses, dresses, and some knits.
- Use a no heat (air) setting for rubber, plastic or heat sensitive fabrics.
- Line dry bonded or laminated fabrics.

If you are unsure of the temperature to select for a load, select a lower setting rather than a higher setting.

NOTE: If you have questions about drying temperatures for various loads, refer to the care label directions.

Cycles

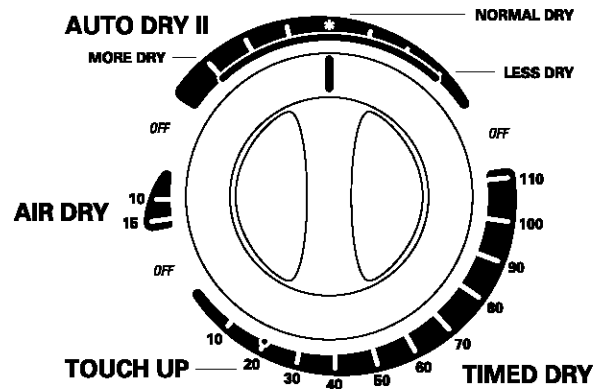

Auto Dry II

Use this cycle to dry most loads. Dryness is determined by thermostats that react to the amount of moisture in the air exhausted from the dryer. Moist air indicates clothes are damp. Dry air indicates that moisture has been removed.

This cycle includes a 10 minute (approximately) cool down period at the end of the cycle to make clothes easier to handle and reduce wrinkling.

Dry most loads using the Normal Dry (*) setting. When the cycle ends, check the dryness of the load.

- If the load is drier than you like, select a setting closer to LESS DRY the next time you dry a similar load.
- If the load is not as dry as you like, complete drying using the Timed Dry cycle. The next time you dry a similar load, select a setting closer to MORE DRY.

NOTE: Drying time with an automatic cycle varies according to the type of fabric, size of load, and temperature setting. See "Drying, Cycle and Temperature Tips."

Timed Dry

Use this cycle to complete drying if items are still damp after the Auto Dry II cycle. Timed Dry is also useful for heavyweight and bulky items, such as bedspreads, work clothes, and large loads that require a long drying time. Use this cycle to get up to 110 minutes of heated drying time. The heating cycle is followed by a 10 minute (approximately) cool down period.

Touch Up

Use this cycle to smooth synthetic and permanent press clothes that are clean but wrinkled from being crowded in a closet or suitcase. This setting provides approximately 10 minutes of heated tumbling followed by a 10 minute (approximately) cool down period. Remove clothes immediately when tumbling stops.

Air Dry

Use the Air Dry cycle for items that require drying without heat such as rubber, plastic and heat sensitive fabrics. This chart shows examples of items that can be dried using an air cycle.

Type of Load	Minutes*
Foam rubber — pillows, padded bras, stuffed toys	20 - 30
Plastic — Shower curtains, tablecloths	20 - 30
Rubber-backed rugs	40 - 50
Olefin, polypropylene, sheer nylon	10 - 20

*Reset time as needed to allow items to dry completely.

When using Air Dry

- Check to see that coverings are securely stitched.
- Shake and fluff pillows by hand periodically during the cycle.
- Dry item completely. Foam rubber pillows are slow to dry.

End of Cycle Signal

Your dryer sounds a signal when a drying cycle is finished. This signal is helpful when you are drying items that need to be removed as soon as the dryer stops in order to prevent wrinkles.

LAUNDRY CENTER CARE

Cleaning Your Washer

Cleaning the exterior

Use a soft, damp cloth or sponge to wipe up any spills such as detergent or bleach. Occasionally wipe the outside of your washer to keep it looking new.

Cleaning the interior

Clean your washer interior by mixing 1 cup (250 mL) of chlorine bleach and 2 scoops or caps full of detergent. Pour this into your washer and run it through a complete cycle using hot water. Repeat this process if necessary.

NOTE: Remove any hard water deposits using only cleaners labeled as washer safe.

Water Inlet Hoses

Replace inlet hoses after 5 years of use to reduce the risk of hose failure. Periodically inspect and replace inlet hoses if bulges, kinks, cuts, wear, or leaks are found.

When replacing your inlet hoses, mark the date of replacement on the label with a permanent marker.

Cleaning the Lint Screen

Every load cleaning

The lint screen is located on the back wall of the dryer. Remove lint before each load. A screen blocked by lint can increase drying time.

To clean

1. Pull out the lint screen and its cover.

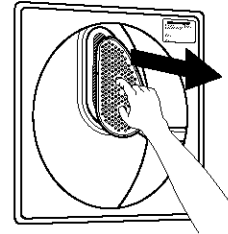

2. Separate the cover and the screen by squeezing the screen and pulling on the cover at the same time.

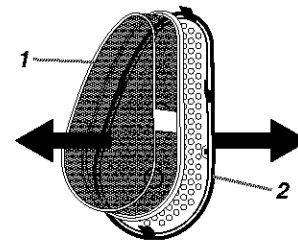

1. Screen
2. Cover

3. Roll lint off the screen with your fingers. Do not rinse or wash screen to remove lint. Wet lint is hard to remove.

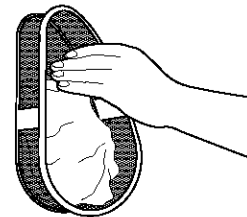

4. Put the lint screen and cover back together and push firmly back into place.

IMPORTANT:

- Do not run the dryer with the lint screen loose, damaged, blocked, or missing. Doing so can cause overheating and damage to both the dryer and fabrics.
- Some towels made of synthetic fibers and natural fibers (polyester and cotton blends) may shed more lint than other towels, causing your dryer's lint screen to fill up faster. Be sure to remove lint from the lint screen before and after drying new towels.
- If lint falls off the screen into the dryer during removal, check the exhaust hood and remove lint. See "Venting Requirements."

As needed cleaning

Laundry detergent and fabric softener residue can build up on the lint screen. This buildup can cause longer drying times for your clothes, or cause the dryer to stop before your load is completely dry. The screen is probably clogged if lint falls off the screen.

Clean the lint screen (as outlined following) every 6 months, or more frequently if it becomes clogged due to a residue buildup.

To wash

1. Roll lint off the screen with your fingers.
2. Wet both sides of lint screen with hot water.
3. Wet a nylon brush with hot water and liquid detergent. Scrub lint screen with the brush to remove residue buildup.

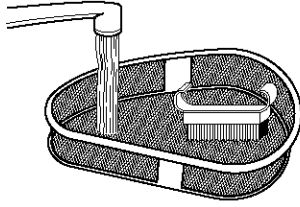

4. Rinse screen with hot water.
5. Thoroughly dry lint screen with a clean towel. Replace screen in dryer.

Cleaning the Dryer Interior

⚠ WARNING



Explosion Hazard

Use nonflammable cleaner.

Failure to do so can result in death, explosion, or fire.

To clean dryer drum

1. Apply a liquid, non-flammable household cleaner to the stained area and rub with a soft cloth until all excess dye is removed.
2. Wipe drum thoroughly with a damp cloth.
3. Tumble a load of clean cloths or towels to dry drum.

NOTE: Garments which contain unstable dyes, such as denim blue jeans or brightly colored cotton items, may discolor the dryer interior. These stains are not harmful to your dryer and will not stain future loads of clothes. Dry unstable dye items inside out to prevent dye transfer.

Removing Accumulated Lint

From inside the dryer cabinet

Lint should be removed every 2 years, or more often, depending on dryer usage. Cleaning should be done by a qualified person.

From the exhaust vent

Lint should be removed every 2 years, or more often, depending on dryer usage.

Vacation, Storage, and Moving Care

Install and store your laundry center where it will not freeze. Because some water may stay in the hoses, freezing can damage your laundry center. If storing or moving your laundry center during freezing weather, winterize it.

Non-use or vacation care

Operate your laundry center only when you are at home. If you will be on vacation or not using your laundry center for an extended period of time, you should:

- Unplug laundry center or disconnect power.
- Turn off the water supply to the washer. This helps avoid accidental flooding (due to a water pressure surge) while you are away.

To winterize laundry center

1. Shut off both water faucets.
2. Disconnect and drain water inlet hoses.
3. Put 1 quart (1 L) of R.V.-type antifreeze in the basket.
4. Run washer on a drain and spin setting for about 30 seconds to mix the antifreeze and water.
5. Unplug laundry center or disconnect power.

To use laundry center again

1. Flush water pipes and hoses.
2. Reconnect water inlet hoses.
3. Turn on both water faucets.
4. Plug in laundry center or reconnect power.
5. Run the washer through a complete cycle with 1 cup (250 mL) of detergent to clean out antifreeze.

To transport the laundry center

1. Shut off both water faucets.
2. Disconnect and drain water inlet hoses.
3. If laundry center will be moved during freezing weather, put in a quart (1 L) of R.V.-type antifreeze in the basket. Run washer on a spin setting for about 30 seconds to mix the antifreeze and water.
4. Disconnect the drain from the drain system.
5. Unplug the power cord.
6. Disconnect the exhaust vent.
7. Wash lint screen.
8. Make sure leveling legs are secure.
9. Place the inlet hoses into the basket.
10. Drape the power cord and drain hose over edge and into the basket.
11. Use masking tape to secure the washer lid and dryer door.

Re-installing your laundry center

1. Follow the "Installation Instructions" to locate, level, and connect the laundry center.
2. Run the washer through a complete cycle with 1 scoop or capful of detergent to clean the washer and remove the antifreeze, if used.

TROUBLESHOOTING WASHER

First try the solutions suggested here and possibly avoid the cost of a service call...

Washer won't fill, rinse or agitate

- **Check the following:**
 - Is the power cord plugged into a grounded 3 prong outlet?
 - Is the indicator on the Cycle Control knob properly lined up with a cycle? Turn the Cycle Control knob to the right slightly and pull to start.
 - Are the water inlet valve screens clogged?
 - Are both the hot and cold water faucets turned on?
 - Is the water inlet hose kinked?
 - **Does the water level seem too low, or does the washer appear to not fill completely?**

The top of the agitator is much higher than the highest water level. This creates a perception that the washer is not filling completely. This is normal.
-

Washer stops

- **Check the following:**
 - Is the power cord plugged into a grounded 3 prong outlet?
 - Is the indicator on the Cycle Control knob properly lined up with a cycle? Turn the Cycle Control knob to the right slightly and pull to start.
 - Are the water inlet valve screens clogged?
 - Are both the hot and cold water faucets turned on?
 - Is the water inlet hose kinked?
 - **Is there power at the plug?**

Check your electrical source or call an electrician.
 - **Has a fuse blown or is the circuit breaker open?**

If problem continues, call an electrician.
 - **Are you using an extension cord?**

Do not use an extension cord.
 - **Is the washer overloaded?**

Wash smaller loads.
 - **Is the washer in a normal pause in the Permanent Press cycle?**

The washer pauses for about 2 minutes in the Permanent Press cycle. Allow the cycle to continue.
-

Washer won't drain or spin

- **Is the drain hose clogged, or the end of the drain hose more than 96 in. (2.4 m) above the floor?**

See the Installation Instructions for proper installation of drain hose.
 - **Is the lid open?**

The lid must be closed during operation.
 - **Is there excessive sudsing?**

Always measure detergent. Follow manufacturer's directions. If you have very soft water, you might need to use less detergent.
-

- **Is your voltage low?**

Check your electrical source or call an electrician. Do not use an extension cord.
-

Washer continues to fill or drain, or the cycle seems stuck

- **Is the top of drain hose lower than the water level in washer?**

The top of the hose must be higher than the water level in the washer for proper operation (see "Installation Instructions").
 - **Does the drain hose fit too tightly in the standpipe, or is it taped to the standpipe?**

The drain hose should be loose yet fit securely. Do not seal the drain hose with tape. The hose needs an air gap (see "Installation Instructions").
-

Washer makes noise

- **Is the load balanced and the laundry center level?**

The wash load should be balanced and not overloaded.

The laundry center must be level. Ensure leveling legs are installed (see "Installation Instructions").
 - **Gears are engaging after the drain and before spin.**

These are normal washer noises.
-

Washer leaks

- **Check the following:**

Are the fill hoses tight? Are the fill hose washers properly seated? Is the drain hose clamp properly installed? (See "Installation Instructions.")
 - **Is the sink or drain clogged?**

Sink and standpipe must be able to handle 17 gal. (64 L) of water per minute.
 - **Is water deflecting off the tub ring or the load?**

Center the tub before starting the washer.

The wash load should be balanced and not overloaded. The fill or spray rinses can deflect off the load.

The laundry center must be level. Ensure leveling legs are installed (see "Installation Instructions").
 - **Check household plumbing for leaks.**
-

Washer basket is crooked

- **Was the washer basket pulled forward during loading?**

The wash load should be balanced and not overloaded. Push the basket to the center before starting wash.
 - **Is the load balanced and the laundry center level?**

The wash load should be balanced and not overloaded.

The laundry center must be level. Ensure leveling legs are installed (see "Installation Instructions").
 - **The washer basket moves while washing.**

This is normal.
-

Agitator operation

- **The top of the agitator is loose, or moves in only one direction.**

This is normal.
-

Load too wet

- **Did you use the right cycle for the load being washed?**
Select a cycle with a higher spin speed (if available).
- **Did you use a cold rinse?**
Cold rinses leave loads wetter than warm rinses. This is normal.

Residue or lint on load

- **Did you sort properly?**
Sort lint givers (towels, chenille) from lint takers (corduroy, synthetics). Also sort by color.
- **Did you overload the washer?**
The wash load must be balanced and not overloaded. Lint can be trapped in the load if overloaded. Wash smaller loads.
- **Check the following:**
Was paper or tissue left in the pockets?

Did you use enough detergent? Follow manufacturer's directions. Use enough detergent to hold the lint in the water.

Is your water colder than 70°F (21°C)? Wash water colder than 70°F (21°C) may not completely dissolve the detergent.

Stains on load

- **Did you follow the manufacturer's directions when adding detergent and fabric softener?**
Measure detergent and fabric softener. Use enough detergent to remove soil and hold it in suspension.

Dilute fabric softener and add to the rinse portion of a cycle only. Do not drip fabric softener on clothes.
- **Is there above average iron (rust) in water?**
You may need to install an iron filter.
- **Did you properly sort the load?**
Sort dark clothes from whites and lights.
- **Did you unload the washer promptly?**
To avoid dye transfer, unload the washer as soon as it stops.

Load is wrinkled

- **Did you use the right cycle for the load being washed?**
Use a cycle with a low spin speed to reduce wrinkling.
- **Did you unload the washer promptly?**
Unload the washer as soon as it stops.
- **Did you overload the washer?**
The wash load must be balanced and not overloaded. Loads should move freely during washing.
- **Was the wash water warm enough to relax wrinkles?**
If safe for the load, use warm wash water.
- **Are the hot and cold water hoses reversed?**
Check to be sure the hot and cold water hoses are connected to the right faucets (see "Installation Instructions").

Load is tangled or twisted

- **Did you overload the washer?**
The wash load must be balanced and not overloaded. Loads should move freely during washing (see "Loading").
- **Did you wrap items around the agitator?**
Drop items loosely into the washer. Do not wrap items around the agitator.

Gray whites, dingy colors

- **Did you properly sort the load?**
Dye transfer can occur when mixing whites and colors in a load. Sort dark clothes from whites and lights.
- **Was the wash temperature too low?**
Use warm washes if safe for the load.
- **Did you use enough detergent, or do you have hard water?**
Use more detergent for washing heavy soils in cold or hard water.
- **Are the hot and cold water hoses reversed?**
Check to be sure the hot and cold water hoses are connected to the right faucets (see "Installation Instructions").

Garment damage

- **Check the following:**
Were sharp items removed from pockets before washing?
Empty pockets, zip zippers, snap or hook fasteners before washing.

Were strings and sashes tied to prevent tangling?

Were items damaged before washing? Mend rips and broken threads in seams before washing.
- **Did you overload the washer?**
The wash load must be balanced and not overloaded. Loads should move freely during washing.
- **Did you properly add chlorine bleach?**
Do not pour chlorine bleach directly on load. Wipe up bleach spills. Undiluted bleach will damage fabrics.
- **Did you follow the manufacturer's care label instructions?**

TROUBLESHOOTING DRYER

First try the solutions suggested here and possibly avoid the cost of a service call...

Clothes are not drying satisfactorily

■ Check the following:

Is the lint screen clogged with lint?

Is the exhaust vent or outside exhaust hood clogged with lint, restricting air movement? Run the dryer for 5-10 minutes. Hold your hand under the outside exhaust hood to check air movement. If you do not feel air movement, clean exhaust system of lint or replace exhaust vent with heavy metal or flexible metal vent (see "Installation Instructions").

Is the exhaust vent crushed or kinked? Replace with heavy metal or flexible metal vent. See your Installation Instructions.

Has a fuse blown or a circuit breaker tripped?

Has an air cycle been selected? Select the right cycle for the types of garments being dried (see "Drying, Cycle and Temperature Tips").

Are fabric softener sheets blocking the grille? Use only one fabric softener sheet and only use it once.

■ Is the dryer located in a room with temperature below 45°F (7°C)?

Proper operation of dryer cycles requires temperatures above 45°F (7°C).

■ Was a cold rinse water used? Was the load very wet?

Expect longer drying times with items rinsed in cold water and with items that hold moisture (cottons).

■ Is the load too large and heavy to dry quickly?

Separate the load to tumble freely.

Dryer will not run

■ Check the following:

Is the power cord plugged in?

Has a fuse blown, or has a circuit breaker tripped?

Was a regular fuse used? Use a time-delay fuse.

Is the dryer door firmly closed?

Was the START button firmly pressed?

Is a cycle selected?

Unusual sounds

■ Has the dryer had a period of non-use?

If the dryer hasn't been used for a while, there may be a thumping sound during the first few minutes of operation.

Lint on load

■ Is the lint screen clogged?

Clean lint screen. Check for air movement.

■ Is the load properly sorted?

Sort lint givers (towels, chenille) from lint takers (corduroy, synthetics). Also sort by color.

■ Is the load too big or too heavy?

Dry smaller loads so lint can be carried to the lint screen.

■ Was the load overdried?

Use correct dryer settings for load type. Overdrying can cause lint-attracting static electricity (see "Drying, Cycle, and Temperature Tips").

■ Was paper or tissue left in pockets?

■ Is pilling being mistaken for lint?

Pilling (surface fuzz) is caused by normal wear and laundering.

Stains on load or color change

■ Was dryer fabric softener properly used?

Add dryer fabric softener sheets at the beginning of the cycle. Fabric softener sheets added to a partially-dried load can stain your garments.

■ Were items soiled when placed in the dryer?

Items should be clean before being dried.

■ Were items properly sorted?

Sort light colors from dark colors. Sort colorfast items from noncolorfast items.

Items shrinking

■ Was the dryer overloaded?

Dry smaller loads that can tumble freely.

■ Did the load overdry?

Check the manufacturer's care label. Match dryer setting to load type (see "Drying, Cycle, and Temperature Tips").

Loads are wrinkled

■ Was the load removed from dryer at the end of the cycle?

■ Was the dryer overloaded?

Dry smaller loads that can tumble freely.

■ Did the load overdry?

Check the manufacturer's care label. Match dryer setting to load type (see "Drying, Cycle, and Temperature Tips").

Odors

■ Have you recently been painting, staining or varnishing in the area where your laundry center is located?

If so, ventilate the area. When the odors or fumes are gone from the area, re-wash and dry the clothing.

■ Is the dryer being used for the first time?

The new electric heating element may have an odor. The odor will be gone after the first cycle.

Garment damage

■ Check the following:

Were zippers, snaps, and hooks left open?

Were strings and sashes tied to prevent tangling?

Were care label instructions followed?

Were items damaged before drying?

Get it fixed, at your home or ours!

For repair of major brand appliances **in your own home...**
no matter who made it, no matter who sold it!

1-800-4-MY-HOME® Anytime, day or night
(1-800-469-4663) (U.S.A. and Canada)

www.sears.com

www.sears.ca

For repair of carry-in products like vacuums, lawn equipment,
and electronics, call for the location of your nearest
Sears Parts and Repair Center.

1-800-488-1222 Anytime, day or night (U.S.A. only)

www.sears.com

For the replacement parts, accessories and owner's manuals
that you need to do-it-yourself, call **Sears PartsDirectSM!**

1-800-366-PART 6 a.m. – 11 p.m. CST, 7 days a week
(1-800-366-7278) (U.S.A. only)

www.sears.com/partsdirect

To purchase or inquire about a Sears Service Agreement
or Sears Maintenance Agreement:

1-800-827-6655 (U.S.A.)

7 a.m. – 5 p.m. CST, Mon. – Sat.

1-800-361-6665 (Canada)

9 a.m. – 8 p.m. EST, M – F, 4 p.m. Sat.

Para pedir servicio de reparación a
domicilio, y para ordenar piezas:

1-888-SU-HOGARSM
(1-888-784-6427)

Au Canada pour service en français:

1-800-LE-FOYER^{MC}
(1-800-533-6937)
www.sears.ca

