



# Automatic Washers with CALYPSO™ Wash Motion

Use and Care Guide

# Lavadoras automáticas con movimiento de lavado CALYPSO™

Manual de Uso y Cuidado

# Laveuses automatiques à mouvement de lavage CALYPSO™

Guide d'utilisation et d'entretien

ENGLISH

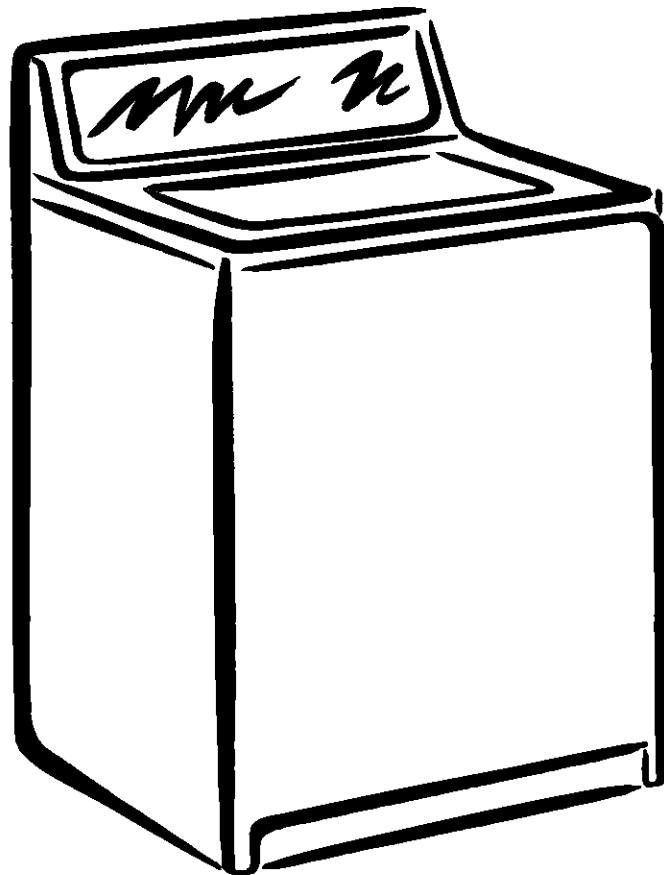

---

# TABLE OF CONTENTS

<b>SERVICE</b> .....	<b>2</b>
<b>WARRANTY</b> .....	<b>3</b>
<b>WASHER SAFETY</b> .....	<b>4</b>
<b>INSTALLATION REQUIREMENTS</b> .....	<b>5</b>
Tools and Parts .....	5
Alternate Parts .....	5
Location Requirements .....	5
Drain System .....	6
Electrical Requirements.....	6
<b>INSTALLATION INSTRUCTIONS</b> .....	<b>7</b>
Install Leveling Feet.....	7
Connect Drain Hose.....	8
Connect Inlet Hoses.....	8
Secure Drain Hose .....	9
Level Washer .....	9
Complete Installation.....	9
<b>FEATURES AND BENEFITS</b> .....	<b>10</b>
CALYPSO™ Wash Motion.....	10
<b>WASHER USE</b> .....	<b>11</b>
Starting Your Washer .....	11
Pausing or Restarting .....	12
Changing Cycles, Options and Modifiers .....	12
Cycles.....	12
What Happens in a Wash Cycle .....	13
Options .....	14
Modifiers .....	15
<b>LAUNDRY TIPS</b> .....	<b>16</b>
Loading.....	16
<b>WASHER CARE</b> .....	<b>17</b>
Cleaning Your Washer.....	17
Water Inlet Hoses .....	17
Vacation, Storage, and Moving Care .....	17
<b>TROUBLESHOOTING</b> .....	<b>18</b>
<b>LID INSTRUCTIONS</b> .....	<b>20</b>

---

# SERVICE

In the U.S.A.

## Master Protection Agreements

Congratulations on making a smart purchase. Your new Kenmore® appliance is designed and manufactured for years of dependable operation. But like all products, it may require preventive maintenance or repair from time to time. That's when having a Master Protection Agreement can save you money and aggravation.

*Purchase a Master Protection Agreement now and protect yourself from unexpected hassle and expense.*

The Master Protection Agreement also helps extend the life of your new appliance. Here's what's included in the Agreement:

- ✓ **Expert service** by our 12,000 professional repair specialists
- ✓ **Unlimited service and no charge** for parts and labor on all covered repairs
- ✓ **"No-lemon" guarantee** – replacement of your covered product if more than three product failures occur within twelve months
- ✓ **Product replacement** if your covered product can't be fixed
- ✓ **Annual Preventive Maintenance Check** at your request – no extra charge
- ✓ **Fast help by phone** – non-technical and instructional assistance on products repaired in your home, plus convenient repair scheduling
- ✓ **Power surge protection** against electrical damage due to power fluctuations
- ✓ **Rental reimbursement** if repair of your covered product takes longer than promised

Once you purchase the Agreement, a simple phone call is all that it takes for you to schedule service. You can call anytime day or night, or schedule a service appointment online.

Sears has over 12,000 professional repair specialists, who have access to over 4.5 million quality parts and accessories. That's the kind of professionalism you can count on to help prolong the life of your new purchase for years to come. Purchase your Master Protection Agreement today!

**Some limitations and exclusions apply. For prices and information call 1-800-827-6655.**

## Sears Installation Service

For Sears guaranteed professional installation of home appliances and items like garage door openers and water heaters, in the U.S.A. call **1-800-4-MY-HOME®**.

---

## In Canada

Your purchase has added value because you can depend on Sears HomeCentral® for service. With over 2,400 Service Technicians and access to over 900,000 parts and accessories, we have the tools, parts, knowledge and skills to back our pledge: We Service What We Sell.

### Sears Maintenance Agreements

Your Kenmore® appliance is designed, manufactured and tested to provide years of dependable operation. Yet any major appliance may require service from time to time. The Sears Maintenance Agreement offers you an outstanding service program, affordably priced.

#### The Sears Maintenance Agreement

- Guarantees tomorrow's service at today's price.
- Eliminates repair bills resulting from normal wear and tear.
- Covers non-technical and instructional service calls.
- Provides an annual Preventive Maintenance Check, at your request, to ensure that your appliance is in proper running condition.

Some limitations apply. For information concerning Sears Home Central® Maintenance Agreements, call 1-800-361-6665.

---

# WARRANTY

### Limited Lifetime Warranty on Stainless Steel Basket

For the lifetime of the washer from the date of purchase, Sears will replace the Stainless Steel wash basket due to defective material or workmanship. This warranty does not include any polishing marks found in the bottom of the basket which occurs during the break in period of the washer. You will be charged for labor after the first year.

### Limited Ten-Year Warranty on Plastic Tub\*

For the second through tenth year from the date of purchase, Sears will replace the plastic tub if defective in material or workmanship. You will be charged for labor after the first year.

### Limited Five-Year Warranty on Drive System Parts\*

For the second through fifth year from the date of purchase, Sears will replace the following drive system parts if defective in material or workmanship. The washplate shaft, drive pulley, lower drive bearing plate and drive belt. You will be charged for labor after the first year.

### Limited Two-Year Warranty on SENSOR SMART™ Electronic Control Board

For two years from the date of purchase, Sears will replace the electronic control boards if defective in material or workmanship. You will be charged for labor after the first year.

### Full One-Year Warranty on Mechanical and Electrical Parts

For one year from the date of purchase, when this washer is installed and operated according to the instructions provided in the Use and Care Guide, Sears will repair or replace any of its mechanical or electrical parts if defective in material or workmanship.

### Warranty Restriction

If the washer is subject to other than private family use, the above warranty coverage is effective for only 90 days.

### Warranty Service

Warranty service is available by contacting the nearest Sears Service Center in the United States or Canada. This warranty applies only while the product is in use in the United States or Canada. This warranty gives you specific legal rights and you may also have other rights which vary from state to state or province to province.

\*Warranty terms may vary in Canada.

Please reference the service numbers located on the back page of this manual.

Sears, Roebuck and Co.  
D/817WA, Hoffman Estates, IL 60179  
Sears Canada, Inc.  
Toronto, Ontario, Canada M5B 2B8

### Product Record

In the space below, record your complete model number, serial number, and purchase date. You can find this information on the model and serial number label, as shown.

Have this information available to help you quickly obtain assistance or service when you contact Sears concerning your appliance.

Model number 110 \_\_\_\_\_

Serial number \_\_\_\_\_

Purchase date \_\_\_\_\_

Save these instructions and your sales receipt for future reference.

# WASHER SAFETY

## Your safety and the safety of others are very important.

We have provided many important safety messages in this manual and on your appliance. Always read and obey all safety messages.



This is the safety alert symbol.

This symbol alerts you to potential hazards that can kill or hurt you and others.

All safety messages will follow the safety alert symbol and either the word "DANGER" or "WARNING." These words mean:

**! DANGER**

**You can be killed or seriously injured if you don't immediately follow instructions.**

**! WARNING**

**You can be killed or seriously injured if you don't follow instructions.**

All safety messages will tell you what the potential hazard is, tell you how to reduce the chance of injury, and tell you what can happen if the instructions are not followed.

## IMPORTANT SAFETY INSTRUCTIONS

**WARNING:** To reduce the risk of fire, electric shock, or injury to persons when using the washer, follow basic precautions, including the following:

- Read all instructions before using the washer.
- Do not wash articles that have been previously cleaned in, washed in, soaked in, or spotted with gasoline, dry-cleaning solvents, other flammable, or explosive substances as they give off vapors that could ignite or explode.
- Do not add gasoline, dry-cleaning solvents, or other flammable, or explosive substances to the wash water. These substances give off vapors that could ignite or explode.
- Under certain conditions, hydrogen gas may be produced in a hot water system that has not been used for 2 weeks or more. **HYDROGEN GAS IS EXPLOSIVE.** If the hot water system has not been used for such a period, before using the washing machine, turn on all hot water faucets and let the water flow from each for several minutes. This will release any accumulated hydrogen gas. As the gas is flammable, do not smoke or use an open flame during this time.
- Do not allow children to play on or in the washer. Close supervision of children is necessary when the washer is used near children.
- Before the washer is removed from service or discarded, remove the door or lid.
- Do not reach into the washer if the drum, tub or agitator is moving.
- Do not install or store the washer where it will be exposed to the weather.
- Do not tamper with controls.
- Do not repair or replace any part of the washer or attempt any servicing unless specifically recommended in this manual or in published user-repair instructions that you understand and have the skills to carry out.
- See "Electrical Requirements" for grounding instructions.

**SAVE THESE INSTRUCTIONS**

# INSTALLATION REQUIREMENTS

## Tools and Parts

Assemble the necessary tools and supplies before beginning the washer installation. The parts supplied are in the washer basket. Do not put the expanded foam plug back into the washer.

### Tools needed for connecting the drain hose and water inlet hoses

- Pliers that open to 1 $\frac{1}{16}$  in. (3.95 cm)
- Flashlight (optional)

### Parts supplied:

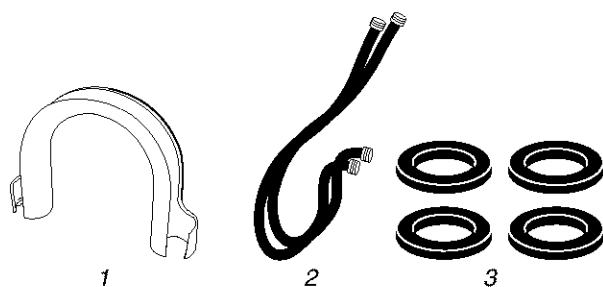

1. Drain hose "hook"
2. Water inlet hoses (2)
3. Flat water inlet hose washers (4)

### Tools needed for securing the drain hose and leveling the washer

- Adjustable or open end wrench  $\frac{9}{16}$  in. (14 mm)
- Level
- Wood block
- Ruler or measuring tape

### Parts supplied:

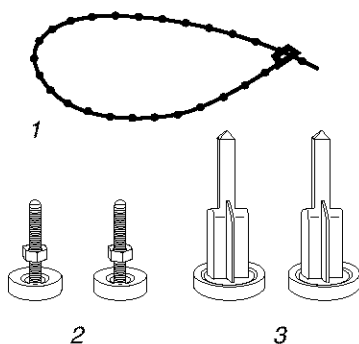

1. Beaded tie strap
2. Front leveling feet with nuts (2)
3. Rear self-adjusting feet (2)

## Alternate Parts

Parts listed are available from your local Sears store or Sears Service Center. Please reference the service numbers located on the back page of this manual.

If You Have	You Will Need to Buy
Laundry tub or standpipe taller than 96 in. (2.4 m)	Sump pump system (if not already available)
1 in. (2.5 cm) diameter standpipe	2 in. (5 cm) diameter to 1 in. (2.5 cm) diameter standpipe adapter, Part No. 3363920
Overhead sewer	Standard 20 gal. (76 L) 39 in. (99 cm) tall drain tub or utility sink and sump pump (available from local plumbing suppliers)
Floor drain	Siphon break, Part Number 285834; additional drain hose, Part Number 8318155 and connector kit, Part Number 285835
Drain hose too short	Drain hose, Part Number 8329541 and connector kit, Part Number 285835
Lint clogged drain	Drain protector, Part Number 367031 and connector kit, Part Number 285835
Water faucets beyond reach of fill hoses	2 longer water fill hoses: 6 ft (1.8 m) Part Number 76314, 10 ft (3.0 m) Part Number 350008

## Location Requirements

Selecting the proper location for your washer improves performance and minimizes noise and possible washer "walk."

Your washer can be installed in a basement, laundry room, closet, or recessed area. (See "Drain System.")

**IMPORTANT:** Do not install or store the washer where it will be exposed to the weather.

Proper installation is your responsibility.

### You will need:

- A water heater set to deliver 120°F (49°C) water to the washer.
- A grounded electrical outlet located within 4 ft (1.2 m) of where the power cord is attached to the back of the washer. (See "Electrical Requirements.")
- Hot and cold water faucets located within 4 ft (1.2 m) of the hot and cold water fill valves, and water pressure of 20-100 psi (138-690 kPa).
- A level floor with a maximum slope of 1 in. (2.5 cm) under entire washer. Installing the washer on carpeting is not recommended.
- A sturdy floor to support the washer weight (washer, water and load) of 315 lbs (143 kgs).

Do not store or operate your washer in temperatures at or below 32°F (0°C). Some water can remain in the washer and can cause damage in low temperatures. See "Washer Care" for winterizing information.

## Recessed area or closet installation

The dimensions shown are for the recommended spacing allowed, except the closet door ventilation openings. The dimensions shown for the closet door ventilation openings are the minimum required.

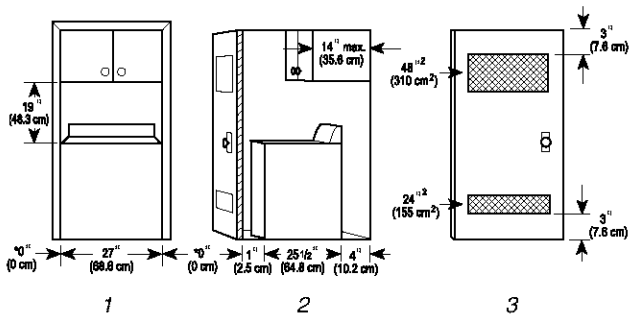

1. Front view  
2. Side view  
3. Closet door with vents

- Additional spacing should be considered for ease of installation and servicing.
- Additional clearances may be required for wall, door and floor moldings.
- Additional spacing of 1 in. (2.5 cm) on all sides of the washer is recommended to reduce noise transfer.
- If a closet door is installed, the minimum air openings in the top and bottom of the door are required. Louvered doors with air openings in the top and bottom are acceptable.
- Companion appliance spacing should also be considered.

## Drain System

The washer can be installed using the standpipe drain system (floor or wall), the laundry tub drain system, or the floor drain system. Select the drain hose installation method you need. (See “Alternate Parts.”)

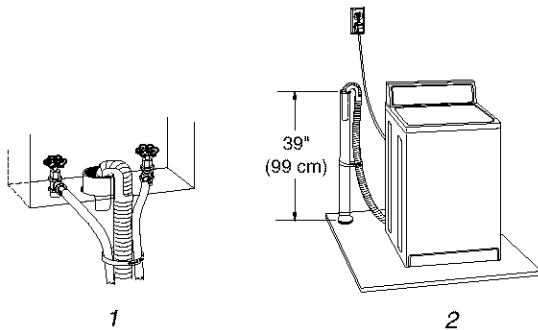

### Standpipe drain system - wall or floor (view 1 & 2)

The standpipe drain requires a minimum diameter standpipe of 2 in. (5 cm). The minimum carry-away capacity can be no less than 17 gal. (64 L) per minute. A 2 in. (5 cm) diameter to 1 in. (2.5 cm) diameter standpipe adapter kit is available. See “Alternate Parts.”

The top of the standpipe must be at least 39 in. (99 cm) high and no higher than 96 in. (2.4 m) from the bottom of the washer.

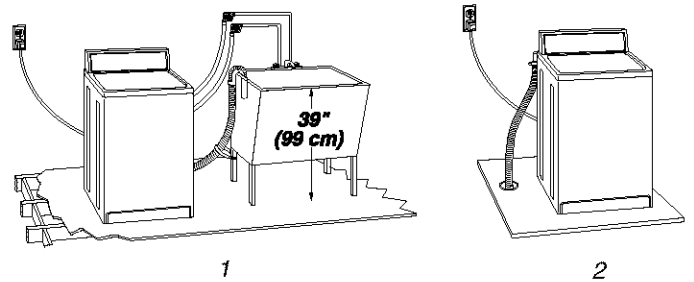

### Laundry tub drain system (view 1)

The laundry tub needs a minimum 20 gal. (76 L) capacity. The top of the laundry tub must be at least 39 in. (99 cm) above the floor and no higher than 96 in. (2.4 m) from the bottom of the washer.

### Floor drain system (view 2)

The floor drain system requires a siphon break that may be purchased separately. (See “Alternate Parts.”)

The siphon break must be a minimum of 28 in. (71 cm) from the bottom of the washer. Additional hoses might be needed.

## Electrical Requirements

### ⚠ WARNING



#### Electrical Shock Hazard

**Plug into a grounded 3 prong outlet.**

**Do not remove ground prong.**

**Do not use an adapter.**

**Do not use an extension cord.**

**Failure to follow these instructions can result in death, fire, or electrical shock.**

- A 120-volt, 60-Hz., AC-only, 15- or 20-ampere, fused electrical supply is required. Time-delay fuse or circuit breaker is recommended. It is recommended that a separate circuit serving only this appliance be provided.
- This washer is equipped with a power supply cord having a 3 prong ground plug.
- To minimize possible shock hazard, the cord must be plugged into a mating, 3 prong, ground-type outlet, grounded in accordance with local codes and ordinances. If a mating outlet is not available, it is the personal responsibility and obligation of the customer to have the properly grounded outlet installed by a qualified electrician.
- If codes permit and a separate ground wire is used, it is recommended that a qualified electrician determine that the ground path is adequate.

- Do not ground to a gas pipe.
- Check with a qualified electrician if you are not sure the washer is properly grounded.
- Do not have a fuse in the neutral or ground circuit.

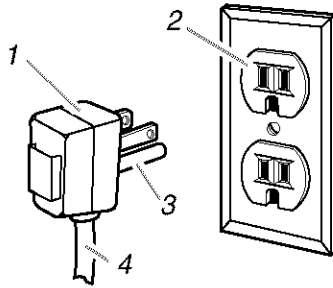

1. 3 prong grounding plug
2. 3 prong grounding-type outlet
3. Ground prong
4. Power supply cord

## GROUNDING INSTRUCTIONS

### For a grounded, cord-connected washer:

This washer must be grounded. In the event of a malfunction or breakdown, grounding will reduce the risk of electrical shock by providing a path of least resistance for electric current. This washer is equipped with a cord having an equipment-grounding conductor and a grounding plug. The plug must be plugged into an appropriate outlet that is properly installed and grounded in accordance with all local codes and ordinances.

**WARNING:** Improper connection of the equipment-grounding conductor can result in a risk of electric shock. Check with a qualified electrician or serviceman if you are in doubt as to whether the appliance is properly grounded.

Do not modify the plug provided with the appliance – if it will not fit the outlet, have a proper outlet installed by a qualified electrician.

### For a permanently connected washer:

This washer must be connected to a grounded metal, permanent wiring system, or an equipment grounding conductor must be run with the circuit conductors and connected to the equipment-grounding terminal or lead on the appliance.

# INSTALLATION INSTRUCTIONS

## Install Leveling Feet

### **⚠ WARNING**

**Excessive Weight Hazard**  
Use two or more people to move and install washer.

**Failure to do so can result in back or other injury.**

### Install the rear self-adjusting feet

1. To prevent floor damage, set the washer onto cardboard.
2. Move the washer to within approximately 3 ft (90 cm) of the final location.
3. Prop up the rear of the washer about 4 in. (10.2 cm) with a wood block or similar object. The block needs to support the weight of the washer.
4. Install the self-adjusting rear feet by pushing all the way up into the hole shown below.

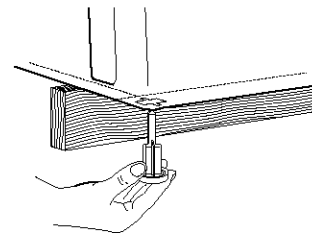

5. Tilt the washer forward and remove the wood block. Gently lower the washer to the floor.

### Install the front leveling feet

6. Prop up the front of the washer about 4 in. (10.2 cm) with a wood block or similar object. The block needs to support the weight of the washer.
7. Screw the lock nut onto each foot to within 1 in. (2.5 cm) of the base.

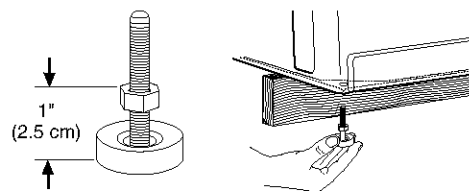

8. Screw the feet into the correct holes at the front corner of the washer until the nuts touch the washer.

**NOTE:** Do not tighten the nuts until the washer is level.

9. Tilt the washer back and remove the wood block. Gently lower the washer to the floor.

## Connect Drain Hose

Proper connection of the drain hose protects your floors from damage due to water leakage. Carefully read and follow these instructions.

The drain hose is connected to your washer and is stored inside of the washer cabinet.

### Remove drain hose from washer cabinet

Gently pull the corrugated drain hose out of the washer from the top of the hose. Continue to pull the hose until the end emerges. Do not force excess drain hose back into the rear of the washer.

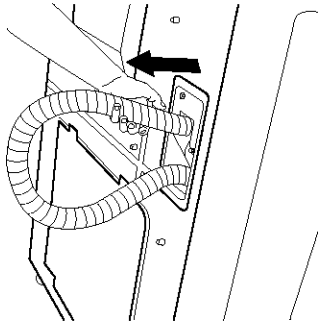

### Laundry tub drain or standpipe drain

Connecting the drain hose "hook" to the corrugated drain hose

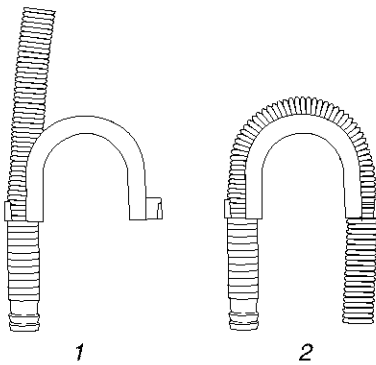

1. Snap either end of the drain hose "hook" to the drain hose at the point where the corrugation begins.
2. Bend drain hose over drain hose "hook" and snap into place.

### To prevent drain water from going back into the washer:

- Do not straighten hooked end of the drain hose and force excess drain hose into standpipe. Hose should be secure but loose enough to provide a gap for air.
- Do not lay excess hose on the bottom of the laundry tub.

### Floor drain

Do not install the drain hose "hook" on to the corrugated drain hose. You may need additional parts. (See Floor Drain under "Alternate Parts.")

## Connect Inlet Hoses

1. Insert a new flat washer (supplied) into each end of the inlet hoses. Firmly seat the washers in the couplings.

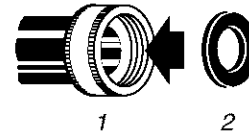

1. Coupling  
2. Washer

### Connect the inlet hoses to the water faucets

Make sure the washer basket is empty.

2. Attach the hose with the red coupling to the hot water faucet. Screw on coupling by hand until seated on the washer.
3. Attach the hose with the blue coupling to the cold water faucet. Screw on coupling by hand until seated on the washer.
4. Using pliers, tighten the couplings with an additional two-thirds turn.

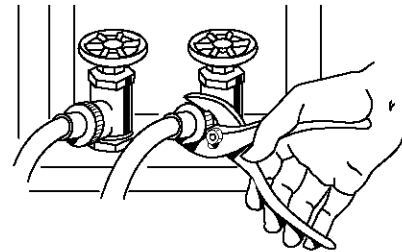

**NOTE:** Do not overtighten. Damage to the valves can result.

### Clear the water lines

5. Run water through both faucets and inlet hoses, into a bucket or laundry tub, to get rid of particles in the water lines that might clog the inlet valve screens.

### Connect the inlet hoses to the washer

6. Attach the hose with the blue coupling to the COLD (left) inlet valve. Screw on coupling by hand until seated on the washer. Using pliers, tighten the couplings with an additional two-thirds turn.

**NOTE:** Do not overtighten. Damage to the valves can result.

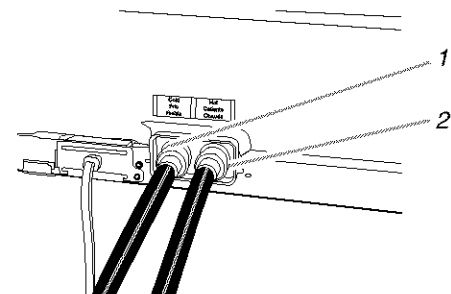

1. Cold water inlet valve (blue)  
2. Hot water inlet valve (red)



- Attach the hose with the red coupling to the HOT water (right) inlet valve. Screw on coupling by hand until seated on the washer. Using pliers, tighten the couplings with an additional two-thirds turn.

**NOTE:** Do not overtighten. Damage to the valves can result.

### Check for leaks

- Turn on the water faucets and check for leaks. A small amount of water might enter the washer. You will drain this later.

**NOTE:** Replace inlet hoses after 5 years of use to reduce the risk of hose failure. Record hose installation or replacement dates for future reference.

Periodically inspect and replace hoses if bulges, kinks, cuts, wear, or leaks are found.

## Secure Drain Hose

- Drape the power cord over the console.
- Move the washer to its final location and remove any cardboard used to move washer.
- Locate the beaded tie strap (supplied).



*Beaded Tie Strap*

- Wrap the drain hose to the laundry tub leg or standpipe with the tie strap. (See illustrations 1 and 2.)

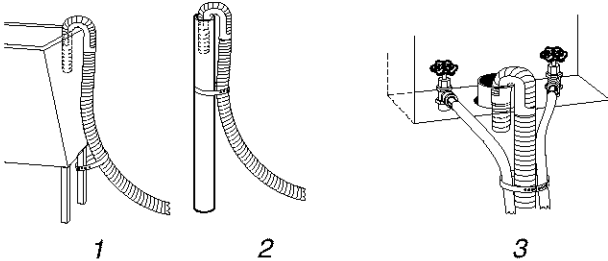

If the washer faucets and the drain standpipe are recessed, put the hooked end of the drain hose in the standpipe. (See illustration 3.) Tightly wrap the tie strap around the water inlet hoses and the drain hose.

Do not force excess drain hose back into the rear of the washer.

## Level Washer

Properly leveling your washer prevents excessive noise and vibration.

- Check the levelness of the washer by placing a level on the top edge of the washer, first side-to-side, then front-to-back.
- If the washer is against a wall, move the washer out slightly before tipping back. If the washer is not level, prop up the front of the washer with the wood block and adjust the feet up or down as necessary. Repeat this step until washer is level.

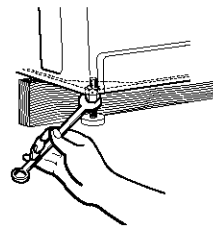
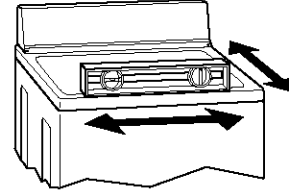

- After the washer is in the final location and level, use a  $\frac{1}{16}$  in. (14 mm) open-end wrench to turn the nuts on the feet tightly against the washer cabinet.
- If the nuts are not tight against the washer cabinet, the washer may vibrate.
- Tilt the washer forward until the rear of the washer is at least 4 in. (10.2 cm) off the floor. You may hear the self-adjusting rear feet click into place. Lower the washer to the floor.

## Complete Installation

- Check the electrical requirements. Be sure that you have the correct electrical supply and the recommended grounding method. (See "Electrical Requirements.")
- Check to be sure all parts are now installed. If there is an extra part, go back through the steps to see which step was skipped.
- Check to be sure you have all of your tools.
- Dispose/recycle all packaging materials. Keep the expanded foam plug for use if the washer should be transported.
- Check to be sure the water faucets are on.

6. Check for leaks around faucets and inlet hoses.

**⚠ WARNING**



**Electrical Shock Hazard**

**Plug into a grounded 3 prong outlet.**

**Do not remove ground prong.**

**Do not use an adapter.**

**Do not use an extension cord.**

**Failure to follow these instructions can result in death, fire, or electrical shock.**

7. Plug into a grounded 3 prong outlet.
8. Remove the protective film on the console and any tape remaining on the washer.
9. Read "Washer Use."
10. To test your washer, measure ½ the normal recommended amount of powdered or liquid detergent and pour it into the detergent dispenser. Close the lid. Select any cycle, and then press START. Allow it to complete one whole cycle.

## FEATURES AND BENEFITS

### CALYPSO™ Wash Motion

Your new washer works differently than most washers that you are accustomed to. The most striking difference is the washer does not have an agitator. It uses the innovative CALYPSO™ wash motion. The Wash Plate, at the bottom of the basket, creates a motion that lifts, rolls and bounces your wash load through a mixture of water and detergent that is continuously reapplied to the load to force out stains and soils.

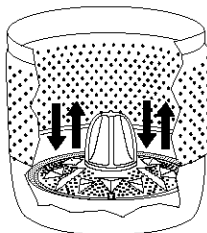

#### The CALYPSO™ wash motion

- Is easier to load (since there is no agitator.)
- Is gentler on clothes. There is less wear and tear on your clothes.
- Fluffs the load after the final spin to make unloading easier.

#### SENSOR SMART™ Electronic Controls

SENSOR SMART electronic controls are easy to use whether you are a beginner or an "expert."

#### TRIPLE SMART™ Dispensers

The TRIPLE SMART dispensers make your washer truly automatic. It is unnecessary for you to return to the washer during the cycle to add detergent, bleach, or fabric softener.

Laundry products are diluted with fresh water and added to the load at the proper time in the wash cycle.

#### Auto Water Level

This washer senses load size and composition, then automatically adjusts water level for best cleaning and rinsing performance. It eliminates the guess work. The water level is just right for every wash load size.

#### Larger Load Size

Since there is no agitator, you can wash larger, bulkier items such as a sleeping bag. You are also able to wash more clothes at one time, which means fewer loads. The KING SIZE™ Capacity Plus allows for loads such as king size bedding. You can wash a pillow or a large stuffed teddy bear.

#### ULTRA QUIET PAK™

The ULTRA QUIET PAK reduces water sounds and ringing noises. The cabinet and base are insulated with sound-dampening materials. An additional tub wrap is added for superior vibration and sound-dampening.

#### Suspension System

To reduce washer "walk" and "out of balance" conditions, your new washer combines:

- 4 Spring damper struts to isolate vibration
- 2 Shock absorbers at the washer base to minimize movement
- Balance ring at the top of the wash basket to minimize vibration

#### Stainless Steel Basket

The Stainless Steel basket eliminates corrosion and enables higher spin speeds for more water extraction, reducing drying time.

#### High-Efficiency Wash System

Your new top loading, high-efficiency washer saves time with fewer, larger loads, conserves resources and lowers your water and energy bills too.

#### Force Filter Wash/Rinse System

This washer filters 100% of the wash and rinse water. The water is filtered then re-circulated. The force filter traps sand and dirt, flushing it down the drain, so it is not re-deposited on the clean clothes.

# WASHER USE

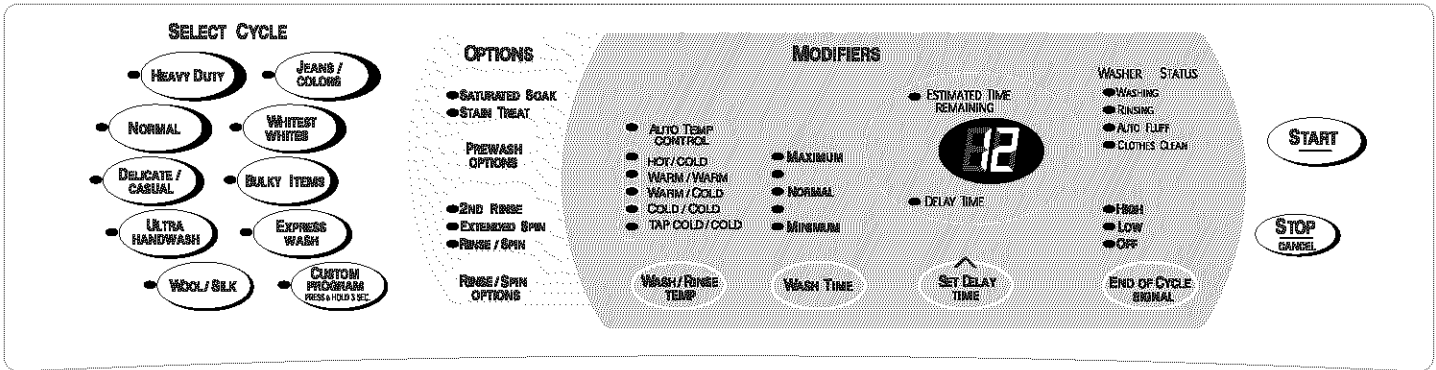

## Starting Your Washer

⚠ WARNING



Fire Hazard

**Never place items in the washer that are dampened with gasoline or other flammable fluids.**

**No washer can completely remove oil.**

**Do not dry anything that has ever had any type of oil on it (including cooking oils).**

**Doing so can result in death, explosion, or fire.**

**WARNING:** To reduce the risk of fire, electric shock, or injury to persons, read the IMPORTANT SAFETY INSTRUCTIONS before operating this appliance.

The following is a guide to starting your washer. Periodic references to other sections of this manual provide more detailed information.

1. Place a load of sorted clothes into the washer. Load to a level shown below. (See "Loading.")

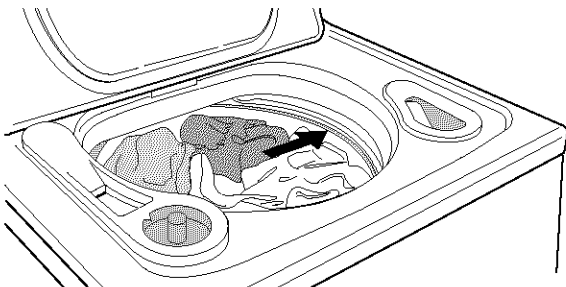

2. Pour measured powdered or liquid detergent into the detergent dispenser.



- For best performance use with High Efficiency detergents. The package for this type of detergent will be marked "HE" or "High Efficiency." The new wash action of the CALYPSO™ system along with less water, could create too much sudsing with a regular detergent. HE detergents such as TIDE® HE are made to produce the right amount of suds for the best performance. Follow the manufacturer's instructions to determine the amount of detergent to use.
- If High Efficiency detergent is not available, use a reduced amount of regular laundry detergent.

**NOTE:** You can add color-safe bleach (liquid or powdered) to this dispenser as well.

3. Pour measured liquid chlorine bleach into the liquid chlorine bleach dispenser, if needed. Bleach is diluted and automatically dispensed at the proper time during the wash cycle.

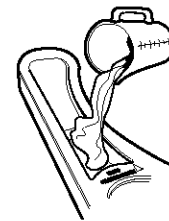

- Do not overfill. Never use more than 1 cup (250 mL) for a full load. Use less with a smaller load size.
- Follow the manufacturer's directions for safe use.
- To avoid spilling, use a cup with a pouring spout. Do not let bleach splash, drip, or run down into the washer basket.

**NOTE:** Use only liquid chlorine bleach in this dispenser.

- Pour measured liquid fabric softener into the fabric softener dispenser, if desired.



- Do not overfill. The dispenser holds 3 oz (94 mL), or a capful of fabric softener.
- The fabric softener is dispensed in the final rinse.
- Do not spill or drip any fabric softener on the clothes.

**NOTE:** Use only liquid fabric softener in this dispenser.

- Close the washer lid.
- Select a Cycle. This turns on the washer display. (See “Cycles.”)
- Select an Option, if desired. (See “Options.”)
- Select the desired Modifiers. (See “Modifiers.”)
- Press START. The wash cycle begins and the display shows the estimated remaining time.

**NOTE:** If you do not press Start within 5 minutes of selecting the cycle, the washer automatically shuts off.

## Pausing or Restarting

### To pause the washer at any time

Press STOP/CANCEL.

### To restart the washer

Close the lid and press START.

## Changing Cycles, Options and Modifiers

You can change Cycles, Options and Modifiers any time before Start is pressed.

- A short tone sounds when a change is selected.
- Two short tones sound if an unavailable combination is selected. The last selection will not be accepted.

### Changing Cycles after pressing Start

- Press STOP/CANCEL twice.
- Select the desired wash cycle.
- Press START.

The washer restarts at the beginning of the new cycle.

**NOTE:** If you do not press Start within 5 minutes of pausing the washer, the washer automatically shuts off.

### Changing Options and Modifiers after pressing Start

You can change an Option or Modifier anytime before the selected Option or Modifier begins.

- Press STOP/CANCEL.
- Select the new Option and/or Modifiers.
- Press START to continue the cycle.

## Cycles

Use these pads to choose the right wash cycle for the type of fabrics you are washing.

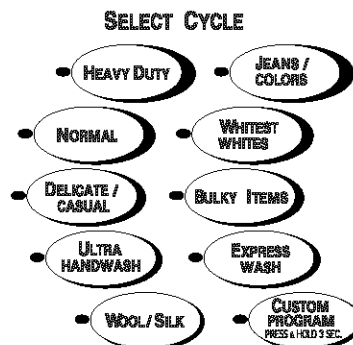

- For most loads, use the time recommended in the preset cycle settings.
- For heavy soil and sturdy fabrics, use more wash time.
- For light soil and delicate fabrics, use less wash time.

### HEAVY DUTY

Use this cycle to get 19 to 23 minutes of wash time for loads of sturdy, colorfast fabrics such as work clothes. Cycle combines high speed wash action and high spin speed. The preset cycle wash time is 23 minutes. If the Heavy Duty load size is small, 6 items or less, it is recommended that the Normal cycle be used. Stain Treat is the default option for this cycle, but it can be turned off. (See “Changing Cycles, Options and Modifiers.”)

### NORMAL

Use this cycle to get 12 to 16 minutes of wash time for normally soiled cottons and linens. Cycle combines medium speed wash action and high spin speed. The preset cycle wash time is 14 minutes. If the Normal load size is small, 6 items or less, it is recommended that the Jeans/Colors cycle be used.

### JEANS/COLORS

Use this cycle to get 14 to 18 minutes of wash time for dark, colored items that may run or fade. Cycle combines low/medium speed wash action and high speed final spin. The preset cycle wash time is 16 minutes.

### WHITEST WHITES

This cycle introduces liquid chlorine bleach to the load at the proper time for improved whitening of your heavily soiled white fabrics. Use this cycle to get 19 to 23 minutes of medium speed wash action and high speed final spin. For maximum soil and stain removal, liquid chlorine bleach must be used. The preset cycle wash time is 23 minutes. Stain Treat is the default option for this cycle, but it can be turned off. (See “Changing Cycles, Options and Modifiers.”)

### DELICATE/CASUAL

Use this cycle to get 12 to 16 minutes of low speed wash action for no-iron fabrics and garments indicating “Gentle” cycle on the care label. Low/medium spin speed is used to reduce wrinkling. The preset cycle wash time is 14 minutes.

### BULKY ITEMS

Use this cycle to get 13 to 17 minutes of wash time for large items like blankets and comforters. Cleaning starts with a spray of water and detergent mixture to thoroughly saturate your large load. This is followed by low/medium wash action and low/medium spin speed to maintain load balance. The preset cycle wash time is 15 minutes.

## ULTRA HANDWASH

Use this cycle to get 7 to 11 minutes of wash time for garments labeled “Hand Wash” and special care items. Gentle cleaning starts with a continuous spray of water and detergent mixture as the load is spun at extra-low speed. This lasts for about one minute and is followed by a brief period of extra-low wash action. Low/medium spin speed helps reduce wrinkling. The preset cycle wash time is 7 minutes.

### Garments are labeled “Hand Wash” because:

- The fiber construction may be sensitive to wash action.
- The fabric contains sensitive dyes that may bleed.

**NOTE:** Some “Hand Wash” items, particularly wool, naturally shrink when washed. Keep this in mind when you purchase items labeled “Hand Wash.” Items that shrink should be dried flat. When still wet, block these items by gently stretching to original measurements.

## EXPRESS WASH

Use this cycle to get 7 to 11 minutes of wash time for small, lightly soiled loads that are needed in a hurry. Fast cleaning starts with a continuous spray of water and detergent mixture as the load is spun at extra-low speed, followed by a brief period of low/medium speed wash action. High spin speed reduces drying time. For the fastest results, select warm wash. The preset cycle wash time is 7 minutes.

## WOOL/SILK

Use this cycle to get 6 to 10 minutes of wash time for washable items that are normally dry cleaned. Cycle combines extra-low speed spray cleaning and wash action to provide gentle care for delicate items, such as wool sweaters and silk blouses. Low spin speed helps garments maintain their shape. The preset cycle wash time is 6 minutes.

## CUSTOM PROGRAM

Custom Program allows you to store a customized wash cycle for future use.

### To Custom Program a wash cycle:

1. Select a cycle.
2. Select the desired Options.
3. Select the desired Modifiers.
4. Press and hold CUSTOM PROGRAM (approximately 3 seconds) until a beep sounds.
5. Press START. The Custom Program cycle is now stored for future use. To reuse the cycle, select CUSTOM PROGRAM and press START.

## Preset Cycle Settings

For ease of use, preset cycle settings provide the recommended fabric care settings for each cycle.

### To use the preset cycle settings:

1. Select the cycle you want by pressing one of the pads under SELECT CYCLE. The preset cycle settings will be displayed (see chart below).
2. Press START. The wash cycle will begin.

## PRESET CYCLE SETTING

Cycle	Preset Minutes	Wash Time*	Wash/Rinse Temperature
HEAVY DUTY	23	MAXIMUM	WARM/COLD
NORMAL	14	NORMAL	WARM/COLD
JEANS/ COLORS	16	NORMAL	WARM/COLD
DELICATE/ CASUAL	14	NORMAL	WARM/COLD
ULTRA HANDWASH	7	MINIMUM	COLD/COLD
EXPRESS WASH	7	MINIMUM	WARM/COLD
WHITEST WHITES	23	NORMAL	HOT/COLD (No ATC)
BULKY ITEMS	15	NORMAL	WARM/COLD
WOOL/SILK	6	MINIMUM	COLD/COLD

\*Wash Time in minutes will appear in the display while making selections. The total cycle time will appear, including an estimated time for drain and fill times, once START is pressed.

## What Happens in a Wash Cycle

After you have loaded the washer, selected the cycle, options and modifiers and you have pressed START, your washer does the following:

### Distributes the load

- Load is initially fluffed to distribute the load before water is added.

### Fills

- Water enters through the dispenser to mix with the detergent. Water continues to be added until the load is soaked and just enough water is present to maintain the spray. This way of washing and rinsing uses less water and makes the detergent more effective in cleaning your clothes. As a result, you will only see a wet load and not a full tub of water, if you open the lid.

### Washes

- As the washer continues to fill, a low speed spin begins and the detergent/water mixture is sprayed on to the load.
- The spinning stops and the CALYPSO™ wash motion begins, while the wash water continues to be sprayed on to the moving load. The length of wash depends on the cycle and wash time selected.
- The CALYPSO™ wash motion features five wash speeds in combination with low-speed spin sprays for a variety of fabric care needs.
- Liquid chlorine bleach is dispensed in the last 2 to 3 minutes of the wash cycle to help ensure the best cleaning results.
- The wash water is then drained and spun out before rinsing begins.

## Rinses

- Rinsing is accomplished in the same manner as washing. Fresh water is added to a slow spinning load. Then the load moves through the spray rinses. The water is then drained away and the rinsing process is repeated. The number of rinses varies depending on the cycle.
- During the last rinse, fabric softener is dispensed into the bottom of the tub and applied to the load.

## Final Spin

- The last of the rinse water is drained and the load is spun. The amount of spinning depends on the cycle selected.

To make unloading easy the load is peeled off the sides of the basket by the CALYPSO™ wash motion.

## Normal Washer Sounds

As with any new product, you will hear sounds that you are not accustomed to. You may hear various sounds occurring during the washing, rinsing and spinning process. Between changes in wash actions, there will be momentary pauses. You will hear water spraying and splashing during the wash and rinse cycles. These new sounds and pauses are part of normal washer operation. (See “Troubleshooting.”)

## Options

Use this feature to select the desired prewash and rinse options for your wash cycle.

### PREWASH OPTIONS

Select a prewash option to ensure thorough cleaning of your heavily soiled and stained loads.

- SATURATED SOAK
- STAIN TREAT

PREWASH  
OPTIONS

### SATURATED SOAK

Use this option for set-in stains and soil that need extra time for removal. Soaking in this washer is different than in a conventional washer. The washer sprays the load with water and detergent for 4 minutes at extra low spin speed followed by a brief period of wash action at the speed of the selected cycle. Then another 4 minutes of spraying and extra low spinning occurs. The wash action then pauses for the detergent to work on the soils. The SATURATED SOAK feature is followed by the selected cycle. Using SATURATED SOAK will extend your wash cycle by 16 minutes.

### STAIN TREAT

This option provides enhanced CATALYST® Cleaning Action for tough stains. The HEAVY DUTY and WHITEST WHITES cycles automatically include STAIN TREAT for total wash times of 23 minutes.

**NOTE:** Deselecting STAIN TREAT from the HEAVY DUTY and WHITEST WHITES cycles will decrease the total wash times to 19 minutes.

STAIN TREAT may be selected as an option with other cycles. See table for details.

Cycle	Stain Treat
HEAVY DUTY	Default (23 minutes total wash time)
NORMAL	Option
JEANS/COLORS	Not available
DELICATE/CASUAL	Option
ULTRA HANDWASH	Option
EXPRESS WASH	Option
WHITEST WHITES	Default (23 minutes total wash time)
BULKY ITEMS	Not available
WOOL/SILK	Not available

## RINSE/SPIN OPTIONS

Selecting this option allows you to choose a 2nd Rinse and Extended Spin option. You may also select and run EXTENDED SPIN and RINSE/SPIN without first selecting a cycle. RINSE/SPIN is not available if a cycle has been selected.

- 2ND RINSE
- EXTENDED SPIN
- RINSE / SPIN

RINSE / SPIN  
OPTIONS

Press RINSE/SPIN OPTIONS until the indicator light next to the desired setting glows.

### 2nd RINSE

Selecting this option provides a second rinse with the same water temperature as selected for the first rinse. A 2nd Rinse can be added to any wash cycle.

### EXTENDED SPIN

This option adds an additional 3 minutes of spin to any cycle to reduce drying time and save energy. If you select EXTENDED SPIN and do not select a wash cycle, you will get an 8 minute, high speed spin.

### RINSE/SPIN

Use this option to get a combination of rinses and spins followed by a high-speed spin. The time display will include an estimate of how long it will take to fill and drain the washer. Fabric softener can be added to the Fabric Softener dispenser.

### When to use Rinse/Spin:

- For loads that need rinsing only.
- For completing a cycle after the power has been off.
- To add fabric softener to load.

### To use or change Rinse/Spin settings:

1. Add fabric softener to the dispenser (if desired).
2. Press the RINSE/SPIN OPTIONS control until the RINSE/SPIN indicator light glows.
3. Press START.

## Modifiers

Modifiers allow you to further customize your cycles and save energy.

### WASH/RINSE TEMP

Select a water temperature based on the type of load you are washing. Use the warmest water safe for fabrics. Follow garment label instructions.

Warm rinses leave the loads dryer than cold rinses. Warm rinses increase wrinkling. In cold climates, a warm rinse makes the load more comfortable to handle. Cold rinses save energy.

### Temperature Guide

Wash Water Temperature	Suggested Fabrics
<b>HOT</b> 111°F (44°C) or above	Whites and pastels Heavy soils
<b>WARM</b> 90°-110°F (32°-43°C)	Bright colors Moderate to light soils
<b>COLD</b> 70°-90°F (21°-32°C)	Colors that bleed or fade Light soils

*In wash water temperatures colder than 70°F (21°C), detergents do not dissolve well. Soils may be difficult to remove.*

### AUTO TEMP CONTROL

ATC (Auto Temp Control) electronically senses and maintains a uniform water temperature. ATC regulates incoming hot and cold water. The ATC is automatically turned On when a cycle is selected. (See “Preset Cycle Settings” in “Cycles.”)

ATC is available with WARM/WARM, WARM/COLD and COLD/COLD settings. The AUTO TEMP CONTROL light will glow indicating that ATC is working.

- AUTO TEMP CONTROL
- HOT / COLD
- WARM / WARM
- WARM / COLD
- COLD / COLD
- TAP COLD / COLD



- ATC ensures consistent cleaning.
- When using ATC, warm water is added to the washer to maintain a temperature of approximately 75°F (24°C), so detergents dissolve properly.
- Warm washes are regulated at approximately 100°F (38°C).
- Warm rinses are regulated at approximately 75°F (24°C). This is a cooler warm rinse than you are used to, but it saves energy and gives proper rinsing. The load is a comfortable temperature to remove from the washer.

## WASH TIME

Wash Time is preset for each wash cycle. (See “Preset Cycle Settings” in “Cycles.”) As you press WASH TIME pad, the cycle time (minutes) will increase or decrease in the ESTIMATED TIME REMAINING display and a different WASH TIME light will glow. To get the minimum wash time, press the pad until the indicator light next to MINIMUM illuminates. This is the shortest wash time available for that cycle.

- MAXIMUM
- 
- NORMAL
- 
- MINIMUM



When a wash cycle is started, the estimated time remaining for the cycle, including fills and drains, will be displayed. The time will count down to the end of the cycle. The ESTIMATED TIME REMAINING light will glow.



### SET DELAY TIME

You can use the SET DELAY TIME feature to delay the start of a wash cycle for up to 11 hours (depending on your model).

1. Load the washer and fill the dispensers.
2. Close the washer lid.
3. Select the desired Cycle, Options and Modifiers.
4. Press SET DELAY TIME. 1H (one hour) will be displayed in the time display window. The indicator light for DELAY TIME will glow.



5. For a longer delay time, press SET DELAY TIME. The time will increase by one-hour steps.
6. Press START. The countdown to the wash cycle will show in the time display window.

#### To change the Delay Time:

- Press STOP/CANCEL.
- Reset the SET DELAY TIME.
- Press START to begin the countdown.

#### To cancel Delay Start:

Press START again to begin the cycle right away or press STOP/CANCEL twice.

## Adjustable END OF CYCLE SIGNAL

A tone will sound at the end of the cycle. The sound level of this tone can be adjusted by pressing END OF CYCLE SIGNAL. The volume of tone you will hear at the end of the cycle will sound as the pads are pressed.

- HIGH
- LOW
- OFF



## Indicator Lights SELECT CYCLE

Located next to each pad, these lights show the cycle you have selected.

### OPTIONS

These lights show the Prewash and/or Rinse/Spin Options you have selected.

### MODIFIERS

These lights show the selected Wash/Rinse Temperature, Wash Time, Estimated Time Remaining in cycle, and End of Cycle Signal.

### WASHER STATUS

These lights show what portion of the cycle the washer is operating.

- WASHER STATUS
- WASHING
  - RINSING
  - AUTO FLUFF
  - CLOTHES CLEAN

## Operating Controls START

Press START to start your washer after a cycle has been selected. Be sure all desired Options and Modifiers have been selected. The lid must be closed for the washer to start.



## STOP/CANCEL

Press STOP/CANCEL once to pause or stop the washer at any time. Press START to complete the cycle from where it was stopped. Press STOP/CANCEL twice to turn off the washer.



# LAUNDRY TIPS

## Preparing clothes for washing

Follow these recommendations to help you prolong the life of your garments.

- Close zippers, snaps, and hooks to avoid snagging other items. Remove pins, buckles, and other hard objects to avoid scratching the washer interior. Remove non-washable trim and ornaments.
- Empty pockets and turn them inside-out.
- Turn down cuffs; brush away lint and dirt.
- Turn synthetic knits inside-out to avoid pilling.
- Tie strings and sashes so they will not tangle.
- Mend tears, loose hems, and seams.
- Treat spots and stains.
- Stained or wet garments should be washed promptly for best results.

## Sorting

- Separate heavily soiled items from lightly soiled ones, even if they would normally be washed together. Separate lint-givers (towels, chenille) from lint-takers (corduroy, synthetics, permanent press). When possible, turn lint-givers inside-out.
- Separate dark colors from light colors, colorfast items from non-colorfast items.
- Sort by fabric and construction (sturdy cottons, knits, delicate items).

## Loading

### Loading suggestions (maximum size loads)

#### KING SIZE™ Capacity Plus Washer

##### Heavy Work Clothes

4 jeans	2 sweatpants
4 workpants	2 sweatshirts
4 workshirts	

##### Towels

10 bath towels	14 washcloths
10 hand towels	

##### Mixed Load

3 sheets (1 king, 2 twin)	9 T-shirts
4 pillowcases	9 shorts
3 shirts	10 handkerchiefs
3 blouses	



---

# WASHER CARE

---

## Cleaning Your Washer

### Cleaning the exterior

Use a soft, damp cloth or sponge to wipe up any spills such as detergent or bleach. Occasionally wipe the outside of your washer to keep it looking new.

### Cleaning the interior

To clean your washer interior, add 1 cup (250 mL) of chlorine bleach and 1 scoop or cap full of detergent into your dispenser, and run the washer through the NORMAL cycle using hot water. Repeat this process if necessary.

**NOTE:** Remove any hard water deposits using only cleaners labeled as washer safe.

---

## Water Inlet Hoses

Replace inlet hoses after five years of use to reduce the risk of hose failure. Periodically inspect and replace inlet hoses if bulges, kinks, cuts, wear or leaks are found.

When replacing your inlet hoses, mark the date of replacement on the label with a permanent marker.

---

## Vacation, Storage, and Moving Care

Install and store your washer where it will not freeze. Because some water may stay in the hoses, freezing can damage your washer. If storing or moving your washer during freezing weather, winterize it.

### Non-use or vacation care:

Operate your washer only when you are at home. If you will be on vacation or not using your washer for an extended period of time, you should:

- Unplug washer or disconnect power.
- Turn off the water supply to the washer. This helps avoid accidental flooding (due to a water pressure surge) while you are away.

### To winterize washer:

1. Shut off both water faucets.
2. Disconnect and drain water inlet hoses.
3. Put 1 quart (1 L) of R.V.-type antifreeze in the basket.
4. Run washer on an EXTENDED SPIN cycle.
5. Unplug washer or disconnect power.

### To use washer again:

1. Flush water pipes and hoses.
2. Reconnect water inlet hoses.
3. Turn on both water faucets.
4. Plug in washer or reconnect power.
5. Run the washer through any cycle with 1/2 the normal recommended amount of detergent to clean out the antifreeze.

### To transport the washer:

1. Shut off both water faucets.
2. Disconnect and drain water inlet hoses.
3. If washer will be moved during freezing weather, put in a quart (1 L) of R.V.-type antifreeze in the basket. Run washer on an EXTENDED SPIN cycle.
4. Disconnect the drain from the drain system.
5. Unplug the power cord.
6. Place the inlet hoses into the basket.
7. Drape the power cord and drain hose over edge and into the basket.
8. Place the expanded foam plug retained from the washer's shipping material into basket opening. Close the lid and put a piece of tape over the lid and down to the front of the washer.

### Re-installing the washer

1. Follow the "Installation Instructions" to locate, level and connect the washer.
2. Run the washer through any cycle with 1/2 the normal recommended amount of detergent to clean out the antifreeze, if used.

---

# TROUBLESHOOTING

---

First try the solutions suggested here and possibly avoid the cost of a service call...

---

## Washer displaying code messages.

If any of these codes continue to occur, call for service.

---

- **“PF” (Power Failure) flashes**  
Was the washing cycle interrupted by a power failure? Press START to continue the cycle from the moment that power was lost, - OR - Press STOP/CANCEL to clear the display and completely cancel the cycle.
  - **“FL” (Over Fill) flashes**  
The washer will beep every 10 seconds with no time-out. The pump will cycle one half minute on, one half minute off, until the over fill switch is reset or power is discontinued to the unit. Press STOP/CANCEL to clear the display. Shut off the water faucets to the inlet hoses if water continues to flow.
  - **“Er” (Processor Reset Error)**  
Cycle information was not stored during a power failure. Press STOP/CANCEL to clear the display.
  - **“LF” (Long Fill) flashes**  
Are the water inlet hoses kinked or clogged?  
Are the water inlet valve screens clear?  
Press STOP/CANCEL to clear the display.
  - **“CE” (Communications Error) flashes - beeps once**  
Press STOP/CANCEL to clear the display.
  - **“Ld” (Long Drain) flashes**  
Is the drain hose kinked or clogged?  
Press STOP/CANCEL to clear the display.
  - **“CA” or “CI” (Current Limit)**  
Is the washer overloaded?  
Press STOP/CANCEL to clear the display.
  - **“Or” (Open Relay)**  
Washer operation failure. Call for service.
  - **“Sr” (Stuck Relay)**  
Washer operation failure. Call for service.
  - **“LS” (Lid Switch Error) flashes**  
Is the washer lid open? Close the lid and press START to continue the cycle.  
  
Is the lid closed? Open and close the lid. Press STOP/CANCEL to clear the display.
  - **“SL” (Suds Lock)**  
Press STOP/CANCEL to clear the display. Drain/Spin load; restart cycle. Do not add detergent. Use cold water.
  - **“dt” (Diagnostic Tests)**  
For service diagnostics only. Press STOP/CANCEL to clear the display.
  - **“ob” (Off Balance)**  
Is the load unbalanced? Redistribute the load. Close lid and press START.
- 

## Washer won't fill, rinse or wash

---

- **Does the water level seem too low, or does the washer appear to not fill completely?**  
This washer uses very little water and never fills completely. Water will not be seen over the top of the wash plate.

- **Check the following:**  
Is the power cord plugged into a grounded 3 prong outlet?  
  
Is there power at the plug? Check electrical source or call electrician.  
  
Are the hot and cold water faucets turned on?  
  
Is the water inlet hose kinked?  
  
Are the water inlet valve screens clogged?
- 

## Washer stops

---

- **Check the following:**  
Is the power cord plugged into a grounded 3 prong outlet?  
  
Is there oversudsing? Cancel the current cycle. Press RINSE/SPIN to drain the load. Re-select your desired cycle and press START. Do not add detergent. Use cold water.  
  
Are the hot and cold water faucets turned on?  
  
Is the water inlet hose kinked?  
  
Are the water inlet valve screens clogged?
  - **After opening the lid, did you press START?**  
If the lid is opened during washer operation, the washer will stop. Closing the lid will not restart the washer. You must press START.
  - **Is there power at the plug?**  
Check electrical source or call electrician.
  - **Has a fuse blown or has the circuit breaker tripped?**  
If problem continues, call electrician.
  - **Are you using an extension cord?**  
Do not use an extension cord.
  - **Is the washer overloaded?**  
Wash smaller loads. See “Starting Your Washer” for maximum load size.
  - **Did you add more items to the load once the washer started?**  
Once the load is wet, there may appear to be space for more items. For best results determine load size with dry items only.
- 

## Washer won't drain or spin

---

- **Is the drain hose clogged, or the end of the drain hose more than 96 in. (244 cm) above the floor?**  
See “Installation Instructions” for proper installation of drain hose.
- **Is the lid open?**  
The lid must be closed during operation.
- **Is there excessive sudsing?**  
For best results, use High Efficiency detergents like TIDE® HE, which produce less suds. Follow manufacturer's directions.
- **Is your voltage low?**  
Check electrical source or call electrician. Do not use an extension cord.

---

### Washer continues to fill or drain, or the cycle seems stuck

---

- **Does the drain hose fit too tightly in the standpipe, or is it taped to the standpipe?**  
The drain hose should be loose yet fit securely. Do not seal the drain hose with tape. The hose needs an air gap. (See “Installation Instructions.”)

---

### Washer makes noise

---

- **Is the load balanced and the washer level?**  
The wash load should be balanced. See “Starting Your Washer” for maximum load size.  
  
The washer must be level. The front feet should be properly installed and the nuts tightened. Reset the rear leveling legs if needed. (See “Installation Instructions.”)  
  
Are the self-adjusting rear feet installed?  
  
Can you hear water spraying? This is part of the wash action.  
  
If water is drained quickly from the washer, you may hear air being pulled through the pump. This happens during the end of draining. It is normal.  
  
When the cycle changes from washing to draining or spinning, you may hear a noise as the drive system shifts. This is normal.
- **Are you washing items with metal snaps, buckles or zippers?**  
You may hear metal items touching the basket. This is normal.
- **Are you washing a small load?**  
You will hear more splashing sounds when washing small loads. This is normal.
- **Is the washer installed on a solid floor?**  
Refer to the “Installation Instructions” for flooring requirements.

---

### Washer leaks

---

- **Check the following:**  
Are the fill hoses tight? Are the fill hose washers properly seated? Is the drain hose clamp properly installed? (See “Installation Instructions.”)
- **Is the sink or drain clogged?**  
Sink, floor drain and standpipe must be able to handle 17 gal. (64.1 L) of water per minute.
- **Is water bouncing off the tub ring or the load?**  
The wash load should be balanced and not overloaded. If not, the fill or spray rinses can bounce off the load.  
  
The washer must be level. The front and rear feet should be properly installed and the nuts tightened. Reset the self-adjusting rear feet if needed. (See “Installation Instructions.”)
- **Did you pull the drain hose from the washer cabinet and install it in a standpipe or laundry tub?**  
(See “Installation Instructions.”)
- **Check household plumbing for leaks.**

---

### Washer basket is crooked

---

- **Is the load balanced and the washer level?**  
The wash load should be balanced.  
  
The washer must be level. The front feet should be properly installed and the nuts tightened. Reset the rear leveling legs, if needed. (See “Installation Instructions.”)

---

### Dispensers clogged or leaking

---

- **Are the laundry products in the correct dispensers?**  
Add the correct amounts of detergent, fabric softener or chlorine bleach to the correct dispenser. Add powdered or liquid color-safe bleach to the detergent dispenser. Do not use the chlorine bleach dispenser for color-safe bleach.

---

### Load too wet

---

- **Did you use the right cycle for the load being washed?**  
Select a cycle with a higher spin speed.
- **Did you use a cold rinse?**  
Cold rinses leave loads wetter than warm rinses. This is normal.
- **Did you use regular laundry detergent?**  
Regular detergent can cause too much suds and leave the load wet. Use High Efficiency detergents like TIDE® HE.

---

### Residue or lint on load

---

- **Did you add detergent to the dispenser?**  
For best results, use the dispenser to dissolve the detergent.
- **Did you sort properly?**  
Sort lint givers (towels, chenille) from lint takers (corduroy, synthetics). Also sort by color.
- **Did you overload the washer?**  
The wash load must be balanced. See “Starting Your Washer” for maximum load size. Lint can be trapped in the load if overloaded. Wash smaller loads.
- **Check the following:**  
Was paper or tissue left in pockets?
- **Did you use enough detergent?**  
Follow manufacturer’s directions. Use enough detergent to hold the lint in the water.
- **Is your water colder than 70°F (21°C)?**  
Wash water colder than 70°F (21°C) may not completely dissolve the detergent.
- **Are you using a gentle wash cycle?**  
Consider using liquid detergent for slow speed cycles like Bulky, Hand Wash, Wool/Silk.

---

### Stains on load

---

- **Did you add detergent to the dispenser?**  
For best results, use the dispenser to dissolve the detergent.
- **Did you use enough detergent?**  
Use enough detergent to remove soil and hold it in suspension. For best performance, use High Efficiency detergents like TIDE® HE, at the manufacturer’s recommended amounts.
- **Did you add fabric softener directly to the load?**  
Use your fabric softener dispenser, if available. Do not drip fabric softener on clothes.
- **Is there above average iron (rust) in water?**  
You may need to install an iron filter.

- **Did you properly sort the load?**  
Sort dark clothes from whites and lights.
- **Did you unload the washer promptly?**  
To avoid dye transfer, unload the washer as soon as it stops.
- **Did you use a fabric softener dispensing ball?**  
Use the fabric dispenser provided with the washer. Dispensing balls will not operate correctly with this washer.
- **Did you use powder detergent in a low speed cycle?**  
Consider using liquid detergent.
- **Did you add detergent, chlorine bleach or fabric softener too late in the cycle?**  
Detergent and chlorine bleach should be added before starting the washer. Fabric softener should be added before the rinse status light is lit.
- **Did you use EXPRESS WASH on a large load?**  
EXPRESS WASH is designed to wash only a few items for best results.

### Load is wrinkled

- **Did you unload the washer promptly?**  
Unload the washer as soon as it stops.
- **Did you use the right cycle for the load being washed?**  
Use the Delicate/Casual cycle or another cycle with a low spin speed to reduce wrinkling.
- **Did you overload the washer?**  
The wash load must be balanced and not overloaded. Loads should move freely during washing.
- **Are the hot and cold water hoses reversed?**  
Check to be sure the hot and cold water hoses are connected to the right faucets. (See "Installation Instructions.")

### Load is tangled or twisted

- **Did you overload the washer?**  
See "Starting Your Washer" for maximum load size. Loads should move freely during washing.

### Gray whites, dingy colors

- **Did you properly sort the load?**  
Dye transfer can occur when mixing whites and colors in a load. Sort dark clothes from whites and lights.
- **Was the wash temperature too low?**  
Use hot or warm washes if safe for the load. Hot water should be at least 111°F (44°C) to clean heavy soils.
- **Did you use enough detergent, or do you have hard water?**  
Use more detergent for washing heavy soils in cold or hard water. Water temperature should be at least 70°F (21°C) for soap to dissolve and work properly.

### Garment damage

- **Check the following:**  
Were sharp items removed from pockets before washing? Empty pockets, zip zippers, snap or hook fasteners before washing.  
Were strings and sashes tied to prevent tangling?  
Were items damaged before washing? Mend rips and broken threads in seams before washing.
- **Did you overload the washer?**  
See "Starting Your Washer" for maximum load size.
- **Did you properly add chlorine bleach?**  
Do not pour chlorine bleach directly on load. Use your liquid chlorine bleach dispenser. Wipe up bleach spills. Undiluted bleach will damage fabrics. Do not place load items on top of the bleach dispenser when loading and unloading the washer.
- **Did you follow the manufacturer's care label instructions?**

### Cycle too long

- **Are you using a High Efficiency Detergent?**  
If using a regular sudsing detergent, the washer may be using extra rinses to remove the suds, which will cause the cycle to run longer. Use a High Efficiency detergent like TIDE® HE, which produces less suds, or reduce the amount of regular detergent.

### Wash temperature is not what I picked

- **Are the hot and cold water inlet hoses reversed?**  
As washing progresses, the wash temperature will decrease slightly for hot and warm washes. This is normal.

## LID INSTRUCTIONS

These instructions are found under the lid of your washer.

GARMENT CARE SYMBOL	WASHER CYCLE	FABRIC / LOAD TYPE
	HEAVY DUTY	EXTRA DIRTY
	NORMAL	COTTONS
	DELICATE / CASUAL	SYNTHETICS / BLENDS
	DELICATE / CASUAL	KNITS
	ULTRA HANDWASH	LINGERIE

GARMENT CARE SYMBOL	WATER TEMP SETTINGS	BLEACH RECOMMENDATION
	HOT WASH	
	WARM WASH	
•	COLD WASH	
△		ANY BLEACH
△		NON-CHLORINE BLEACH
⚡		DO NOT BLEACH

## OPERATING SUGGESTIONS

FOR BEST WASH PERFORMANCE USE A HIGH EFFICIENCY / LOW SUDSING DETERGENT.

### 1. SELECT CYCLE

Select the cycle according to the fabric type being washed. Press START, if OPTIONS and MODIFIERS are the desired settings.

HEAVY DUTY	For sturdy fabrics and heavy soil. <i>Deep cleans ground-in dirt on work clothes and play wear.</i>
JEANS/COLORS	For dark colored cotton items that may run or fade. <i>Reduces fading of dark colored items like denim jeans and casual cottons. (To minimize fading, turn garment inside out before laundering.)</i>
NORMAL	For mixed loads and average soil. <i>Cleans a variety of items including linens and everyday wear.</i>
WHITEST WHITES	For extra whitening and brightening (with 1 cup [250 ml] of liquid chlorine bleach). <i>Deep cleans white items such as underwear, sheets and socks.</i>
DELICATE/CASUAL	For fabric blends and all garments indicating "gentle" cycle on the care label. <i>Keeps colored items like golf shirts, cottons sweaters and wrinkle-resistant clothes looking new and uses a slower spin to prevent wrinkles from setting.</i>
BULKY ITEMS	For thoroughly washing large, bulky items. <i>Cleans big items such as comforters, pillows and rugs.</i>
ULTRA HANDWASH	For garments indicating "hand wash" on the care label. <i>Gently cleans fine washables like lingerie and sweaters.</i>
EXPRESS WASH	For quickly cleaning a few lightly soiled items. <i>Cleans and refreshes your favorite item of clothing in a hurry.</i>
WOOL/SILK	For many washable items normally dry cleaned. <i>Gently cleans items such as wool sweaters and silk blouses.</i>
CUSTOM PROGRAM	For creating your own special cycle. <i>Remembers your personal preferences for future use.</i>











### 2. OPTIONS

PREWASH	SATURATED SOAK	Loosens soils when added to any cycle.
	STAIN TREAT	Removes toughest soils/stains (with 2 measures of detergent).
RINSE/SPIN	2ND RINSE	Adds an additional rinse to any cycle.
	EXTENDED SPIN	Extracts more water from heavy items.
	RINSE/SPIN	Rinses the load without a cycle selected.

### 3. MODIFIERS

WASH/RINSE TEMP	Provides best care and cleaning on AUTO TEMP selections.
WASH TIME	Fine tunes wash time for selected cycle.
SET DELAY TIME	Starts the wash when it is convenient.

### FOR BEST STAIN REMOVAL RESULTS

It's best to wash stains as soon as possible.	Use liquid chlorine bleach dispenser	Use hottest wash temperature safe for fabric.
 Ring around the Collar	✓	<b>WARM or HOT</b>
 Dirty Mechanical Oil		<b>WARM or HOT</b>
 Mud	✓	<b>WARM or HOT</b>
 Ketchup, Tomato Products	✓	<b>WARM or HOT</b>
 Perspiration, Deodorants		<b>WARM or HOT</b>
 Grass	✓	<b>WARM or HOT</b>
 Blood	✓	<b>COLD or WARM</b>
 Ball Point Pen, Ink	✓	<b>WARM or HOT</b>
 Chocolate, Coffee	✓	<b>WARM or HOT</b>
 Cosmetics		<b>WARM or HOT</b>

**Do not tumble dry soiled or stained items. Heat may permanently set stains. For additional information regarding stains refer to owners manual.**

# Get it fixed, at your home or ours!

## Your Home

For repair—in your home—of all major brand appliances, lawn and garden equipment, or heating and cooling systems, **no matter who made it, no matter who sold it!**

For the replacement parts, accessories and owner's manuals that you need to do-it-yourself.

For Sears professional installation of home appliances and items like garage door openers and water heaters.

**1-800-4-MY-HOME® (1-800-469-4663)**

Call anytime, day or night (U.S.A. and Canada)

[www.sears.com](http://www.sears.com)    [www.sears.ca](http://www.sears.ca)

## Our Home

For repair of carry-in items like vacuums, lawn equipment, and electronics, call or go on-line for the location of your nearest **Sears Parts & Repair Center.**

**1-800-488-1222**

Call anytime, day or night (U.S.A. only)

[www.sears.com](http://www.sears.com)

To purchase a protection agreement on a product serviced by Sears:

**1-800-827-6655 (U.S.A.)**

**1-800-361-6665 (Canada)**

Para pedir servicio de reparación a domicilio, y para ordenar piezas:

**1-888-SU-HOGAR<sup>SM</sup>**

(1-888-784-6427)

Au Canada pour service en français:

**1-800-LE-FOYER<sup>MC</sup>**

(1-800-533-6937)

[www.sears.ca](http://www.sears.ca)

# SEARS

®Registered Trademark/™Trademark/SM Service Mark of Sears, Roebuck and Co., used under licensee by Sears Canada.

CALYPSO is a trademark of Whirlpool U.S.A., used under licensee by Sears, Roebuck and Co. and Sears Canada.

®CATALYST is a registered trademark of Whirlpool U.S.A., used under licensee by Sears, Roebuck and Co. and Sears Canada.

®TIDE is a registered trademark of The Procter & Gamble Company.

®Marca Registrada/™Marca de Fábrica/SM Marca de Servicio de Sears, Roebuck and Co., usada bajo licencia de Sears Canada.

CALYPSO es una marca de comercio de Whirlpool, U.S.A., usada bajo licencia de Sears, Roebuck and Co. y Sears Canada.

®CATALYST es una marca registrada de Whirlpool U.S.A. usada bajo licencia de Sears, Roebuck and Co., y Sears Canada.

®TIDE es una marca registrada de The Procter & Gamble Company.

MC Marque de commerce/MD Marque déposée de Sears, Roebuck and Co., en vertu d'un porteur de licence par Sears Canada.

CALYPSO est une marque de commerce de Whirlpool, U.S.A., en vertu d'un porteur de licence par Sears, Roebuck and Co. et Sears Canada.

®CATALYST est une marque déposée de Whirlpool, U.S.A., en vertu d'un porteur de licence par Sears, Roebuck and Co. et Sears Canada. Imreso en los EE. UU.

®TIDE est une marque déposée de The Procter & Gamble Company.

5/02

Printed in U.S.A.

Imprimé aux É.-U.

3955675A

© Sears,  
Roebuck  
and Co.