



Profile Side by Side Refrigerators

Safety Instructions2-4

Operating Instructions

Additional Features12
Automatic Icemaker14
Care and Cleaning16, 17
Crispers and Pans13
CustomCool™7, 8
Ice and Water Dispenser15, 16
Refrigerator Doors12
Replacing the Light Bulbs18
Shelves and Bins10, 11
Temperature Controls5
TurboCool™6
Water Filter9

Installation Instructions

Preparing to Install
the Refrigerator24, 25
Removing and
Replacing Doors23
Trim Kits and Panels19-22
Water Line Installation26-30

Troubleshooting Tips32-34
Normal Operating Sounds31

Consumer Support

Consumer SupportBack Cover
Performance Data Sheet37
Product Registration39, 40
State of California Water
Treatment Device Certificate38
Warranty (Canadian)35
Warranty (U.S.)36

Write the model and serial numbers here:

Model # _____

Serial # _____

Find these numbers on a label inside the refrigerator compartment at the top on the right side.

**Owner's Manual
and Installation**

Models 23, 25, 26, 27 and 29

Profile Côte à Côte Réfrigérateurs

**Manuel d'utilisation
et d'installation**

La section française commence à la page 42

Profile Lado a Lado Refrigeradores

**Manual del propietario
e instalación**

La sección en español empieza en la página 78

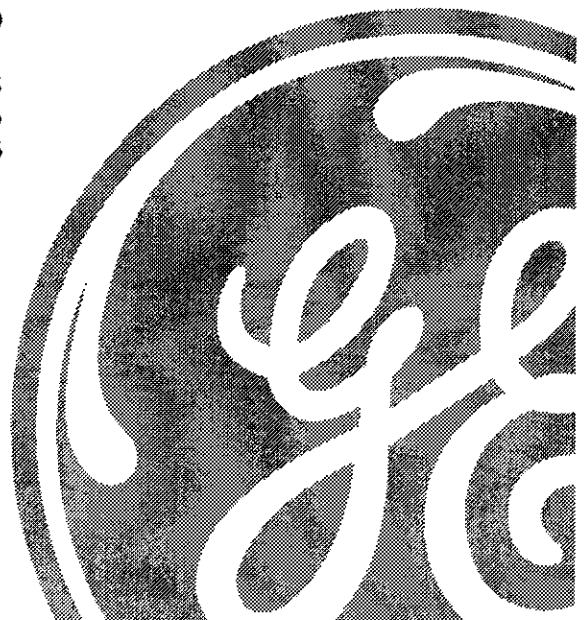

IMPORTANT SAFETY INFORMATION. READ ALL INSTRUCTIONS BEFORE USING.

⚠ WARNING!

Use this appliance only for its intended purpose as described in this Owner's Manual.



SAFETY PRECAUTIONS

When using electrical appliances, basic safety precautions should be followed, including the following:

- This refrigerator must be properly installed and located in accordance with the Installation Instructions before it is used.
- Do not allow children to climb, stand or hang on the shelves in the refrigerator. They could damage the refrigerator and seriously injure themselves.
- Do not touch the cold surfaces in the freezer compartment when hands are damp or wet. Skin may stick to these extremely cold surfaces.
- Do not store or use gasoline or other flammable vapors and liquids in the vicinity of this or any other appliance.
- In refrigerators with automatic icemakers, avoid contact with the moving parts of the ejector mechanism, or with the heating element located on the bottom of the icemaker. Do not place fingers or hands on the automatic icemaking mechanism while the refrigerator is plugged in.
- Keep fingers out of the "pinch point" areas; clearances between the doors and between the doors and cabinet are necessarily small. Be careful closing doors when children are in the area.
- Unplug the refrigerator before cleaning and making repairs.

NOTE: We strongly recommend that any servicing be performed by a qualified individual.
- Setting either or both controls to **0 (off)** does not remove power to the light circuit.
- Do not refreeze frozen foods which have thawed completely.
- Always clean the **CustomCool™** Tray after thawing food.

▲ DANGER! RISK OF CHILD ENTRAPMENT

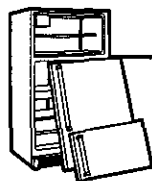

PROPER DISPOSAL OF THE REFRIGERATOR

Child entrapment and suffocation are not problems of the past. Junked or abandoned refrigerators are still dangerous...even if they will sit for "just a few days." If you are getting rid of your old refrigerator, please follow the instructions below to help prevent accidents.

Before You Throw Away Your Old Refrigerator or Freezer:

- Take off the doors.
- Leave the shelves in place so that children may not easily climb inside.

CFC Disposal

Your old refrigerator may have a cooling system that used CFCs (chlorofluorocarbons). CFCs are believed to harm stratospheric ozone.

If you are throwing away your old refrigerator, make sure the CFC refrigerant is removed for proper disposal by a qualified servicer. If you intentionally release this CFC refrigerant you can be subject to fines and imprisonment under provisions of environmental legislation.



USE OF EXTENSION CORDS

Because of potential safety hazards under certain conditions, we strongly recommend against the use of an extension cord.

However, if you must use an extension cord, it is absolutely necessary that it be a UL-listed (in the United States) or a CSA-listed (in Canada), 3-wire grounding type appliance extension cord having a grounding type plug and outlet and that the electrical rating of the cord be 15 amperes (minimum) and 120 volts.

IMPORTANT SAFETY INFORMATION. READ ALL INSTRUCTIONS BEFORE USING.

⚠ WARNING!



HOW TO CONNECT ELECTRICITY

Do not, under any circumstances, cut or remove the third (ground) prong from the power cord. For personal safety, this appliance must be properly grounded.

The power cord of this appliance is equipped with a 3-prong (grounding) plug which mates with a standard 3-prong (grounding) wall outlet to minimize the possibility of electric shock hazard from this appliance.

Have the wall outlet and circuit checked by a qualified electrician to make sure the outlet is properly grounded.

If the outlet is a standard 2-prong outlet, it is your personal responsibility and obligation to have it replaced with a properly grounded 3-prong wall outlet.

The refrigerator should always be plugged into its own individual electrical outlet which has a voltage rating that matches the rating plate.

This provides the best performance and also prevents overloading house wiring circuits which could cause a fire hazard from overheated wires.

Never unplug your refrigerator by pulling on the power cord. Always grip plug firmly and pull straight out from the outlet.

Repair or replace immediately all power cords that have become frayed or otherwise damaged. Do not use a cord that shows cracks or abrasion damage along its length or at either end.

When moving the refrigerator away from the wall, be careful not to roll over or damage the power cord.



USE OF ADAPTER PLUGS *(Adapter plugs not permitted in Canada)*

Because of potential safety hazards under certain conditions, we strongly recommend against the use of an adapter plug.

However, if you must use an adapter, where local codes permit, a **temporary connection** may be made to a properly grounded 2-prong wall outlet by use of a UL-listed adapter available at most local hardware stores.

The larger slot in the adapter must be aligned with the larger slot in the wall outlet to provide proper polarity in the connection of the power cord.

When disconnecting the power cord from the adapter, always hold the adapter in place with one hand while pulling the power cord plug with the other hand. If this is not done, the adapter ground terminal is very likely to break with repeated use.

If the adapter ground terminal breaks, **DO NOT USE** the refrigerator until a proper ground has been established.

Attaching the adapter ground terminal to a wall outlet cover screw does not ground the appliance unless the cover screw is metal, and not insulated, and the wall outlet is grounded through the house wiring. You should have the circuit checked by a qualified electrician to make sure the outlet is properly grounded.



**READ AND FOLLOW THIS SAFETY INFORMATION CAREFULLY.
SAVE THESE INSTRUCTIONS**

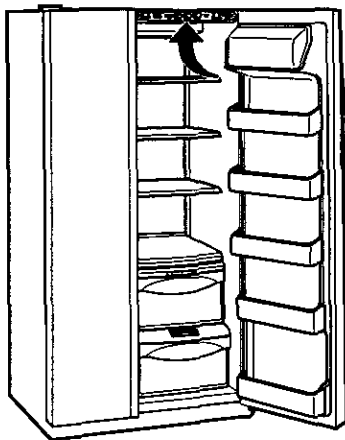
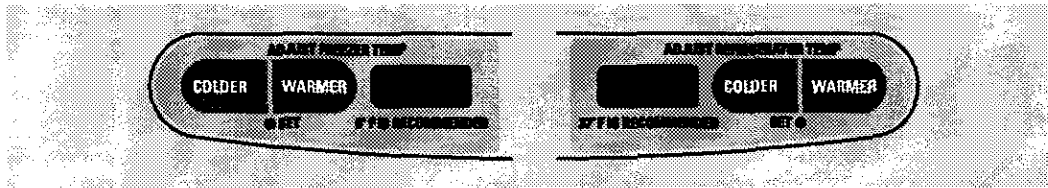

The temperature controls are preset in the factory at **37°F** for the refrigerator compartment and **0°F** for the freezer compartment. Allow 24 hours for the temperature to stabilize to the preset recommended settings.

The temperature controls can display both the **SET** temperature as well as the actual temperature in the refrigerator and freezer. The actual temperature may vary slightly from the **SET** temperature based on usage and operating environment.

Setting either or both controls to **OFF** stops cooling in both the freezer and refrigerator compartments, but does not shut off electrical power to the refrigerator.

NOTE: The refrigerator is shipped with protective film covering the temperature controls. If this film was not removed during installation, remove it now.

To change the temperature, press and release the **WARMER** or **COLDER** pad. The **SET** light will come on and the display will show the set temperature. To change the temperature, tap either the **WARMER** or **COLDER** pad until the desired temperature is displayed. Refrigerator temperatures can be adjusted between 34°F and 44°F and the freezer temperatures can be adjusted between -6°F and +6°F.

Once the desired temperature has been set, the temperature display will return to the actual refrigerator and freezer temperatures after 5 seconds. Several adjustments may be required. Each time you adjust controls, allow 24 hours for the refrigerator to reach the temperature you have set.

To turn the cooling system off, tap the **WARMER** pad for either the refrigerator or the freezer until the display shows **OFF**. To turn the unit back on, press the **COLDER** pad for either the refrigerator or freezer. The **SET** light will illuminate on the side you selected. Then press the **COLDER** pad again (on the side where the **SET** light is illuminated) and it will go to the preset points of **0°F** for the freezer and **37°F** for the refrigerator. Setting either or both controls to **OFF** stops cooling in both the freezer and refrigerator compartments, but does not shut off electrical power to the refrigerator.

Performance Air Flow System

The Performance Air-Flow System is designed to maximize temperature control in the refrigerator and freezer compartments. This unique special feature consists of the Air Tower along the back wall of the refrigerator and the Air Tunnel on the bottom portion of the freezer rear wall. Placing food in front of the louvers on these components will not

affect performance. Although the Air Tower and the Air Tunnel can be removed, doing so will affect temperature performance. (For removal instructions, on-line, 24 hours a day, contact us at GEAppliances.com or call 800.GE.CARES. In Canada, contact us at geappliances.ca or call 1.800.361.3400.)

About TurboCool.™

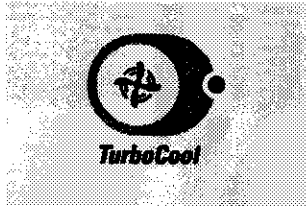

How it Works

TurboCool rapidly cools the refrigerator compartment in order to more quickly cool foods. Use **TurboCool** when adding a large amount of food to the refrigerator compartment, putting away foods after they have been sitting out at room temperature or when putting away warm leftovers. It can also be used if the refrigerator has been without power for an extended period.

Once activated, the compressor will turn on immediately and the fans will cycle on and off at high speed as needed for eight hours. The compressor will continue to run until the refrigerator compartment cools to approximately 34°F (1°C), then it will cycle on and off to maintain this setting. After 8 hours, or if **TurboCool** is pressed again, the refrigerator compartment will return to the original setting.

How to Use

Press **TurboCool**. The refrigerator temperature display will show **TC**.

After **TurboCool** is complete, the refrigerator compartment will return to the original setting.

NOTES: The refrigerator temperature cannot be changed during **TurboCool**.

The freezer temperature is not affected during **TurboCool**.

When opening the refrigerator door during **TurboCool**, the fans will continue to run if they have cycled on.

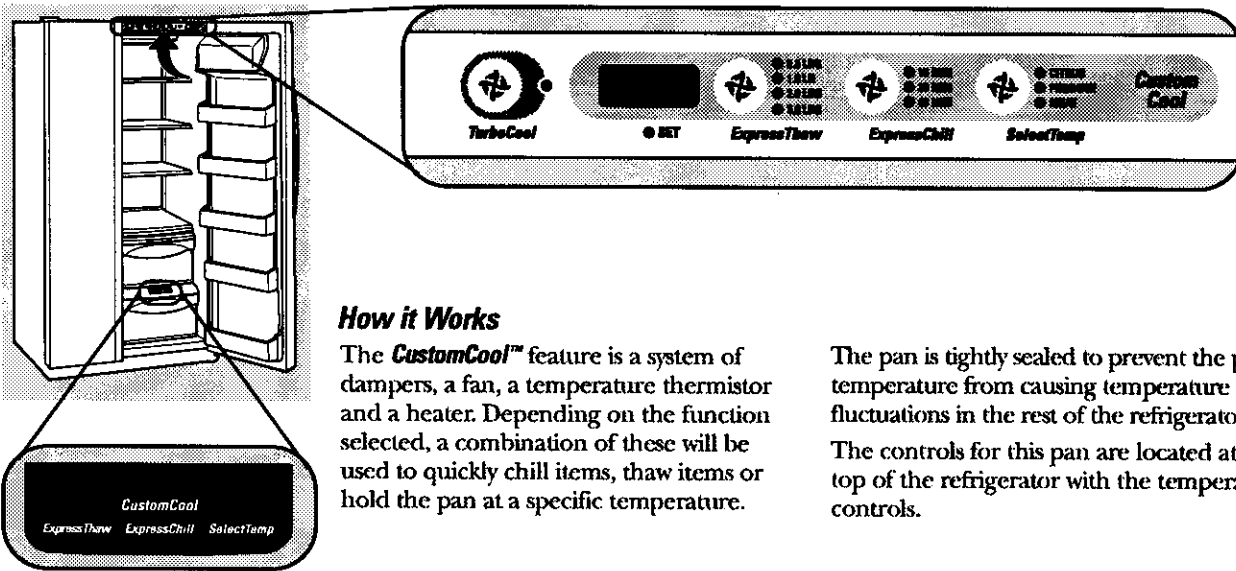

How it Works

The **CustomCool™** feature is a system of dampers, a fan, a temperature thermistor and a heater. Depending on the function selected, a combination of these will be used to quickly chill items, thaw items or hold the pan at a specific temperature.

The pan is tightly sealed to prevent the pan's temperature from causing temperature fluctuations in the rest of the refrigerator. The controls for this pan are located at the top of the refrigerator with the temperature controls.

How to Use

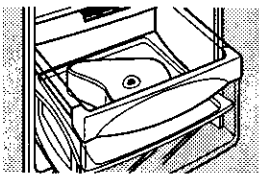

ExpressThaw™

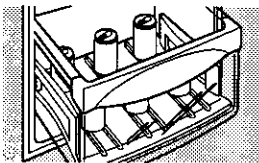

ExpressChill™

- 1 Empty the pan. Place the Chill/Thaw tray in the pan with the metal plate facing down to chill and store items, or with the metal plate facing up to thaw items. Place the items on the tray and close the pan completely.
- 2 Select the **ExpressThaw™**, **ExpressChill™** or **SelectTemp™** pad. The display and **SET** light will come on. Tap the pad until the light appears next to the desired setting. Use the chart to determine the best setting to use.
 - To stop a feature before it is finished, tap that feature's pad until no options are selected and the display is off.
 - During **ExpressThaw™** and **ExpressChill™**, the display on the controls will count down the time in the cycle.

- After the **ExpressThaw™** cycle is complete, the pan will reset to the **MEAT** setting (31°F) to help preserve thawed items until they are used.
- The displayed actual temperature of the **CustomCool** pan may vary slightly from the **SET** temperature based on usage and operating environment.

NOTE: For food safety reasons, it is recommended that foods be wrapped in plastic wrap when using **ExpressThaw™**. This will help contain meat juices and improve thawing performance.

About CustomCool™

CustomCool™ Chart

NOTE: Results may vary depending on packaging, starting temperature and other food traits.

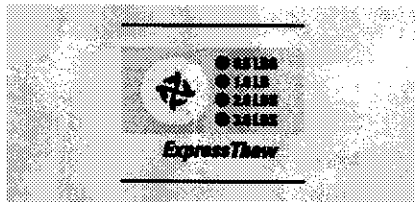

0.5 Lb. (4 hours)

- Hamburger Patties (0.5 lb)
- Individually Wrapped Filet Mignon (0.5 lb)

1.0 Lb. (6 hours)

- Chicken Breasts (1.0 lb)
- Ground Beef (1.0 lb)
- Steak (1.0 lb)

2.0 Lbs. (10 hours)

- Chicken Breasts (2.0 lbs)
- Ground Beef (2.0 lbs)
- Steak (2.0 lbs)

3.0 Lbs. (12 hours)

- Chicken Breasts (3.0 lbs)
- Ground Beef (3.0 lbs)
- Steak (3.0 lbs)

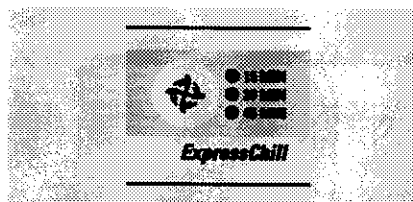

15 Minutes

- 1 Beverage Can (12 oz)
- 2 Small Juice Boxes (6-8 oz each)

30 Minutes

- 2 to 6 Beverage Cans (12 oz each)
- 2 Plastic 20 oz Bottles of Beverage
- 4 to 6 Small Juice Boxes (6-8 oz each)
- 3 Foil Juice Packets
- Wine (750 ml bottle)

45 Minutes

- 2 Liter of Beverage
- 1/2 Gallon of Juice
- Gelatin—1 package

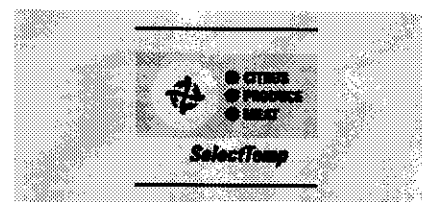

Citrus Setting (43°F)

- Oranges, Lemons, Limes, Pineapple, Cantaloupe
- Beans, Cucumbers, Tomatoes, Peppers, Eggplant, Squash

Produce Setting (35°F)

- Strawberries, Raspberries, Kiwifruit, Pears, Cherries, Blackberries, Grapes, Plums, Nectarines, Apples
- Asparagus, Broccoli, Corn, Mushrooms, Spinach, Cauliflower, Kale, Green Onion, Beets, Onions

Meat Setting (31°F)

- Raw Meat, Fish and Poultry

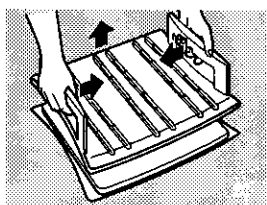

Disassembling the Chill/Thaw tray

About the CustomCool™ Pan Rack and Tray

To clean the Chill/Thaw tray, disassemble the metal tray from the plastic stand by lightly pushing in on the handles of the plastic stand and removing the metal tray. Both the metal tray and the plastic stand are dishwasher safe.

To reassemble the tray, place the plastic stand upside down (handles on bottom) on a solid surface. Place the metal plate on top of the stand matching up the curved side of the plate with the curved side of the stand. Insert one side of the plate into the notches on the stand. Push in on the handle on the other side of the stand while pushing that end of the plate down and into place. You should hear the plate "click" into place.

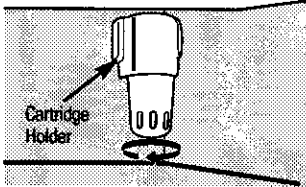
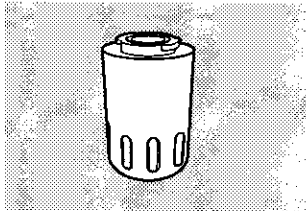

Place the top of the cartridge up inside the cartridge holder and slowly turn it to the right.

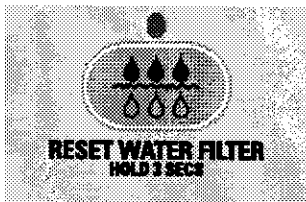
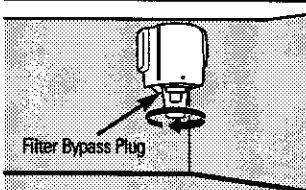

Water Filter Cartridge

The water filter cartridge is located in the back upper right corner of the refrigerator compartment.

When to Replace the Filter

There is a replacement indicator light for the water filter cartridge on the dispenser. This light will turn orange to tell you that you need to replace the filter soon.

The filter cartridge should be replaced when the replacement indicator light turns red or if the flow of water to the dispenser or icemaker decreases.

Installing the Filter Cartridge

- 1 If you are replacing the cartridge, first remove the old one by slowly turning it to the left. **Do not** pull down on the cartridge. A small amount of water may drip down.
- 2 Fill the replacement cartridge with water from the tap to allow for better flow from the dispenser immediately after installation.
- 3 Lining up the arrow on the cartridge and the cartridge holder, place the top of the new cartridge up inside the holder. **Do not** push it up into the holder.

Slowly turn it to the right until the filter cartridge stops. **DO NOT OVERTIGHTEN.** As you turn the cartridge, it will automatically raise itself into position. Cartridge will rotate about 1/4 turn.

- 4 Run water from the dispenser for 3 minutes (about 1½ gallons) to clear the system and prevent sputtering.
- 5 Press and hold the **RESET WATER FILTER** pad on the dispenser for 3 seconds.

NOTE: A newly-installed water filter cartridge may **cause water to spurt** from the dispenser.

Filter Bypass Plug

You must use the filter bypass plug when a replacement filter cartridge is not available. The dispenser and the icemaker will not operate without the filter or filter bypass plug.

Replacement Filters:

To order additional filter cartridges in the United States, visit our Website, GEAppliances.com, or call GE Parts and Accessories, 800.626.2002.

GWF
Suggested Retail \$34.95 USD

Customers in Canada should consult the yellow pages for the nearest Camco Service Center.

About the shelves and bins.

Not all features are on all models.

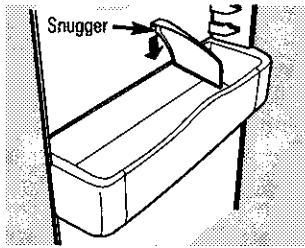

Refrigerator bin

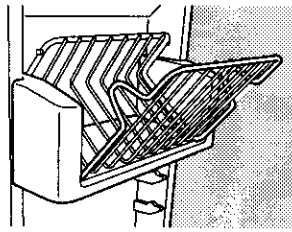

Freezer tilt-out bin

Refrigerator Door Bins and Freezer Door Tilt-Out Bins

Large Bins

The larger refrigerator door bins and freezer tilt-out door bins are adjustable.

To remove: Lift the front of the bin straight up, then lift up and out.

To replace or relocate: Engage the back side of the bin in the molded supports of the door. Then push down on the front of the bin. Bin will lock in place.

Small Bins

To remove: Lift the front of the bin straight up then out.

To replace: Position the bin above the rectangular molded supports on the door. Then slide the bin down onto the support to lock it in place.

The snagger helps prevent tipping, spilling or sliding of small items stored on the door shelf. Place a finger on either side of the snagger near the rear and move it back and forth to fit your needs.

Not all features are on all models.

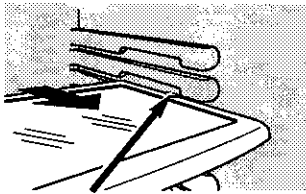

Press tab and pull shelf forward to remove

Slide-Out Spillproof Shelf

The slide-out spillproof shelf allows you to reach items stored behind others. The special edges are designed to help prevent spills from dripping to lower shelves.

To remove:

Slide the shelf out until it reaches the stop, then press down on the tab and slide the shelf straight out.

To replace or relocate:

Line the shelf up with the supports and slide it into place. The shelf can be repositioned when the door is at 90° or more. To reposition the shelf, slide the shelf past the stops and angle downward. Slide shelf down to the desired position, line up with the supports and slide into place.

Make sure you push the shelves all the way back in before you close the door.

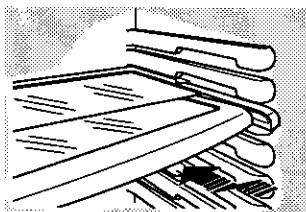
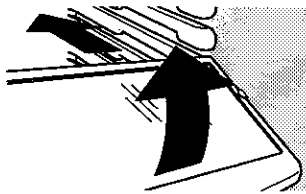

QuickSpace™ Shelf

This shelf splits in half and slides under itself for storage of tall items on the shelf below.

This shelf can be removed and replaced or relocated just like Slide-Out Spillproof Shelves.

On some models, this shelf can not be used in the lowest position.

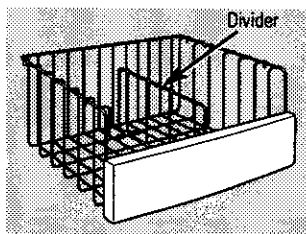

Freezer Baskets

To remove, push the basket all the way to the back of the freezer. Lift up until the back pins are disengaged. Lift the entire basket up and pull out.

The divider can be used to organize food packages. For large packages, simply fold down the divider.

Make sure you push the baskets all the way back in before you close the door.

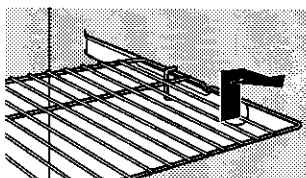

Slide-Out Freezer Shelves

To remove, slide out to the **stop** position, lift the front past the stop position, and slide out.

Make sure you push the shelves all the way back in before you close the door.

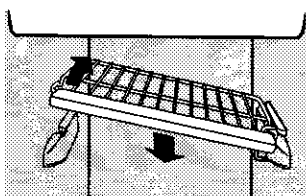

Fixed Freezer Shelves

To remove, lift the shelf up at the left side and then bring the shelf out.

About the additional features.

Not all features are on all models.

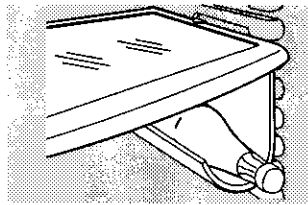

Removable Beverage Rack

The beverage rack is designed to hold a bottle on its side. It can be attached to any slide-out shelf.

To install:

- 1 Line up the large part of the slots on the top of the rack with the tabs under the shelf.
- 2 Then slide the rack back to lock it in place.

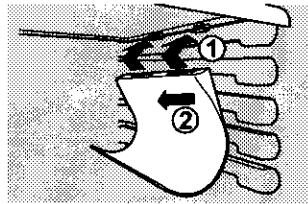

About the refrigerator doors.

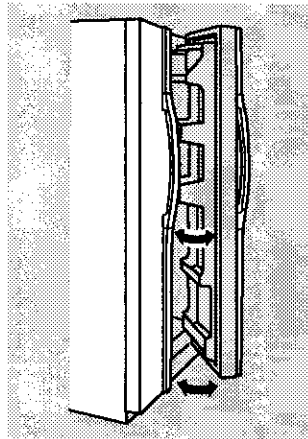

Refrigerator Doors

The refrigerator doors may feel different than the ones you are used to. The special door opening/closing feature makes sure the doors close all the way and are securely sealed.

The resistance you feel at the **stop** position will be reduced as the door is loaded with food.

When opening and closing the door you will notice a **stop** position. If the door is opened past this **stop** point, the door will remain open to allow you to load and unload food more easily. When the door is only partially open, it will automatically close.

When the door is only partially open, it will automatically close.

Beyond this **stop** the door will stay open.

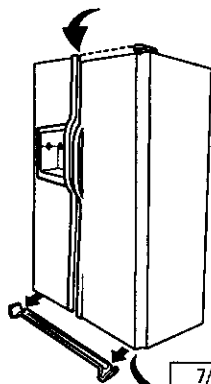

Door Alignment

If doors are uneven, adjust the refrigerator door.

- 1 Using a 7/16" socket wrench, turn the door adjusting screw to the right to raise the door, to the left to lower it. (A nylon plug, imbedded in the threads of the pin, prevents the pin from turning unless a wrench is used.)

- 2 After one or two turns of the wrench, open and close the refrigerator door and check the alignment at the top of the doors.

To remove the base grille, open the doors, remove the screw at each end of the base grille and then pull the grille straight out.

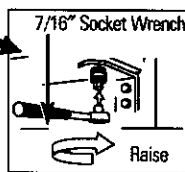

About the crispers and pans.

GEAppliances.com

Not all features are on all models.

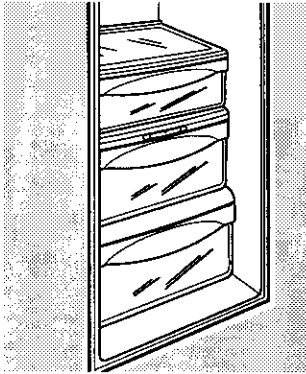

Fruit and Vegetable Crispers

Excess water that may accumulate in the bottom of the drawers should be wiped dry.

On some models, the bottom drawer has a cover that slides back as the drawer is opened. This allows full access to the drawer. As the drawer is closed, the cover will slide forward into its original position.



Adjustable Humidity Crispers

Slide the control all the way to the **HI** setting to provide high humidity recommended for most vegetables.

Slide the control all the way to the **LO** setting to provide lower humidity levels recommended for most fruits.

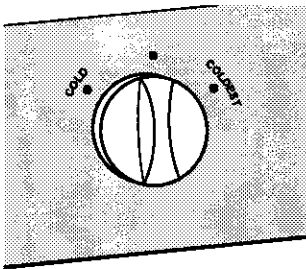

Convertible Meat Pan

The convertible meat pan has its own cold air duct to allow a stream of cold air from the freezer compartment to flow to the pan.

The variable temperature control regulates the air flow from the Climate Keeper.

Set the control to the **coldest** setting to store fresh meats.

Set the control to **cold** to convert the pan to normal refrigerator temperature and provide extra vegetable storage space. The cold air duct is turned off. Variable settings between these extremes can be selected.

About crisper removal.

Not all features are on all models.

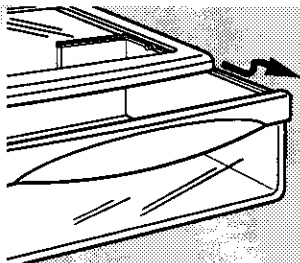

Crisper Removal

Crispers can easily be removed by pulling the drawer straight out and lifting the drawer up and over the **stop** location.

If the door prevents you from taking out the drawers, first try to remove the door bins. If this does not offer enough clearance, the refrigerator will need to be rolled forward until the door opens enough to slide the drawers out. In some cases, when you roll the refrigerator out, you will need to move the refrigerator to the left or right as you roll it out.

Safety Instructions

Operating Instructions

Installation Instructions

Troubleshooting Tips

Consumer Support

About the automatic icemaker.

A newly installed refrigerator may take 12 to 24 hours to begin making ice.

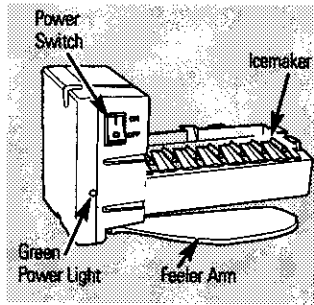

Automatic Icemaker

The icemaker will produce seven cubes per cycle—approximately 100–130 cubes in a 24-hour period, depending on freezer compartment temperature, room temperature, number of door openings and other use conditions.

If the refrigerator is operated before the water connection is made to the icemaker, set the power switch in the **O (off)** position.

When the refrigerator has been connected to the water supply, set the power switch to the **I (on)** position.

The icemaker will fill with water when it cools to 15°F (–10°C). A newly installed refrigerator may take 12 to 24 hours to begin making ice cubes.

You will hear a buzzing sound each time the icemaker fills with water.

Throw away the first few batches of ice to allow the water line to clear.

Be sure nothing interferes with the sweep of the feeler arm.

When the bin fills to the level of the feeler arm, the icemaker will stop producing ice. It is normal for several cubes to be joined together.

If ice is not used frequently, old ice cubes will become cloudy, taste stale and shrink.

NOTE: In homes with lower-than-average water pressure, you may hear the icemaker cycle multiple times when making one batch of ice.

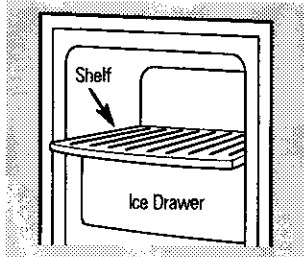

Pull the upper freezer shelf straight out to access the icemaker. Always be sure to replace the shelf. The shelf can be used for storage.

Ice Storage Drawer

To access ice, pull the drawer forward.

To remove the drawer, pull it straight out and lift it past the **stop** location.

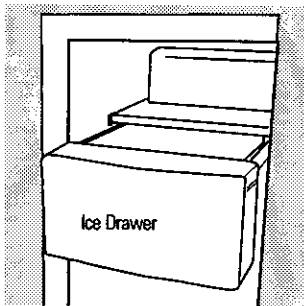



To Use the Dispenser

Select **CUBED ICE** , **CRUSHED ICE**  or **WATER** .

Press the glass gently against the top of the dispenser cradle.

The spill shelf is not self-draining. To reduce water spotting, the shelf and its grille should be cleaned regularly.

If no water is dispensed when the refrigerator is first installed, there may be air in the water line system. Press the dispenser arm for at least two minutes to remove trapped air from the water line and to fill the water system. To flush out impurities in the water line, throw away the first six glassfuls of water.

CAUTION: Never put fingers or any other objects into the ice crusher discharge opening.

Locking the Dispenser



Press the **LOCK CONTROL** pad for 3 seconds to lock the dispenser and control panel. To unlock, press and hold the pad again for 3 seconds.

Dispenser Light

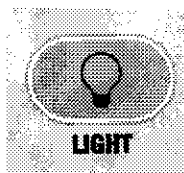

This pad turns the **night light** in the dispenser on and off. The light also comes on when the dispenser cradle is pressed. If this light burns out, it should be replaced with a 6 watt 12V maximum bulb.

Quick Ice

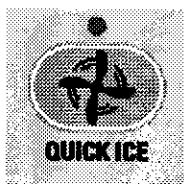

When you need ice in a hurry, press this pad to speed up ice production. This will increase ice production for the following 48 hours or until you press the pad again.

Door Alarm



To set the alarm, press this pad until the indicator light comes on. This alarm will sound if either door is open for more than 3 minutes. The light goes out and the beeping stops when you close the door.

Important Facts About Your Dispenser

- Do not add ice from trays or bags to the storage drawer. It may not crush or dispense well.
- Avoid overfilling glass with ice and use of narrow glasses. Backed-up ice can jam the chute or cause the door in the chute to freeze shut. If ice is blocking the chute, poke it through with a wooden spoon.
- Beverages and foods should not be quick-chilled in the ice storage drawer. Cans, bottles or food packages in the storage drawer may cause the icemaker or auger to jam.
- To keep dispensed ice from missing the glass, put the glass close to, but not touching, the dispenser opening.
- Some crushed ice may be dispensed even though you selected **CUBED ICE**. This happens occasionally when a few cubes accidentally get directed to the crusher.
- After crushed ice is dispensed, some water may drip from the chute.
- Sometimes a small mound of snow will form on the door in the ice chute. This condition is normal and usually occurs when you have dispensed crushed ice repeatedly. The snow will eventually evaporate.

About the ice and water dispenser.

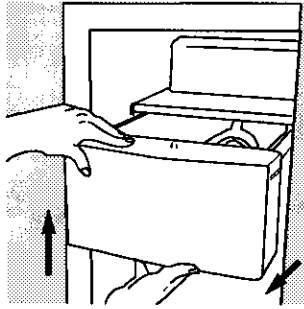

Ice Storage Drawer on Dispenser Models

To remove:

Set the icemaker power switch to the **0 (off)** position. Pull the drawer straight out and then lift past the **stop** position.

To replace:

When replacing the drawer, be sure to press it firmly into place. If it does not go all the way back, remove it and rotate the drive mechanism 1/4 turn. Then push the drawer back again.

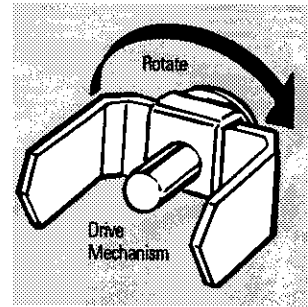

Care and cleaning of the refrigerator.



Dispenser drip area.

Cleaning the Outside

The dispenser drip area, beneath the grille, should be wiped dry. Water left in this area may leave deposits. Remove the deposits by adding undiluted vinegar to the well. Soak until the deposits disappear or become loose enough to rinse away.

The dispenser cradle. Before cleaning, lock the dispenser by pressing and holding the **LOCK CONTROL** pad for 3 seconds. Clean with warm water and baking soda solution—about a tablespoon (15 ml) of baking soda to a quart (1 liter) of water. Rinse thoroughly and wipe dry.

The door handles and trim. Clean with a cloth dampened with soapy water. Dry with a soft cloth.

The stainless steel panels and door handles (on some models) can be cleaned with a commercially available stainless steel cleaner such as *Stainless Steel Magic*.™

Stainless Steel Magic is available at Ace, True Value, Servistar, HWI and other leading stores. It is also available through GE Parts and Accessories, 800.626.2002. Order part number WX10X15.

Do not use appliance wax or polish on the stainless steel.

Keep the outside clean. Wipe with a clean cloth lightly dampened with kitchen appliance wax or mild liquid dish detergent. Dry and polish with a clean, soft cloth.

Do not wipe the refrigerator with a soiled dish cloth or wet towel. These may leave a residue that can erode the paint. Do not use scouring pads, powdered cleaners, bleach or cleaners containing bleach because these products can scratch and weaken the paint finish.

Cleaning the Inside

To help prevent odors, leave an open box of baking soda in the fresh food and freezer compartments.

Unplug the refrigerator before cleaning. If this is not practical, wring excess moisture out of sponge or cloth when cleaning around switches, lights or controls.

Use warm water and baking soda solution—about a tablespoon (15 ml) of baking soda to a quart (1 liter) of water. This both cleans and neutralizes odors. Rinse and wipe dry.

Use of any cleaning solution other than that which is recommended, especially those that contain petroleum distillates, can crack or damage the interior of the refrigerator.

Avoid cleaning cold glass shelves with hot water because the extreme temperature difference may cause them to break. Handle glass shelves carefully. Bumping tempered glass can cause it to shatter.

Do not wash any plastic refrigerator parts in the dishwasher.

Behind the Refrigerator

Be careful when moving the refrigerator away from the wall. All types of floor coverings can be damaged, particularly cushioned coverings and those with embossed surfaces.

Pull the refrigerator straight out and return it to position by pushing it straight in. Moving the refrigerator in a side direction may result in damage to the floor covering or refrigerator.

When pushing the refrigerator back, make sure you don't roll over the power cord or icemaker supply line.

Preparing for Vacation

For long vacations or absences, remove food and unplug the refrigerator. Clean the interior with a baking soda solution of one tablespoon (15 ml) of baking soda to one quart (1 liter) of water. Leave the doors open.

Set the icemaker power switch to the **O (off)** position and shut off the water supply to the refrigerator.

If the temperature can drop below freezing, have a qualified servicer drain the water supply system to prevent serious property damage due to flooding.

Preparing to Move

Secure all loose items such as shelves and drawers by taping them securely in place to prevent damage.

When using a hand truck to move the refrigerator, do not rest the front or back of the refrigerator against the hand truck. This could damage the refrigerator. Handle only from the sides of the refrigerator.

Be sure the refrigerator stays in an upright position during moving.

Replacing the light bulbs.

Setting the controls to **OFF** does not remove power to the light circuit.

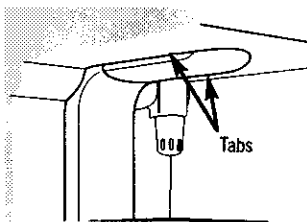

Refrigerator Compartment—Upper Light

- 1 Unplug the refrigerator.
- 2 The bulbs are located at the top of the compartment, inside the light shield. On some models, a screw at the front of the light shield will have to be removed.
- 3 To remove the light shield, press in on the tabs on the sides of the shield and slide forward and out.
- 4 After replacing the bulb with an appliance bulb of the same or lower wattage, replace the light shield and screws (on some models). When replacing the light shield, make sure that the tabs at the back of the shield fit into the slots at the back of the light shield housing.
- 5 Plug the refrigerator back in.

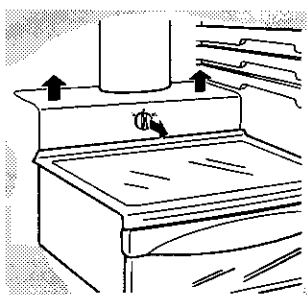

Refrigerator Compartment—Lower Light

This light is located above the top drawer.

- 1 Unplug the refrigerator.
- 2 Remove the convertible meat drawer control knob by pulling straight out.
- 3 Lift the light shield up and pull it out.
- 4 After replacing the bulb with an appliance bulb of the same or lower wattage, replace the shield and the knob.
- 5 Plug the refrigerator back in.

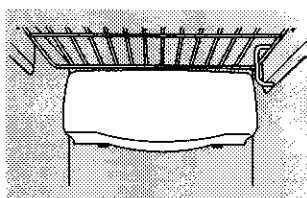

Freezer Compartment

- 1 Unplug the refrigerator.
- 2 Remove the shelf just above the light shield. (The shelf will be easier to remove if it is emptied first.) On some models, a screw at the top of the light shield will need to be removed.
- 3 To remove the light shield, press in on the sides, and lift up and out.
- 4 Replace the bulb with an appliance bulb of the same or lower wattage, and reinstall the light shield. When reinstalling the light shield, make sure the top tabs snap securely into place. Replace the screw (on some models).
- 5 Reinstall the shelf and plug the refrigerator back in.

Dispenser

- 1 Unplug the refrigerator.
- 2 The bulb is located on the dispenser under the control panel. Remove the light bulb by turning it counterclockwise.
- 3 Replace the bulb with a bulb of the same size and wattage.
- 4 Plug the refrigerator back in.

Trim kits and decorator panels.

For CustomStyle™ models

Read these instructions completely and carefully.



Before You Begin

Some models are equipped with trim kits that allow you to install door panels. You can order pre-cut black, white, bisque or stainless steel decorator panels from GE Parts and Accessories, 800.626.2002, or you can add wood panels to match your kitchen cabinets.

Panels less than 1/4" (6 mm) thick

When installing wood panels less than 1/4" (6 mm) thick, you need to create a filler panel, such as 1/8" cardboard, that will fit between the face of the door and the wood panel. If you are installing the pre-cut decorator panels, pre-cut filler panels are included in the kit. The combined thickness of the decorator or wood panel and the filler panel should be 1/4" (6 mm).

Panels 1/4" thick or less

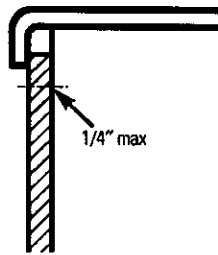

3/4" (19 mm) or Raised Panel

A raised panel design screwed or glued to a 1/4" (6 mm) thick backing, or a 3/4" (19 mm) routed board can be used. The raised portion of the panel must be fabricated to permit clearances of at least 2" (5.1 cm) from the handle side for fingertip clearance.

Panels thicker than 1/4" (6 mm), up to 3/4" (19 mm) max, will require that the outer 5/16" (8 mm) of panel perimeter be no thicker than 1/4" (6 mm).

Weight limitations for custom panels:

Fresh Food 38 lbs. (17 kg) max.

Freezer Door 28 lbs. (13 kg) max.

Panels thicker than 1/4" (6 mm)

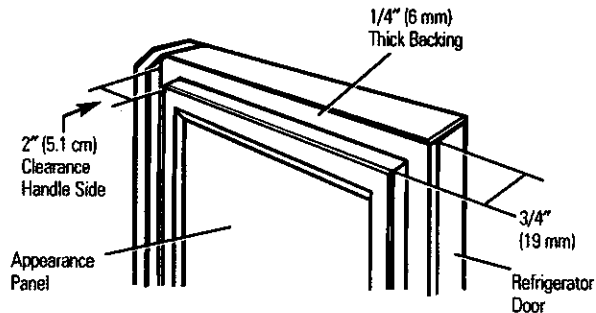
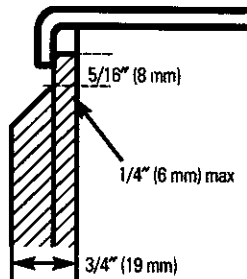

Trim kits and decorator panels.

Dimensions for Custom Wood Panels

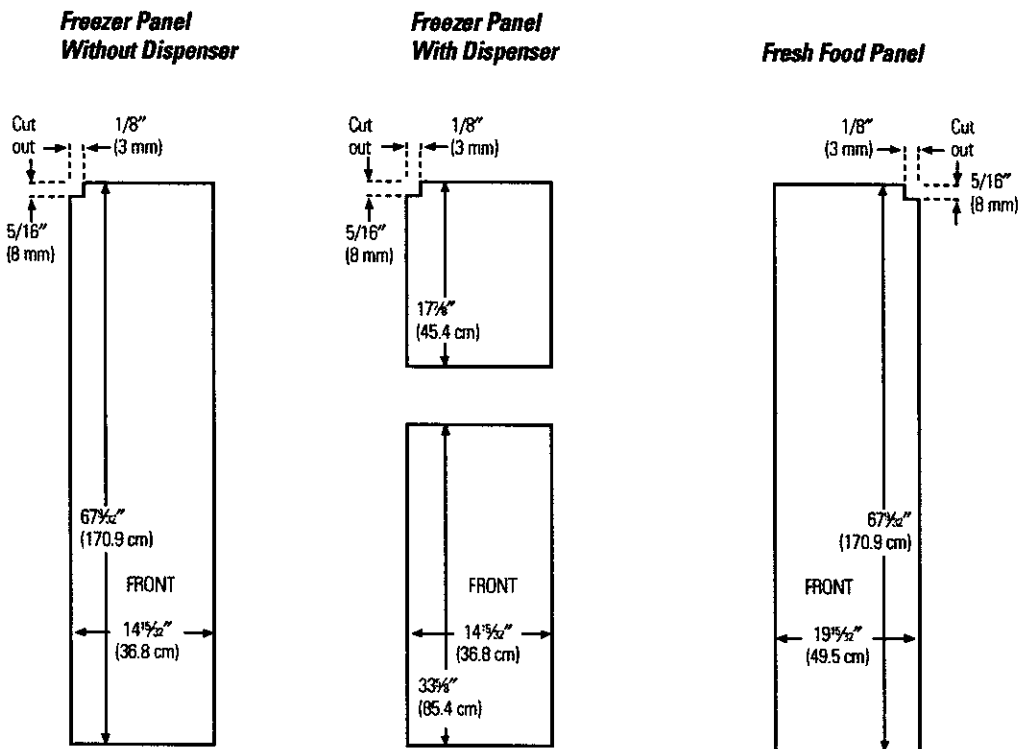

The areas at the top of the panels need to be cut out of the panels.

Inserting the door panels.

Read these instructions completely and carefully.

1 Insert the Freezer Panel and Fresh Food Panel.

Carefully push the freezer panel in until it slides into the slot behind the door handle. Push the filler panel (required with some door panels) in behind the decorator panel. Repeat for fresh food panel.

If your model has a dispenser, this step only applies to the fresh food panel and top freezer panel.

2 Insert the Bottom Freezer Panel (on dispenser models).

Carefully push the panel in until it slides into the slot behind the door handle. Push the filler panel

(required with some door panels) in behind the decorator panel.

3 Attach the Top Trim on the Freezer and Fresh Food Doors.

The Top Trim can be found inside the refrigerator compartment.

With a T-20 Torxdriver, attach the Top Trim, using two screws on each Top Trim piece, to the top of

each door. Hand tighten only. Make sure that the top of each panel fits snugly behind the lip of the Top Trim.

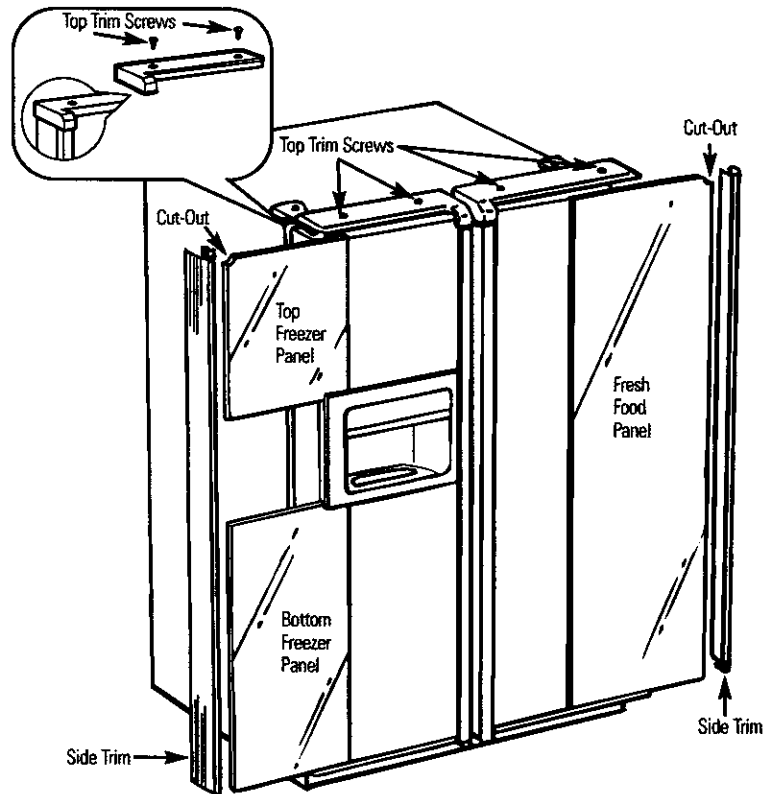

Inserting the door panels.

4 Install the Side Trim.

These pieces are tucked inside the refrigerator door handle.

Do not remove the protective film on the outside of the Side Trim until the Side Trim is installed.

Fit the bottom of the Side Trim under the Bottom Trim as illustrated.

Hold the Side Trim against the front face of the decorator panels and fit the Side Trim under the Top Trim. Make sure the magnetically attached Side Trim is fitted correctly and that you are satisfied with the appearance of all the parts.

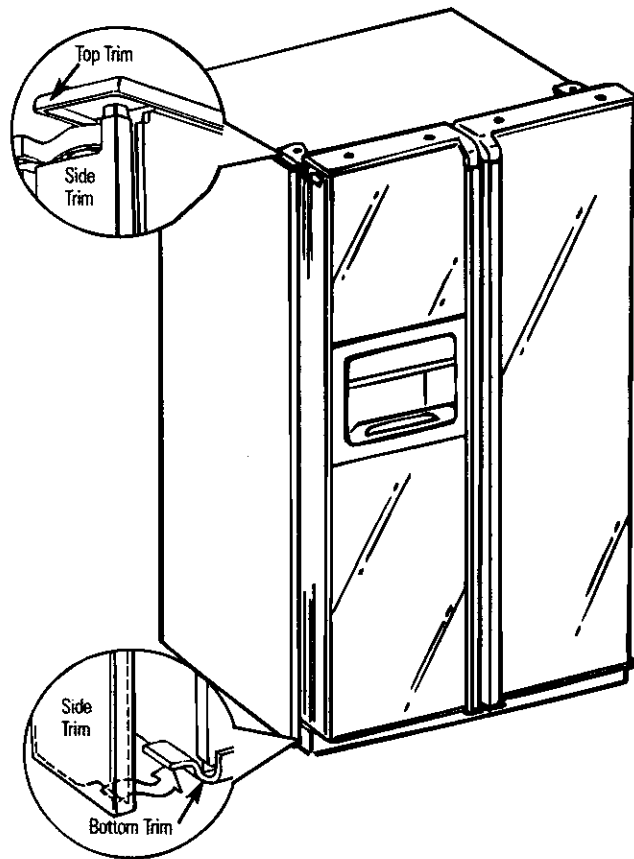

Removing and replacing the doors.

When installing or moving the refrigerator, the doors may need to be removed in order to fit the refrigerator through a doorway.

Removing the Doors

Make sure the doors are closed and the refrigerator is unplugged.

- 1 **Disconnect water line and wiring harness.**
Near the lower hinge on the freezer side, push in on the collars at each end of the coupling, and pull the water line tubing from the coupling. Also, disconnect wiring harness. Pull the water line and the harness through the lower rail.

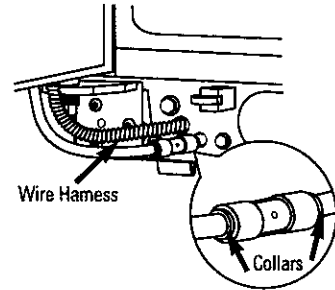

- 2 **Remove the hinge covers and the hinges.**
In order to access the hinges, the hinge covers need to be removed. Remove the cover by grasping it on the sides, near the back of the cover. Push back on the cover and lift up at the back, then the front.

NOTE: DO NOT use a screwdriver to remove the cover. BE CAREFUL not to break the rear retaining tab on the hinge cover. Remove the hinges using a Torx T-20.

- 3 **Remove the doors.**
Carefully rotate the door to 90°. Guiding the disconnected water line and wiring harness, lift the door straight up.

NOTE: Not lifting the door straight up may damage the bottom hinge. Place doors on a protected surface.

NOTE: Be careful not to pinch the water tubing and the wire harness at the bottom of the door.

NOTE: Do not allow the connector to contact the floor. Hard contact can damage the connector. See "Replacing the Doors."

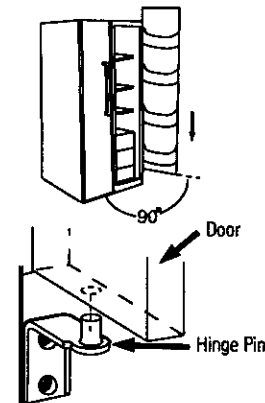
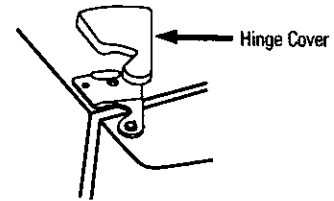

Replacing the Doors

- 1 **Place doors on bottom hinges.**
With the door at 90°, lower the door straight down onto the bottom hinge. Carefully close the door.

NOTE: Not lowering the door straight down onto the bottom hinge may damage the hinge.

NOTE: Do not allow the connector to contact the floor. Hard contact can damage the connector.

- 2 **Replace top hinges and hinge covers.**
Reinstall the top hinges using a Torx T-20. Replace the hinge covers. If the doors are not level, adjust the bottom right hinge with a 7/16" open ended wrench.

- 3 **Reconnect water line and wiring harness.**
Insert water tubing back into coupling, making sure the tubing is pushed far enough into the coupling so that you no longer see the mark on the tubing. Reconnect the wiring harness.

- 4 **Turn on the water supply and plug the refrigerator back in.**

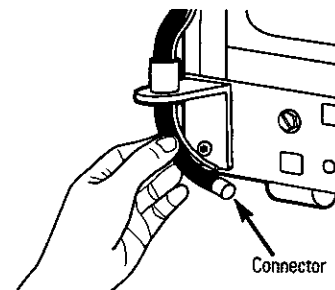

Installation Instructions

Refrigerator

Models 23, 25, 26, 27 & 29

Questions? Call 800.GE.CARES (800.432.2737) or Visit our Website at: GEAppliances.com
In Canada, call 1.800.361.3400 or Visit our Website at: geappliances.ca

BEFORE YOU BEGIN

Read these instructions completely and carefully.

- **IMPORTANT** — Save these instructions for local inspector's use.
- **IMPORTANT** — Observe all governing codes and ordinances.
- **Note to Installer** — Be sure to leave these instructions with the Consumer.
- **Note to Consumer** — Keep these instructions for future reference.
- **Skill level** — Installation of this appliance requires basic mechanical skills.
- **Completion time** — Refrigerator Installation
15 minutes
- Proper installation is the responsibility of the installer.
- Product failure due to improper installation is not covered under the Warranty.

WATER SUPPLY TO THE ICEMAKER (ON SOME MODELS)

If the refrigerator has an icemaker, it will have to be connected to a cold water line. A GE water supply kit (containing tubing, shutoff valve, fittings and instructions) is available at extra cost from your dealer, by visiting our Website at GEAppliances.com (in Canada at geappliances.ca) or from Parts and Accessories, 800.626.2002 (in Canada 1.888.261.3055).

REFRIGERATOR LOCATION

- Do not install the refrigerator where the temperature will go below 60°F (16°C) because it will not run often enough to maintain proper temperatures.
- Do not install the refrigerator where the temperature will go above 100°F (37°C) because it will not perform properly.
- Install it on a floor strong enough to support it fully loaded.

CLEARANCES

Allow the following clearances for ease of installation, proper air circulation and plumbing and electrical connections:

	23'	25', 26', 27' and 29'
• Sides	1/8" (4 mm)	1/8" (4 mm)
• Top	1" (25 mm)	1" (25 mm)
• Back	1/2" (13 mm)	1" (25 mm)

ROLLERS

The rollers have 3 purposes:

- Rollers adjust so the door closes easily when opened about halfway. [Raise the front about 5/8" (16 mm) from the floor.]
- Rollers adjust so the refrigerator is firmly positioned on the floor and does not wobble.
- Rollers allow you to move the refrigerator away from the wall for cleaning.

Final leveling adjustments should be made after the refrigerator has been installed.

To adjust the rollers on 25', 26', 27' and 29' models:

- Turn the roller adjusting screws **clockwise to raise** the refrigerator, **counterclockwise to lower** it. Use a 3/8" hex socket or wrench, or an adjustable wrench.

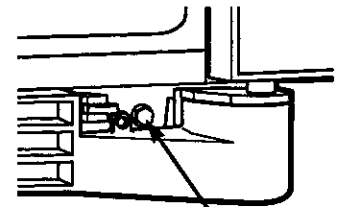

Roller adjusting screw

Installation Instructions

ROLLERS (CONT.)

To adjust the rollers on 23' models:

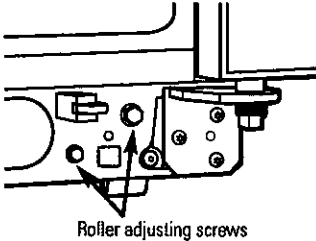
- 1 Remove the base grille by opening the doors, removing the screws at each end, and pulling it straight out.
- 2 Turn the front roller adjusting screws **clockwise to raise** the refrigerator, **counterclockwise to lower** it. Use a $3/8"$ hex socket or wrench, or an adjustable wrench.
 
- 3 These models also have rear adjustable rollers so you can align the refrigerator with your kitchen cabinets. Use a long-handled $5/16"$ socket wrench to turn the screws for the rear rollers—**clockwise to raise** the refrigerator, **counterclockwise to lower** it.
- 4 Replace the base grille.

DIMENSIONS AND SPECIFICATIONS (for CustomStyle™ models)

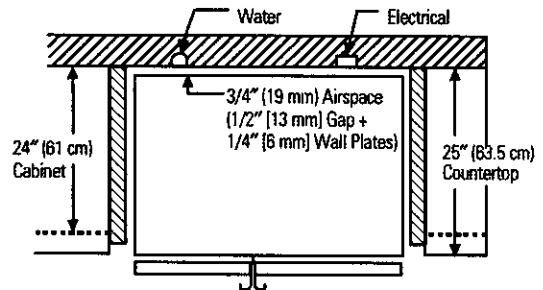
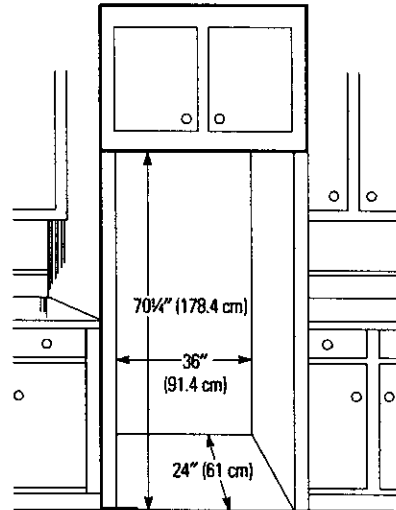

DOOR ALIGNMENT

After leveling, make sure that the refrigerator door is $1/16"$ higher than the freezer door.

To align the doors, adjust the refrigerator door.

- 1 Using a $7/16"$ socket wrench, turn the door adjusting screw to the right to raise the door, to the left to lower it. (A nylon plug, imbedded in the threads of the pin, prevents the pin from turning unless a wrench is used.)
- 2 After one or two turns of the wrench, open and close the refrigerator door and check the alignment at the top of the doors.

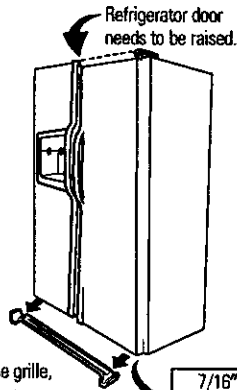

To remove the base grille, open the doors, remove the screw at each end of the base grille and then pull the grille straight out.

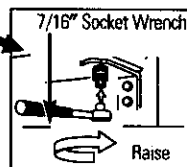

Installation Instructions

INSTALLING THE WATER LINE (ON SOME MODELS)

BEFORE YOU BEGIN

Recommended copper water supply kits are WX8X2, WX8X3 or WX8X4, depending on the amount of tubing you need. Approved plastic water supply lines are GE SmartConnect™ Refrigerator Tubing (WX08X10002, WX08X10006, WX08X10015 and WX08X10025).

When connecting your refrigerator to a GE Reverse Osmosis Water System, the only approved installation is with a GE RVKit. For other reverse osmosis water systems, follow the manufacturer's recommendations.

If the water supply to the refrigerator is from a Reverse Osmosis Water Filtration System AND the refrigerator also has a water filter, use the refrigerator's filter bypass plug. Using the refrigerator's water filtration cartridge in conjunction with the RO filter can result in hollow ice cubes and slower water flow from the water dispenser.

This water line installation is not warranted by the refrigerator or icemaker manufacturer. Follow these instructions carefully to minimize the risk of expensive water damage.

Water hammer (water banging in the pipes) in house plumbing can cause damage to refrigerator parts and lead to water leakage or flooding. Call a qualified plumber to correct water hammer before installing the water supply line to the refrigerator.

To prevent burns and product damage, do not hook up the water line to the hot water line.

If you use your refrigerator before connecting the water line, make sure the icemaker power switch is in the **O (off)** position.

Do not install the icemaker tubing in areas where temperatures fall below freezing.

When using any electrical device (such as a power drill) during installation, be sure the device is double insulated or grounded in a manner to prevent the hazard of electric shock, or is battery powered.

All installations must be in accordance with local plumbing code requirements.

WHAT YOU WILL NEED



- **Copper or GE SmartConnect™ Refrigerator Tubing kit**, 1/4" outer diameter to connect the refrigerator to the water supply. If using copper, be sure both ends of the tubing are cut square.

To determine how much tubing you need: measure the distance from the water valve on the back of the refrigerator to the water supply pipe. Then add 8' (2.4 m). Be sure there is sufficient extra tubing (about 8' [2.4 m] coiled into 3 turns of about 10" [25 cm] diameter) to allow the refrigerator to move out from the wall after installation.

GE SmartConnect™ Refrigerator Tubing Kits are available in the following lengths:

2' (.6 m)	– WX08X10002
6' (1.8 m)	– WX08X10006
15' (4.6 m)	– WX08X10015
25' (7.6 m)	– WX08X10025

Be sure that the kit you select allows at least 8' (2.4 m) as described above.

Installation Instructions

WHAT YOU WILL NEED (CONT.)

NOTE: The only GE approved plastic tubing is that supplied in GE SmartConnect™ Refrigerator Tubing kits. Do not use any other plastic water supply line because the line is under pressure at all times. Certain types of plastic will crack or rupture with age and cause water damage to your home.

- A GE water supply kit (containing tubing, shutoff valve and fittings listed below) is available at extra cost from your dealer or from Parts and Accessories, 800.626.2002 (in Canada 1.888.261.3055).
- A cold water supply. The water pressure must be between 20 and 120 p.s.i. (1.4–8.1 bar).

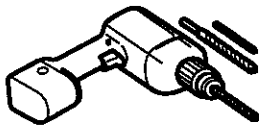

- Power drill.
- 1/2" or adjustable wrench.
- Straight and Phillips blade screwdriver.

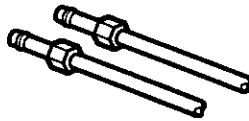

- Two 1/4" outer diameter compression nuts and 2 ferrules (sleeves)—to connect the copper tubing to the shutoff valve and the refrigerator water valve.
- OR
- If you are using a GE SmartConnect™ Refrigerator Tubing kit, the necessary fittings are preassembled to the tubing.

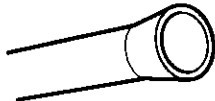

- If your existing copper water line has a flared fitting at the end, you will need an **adapter** (available at plumbing supply stores) to connect the water line to the refrigerator **OR** you can cut off the flared fitting with a **tube cutter** and then use a compression fitting. Do not cut formed end from GE SmartConnect™ Refrigerator tubing.

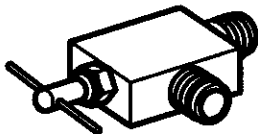

- **Shutoff valve** to connect to the cold water line. The shutoff valve should have a water inlet with a minimum inside diameter of 5/32" at the point of connection to the **COLD WATER LINE**. Saddle-type shutoff valves are included in many water supply kits. Before purchasing, make sure a saddle-type valve complies with your local plumbing codes.

Install the shutoff valve on the nearest frequently used drinking water line.

1 SHUT OFF THE MAIN WATER SUPPLY

Turn on the nearest faucet long enough to clear the line of water.

2 CHOOSE THE VALVE LOCATION

Choose a location for the valve that is easily accessible. It is best to connect into the side of a vertical water pipe. When it is necessary to connect into a horizontal water pipe, make the connection to the top or side, rather than at the bottom, to avoid drawing off any sediment from the water pipe.

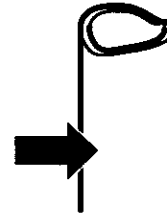

3 DRILL THE HOLE FOR THE VALVE

Drill a 1/4" hole in the water pipe (even if using a self-piercing valve), using a sharp bit. Remove any burrs resulting from drilling the hole in the pipe.

Take care not to allow water to drain into the drill.

Failure to drill a 1/4" hole may result in reduced ice production or smaller cubes.

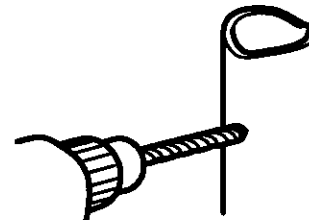

Installation Instructions

INSTALLING THE WATER LINE (CONT.)

4 FASTEN THE SHUTOFF VALVE

Fasten the shutoff valve to the cold water pipe with the pipe clamp.

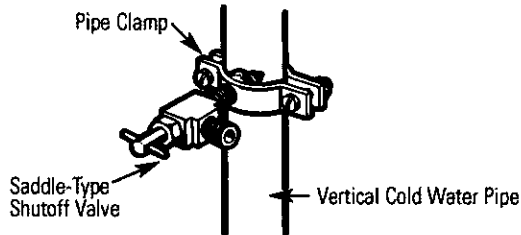

NOTE: Commonwealth of Massachusetts Plumbing Codes 248CMR shall be adhered to. Saddle valves are illegal and use is not permitted in Massachusetts. Consult with your licensed plumber.

5 TIGHTEN THE PIPE CLAMP

Tighten the clamp screws until the sealing washer begins to swell.

NOTE: Do not overtighten or you may crush the tubing.

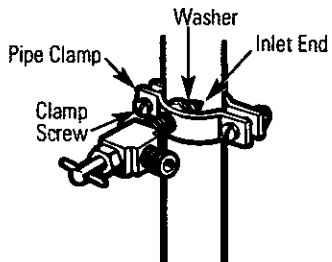

6 ROUTE THE TUBING

Route the tubing between the cold water line and the refrigerator.

Route the tubing through a hole drilled in the wall or floor (behind the refrigerator or adjacent base cabinet) as close to the wall as possible.

NOTE: Be sure there is sufficient extra tubing (about 8' [2.4 m] coiled into 3 turns of about 10" [25 cm] diameter) to allow the refrigerator to move out from the wall after installation.

7 CONNECT THE TUBING TO THE VALVE

Place the compression nut and ferrule (sleeve) for copper tubing onto the end of the tubing and connect it to the shutoff valve.

Make sure the tubing is fully inserted into the valve. Tighten the compression nut securely.

For plastic tubing from a GE SmartConnect™ Refrigerator Tubing kit, insert the molded end of the tubing into the shutoff valve and tighten compression nut until it is hand tight, then tighten one additional turn with a wrench. Overtightening may cause leaks.

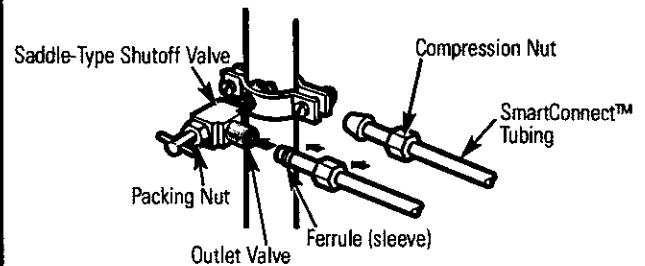

NOTE: Commonwealth of Massachusetts Plumbing Codes 248CMR shall be adhered to. Saddle valves are illegal and use is not permitted in Massachusetts. Consult with your licensed plumber.

8 FLUSH OUT THE TUBING

Turn the main water supply on and flush out the tubing until the water is clear.

Shut the water off at the water valve after about one quart (1 liter) of water has been flushed through the tubing.

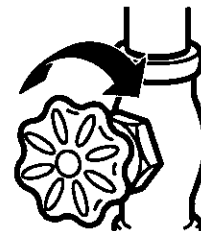

Installation Instructions

9 CONNECT THE TUBING TO THE REFRIGERATOR

NOTES:

- Before making the connection to the refrigerator, be sure the refrigerator power cord is not plugged into the wall outlet.
- If your refrigerator does not have a water filter, we recommend installing one if your water supply has sand or particles that could clog the screen of the refrigerator's water valve. Install it in the water line near the refrigerator. If using GE SmartConnect™ Refrigerator Tubing kit, you will need an additional tube (WX08X10002) to connect the filter. Do not cut plastic tube to install filter.

Some models have the refrigerator connection at the end of tubing located outside the compressor compartment access cover. On other models, the compressor compartment access cover must be removed in order to access the refrigerator connection at the water valve.

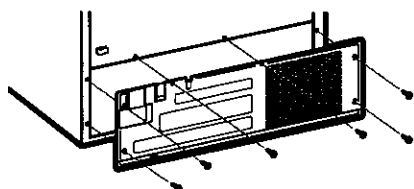

On models using the refrigeration connection at the water valve, remove the plastic flexible cap.

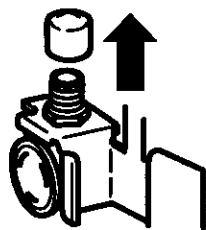

Place the compression nut and ferrule (sleeve) onto the end of the tubing as shown. On the GE SmartConnect™ Refrigerator Tubing kit, the nuts are already assembled to the tubing.

9 CONNECT THE TUBING TO THE REFRIGERATOR (CONT.)

Insert the end of the tubing into the water valve connection as far as possible. While holding the tubing, tighten the fitting.

For plastic tubing from a GE SmartConnect™ Refrigerator Tubing kit, insert the molded end of the tubing into the refrigerator connection and tighten the compression nut until it is hand tight, then tighten one additional turn with a wrench. Overtightening may cause leaks.

Fasten the tubing into the clamp provided to hold it in a vertical position. You may need to pry open the clamp.

One of the illustrations below will look like the connection on your refrigerator.

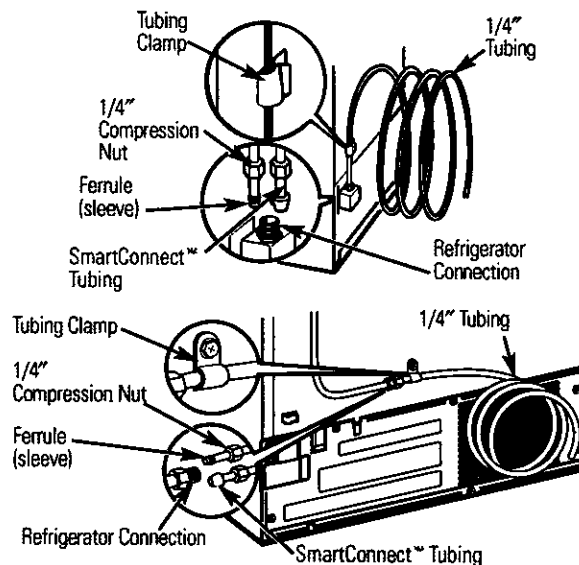

Installation Instructions

INSTALLING THE WATER LINE (CONT.)

10 TURN THE WATER ON AT THE SHUTOFF VALVE

Tighten any connections that leak.

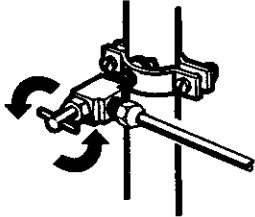

Replace access cover.

11 PLUG IN THE REFRIGERATOR

Arrange the coil of tubing so that it does not vibrate against the back of the refrigerator or against the wall. Push the refrigerator back to the wall.

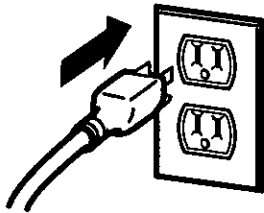

START THE ICEMAKER

Set the icemaker power switch to the *I (on)* position. The icemaker will not begin to operate until it reaches its operating temperature of 15°F (-9°C) or below. It will then begin operation automatically if the icemaker power switch is in the *I (on)* position.

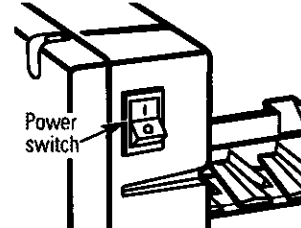

NOTE: In lower water pressure conditions, the water valve may turn on up to 3 times to deliver enough water to the icemaker.



Newer refrigerators sound different from older refrigerators. Modern refrigerators have more features and use newer technology.

Do you hear what I hear? These sounds are normal.

HUMMM... WHOOSH...

- The new high efficiency compressor may run faster and longer than your old refrigerator and you may hear a high-pitched hum or pulsating sound while it is operating.
- Sometimes the refrigerator runs for an extended period, especially when the doors are opened frequently. This means that the **Frost Guard™** feature is working to prevent freezer burn and improve food preservation.
- You may hear a whooshing sound when the doors close. This is due to pressure equalizing within the refrigerator.



- You may hear the fans spinning at high speeds. This happens when the refrigerator is first plugged in, when the doors are opened frequently or when a large amount of food is added to the refrigerator or freezer compartments. The fans are helping to maintain the correct temperatures.
- If either door is open for over 3 minutes, you may hear the fans come on in order to cool the light bulbs.
- The fans change speeds in order to provide optimal cooling and energy savings.
- You may hear the fans running after selecting one of the **CustomCool™** settings.

CLICKS, POPS, CRACKS and CHIRPS

- You may hear cracking or popping sounds when the refrigerator is first plugged in. This happens as the refrigerator cools to the correct temperature.
- Electronic dampers click open and closed to provide optimal cooling and energy savings.
- The compressor may cause a clicking or chirping sound when attempting to restart (this could take up to 5 minutes).
- The electronic control board may cause a clicking sound when relays activate to control refrigerator components.
- Expansion and contraction of cooling coils during and after defrost can cause a cracking or popping sound.
- On models with an icemaker, after an icemaking cycle, you may hear the ice cubes dropping into the ice bucket.

WATER SOUNDS



- The flow of refrigerant through the freezer cooling coils may make a gurgling noise like boiling water.
- Water dropping on the defrost heater can cause a sizzling, popping or buzzing sound during the defrost cycle.
- A water dripping noise may occur during the defrost cycle as ice melts from the evaporator and flows into the drain pan.
- Closing the door may cause a gurgling sound due to pressure equalization.



For additional information on normal icemaker and dispenser operating sounds, see the *About the automatic icemaker* and *About the ice and water dispenser* sections.

Before you call for service...



Troubleshooting Tips
Save time and money! Review the charts on the following pages first and you may not need to call for service.

Problem	Possible Causes	What To Do
Refrigerator does not operate	Refrigerator in defrost cycle.	• Wait about 30 minutes for defrost cycle to end.
	Either or both controls set to OFF .	• Set the controls to a temperature setting.
	Refrigerator is unplugged.	• Push the plug completely into the outlet.
	The fuse is blown/circuit breaker is tripped.	• Replace fuse or reset the breaker.
Vibration or rattling (slight vibration is normal)	The refrigerator is in showroom mode.	• Unplug the refrigerator and plug it back in.
	Rollers need adjusting.	• See <i>Rollers</i> .
Motor operates for long periods or cycles on and off frequently. (Modern refrigerators with more storage space and a larger freezer require more operating time. They start and stop often to maintain even temperatures.)	Normal when refrigerator is first plugged in.	• Wait 24 hours for the refrigerator to completely cool down.
	Often occurs when large amounts of food are placed in refrigerator.	• This is normal.
	Door left open.	• Check to see if package is holding door open.
	Hot weather or frequent door openings.	• This is normal.
	Temperature controls set at the coldest setting.	• See <i>About the controls</i> .
Refrigerator or freezer compartment too warm	Temperature control not set cold enough.	• See <i>About the controls</i> .
	Warm weather or frequent door openings.	• Set the temperature control one step colder See <i>About the controls</i> .
	Door left open.	• Check to see if package is holding door open
Frost or ice crystals on frozen food (frost within package is normal)	Door left open.	• Check to see if package is holding door open.
	Too frequent or too long door openings.	
Divider between refrigerator and freezer compartments feels warm	Automatic energy saver system circulates warm liquid around front edge of freezer compartment.	• This helps prevent condensation on the outside.
Automatic icemaker does not work	Icemaker power switch is in the off position.	• Set the power switch to the on position.
	Water supply turned off or not connected.	• See <i>Installing the water line</i> .
	Freezer compartment too warm.	• Wait 24 hours for the refrigerator to completely cool down
	Piled up cubes in the storage bin cause the icemaker to shut off.	• Level cubes by hand.
	Ice cubes stuck in icemaker. (Green power light on icemaker blinking).	• Turn off the icemaker, remove cubes and turn the icemaker back on.

Problem	Possible Causes	What To Do
Frequent "buzzing" sound	Icemaker power switch is in the <i>I (on)</i> position, but the water supply to the refrigerator has not been connected.	<ul style="list-style-type: none"> Set the power switch to the <i>O (off)</i> position. Keeping it in the <i>I (on)</i> position will damage the water valve.
Ice cubes have odor/taste	Ice storage bin needs cleaning.	<ul style="list-style-type: none"> Empty and wash bin. Discard old cubes.
	Food transmitting odor/taste to ice cubes.	<ul style="list-style-type: none"> Wrap foods well
	Interior of refrigerator needs cleaning.	<ul style="list-style-type: none"> See <i>Care and cleaning</i>.
Small or hollow cubes	Water filter clogged.	<ul style="list-style-type: none"> Replace filter cartridge with new cartridge or with plug
Slow ice cube freezing	Door left open.	<ul style="list-style-type: none"> Check to see if package is holding door open.
	Temperature control not set cold enough.	<ul style="list-style-type: none"> See <i>About the controls</i>.
Cube dispenser does not work	Icemaker turned off or water supply turned off.	<ul style="list-style-type: none"> Turn on icemaker or water supply
	Ice cubes are frozen to icemaker feeler arm.	<ul style="list-style-type: none"> Remove cubes.
	Irregular ice clumps in storage container.	<ul style="list-style-type: none"> Break up with fingertip pressure and discard remaining clumps. Freezer may be too warm. Adjust the freezer control to a colder setting, one position at a time, until clumps do not form.
	Dispenser is LOCKED .	<ul style="list-style-type: none"> Press and hold the LOCK CONTROL pad for 3 seconds.
Water has poor taste/odor	Water dispenser has not been used for a long time.	<ul style="list-style-type: none"> Dispense water until all water in system is replenished.
Water in first glass is warm	Normal when refrigerator is first installed.	<ul style="list-style-type: none"> Wait 24 hours for the refrigerator to completely cool down.
	Water dispenser has not been used for a long time.	<ul style="list-style-type: none"> Dispense water until all water in system is replenished
	Water system has been drained.	<ul style="list-style-type: none"> Allow several hours for replenished supply to chill.
Water dispenser does not work	Water supply line turned off or not connected.	<ul style="list-style-type: none"> See <i>Installing the water line</i>.
	Water filter clogged.	<ul style="list-style-type: none"> Replace filter cartridge or remove filter and install plug.
	Air may be trapped in the water system.	<ul style="list-style-type: none"> Press the dispenser arm for at least two minutes.
	Dispenser is LOCKED .	<ul style="list-style-type: none"> Press and hold the LOCK CONTROL pad for 3 seconds.
Water spurting from dispenser	Newly-installed filter cartridge.	<ul style="list-style-type: none"> Run water from the dispenser for 3 minutes (about one and a half gallons).
Water is not dispensed but icemaker is working	Water in reservoir is frozen.	<ul style="list-style-type: none"> Call for service
	Refrigerator control setting is too cold.	<ul style="list-style-type: none"> Set to a warmer setting.
No water or ice cube production	Supply line or shutoff valve is clogged.	<ul style="list-style-type: none"> Call a plumber
	Water filter clogged.	<ul style="list-style-type: none"> Replace filter cartridge or remove filter and install plug.
	Dispenser is LOCKED .	<ul style="list-style-type: none"> Press and hold the LOCK CONTROL pad for 3 seconds.
CUBED ICE was selected but CRUSHED ICE was dispensed	Last setting was CRUSHED ICE .	<ul style="list-style-type: none"> A few cubes were left in the crusher from the previous setting. This is normal

Before you call for service...

Problem	Possible Causes	What To Do
Orange glow in the freezer	Defrost heater is on.	<ul style="list-style-type: none"> This is normal.
Refrigerator has odor	Foods transmitting odor to refrigerator.	<ul style="list-style-type: none"> Foods with strong odors should be tightly wrapped. Keep an open box of baking soda in the refrigerator; replace every three months
	Interior needs cleaning.	<ul style="list-style-type: none"> See <i>Care and cleaning</i>.
Door not closing properly	Door gasket on hinge side sticking or folding over.	<ul style="list-style-type: none"> Apply paraffin wax to the face of the gasket.
	A door bin is hitting a shelf inside the refrigerator.	<ul style="list-style-type: none"> Move the door bin up one position.
Moisture forms on outside of refrigerator	Not unusual during periods of high humidity.	<ul style="list-style-type: none"> Wipe surface dry.
Moisture collects inside (in humid weather, air carries moisture into refrigerator when doors are opened)	Too frequent or too long door openings.	
Interior light does not work	No power at outlet.	<ul style="list-style-type: none"> Replace fuse or reset the breaker.
	Light bulb burned out.	<ul style="list-style-type: none"> See <i>Replacing the light bulbs</i>.
Water on kitchen floor or on bottom of freezer	Cubes jammed in chute.	<ul style="list-style-type: none"> Poke ice through with a wooden spoon.
Hot air from bottom of refrigerator	Normal air flow cooling motor. In the refrigeration process, it is normal that heat be expelled in the area under the refrigerator. Some floor coverings are sensitive and will discolor at these normal and safe temperatures.	
Refrigerator never shuts off but the temperatures are OK	Adaptive defrost keeps compressor running during door openings.	<ul style="list-style-type: none"> This is normal. The refrigerator will cycle off after the door remains closed for 2 hours
Refrigerator beeping	Door open.	<ul style="list-style-type: none"> Close door.
Food isn't thawing/chilling	Packaging.	<ul style="list-style-type: none"> Increase time or re-package in plastic
	Wrong weight selected.	<ul style="list-style-type: none"> Select a larger weight.
	Item with high fat content.	<ul style="list-style-type: none"> Select a larger weight.
	Not using Chill/Thaw tray.	<ul style="list-style-type: none"> Place items on tray and allow space in between items for better airflow.
Actual temperature not equal to Set temperature	Unit just plugged in.	<ul style="list-style-type: none"> Allow 24 hours for system to stabilize.
	Door open for too long.	<ul style="list-style-type: none"> Allow 24 hours for system to stabilize
	Warm food added to refrigerator.	<ul style="list-style-type: none"> Allow 24 hours for system to stabilize
	Defrost cycle is in process.	<ul style="list-style-type: none"> Allow 24 hours for system to stabilize.
Select Temp feature is not working	Refrigerator compartment temperature control is set at warmest setting.	<ul style="list-style-type: none"> This is normal. In order to minimize energy usage, the Select Temp feature is disabled when the refrigerator temperature control is set at the warmest setting.

CONSUMER WARRANTY

(for customers in Canada)

Your refrigerator is warranted to be free of defects in material and workmanship.

What is covered	How Long Warranted (From Date of Sale)	Parts Repair or Replace at Camco's Option	Labour
Compressor	Ten (10) Years	Ten (10) Years	Five (5) Years
Sealed System (including evaporator, condenser tubing and refrigerant)	Five (5) Years	Five (5) Years	Five (5) Years
All Other Parts	One (1) Year	One (1) Year	One (1) Year

TERMS AND CONDITIONS:

This warranty applies only for single family domestic use in Canada when the Refrigerator has been properly installed according to the instructions supplied by Camco and is connected to an adequate and proper utility service.

Damage due to abuse, accident, commercial use, and alteration or defacing of the serial plate cancels all obligations of this warranty.

Service during this warranty must be performed by an Authorized Camco Service Agent.

Neither Camco nor the Dealer is liable for any claims or damages resulting from any failure of the Refrigerator or from service delays beyond their reasonable control.

To obtain warranty service, purchaser must present the original bill of sale. Components repaired or replaced are warranted through the remainder of the original warranty period only.

This warranty is in addition to any statutory warranty.

IMPORTANT

Keep this warranty and your bill of sale as proof of original purchase and purchase date.

Camco Service is available coast to coast.
If further help is needed concerning this warranty, contact:
Manager, Consumer Relations, Camco Inc.,
Suite 310, 1 Factory Lane, Moncton, N.B. E1C 9M3

*Staple your receipt here.
Proof of the original purchase
date is needed to obtain service
under the warranty.*

Refrigerator Warranty. (For customers in the United States)



All warranty service provided by our Factory Service Centers, or an authorized Customer Care® technician. To schedule service, on-line, 24 hours a day, visit us at GEAppliances.com, or call 800.GE.CARES (800 432.2737).

Staple your receipt here
Proof of the original purchase date is needed to obtain service under the warranty.

For The Period Of: GE Will Replace:

One Year
From the date of the original purchase

Any part of the refrigerator which fails due to a defect in materials or workmanship. During this **full one-year warranty**, GE will also provide, **free of charge**, all labor and in-home service to replace the defective part.

Five Years
From the date of the original purchase

Any part of the sealed refrigerating system (the compressor, condenser, evaporator and all connecting tubing) which fails due to a defect in materials or workmanship. During this **full five-year sealed refrigerating system warranty**, GE will also provide, **free of charge**, all labor and in-home service to replace the defective part in the sealed refrigerating system.

What GE Will Not Cover:

- Service trips to your home to teach you how to use the product.
- Improper installation.
- Failure of the product if it is abused, misused, or used for other than the intended purpose or used commercially.
- Loss of food due to spoilage.
- Replacement of house fuses or resetting of circuit breakers.
- Replacement of the water filter cartridge due to water pressure that is outside the specified operating range or due to excessive sediment in the water supply.
- Replacement of the water filter cartridge after its expected useful life.
- Damage to the product caused by accident, fire, floods or acts of God.
- Incidental or consequential damage caused by possible defects with this appliance.

This warranty is extended to the original purchaser and any succeeding owner for products purchased for home use within the USA. In Alaska, the warranty excludes the cost of shipping or service calls to your home.

Some states do not allow the exclusion or limitation of incidental or consequential damages. This warranty gives you specific legal rights, and you may also have other rights which vary from state to state. To know what your legal rights are, consult your local or state consumer affairs office or your state's Attorney General.

Warrantor: General Electric Company, Louisville, KY 40225

Performance Data Sheet

GE SmartWater Filtration System

GWF Cartridge

Health Claim Performance Certified by NSF/ANSI*
 (100% safety factors built in for unmetered usage)

Standard No. 42: Aesthetic Effects						
Parameter	USEPA MCL	Influent Challenge	Effluent		% Reduction	
			Average	Maximum	Average	Minimum
Chlorine	-	1.9 ppm	0.02 ppm	0.05 ppm	98.90%	97.37%
T & O	-	-	-	-	-	-
Particulate**	-	200,000	3,978	7,800	98.00%	96.10%

Standard No. 53: Health Effects						
Parameter	USEPA MCL	Influent Challenge	Effluent		% Reduction	
			Average	Maximum	Average	Minimum
Turbidity	1 NTU***	24.3 NTU	0.07 NTU	0.1 NTU	99.71%	99.59%
Cysts	99.95% Reduction	105,750	26	55	99.97%	99.95%
Lead at pH 6.5	15 ppb	160 ppb	1 ppb	1 ppb	99.37%	99.37%
Lead at pH 8.5	15 ppb	150 ppb	1.8 ppb	4.3 ppb	98.80%	97.13%
Lindane	0.0002 ppm	0.00062 ppm	0.00005 ppm	0.00005 ppm	91.93%	91.93%
Atrazine	0.003 ppm	0.0084 ppm	0.002 ppm	0.003 ppm	76.19%	64.28%
2,4-D	0.100 ppm	0.272 ppm	0.042 ppm	0.090 ppm	84.89%	67.63%
Asbestos	99%	690 MFL./ml	0.32 MFL./ml	1.2 MFL./ml	99.95%	99.82%

* Tested using a flow rate of 0.5 gpm (1.8927 l/m); pressure of 120 psig (8.437 kg/cm²); pH of 7.5±0.5; temp. of 68°±4.5°F (20°±2.5°C)

** Measurement in particles/ml

*** NTU = Nephelometric Units

Operating Specifications

- Capacity: certified for up to 500 gallons (1893 l); up to one year
- Pressure requirement: 40-120 psi (2.8-8.2 bar), non-shock
- Temperature: 33°-100°F (0.6°-38°C)
- Flow rate: 0.5 gpm (1.9 lpm)

General Installation/Operation/Maintenance Requirements

- Flush new cartridge at full flow for 3 minutes to purge out trapped air.
- Replace cartridge when flow becomes too slow.

Special Notices

- Installation instructions; parts and service availability; and standard warranty are included with the product when shipped.
- This drinking water system must be maintained according to manufacturer's instructions, including replacement of filter cartridges.
- Do not use with water that is microbiologically unsafe or of unknown quality without adequate disinfection before or after the system. Systems certified for cyst reduction may be used on disinfected water that may contain filterable cysts.
- The contaminants or other substances removed or reduced by this water treatment system are not necessarily in your water.
- Check for compliance with the state and local laws and regulations.

System Tested and Certified by NSF International against ANSI/NSF Standard 42 & 53 for the reduction of:	
Standard No. 42: Aesthetic Effects Chemical Unit Taste and Odor Reduction Chlorine Reduction, Class I Mechanical Filtration Unit Particulate Reduction, Class I	Standard No. 53: Health Effects Chemical Reduction Unit Lead and Atrazine Reduction Lindane and 2,4-D Reduction Mechanical Filtration Unit Turbidity Reduction Cyst and Asbestos Reduction



Manufactured for: General Electric Company, Louisville, KY 40225

State of California
 Department of Health Services
 Water Treatment Device
 Certificate Number

00 - 1434

Date Issued: May 30, 2000

Date Revised: February 9, 2001

Trademark/Model Designation

Replacement Elements

GE Smart Water Filtration Systems - GWF06

GWF06

GE Smart Water Filtration Systems - GWF

GWF

Hotpoint Refrigerator Systems - HWF

HWF

Manufacturer: General Electric Appliances

The water treatment device(s) listed on this certificate have met the testing requirements pursuant to Section 116830 of the Health and Safety Code for the following health related contaminants:

Microbiological Contaminants and Turbidity

Cysts (protozoan)
 Turbidity

Inorganic/Radiological Contaminants

Asbestos
 Lead

Organic Contaminants

Atrazine
 Lindane
 2,4-D

Rated Service Capacity: 300 gallons*

Rated Service Flow: 0.5 gpm

Do not use where water is microbiologically unsafe or with water of unknown quality, except that systems claiming cyst reduction may be used on water containing cysts.

*** 500 gallons for models that include a replacement filter indicator light.**

For Purchases Made In Iowa: This form must be signed and dated by the buyer and seller prior to the consummation of this sale. This form should be retained on file by the seller for a minimum of two years.

BUYER:

 Name

 Address

 City State Zip

 Signature Date

SELLER:

 Name

 Address

 City State Zip

 Signature Date

GE Service Protection Plus™

GE, a name recognized worldwide for quality and dependability, offers you Service Protection Plus™—comprehensive protection on all your appliances—**No Matter What Brand!**

Benefits Include:

- Backed by GE
- All brands covered
- Unlimited service calls
- All parts and labor costs included
- No out-of-pocket expenses
- No hidden deductibles
- One 800 number to call

***We'll Cover Any Appliance.
Anywhere. Anytime.****

You will be completely satisfied with our service protection or you may request your money back on the remaining value of your contract. No questions asked. It's that simple.

Protect your refrigerator, dishwasher, washer and dryer, range, TV, VCR and much more—**any brand!** Plus there's no extra charge for emergency service and low monthly financing is available. Even icemaker coverage and food spoilage protection is offered. You can rest easy, knowing that all your valuable household products are protected against expensive repairs.

Place your confidence in GE and call us in the U.S. toll-free at **800.626.2224** for more information.

*All brands covered, up to 20 years old, in the continental U.S.

 Cut here

Please place in envelope and mail to:

General Electric Company
Warranty Registration Department
P.O. Box 32150
Louisville, KY 40232-2150

Consumer Product Ownership Registration

Dear Customer:

Thank you for purchasing our product and thank you for placing your confidence in us. We are proud to have you as a customer!

Follow these three steps to protect your new appliance investment:

1 Complete and mail your Consumer Product Ownership Registration today. Have the peace of mind of knowing we can contact you in the unlikely event of a safety modification.

2 After mailing the registration below, store this document in a safe place. It contains information you will need should you require service. Our service number is 800.GE.CARES (800.432.2737).

3 Read your Owner's Manual carefully. It will help you operate your new appliance properly.

Model Number

Serial Number

Important: If you did not get a registration card with your product, detach and return the form below to ensure that your product is registered, or register online at GEAppliances.com.

 Cut here

Consumer Product Ownership Registration



Model Number

Serial Number

Mr. Ms. Mrs. Miss

First Name _____

Last Name _____

Street Address _____

Apt. # _____

E-mail Address* _____

City _____

State _____

Zip Code _____

Date Placed In Use
Month _____

Day _____

Year _____

Phone Number _____

* Please provide your e-mail address to receive, via e-mail, discounts, special offers and other important communications from GE Appliances (GEA).

Check here if you do not want to receive communications from GEA's carefully selected partners.



GE Appliances

General Electric Company
Louisville, Kentucky
GEAppliances.com