

GT SERIES COLOR TELEVISIONS

INSTRUCTION MANUAL

Standard - GT2015, GT2415, GT2715, GT3215

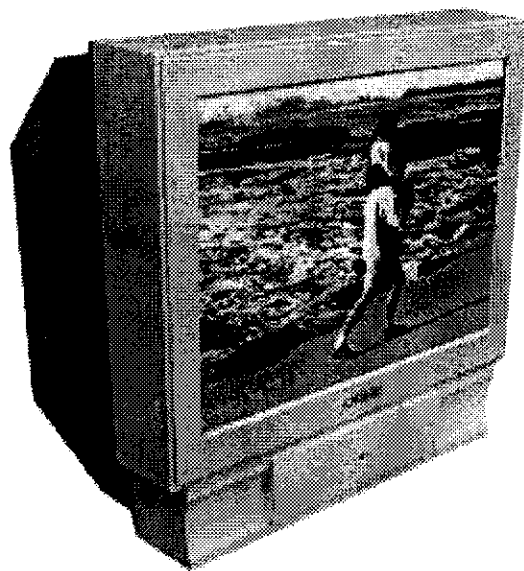

Please read this manual carefully before operation.

BEFORE OPERATION

Dear Customer:

Congratulations! You have purchased one of the finest Color TVs on the market!

This manual will help you use the many exciting and useful features to make your TV viewing more enjoyable than ever before.

Before operating your TV set, please read all these safety and operating instructions completely and then retain for future reference.

Customer's Record

You will find the model number and chassis number on the back of your TV set.

Record these numbers in the spaces provided below.

Refer to them whenever you call upon your Apex dealer regarding this product.

Model Numbers: GT2015, GT2415, GT2715, GT3215

Chassis Number: CH-12C2

Safety Precautions

WARNING:

TO REDUCE THE RISK OF FIRE OR ELECTRIC SHOCK, DO NOT EXPOSE THIS APPLIANCE TO RAIN OR MOISTURE.

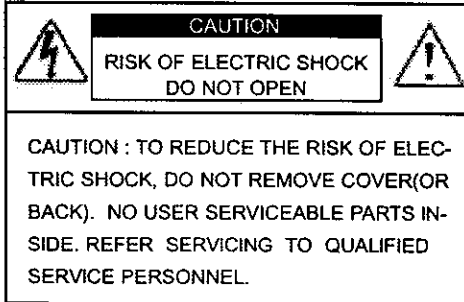

The lightning symbol in the triangle tells you that the voltage inside this product may be strong enough to cause an electric shock.

NOT TRY TO SERVICE THIS PRODUCT YOURSELF.



The exclamation point in the triangle tells you that important operating and maintenance instructions follow this symbol.

CAUTIONS:

TO PREVENT ELECTRIC SHOCK, DO NOT USE THIS POLARIZED PLUG WITH AN EXTENSION CORD RECEPTACLE OR OTHER OUTLET UNLESS THE PRONGS CAN BE FULLY INSERTED INTO THE OUTLET TO PREVENT ANY EXPOSURE OF THE PRONGS ON THE POLARIZED PLUG.

Avoid displaying stationary images on your TV screen for extended periods of time. Stationary patterns generated by computer displays, video games, stock market reports, etc. can become permanently engrained on the picture tube. This damage is not protected by your warranty as it is the result of misuse. Should you wish to use your Apex Television to display still images, it is always advisable to reduce brightness and contrast settings. Never leave a video game or computer display unattended.

NOTE TO CABLE INSTALLER IN THE USA:

This reminder is provided to call your attention to Article 820 - 40 of the NEC that provides guidelines for proper grounding and, in particular, specifies that the cable ground shall be connected to the grounding system of the building, as close to the point of cable entry as practical.

BEFORE OPERATION (continued)

Important Safety Instructions

CAUTION

PLEASE READ THESE INSTRUCTIONS, KEEP THESE INSTRUCTIONS AND HEED ALL WARNINGS. FOLLOW ALL INSTRUCTIONS.

Electrical energy can perform many useful functions. This TV set has been engineered and manufactured to assure your personal safety. However improper use can result in potential electrical shock or fire hazards. In order not to defeat the safe guards incorporated in this TV set, observe the following basic rules for antenna/ TV installation, use and servicing. All operating and use instructions should be followed. Do not remove the cabinet cover. This may expose you to dangerous voltages. Refer all servicing to qualified service personnel.

Precautions

Power Sources - The TV set should be operated only from the type of power source indicated on the TV set or as indicated in the Operation Manual. If you are not sure of the type of power supply in your home, consult your local power company. For TV sets designed to operate from battery power, or other sources, refer to the operating instructions.

Grounding or Polarization - Do not defeat the safety purpose of the polarized or grounding-type plug. A polarized plug has two blades with one wider than the other. A grounding - type plug has two blades and a third grounding prong. The wide blade or the third prong is provided for your safety. If the provided plug does not fit into your outlet, consult an electrician for replacement of the obsolete outlet.

Alternate Warnings - This plug will only fit into a grounding-type power outlet. This is a safety feature. If you are unable to insert the plug into the outlet, contact your electrician to have a suitable outlet installed. Do not defeat the safety purpose of the grounding plug.

Power-Cord Protection - Protect the power cord from being walked on or pinched, particularly at plugs, convenience receptacles, and the point where they exit from the TV.

Overloading - Do not overload wall outlets, extension cords or integral convenience receptacles as this can result in fire or electric shock.

Lightning - For added protection for this TV set during a lightning storm, or when it is left unattended and unused for long periods of time, unplug it from the wall outlet and disconnect the antenna or cable system. This will prevent damage to the product due to lightning and power-line surges.

If a snapping or popping sound from a TV set is heard continuously or frequently while the TV set is operated, unplug the TV set and consult your dealer or service technician. It is normal for some TV sets to make occasional snapping or popping sounds, particularly when being turned on or off.

Heat - Do not install near any heat sources such as radiators, heat registers, stoves, or other apparatus (including amplifiers) that produce heat.

Accessories - Do not place the TV set on an unstable cart, stand, tripod, bracket, or table. The TV set may fall, causing serious injury to a child or adult, and serious damage to the TV set. Use only with a cart, stand, tripod, bracket, or table recommended by the manufacturer, or accessory recommended by the manufacturer, or sold with the TV set, and should use a mounting accessory recommended by the manufacturer.

A product and cart combination should be moved with care. Quick stops, excessive force, and uneven surfaces may cause the TV set and cart combination to overturn.

Water and Moisture Warnings - Do not use the TV set near water-for example, near a bath tub, wash bowl, kitchen sink, or laundry tub; in a wet basement; or near a swimming pool; and the like. The TV set should not be exposed to dripping or splashing and no objects filled with liquids, such as vases, should be placed on the TV set.

Object and Liquid Entry - Never push objects of any kind into the TV set through openings as they may touch dangerous voltage points or short-out parts that could result in a fire or electric shock. Never spill liquid of any kind on the TV set.

Cleaning - Unplug the TV set from the wall outlet before cleaning or polishing it. Do not use liquid cleaners or aerosol cleaners. Use a dry cloth for cleaning the exterior of the TV set.

Attachments - Do not use attachments not recommended by the product manufacturer as they may cause hazards or electric shock.

Ventilation - Slots and openings in the cabinet are provided for ventilation and to ensure reliable operation of the TV set and to protect it from overheating, and these openings must not be blocked or covered. The openings should never be blocked by placing the TV set on a bed, sofa, rug, or other similar surface. This TV set should not be placed in a built-in installation such as a bookcase or rack unless proper ventilation is provided or the manufacturer's instructions have been adhered to.

BEFORE OPERATION (continued)

Precautions (continued)

Damage Requiring Service - Unplug the TV set from the wall outlet and refer servicing to qualified service personnel under the following conditions:

- a. If the power cord or plug is damaged or frayed.
- b. If liquid has been spilled or objects have fallen into the TV set.
- c. If the TV set has been exposed to rain or water.
- d. If the TV set has been subject to excessive shock by being dropped, or the cabinet has been damaged.
- e. If the TV set does not operate normally by following the operating instructions. Adjust only those controls that are covered by the operating instructions as an improper adjustment of other controls may result in damage and will often require extensive work by a qualified technician to restore the TV set to its normal operation.
- f. When the TV set exhibits a distinct change in performance-this indicates a need for service.

Servicing - Do not attempt to service the TV set yourself as opening or removing covers may expose you to dangerous voltage or other hazards. Refer all servicing to qualified service personnel.

Replacement Parts - When replacement parts are required, be sure the service technician has used replacement parts specified by the manufacturer or have the same characteristics as the original parts. Unauthorized substitutions may result in fire, electric shock, or other hazards.

Safety Check - Upon completion of any service or repairs to the TV set, ask the service technician to perform routine safety checks to determine that the TV set is in proper operating condition.

Disposal - When the TV set reaches the end of its useful life, improper disposal could result in a picture tube implosion. Ask a qualified service technician to dispose of the TV set.

ANTENNA

Outdoor Antenna Grounding- If an outdoor antenna is installed, follow the precautions below.

An outdoor antenna system should not be located in the vicinity of overhead power lines or other electric light or power circuits, or where it can come in contact with such power lines or circuits.

WHEN INSTALLING AN OUTDOOR ANTENNA SYSTEM, EXTREME CARE SHOULD BE TAKEN TO KEEP FROM CONTACTING SUCH POWER LINES OR CIRCUITS AS CONTACT WITH THEM IS ALMOST INVARIABLY FATAL.

Be sure the antenna system is grounded so as to provide some protection against voltage surges and built-up static charges. Section 810 of the National Electrical Code in USA and Section 54 of the Canadian Electrical Code(ANSI/NFPA 70) in Canada provides information with respect to proper grounding of the mast and supporting structure, grounding of the lead-in wire to an antenna discharge unit, size of grounding conductors, location of antenna discharge unit, connection to grounding electrodes, and requirements for the grounding electrode.

Example of antenna grounding according to National Electrical Code (NEC)

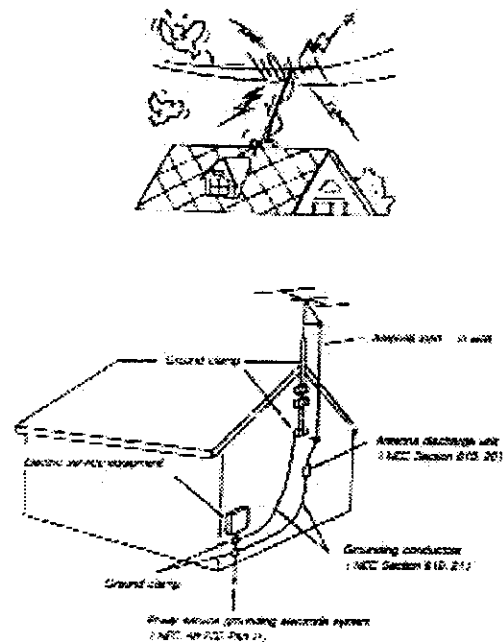

BEFORE OPERATION (continued)

FCC Warning

Class B Computing Device

Information to User

This equipment has been tested and found to comply with the limits for a class B digital device pursuant to part 15 of FCC Rules. These limits are designed to provide reasonable protection against harmful interference in a residential installation. This equipment generates, uses, and can radiate radio frequency energy and, if not installed and used in accordance with the instructions, may cause harmful interference to radio communications. However, there is no guarantee that interference will not occur in a particular installation. If this equipment off and on, the user is encouraged to try to correct the interference by one or more of the following measures:

- 1) Reorient or relocate the receiving antenna.
- 2) Increase the separation between the equipment and receiver.
- 3) Connect the equipment into an outlet on a circuit different from that to which the receiver is connected.
- 4) Consult the dealer or an experienced radio/TV technician for help and for additional suggestions.

The user may find the following booklet prepared by the Federal Communications Commission helpful: "How to Identify and Resolve Radio -TV Interference Problems". This booklet is available from the US Government Printing Office, Washington, D. C 20402, Stock No. 004-000-00345-4.

FCC Warning

The user is cautioned that changes or modifications not expressly approved by the manufacturer could void the user's authority to operate the equipment.

NOTE: In order for an installation of the product to maintain compliance with the limits for a Class B device, shielded cables must be used.

BEFORE OPERATION (continued)

FCC Warning

Class B Computing Device

Information to User

This equipment has been tested and found to comply with the limits for a class B digital device pursuant to part 15 of FCC Rules. These limits are designed to provide reasonable protection against harmful interference in a residential installation. This equipment generates, uses, and can radiate radio frequency energy and, if not installed and used in accordance with the instructions, may cause harmful interference to radio communications. However, there is no guarantee that interference will not occur in a particular installation. If this equipment off and on, the user is encouraged to try to correct the interference by one or more of the following measures:

- 1) Reorient or relocate the receiving antenna.
- 2) Increase the separation between the equipment and receiver.
- 3) Connect the equipment into an outlet on a circuit different from that to which the receiver is connected.
- 4) Consult the dealer or an experienced radio/TV technician for help and for additional suggestions.

The user may find the following booklet prepared by the Federal Communications Commission helpful: "How to Identify and Resolve Radio -TV Interference Problems". This booklet is available from the US Government Printing Office, Washington, D. C 20402, Stock No. 004-000-00345-4.

FCC Warning

The user is cautioned that changes or modifications not expressly approved by the manufacturer could void the user's authority to operate the equipment.

NOTE: In order for an installation of the product to maintain compliance with the limits for a Class B device, shielded cables must be used.

CONTENTS

INTRODUCTION	
Features.....	9
Control Buttons.....	10
Menus.....	12
INSTALLATION	
To Connect the Antenna.....	13
Remote Batteries.....	13
To Connect External Equipment.....	14
BASIC FUNCTIONS	
Power On/Off.....	15
On - Screen Display.....	15
Tuning in.....	16
Function Selection.....	17
General Operation.....	20
Picture Improvement.....	22
Sound Improvement.....	23
ADDITIONAL FEATURES	
Time Setting.....	24
Childlock.....	24
Programming the Remote Control.....	25
SPECIFICATIONS.....	27
TROUBLESHOOTING GUIDE.....	28
LIMITED UNITED STATES WARRANTY.....	29

Note:

The OSD and illustration in this manual may be somewhat different from the actual situation. Please take the TV as the standard.

FeaturesINTRODUCTION

Features

True Flat Picture Tube

- Delivers real pictures, which ensures that you can watch sharper and more natural pictures. By adopting the invar shadow - mask, the tube increases the transparency and reduces thermal deformation, which greatly improves the picture stability and delivers more vivid pictures.

English/French/Spanish Menus

- The unique English/French/Spanish menu control function makes the operation more easily.

181 Channel Tuner

- 2-69 channels in the Air mode and 1-125 channels in the Cable mode can be preset (of which 2-13 channels in the Air and Cable modes are the same.)

AV/S - VIDEO Terminals for External Equipment Connection

On/Off Timer

- The TV automatically turns off and on and tunes to the desired channel at the time when programmed.

Auto Off

- Under no signal condition, the TV will turn off in15 min.

Childlock Function

- Prevents children from watching TV for a long period of time. Especially when parents are out .

Parental Control

- Prevents children from watching programs not suitable for them.

Quick Selectable Picture/Sound Modes

- Allows one - touch selection of your favorite picture and sound quality among three picture modes and four sound modes.

CCD /Text Function

- If they are included in a program, you can view closed captions or text information.
Correction Technology
- Reduces picture noise and improves color quality.

Black Level Extension

- The black level extension circuit circuit enhances the picture gradation.

Digital Geometric Correction

- The TV adopts digital geometric correction with no mechanic adjustment, which offers the TV reliability.

Channel Scan

- Displays all channels set in the Add mode.

MTS Stereo

AVC - Auto Volume Correction

INTRODUCTION (continued)

Control Buttons

Front panel (Gt2415, GT2715, GT3215)

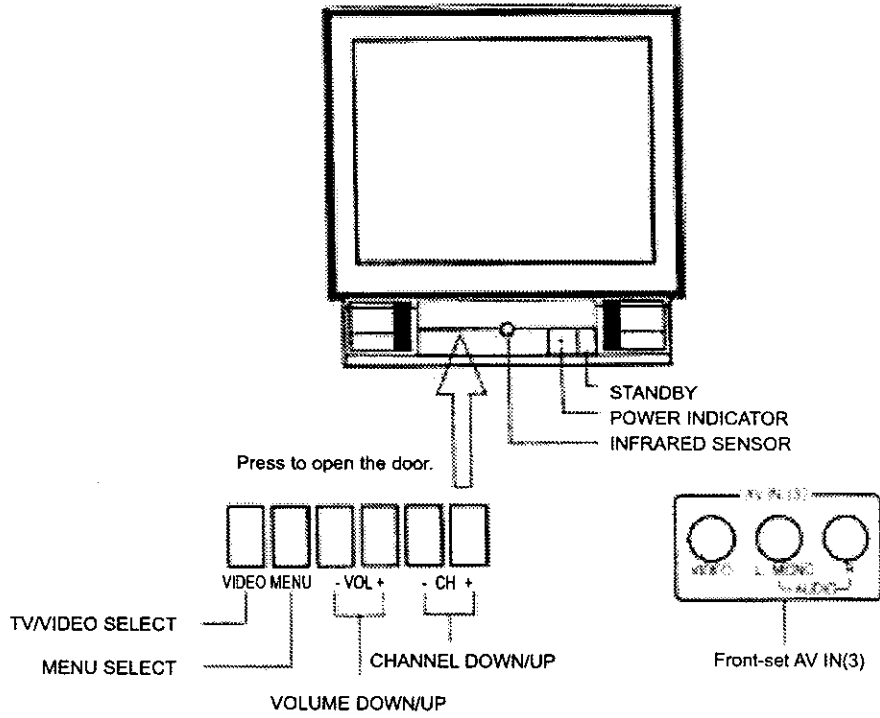

Note:

The buttons on the TV set share the same functions with those buttons of the same name on the remote control. The following section of this manual will focus on operation of the remote control.

Top panel

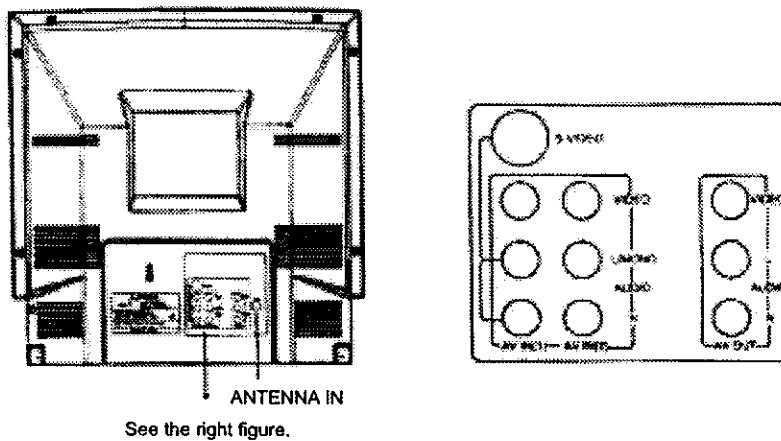

INTRODUCTION (continued)

Control Buttons (continued)

Remote control

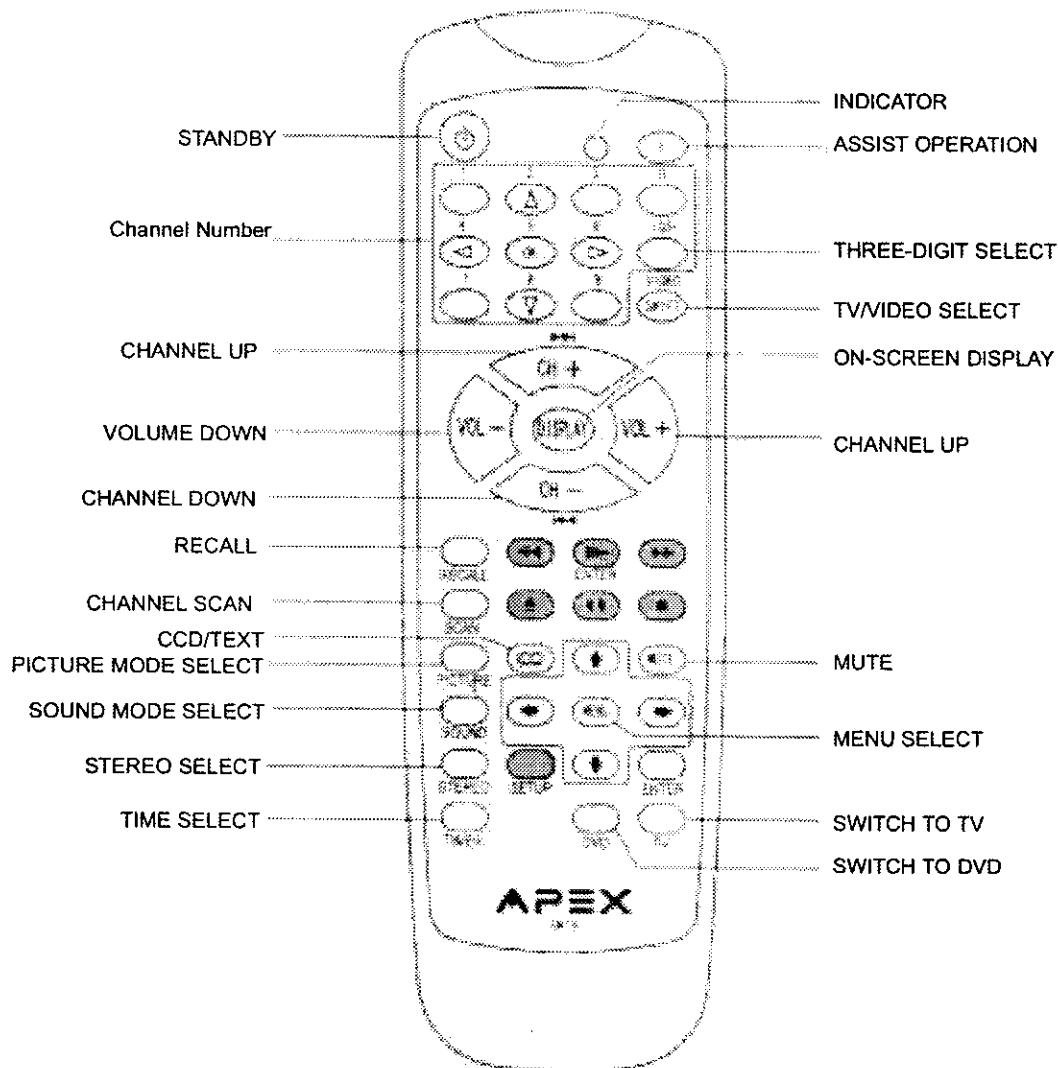

The buttons marked with shades don't function for the TV set.

○

Notes:

- ① When in operation, please point your remote control directly to the infrared sensor.
- ② Do not expose the remote control to impacts, water or disassemble it.
- ③ Do not repeatedly press the buttons on the remote control. Allow interval of no less than one second between selections.

INTRODUCTION (continued)

Menus

Press the MENU button, and the TV will display the primary menu as follows:

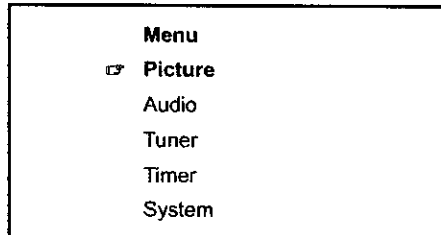

To adjust a function, press the ↓ / ↑ buttons to highlight the selection, and press the ← / → buttons to select a sub-menu. (Take English menus for example).

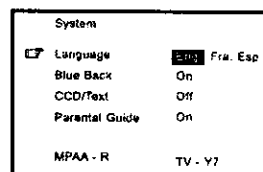
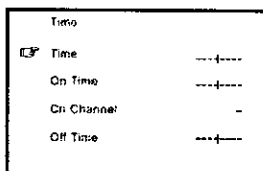
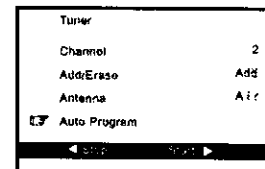
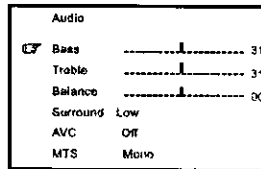
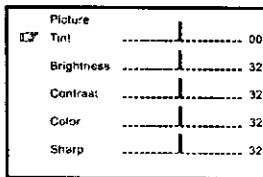

After selecting a sub-menu, press the ↓ / ↑ buttons to highlight the desired item and press the ← / → buttons to adjust.

MENU display except "Tuner" disappears 6 seconds after last selection.

Notes:

- ① After calling up the sub menu, pressing the MENU button can return to the primary menu display.
- ② The adjustable Tint range in the Picture menu and Balance range in the Audio menu are - 31 ~ +31 and L31 ~ R31 respectively while the other adjustments are 0 ~63.
- ③ When the Tuner menu is recalled, the display will not disappear automatically. Press the DISPLAY button to cancel menu display.

Call up a sub - menu in the same way mentioned above, then press the ↓ / ↓ buttons to highlight an adjustment and the ← / → buttons to adjust the selection. In the following function introductions, the operations are similar to the above ways unless otherwise noted.

INSTALLATION

- Please read the safety instructions in this manual completely before installation.
- Install your TV in a room where direct sunlight will not fall upon the screen.
- Allow enough space (at least 10cm) between the TV and the wall for proper ventilation.
- It is recommended to watch TV in soft and indirect light. The optimum watching distance is 5-7 times of the screen's vertical length.

Auto-degaussing

Color TV is easily affected by magnetism which leads to color distortion. If your TV is moved or affected by near magnetic components or appliances with power on, press the  button to power off your TV for at least 1 hour. The built-in auto-degaussing circuit will eliminate the magnetism interference.

To Connect the Antenna

An outdoor antenna or CATV is recommended for the best reception.

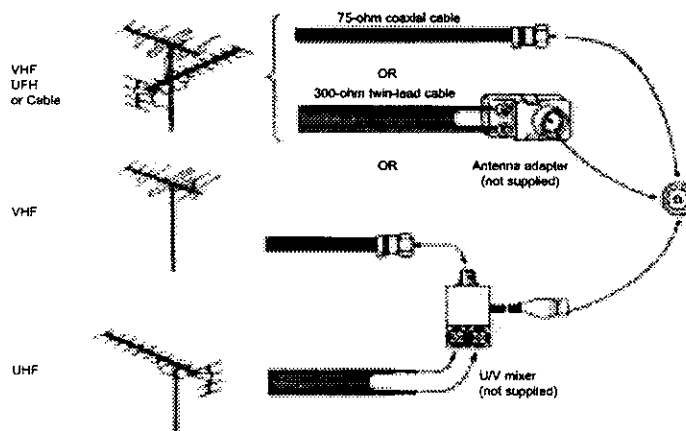

Notes:

- ① It is recommended that a 75 ohm coaxial cable be used in order to eliminate possible interference and noise which may occur due to nearby radio transmissions.
- ② The antenna cable should not be tied together with other wiring.
- ③ Set up a lightning arrester and check it regularly when an outdoor antenna is used.

Remote Batteries

- ① Remove the battery compartment lid.
- ② Place in two AAA batteries. Make sure the positive \oplus and negative \ominus polarities are correct.
- ③ Reattach the battery lid.

Notes:

- ① Alkaline batteries are recommended for longer life. Always replace both batteries with fresh ones of the same type.
- ② Do not expose batteries to fire or disassemble them.
- ③ To avoid battery leakage, remove batteries from the remote control when it is not to be used for a long period of time or the batteries are exhausted.

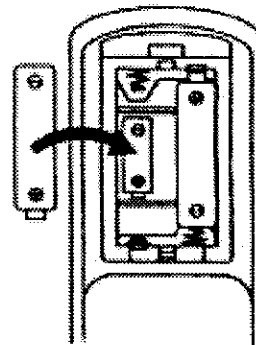

INSTALLATION (continued)

To Connect External Equipment

The following are optional connections. Please refer to operation manuals of external audio/video equipment that will be connected to your set.

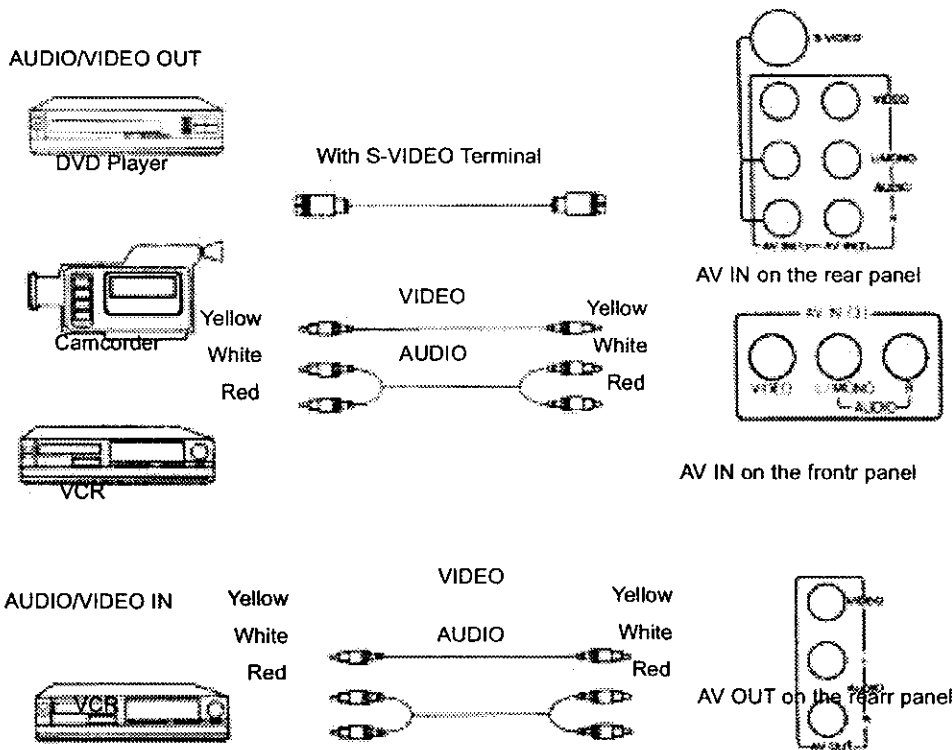
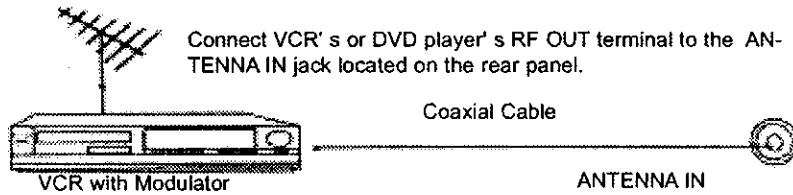

Notes:

- ① Before connection, do power off your TV and external equipment.
- ② To receive signals from external equipment, you must select a proper AV input.
- ③ Do not use S - VIDEO and AV IN(1) terminals at the same time.

BASIC FUNCTIONS

Power On/Off

1. Power on

Plug in the supply socket, and press the MAIN POWER SWITCH on the TV to enter the Power On mode.

2. Standby

When in the Power On mode, press the  button on the remote control to enter the Standby mode. At this time, part of circuit on the TV set remains active.

In the Standby mode, press the  button on the remote control to enter the Power On mode.

3. Power off

When in the Power On or Standby mode, Press the MAIN POWER SWITCH on the TV to turn off the power supply of the TV set.

Note:

Avoid switching the TV on and off frequently. Doing so may shorten life span of internal components.

Auto off when no signal received

When a channel has no signal (e.g. program is over) and if no button is pressed within 15 minutes, the TV will automatically enter the Standby mode. If the Off Time is preset and the time left is less than 15 minutes, the TV will carry out the Off Time program prior to the auto-off.

On - Screen Display

Press the DISPLAY button repeatedly in the TV or Video mode to display the current mode on the screen and turn off the display respectively.

Press the DISPLAY button first and the TV screen is displayed as follows.

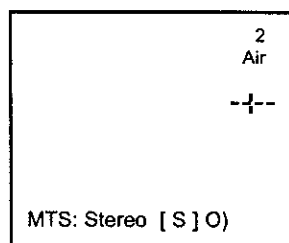

In the TV mode

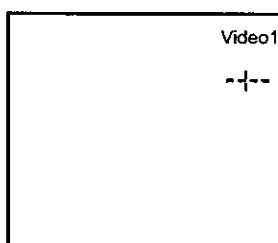

In the Video mode

Note:

With other OSD, pressing the DISPLAY button first can turn it off.

BASIC FUNCTIONS (continued)

Tuning in

This section gives descriptions about adjustment of items in the Tuner menu.

1. Auto program

1) Press the ↓ / ↑ buttons to highlight "Auto Program".

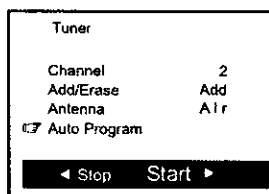

2) Press the → button, and the TV will search automatically in sequence. After auto search, the TV will store receivable channels and return to the lowest channel number.

During auto program, press the ← button to stop searching.

Notes:

- ① After auto program, there may be some repeated channels or inferior signal received. In this case, press any of the ← / →, Channel Number buttons to select one of the channels. Then set Add/Erase to Erase so that pressing the CH - / + buttons can not call up the channels. To resume the channels, set Add/Erase to Add in the way mentioned above.
- ② When Antenna is set to the Air mode, the TV will auto search from channel number 2 to 69; when set to the Cable mode, it will auto search from 1 to 125 (of which 2 -13 channels in the Air and Cable modes are the same.)

2. Channel selection

Press the ↓ / ↑ buttons to highlight "Channel" in the Tuner menu, and press any of the ← / →, Channel Number buttons to select channel numbers.

3. Add/Erase selection

Press the ↓ / ↑ buttons to highlight "Add / Erase", and press the ← / → buttons to select "Add" or "Erase" cyclically.

BASIC FUNCTIONS (continued)

Function Selection Menus

1. Language selection

1) Press the ↓ / ↑ buttons to highlight "Language".

System	
Language	Eng. Fra. Esp.
Blue Back	On
CCD/Text	Off
Parental Guide	On
MPAA - R	TV - Y7

2) Press the ← / → buttons to select a desired language display (English/French/Spanish).

2. Blue screen display

When there is no signal received with Blue Back On, the TV will display a soft blue background on the screen.

1) Press the ↓ / ↑ buttons to highlight "Blue Back".

System	
Language	Eng. Fra. Esp.
Blue Back	On
CCD/Text	Off
Parental Guide	On
MPAA - R	TV - Y7

2) Press the ← / → buttons and set Blue Back to On.

Notes:

- 1 The Blue Back function is inactive during search.
- 2 If Blue Back is set to Off, noise dots will be displayed on the screen when no signal is present in the TV mode. Blue Back is not available when no signal is present in the Video mode.

3. Closed caption function

When available in a program, you can view closed captions or text information.

1) Press the ↓ / ↑ buttons to highlight "Closed Caption".

System	
Language	Eng. Fra. Esp.
Blue Back	On
CCD/Text	Off
Parental Guide	On
MPAA - R	TV - Y7

2) Press the ← / → buttons (- VOL + buttons on the TV) to select one of the 9 modes

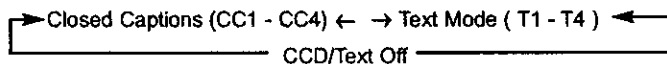

When you select the Closed - Caption (CC1-CC4) mode, the TV can decode CCD signal, and display it on the screen, which is especially helpful for hearing impaired individuals.

Closed caption provides an on-screen display of the dialogue, narration, and / or sound effects of a TV program.

BASIC FUNCTIONS (continued)

Function Selection (continued)

Captions will appear at either the top or bottom of the screen while a captioned broadcast is received.

When you select the Text (T1-T4) mode, the TV can receive teletext signal.

When you select "CCD/Text Off", the CCD / Text function is off.

3) Press the **CC** button to turn on/off the CCD/Text mode.

Notes:

- A CCD signal may not be decoded in the following conditions:
 - When a video tape has been dubbed.
 - When the signal reception is weak.
 - When the signal has been changed or altered.
- With signal received without Closed Captions or Text, closed captions or text characters do not appear on the screen.

4. Parental Control

You may prevent children from watching programs not suitable for them, such as sexual or violence programs.

Press the \downarrow / \uparrow buttons to highlight "Parental Guide"(provided it has been preset).

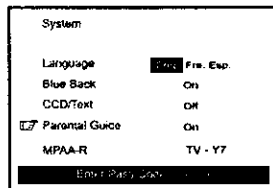

Use the Channel Number buttons to enter the initial pass code 6688, then press the \rightarrow button again to proceed to the next menu display.

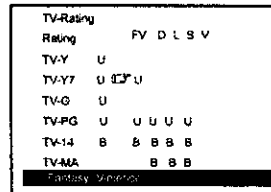
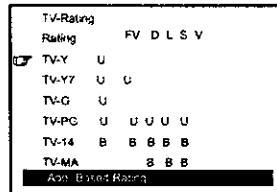

The TV ratings are divided into two groups: age - based and content - based.

Age	Defined as
TV - Y	All Children
TV - Y7	Directed to Older Children
TV - G	General Audience
TV - PG	Parental Guidance Suggested
TV - 14	Parents Strongly Cautioned
TV - MA	Mature Audience Only

Contents	Defined as
FV	Fantasy Violence
D	Sexually Suggestive Dialogue
L	Adult Language
S	Sexual Situations
V	Violence

Press the \downarrow / \uparrow buttons to highlight one of the items TV-Y, TV-Y7, TV-G, TV-PG, TV-14, TV-MA, Rating, FV, D, L, S, V. Press the MENU button to display "U" or "B" on the screen. A "U" indicates a rating which is unblocked and a "B" indicates a rating which is blocked.

BASIC FUNCTIONS (continued)

Function Selection (continued)

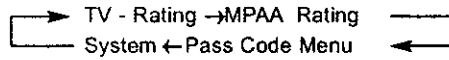

Press the ←-button to move the cursor from " Pass Code Menu ", " MPA A Rating ", " TV-Rating" to " System", and select " Parental Guide Off " to stop circulation.

The following is the MPA A-Rating menu.

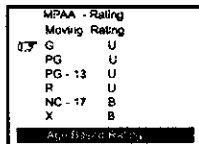

Press the →button repeatedly to recall the Pass Code menu as follows.

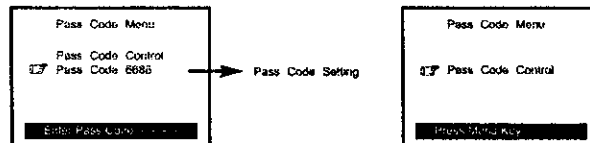

After calling up the Pass Code Menu first, press the ↓ / ↑ buttons to highlight "Pass Code 6688", and then "Enter Pass Code - - -" appears on the screen. Press the Channel Number buttons to enter new pass code which you need enter when calling up the Parental Guide Menu.

Notes:

- ① Only when the set pass code appears on the screen before the menu display is turned off, does the TV remind you of entering the pass code when you call up the Parental Guide Menu again.
- ② If you forget the new pass code when turning on the Parental Guide Menu display, you may enter the initial pass code 6688.
- ③ If you wouldn't like to set any pass code, press the ↓ / ↑ buttons to highlight Pass "Code Control" and MENU button to turn off the pass code setting display.

BASIC FUNCTIONS (continued)

General Operation

1. To control volume



Press the - VOL + buttons to decrease or increase the volume.

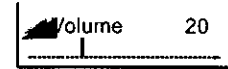

While adjusting volume, press the F and - VOL + buttons at the same time and the volume decreases or increases by 4 levels.



During normal play, press the MUTE button to eliminate the sound until you press the VOL + or MUTE button again.



2. To select a channel



Press the CH + button to choose higher-numbered channels and the -CH button to choose lower-numbered channels. For example, if the current channel number is 7 (Provided that Channel 6,8 are set to Add).

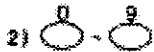
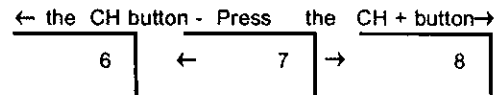

Using the Channel Number buttons

- To select a one -digit channel number
Press the 0 button, then press another Channel Number button (except 100+) to select a desired number.
- To select a two -digit channel number
Enter a first-digit, then second-digit.
- To select channel number between 100 and 125 in the Cable mode
Press the 100+ button so that "1_ _" appear on the screen, then enter the next digit one and two.

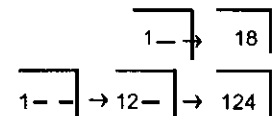
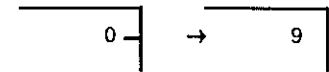

Press the RECALL button and the TV will directly skip back to the previous channel. For example, you are watching Channel 3 and previously you watched Channel 15. If you press the RECALL button, the channel number will skip directly from Channel 3 to Channel 15. Press the RECALL button repeatedly to change between these two channels.

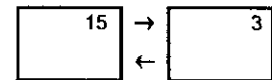

Note:

In the Video mode, pressing the RECALL button can return to the TV mode.

BASIC FUNCTIONS (continued)

General Operation (continued)



- 4) **SCAN**  ① Press the SCAN button so that "Scan Off" appear on the screen.
② Press the SCAN button again so that "Scan On" appear on the screen and the TV begins to scan from the current channel.

Scan On



Note:

During scanning, pressing any button can interrupt scanning.

3. CCD/Text switch

-  Press the  button to display the current Closed Captions/Text mode on the screen. Press the button again to display "CCD/Text Off" on the screen

4. TV/Video selection

- VIDEO**  Press the VIDEO button, and the screen display changes in circular way:
 Video1 → Video2 → Video3 → S → VHS → Channel Number

To receive signals from external equipment, please be sure to select a corresponding Video mode.

Notes:

In the Video mode, pressing the CH - / + buttons can return to the TV mode.

5. Stereo selection

-  **STEREO** In the TV mode, the TV can automatically identify MTS stereo modes among Mono, Stereo, SAP and SAP.
Press the STEREO button firstly to display the auto - identified MTS mode on the screen. Press the button again before the OSD disappears to shift to other MTS mode as follows.
With Stereo/SAP signal received, you may select one of the SAP, Stereo and Mono modes cyclically.
With Stereo signal received, you may select one of the Stereo and Mono modes cyclically.
With Mono signal received, only Mono mode can be available.

BASIC FUNCTIONS (continued)

Picture Improvement

1. To select picture modes



Press the PICTURE button repeatedly to select one of the Normal, Memory and Theater modes.

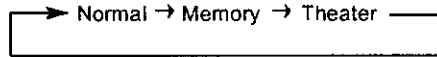

Refer to the following introduction about each mode.

Mode	Picture Quality
Normal	Standard mode, suitable for watching ordinary program.
Memory	Picture quality users set.
Theater	Movie-like picture setting, suitable for viewing some movie programs.

2. To set desired picture quality

1) Call up the Picture menu and the TV screen is displayed as follows.

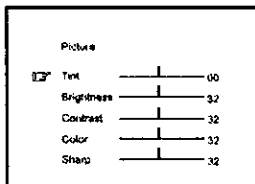

2) Press the ↓ / ↑ buttons to choose an adjustment.

3) Press the ← / → buttons to adjust the digital level of the selected adjustment as desired.

The adjusted level is stored in the MEMORY position and remains unchanged until next adjustment.

Item	Picture Quality	
	Press	
	← button	→ button
Tint	Purplish	Greenish
Brightness	Darker	Brighter
Contrast	Lower	Higher
Color	Paler	Deeper
Sharp	Softer	Sharper

BASIC FUNCTIONS (continued)

Sound Improvement

1. To select sound modes



Press the SOUND button repeatedly to select one of the Speech, Music, Theater and Memory modes.

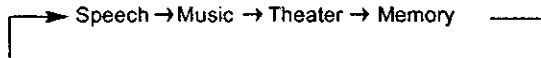

Refer to the following introduction about each mode.

Mode	Sound Quality
Speech	Language clarity improvement, suitable for program focusing on dialogue
Music	Suitable for enjoying music programs
Theater	Movie-like sound setting, suitable for enjoying dynamic sound, such as programs of entertainment
Memory	Sound quality users set

2. To set desired sound quality

1) Call up the Audio menu.

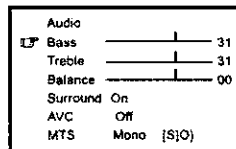

2) Press the ↓ / ↑ buttons to select an adjustment.

3) Press the ← / → buttons to adjust the digital level of the selected item as desired.

The adjusted level is stored in the Memory position and remains unchanged until next adjustment.

Item	Sound Quality	
	Press	
	← button	→ button
Bass	Weaker	Stronger
Treble	Weaker	Stronger
Balance	Decrease the right volume	Decrease the left volume
Surround	On, Off	
AVC	On, Off	
MTS	Refer to "Stereo selection".	

ADDITIONAL FEATURES

Time Setting

In the Standby or Power On mode, the TV can automatically complete some functions such as power -on, channel preset and power-off as desired.

- 1 . Press the TIMER button to turn on the Timer menu display as shown right.
- 2 . Press the ↑ / ↓ buttons to select an adjustment.
- 3 . Press the ← / → buttons to adjust the selection.

For example, now it is 6:00PM, you have set On Time, On Channel and Off Time to 7:00PM, 22 and 8:00PM respectively. The TV will automatically perform the above settings in the Standby or Power On mode.

Notes:

- ① Only after setting "Time", can you set other items.
- ② If the TV is powered off with the MAIN POWER SWITCH, all the settings will automatically be cancelled.

Timer	
<input checked="" type="checkbox"/> Time	--+-
On Time	--+-
On Channel	-
Off Time	--+-



Timer	
Time	6:00PM
On Time	7:00PM
On Channel	22
<input checked="" type="checkbox"/> Off Time	8:00PM

Childlock

The CHILDLOCK function prevents children from watching TV.

Hold down the F button and then press the MUTE button until the symbol

"" appears on the screen, and the TV enters the CHILDLOCK mode.

Except for the symbol "", the screen becomes blue back and mutes when you press the  button to turn the TV off, then turn the TV on after setting the CHILDLOCK function. To unlock the TV, hold down the F button and then press the MUTE button again.

Note:

The CHILDLOCK can be set or cancelled only by the remote control.

After setting CHILDLOCK, secure the remote control in a safe place.

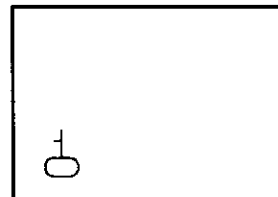

ADDITIONAL FEATURES (continued)

Programming the Remote Control

1. Remote - control switchover

Press the TV, VCR/DVD, SAT/CAB or AUX button to select the device you want to control.

2. To program the remote control

1. Press and hold the TV, VCR/DVD, SAT/CAB or AUX button for over 2 seconds until the INDICATOR on the remote control turns off. Release the button (the INDICATOR will light again) and the remote control enters the PROGRAMMING mode.
2. Use the 0 - 9 buttons to enter three - digit code number for your equipment. If the correct code number is entered, the INDICATOR blinks three times. If you enter a code not listed below, or you press any other buttons than SEARCH and 100 +, the INDICATOR turns off.

3. DVD codes

Code No.	Model.No	Code.No	Model.No
00	AD1000 AD1200 AD1500 AD1600 AD500 AD500B AD500W AD500WM AD600A AD703A AD5131 AD1700M	05	MD100
01	AD1000W	06	AD800
02	AD7701	07	AT-100W
03	AD3201	08	AD2100
04	AD660 AD700		

4. Descriptions of the buttons

1) Buttons for TV and DVD: ⏻, 0-9, 100+, VIDEO/SHIFT, VOL-,VOL+,CH-/PREV,CH+/NEXT, DISPLAY,MUTE, MENU, ←, →, ↓ and ↑

2) Buttons for DVD only: PLAY/ENTER,STOP,PAUSE,OPEN/CLOSE,REV,FWD,SETUP,ENTER











3) Buttons for TV only: RECALL,SCAN,PICTURE,SOUND,STEREO,TIMER,CC

Note: The REV,FWD,VOL - , VOL + buttons don't function for the device marked with *.

ADDITIONAL FEATURES (continued)

Programming the Remote Controller (continued)

Operating a DVD player

Press	To
	1. Power on the VCR
	2. Select channels directly
	3. Play DVD
	4. Stop
	5. Pause
	6. Move the cursor in the men
	7. Display the DVD menu
	8. PREV (CH -) /NEXT (CH +)
	9. REV/FWD
	10. Open/Close

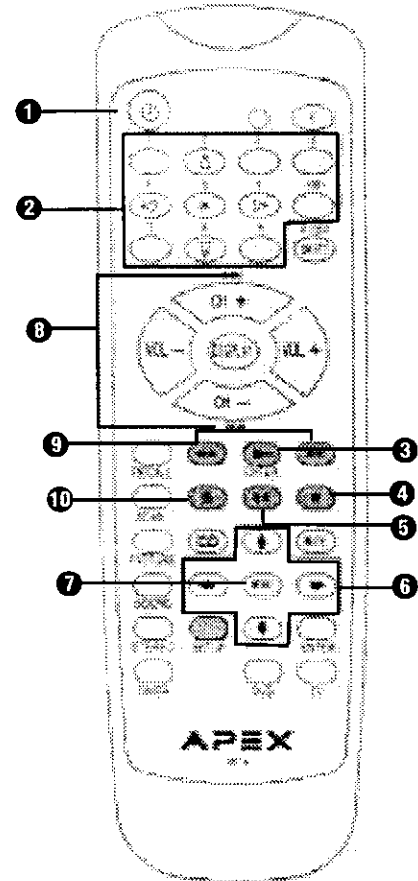

The buttons marked with shades don't function for the TV set.

Notes:

- 1 When in operation, please point your remote control directly to the infrared sensor.
- 2 Do not expose the remote control to impacts, water or disassemble it.
- 3 Do not repeatedly press the buttons on the remote control. Allow interval of no less than one second between selections.

Note:

When operating your non - TV AV equipment with the remote controller, refer to operation instructions of your original remote.

SPECIFICATIONS

Model Number	GT2015	GT2415	GT27125	GT3215
Television system	NTSC-M			
Channel coverage	VHF 2~13/UHF 14~69/CABLE TV: MID BAND(A-8~A-1, A-I) SUPER BAND(J~W) HYPER BAND(AA~ZZ, AAA, BBB) ULTRA BAND(65~94, 100~125)			
Channels preset	181			
Antenna input	75 (unbalanced)			
Pictue tube Effective screen dimensions (Approx.)	280mm x 210mm 15.98 x 12.01 in.	478mm x 363mm 18.82 x 12.29 in.	540mm x 405mm 21.26 x 15.94 in.	640mm x 478mm 25.20 x 18.82 in.
Max.audio output	5W+5W			
Power source	~120Vac 60Hz			
Weight(Approx.)	25.2kg (55.44 lbs)	30kg(66 lbs.)	48kg(106 lbs.)	71kg(156 lbs.)
Dimensions(W/H/D) (Approx.)	512 x 522 x 510mm (20.16 x 20.55x 20.08 in.)	587 x 575x 482mm 23.10 x 22.62 x 18.98 in.	674x 639x 516mm 26.54 x 25.16x 20.31 in.	768 x 721x 570mm 30.24 x 28.39 x 22.44in.
Packing Dimensions (Approx.)	614 x 634 x 614mm (24.17 x 24.96 x 24.17 in.)	707 x 690x 580mm 32.13 x27.12 x 22.83 in.	816 x 770x 633mm 32.13x 30.31 x 24.92 in.	984x 775x 742mm 38.74 x 30.51x29.21in.
Rated power consumption	~110W	125W	135W	150W

Designs and specifications are subject to change without notice.

TROUBLESHOOTING GUIDE

Check the following guide for a possible correction to a problem before contacting customer service. Check FAQ at our website: www.apexdigitalinc.com.

Symptoms and Correction

Symptoms	Correction
No power	<ul style="list-style-type: none"> • Connect the power plug into the wall outlet securely.
No picture	<ul style="list-style-type: none"> • Verify the connection from the DVD/VCR video output to the TV video input is secure. Then switch TV to the appropriate Video mode. • Verify coaxial cable from antenna is connected to RF IN.
No sound	<ul style="list-style-type: none"> • Connect the audio cables into the terminals securely. • Verify the connection from the DVD/VCR audio output to the TV audio input. Then switch to the appropriate mode on the receiver. Refer to your audio amplifier owner's manual. • Mute feature may be enabled. • Make sure MTS feature is properly set.
No TV signal	<ul style="list-style-type: none"> • Check whether your receiver is set to the TV mode. • Check whether the antenna is well connected to the TV receiver. Unplug the TV from the wall for 30 seconds, then plug in and try again. Unplug the antenna connection from the back of the TV, unplug the TV from the wall, wait 30 seconds, then try again.
Stripe or purple interference appears in the screen.	<ul style="list-style-type: none"> • Interference may come from high frequency sources such as a broadcasting station, poor ground connection in cable used, or non shielded audio speakers too close to the picture tube.
Picture becomes snowy.	<ul style="list-style-type: none"> • Check the antenna lead wire to see if it has open circuit or not. • Check the connection of antenna lead wire to the TV set input. • Check whether there is any damage to antenna.
Picture with multi-image	<ul style="list-style-type: none"> • Change the direction of antenna to minimize the multi image. • The video frequency radiated from TV station can be reflected by tall buildings, high tower, etc.
No stereo or foreign language received	<ul style="list-style-type: none"> • Make sure MTS feature is properly set.
TV channel not received	<ul style="list-style-type: none"> • Make sure the Air/Cable setting is correct. • Channel may be locked with the block channel feature, such as Parental Control. • Check Add/Erase feature, as channel may have been erased during set up.
Black box appears on screen.	<ul style="list-style-type: none"> • Closed Caption to Text feature may be active.
Remote control doesn't operate.	<ul style="list-style-type: none"> • Batteries may be weak. Replace batteries. • Make sure remote sensor is not blocked including deflection from curved glass cabinet. <p>Program the remote control to 000 for your TV. See "Programming the Remote Control"</p>

LIMITED UNITED STATES WARRANTY GT Series

Apex Digital, Inc. makes the following limited warranties. These limited warranties extend to the original consumer purchaser or any person receiving this product as a gift from the original consumer purchaser and to no other purchaser or transferee.

Limited Ninety (90) Days Warranty

Apex Digital, Inc. warrants this product and its parts against defects in material or workmanship for a period of ninety (90) days after the date of original retail purchase. During this period Apex Digital, Inc. will repair or replace a defective part or product at their option, with a new or refurbished part or product, without charge to you. Authorized Apex Digital, Inc. Service Center personnel will come to your home when warranty service is required. Depending on the type of repair required, the service will either be performed in your home or the set will be taken to the Authorized Apex Digital, Inc. Service Center's repair facility for repair and then returned to your home at no cost to you.

Limited One (1) Year Warranty

Apex Digital, Inc. further warrants the parts in this product against defects in materials or workmanship for a period of one (1) year after the date of original retail purchase with exception of the remote control which is guaranteed for ninety (90) days. During this period Apex Digital, Inc. will replace a defective part with a new or refurbished part without charge to you, except that if a defective part is replaced after ninety (90) days from the date of original retail purchase, you are responsible to pay all labor charges involved in the part(s) replacement including all packing, transportation and insurance charges for the set to and from the Service Center.

Limited Two (2) Years Warranty

Apex Digital, Inc. further warrants the picture tube in this product against defects in materials or workmanship for a period of two (2) years after the date of original retail purchase. During this period Apex Digital, Inc. will replace the defective picture tube at their option with a new or rebuilt picture tube or at their option replace the entire product with a new or refurbished product at no charge to you; if however the defective picture tube or product is replaced after one (1) year from the date of the original retail purchase, you pay all labor, packing and transportation charges involved in the replacement.

Rental Product

The warranty for a rental product begins with the original date of receipt by the rental firm.

- **Your Responsibility**

The above warranties are subject to the following conditions:

You must retain your bill of sale to provide proof of purchase.

All warranty service of this product must be made by an Authorized Apex Digital, Inc. Service Center.

These warranties are effective only if the product is purchased and operated in the U.S.A., Hawaii and Puerto Rico.

Labor service charges for set installation, setup, adjustment of customer controls and installation or repair of any type of antenna or cable systems are not covered by this warranty. Reception problems caused by inadequate antenna or cable system are your responsibility.

Warranties extend only to defects in materials or workmanship as limited above and do not extend to any product or parts which have been lost or discarded by you or damage to product or parts caused by misuse, accident, damage caused by Acts of God, such as lightning or fluctuations in electrical power, improper installation, improper maintenance or use in violation of instructions furnished by us; or to product which has been modified or had the serial number removed, altered, defaced or rendered illegible.

Warranties do not cover cosmetic damages or lost accessories.

How to Obtain Warranty Service

If after following all the operating instructions in this manual and reading the section TROUBLESHOOTING you find that service is necessary:

1. Should it be necessary contact our Customer Service Center directly call 866 4 APEXINC (866 427 - 3946), Mon - Fri 8am - 5pm (Pacific Time).
2. After obtaining the requested information, you must present your bill of sale to the Authorized Service Center to obtain warranty service.
3. Authorized Apex Digital, Inc. Service personnel will come to your home when warranty service is required. Depending on the type of repair required, the service will either be performed in your home or the set will be taken to the Authorized Service Center's facility for repair and then returned to your home.

Limitations

All warranties implied by state law, including the implied warranties of merchantability and fitness for a particular purpose, are expressly limited to the duration of the limited warranties as set forth above. With the exception of any warranties implied by state law as hereby limited, the foregoing warranty is exclusive and in lieu of all other warranties, guarantees, agreements and similar obligations of manufacturers or seller with respect to the repair or replacement of any parts. In no event shall Apex Digital, Inc. be liable for consequential or incidental damages.

No person, agent, distributor, dealer or company is authorized to change, modify or extend the terms of these warranties in any manner whatsoever. The time within which action must be commenced to enforce any obligation of Apex Digital, Inc. arising under this warranty or under any statute, or law of the United States or any state thereof, is hereby limited to ninety (90) days from the date you discover or should have discovered the defect. This limitation does not apply to implied warranties arising under state law.

This warranty gives you specific rights and you may also have these rights which may vary from state to state. Some states do not allow limitation on how long an implied warranty lasts, when an action may be brought, or the exclusion or limitation of incidental or consequential damages, so the above provisions may not apply to you.

Packing List

NO.	Parts	Quantity	Remarks
1	GT Series Color TV Receiver	1	
2	K12C-C1 Infrared Remote Control	1	
3	Operation Manual	1	
4	AAA Alkaline Batteries	2	
5			

APEX Digital, Inc.

2919 E. Philadelphia Street

Ontario, CA 91761

www.apexdigitalinc.com