

# ONKYO.

## Contents

**AV Receiver**

**Before using** 2

# *TX-DS797*

**Instruction Manual**

**Facilities and connections** 8

**Setup and operation** 26

**Remote controller** 56

**Appendix** 71

Thank you for purchasing the Onkyo AV Receiver. Please read this manual thoroughly before making connections and plugging in the unit. Following the instructions in this manual will enable you to obtain optimum performance and listening enjoyment from your new AV Receiver. Please retain this manual for future reference.

**WARNING:**

TO REDUCE THE RISK OF FIRE OR ELECTRIC SHOCK, DO NOT EXPOSE THIS APPLIANCE TO RAIN OR MOISTURE.

**CAUTION:**

TO REDUCE THE RISK OF ELECTRIC SHOCK, DO NOT REMOVE COVER (OR BACK). NO USER-SERVICEABLE PARTS INSIDE. REFER SERVICING TO QUALIFIED SERVICE PERSONNEL.



**WARNING**  
RISK OF ELECTRIC SHOCK  
DO NOT OPEN

**AVIS**  
RISQUE DE CHOC ELECTRIQUE  
NE PAS OUVRIR



The lightning flash with arrowhead symbol, within an equilateral triangle, is intended to alert the user to the presence of uninsulated "dangerous voltage" within the product's enclosure that may be of sufficient magnitude to constitute a risk of electric shock to persons.



The exclamation point within an equilateral triangle is intended to alert the user to the presence of important operating and maintenance (servicing) instructions in the literature accompanying the appliance.

## Important Safeguards

1. **Read Instructions** – All the safety and operating instructions should be read before the appliance is operated.
2. **Retain Instructions** – The safety and operating instructions should be retained for future reference.
3. **Heed Warnings** – All warnings on the appliance and in the operating instructions should be adhered to.
4. **Follow Instructions** – All operating and use instructions should be followed.
5. **Cleaning** – Unplug the appliance from the wall outlet before cleaning. The appliance should be cleaned only as recommended by the manufacturer.
6. **Attachments** – Do not use attachments not recommended by the appliance manufacturer as they may cause hazards.
7. **Water and Moisture** – Do not use the appliance near water –for example, near a bath tub, wash bowl, kitchen sink, or laundry tub; in a wet basement; or near a swimming pool; and the like.
8. **Accessories** – Do not place the appliance on an unstable cart, stand, tripod, bracket, or table. The appliance may fall, causing serious injury to a child or adult, and serious damage to the appliance. Use only with a cart, stand, tripod, bracket, or table recommended by the manufacturer, or sold with the appliance. Any mounting of the appliance should follow the manufacturer's instructions, and should use a mounting accessory recommended by the manufacturer.
9. An appliance and cart combination should be moved with care. Quick stops, excessive force, and uneven surfaces may cause the appliance and cart combination to overturn.
10. **Ventilation** – Slots and openings in the cabinet are provided for ventilation and to ensure reliable operation of the appliance and to protect it from overheating, and these openings must not be blocked or covered. The openings should never be blocked by placing the appliance on a bed, sofa, rug, or other similar surface. The appliance should not be placed in a built-in installation such as a bookcase or rack unless proper ventilation is provided. There should be free space of at least 20 cm (8 in.) and an opening behind the appliance.
11. **Power Sources** – The appliance should be operated only from the type of power source indicated on the marking label. If you are not sure of the type of power supply to your home, consult your appliance dealer or local power company.
12. **Grounding or Polarization** – The appliance may be equipped with a polarized alternating current line plug (a plug having one blade wider than the other). This plug will fit into the power outlet only one way. This is a safety feature. If you are unable to insert the plug fully into the outlet, try reversing the plug. If the plug should still fail to fit, contact your electrician to replace your obsolete outlet. Do not defeat the safety purpose of the polarized plug.
13. **Power-Cord Protection** – Power-supply cords should be routed so that they are not likely to be walked on or pinched by items placed upon or against them, paying particular attention to cords at plugs, convenience receptacles, and the point where they exit from the appliance.
14. **Outdoor Antenna Grounding** – If an outside antenna or cable system is connected to the appliance, be sure the antenna or cable system is grounded so as to provide some protection against voltage surges and built-up static charges. Article 810 of the National Electrical Code, ANSI/NFPA 70, provides information with regard to proper grounding of the mast and supporting structure, grounding of the lead-in wire to an antenna-discharge unit, size of grounding conductors, location of antenna-discharge unit, connection to grounding electrodes, and requirements for the grounding electrode. See Figure 1.
15. **Lightning** – For added protection for the appliance during a lightning storm, or when it is left unattended and unused for long periods of time, unplug it from the wall outlet and disconnect the antenna or cable system. This will prevent damage to the appliance due to lightning and power-line surges.
16. **Power Lines** – An outside antenna system should not be located in the vicinity of overhead power lines or other electric light or power circuits, or where it can fall into such power lines or circuits. When installing an outside antenna system, extreme care should be taken to keep from touching such power lines or circuits as contact with them might be fatal.
17. **Overloading** – Do not overload wall outlets, extension cords, or integral convenience receptacles as this can result in a risk of fire or electric shock.
18. **Object and Liquid Entry** – Never push objects of any kind into the appliance through openings as they may touch dangerous voltage points or short-out parts that could result in a fire or electric shock. Never spill liquid of any kind on the appliance.
19. **Servicing** – Do not attempt to service the appliance yourself as opening or removing covers may expose you to dangerous voltage or other hazards. Refer all servicing to qualified service personnel.
20. **Damage Requiring Service** – Unplug the appliance from the wall outlet and refer servicing to qualified service personnel under the following conditions:
  - A. When the power-supply cord or plug is damaged,
  - B. If liquid has been spilled, or objects have fallen into the appliance,
  - C. If the appliance has been exposed to rain or water,
  - D. If the appliance does not operate normally by following the operating instructions. Adjust only those controls that are covered by the operating instructions as an improper adjustment of other controls may result in damage and will often require extensive work by a qualified technician to restore the appliance to its normal operation,
  - E. If the appliance has been dropped or damaged in any way, and
  - F. When the appliance exhibits a distinct change in performance – this indicates a need for service.

PORTABLE CART WARNING



21. **Replacement Parts** – When replacement parts are required, be sure the service technician has used replacement parts specified by the manufacturer or have the same characteristics as the original part. Unauthorized substitutions may result in fire, electric shock, or other hazards.
22. **Safety Check** – Upon completion of any service or repairs to the appliance, ask the service technician to perform safety checks to determine that the appliance is in proper operation condition.
23. **Wall or Ceiling Mounting** – The appliance should be mounted to a wall or ceiling only as recommended by the manufacturer.
24. **Heat** – The appliance should be situated away from heat sources such as radiators, heat registers, stoves, or other appliances (including amplifiers) that produce heat.

## Precautions

### 1. Recording Copyright

Recording of copyrighted material for other than personal use is illegal without permission of the copyright holder.

### 2. AC Fuse

The fuse is located inside the chassis and is not user-serviceable. If power does not come on, contact your Onkyo authorized service station.

### 3. Care

From time to time you should wipe the front and rear panels and the cabinet with a soft cloth. For heavier dirt, dampen a soft cloth in a weak solution of mild detergent and water, wring it out dry, and wipe off the dirt. Following this, dry immediately with a clean cloth. Do not use rough material, thinners, alcohol or other chemical solvents or cloths since these could damage the finish or remove the panel lettering.

### 4. Power

#### WARNING

BEFORE PLUGGING IN THE UNIT FOR THE FIRST TIME, READ THE FOLLOWING SECTION CAREFULLY.

The voltage of the available power supply differs according to country or region. Be sure that the power supply voltage of the area where this unit will be used meets the required voltage (e.g., AC 230 V, 50 Hz or AC 120 V, 60 Hz) written on the rear panel.

Worldwide models are equipped with a voltage selector to conform to local power supplies. Be sure to set this switch to match the voltage of the power supply in your area before plugging in the unit.

#### For British models

Replacement and mounting of an AC plug on the power supply cord of this unit should be performed only by qualified service personnel.

#### IMPORTANT

The wires in the mains lead are coloured in accordance with the following code:

- Blue : Neutral
- Brown : Live

As the colours of the wires in the mains lead of this apparatus may not correspond with the coloured markings identifying the terminals in your plug, proceed as follows:

The wire which is coloured blue must be connected to the terminal which is marked with the letter N or coloured black.

The wire which is coloured brown must be connected to the terminal which is marked with the letter L or coloured red.

#### IMPORTANT

A 5 ampere fuse is fitted in this plug. Should the fuse need to be replaced, please ensure that the replacement fuse has a rating of 5 amperes and that it is approved by ASTA or BSI to BS1362. Check for the ASTA mark or the BSI mark on the body of the fuse.

IF THE FITTED MOULDED PLUG IS UNSUITABLE FOR THE SOCKET OUTLET IN YOUR HOME THEN THE FUSE SHOULD BE REMOVED AND THE PLUG CUT OFF AND DISPOSED OF SAFELY. THERE IS A DANGER OF SEVERE ELECTRICAL SHOCK IF THE CUT OFF PLUG IS INSERTED INTO ANY 13 AMPERE SOCKET.

If in any doubt, consult a qualified electrician.

FIGURE 1:  
EXAMPLE OF ANTENNA GROUNDING AS PER NATIONAL ELECTRICAL CODE, ANS/NFPA 70

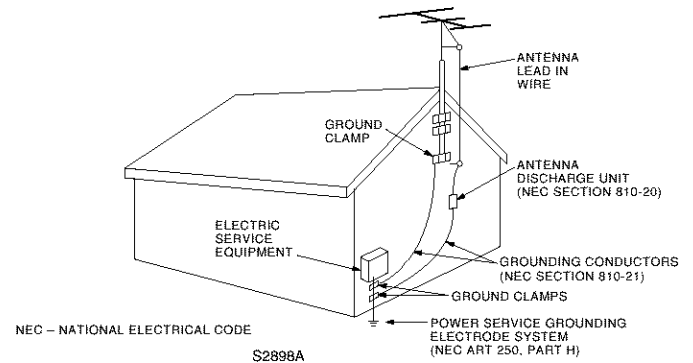

### For U.S. models

#### Note to CATV system installer:

This reminder is provided to call the CATV system installer's attention to Section 820-40 of the NEC which provides guidelines for proper grounding and, in particular, specifies that the cable ground shall be connected to the grounding system of the building, as close to the point of cable entry as practical.

### FCC Information for User

#### CAUTION:

The user changes or modifications not expressly approved by the party responsible for compliance could void the user's authority to operate the equipment.

#### NOTE:

This equipment has been tested and found to comply with the limits for a Class B digital device, pursuant to Part 15 of the FCC Rules. These limits are designed to provide reasonable protection against harmful interference in a residential installation. This equipment generates, uses and can radiate radio frequency energy and, if not installed and used in accordance with the instructions, may cause harmful interference to radio communications. However, there is no guarantee that interference will not occur in a particular installation. If this equipment does cause harmful interference to radio or television reception, which can be determined by turning the equipment off and on, the user is encouraged to try to correct the interference by one or more of the following measures:

- Reorient or relocate the receiving antenna.
- Increase the separation between the equipment and receiver.
- Connect the equipment into an outlet on a circuit different from that to which the receiver is connected.
- Consult the dealer or an experienced radio/TV technician for help.

### For Canadian models

**NOTE:** THIS CLASS B DIGITAL APPARATUS COMPLIES WITH CANADIAN ICES-003.

For models having a power cord with a polarized plug:

**CAUTION:** TO PREVENT ELECTRIC SHOCK, MATCH WIDE BLADE OF PLUG TO WIDE SLOT, FULLY INSERT.

### Modèle pour les Canadien

**REMARQUE:** CET APPAREIL NUMÉRIQUE DE LA CLASSE B EST CON-FORME À LA NORME NMB-003 DU CANADA.

Sur les modèles dont la fiche est polarisée:

**ATTENTION:** POUR ÉVITER LES CHOCS ÉLECTRIQUES, INTRODUIRE LA LAME LA PLUS LARGE DE LA FICHE DANS LA BORNE CORRESPONDANTE DE LA PRISE ET POUSSER JUSQU'AU FOND.



# Contents

<b>Enjoying music or videos with the TX-DS797 ...</b>	<b>50</b>
Basic operation .....	50
Temporarily turning off the sound .....	50
Adjusting the bass and treble .....	50
Listening with headphones .....	50
Changing the listening mode .....	51
Entering names for input sources and tuner stations .....	51
Switching the display .....	52
Adjusting the brightness of the front display .....	52
Using the sleep time (remote controller only) .....	52
Temporarily changing the speaker output levels .....	52
Changing the audio mode .....	53
Enjoying the multichannel output .....	53
<b>Enjoying music in the remote zone .....</b>	<b>54</b>
Playing music using the buttons on the TX-DS797 .....	54
Selecting an input source using the remote controller ..	54
<b>Recording a source .....</b>	<b>55</b>
To record the input source signal	
you are currently watching or listening to .....	55
To record an input source signal different from	
that you are currently watching or listening to .....	55

## Remote controller

<b>Using remote controller .....</b>	<b>56</b>
<b>Overview .....</b>	<b>56</b>
Calling up a preset radio station .....	56
Controlling an Onkyo cassette tape deck .....	56
Controlling an Onkyo CD player .....	57
Controlling an Onkyo DVD player .....	58
Controlling an Onkyo MD recorder .....	59
SAT, CABLE, VCR, and TV MODE buttons .....	59
<b>Learning a pre-programming code .....</b>	<b>60</b>
Learning a pre-programming code .....	60
Pre-programming codes .....	61
<b>Operating your programmed remote controller .....</b>	<b>62</b>
DVD MODE (DVD Player Mode) .....	62
SAT MODE (Satellite Tuner Mode) .....	62
CABLE MODE (Cable Mode) .....	62
VCR MODE (VCR Mode) .....	63
TV MODE (TV Mode) .....	63

<b>Programming the commands of remote controllers for other devices into the remote controller .....</b>	<b>64</b>
Programming procedure .....	64
Erasing the programmed command from one button ....	66
Erasing all the commands programmed	
under a MODE button .....	66
<b>Using a Macro function .....</b>	<b>67</b>
<b>What is a Macro function? .....</b>	<b>67</b>
Programming a Macro function .....	67
Running a Macro function .....	67
Programming the Direct Macro function .....	68
Running a Direct Macro function .....	68
Erasing a macro from the MODE MACRO button .....	69
Erasing a direct macro from the DIRECT MACRO button .....	69
Erasing all commands and macros	
that have been programmed .....	70
(Macro mode programming memo .....	70)

## Appendix

<b>Specifications .....</b>	<b>71</b>
<b>Troubleshooting guide .....</b>	<b>72</b>
POWER .....	72
SPEAKERS .....	72
FM/AM TUNER .....	72
VIDEO and AUDIO .....	73
REMOTE CONTROLLER .....	73
OTHER .....	73
If one of the messages shown below appears .....	73

### Declaration of Conformity

We, ONKYO EUROPE  
ELECTRONICS GmbH  
INDUSTRIESTRASSE 20  
82110 GERMERING,  
GERMANY



declare in own responsibility, that the ONKYO product described in this instruction manual is in compliance with the corresponding technical standards such as EN60065, EN55013, EN55020 and EN61000-3-2, -3-3.

GERMERING, GERMANY

I. MORI

ONKYO EUROPE ELECTRONICS GmbH

# Features

## Amplifier Features

- 100 W×2 (Front)/100 W (Center)/100 W×2 (Surround)/100 W (Surround Back) at 8 Ω, 20Hz-20kHz, 0.08% THD (FTC)
- 135 W×2 (Front)/135 W (Center)/135 W×2 (Surround)/135 W (Surround Back) at 6 Ω (DIN)
- 160 W×2 (Front)/160 W (Center)/160 W×2 (Surround)/160 W (Surround Back) at 6 Ω (EIAJ)
- 6 Channel Amplifier
- Wide Range Amplifier Technology (WRAT)
- Linear Optimum Gain Volume Circuitry
- 192 kHz/24 Bit D/A Converters (except for Surround Back L/R)
- Ready for HDTV, Progressive-Scan DVD and DVD-Audio
- Zone-2 Capability

## Audio/Video Features

- THX® Surround EX®
- THX Select Certified
- Dolby® Digital, Dolby Pro Logic II
- DTS, DTS-ES Discrete 6.1, DTS-ES Matrix 6.1 and DTS Neo:6
- Theater-Dimensional™ Virtual Surround Mode
- Non-Scaling Configuration
- Onscreen displays (Basic menu/Advanced menu)
- 2 Wideband Component-Video Inputs/1 Output
- Composite to S-Video Conversion
- 6 S-Video Inputs/3 Outputs
- 6 Assignable Digital Inputs (3 optical/3 coaxial), 1 outputs, and 1 Digital Input (optical)

- Pre Out Terminals for Front L/R, Center, Surround L/R, Surround back L/R and Subwoofer

## FM/AM Tuner Features

- 40 FM/AM random presets
- FM auto tuning
- RDS (European models only) with PS, PTY, RT, TP

## Other Performance Features

- IntelliVolume
- Character Input
- Powerful backlit/preprogrammed learning remote with macro and mode-key LEDs

\* Manufactured under license from Dolby Laboratories.

"Dolby," "Pro Logic," "Surround EX" and the double-D symbol are trademarks of Dolby Laboratories.

- "Theater-Dimensional" is a trademark of Onkyo Corporation.
- Lucasfilm and THX are trademarks of Lucasfilm Ltd. All rights reserved. Used under authorization.
- Re-Equalization and the "Re-EQ" logo are trademarks of Lucasfilm Ltd. Manufactured under license of Lucasfilm Ltd.
- "DTS," "DTS-ES Extended Surround" and "Neo:6" are trademarks of Digital Theater Systems, Inc.
- Xantech is a registered trademark of Xantech Corporation.
- Niles is a registered trademark of Niles Audio Corporation.

### THX Select

Before any home theatre component can be THX Select certified, it must pass a rigorous series of quality and performance tests. Only then can a product feature the THX Select logo, which is your guarantee that the Home Theatre products you purchase will give you superb performance for many years to come. THX Select requirements define hundreds of parameters, including power amplifier performance, and pre-amplifier performance and operation for both digital and analog domains. THX Select receivers also feature proprietary THX technologies (e.g., THX Mode, see page 39) which accurately translate film soundtracks for home theater playback.

# Supplied accessories

Check that the following accessories are supplied with the TX-DS797.

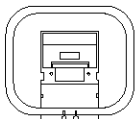

AM loop antenna × 1

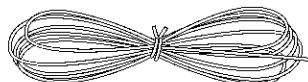

FM indoor antenna × 1

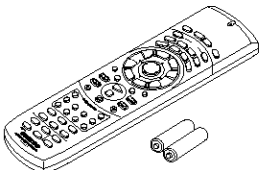

Remote controller × 1  
Batteries (AA, R6 or UM-3) × 2

The following accessories may be available depending on the area which it was purchased.

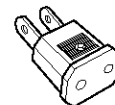

Conversion plug × 1

(Use this plug if the power cord plug of the TX-DS797 does not fit your AC outlet. Shape may vary depending on the area which it was purchased.)

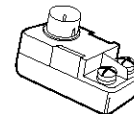

75/300 Ω antenna adapter × 1  
(For all models other than USA, Canadian and European models)

# Before using this unit

## Setting the Voltage selector (Worldwide models only)

Worldwide models are equipped with a voltage selector to conform with local power supplies. Be sure to set this switch to match the voltage of the power supply in your area before plugging in the unit. Determine the proper voltage for your area: 220-230 V or 120 V. If the preset voltage is not correct for your area, insert a screwdriver into the groove in the switch. Slide the switch all the way to the upper (120 V) or to the lower (220-230 V), whichever is appropriate.

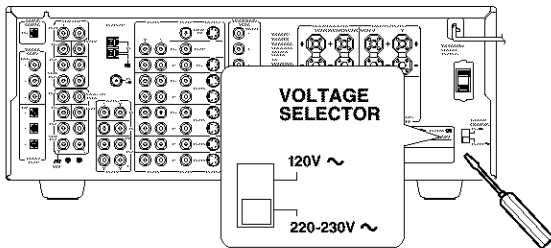

## Installing the remote controller batteries

1. Remove the battery compartment cover by pressing and sliding the cover.
2. Insert two AA (R6 or UM-3) batteries into the battery compartment. Carefully follow the polarity diagram (positive (+) and negative (-) symbols) inside the battery compartment.
3. After batteries are installed and seated correctly, replace the compartment cover.

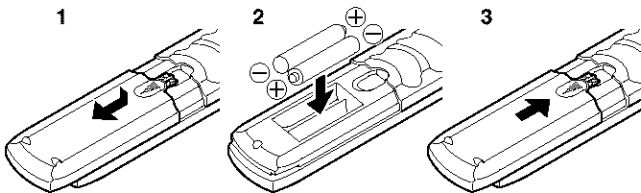

### Notes:

- Do not mix new batteries with old batteries or different kinds of batteries.
- To avoid corrosion, remove the batteries if the remote controller is not to be used for a long time.
- Remove dead batteries immediately to avoid damage from corrosion. If the remote controller does not operate smoothly, replace both the batteries at the same time.

## Using the remote controller

Point the remote controller toward the remote control sensor. The STANDBY indicator lights up when the unit receives a signal from the remote controller.

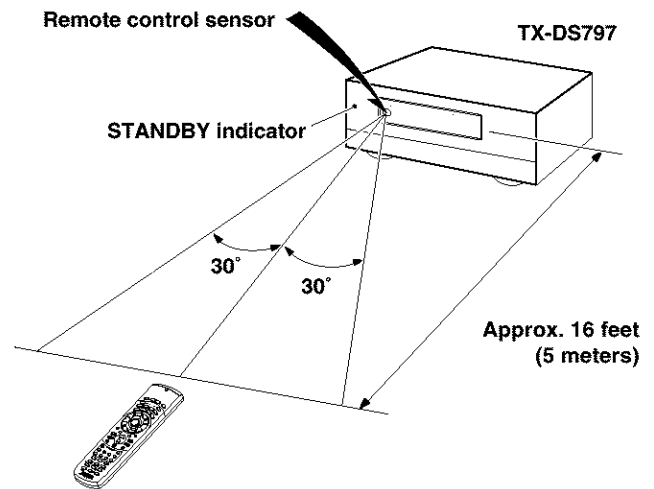

### Notes:

- Place the unit away from strong light such as direct sunlight or inverted fluorescent light which can prevent proper operation of the remote controller.
- Using another remote controller of the same type in the same room or using the unit near equipment which uses infrared rays may cause operational interference.
- Do not put objects on the remote controller. Its buttons may be pressed by mistake and drain the batteries.
- Make sure the audio rack doors do not have colored glass. Placing the unit behind such doors may prevent proper remote controller operation.
- If there is any obstacle between the remote controller and the remote control sensor, the remote controller will not operate.

# Front panel facilities

Here is an explanation of the controls and displays on the front panel of the TX-DS797.

## Front panel

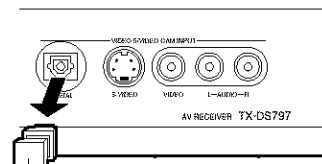
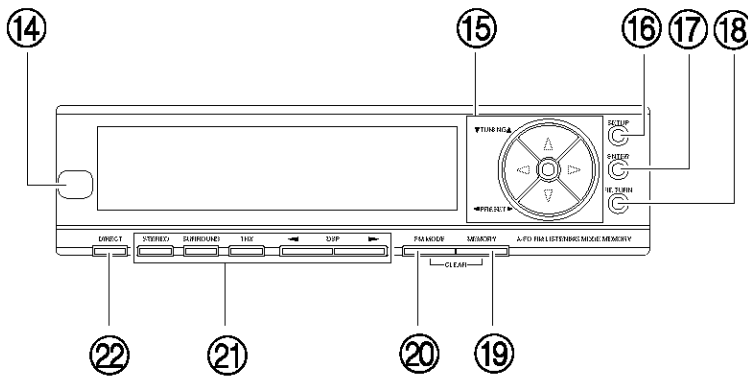
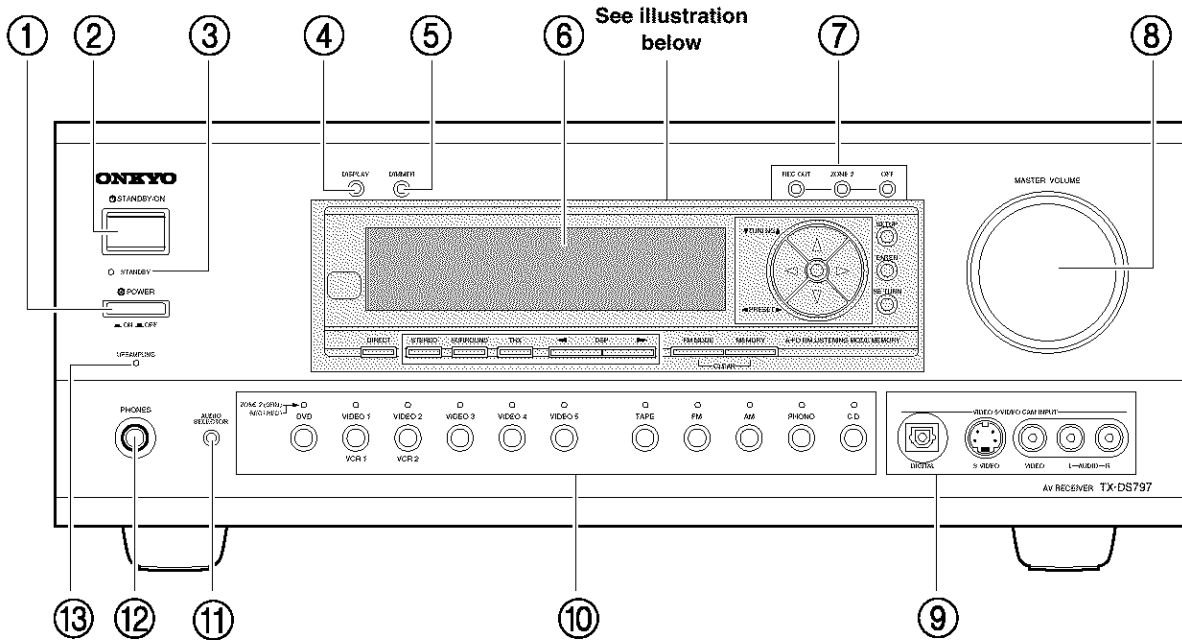

### Protective cap

The VIDEO 5 INPUT jack is equipped with a protective cap. When using this jack, remove the protective cap and keep it safely. When not using this jack, replace the protective cap.

## Front panel display

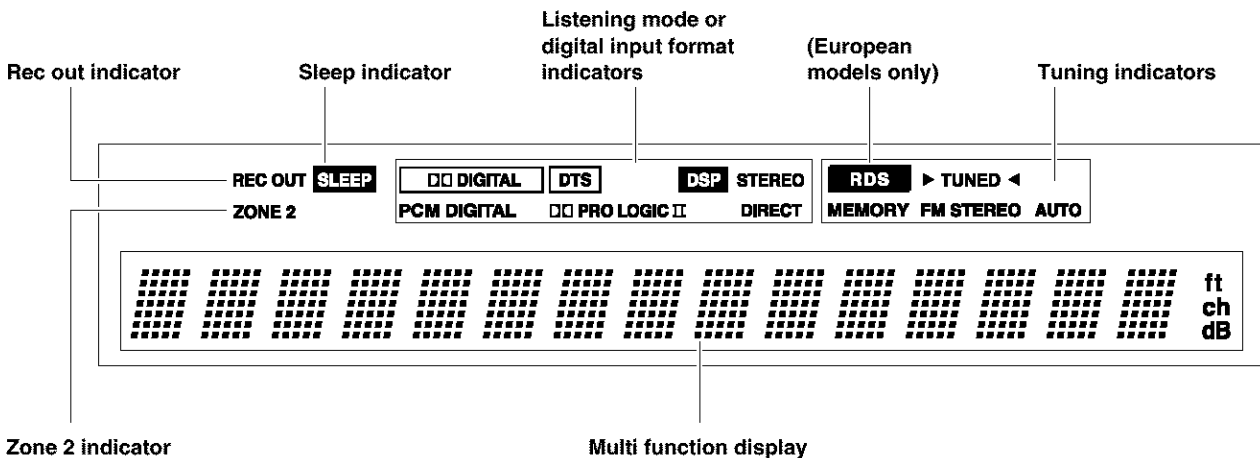



# Front panel facilities

For operational instructions, see page indicated in brackets [ ].

## ① POWER switch [23]

Turns on and off the main power supply for the TX-DS797.

## ② STANDBY/ON button [23]

When this button is pressed with the main power switch turned on, the TX-DS797 turns on and the display lights up. Press again to return the TX-DS797 to the standby state.

## ③ STANDBY indicator [7, 23]

Lights when the TX-DS797 is in the standby state and flashes when a signal is received from the remote controller.

## ④ DISPLAY button [52]

The DISPLAY button is used to display information about the current input source signal. Each time you press the display button, the screen changes to show you different information concerning the input signal.

## ⑤ RT/PTY/TP (European models only) button [49]

This button is only available on European models. Use this button to help tune into the Radio Data System (RDS) for FM broadcasting. RDS was developed within the European Broadcasting Union (EBU) and is available in most European countries. Each time the button is pressed, the display changes from RT (radio text) to PTY (program type) to TP (traffic program) and then back to RT again.

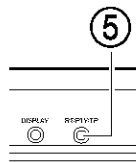

## ⑤ DIMMER button [52]

Press to set the brightness of the front display. There are 3 settings available: normal, dark, and very dark.

- The dimmer control for the front display can be performed at the remote controller.

## ⑥ Front display

## ⑦ REC OUT/ZONE 2/OFF buttons [54, 55]

These buttons allow you to use the TX-DS797 to output to a remote zone (Zone 2) or to another component for recording purposes (Rec Out). Press the REC OUT button to output the audio and video signals to a recording component for recording purposes. Press the ZONE 2 button to enjoy the output from the TX-DS797 in a different room, which is referred to as a remote zone (Zone 2).

When either button is pressed, the currently selected input source for recording or outputting to the remote zone is displayed in the front panel display. If "SOURCE" is displayed, then the same input source as that selected for the main zone will be output.

To select an input source, press the desired button (REC OUT or ZONE 2) and then press one of the input source button within 5 seconds. That source will be output for recording or viewing in the remote zone.

To set the REC OUT or ZONE 2 output to the source channel, press that button twice in succession. To turn off the REC OUT or ZONE 2 output, press that button and then press the OFF button within 5 seconds.

### Note:

The Rec Out and Zone 2 buttons use the same circuit and therefore cannot be used at the same time. When Rec Out is selected, nothing is output to Zone 2, and vice versa. When ZONE 2 is selected, REC OUT is automatically fixed to SOURCE.

## ⑧ MASTER VOLUME dial [50, 53]

The MASTER VOLUME dial is used to control the volume for the main zone. The volume for the remote zone (Zone 2) is independent.

## ⑨ VIDEO 5/VIDEO CAM INPUT terminals [18]

For connecting a video camera or game device.

## ⑩ Input source buttons (DVD, VIDEO 1–5, TAPE, FM, AM, PHONO, and CD) [23, 46, 50, 55]

These buttons are used to select the input source for the main zone. To select the input source for the remote zone (Zone 2) or recording out (Rec Out), first press the ZONE 2 or REC OUT button, and then the desired input source button. The input channel with its indicator lit red is output to REC OUT and the one with its indicator lit green is output to ZONE 2.

## ⑪ AUDIO SELECTOR button [53]

This button is used to select the type of audio input signal. Each time pressed, the setting cycles from "Auto" → "Multich" → "Analog" and back. When multichannel is not selected, the setting just changes back and forth between "Auto" and "Analog."

## ⑫ PHONES jack [50]

This is a standard stereo jack for connecting stereo headphones.

## ⑬ UPSAMPLING indicator [40]

Lights during upsampling. This function is available when the input source is Analog/PCM and the listening mode is set to the stereo or surround (Dolby Pro Logic II only) mode.

## ⑭ Remote control sensor [7]

## ⑮ TUNING ▲/▼, PRESET ◀▶, cursor (◀▶/▲/▼) buttons [27, 46, 47]

To tune in a radio station, use the ▲/▼ buttons. The tuner frequency is displayed in the front display and it can be changed in 50 kHz increments for FM and 10 kHz increments for AM.

When FM is selected, you can hold down one of the tuning buttons and then release it to activate the auto-search feature. It will search for a station in the direction of the button you pressed and stop when it tunes into one. When navigating through the menu settings, these buttons move the cursor up or down (or change the highlighted item).

To select a radio station that was stored using the MEMORY button, use the ◀▶ buttons.

When navigating through the menu settings, these buttons select the value or item that you selected with the TUNING ▲/▼ buttons.

When you press the SETUP button, the cursor indicators light and the SETUP button becomes able to be used for setup menu operations.

## ⑯ SETUP button [27]

Press to enter the setup menu. When pressed, the cursor (◀▶/▲/▼) indicators light. The OSD menu will appear on the TV monitor as well as the front display on the TX-DS797.

## ⑰ ENTER button [27]

Press to display the screen for the selected item in the Setup Menu.

## Front panel facilities

### 18 RETURN button [27]

Press to exit the Main menu level or go back one level up.

### 19 MEMORY button [47]

This button is used to assign the radio station that is currently tuned in to a preset channel or delete a previously preset station.

### 20 FM MODE button [46]

If you are listening to an FM radio station in stereo and the sound cuts out or there is a great deal of noise, switch from STEREO to MONO. Each time this button is pressed, the AUTO indication turns on and off, and the stereo mode changes from AUTO to MONO and vice versa.

### 21 LISTENING MODE buttons [51]

Press these buttons to select a listening mode for the current input source.

**STEREO:** Selects for normal stereo output.

**SURROUND:** Selects for the Dolby Pro Logic, Neo:6, Dolby Digital, or DTS listening modes.

**THX:** Selects for the THX listening mode.

**DSP** ◀▶: Switches to the listening mode before or after the current one.

### 22 DIRECT button [51]

The direct mode outputs the sound without sound adjustment or filtration. In the direct mode, even if the Subwoofer setting of the Speaker Config sub-menu is set to "Yes," no sound is output from the subwoofer and the left and right channels are output, as is, to the left and right speakers. Even for multichannel input signals, the sounds are not passed through the sound adjustment circuits.

## Remote controller

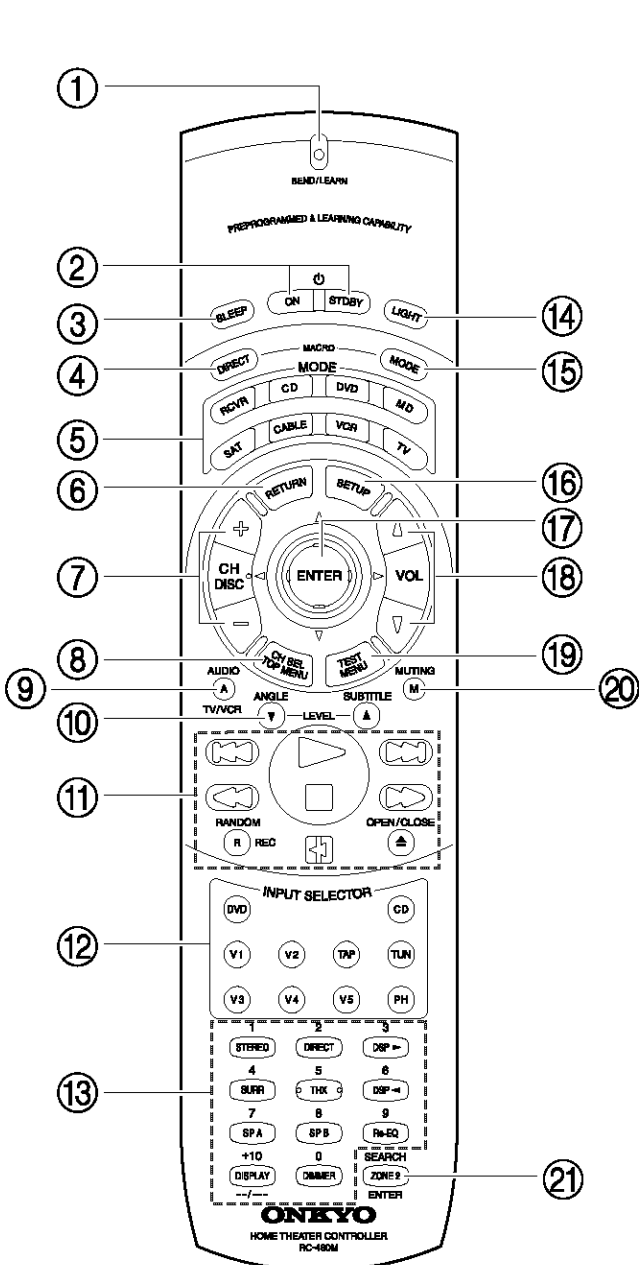

### 1 SEND/LEARN indicator

This indicator acts as a guide when commands are programmed into or sent by the remote controller. It also warns the user when an error is made or battery power is low.

### 2 ON/STDBY button [23]

**ON:** Turns on the TX-DS797.

**STDBY:** Places the TX-DS797 in the standby state.

Be aware that pressing the STDBY button only places the TX-DS797 in standby and does not turn the power completely off.

### 3 SLEEP button [52]

Sets the sleep function.

The SLEEP button enables you to set the TX-DS797 to turn off automatically after a specified time period.

### 4 DIRECT MACRO button [68]

For executing and programming the Direct Macro function.

### 5 MODE buttons and indicators [56-59, 62-69]

For selecting the component to be operated by the remote controller. When a MODE button is pressed, it will light green for 8 seconds. The selected MODE button will also light whenever any other operation button is pressed to tell you which mode the remote controller is in.

### 6 RETURN button [27]

For entering the selected setting and returning to the previous menu.

### 7 CH +/-, DISC + button [47, 56-58, 62, 63]

When in the RCVR mode, for selecting a tuner preset channel.

For selecting the disc to be played back for components with disc changers when in the DVD or CD modes.

### 8 CH SEL/TOP MENU button

**CH SEL:** For selecting the speaker for level adjustment when in the RCVR mode. Used together with the LEVEL ▲/▼ buttons. [52]

**TOP MENU:** When in the DVD mode, for displaying the menu screen(s) recorded on DVD media. [58]

## Remote controller

### ⑨ AUDIO/TV/VCR button

**AUDIO/A:** For selecting the audio input signal. The setting changes from "Auto" to "Multich" to "Analog" and back each time this button is pressed. [53]

**TV/VCR:** Must be preprogrammed for use in the TV and VCR modes. [63]

### ⑩ LEVEL ▼/ANGLE and LEVEL ▲/SUBTITLE buttons

**LEVEL ▼/▲:** Select the speaker whose volume is to be adjusted using the CH SEL button and adjust the volume using the LEVEL ▲/▼ buttons in the RCVR mode. [52]

**ANGLE:** When in the DVD mode, for selecting a camera angle when a DVD-Video is recorded with multiple angle playback. [58]

**SUBTITLE:** When in the DVD mode, for selecting one of the subtitle languages recorded on a DVD-Video. [58]

### ⑪ CD/TAPE/DVD/MD operation buttons [56-59]

For operating other ONKYO components connected to the TX-DS797 through the **RI** terminals.

### ⑫ INPUT SELECTOR buttons [50]

Selects an input source.

Same as the input selector buttons on front panel of the TX-DS797. The input source for each buttons is given here. DVD: DVD, CD: CD, V1: VIDEO1, V2: VIDEO2, V3: VIDEO3, V4: VIDEO4, V5: VIDEO5, TAP: TAPE, TUN: FM/AM, PH: PHONO.

### ⑬ Numeric key/Listening mode SP A, B/ Re-EQ/DISPLAY/DIMMER buttons

**1 to 9, +10, --/--, 0:** For entering the number of a track. [57-63]

**STEREO, DIRECT, DSP ◀, SURR, THX:** You can select a listening mode. [51]

**SP A, SP B:** Not used with the TX-DS797.

**Re-EQ:** Depending on the listening mode, you can turn the cinema re-equalization function on or off. [40, 43]

**DISPLAY:** For changing the display in the front display. [52]

**DIMMER:** Adjusts the display brightness.

There are three settings available: normal, dark and very dark. [52]

### ⑭ LIGHT button

For illuminating the buttons of the remote controller.

This button is useful when using the remote controller in dark locations. When pressed, the buttons on the remote controller light green.

The button for the mode currently selected lights brighter than the rest.

### ⑮ MODE MACRO button [67]

For executing and programming the Macro function.

### ⑯ SETUP button [27]

For displaying and quitting the Setup menu.

### ⑰ ▲/▼/◀▶, ENTER button [27]

When selecting items in the Setup menu, press the upper and lower portions to select an item, press the right and left portions to select parameter values or modes, and press ENTER to select the item.

### ⑱ VOL ▲/▼ button [50, 53]

For adjusting the volume.

### ⑲ TEST/MENU button

**TEST:** Outputs a test tone for setting speaker levels.

Use this button in conjunction with the LEVEL ▲/▼ and CH SEL buttons to calibrate the speakers levels without entering the Setup menu. When TEST button is pressed, the test noise (pink noise) is output. Use the LEVEL ▲/▼ buttons to increase or decrease the sound level. Use the CH SEL button to change from speaker to speaker. For a more detailed explanation of how to calibrate the speaker levels, see page 31.

**MENU:** When in the DVD mode, this button displays the DVD menu. [58]

### ⑳ MUTING button [50]

Activates the mute function.

### ㉑ ZONE 2/SEARCH/ENTER button

**ZONE 2:** When in the RCVR mode, press this button to perform operations on the remote zone (Zone 2). [54]

**SEARCH:** When in the DVD mode, for finding the specific section on a disc where you want to start playback. [58]

**ENTER:** When in the MD mode, for confirming the selection. [59]

# Rear panel facilities

Here is an explanation of the terminals found on the rear of the TX-DS797 and how they are used. Before connecting your audio and video components, be sure to read this section carefully and then proceed to the explanations on how to connect each individual component (see page 15).

- Be sure to always refer to the instructions that came with the component that you are connecting.
- Do not plug in the power cord until all connections have been made.
- For input jacks, red connectors (marked R) are used for the right channel, white connectors (marked L) are used for the left channel, and yellow connectors (marked V) are used for video connection.

- Insert all plugs and connectors securely. Improper connections can result in noise, poor performance, or damage to the equipment.

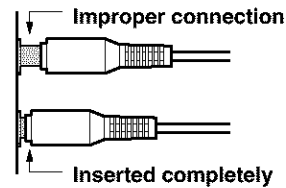

- Do not bind audio/video connection cables with power cords and speaker cables. Doing so may adversely affect the picture and sound quality.

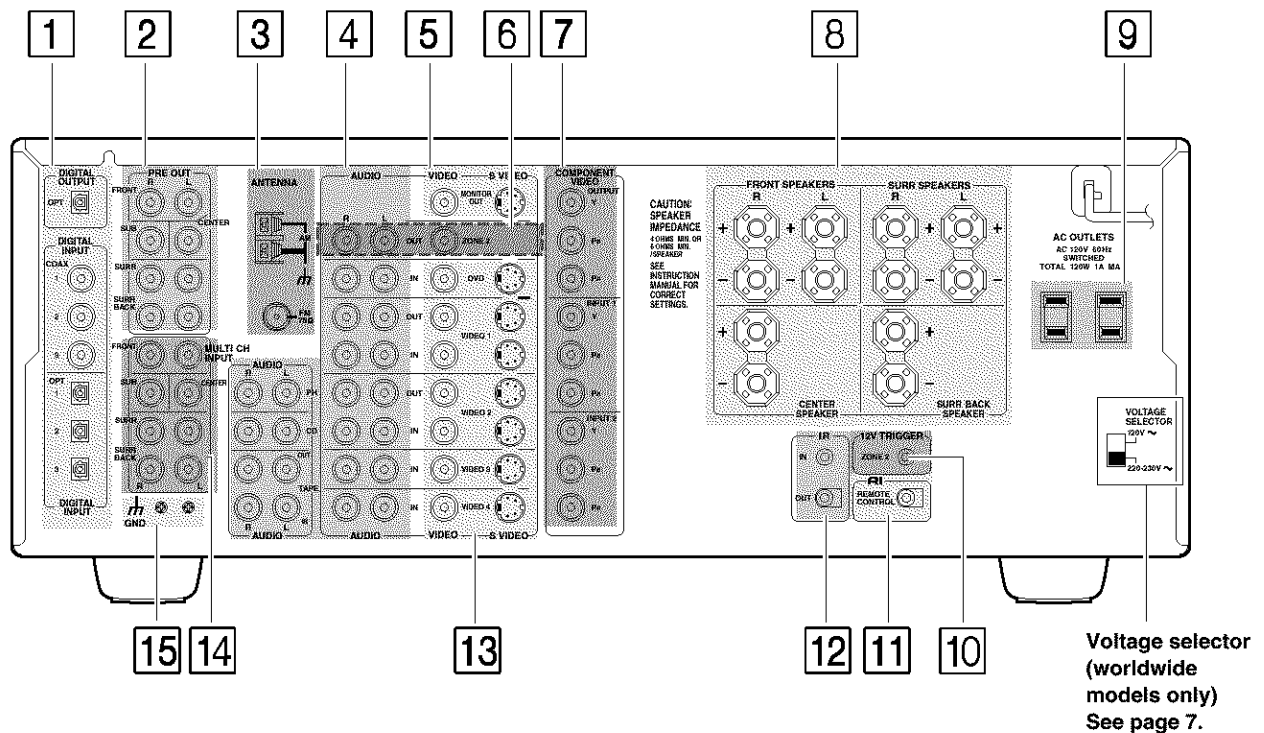

## 1 DIGITAL INPUT/OUTPUT (coaxial and optical)

These are the digital audio inputs and outputs on the rear panel. There are three digital inputs with coaxial jacks and three with optical jacks. The inputs accept digital audio signals from a compact disc, LD, DVD, or other digital source component. For digital output, there is 1 optical output. The digital outputs can be connected to MD recorders, CD recorders, DAT decks, or other similar components.

- Since an analog connection must be made when using REC OUT or ZONE 2, make sure that the connection to the input source is not digital only, but analog as well.
- When using one of the optical input or output jacks, remove the protective cap and keep it safely. When the jack is not used, replace the protective cap.
- When using an optical input or output jack, always use an optical fiber cable.

COAXIAL Coaxial cable

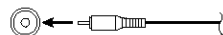

OPTICAL Optical fiber cable

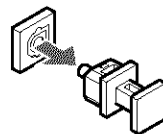
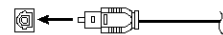

### Optical digital input terminal

An optical digital input terminal is equipped with a protection cap. When connecting, remove this cap. When not using, put the cap back on the terminal.

## Rear panel facilities

### 2 PRE OUT

These jacks are for connecting auxiliary power amplifier. Using auxiliary power amplifiers allows you to listen at louder volumes than with the TX-DS797 alone. If power amplifiers are used, connect each speaker to the corresponding power amplifier.

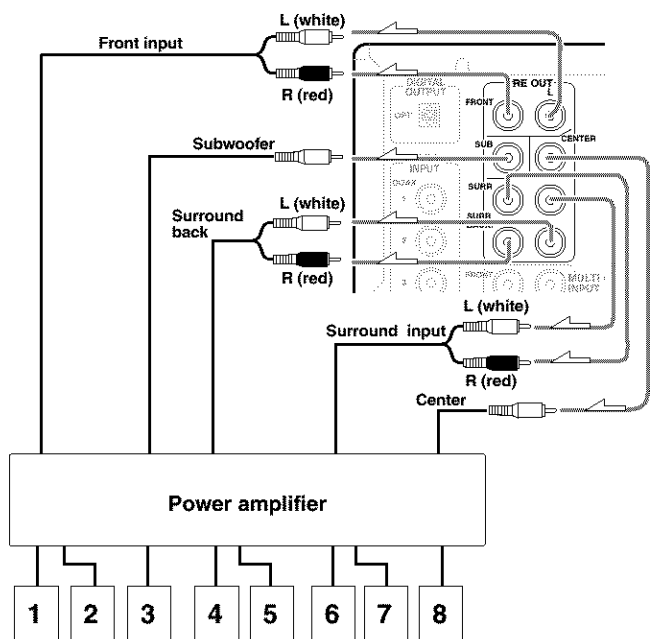

- |                               |                                |
|-------------------------------|--------------------------------|
| 1. Front left speaker         | 5. Surround back right speaker |
| 2. Front right speaker        | 6. Surround left speaker       |
| 3. Subwoofer                  | 7. Surround right speaker      |
| 4. Surround back left speaker | 8. Center speaker              |

### 3 ANTENNA

These jacks are for connecting the FM indoor antenna and AM loop antenna that are supplied with the TX-DS797.

### 4 AUDIO IN/OUT

These are the analog audio inputs and outputs. There are eight audio inputs and 3 audio outputs. The audio inputs and outputs require RCA-type connectors.

- When connecting a VCR or other video component, make sure you connect the audio and video leads together (i.e., both to VIDEO 3).
- The PHONO (PH) input jacks on the TX-DS797 is designed for use with turntables that use moving magnet cartridges.

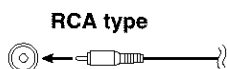

### 5 MONITOR OUT

The monitor output includes both composite video and S video configurations. This output is for connecting television monitors or projectors.

### 6 ZONE 2 AUDIO/VIDEO OUT

Connect the device that will be used in the remote zone (Zone 2). For more information regarding how to make the connections, refer to "Connecting the remote zone (Zone 2) speakers" on page 21.

### 7 COMPONENT VIDEO INPUT/OUTPUT

If your DVD player or other device has component video connectors, be sure to connect them to these component video connectors on the TX-DS797. The TX-DS797 has two component video input connectors to obtain the color information (Y, PB, PR) directly from the recorded DVD signal or other video component and one component video output connector to output it directly into the matrix decoder of the display device. By sending the pure DVD component video signal directly, the DVD signal forgoes the extra processing that normally would degrade the image. The result is vastly increased image quality, with incredibly lifelike colors and crisp detail.

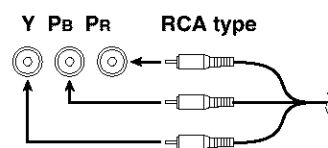

### 8 SPEAKERS

Six terminals are provided for the front left, front right, front center, surround left, surround right, and surround back speakers. Speaker outputs are compatible with banana plug connectors (other than European models).

### 9 AC OUTLETS

The TX-DS797 is supplied with AC mains outlets for connecting the power cords from other devices so that their power is supplied through the TX-DS797. By doing this, you can use the STANDBY/ON button on the TX-DS797 to turn on and off the connected devices as well.

**The shape, number, and total capacity of the AC outlets may differ depending on the area of purchase.**

#### Caution:

Make sure that the total capacity of the other components connected to this unit does not exceed the capacity that is printed on the rear panel (e.g., 120 watts).

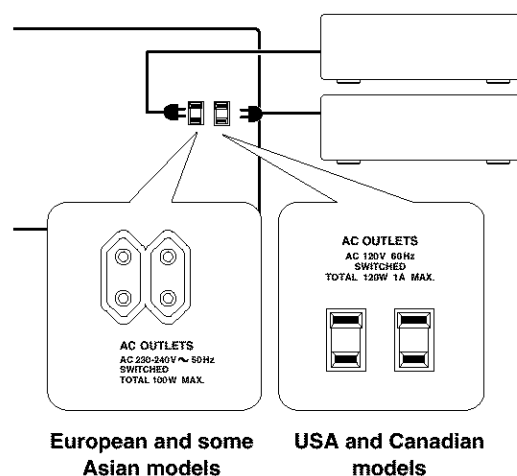

### 10 12V TRIGGER ZONE 2 terminal

When the TX-DS797 is in the ZONE 2 mode, this terminal outputs at 12 V/100 mA.

## Rear panel facilities

### 11 RI REMOTE CONTROL

The **RI** terminal on the TX-DS797 is for connecting other Onkyo components equipped with the same **RI** terminal. When a component is **RI**-connected, you can point the remote controller supplied with the TX-DS797 at the sensor on the TX-DS797 and operate that component without having to switch remote controllers. In addition, by connecting components to the **RI** terminal, you can also perform the system operations given below.

#### Power on/ready function

When the TX-DS797 is in the standby state, if an **RI**-connected component is turned on, then the TX-DS797 also turns on and the input source selected at the TX-DS797 automatically switches to that component.

If the power cord for an **RI**-connected component is connected to the AC OUTLET on the TX-DS797, or if the TX-DS797 is turned on, this function will not work.

#### Direct change function

When the play button is pressed at an **RI**-connected component, the input source selected at the TX-DS797 automatically changes to that component.

#### Power off function

When the TX-DS797 is placed in the standby state, all **RI**-connected components are also automatically put into the standby state.

#### CAUTION

If an MD recorder is connected to the TAPE jack on the TX-DS797, switch the Input Selector from TAPE to MD (see page 23).

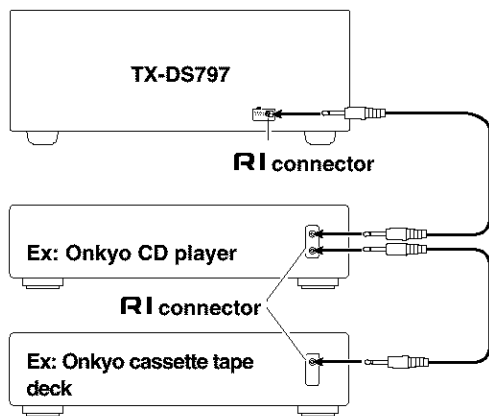

To connect components using the **RI** terminal, simply connect a remote control cable from this **RI** terminal to the **RI** terminal of the other component. An **RI** remote control cable with a 1/8-inch (3.5-mm) miniature two-conductor plug comes with every cassette tape deck, compact disc player, MD recorder, and DVD player that has an **RI** terminal.

- When performing operations with **RI**-connected components using the **RI** system, do not use the remote zone (Zone 2).
- For remote control operation, the audio connection cables must also be connected.
- If a component has two **RI** terminals, you can use either one to connect to the TX-DS797. The other one can be used to daisy chain with another component.
- With Onkyo DVD players, you can enter the pre-program code so that you can operate the DVD player directly with the remote controller without connecting the **RI** terminals (see page 61).

### 12 IR IN/OUT

If the TX-DS797 is located inside a rack or cabinet that will not allow infrared beams to reach the IR sensor, you will need to connect a remote sensor to IR IN input to be able to use the remote controller. Then install the remote sensor in an unblocked location where you can easily point the remote controller.

Using a mini-jack connector, connect the IR emitter to the IR OUT terminal on the TX-DS797 and then place the IR emitter on the remote sensor of the component or facing it.

### 13 VIDEO IN/OUT

These are the video inputs and outputs. On the rear panel, there are five video inputs and two video outputs and each one includes both composite video and S video configurations. Connect VCRs, LD players, DVD players, and other video components to the video inputs.

The two video output channels can be used to be connected to video tape recorders for making recordings.

- When connecting a VCR or other video component, make sure you connect the audio and video leads together (i.e., both to VIDEO 3).
- The VIDEO 5 inputs are located on the front panel.

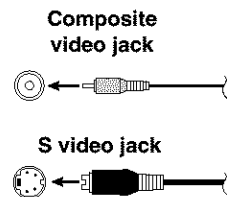

### 14 MULTI CHANNEL INPUT

By connecting a DVD player, MPEG decoder, or other component that has a multi channel port, you can playback the audio with 5.1-channel or 7.1-channel output. So be sure to prepare a cable that can properly connect the TX-DS797 to the peripheral device. The signal input from SURR BACK R is output to the SURR BACK SPEAKER terminal.

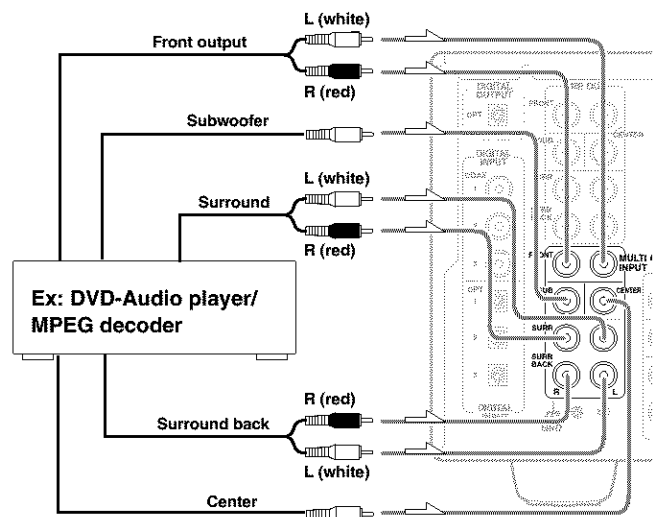

### 15 GND

Use this GND terminal for connecting the ground (or earth) wire if a turntable is connected. Refer to "Connecting a turntable" on page 15.

# Connections

Here is an explanation of how to connect the main components to the TX-DS797 in the standard manner. There are many ways that any one component can be connected, and it is up to you to decide which method best fits your situation. The directions given here are only one option and should only be thought of as such. It is best to fully understand the nature of each connector and terminal as well as each of your components and their features to ascertain which method of connection is best.

 : Signal flow

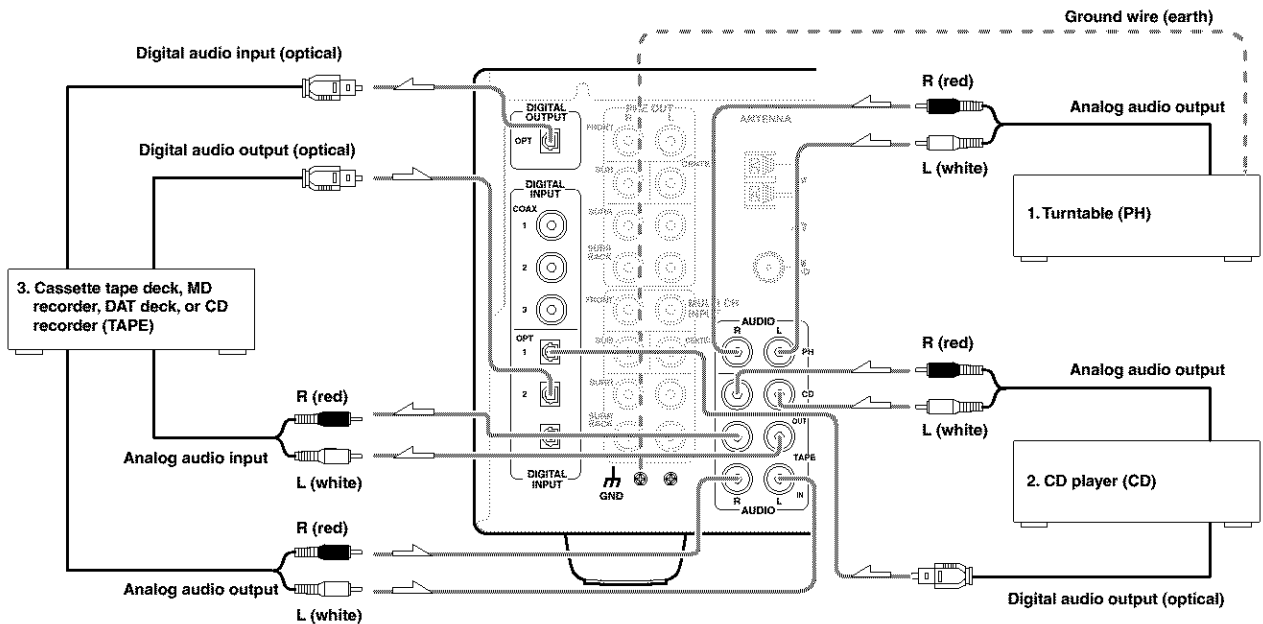
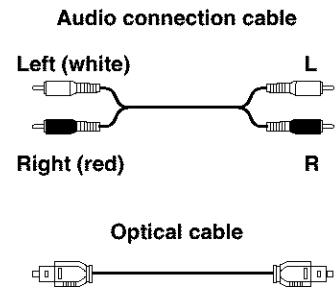

## Connecting your audio components

Below is an example of how you can connect your audio components to the TX-DS797. Refer to the diagram above for the following connection examples.

### 1. Connecting a turntable (PH)

Using an RCA-type audio connection cable, connect the output terminal on the turntable to the PH input jacks on the TX-DS797. Make sure that you properly connect the left channel to the L jack and the right channel to the R jack.

#### Note:

The TX-DS797 is designed for use with moving magnet cartridges. For proper operation, connect a ground (or earth) wire to the GND terminal. For some turntables, however, connecting the ground wire may cause increased noise, and in such a case, a ground wire is not necessary and should not be connected.

### 2. Connecting a compact disc player (CD)

Using an RCA-type audio connection cable, connect the output terminal on the compact disc player to the CD input jacks on the TX-DS797. Make sure that you properly connect the left channel to the L jack and the right channel to the R jack.

If the compact disc player has a digital output jack as well, be sure to also connect it to either a DIGITAL INPUT (COAX) or DIGITAL INPUT (OPT) jack on the TX-DS797 depending on the type of connector on the compact disc player.

With the initial settings of the TX-DS797, the CD input source is set for digital input at the OPT 1 jack.

If the digital connection is made at a different jack, this must be changed at the Setup menu: Input Setup → Digital Setup (see page 33).

### 3. Connecting a cassette tape deck, MD recorder, DAT deck, or CD recorder (TAPE)

Using an RCA-type audio connection cable, connect the output terminals (PLAY) of the device to the TAPE IN jacks on the TX-DS797 and the input terminals (REC) to the TAPE OUT jacks. Make sure that you properly connect the left channel to the L jack and the right channel to the R jack.

If the device has a digital output jack as well, be sure to also connect it to either a DIGITAL INPUT (COAX) or DIGITAL INPUT (OPT) jack on the TX-DS797 depending on the type of connector on the device.

With the initial settings of the TX-DS797, the TAPE input source is set for digital input at the OPT 2 jack.

If the digital connection is made at a different jack, this must be changed at the Setup menu: Input Setup → Digital Setup (see page 33).

#### Note:

The output from the DIGITAL OUTPUT jack of the TX-DS797 is only the digital signal input to the DIGITAL INPUT jack.

# Connections

↗ : Signal flow

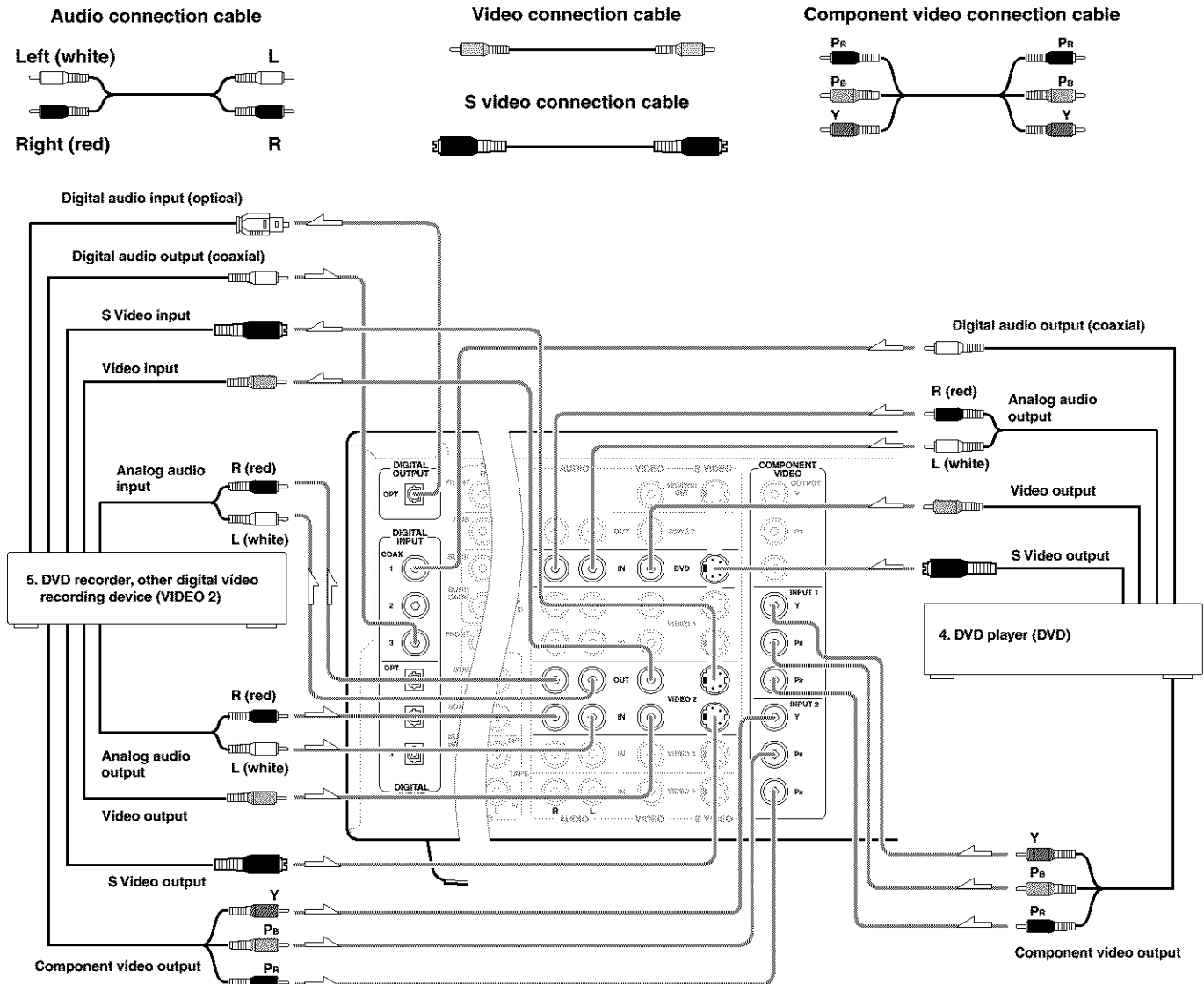

## Connecting your video components

Below is an example of how you can connect your video components to the TX-DS797. Refer to the diagram above for the following connection examples.

### The flow of the video signals is as follows:

- The signal that comes in from VIDEO IN is sent to VIDEO OUT and S VIDEO OUT.
- The signal that comes in from S VIDEO IN is sent to S VIDEO OUT and VIDEO OUT.
- The signal that comes in from COMPONENT VIDEO INPUT is only sent to COMPONENT VIDEO OUTPUT. When connecting a video player to the COMPONENT VIDEO INPUT terminals, be sure to connect your television to the COMPONENT VIDEO OUTPUT terminals.

### Note:

If only the video connection for the MONITOR OUT is made, even if the input from each source component is through a component video connection, the picture will not appear. If only the S video connection for the MONITOR OUT is made, the picture will not appear.

## 4. Connecting a DVD player (DVD)

If the device is equipped with an S video output terminal, connect it to the DVD S VIDEO IN terminal with an S video cable. If it does not have an S video output terminal, connect its video output terminal to the DVD VIDEO IN terminal using an RCA-type video connection cable. You do not need to connect to both the DVD S VIDEO IN and DVD VIDEO IN terminals. If the device has component video outputs, connect them to one of the COMPONENT VIDEO INPUT jacks.

**With the initial settings of the TX-DS797, the DVD input source is set for the COMPONENT VIDEO INPUT 1 jack.**

If the video connection is made at COMPONENT VIDEO INPUT 2, this must be changed at the Setup menu: Input Setup → Video Setup → Component Video (see page 35).

Using an RCA-type audio connection cable, connect the audio output terminal on the device to the audio DVD IN jacks on the TX-DS797. Make sure that you properly connect the left channel to the L jack and the right channel to the R jack.

If the device has a digital output jack as well, be sure to also connect it to either a DIGITAL INPUT (COAX) or DIGITAL INPUT (OPT) jack on the TX-DS797 depending on the type of connector on the DVD player.



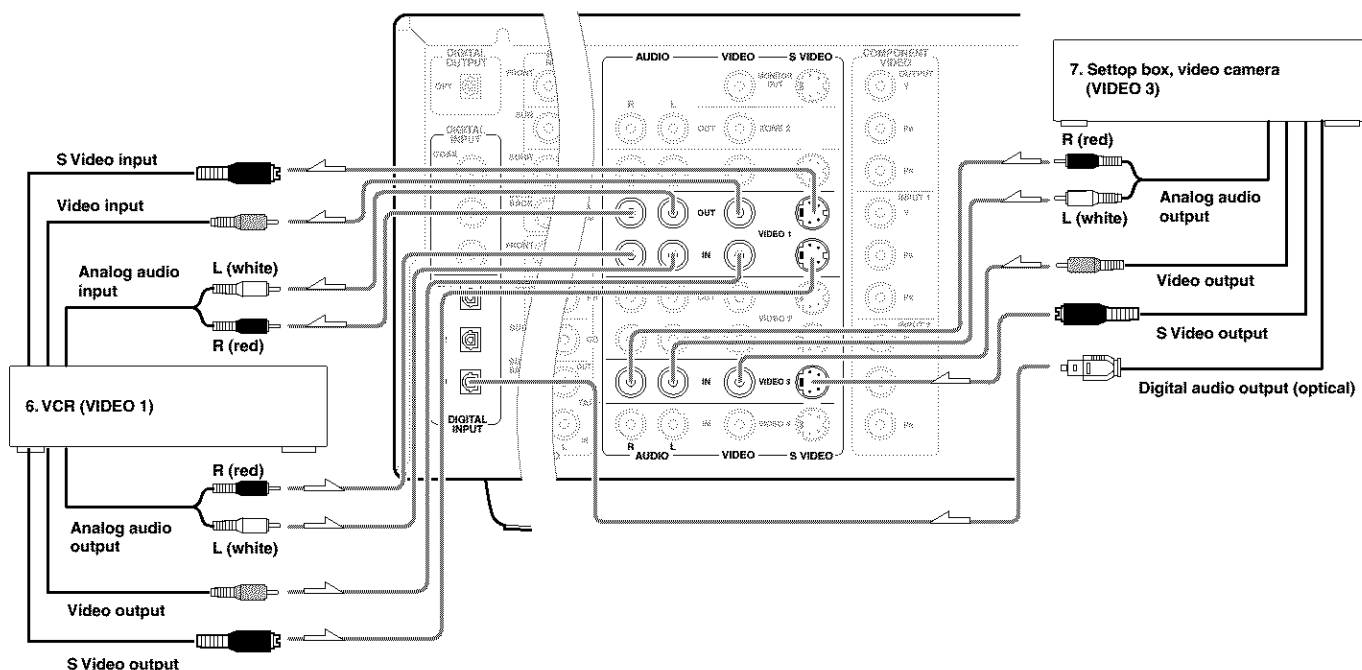

With the initial settings of the TX-DS797, the DVD input source is set for digital input at the COAX 1 jack.

If the digital connection is made at a different jack, this must be changed at the Setup menu: Input Setup → Digital Setup (see page 33).

## 5. Connecting a DVD recorder or other digital video recording device (VIDEO 2)

Using an RCA-type video connection cable, connect the video output terminal (composite) on the device to the VIDEO 2 IN jacks on the TX-DS797 and video input terminal to the VIDEO 2 OUT jacks. If there is an S video input/output terminal on the device, connect it to the S VIDEO 2 IN/OUT jack using an S video cable. You do not need to connect to both the S VIDEO 2 IN and VIDEO 2 IN terminals. If the device has component video outputs, connect them to one of the COMPONENT VIDEO INPUT jacks.

With the initial settings of the TX-DS797, the VIDEO 2 input source is set for the COMPONENT VIDEO INPUT 2 jack.

If the video connection is made at COMPONENT VIDEO INPUT 1, this must be changed at the Setup menu: Input Setup → Video Setup → Component Video (see page 35).

Using an RCA-type audio connection cable, connect the audio output terminal on the device to the same VIDEO 2 IN audio jacks on the TX-DS797 and audio input terminal to the VIDEO 2 OUT audio jacks. Make sure that you properly connect the left channel to the L jack and the right channel to the R jack.

If the device has a digital output jack as well, be sure to also connect it to either a DIGITAL INPUT (COAX) or DIGITAL INPUT (OPT) jack on the TX-DS797 depending on the type of connector on the device.

With the initial settings of the TX-DS797, the VIDEO 2 input source is set for digital input at the COAXIAL 3 jack.

If the digital connection is made at a different jack, this must be changed at the Setup menu: Input Setup → Digital Setup (see page 33).

If the device also has a digital input jack, it can be connected to the DIGITAL OUTPUT (OPT) jack on the TX-DS797 for digital recording of the source for REC OUT at the TX-DS797.

### Note:

The output from the DIGITAL OUTPUT jack of the TX-DS797 is only the digital signal input to the DIGITAL INPUT jack.

## 6. Connecting a video cassette recorder (VIDEO 1)

Using an RCA-type video connection cable, connect the video output terminal (composite) on the video cassette recorder to the VIDEO 1 IN jacks on the TX-DS797 and video input terminal to the VIDEO 1 OUT jacks. If there is an S video input/output terminal on the video cassette recorder, connect it to the S VIDEO 1 IN/OUT jack using an S video cable. You do not need to connect to both the S VIDEO 1 IN and VIDEO 1 IN terminals. If the video cassette recorder has component video outputs, connect them to one of the COMPONENT VIDEO INPUT jacks.

With the initial settings of the TX-DS797, the VIDEO 1 input source is set for the COMPONENT VIDEO INPUT 2 jack.

If the video connection is made at COMPONENT VIDEO INPUT 1, this must be changed at the Setup menu: Input Setup → Video Setup → Component Video (see page 35).

Using an RCA-type audio connection cable, connect the audio output terminal on the video cassette recorder to the same VIDEO 1 IN audio jacks on the TX-DS797 and audio input terminal to the VIDEO 1 OUT audio jacks. Make sure that you properly connect the left channel to the L jack and the right channel to the R jack.

With the initial settings of the TX-DS797, the VIDEO 1 input source is set for digital input at the COAX 2 jack.

If the digital connection is made at a different jack, this must be changed at the Setup menu: Input Setup → Digital Setup (see page 33).

# Connections

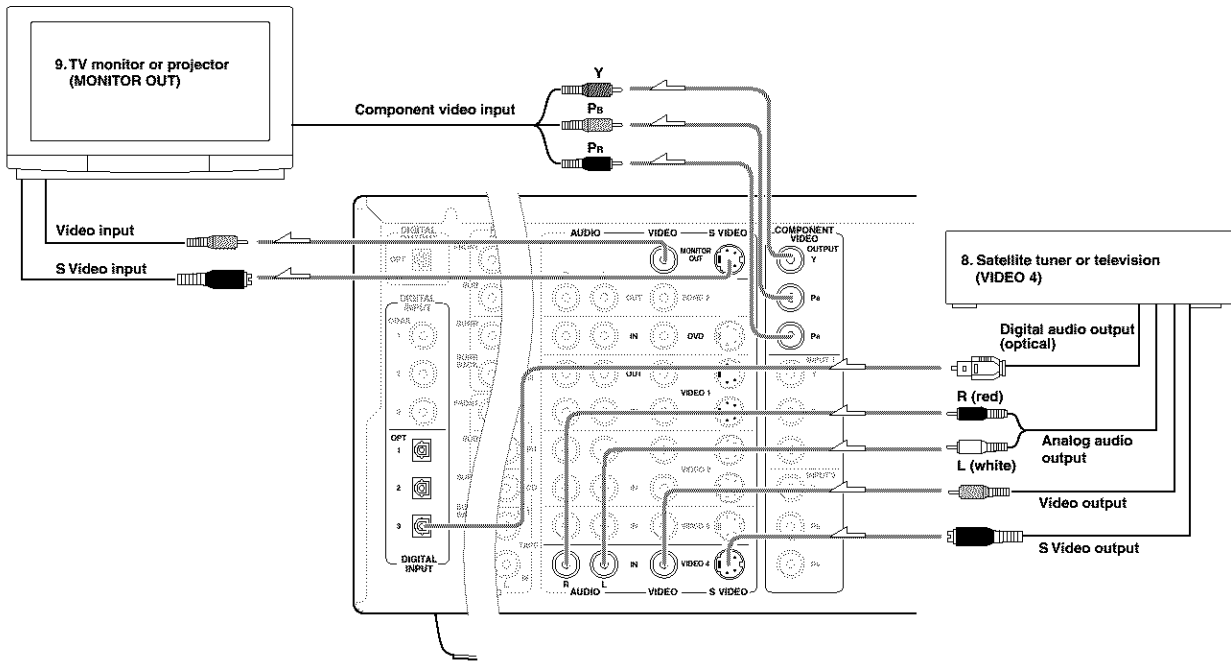

## 7, 8. Connecting a satellite tuner, television, or settop box (VIDEO 3 or 4)

If the satellite tuner or television is equipped with an S video output terminal, connect it to the S VIDEO 3 (or 4) IN terminal with an S video cable. If it does not have an S video output terminal, connect its video output terminal to the VIDEO 3 (or 4) IN terminal using an RCA-type video connection cable. You do not need to connect to both the S VIDEO 3 (or 4) IN and VIDEO 3 (or 4) IN terminals. If the satellite tuner or television has component video outputs, connect them to one of the COMPONENT VIDEO INPUT jacks.

**With the initial settings of the TX-DS797, the VIDEO 3 and VIDEO 4 input sources are set for the COMPONENT VIDEO INPUT 2 jack.**

If the video connection is made at COMPONENT VIDEO INPUT 1, this must be changed at the Setup menu: Input Setup → Video Setup → Component Video (see page 35).

Using an RCA-type audio connection cable, connect the audio output terminal on the satellite tuner or television to the same VIDEO 3 (or 4) IN audio jacks on the TX-DS797. Make sure that you properly connect the left channel to the L jack and the right channel to the R jack.

If the device has a digital output jack as well, be sure to also connect it to either a DIGITAL INPUT (COAX) or DIGITAL INPUT (OPT) jack on the TX-DS797 depending on the device.

**With the initial settings of the TX-DS797, the VIDEO 3 input source is set for digital input at the OPT 3 jack.**

If the digital connection is made at a different jack, this must be changed at the Setup menu: Input Setup → Digital Setup (see page 33).

**With the initial settings of the TX-DS797, nothing is allocated as the digital input source for VIDEO 4 (----).**

If you connect a digital component to the VIDEO 4 terminal, be sure to make the appropriate settings in the Digital Setup sub-menu (see page 33).

## 9. Connecting a television monitor or projector (MONITOR OUT)

The TX-DS797 is equipped with a simple Y/C separate circuit and simple Y/C mixed circuit. Since both the signal from the S VIDEO

and VIDEO inputs are output to the MONITOR OUT S VIDEO output, if the television or projector is equipped with an S video input, it is unnecessary to connect the video connectors. If it is equipped with only a video input, connect it to the MONITOR OUT VIDEO output.

If the monitor or projector is equipped with an S video output terminal, connect it to the MONITOR OUT S VIDEO terminal with an S video cable. If it does not have an S video output terminal, connect its video output terminal to the MONITOR OUT VIDEO terminal using an RCA-type video connection cable. You do not need to connect to both the MONITOR OUT S VIDEO and MONITOR OUT VIDEO terminals. If the device has component video inputs, connect them to the COMPONENT VIDEO OUTPUT jacks.

### Note:

Note that the Setup menu will only be displayed on the monitor connected to MONITOR OUT and not those connected to the COMPONENT VIDEO OUTPUT jacks.

## 10. Connecting video camera, etc. (VIDEO 5/VIDEO CAM INPUT)

If the device is equipped with an S video output terminal, connect it to the S VIDEO 5 IN terminal with an S video cable. If it does not have an S video output terminal, connect its video output terminal to the VIDEO 5 IN terminal using an RCA-type video connection cable. You do not need to connect to both the S VIDEO 5 IN and VIDEO 5 IN terminals.

The VIDEO 5 digital input is fixed to the OPTICAL input on the front panel.

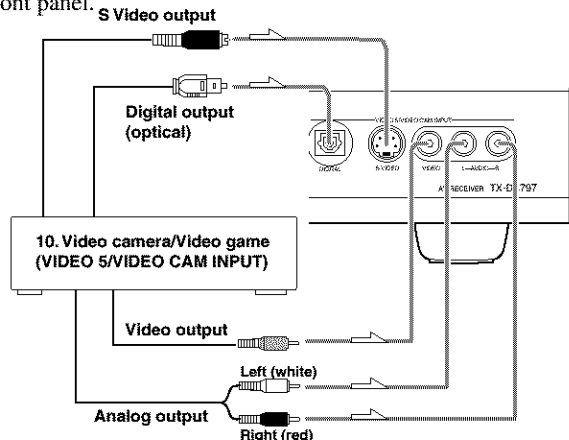

# Connecting speakers

Before connecting the speakers, place them correctly by consulting the instruction manuals that came with them.

For surround playback, the configuration and placement of your speakers are very important.

For THX surround EX playback, we recommend that you use a THX speaker system that is certified by Lucasfilm Ltd.

## Ideal speaker configuration

- **Front right and left speakers**
- **Center speaker**

Produces a rich sound image by serving as a sound source for the front right and left speakers and enhancing the sonic movement.

- **Surround right and left speakers**

Adds three-dimensional sonic movement and produces environmental sound associated with the background and effect sound for each scene.

- **Surround back speaker**

Required for enjoying THX Surround EX, DTS-ES Matrix 6.1, or DTS-ES Discrete 6.1 audio. For audio using surround back right and surround back left speakers, a separately-sold 2-channel power amplifier is required.

Lucasfilm/THX recommends the use of two Surround Back speakers to enjoy the full potential of THX Surround EX. An external stereo power amplifier will need to be used to power the two speakers from the Pre-Amp out terminals.

However, if you are unable to position two speakers in your listening environment, a single surround speaker can be used and the TX-DS797 has an internal amplifier to power this speaker for your convenience.

- **Subwoofer**

Produces powerful and heavy bass.

## Minimum speaker configuration for surround sound playback

- **Front right and left speakers**
- **Surround right and left speakers**

The sound recorded for the center speaker and the subwoofer will be properly distributed to the front right and left speakers for optimized surround playback.

## Speaker placement

Ideal speaker placement varies depending on the size of your room and the wall coverings. Here, only typical example of speaker placement and recommendations are shown.

In order to create the optimum conditions for the best sound quality, be sure to place all the speakers so that the greatest difference between the distances of each speaker to the listening position is less than 20 feet (6 meters).

### Important points regarding speaker placement

#### Front left and right speakers and center speaker

- Place these three speakers at the same height from the floor.
- Place each speaker so that sound is aimed at the location of the listener's ears when at the listening position.

#### Surround left and right speakers

- Place these speakers so that their height is 3 feet (1 meter) higher than that of the listener's ears.

### Surround back speaker/Surround back left and right speakers

- Place these speakers behind the listener so that the angle between each speaker and the listener is approximately 15 degrees.
- Place these speakers so that their height is 3 feet (1 meter) higher than that of the listener's ears.

#### Note:

For audio using surround back right and surround back left speakers, a separately-sold 2-channel power amplifier is required.

(Only one surround back speaker)

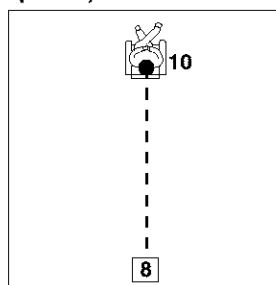

(Two surround back speakers)

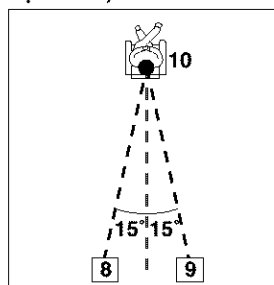

### Subwoofer

A subwoofer is recommended for the highest bass effect.

(Only one surround back speaker)

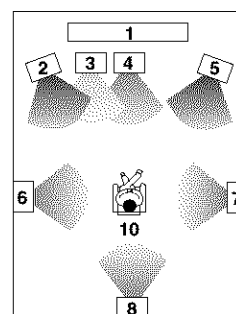

(Two surround back speakers)

Layout with dipolar speakers

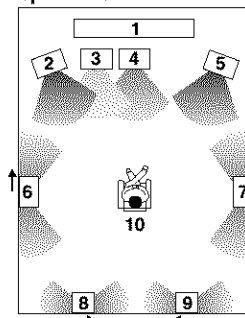

Layout with monopolar speakers

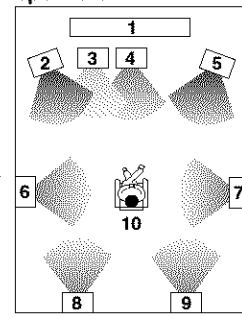

- |                          |  |
|--------------------------|--|
| 1 TV or screen           | 8 Surround back left speaker or Surround back speaker (only one surround back speaker) |
| 2 Front left speaker     | 9 Surround back right speaker  |
| 3 Subwoofer              | 10 Listening position  |
| 4 Center speaker         |  |
| 5 Front right speaker    |  |
| 6 Surround left speaker  |  |
| 7 Surround right speaker |  |

Most dipoles have an arrow on them to indicate their orientation towards the screen. So for the side dipoles, the arrows point forward. For the back dipoles, the arrows should point towards each other to achieve the correct acoustical phasing in the room.

# Connecting speakers

## Connecting speakers

**Caution:**  
Connect only speakers with an impedance between 4 and 16 Ω to the TX-DS797. If the impedance of even one speaker is between 4 and 6 Ω, be sure to set the speaker impedance setting accordingly (see page 28).

- Notes:**
- When you are using only one speaker or when you wish to listen to monaural (mono) sound, a single speaker should never be connected in parallel to both the right and left-channel terminals simultaneously.

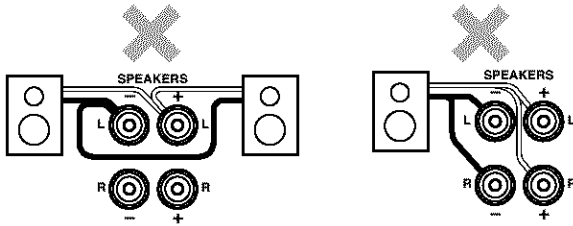

- To prevent damage to circuitry, never short-circuit the positive (+) and negative (-) speaker wire.
- NO!**
- Be sure to connect the positive and negative cables for the speakers properly. If they are mixed up, the left and right signals will be reversed and the audio will sound unnatural.
  - Do not connect more than one speaker cable to one speaker terminal. Doing so may damage the TX-DS797.
  - Connect your surround back speaker to the SURR BACK SPEAKER terminals (see page 20).

## Connecting the speaker cable

- Strip away 5/8 inch (15 mm) of wire insulation.
- Twist wire ends very tight.
- Unscrew
- Insert wire
- Screw

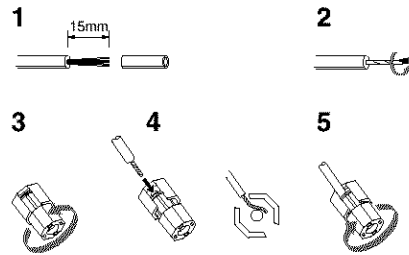

## Connecting a subwoofer

Use the PRE OUT SUBWOOFER jack to connect a subwoofer with a built-in power amplifier. If your subwoofer does not have a built-in amplifier, connect an amplifier to the PRE OUT SUBWOOFER jack and the subwoofer to the amplifier.

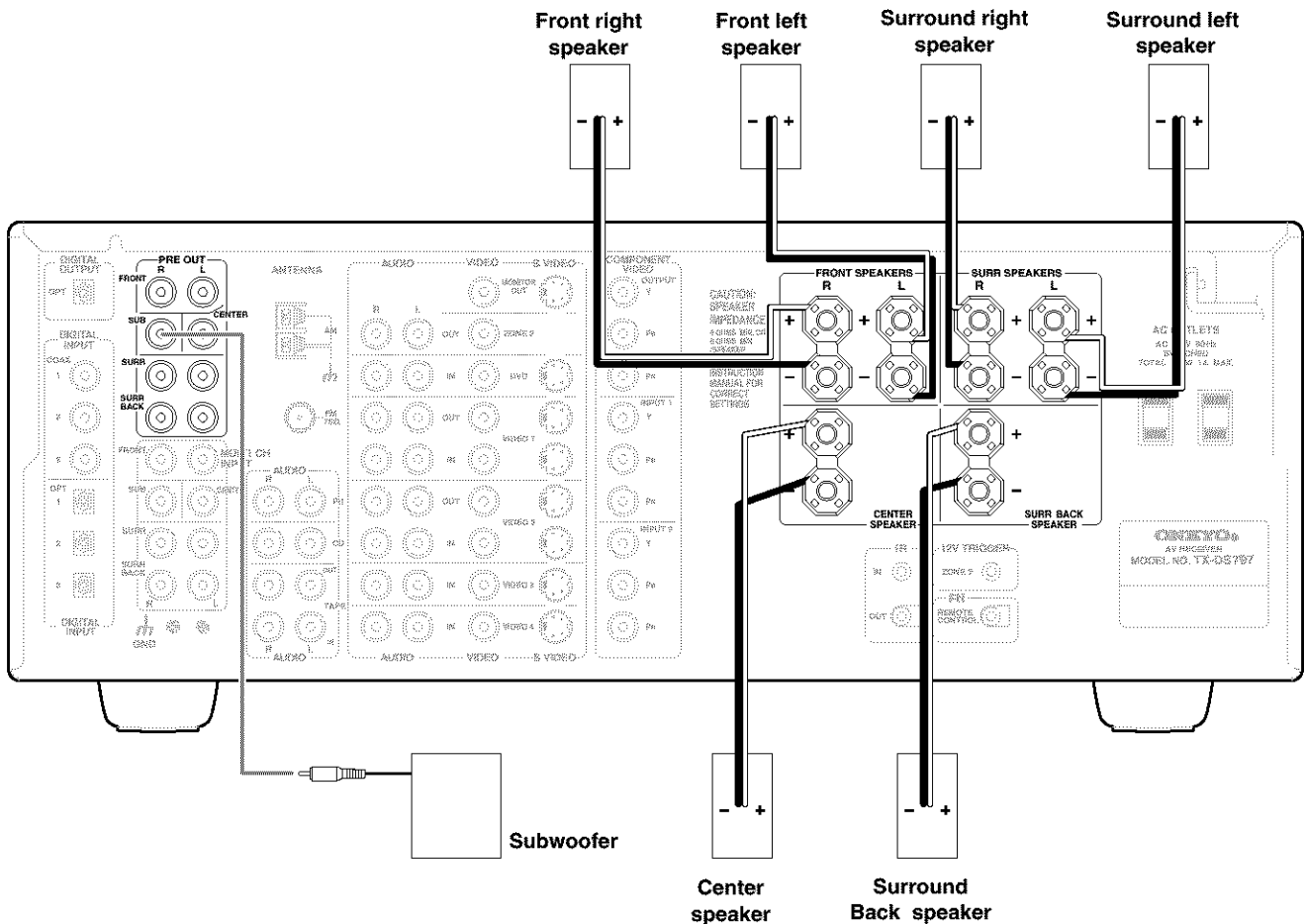

# Connecting the remote zone (Zone 2) speakers

The TX-DS797 allows you to connect another set of speakers and place them in a different room or separated area for listening to music. This other room or area is referred to as the remote zone (Zone 2), while the room where the TX-DS797 is located is the main zone. In addition, the IR IN/OUT allows you to control the TX-DS797 from the remote zone (Zone 2) with the remote controller even though the remote zone is physically separated. The diagram below shows how to make the proper connections for the remote zone.

## When using the ZONE 2 OUT terminals

The ZONE 2 OUT terminal is a constant output. Connect to the LINE input of the amplifier (CD, tape, etc.). Adjust the volume with the amplifier connected to the ZONE 2 OUT terminal.

1. **Connect the TX-DS797 to the amplifier for the remote zone.**
2. **Connect the remote zone speaker cables to the speaker terminals on the amplifier.**  
Adjust the volume level at the amplifier.
3. **Connect the TX-DS797 to the monitor for the remote zone.**

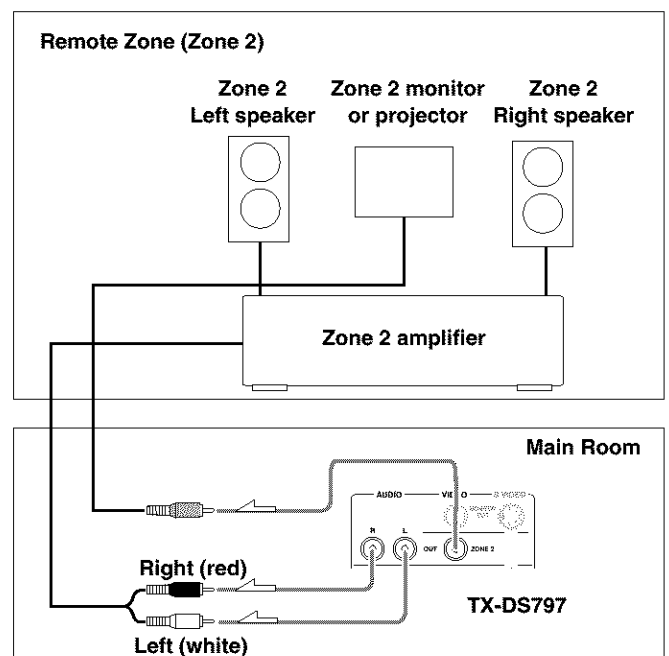

# Operating components not reached by the remote controller signals (IR IN/OUT)

The following equipment (sold separately) is essential for operation:

- Onkyo's Multi-Room System kits (IR Remote Controller Extension System), or
- Multiroom A/V distribution and control systems from Niles® and Xantech® to name a few

## If the remote controller signal does not reach the TX-DS797 remote sensor

If the TX-DS797 is located inside a cabinet or other enclosure where the infrared rays from the remote controller cannot enter, then operation with the remote controller will not be possible. In such a case, it will be necessary to install a remote sensor at a location outside of the cabinet for the infrared rays from the controller to reach.

With this connection, select "Main" for the Hardware Setup → IR IN Setup → Position setting in the Setup menu (see page 28).

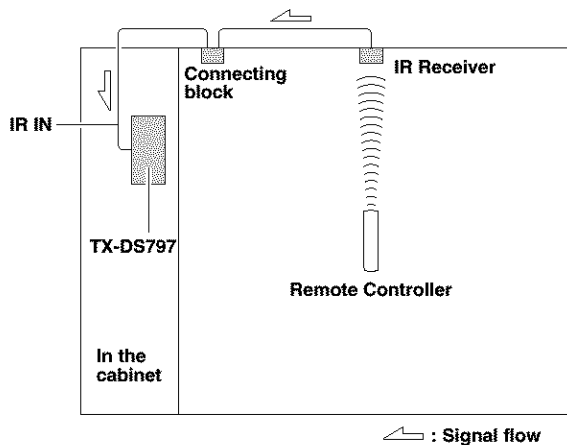

The IR IN input allows you to control the TX-DS797 from the remote zone (Zone 2) with the remote controller even though the remote zone is physically separated. The diagram below shows how to make the proper connections for the remote zone.

With this connection, select "Zone 2" for the Hardware Setup → IR IN Setup → Position setting in the Setup menu (see page 28).

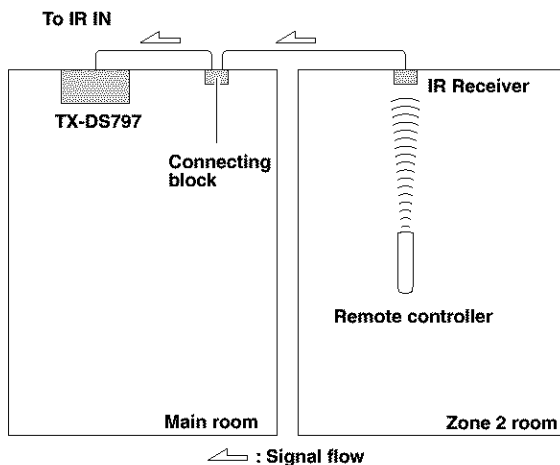

Make connection as shown below. Do not plug the equipment into the power source until the connection is complete.

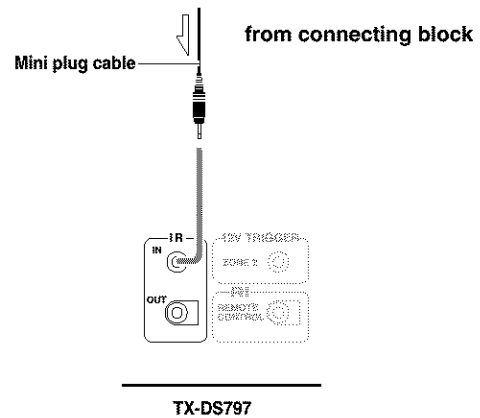

## If the remote controller signal does not reach other components

In this situation, you will need to use a commercially available IR emitter. Connect the mini plug of the IR emitter to the IR OUT terminal on the TX-DS797 and then place the IR emitter on the remote sensor of the component or facing it. When the IR emitter is connected, only the signal input to the IR IN terminal is output to the IR OUT terminal. The signal input from the remote sensor on the front of the TX-DS797 will not be output to the IR OUT terminal.

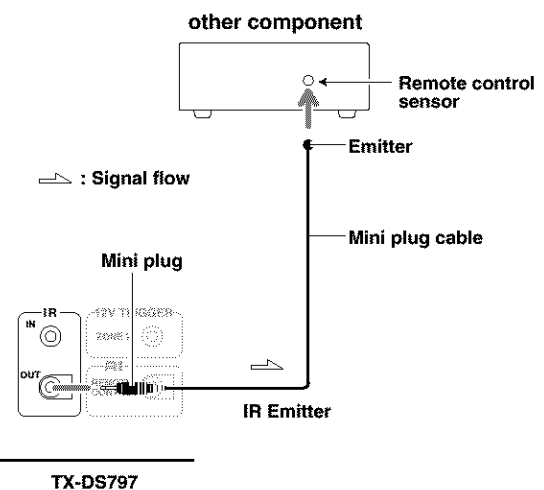
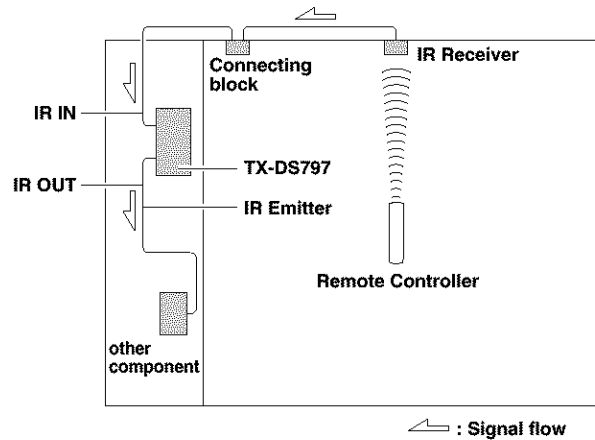

# Connecting the power

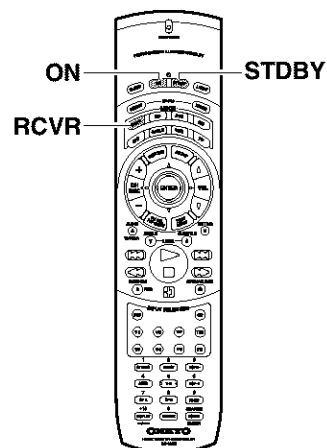
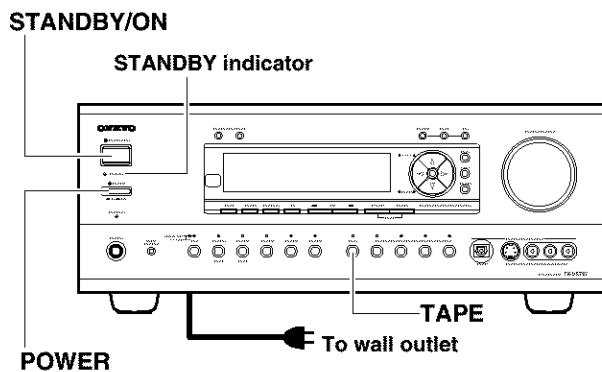

- The TX-DS797 is shipped with the main power (POWER) switch in the on position (ON). When the power cord is plugged in for the first time, the TX-DS797 will automatically enter the standby state and the STANDBY indicator will light (same condition after step 2 below).
- Before you plug in the TX-DS797, confirm that all connections have been made properly.
- Turning on the power may cause a momentary power surge, which might interfere with other electrical equipment on the same circuit, such as computers. If this happens, use a wall outlet on a different circuit.

## 1. Plug the power cord into an AC wall outlet.

## 2. Press the POWER switch to set the TX-DS797 to standby state.

The STANDBY indicator will light up.

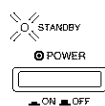

## 3. Press the STANDBY/ON button to turn on the TX-DS797. The display and four jog dial indicators will light up and the STANDBY indicator will turn off.

If you press the STANDBY/ON button again, the receiver returns to Standby mode.

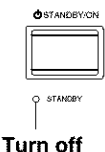

## Turning the power on from the remote controller:

Before you can use the remote controller, you must perform steps 1 and 2 above and place the TX-DS797 in the standby state.

## 1. Press the RCVR MODE button.

The RCVR MODE button lights green.

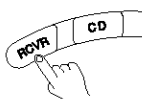

## 2. Press the ON button to turn on the TX-DS797 (take it out of the standby state).

To return the TX-DS797 to the standby state, press the STDBY button.

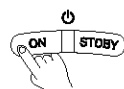

## To change the display of the input source from TAPE to MD:

If you connected an MD recorder to the TAPE jack on the TX-DS797, you can have "MD" appear when the TAPE source button is pressed. By changing the display, if an Onkyo MD recorder is connected, the RI system functions will become enabled.

## Changing the display:

Press and hold down the TAPE source button until the display changes from TAPE to MD (approx. 3 seconds).



To return the display to its original setting, perform the same procedure. This setting is necessary to allow RI system functions for the connected cassette tape or MD recorder.

## Memory preservation

This unit does not require memory preservation batteries. A built-in memory power backup system preserves the contents of the memory during power failures and even when the POWER switch is set to off. The POWER switch must be set to on in order to charge the backup system.

The memory preservation period after the unit has been turned off varies depending on climate and placement of the unit. On the average, memory contents are protected over a period of a few weeks after the last time the unit has been turned off. This period is shorter when the unit is exposed to a highly humid climate.

# Connecting antennas

To use the tuner of TX-DS797, it is necessary to prepare the supplied FM and AM antennas.

- Adjustment and placement of the FM and AM antennas for better reception must be done while listening to a station broadcast.
- If better reception cannot be obtained, then placement of an outside antenna is recommended.

## Assembling the AM loop antenna

Assemble the loop antenna as shown in the illustration.

- Refer to “Connecting the AM loop antenna” below for details on connecting the loop antenna.

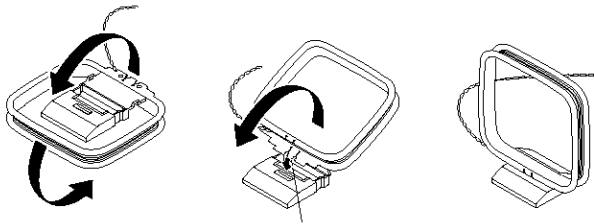

Insert into the hole.

## Connecting the AM antenna cable

1. Press down the lever.
2. Insert the wire into the hole.
3. Release the lever.

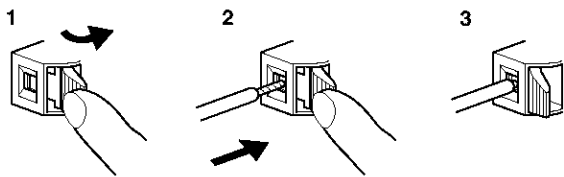

## Connecting the included antennas

### Connecting the FM indoor antenna:

The FM indoor antenna is for indoor use only. During use, extend the antenna and move it in various directions until the clearest signal is received. Fix it with push pins or similar implements in the position that will cause the least amount of distortion.

If the reception is not very clear with the attached FM indoor antenna, the use of an outdoor antenna is recommended.

### Connecting the AM loop antenna:

The AM loop antenna is for indoor use only. Set it in the direction and position where you receive the clearest sound. Put it as far away as possible from the TX-DS797, televisions, speaker cables, and power cords.

When reception is not satisfactory with the attached AM loop antenna alone, connection of an outdoor antenna is recommended.

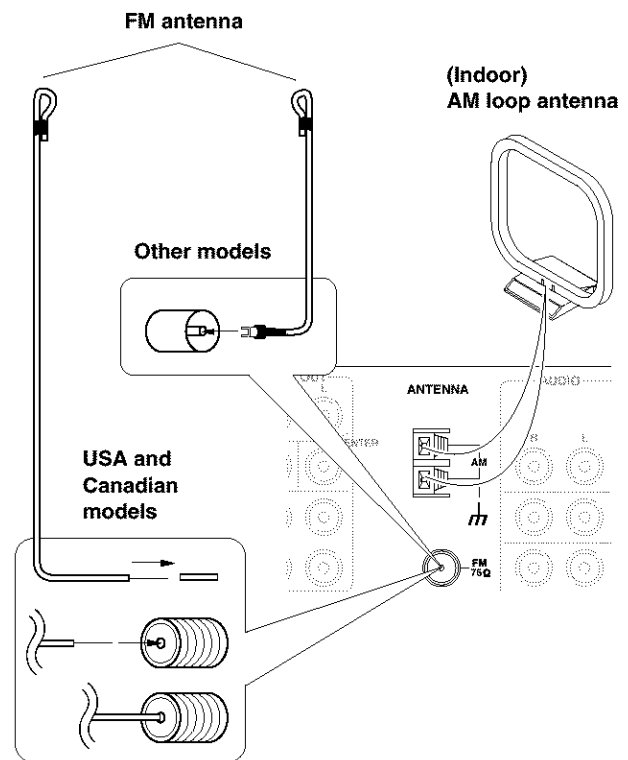

Strip away the insulation from the end of the cable, then fully insert the stripped end of the cable.

### Hint:

Either of the split ends of the AM antenna can be connected to either terminal. Unlike speaker cabling, there is no polarity for AM broadcast signals.



# Connecting antennas

## Connecting an FM outdoor antenna

Please make sure that you follow the considerations:

- Keep the antenna away from noise sources (neon signs, busy roads, etc.).
- It is dangerous to put the antenna close to power lines. Keep it well away from power lines, transformers, etc.
- To avoid the risk of lightning and electrical shock, grounding is necessary. Follow item 14 of the "Important Safeguards" on page 2 when you install the outdoor antenna.

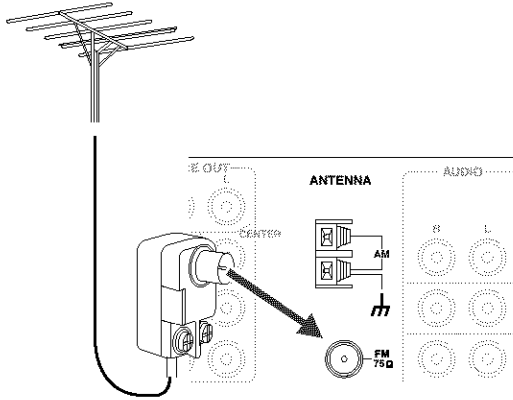

## Connecting an AM outdoor antenna

An outdoor antenna will be more effective if it is stretched horizontally above a window or outside.

- Do not remove the AM loop antenna.
- To avoid the risk of lightning and electrical shock, grounding is necessary. Follow item 14 of the "Important Safeguards" on page 2 when you install the outdoor antenna.

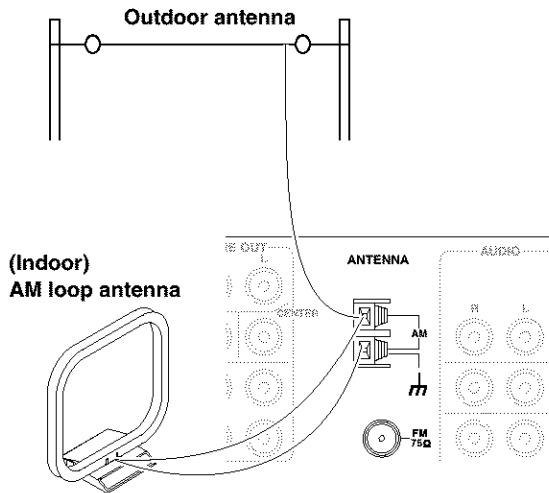

**Note:**

If you are using the TX-DS797 worldwide model in a region where AM frequencies are delineated by 10-kHz steps, be sure to set the AM Freq Step Setup setting accordingly (see page 28).

## Directional linkage

Do not use the same antenna for both FM and TV (or VCR) reception since the FM and TV (or VCR) signals can interfere with each other. If you must use a common FM/TV (or VCR) antenna, use a directional linkage type splitter.

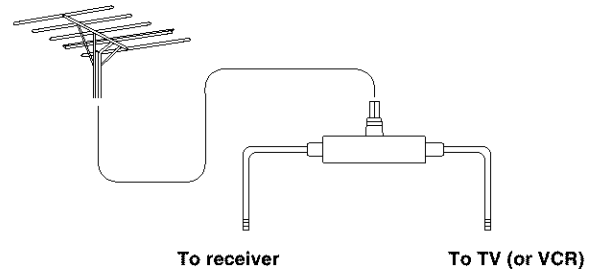

## Connecting the antenna cable to the 75/300 Ω antenna adapter (For all models other than European models)

**Connecting the 300 Ω ribbon wire:**

Loosen the screws and wrap the wire around these screws. Then tighten the screws with a screwdriver.

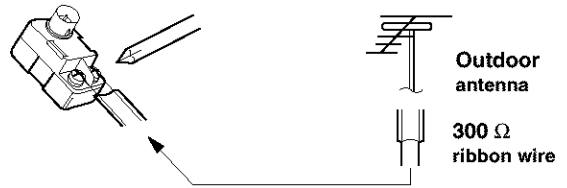

**Connecting the coaxial cable:**

1. With your fingernail, or a small screwdriver, press the stoppers of the 75/300 Ω antenna adapter outward and remove the cover.
2. Remove the transformer wire A from slit B and insert it into slit C.
3. Prepare the coaxial cable as shown in the diagram.
4. Connect the 75/300 Ω antenna adapter to the coaxial cable.
  1. Insert the end of the cable.
  2. Clamp it in place with pliers.
5. Reinstall the cover.

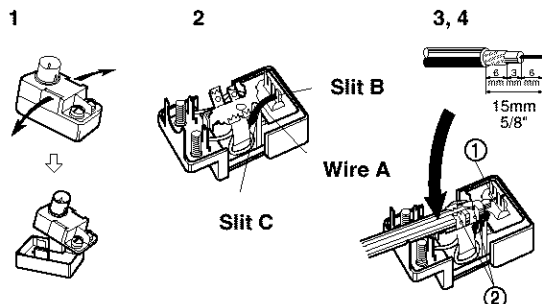

# Setup menus

When making the various settings required to configure your TX-DS797 optimally, you can either use the OSD menu that appears on your television monitor or you can use the display on the front of the TX-DS797. The OSD menu is a settings menu that is displayed on your TV monitor. For use as reference when performing the setting procedures, this manual shows both the OSD menu displayed on your television monitor and the display on the front of the TX-DS797.

The Setup menu consists of a main screen that is divided up into 5 menus: Hardware Setup, Speaker Setup, Input Setup, Audio Adjust, and Preference. These menus are then divided up into various sub-menus, and these contain settings for you to optimize your home theater as you wish.

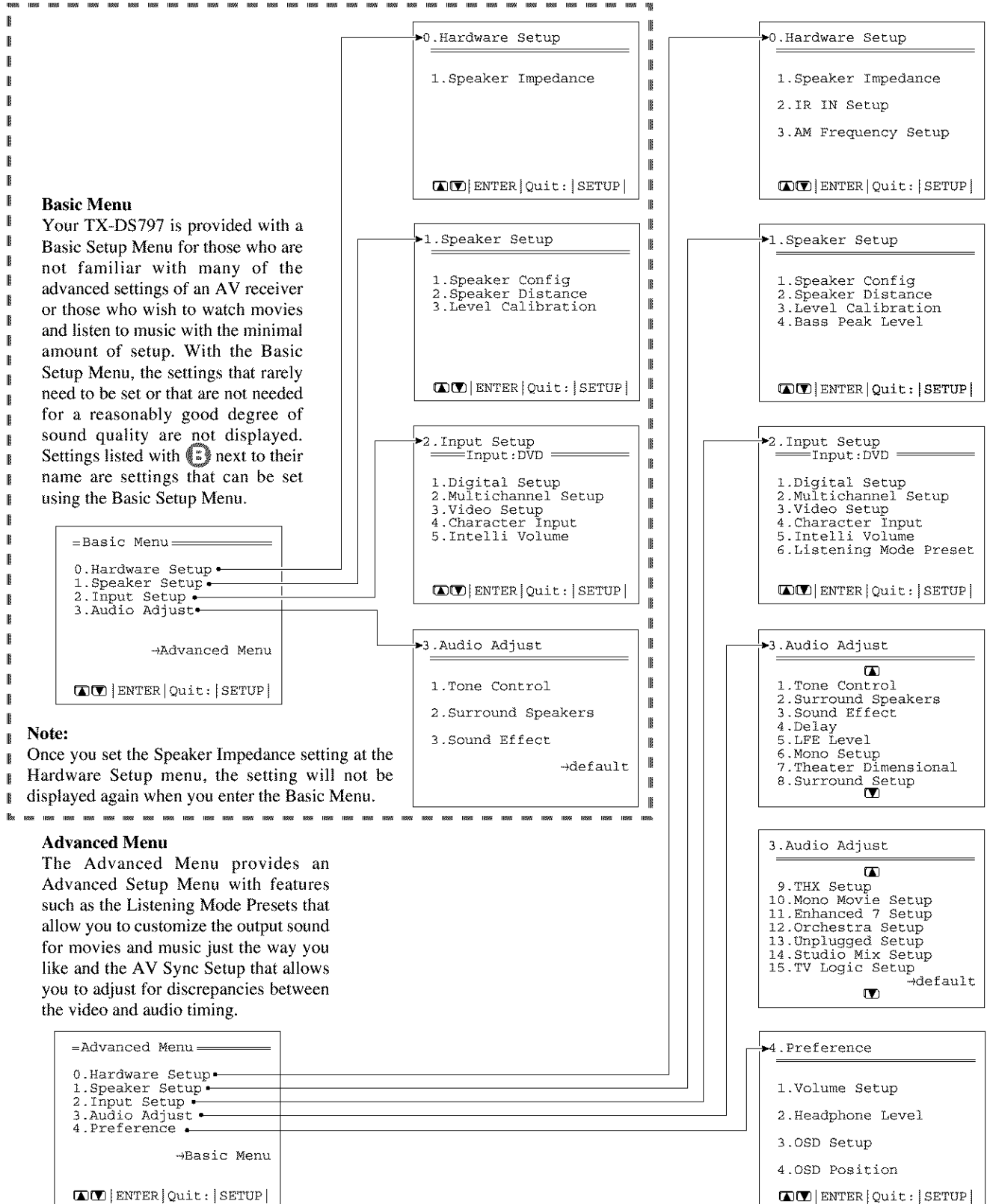



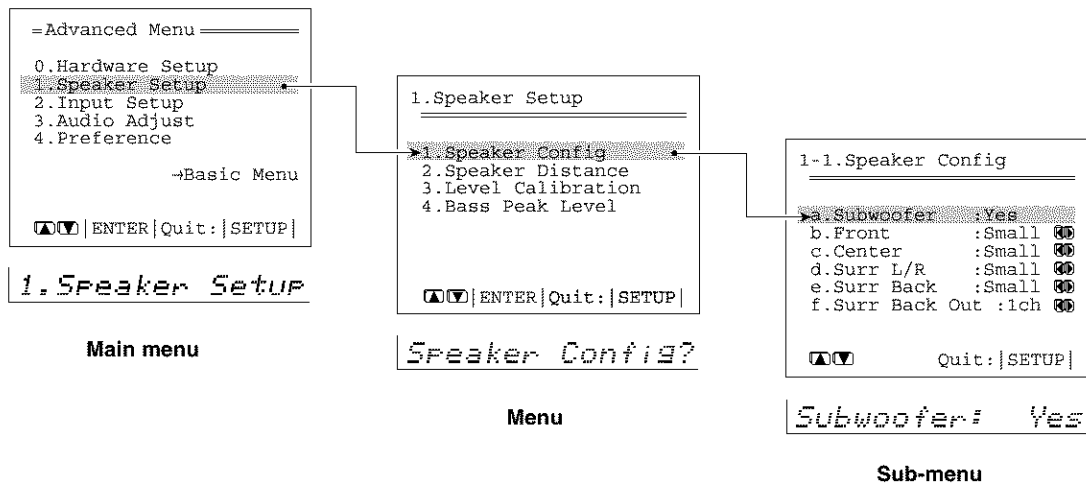









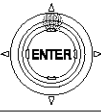

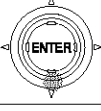
# Setup menus

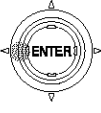

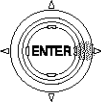
## Navigating through the Setup menu

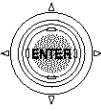
You can change settings using the buttons on the front panel and on the remote controller.

The buttons on the remote controller correspond to those on the TX-DS797 as shown below.

Button on remote controller	Button on TX-DS797
 SETUP	 SETUP
 (upper edge of ENTER button)	 UP
 (lower edge of ENTER button)	 DOWN
 (left edge of ENTER button)	 LEFT
 (right edge of ENTER button)	 RIGHT
 ENTER	 ENTER
 RETURN	 RETURN

### 1. Press the SETUP button.

The main menu screen of the Main menu appears on your TV monitor.

### 2. Using the ▲ and ▼ cursor buttons, select the menu that you want to enter.

### 3. Press the ENTER button to enter the selected menu.

The screen for that menu appears.

### 4. Using the ▲ and ▼ cursor buttons, select the sub-menu that you want to enter, and press the ENTER button.

Each sub-menu has different settings that can be changed as desired, and they are all explained below. To change a setting, first select it using the ▲ and ▼ cursor buttons, and then change the setting using the ◀ and ▶ cursor buttons.

### 5. Press the RETURN button to set the new settings and return to the previous menu screen, and again to return to the main screen.

#### Note:

Press the SETUP button to exit the Setup menu immediately.

# Hardware Setup

## 0. Hardware Setup menu

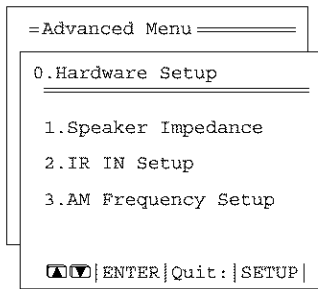

0. Hardware Setup

The Hardware Setup menu will need to be set before you use your TX-DS797 for the first time. Once you set the Speaker Impedance setting at the Hardware Setup menu, the setting will not be displayed again when you enter the Basic Menu. To change the setting at a later date, select the Advanced Menu to display the Hardware Setup menu.

### 0-1. Speaker Impedance sub-menu

Set the impedance level to match the specifications of the speakers you are using.

If the impedances of all speakers are between 6 and 16  $\Omega$ , select “6 ohms.” If the impedance of even one speaker is between 4 and 6  $\Omega$ , select “4 ohms.”

#### Note:

Before you change this setting, be sure to first lower the volume at the TX-DS797 to the minimum level.

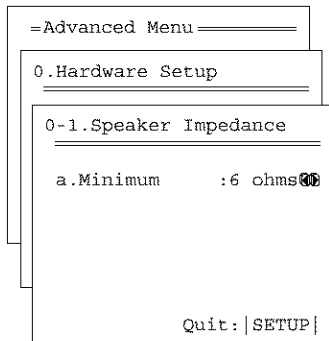

SP Impedance?

## 0-2. IR IN Setup sub-menu

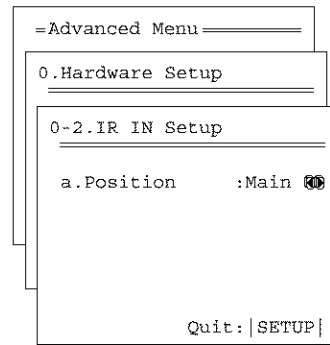

IR IN Setup?

This sub-menu allows you to set where you will be using the remote controller when you are using it in conjunction with the IR IN terminal (i.e. remote controller signals are input at the IR IN terminal).

**Main:** Select when you have a remote sensor for the remote controller connected to the IR IN terminal in the main room.

**Zone 2:** Select to perform the remote zone (Zone 2) operations from the remote zone. When this is selected, the ON/STDBY, INPUT SELECTOR, and CH  $\pm$  buttons work without having to press the ZONE 2 button on the remote controller.

## 0-3. AM Frequency Step sub-menu

### a. AM Frequency Step

This sub-menu only appears on the worldwide model. The initial setting is 9 kHz, and this needs only to be changed if you are using the TX-DS797 in a 10-kHz region.

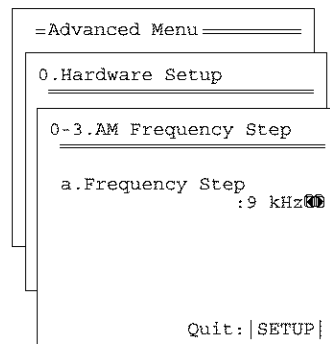

AM Freq Step?

# Speaker Setup

## 1. Speaker Setup menu

After you have installed the TX-DS797, connected all the components, and determined the speaker layout, it is now time to perform the settings in the Speaker Setup menu for the optimum sound acoustics for your environment and speaker layout.

Before you perform the following settings, it is important that you first determine the following characteristics:

- The types and sizes of the speakers that are connected.
- The distance from each speaker to your normal listening position.

### (Only one surround back speaker)

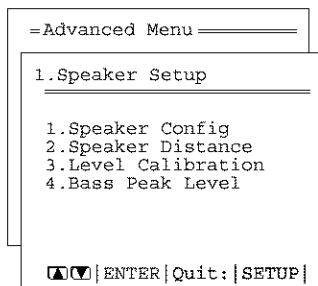

1. Speaker Setup

### (Two surround back speakers)

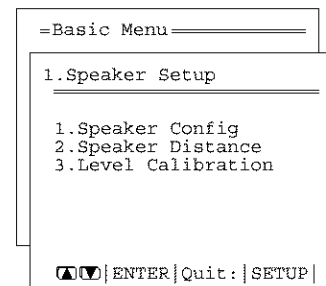

1. Speaker Setup

### Memo:

#### (Only one surround back speaker)

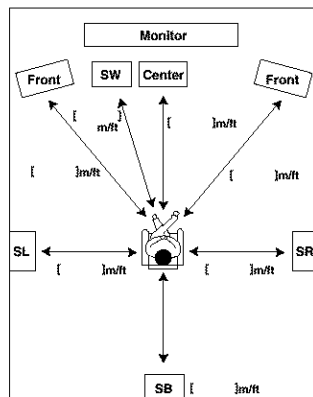

#### (Two surround back speakers)

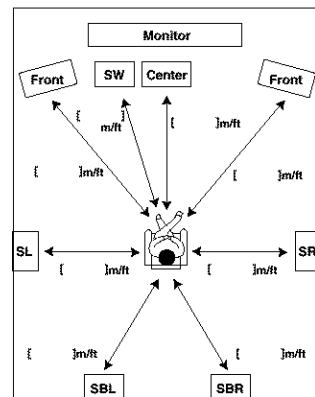

### Tip:

When setting the speaker size in the Speaker Config sub-menu, use the guidelines given below.

**Large:** The complete frequency range for the channel you are setting will be output from the speaker.

**Small:** Frequencies of the channel you are setting lower than 80 Hz will be output from the subwoofer. If there is no subwoofer, then the output will be from the left and right front speakers. (Set all speakers for THX speaker systems to "small.")

## 1-1. Speaker Config sub-menu

Here you will enter which speakers are connected and the size of each speaker.

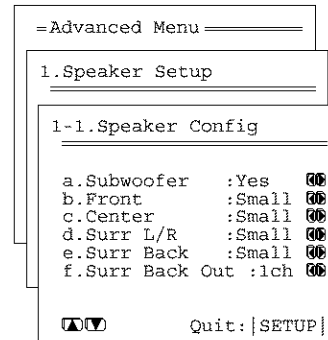

Speaker Config?

### a. Subwoofer

**Yes:** Select when a subwoofer is connected.

**No:** Select when a subwoofer is not connected.

### b. Front

**Large:** Select if the front speakers are large sized.

**Small:** Select if the front speakers are small sized.

- If "No" is selected for the Subwoofer setting, then this setting is fixed to "Large."

### c. Center

**None:** Select if no center speaker is connected.

**Large:** Select if the center speaker is large sized.

**Small:** Select if the center speaker is small sized.

- If "Small" is selected for the Front setting, then "Large" cannot be selected for this setting.

### d. Surround L/R

**None:** Select if no surround left and right speakers are connected.

**Large:** Select if the surround left and right speakers are large sized.

**Small:** Select if the surround left and right speakers are small sized.

- If "Small" is selected for the Front setting, then "Large" cannot be selected for this setting.

### e. Surround Bk

**None:** Select if no surround back left and right speakers are connected.

**Large:** Select if the surround back left and right speakers are large sized.

**Small:** Select if the surround back left and right speakers are small sized.

- If "None" is selected for the Surround L/R setting, the display disappears from the screen.

- If "Small" is selected for the Surround L/R setting, then "Large" cannot be selected for this setting.

### f. Surr Back Out

**1ch:** Select if there is only one surround back speaker.

**2ch (PREOUT only):** Select if there are two surround back speakers. (For preout output only.)

# Speaker Setup

## 1-2. Speaker Distance sub-menu

Here you will enter the distance from each speaker to your normal listening position. This is important for the timing of the acoustics to create the proper sound space that the TX-DS797 and today's sound systems are able to produce.

### Notes:

- Speakers that you selected "No" or "None" for in the Speaker Config sub-menu will not appear.
- The difference between the distances of different speakers cannot be set to more than 20 feet (6 meters).

### (Only one surround back speaker)

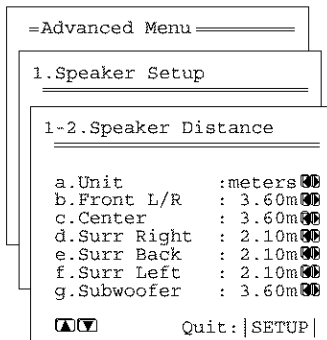

### (Two surround back speakers)

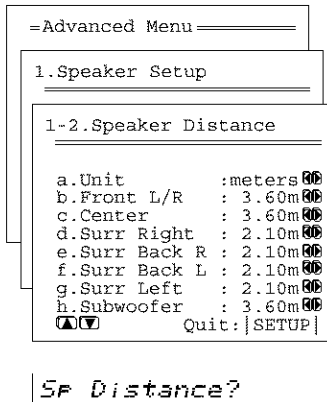

### a. Unit

**feet:** Select if you will enter the distances in feet.

**meters:** Select if you will enter the distances in meters.

### b. Front L/R

Set the distance from the front left and right speakers to your normal listening position between 1 and 30 feet in 0.5-foot intervals (0.3 to 9 meters in 0.15-meter intervals).

Position the front left and right speakers so that they are the same distance from the listener. If they are not, you may lose the center position for stereo sound.

### c. Center

Set the distance from the center speaker to your normal listening position between 1 and 30 feet in 0.5-foot intervals (0.3 to 9 meters in 0.15-meter intervals).

### d. Surr Right

Set the distance from the surround right speaker to your normal listening position between 1 and 30 feet in 0.5-foot intervals (0.3 to 9 meters in 0.15-meter intervals).

### e. Surr Back

Set the distance from the surround back speaker to your normal listening position between 1 and 30 feet in 0.5-foot intervals (0.3 to 9 meters in 0.15-meter intervals).

- This setting appears if set for one surround back speaker in the Speaker Config sub-menu.

### f. Surr Left

Set the distance from the surround left speaker to your normal listening position between 1 and 30 feet in 0.5-foot intervals (0.3 to 9 meters in 0.15-meter intervals).

### g. Subwoofer

Set the distance from the subwoofer to your normal listening position between 1 and 30 feet in 0.5-foot intervals (0.3 to 9 meters in 0.15-meter intervals).

### e. Surr Back R

Set the distance from the surround back right speaker to your normal listening position between 1 and 30 feet in 0.5-foot intervals (0.3 to 9 meters in 0.15-meter intervals).

- This setting appears if set for two surround back speakers in the Speaker Config sub-menu.

### f. Surr Back L

Set the distance from the surround back left speaker to your normal listening position between 1 and 30 feet in 0.5-foot intervals (0.3 to 9 meters in 0.15-meter intervals).

- This setting appears if set for two surround back speakers in the Speaker Config sub-menu.

### Note:

For audio using surround back right and surround back left speakers, a separately-sold 2-channel power amplifier is required.

# Speaker Setup

## 1-3. Level Calibration sub-menu

Here you will set the volume for each speaker so that they are all heard by the listener at the same level. This is especially important for speaker layouts where the left and right speakers are at different distances or in asymmetrical positions due to room designs and configurations. These settings and the distance settings performed above are vital to create the proper acoustics required for the optimum sound space and dynamics.

### Notes:

- **Be aware that when you enter this sub menu, a loud white noise is output.**
- The speaker level settings here are not effective for multi-channel input sources. To adjust the speaker levels for multi-channel input sources, you will need to use the CH SEL, LEVEL ▲, and LEVEL ▼ buttons on the RC-460M remote controller. See page 52.

### (Only one surround back speaker)

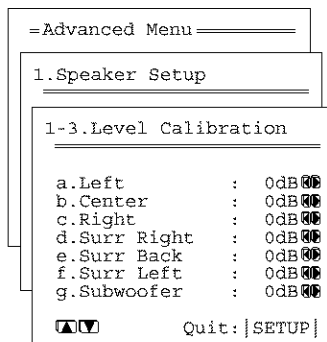

### (Two surround back speakers)

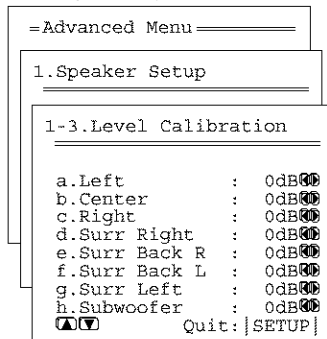

Level Cal?

### Calibrating the speaker levels

- (1) When this sub-menu is entered, the TX-DS797 will emit a pink noise from the front left speaker. At this time, the Master volume automatically increases to the reference level (0dB). Remember the level of this noise and then press the ▼ cursor button. (Note that this can be adjusted to any level between -12 and 12 decibels in 1-decibel intervals.) The TX-DS797 will now emit the pink noise from the center speaker.
- (2) Using the ◀ and ▶ cursor buttons, adjust the volume level of the noise from the center speaker so that it is the same level as the front left speaker. You can jog back and forth between the speakers to help you compare the volume levels.
- (3) Press the ▼ cursor button again. The TX-DS797 will now emit the pink noise from the front right speaker.
- (4) Repeat steps (2) and (3) above for the front right and other speakers until all speakers are adjusted to the same volume level.

### Notes:

- Speakers that you selected “No” or “None” for in the Speaker Config sub-menu will not appear.
- To accurately set the output levels, it is recommended to use a handheld sound pressure level (SPL) meter. Set the meter to C-weighting and slow averaging. A Radio Shack® SPL meter or equivalent is recommended. Using the internal channel noise generators, set each channel so that you read a 75 decibel sound pressure level.

### a. Left

Sound comes from the front left speaker. Adjust the sound level between -12 and 12 decibels in 1-decibel intervals.

### b. Center

Sound comes from the center speaker. Adjust the sound level between -12 and 12 decibels in 1-decibel intervals.

### c. Right

Sound comes from the front right speaker. Adjust the sound level between -12 and 12 decibels in 1-decibel intervals.

### d. Surr Right

Sound comes from the surround right speaker. Adjust the sound level between -12 and 12 decibels in 1-decibel intervals.

### e. Surr Back

Sound comes from the surround back speaker. Adjust the sound level between -12 and 12 decibels in 1-decibel intervals.

- This setting appears if set for one surround back speaker in the Speaker Config sub-menu.

### f. Surr Left

Sound comes from the surround left speaker. Adjust the sound level between -12 and 12 decibels in 1-decibel intervals.

### g. Subwoofer

Sound comes from the subwoofer. Adjust the sound level between -15 and 12 decibels in 1-decibel intervals.

### e. Surr Back R

Sound comes from the surround back right speaker. Adjust the sound level between -12 and 12 decibels in 1-decibel intervals.

- This setting appears if set for two surround back speakers in the Speaker Config sub-menu.

### f. Surr Back L

Sound comes from the surround back left speaker. Adjust the sound level between -12 and 12 decibels in 1-decibel intervals.

- This setting appears if set for two surround back speakers in the Speaker Config sub-menu.

### Note:

For audio using surround back right and surround back left speakers, a separately-sold 2-channel power amplifier is required.

# Speaker Setup

## 1-4. Bass Peak Level (Bass Peak Level Manager\*) sub-menu

Setting the bass peak level is important to keep your subwoofer from being damaged by preventing it from outputting over a set volume. If your subwoofer has a built-in limiter, set this setting to “Off.”

### Note:

If your system does not include a subwoofer, this setting will set the bass peak level for your front speakers.

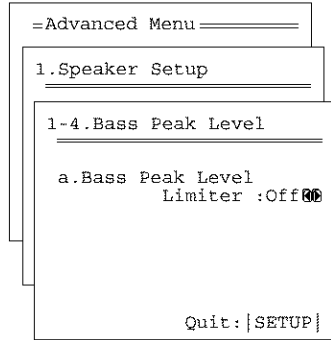

*Bass Peak Lvl?*

### a. Bass Peak Level Limiter

**On:** Select to set the bass peak level. When “On” is selected, the Peak Level setting appears below.

**Off:** Select to turn off the bass peak level limiting function.

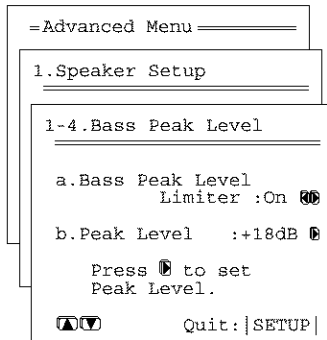

*BassLimiter: On*

### b. Peak Level

The current bass peak level is displayed. Press the ► cursor button to output a test sound. Then press the ► cursor button (or turn the Master Volume dial) to slowly raise the volume to the point where the sound becomes distorted and then back it off until it returns to normal. This is the proper setting for the bass peak level.

After setting the Peak Level at the Bass Peak Level sub-menu, press the RETURN button. The values are set and the previous screen appears.

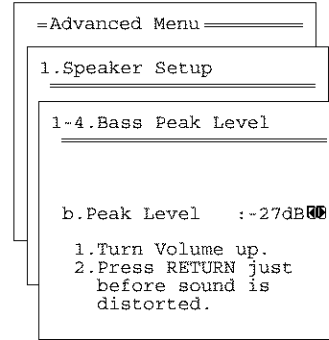

*BassPeakLvl: -27*

### Notes:

- The volume can be adjusted to either  $-\infty$  or between  $-81$  to  $+18$  decibels in 1-decibel increments.
- Do not allow the distorted sound to be output from the subwoofer for a long time for it may damage the subwoofer.

\* Bass Peak Level Manager is a registered trademark of Lucasfilm Ltd.



# Input Setup

## 2. Input Setup menu

This menu allows you to setup the various input sources available with the TX-DS797. Each input source may have a great number of settings that are difficult to keep track of, so we recommend making a chart to record what you have set and for which component to prevent confusion later.

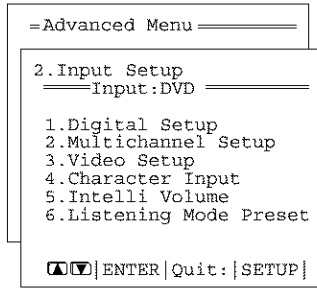

2. Input Setup

### 2-1. Digital Setup sub-menu

The settings made in this sub-menu are valid for the input source that is currently selected with the input source buttons at the front panel and, therefore, these settings are made separately for each digital input source. This sub-menu will not appear if the selected input source button is AM or FM. If this setting is incorrectly made, the digital audio signals may not be properly output, or not heard at all. Also, since VIDEO 5 is fixed to the optical digital terminal on the front panel, this sub-menu will not appear if VIDEO 5 is selected.

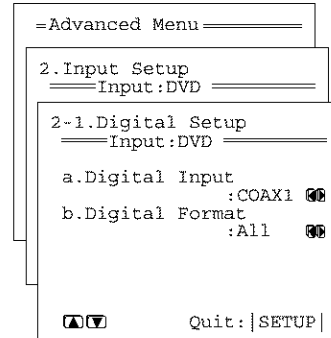

Digital Setup?

#### a. Digital Input

This setting tells the TX-DS797 which input source button on the front panel is connected with which digital input jack on the rear panel. To perform this setting, you must first select a digital input source at the front panel and then set the name of the digital input jack it is connected to here.

For example, if the input source selected at the front panel is CD and the compact disc player is connected to DIGITAL INPUT (OPT) 1, then select "OPT1" here. If the input source selected is not connected to a digital input, then select "----."

**OPT1-3:** Connect your digital components to any of the DIGITAL INPUT (OPT) terminals 1 through 3.

**COAX1-3:** Connect your digital components to any of the DIGITAL INPUT (COAX) terminals 1 through 3.

----: Select if the input source is not from a digital input jack.

#### Initial settings for each input source

Input source	Digital input
CD	OPT 1
PHONO	----
FM	-----
AM	-----
TAPE	OPT 2
VIDEO 1	COAX 2
VIDEO 2	COAX 3
VIDEO 3	OPT 3
VIDEO 4	----
VIDEO 5	Optical on front panel (fixed)
DVD	COAX 1

---- : Available for digital input but not set in initial settings.

 : Not available for digital input.

# Input Setup

## b. Digital Format

Sets the digital signal type to which priority is given during signal detection at the selected digital terminal.

The default setting is "All." If "----" is selected for this input source at the Digital Input setting, then this setting will not appear. Although you can use this default setting as is, you may change it as desired depending on the input signal format (e.g., if you know that you will always be listening to a certain input signal format from a particular input source).

**All:** Select for automatic detection of the input signal format. The input signal format (Dolby Digital, DTS, PCM or Analog) used by the selected input source is detected automatically to execute the required decoding process.

**DTS:** Select for DTS signal processing. The decoding process is executed only when DTS signals are input.

**PCM:** Select for PCM signal processing. The decoding process is executed only when PCM signals are input.

### Notes:

- If "All" is selected and a compact disc or LD is fast-forwarded during playback, decoded PCM signals may produce a skipping sound. In such cases, change the setting to "PCM."
- If a DTS signal is not input when "DTS" is selected, the TX-DS797 does not automatically switch to analog output even if "Auto" is selected with the AUDIO SELECTOR button.

### Notes on DTS:

- If you play a CD or LD that supports DTS when the "PCM" setting is selected on the TX-DS797, the DTS encoded signal will not be decoded and noise will be output. This noise could damage the amplifier and speakers. Therefore, be sure to selected "All" or "DTS" and use the digital input jacks (OPT or COAX) to connect the DTS source.
- If you play a CD or LD that supports DTS when "All" is selected, you may hear a noise for a short while until the DTS decoder recognizes the DTS-encoded signal and starts operating. This is not a malfunction.
- If you press the pause or skip button on the player while playing a DTS source, a short noise may be heard. This is not a malfunction. In such cases, try playing the source in the "DTS" selected.
- The DTS indicator on the TX-DS797 lights while a DTS source is played. When playback finishes and the DTS signal transmission stops, the TX-DS797 remains in DTS mode and the DTS indicator remains lit. This prevents noise when you operate the pause or skip button on the player. Therefore, if the source is immediately switched from DTS to PCM, the PCM signal may not be played. In this case, stop the playback of the source on the player for about three seconds and then resume playback.
- You may not be able to play some DTS source signals from certain CD players and LD players even if you connect the player to the TX-DS797 digitally. This is because the digital signal has been processed (such as the output level, sampling frequency, or frequency response) and the TX-DS797 cannot recognize the signal as DTS data. Therefore you may hear noise when you play a DTS source while processing the signal.
- The outputs for the VIDEO 1 OUT, VIDEO 2 OUT, TAPE OUT, and ZONE 2 OUT output analog audio signals. Do not record from CDs or LDs that support DTS using these outputs. If you do, the DTS-encoded signal will be recorded as noise.
- If a compact disc or LD encoded in the DTS format is played back with "PCM" selected, only noise will be produced. Always select "All" or "DTS" when playing back DTS-encoded sources.

## 2-2. Multichannel Setup sub-menu

This setting is normally set to "No," and only needs to be changed to "Yes" if a DVD player, MPEG decoder, or other component that has a multi channel port is connected to the MULTI CHANNEL INPUT port for 5.1-channel, 6.1-channel, or 7.1-channel audio. For example, if a DVD player is connected to the MULTI CHANNEL INPUT port, then select DVD at the front panel as the input source, bring up this sub-menu, and select "Yes" for the Multichannel setting. You can only select Multichannel with the AUDIO SELECTOR button when "Yes" is selected here.

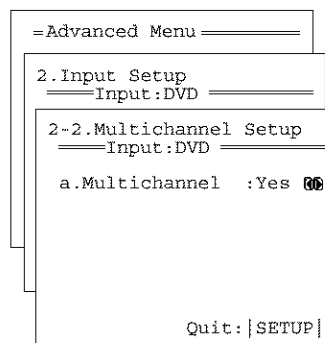

Multich Setup?

Input source selected	Multichannel
CD	No
PHONO	No
FM	No
AM	No
TAPE	No
DVD	Yes
VIDEO 1	No
VIDEO 2	No
VIDEO 3	No
VIDEO 4	No
VIDEO 5	No

### Note:

When playing a device that is actually connected to the MULTI CHANNEL INPUT terminal, select Multichannel with the AUDIO SELECTOR button.

# Input Setup

## 2-3. Video Setup sub-menu

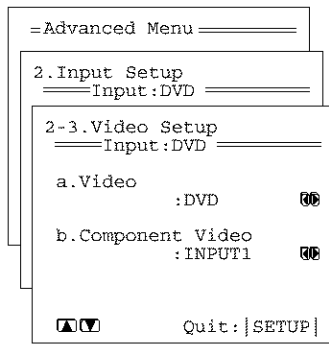

Video Setup?

### a. Video

This setting allows you to match the audio from one component with the video from another. Therefore, you can set a video source to be displayed while the audio from another input source is heard. For example, this allows you to play the music from a compact disc, while displaying the picture from a video cassette player or other video source.

The default settings are given below.

Input source selected	Video
CD	Last Valid
PHONO	Last Valid
FM	Last Valid
AM	Last Valid
TAPE	Last Valid
DVD	DVD
VIDEO 1	VIDEO 1
VIDEO 2	VIDEO 2
VIDEO 3	VIDEO 3
VIDEO 4	VIDEO 4
VIDEO 5	VIDEO 5

**Last Valid:** When you change to an input source set to “Last Valid,” the video of the input source that you changed from is continued. For example, if the selected input source is VIDEO 1, and you then change to CD (set to “Last Valid”), then the audio from the CD input is played while the video from VIDEO 1 continues.

- If no video signal is to be assigned to the input source, set “----.”

### b. Component Video

If a component is connected to the one of the COMPONENT VIDEO inputs (1 or 2), then that input must be set here.

The default settings are given below.

Input source selected	Component video input
CD	Last Valid
PHONO	Last Valid
FM	Last Valid
AM	Last Valid
TAPE	Last Valid
DVD	INPUT 1
VIDEO 1	INPUT 2
VIDEO 2	INPUT 2
VIDEO 3	INPUT 2
VIDEO 4	INPUT 2
VIDEO 5	INPUT 2

**Last Valid (enables the source last selected):** The source that was selected last continues as the input source.

# Input Setup

## 2-4. Character Input sub-menu

This sub-menu allows you to give names to the stations you have preset for the AM/FM tuner, and to the input sources you have connected (excluding the tuner itself). Up to 10 characters can be entered for each name. For example, if you have a DVD connected to the VIDEO4 input jack, then you can give it the name "DVD2." Or, if you have multiple VCRs connected, you can enter the model names or manufacturer names for each one so that you do not have to remember which is connected to which input source.

If you want to enter a name for a preset broadcast radio station, select the station that you want to name and enter the name.

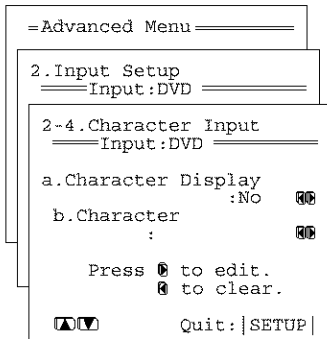

*CharacterInput?*

### a. Character Display

**Yes:** Select to display the name you enter when the input source is selected.

**No:** Select to display the default name.

### b. Character

If you have selected "Yes" for the Character Display above, then here you can enter the name that you want to display. Press **Left** cursor button to clear the current entry. Press **Right** cursor button to bring up the Character Input screen.

At the Character Input screen, press the cursor buttons to move the cursor to the desired character and then press the ENTER button. That character will now appear in the 10-character space field above. Continue until the name is finished or until you have reached 10 characters.

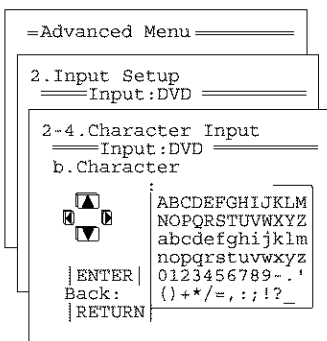

*Char:|*

Using the cursor buttons, select the desired character and press the ENTER button. To change a character, move the cursor backward with the RETURN button or forward with the ENTER button to the location of mistaken character and enter the desired character. To erase a character, enter a blank space in its place. After completing the name, to exit, repeatedly press the ENTER button. Continue until the name is finished or until you have reached 10 characters.

## 2-5. Intelli Volume sub-menu

This sub-menu allows you to set some of the special features offered by the TX-DS797.

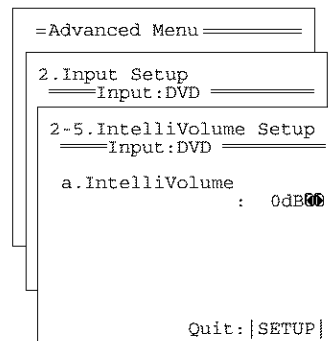

*IntelliVolume?*

### a. Intelli Volume

When switching input sources, you may find that the output level for different components or input sources connected to the TX-DS797 is different even though the main volume setting is the same. Under normal circumstances, you would then have to change the volume setting each time you change the input source. This Intelli Volume setting allows you to preset a volume level for each input source separately so that when you do switch from one input source to another, the TX-DS797 adjusts the volume accordingly so that the resulting volume stays the same. To set the Intelli Volume, simply select an input source at the front panel, and if that source is quieter than other sources, increase its decibel level with the **Right** cursor button, or if it is louder than other sources, decrease its decibel level with the **Left** cursor button.

The Intelli Volume can be adjusted between -12 and +12 decibels.

# Input Setup

## 2-6. Listening Mode Preset sub-menu

With the TX-DS797, you can set a different listening mode for each different signal type that comes from each input source. For example, if your DVD player also plays compact discs and the DVD video signal is Dolby Digital and the compact disc signal is PCM, then you can set a different listening mode for each.

This is especially convenient if you frequently play the same types of movies or music.

\* The 5.1-channel digital surround format has a variety of versions including Dolby Digital and DTS. The 5.1- channel digital surround format enables you to individually record and play five full-range (20 Hz to 20 kHz) channels (left and right front, center, and two surround channels) plus an LFE channel (Low Frequency Effect) for the low-range effect sound. It will create a realistic sound that can be heard in the theaters and concert halls.

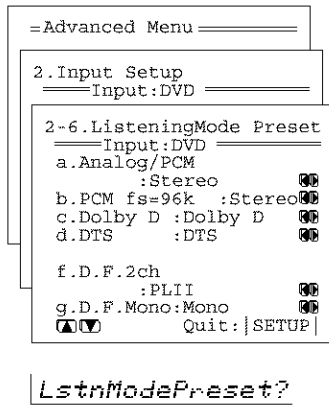

### Relationship between input source and listening mode

Input source signal (display)	Analog/PCM (2ch)	PCM fs=96kHz (96k/24bit)	Dolby D (Multi CH)	DTS (Multi CH)	D.F.2ch (Digital Audio Format)	D.F.Mono
Type of software	Tape, CD, MD, Record, Tuner, DVD (Stereo), LD, Digital satellite	DVD (96k/24bit)	DVD	DVD DTS-CD	DVD Digital satellite	DVD
Listening Mode						
Direct	●	●				
Stereo	●	●	●	●	●	
Mono	●				●	●
Theater-Dimensional	●		●	●	●	
Dolby Pro Logic II	●	●			●	
Dolby Digital			●			
DTS Neo:6	●					
DTS				●		
DTS-ES Discrete				●		
DTS-ES Matrix				●		
THX Cinema(PLII)	●		●	●	●	
THX Cinema(Neo:6)	●					
THX Surround EX			●			
DTS-ES THX Cinema				●		
Mono Movie	●				●	●
Enhanced 7	●		●	●	●	
Orchestra	●		●	●	●	
Unplugged	●		●	●	●	
Studio-Mix	●		●	●	●	
TV Logic	●		●	●	●	
All Ch Stereo	●				●	

The listening modes that can be set are different for each input source format.

#### Note:

**You may not be able to select all the listening modes shown here depending on your speaker configuration or the selected input source.**

# Input Setup

---

## Input source signals

### a. Analog/PCM

Analog sources consist of LP records, FM and AM broadcasts, cassette tapes, and the such. PCM (Pulse Code Modulation) is one form of digital audio signals and is recorded directly onto compact discs and DVDs without compression.

### b. PCM fs=96k

Set a listening mode for the input signal from digital PCM sources recorded with a sampling rate of 96 kHz.

### c. Dolby D (Dolby Digital)

Digital data with AC-3 compression and a maximum of 5.1-channel surround sound. This source signal comes from DVDs and LDs that have the  mark and therefore recorded for 5.1-channel output. This source also comes from digital satellite broadcasts that support Dolby Digital.

#### Dialog norm

Dialogue Normalization (Dialog Norm) is feature of Dolby Digital. When playing back software that has been encoded in Dolby Digital, sometimes you may see a brief message in the front panel display that read Dialog Norm xdB (“x” being a numeric value). Dialogue Normalization serves to let you know if the source material has been recorded at a higher or lower level than usual. For example, if you see the message “Dialog Norm: +4” in the front panel display, to keep the overall output level constant just turn down the volume control by 4dB. In other words, the source material that you are listening to has been recorded 4dB louder than usual. If you do not see a message, then no adjustment of the volume control is necessary.

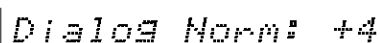

### d. DTS

DTS (Digital Theater System) is compressed digital data with a maximum 5.1-channel surround output that allows for an extremely high-quality sound. This source signal requires a DVD player that supports DTS output and comes from DVDs, compact discs, and LDs that have the  mark.

### f. D.F. 2 ch (Digital Format 2 channel)

2 channel digital signal (except for PCM) such as Dolby Digital. DVD or LD in which the 2 channel sound are recorded may be this type of input signal.

### g. D.F. Mono (Digital Format Monaural)

Monaural digital signal (except for PCM) such as Dolby Digital. DVD or LD in which the monaural sound are recorded may be this type of input signal.

## Listening Modes

### Mono

This mode is for playing old movies whose sound is recorded in monaural or playing left and right channels separately in the movies which contains the different language signals recorded into individual channels. This mode also allows you to listen to the multiplexed soundtracks on DVDs, and other media that have them.

### Direct

This mode delivers pure sound with minimum sound quality adjustment and filtration. The sound recorded for the right and left front channels is output to the right and left front speakers only and not output to the subwoofer.

### Stereo

This mode has all input sound is output from the left and right front speakers.

Subwoofer also can be used for playback.

### T-D (Theater-Dimensional)

For the best enjoyment of your home theater, it is recommended that you have at least front left and right speakers, a center speaker, and surround left and right speakers. However, if you only have front left and right speakers, you can enjoy multichannel audio by using this mode.

This mode controls the characteristics of the sound that reaches each ear to reproduce a multi-speaker setup. To receive the full effect, there is an optimum listening position (sweet spot). Refer to the explanation of the listening angle. In addition, if the reflective sound components are large, it may be difficult to achieve the desired result, so be sure to set up your system and listening position to minimize reflective sound.

### DOLBY PRO LOGIC II

This mode is a new generation 5-channel surround system that provides performance between the 4-channel (left front, right front, center, and monaural surround) Pro Logic Surround and the 5.1-channel Dolby Digital Surround. This mode can be set to the Movie mode designed for playing movies and the Music mode designed for listening to music. In the Movie mode, the surround channels, which used to provide monaural output over only a narrow frequency range, now provide complete stereo output over the full frequency range. The result is movie viewing with a realistic feel of movement. The Music mode uses the surround channels to provide a natural sound space that cannot be provided with normal stereo output.

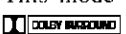
This mode can be used with VHS and DVD videos with the  mark and certain television programs. The Music mode can be used with music compact discs and other stereo sources.

If no surround speakers are connected, then the surround sound is divided and output from the front left and right channels (3 stereo).

### Dolby D (Dolby Digital)

Used for playing Dolby Digital source.

# Input Setup

---

## **DTS Neo:6**

This mode is for 6.1 channel playback of 2 channel sources such as PCM or analog sources. All 6 channel outputs are wide frequency range with a great separation between the different channels.

This mode can be set to the Cinema mode designed for playing movies and the Music mode designed for listening to music.

The Cinema mode is good for movies. Reproduced surround sound makes realistic feel of movement as 6.1 channel sources. This mode can be used with VHS and television programs with stereo sound.

The Music mode uses the surround channels to provide a natural sound space that cannot be provided with normal stereo output. This mode can be used with music compact discs and other stereo sources.

## **DTS**

Used for playing DTS source.

## **DTS-ES Discrete 6.1**

With the addition of the surround back channel, this new format has all 6.1 channels recorded independently for a completely discrete digital format. Since all channels are recorded independently, high-fidelity surround playback with the increased feeling of a separated sound space is achieved.

## **DTS-ES Matrix 6.1**

This format has the surround back channel matrix encoded and inserted into the left and right surround channels so that at playback the output for the left, right, and back surround channels are decoded using a high-precision matrix decoder.

## **THX**

This mode is for playing back sources using THX.

For excellent fidelity when playing back THX sounds, it is recommended to use a THX-certified speaker system.

- **THX Cinema**

This is the conventional 5.1-channel THX format. This mode should be used only when playing back sources that were mixed for playback in large movie theater environments.

- **THX Surround EX**

“THX Surround EX - Dolby Digital Surround EX” is a joint development of Dolby Laboratories and the THX division of Lucasfilm Ltd.

In a movie theater, film soundtracks that have been encoded with Dolby Digital Surround EX technology are able to reproduce an extra channel which has been added during the mixing of the program. This channel, called Surround Back, places sounds behind the listener in addition to the currently available front left, front center, front right, surround right, surround left, and subwoofer channels.

This additional channel provides the opportunity for more detailed imaging behind the listener and brings more depth, spacious ambience, and sound localization than ever before.

When released to the home consumer market, movies that were created using the Dolby Digital Surround EX technology, may have a note to that effect on the packaging. A list of movies created using this technology can be found on the Dolby web site at <http://www.dolby.com> <<http://www.dolby.com>> .

This unit can play the 5.1 ch program in THX surround EX mode, even if the program is not encoded in Dolby Digital Surround EX format. For this kind of program, the sound from surround back channels depends on a program and may not fit to your taste.

## **Mono Movie**

This mode is suitable for playing back monaural recording such as old movie soundtracks. The center channel delivers the unprocessed original sound, whereas the other channels deliver the center-channel sound processed with the appropriate reverberation. This allows you to enjoy monaural sound with the atmosphere of a movie theater.

## **Enhanced 7**

Enhanced 7 intends to reproduce a natural surround environment by using 7-channel speakers. The sound effects moving smoothly toward the surround back. This mode is good for music and TV sports programs.

## **Orchestra**

This mode is appropriate for classical and opera music. The center channel is cut and the surround channels are emphasized to widen the stereo image. It will simulate the natural reverberation that is created in large halls.

## **Unplugged**

This mode is suitable for acoustical instrumental sounds, vocals, and jazz music. By emphasizing the front stereo image, it will simulate the acoustics that you would experience in front of the stage.

## **Studio-Mix**

This mode is for rock and popular music. The lively sounds are enhanced for a powerful acoustic image that simulates the feeling of being in a club or rock concert.

## **TV Logic**

This mode gives realistic acoustics to TV programs that are aired from TV studios. It enhances the entire surround sound and clarity of the conversation.

## **All Ch Stereo**

This mode is designed for playing background music. The front, surround, and surround back channels create a stereo image that encompasses the entire area.

# Audio Adjust

## 3. Audio Adjust Setup menu

Set the various parameters for the sound signals.

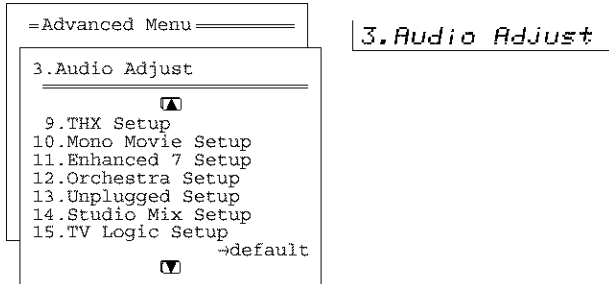
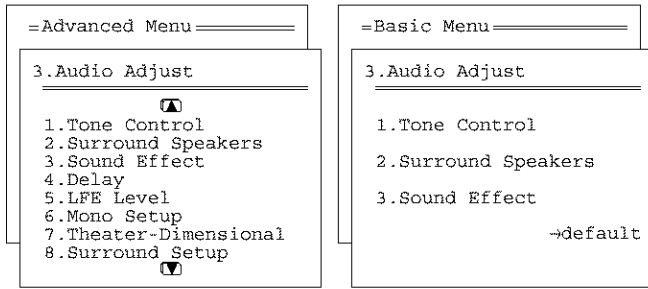

### 3. Audio Adjust

#### 3-1. Tone Control

Separately adjust the bass and treble settings as desired in 2-decibel units.

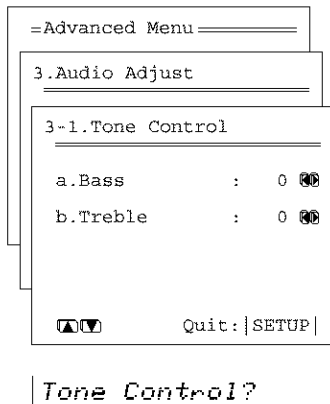

	Parameter	Setting Initial value
a	Bass	-12 to +12 0
b	Treble	-12 to +12 0

#### Note:

If DIRECT or THX is selected as the listening mode, these settings cannot be made. To make these settings, first select another listening mode.

#### 3-2. Surround Speakers

This setting allows you to decide which speakers to output to when surround back speakers are connected and you are playing back a 5.1-channel source.

	Parameter	Setting Initial value
a	Surround Speakers	Surround L/R, Surround Back, Surround L/R Surr L/R + Back

**Surround L/R:** This outputs the sound to the surround left and right speakers as normal and outputs nothing to the surround back speaker.

**Surround Back:** This outputs the sound to the surround back speakers and outputs nothing to the surround left and right speakers.

**Sur L/R+Back:** This outputs the sound to both the surround left and right speakers and the surround back speaker.

#### Note:

If the Surr Back Out setting in the Speaker Config sub menu is set to "1ch," the Surround Speakers sub menu is disabled.

#### 3-3. Sound Effect

Turn on and off the various sound effects.

	Parameter	Setting Initial value
a	RE-EQ	On, Off Off
b	Upsampling	On, Off Off
c	Subwoofer (Ana/PCM)	On, Off On
d	Late Night	Off, Low, High Off

#### a) Re-EQ

Re-EQ (re-equalization) takes the edginess or "brightness" out of your home cinema sound to compensate for the fact that sound mixed for theaters may sound too bright when played back through speakers in the home environment.

This can be set to either "On" or "Off."

This parameter is enabled for listening modes other than the THX, T-D, Direct, PL II Music, or Neo:6 Music listening mode.

#### b) Upsampling

Upsampling processes the input digital signal, or the digital signal converted from an analog input source, and converts its digital sampling frequency to twice its current frequency for an even further detailed sound reproduction. This can be set to either "On" or "Off." When "On" is selected, the UPSAMPLING indicator lights.

#### c) Subwoofer

When "Yes" is selected for the Subwoofer setting in the Speaker Config sub-menu, set this to "Off" if you do not want to have sound output from the subwoofer. This setting is only effective when the input source is Analog/PCM. If "No" is selected for the Subwoofer setting in the Speaker Config sub-menu, then this setting will not appear.

#### d) Late Night

Cinema sound has a vast dynamic range; therefore, to hear the quieter sounds such as human conversations, they must be played back at larger volumes. When this parameter is set to "High" or "Low," the dynamic range of the sound is narrowed down to allow you to easily hear minute sounds at low volumes. This function is especially useful if you wish to play a movie at low volumes during the nighttime.

This can be set to either "Off" or "Low," or "High."

When this parameter is set to High or Low, the dynamic range of the sound is narrowed down to allow you to easily hear minute sounds at low volume.

**Off:** Turns off the Late Night function.

**Low:** Lowers the dynamic range.

**High:** Narrows down the dynamic range.

#### Notes:

- The Late Night function is effective only on Dolby Digital encoded software.
- The depth of the Late Night effect is determined by Dolby Digital software. Some sounds may produce no or little effect.



# Audio Adjust

## 3-4. Delay

This sub-menu gives you various ways to adjust the timing of the audio output from the speakers to give certain soundfield effects or to adjust for unwanted asynchronous video and audio tracks.

This sub-menu does not appear if "Direct" is selected as the listening mode.

	Parameter	Setting Initial value
a	A/V Sync	0.0 ms to 74.0 ms
Relative Delay		
b	Center	-4.0 ms to +6.0 ms
c	Surr L/R	-4.0 ms to +6.0 ms
d	Surr Back	-4.0 ms to +6.0 ms

### a. A/V Sync

If a digital signal processor is connected, there may be times when the audio and video from a DVD or LD player is not output in perfect sync. The result is where the sound and picture do not match and the sound is heard too early. In such a case, use this setting to properly synchronize the audio and video. This setting can be set between 0 to 74.0 ms in 0.5-ms increments. Under normal circumstances, this can be left at 0 ms. If set between 25.0 and 74.0 ms, upsampling is fixed to 24.0 ms. For input sources using the multi channel port, this setting will not appear.

### Relative Delay

#### b. Center, c. Surr L/R, d. Surr Back

Besides level and delay adjustments, the TX-DS797 provides the ability to change or adjust the relative speaker position to fine tune the soundfield for the listener. This is accomplished using Onkyo's unique Enhanced Spatial Positioning Algorithm. This adjustment provides 10 milliseconds of delay for the speakers, which is equivalent to moving the speaker 10 feet (3 meters) away. This adjustment is set up to provide -4.0 or +6.0 milliseconds (-4 or +6 feet/-1.2 or +1.8 meters) of adjustment to the listener's position.

Once the coarse adjustments--speaker level and distance adjustments--are made, the system is set up to provide a typical or broad surround environment. By adjusting the relative position of the speakers, we are able to alter the soundfield to be more spread out (deeper) or focused (shallower).

## 3-5. LFE Level Setup

This sub-menu is for setting the LFE (Low Frequency Effect) levels included in Dolby Digital and DTS software.

	Parameter	Setting Initial value
a	Dolby Digital	-∞, -10 dB to 0 dB
b	DTS	-∞, -10 dB to 0 dB

### a. Dolby Digital

The level can be adjusted to either -∞ or between -10 to 0 decibels in 1-decibel increments. For Dolby Digital input source signals, the LFE level becomes that set here. A setting of 0 decibels is recommended for optimum performance; however, if the low frequency range is too strong, lower this setting as necessary.

### b. DTS

The level can be adjusted to either -∞ or between -10 to 0 decibels in 1-decibel increments. For DTS input source signals, the LFE level becomes that set here. A setting of 0 decibels is recommended for optimum performance; however, if the low frequency range is too strong, lower this setting as necessary.

## 3-6. Mono Setup

The settings shown below are enabled when the listening mode is set to "Mono."

	Parameter	Setting Initial value
a	Academy	On, Off
b	Input Channel	Auto L+R, Left, Right

### a) Academy

Older monaural film mixes relied on high-frequency rolloff in presentation to sound properly balanced, so that excessive hiss from the grain structure of the film would not be heard. The high-frequency loss was typically due to a combination of optical slit loss, electrical filters, loudspeaker response, and screen loss. Some films have been transferred to video without such a high-frequency rolloff, and thus sound overly bright and hissy. This unit includes this "Academy filter," which is based on contemporary playback practices for such films over wide-range systems. This can be set to either "On" or "Off."

### b) Input Channel

This allows you to set which input channel to use for monaural sound.

**Auto L+R:** Select this under normal circumstances.

When the input source is center channel only, this channel is used for monaural sound input channel. Otherwise, left and right channels are mixed and the mixed signal is used for monaural sound input channel.

**Left/Right:** You will need to select either left or right when playing a video source that contains bilingual data. In such a case, the left and right channels will contain different language. Select the channel with the language you desire.

## 3-7. Theater-Dimensional Setup

Select this to modify the Theater-Dimensional (T-D) listening modes. The parameters that can be set are shown in the table below.

	Parameter	Setting Initial value
a	Listening Angle	20 deg, 40 deg
b	Center	On, Off
c	Front Expander	On, Off
d	Virtual Surr Level	-3 dB to +3 dB
e	Dialog Enhance	On, Off

### Theater-Dimensional

For the best enjoyment of your home theater, it is recommended that you have at least front left and right speakers, a center speaker, and surround left and right speakers. However, if you only have front left and right speakers, you can enjoy multichannel audio by using this mode.

This mode controls the characteristics of the sound that reaches each ear to reproduce a multi-speaker setup. To receive the full effect, there is an optimum listening position (sweet spot). Refer to the explanation of the listening angle. In addition, if the reflective sound components are large, it may be difficult to achieve the desired result, so be sure to set up your system and listening position to minimize reflective sound.

# Audio Adjust

## a) Listening angle

The listening angle is the angle subtended by the front left and right speakers as seen from the listener. The setting of 20 and 40 degrees are only for nominal purposes, so select the setting that is closest to your actual listening angle.

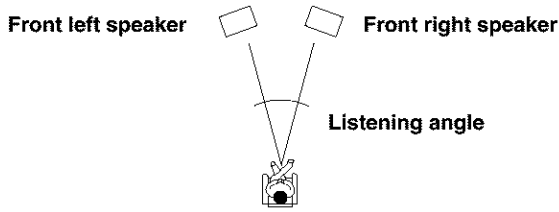

## b) Center

For systems that have a center speaker, the center channel signal can be output from the center speaker. For instance, in systems where the front left and right speakers are small, use of the center speaker may provide a better sound space. (If your system uses a center speaker, be sure to perform the level calibration with the left and right speakers in the Speaker Setup menu beforehand.)

**On:** The center channel signal is output to the center speaker.

**Off:** The center channel signal is output from the front left and right speakers (Phantom Center).

## c) Front Expander

The front expander function spreads out the sound from the front speakers for the feeling of a wide sound space.

**On:** Select to turn on the front expander function to simulate a wider sound space.

**Off:** Select to turn off the front expander function for a normal sound space.

## d) Virtual Surr Level

This parameter adjusts the virtual surround level. This can be set from -3 to +3 decibels.

Lowering this setting can improve the sound when the definition is unclear or when the sound feels unnatural.

## e) Dialog Enhance

This parameter allows you to adjust the dialog sound level from the center speaker if it is difficult to hear.

**On:** Enhances the vocal ranges for the center channel signal.

**Off:** Outputs the center channel signal at the regular level and frequency characteristics.

## 3-8. Surround Setup

Select this to modify the plain Dolby Digital, DTS, and Pro Logic II Surround listening modes. The parameters that can be set are shown in the table below.

	Parameter	Setting Initial value
a	Surr Mode (Analog/PCM)	Pro Logic II Movie Pro Logic II Music DTS Neo:6 Cinema DTS Neo:6 Music
b	Surr Mode (D.F.2ch)	Pro Logic II Movie Pro Logic II Music
c	DTS-ES	Auto, On, Off
<Pro Logic II Music>		
d	Panorama	Off, On
e	Dimension	0, 1, 2, 3, 4, 5, 6
f	Center Width	0, 1, 2, 3, 4, 5, 6, 7

## a) Surr Mode (Analog/PCM)

Changes the surround mode for 2-channel analog/PCM input signals.

## b) Surr Mode (D.F.2ch)

Changes the surround mode for 2-channel digital input signals.

## c) DTS-ES

Selects DTS-ES mode.

**Auto:** When the DTS source has the DTS-ES flag (ID signal for DTS-ES), the listening mode is automatically changed to DTS-ES Discrete 6.1 or DTS-ES Matrix 6.1. If the DTS source has no DTS-ES flag, the mode is changed to DTS 5.1.

**On:** When the DTS source has the DTS-ES flag, the listening mode is automatically changed to DTS-ES Discrete 6.1 or DTS-ES Matrix 6.1. If the DTS source has no DTS-ES flag, the mode is forced to be DTS-ES Matrix 6.1.

**Off:** Even when the DTS source has the DTS-ES flag, the DTS-ES listening modes are not used. The DTS sources are always played in DTS 5.1 mode.

## d) Pro Logic II Music Panorama

Use this listening mode to expand sound space in front of a listener to both side of the listener.

**On:** Turns on the PL II Music Panorama mode.

**Off:** Turns off the PL II Music Panorama mode.

## e) Pro Logic II Music Dimension

Use this listening mode to modify the sound space location forward or backward.

The setting of "3" is the normal position and setting to "2" or lower moves the sound space forward and setting to "4" or higher move the sound space backward.

If the stereo recording has excessive broadness or too strong surroundness, move the sound space forward to get the appropriate sound balance. In contrast, if the stereo recording is somewhat felt like monaural or has narrowness, move the sound space backward to get more surroundness.

## f) Pro Logic II Music Center Width

In Pro Logic II decoding, outstanding center signal will be output only from center speaker. When the center speaker is not used, the decoder divide the center signal equally to each front left and right speakers to create "phantom" center sound image.

The Pro Logic II Music Center Width mode allows you to adjust where the center sound image is heard from. Depending on your setting, the center sound image will be heard from center speaker only, front left and right speakers (as phantom center sound image), or all three speakers (center, front left and right) in various level combinations. For home use, applying some "width" to center signal will improve the level balance for center and main speakers, and effect the width of the center sound image, or "mass" of the sound. Many of sound recordings processed for stereo playback will be reproduced better by controlling the parameter for this listening mode. The recommended setting for Pro Logic II Music mode is "3." This allows you to easily distinguish the Pro Logic II Music mode from the Pro Logic II Movie mode whose setting is automatically set to "0."

# Audio Adjust

## 3-9. THX Setup

Select this Setup THX listening modes; the one that is currently set is the one that is modified. The parameters that can be set are shown in the table below.

	Parameter	Setting	Initial value
a	RE-EQ (THX)	Off, On	On
b	Decoder (Analog/PCM)	PL II, Neo:6	PL II
c	THX Surround (Dolby D)	Off, On	Auto

### a) Re-EQ

Re-EQ (re-equalization) takes the edginess or “brightness” out of your home cinema sound to compensate for the fact that sound mixed for theaters may sound too bright when played back through speakers in the home environment.

This can be set to either “On” or “Off.”

This parameter is only enabled for the THX listening mode. Also, this is set to “On” when the TX-DS797 is turned on.

### b) Decoder

Select the decoding mode for THX processes.

**PL II:** Select for Dolby Pro Logic II Movie.

**Neo:6:** Select for DTS Neo:6 Cinema.

### c) THX Surround EX (Dolby D)

This setting allows you to set whether or not Dolby Digital sources will be played back using THX Surround EX when a surround back speaker is connected.

**Auto:** Automatically outputs signals with EX-identifying signals using THX Surround EX.

**On:** Outputs using THX Surround EX regardless of whether or not the signal contains EX identifiers.

**Off:** Does not output using THX Surround EX regardless of whether or not the signal contains EX identifiers.

## 3-10. 3-11. 3-12. 3-13. 3-14. 3-15.

### Mono Movie Setup/Enhanced 7 Setup/Orchestra Setup/Unplugged Setup/Studio-Mix Setup/TV Logic Setup

When you set the parameters of this sub-menu and select Mono Movie, Enhanced 7, Orchestra, Unplugged, Studio-Mix, or TV Logic as the listening mode, the set parameters become enabled.

	Parameter	Setting	Initial value
a	Front Effect	Off, On	On
b	Reverb Level	Low, Middle, High	Middle
c	Rever Time	Short, Middle, Long	Middle

### a) Front Effect

Some live recordings contain acoustic reverberation. When you play these sources, more reverberation will be applied by the DSP, creating too much reverb effects and the sound loses frame or presence. In this case, set this setting to “Off.” No reverberation from the DSP will be applied to the sound output from the three front channels, so the sound source is be played as it is without any further reverberation.

### b) Reverb Level

This parameter allows you to adjust the depth of acoustic reverberation to match the playback source material, the acoustics of your room, and such other factors.

Select from the three settings “Low,” “Middle,” and “High.”

### c) Reverb Time

Adjust the reverb time to match the source being played back and the acoustics of the room. Select from the three settings “Short,” “Middle,” and “Long.”

## Relationship between listening mode and parameter

Parameter	Tone Control	Subwoofer	Re-EQ	Surround Speakers	Upsampling	LATE NIGHT	LFE Level	Front Effect	Reverb Level	Reverb Time
<b>Listening mode</b>										
Direct										
Stereo	●	●	●		●					
Mono	●	●	●							
Theater-Dimensional	●	●								
Dolby Pro Logic II	●	●	●*1	●	●					
Dolby Digital	●	●	●	●		●	●			
DTS Neo:6	●	●	●*1							
DTS	●	●	●	●			●			
DTS-ES Discrete	●	●	●				●			
DTS-ES Matrix	●	●	●				●			
THX Cinema(PLII)		●	●	●						
THX Cinema(Neo:6)		●	●							
THX Surround EX		●	●				●			
DTS-ES THX Cinema		●	●				●			
Mono Movie	●	●	●	●				●	●	●
Enhanced 7	●	●	●					●	●	●
Orchestra	●	●	●	●				●	●	●
Unplugged	●	●	●	●				●	●	●
Studio-Mix	●	●	●	●				●	●	●
TV Logic	●	●	●	●				●	●	●
All CH Stereo	●	●	●							

The surround given here refers to basic surround modes and consists of Dolby Pro Logic II, Dolby Digital, DTS, etc.

\*1 Enabled for Dolby Pro Logic II Movie and DTS Neo:6 Cinema input sources.

# Preference

## 4. Preference menu

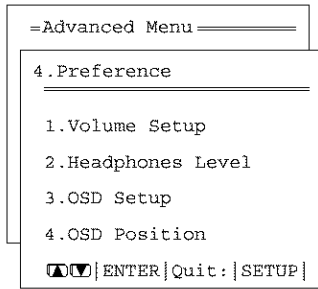

4.Preference

### 4-1. Volume Setup sub-menu

This sub-menu allows you to make various settings concerning the volume control of the TX-DS797.

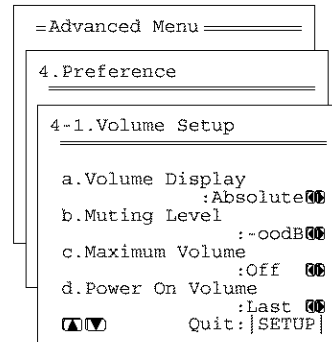

Volume Setup?

#### a. Volume Display

You can choose from two ways of displaying the volume setting on screen.

**Absolute:** This displays the volume with a minimum of min (0) for no sound and a maximum of max (100). As a reference, the volume setting of Ref (82) is used as the 0-decibel for the relative display method.

**Relative:** This displays the volume as a decibel value on a scale with a designated reference point that is displayed as 0, which equals the volume setting of 82 for the absolute display method. With this display method, the minimum value is  $-\infty$ , the next highest is  $-81$ , and the maximum value is  $+18$ .

#### b. Muting Level

This sets the attenuation level during playback when the MUTING button is pressed on the remote controller. This can be set between  $-\infty$ ,  $-50$  and  $-10$  decibels in 10-decibel increments.

#### c. Maximum Volume

This setting allows you to set the maximum volume that can be output with the MASTER VOLUME dial to prevent components from being damaged by excessively loud volumes. For the absolute volume display method, this can be set between 50 and 99. For the relative volume display method, this can be set between  $-32$  and  $+17$  decibels. To not set a maximum volume, select "Off."

#### d. Power On Volume

This sets a designated volume setting for the TX-DS797 to be set every time that the power is turned on. This prevents the TX-DS797 from being turned on while it is set to an extremely high volume and suddenly output very loud sounds. For the absolute volume display method, this can be set between min and max. For the relative volume display method, this can be set between  $-\infty$  and  $+18$  decibels. If you do not mind having the TX-DS797 turned on with its current volume setting, set this to "Last."

# Preference

## 4-2. Headphones Level Setup sub-menu

You can use this sub-menu to adjust the volume output from the headphones so that it matches the level output from the speakers. The headphone volume can be adjusted between -12 and +12 decibels.

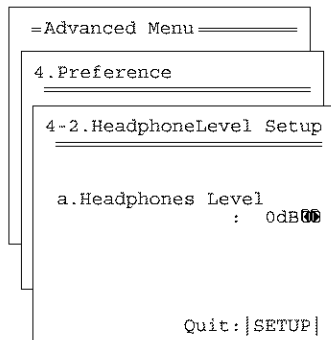

Headphones Lv1?

## 4-3. OSD Setup sub-menu

This sub-menu allows you to customize the OSD Setup menu to display in the manner you desire.

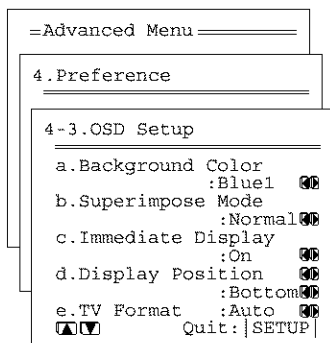

OSD Setup?

### a. Background Color

Select either Blue1, Blue2, Green1, Green2, Magenta, Red1, or Red2 as the background color while the OSD Setup menu is displayed.

### b. Superimpose

**Off:** Select to have the OSD Setup menu displayed on the selected background color.

**Normal:** Select to have the OSD Setup menu superimposed over the current video if one is displayed or on the selected background color if there is no video signal.

**Black:** Select to have the OSD Setup menu displayed on a black background at all times.

### c. Immediate Display

**On:** Select this to have the screen immediately display certain operations as you perform them. The display will remain for a few seconds after the operation is completed.

**Off:** Select this to turn off the immediate display of operations.

### Hint:

If this is set to "Off," the background color will not be displayed even when there is no video signal input.

### d. Display Position

Use this setting to select the position of the immediate display that appears when certain operations are performed. You can position the immediate display at any of ten different levels ranging from the top all the way to the bottom.

### e. TV Format

(For all models other than USA and Canadian models)

The default setting is "Auto," which means that the television format is detected and automatically set by the TX-DS797. However, if you know the correct format, you can use this setting to choose either PAL or NTSC so that no time is wasted on detection.

## 4-4. OSD Position sub-menu

This sub-menu allows you to adjust the position of the OSD Setup menu as it is displayed on your screen. Depending on the monitor used, there may be cases where the OSD Setup menu is not displayed in the center and parts of the menus are cut off. To adjust the position of the OSD Setup menu, simply press the cursor buttons to inch the menu to position you desire.

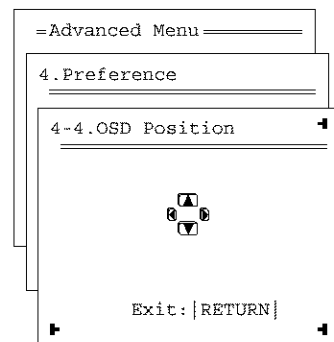

OSD Position?

# Listening to Radio Broadcasts

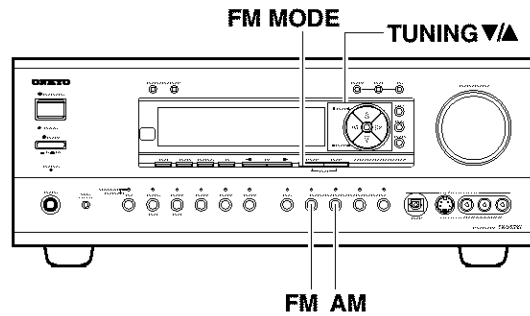

One of the features of the TX-DS797 that is most frequently used is its ability to play FM and AM broadcast radio stations. The TX-DS797 provides a number of listening modes perfect for listening to the radio and getting the most out of your audio system. Also, by presetting radio stations that you listen to frequently, you can select them easily by pressing the CH  $\pm$  button on the remote controller.

## Listening to a stereo radio station (FM mode)

When you tune into a radio station, ► TUNED ◀ indicator appears in the display. If you tune into an FM station in stereo, then “FM STEREO” appears. If the signal is weak, it may be impossible to tune into the station in stereo. In such a case, **press the FM MODE button** on the front panel. The AUTO indication disappears and the radio station is output in the monaural mode. To return to stereo, press the FM MODE button again. “AUTO” appears. Some inter-station noise may be heard, but the sound will not cut in and out as it would if stereo was selected.

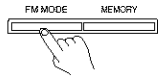

## Tuning into a radio station

1. Press either the AM or FM input source button.
2. Using the TUNING ▲ and ▼ buttons on the front panel, tune into the station you desire.

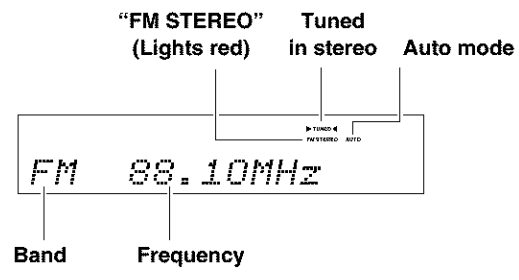
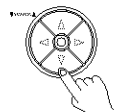
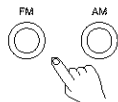

- The tuner frequency changes in 50 kHz increments for FM and 10 kHz increments for AM.
- When tuning into FM stations, you can press the TUNING ▲ or ▼ button continuously for more than 0.5 seconds to scan for an FM station in the direction of the button you pressed (FM auto tuning mode). After you release the button and a station is received in stereo, the scanning stops.
- The European model allows you to receive RDS broadcasts. See pages 48 and 49 for a more detailed explanation.

# Listening to Radio Broadcasts

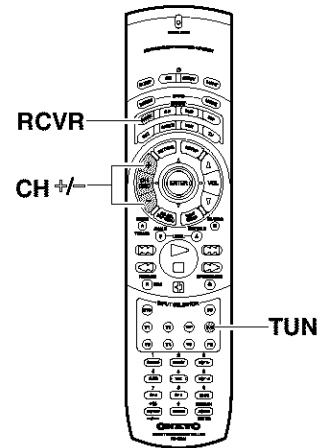
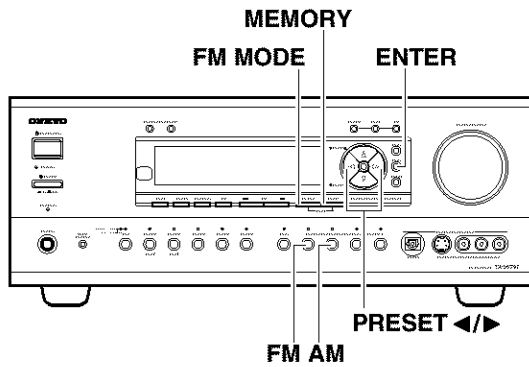

## Presetting a radio station

1. Tune into the radio station you desire (see "Tuning into a radio station").

FM 88.10MHz

2. Press the MEMORY button on the front panel.

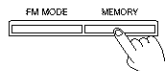

The MEMORY indicator lights red.

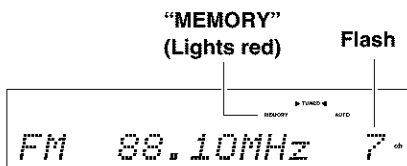

3. Using the PRESET </> buttons, select a preset number (from 1 to 40) to assign the station to be preset.

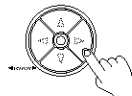

4. Press the ENTER button to finalize the procedure.

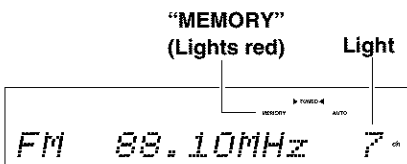

This programs the radio station as a preset radio station.

- Up to 40 stations can be stored in memory as preset radio stations.
- You can enter text names for any of the preset radio stations (see page 36).

## Selecting a preset radio station

1. Press either the AM or FM input source button.

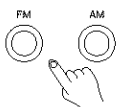

2. Press the PRESET </> buttons and select the number of the desired preset station.

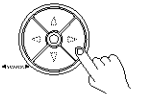

When using the remote controller:

1. Press the RCVR MODE button. The RCVR MODE button lights green.

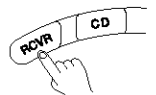

2. Press the TUN button.



3. Press the CH +/- button and select the number of the desired preset station.



## Erasing a preset radio station

This can only be performed at the TX-DS797.

1. Press the AM or FM button and press the PRESET </> buttons to select the preset radio station that you want erase (see above).

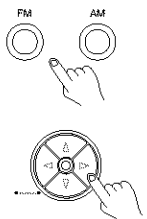

FM 88.10MHz 7

2. Press and hold the MEMORY button and then press the FM MODE button. The selected preset station is erased.

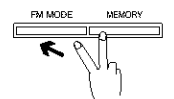

# Listening to RDS broadcasts (European models only)

## Listening to RDS broadcasts

RDS reception is available only on the European model and only in areas where RDS broadcasts are available.

### What is RDS?

RDS stands for Radio Data System and is a type of FM broadcasting. RDS was developed within the European Broadcasting Union (EBU) and is available in most European countries. Many FM broadcasting stations now transmit the RDS signals, which provide the additional information required. RDS provides you with various services so that you can choose a station that broadcasts your favorite categories of music, news, or other information.

There are three main classifications of RDS broadcasts. Though they can be tuned into by using the Tuning buttons as normal stations, RDS broadcasts allow you to scan for stations of the type and classification for which you are looking. This makes it much easier for you to find the station you want (see “Performing a PTY scan” and “Performing a TP scan” on page 49). The three main classifications are explained below.

### RT: Radio Text

When an RDS station broadcasting RT information is selected, the text information received from the station is displayed.

### PTY: Program Type

When an RDS station broadcasting PTY information is selected, the station type (classification) is displayed.

### TP: Traffic Program

When an RDS station broadcasting TP information is selected, traffic information will be broadcasted periodically.

### Notes:

- In some cases, the characters displayed on the display of the TX-DS797 may not be exactly the same as the ones broadcast by the radio station. Also, unusual characters may appear on the display if the TX-DS797 receives characters that cannot be displayed correctly. This is not a malfunction.
- When an RDS station broadcasting PS information is selected, the name of the station is displayed instead of the frequency.

## PTY program types in Europe

The text given in parenthesis is what is actually displayed on the TX-DS797.

### None (NONE):

No program type.

### News reports (NEWS):

Reports on current events and happenings.

### Current affairs (AFFAIRS):

Topical reporting of current affairs, often with a wider range of topics than news reports.

### Information (INFO):

General information such as weather forecasts, consumer affairs, medical help, etc.

### Sport (SPORT):

Live sports action, sports news, and interviews.

### Education (EDUCATE):

Formal educational programs.

### Drama (DRAMA):

Radio plays and serials.

### Culture (CULTURE):

Cultural programs (including religious affairs).

### Science and technology (SCIENCE):

Programs about the natural sciences and technology.

### Varied (VARIED):

Speech-based programs not covered by the above categories (e.g., quizzes, panel games, and comedy).

### Pop music (POP M):

Popular commercial music, usually from past or present sales charts (e.g., Top 40).

### Rock music (ROCK M):

Popular music with an alternative appeal, often not appearing on sales charts.

### Middle of the road music (M.O.R. M):

Easy listening music (as opposed to Pop, Rock, or Classical).

### Light classics (LIGHT M):

Classical music for general rather than specialist appreciation.

### Serious classics (CLASSICS):

Performances of major orchestral works, symphonies, chamber music, etc. (including the Grand Opera).

### Other music (OTHER M):

Music styles not covered by the above categories (e.g., Jazz, Rhythm & Blues, Folk, Country, and Reggae).

### Alarm (ALARM):

When an RDS station is making an emergency broadcast, this ALARM will flash on the display.



# Listening to RDS broadcasts

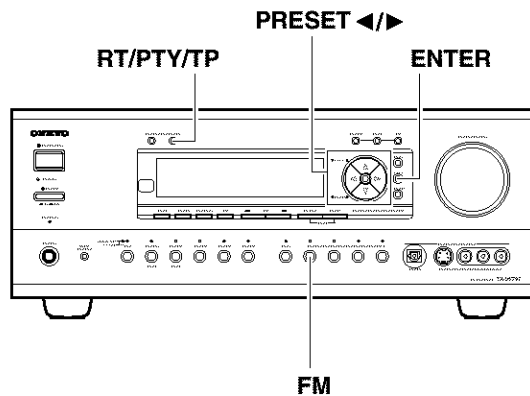

## Displaying Radio Text (RT)

If the station you are currently tuned into is broadcasting RT signals, they will be displayed in the front display on the TX-DS797. If the station does not, this function will be ignored.

**1. To display the radio text, press the RT/PTY/TP button once.**



- If the current station you are listening to is not an RDS station, only the frequency of the station appears.
- If “Waiting” appears on the display, more time is required to receive the RT information. When the information is received, the characters will scroll across the front display.
- If “No Text Data” appears on the display, RT information is not available.
- The display shows the frequency for 3 seconds and returns to program service name.

## Performing a PTY scan

**1. Press the FM input source button.**



**2. Press the RT/PTY/TP button twice.**

The current program type appears on the display.



ROCK M

**3. Using the ◀▶ buttons, select the PTY program type you desire.**

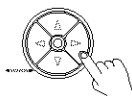

LIGHT M

**4. Press the ENTER button.**

The TX-DS797 will scan until it reaches a station of the program type you selected. It will then stop briefly at that station before continuing on until it reaches the next station. Pressing the ENTER button stops the PTY scan at that point. If you press the RT/PTY/TP while “NONE” is displayed, “PTY ?” will appear. In this case, return to step 3.



**5. Press the ENTER button when it reaches the station that you want to listen to.**

“Not Found” will appear when no RDS signal is being received from the station.



## Performing a TP scan

**1. Press the FM input source button.**



**2. Press the RT/PTY/TP button three times.**



[TP]

“[TP]” will appear if the current station is broadcasting TP signals. This station will periodically broadcast traffic information. To find a different station, proceed to the next step. Also, if “TP” is displayed, proceed to the next step.

**3. Press the ENTER button.**

The TX-DS797 will scan until it reaches a station broadcasting traffic information. If “Not Found” appears on the display, a TP station cannot be located.



# Enjoying music or videos with the TX-DS797

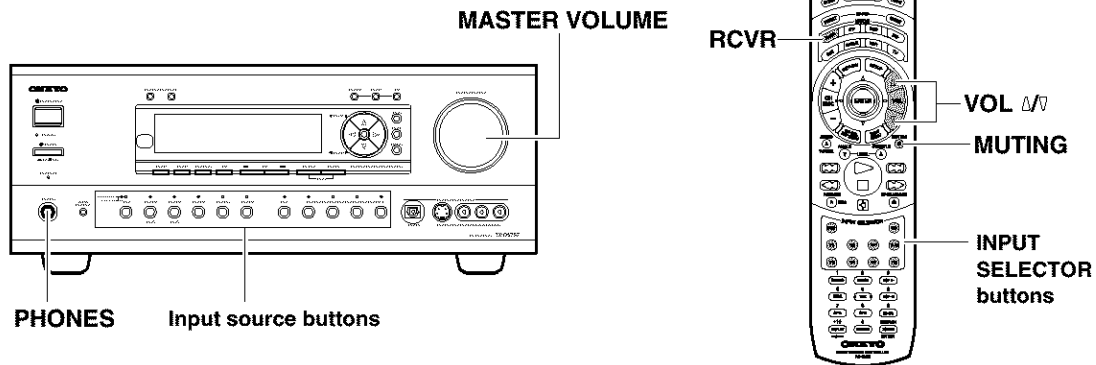

Though the TX-DS797 is often used to listen to the radio, it does not show you its true ability until it is used to play music or watch videos, DVDs, and the like. The TX-DS797 has the latest in state-of-the-art features to play back today's acoustic technologies with the utmost in fidelity and power. From a two-speaker system to a seven-speaker system, you are assured a sound space that you can always enjoy.

## Temporarily turning off the sound

To turn off the sound momentarily, such as when interrupted by a phone call, press the MUTING button on the remote controller. When pressed, "Muting" is displayed on the TX-DS797. Press the MUTING button again to turn the sound back on.

## Basic operation

To use the remote controller, first press the RCVR button.

1. Press the input source (or input selector on the remote controller) button.

TX-DS797

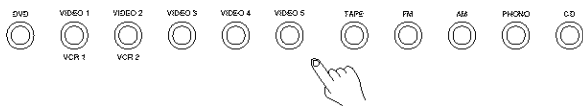

Remote controller

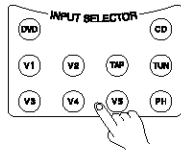

2. Turn on the corresponding component and play the media.
3. Adjust the volume.

TX-DS797

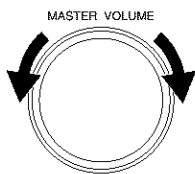

Remote controller



Adjusting the main volume adjusts the volume level output from all the speakers connected to the TX-DS797 together. If headphones are connected, this also adjusts the volume heard from the headphone speakers. To adjust the volume, either press the VOL  $\Delta/\nabla$  buttons on the remote controller or turn the MASTER VOLUME dial. To increase the volume, turn the dial clockwise; to decrease the volume, turn the dial counterclockwise. The volume can be set to Min, 1 to 99, and Max (or  $-\infty$ ,  $-81$  to  $+18$  dB).

Remote controller



## Adjusting the bass and treble

You can adjust the bass and treble levels at the Setup menu: Audio Adjust  $\rightarrow$  Tone Control. This function only affects the front left and right speakers, center speaker, and subwoofer. Only the bass level can be adjusted for the subwoofer (the treble adjustment is not effective). However, these adjustments cannot be made if the listening mode is set to DIRECT.

## Listening with headphones

To listen with headphones, plug a pair of headphones with a standard stereo plug into the PHONES jack on the TX-DS797 front panel. When you connect headphones, the unit will enter STEREO mode automatically and no sound will be heard from the speakers. When the headphones are unplugged, the TX-DS797 returns to its original listening mode. When using the headphones, you can only use the Direct, Stereo, and Mono listening modes. If you have selected MULTI CH INPUT, you will hear sound only from the FRONT L and R channels. The headphone volume level can be adjusted at the Setup menu (see page 45). Note that the signal to the remote zone (Zone 2) will not be affected whether or not headphones are connected.



# Enjoying music or videos with the TX-DS797

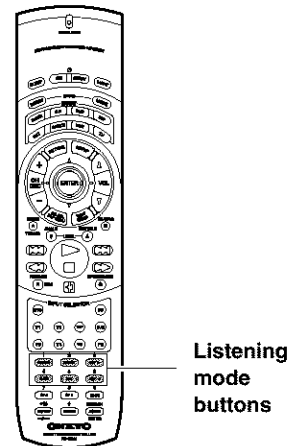
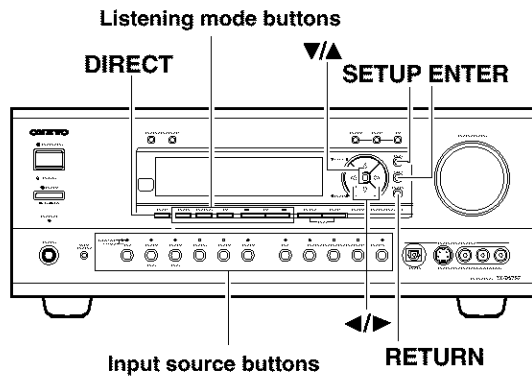

## Changing the listening mode

To change the listening mode during playback, press the listening mode buttons.

The functions of the buttons on the TX-DS797 and those on the remote controller are the same.

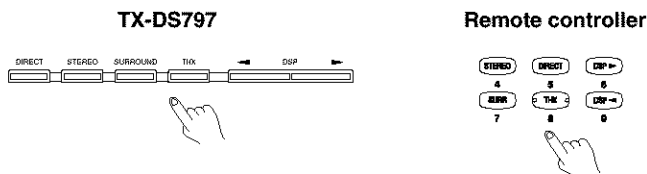

**DIRECT:** Changes the listening mode directly to the Direct listening mode. If pressed, the listening mode for the selected input source set in the Listening Mode Preset is also changed to the Direct listening mode.

**STEREO:** Changes the listening mode directly to the Stereo listening mode. If pressed, the listening mode for the selected input source set in the Listening Mode Preset sub-menu is also changed to the Stereo listening mode.

**SURROUND (Surr):** Changes the listening mode to the surround mode for the current input signal (e.g., Dolby Pro Logic II, Dolby Digital, or DTS). If pressed, the listening mode for the selected input source set in the Listening Mode Preset is also changed to the Surround listening mode.

### When the Surround listening mode is selected

- **When playing back DTS sources**  
Switches the DTS-ES setting from Auto → On → Off.
- **When playing back Analog/PCM sources**  
Switches from Pro Logic II Movie → Pro Logic II Music → DTS Neo6:Cinema → DTS Neo6:Music.
- **When playing back D.F. 2-channel sources**  
Switches from Pro Logic II Movie → Pro Logic II Music.

**THX:** Changes the listening mode to the THX listening mode.

### When the THX listening mode is selected

- **When playing back Dolby Digital sources**  
Switches the THX Surround EX mode (Auto → On → Off) if the source is a Dolby Digital-compatible source.
- **When playing back Analog/PCM sources**  
Switches the decoding mode (Pro Logic II Movie → DTS Neo6:Cinema) for THX processing.
- **When playing back DTS sources**  
Allows you to enjoy the DTS THX Cinema, DTS-ES Discrete 6.1 THX Cinema, and DTS-ES Matrix 6.1 THX Cinema surround systems. The DTS-ES mode changes from Auto → On → Off.

If surround back speakers are not connected, you cannot select THX Surround EX, DTS-ES Discrete 6.1, or DTS-ES Matrix 6.1.

**DSP ◀▶:** Changes the listening mode as shown below.  
Mono → Direct → Stereo → Theater-Dimensional → Surround\* → THX\* → Mono Movie → Enhanced 7 → Orchestra → Unplugged → Studio-Mix → TV Logic → All Ch Stereo → Mono.

If pressed, the listening mode for the selected input source set in the Listening Mode Preset is also changed.

\* The display will differ depending on the format of the current signal.

## Entering names for input sources and tuner stations

You can enter names for your components or radio station names as names for your input sources and have them displayed in the front panel display when that input source is selected. (see page 36)

### Entering characters using the TX-DS797:

1. Press the **SETUP** button.
2. Press the **▼** button to select the “2.Input Setup” menu and press the **ENTER** button.
3. Press the **▼** button to select the “Character Input?” sub-menu and press the **ENTER** button.
4. Press the **▼** button to select “Char: ” and press the **▶** button.
5. The screen changes to show you the characters you have already entered (< >) and then automatically changes to the Character Selection screen (ABCDEF...).  
Press the **▲**, **▼**, **◀**, and **▶** buttons to select the character you desire and press the **ENTER** button. The screen again shows you the characters entered for approximately two seconds and returns you to the Character Selection screen.  
If you enter an incorrect character, press the **RETURN** button to move the cursor to the left and re-enter the character.  
Repeat the above operations to enter up to 10 characters. When you are finished, the entered name appears.
6. Press the **SETUP** button to complete the procedure.

### To correct entered characters

Perform steps 1 to 4 given above. After performing step 4, press the **▶** button to display a name that has already been entered. Press the **ENTER** button to move the cursor to the location of the character that you want to change, enter the new character, and press the **ENTER** button.

### To delete an entered name

Perform the steps 1 to 3 given above. At step 4, press the **◀** button.

# Enjoying music or videos with the TX-DS797

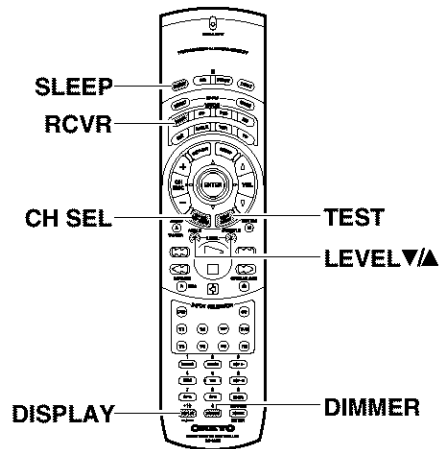
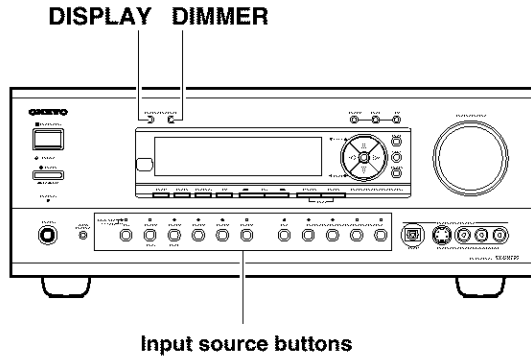

## Switching the display

While listening to or watching an input source, you can display the information regarding the type of source and signal being input by pressing the DISPLAY button on the TX-DS797 or the remote controller.

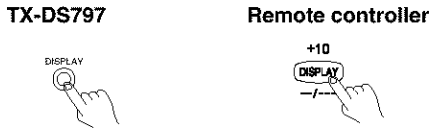

### When an input source other than FM or AM is selected:

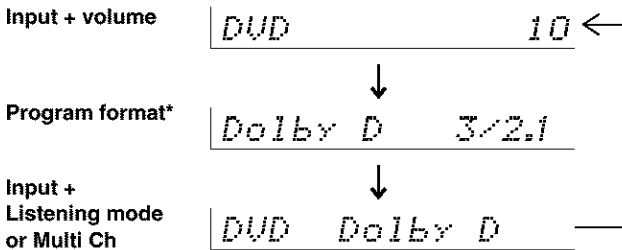

\* If the input signal does not have a program format, then this will be skipped.

### When FM or AM is selected as the input source:

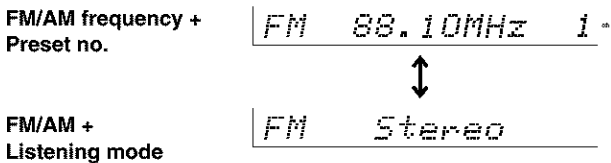

## Adjusting the brightness of the front display

You can adjust the brightness of the front display of the TX-DS797 with DIMMER button on the remote controller or on the TX-DS797 front panel with other than European models.

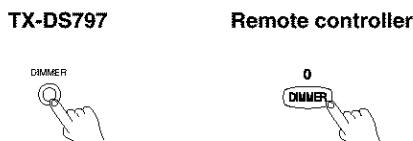

## Using the sleep time (remote controller only)

The SLEEP button enables you to set the TX-DS797 to turn off automatically after a specified time period. If you press it once, the TX-DS797 will turn off after 90 minutes. Each time it is pressed thereafter, the remaining time until the TX-DS797 turns off decreases by 10 minutes. While, the sleep function is enabled, you can press the SLEEP button to see how much time is left. To cancel the sleep function, press the SLEEP button when the time displayed is less than 10 minutes.

If you are using the remote zone (Zone 2), it will turn off at the same time as the main zone. If you want to set the sleep function for Zone 2 only, set the sleep function with main zone turned on and then put the main zone into the standby state.

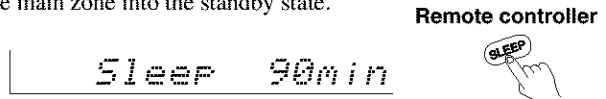

## Temporarily changing the speaker output levels

To change the individual speaker volumes temporarily, follow the procedure given below. Each channel can be set between -12 to +12 decibels. Note that the calibration settings will return to the original settings when the TX-DS797 is put in standby.

1. Press the RCVR MODE button.
2. Press the CH SEL button and select the desired speaker.
3. Press the LEVEL ▲ or ▼ button to adjust the volume level.

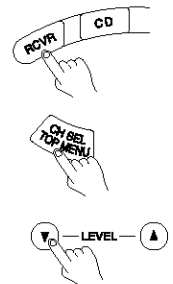

### Notes:

- You cannot select a speaker if the Speaker Config sub-menu of the Speaker Setup is set to No or None.
- If the speaker level is set to +1 dB or higher, the maximum level indicated on the display will change if you raise the volume level.
- When you press the TEST button after you set the level, the current level will be used as the value set via the test tone.

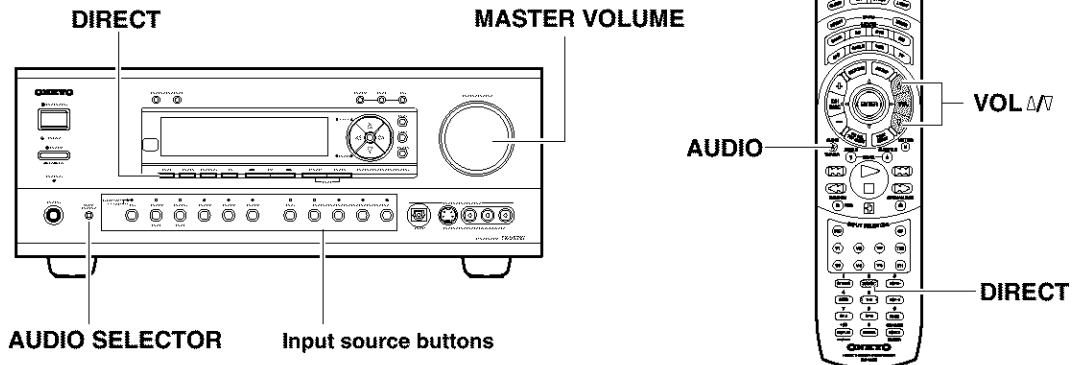

## Changing the audio mode

Press the AUDIO SELECTOR button on the front panel (or AUDIO button on the remote controller) to change the audio mode. Each time the button is pressed, the mode changes from “Auto” → “Multich” → “Analog” and back to “Auto.” The “Auto” audio mode is recommended for normal circumstances.



**Auto (automatic detection):** With this setting, the TX-DS797 automatically detects whether the input signal is digital or analog. When a digital signal is not input, then the analog signal is played.

**Multich (Multichannel):** Select this setting to play back the input from the component connected to the MULTI CHANNEL INPUT port. This setting is effective when the Multichannel setting in the Multichannel sub-menu is set to “Yes” (see page 34).

**Analog:** Select this setting to play back the input from a source component connected to an analog audio input jacks. With this setting, even if a digital signal is input from the same component, only the analog signal will be output.

## Enjoying the multichannel output

Before starting operations, first make sure that the multichannel connection is properly made and that the Multichannel setting of the Input Setup → Multichannel Setup sub-menu to “Yes.”

1. Press the input source button for the component with multichannel output connected to the MULTI CHANNEL INPUT on the rear of the TX-DS797.
2. Select “Multich” using the AUDIO SELECTOR button on the front panel (AUDIO button on the remote controller).



3. Turn on the connected component and start playing the desired media.

4. If necessary, adjust the output level of each speaker as desired (see page 52).

Adjust the speaker output levels so that you can hear the same sound level from each speaker at the listening position. For the front right, front left, center, surround right, and surround left speakers, the output levels can be adjusted between -12 to +12 decibels. The subwoofer can be adjusted between -30 to +12 decibels.

5. Adjust the volume with the MASTER VOLUME dial or the VOL Δ∇ buttons on the remote controller.

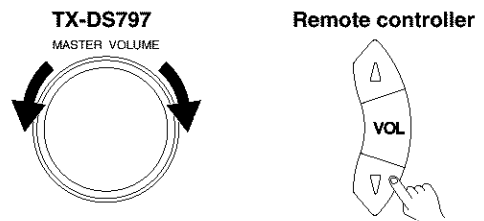

## Using the tone control:

Each time you press the DIRECT button on the remote controller, the display changes from “Direct” → “Tone On.” To make bass and treble adjustment work for multichannel sources, you must first set the tone control to “Tone On.”

1. Press the DIRECT button (or DIRECT button on the remote controller) to display “Tone On.”



When pressed only once, the current setting appears, so press twice to change the setting.

2. Adjust the tone at the Setup menu: Audio Adjust → Tone Control.

## Note:

Adjusting the volume level of each speaker for the MULTI CH INPUT source does not affect the speaker level adjusted by the listening position.

# Enjoying music in the remote zone

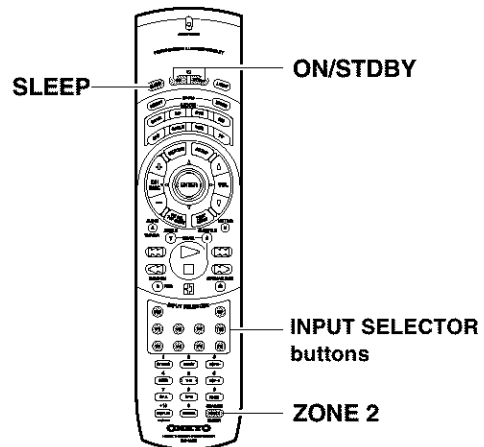
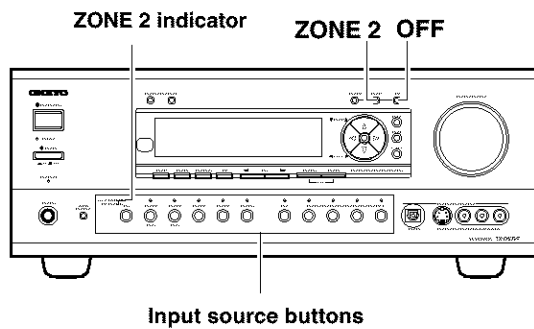

## Playing music using the buttons on the TX-DS797

1. Press the Zone 2 button on the TX-DS797.
2. Select a source.  
After pressing the Zone 2 button, you must press an input source button within 5 seconds. The Zone 2 indicator lights.

Ex.: When the CD button is pressed.

Zone2Sel:CD

To select the same source for the remote zone that is selected for the main zone, press the Zone 2 button again until "Zone2Sel:SOURCE" appears in the display.

Zone2Sel:SOURCE

When "Zone2Sel:Off" is displayed, the output to the remote zone is turned off.

### Notes:

- If a sleep time is set with the SLEEP button, it will also work for the remote zone.
- If the source for the main zone is selected as the source for the remote zone and the source for the main zone is changed, then the source for the remote zone will change as well.
- The Zone 2 terminal is an analog output. Digital signals are not output. If no sound is heard from the selected input source, check if the component is connected to the analog inputs.
- If the REC OUT button is pressed in the main room while someone is using the system in the remote zone, the Zone 2 function will be deactivated and the source will turn off in the remote zone.
- If you select FM (or AM) with the input source buttons when the source for the remote zone (Zone 2) is set to AM (or FM), the output for the remote zone also changes to AM (or FM).
- When you are using the remote zone (Zone 2), **RI** system operation will not work.
- When you are not using the remote zone (Zone 2), press the ZONE 2 button and then press the OFF button to turn off the ZONE 2 indicator.

## Selecting an input source using the remote controller

### Turning on the Zone 2 and putting it in the standby state when the TX-DS797 is in the standby state:

After pressing the ZONE 2 button, press the ON/STDBY button within 5 seconds.



### Selecting an input source:

After pressing the ZONE 2 button, press an input source button within 5 seconds.

If tuner is selected with the TUN button, the CH +/- button becomes enabled.

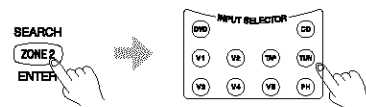

### Notes:

- Adjust the volume for the remote zone at the pre-main amplifier.
- After you press the ZONE 2 button on the remote controller, the STANDBY indicator on the TX-DS797 flashes for five seconds. During this time, you will not be able to perform operations in the main zone using the remote controller.

# Recording a source

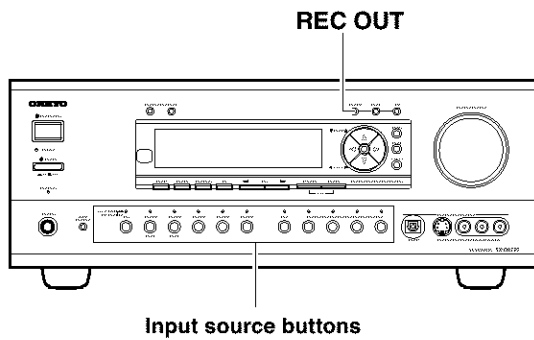

## Notes:

- You cannot record the surround effects.
- Digital signals input to the DIGITAL INPUT (COAX) and DIGITAL INPUT (OPT) inputs will be output to the DIGITAL OUTPUT (OPT) output.
- There are some restrictions on recording digital signals. When making digital recordings, consult the instruction manual that came with your digital recording equipment (e.g., MD recorder or DAT deck) to know what restrictions are imposed.
- You cannot record the source connected to the MULTI CHANNEL INPUT connector.

### To record the input source signal you are currently watching or listening to

This method outputs to the audio and video outputs the currently selected input source signal. This method allows you to a signal while you are actually listening to or watching it.

1. **Select the input source to record by pressing the corresponding input source button.**

The input source is now selected and you may watch or listen to it as desired.

2. **Press the REC OUT button repeatedly until "Rec Sel:SOURCE" appears in the front display.**

The currently selected input source signal to the TAPE OUT,

```
Rec Sel :SOURCE
```

VIDEO 1 OUT, VIDEO 2 OUT outputs for recording.

3. **Start recording at the recording component as desired.**

To confirm the settings, press the Rec Out button. The current settings will appear for 3 seconds in the front display.

### Recording the video from one source and the audio from another:

You can add the sound from one source to the video of another source to make your own video recordings.

Below is an example of recording the sound from a compact disc player connected to CD IN and the video from a video camera connected to VIDEO 5 IN to video cassette tape in a video cassette recorder connected to the VIDEO 1 OUT jack.

1. **Press the CD input source button.**
2. **Set "VIDEO 5" for the Video setting in the Video Setup sub-menu of the Setup menu: Input Setup → Video Setup → Video.**
3. **Insert a CD in the CD player and insert a tape in the video camera connected to the VIDEO 5 IN.**
4. **Insert a video tape for recording in the video cassette recorder connected to VIDEO 1 OUT.**
5. **From this step on, follow the same procedure as described in 2 and 3 above.**

## Notes:

- If you change the input source during recording, you will record the signals from the newly selected input source.
- Digital input signals are only output to the digital outputs and analog input signals are only output from the analog outputs. There is no conversion from digital to analog or vice versa. When connecting CD players and other digital components, do not connect only the digital terminals, but the analog ones as well.

### To record an input source signal different from that you are currently watching or listening to

This method outputs to the audio and video outputs the signal from the input source that you select here. This allows you to record an input source signal different from that which you are listening to or watching at the time of recording.

1. **Press the Rec Out button.**
2. **Within 5 seconds, press the input source selector button of the input source signal that you wish to record.**

The signal from the selected input source will now be output to the TAPE OUT, VIDEO 1 OUT, and VIDEO 2 OUT outputs for recording.

```
Rec Sel :VIDEO3
```

3. **Start recording at the recording component as desired.**

To confirm the settings, press the Rec Out button. The current settings will appear for 5 seconds in the front display.

## Notes:

- Be aware that the remote (Zone 2) and recording (REC OUT) outputs use the same circuit and therefore can be used at the same time.
- If you select FM (or AM) with the input source buttons when the recording source is set to AM (or FM), the output for the recording source also changes to AM (or FM).

# Using remote controller

## Overview

The RC-460M remote controller is a useful tool to help you operate the components of your home theater. To do so, first press the Mode button that corresponds to the device you wish to control. Then simply press the desired operation button and the component will operate accordingly. For example, if you wish to select the CD input source at the TX-DS797 with the remote controller, first press the RCVR MODE button to select the TX-DS797 and then press the CD (INPUT SELECTOR) button.

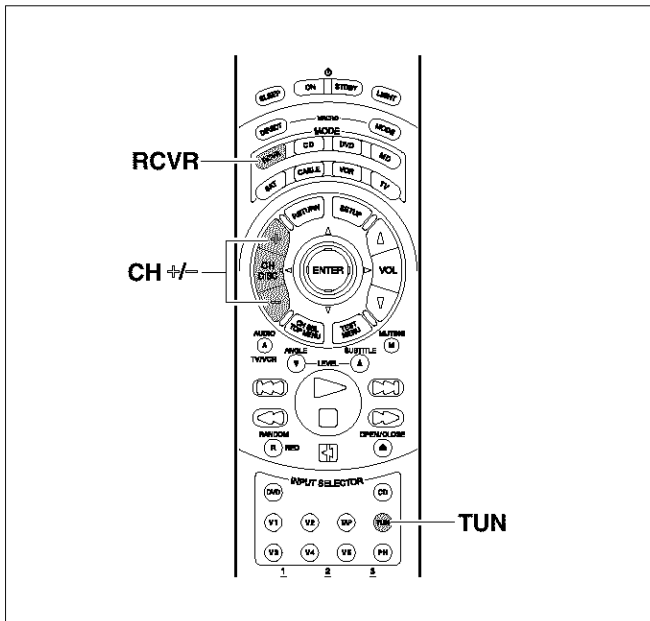

### Calling up a preset radio station

1. Press the RCVR MODE button.  
The RCVR MODE button lights green.
2. Press the TUN input selector button.
3. Press the CH + or - button to select the desired preset station number.

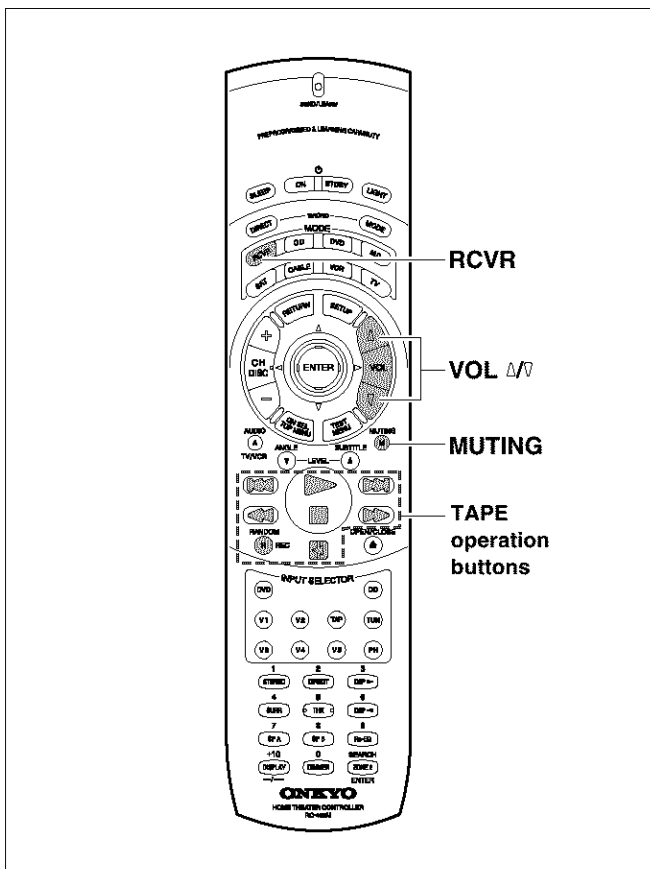

### Controlling an Onkyo cassette tape deck

The **RI** connector of the Onkyo cassette tape deck must be connected to the TX-DS797 (see page 14).

1. Press the RCVR MODE button.  
The RCVR MODE button lights green.
2. Press the desired operation button.  
The buttons shaded in the figure to the left are the operation buttons that can be used to control an Onkyo cassette tape deck.

#### Operation buttons:

- ▷: Play
- : Stop
- ◀: Rewind
- ▶: Fast forward
- ⏮: Press during playback to skip to the beginning of the next track.
- ⏪: Press during playback to skip to the beginning of the current track.

**R (Rec):** Record/Pause

⏮: Reverse playback

You may also use the following buttons:

**VOL Δ/V:** Adjusts the volume at the TX-DS797

**MUTING:** Activates the muting function at the TX-DS797

#### Note:

Even for devices with the ⏮ and ⏪ buttons, signal discrepancies may cause them not to work properly.



# Using remote controller

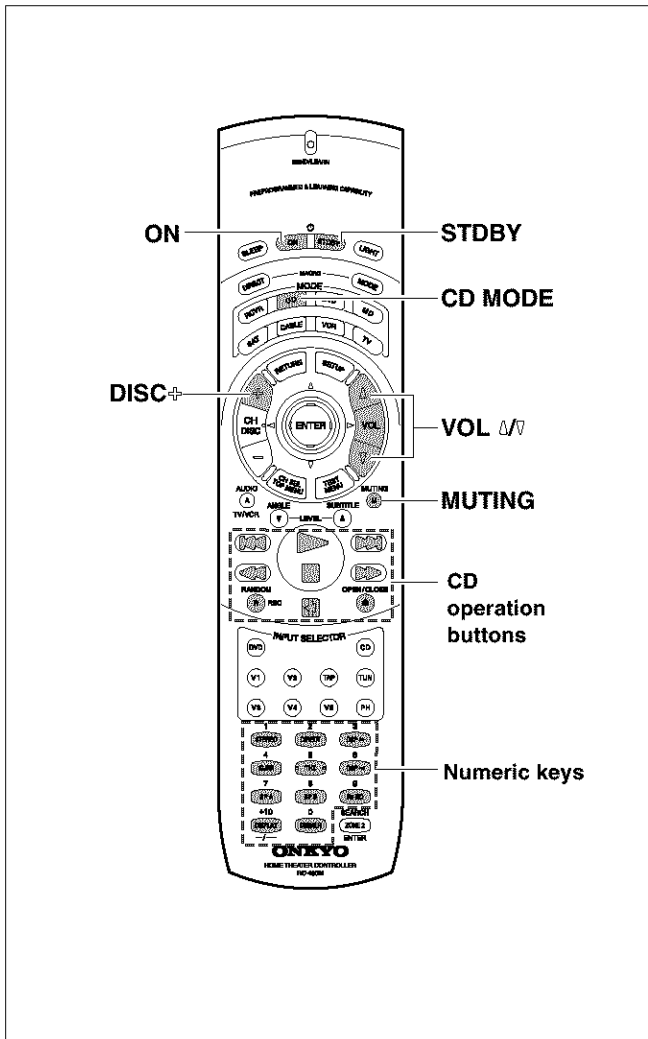

## Controlling an Onkyo CD player

The **RI** connector of the Onkyo compact disc player must be connected to the TX-DS797 (see page 14).

- 1. Press the CD MODE button.**  
The CD MODE button lights green.
- 2. Press the desired operation button.**  
The buttons shaded in the figure to the left are the operation buttons that can be used to control an Onkyo compact disc player.

- Operation buttons:**
- ON:** Turns on and off the compact disc player (same as **STDBY** button on the remote controller).
  - DISC +:** Selects a disc in the CD changer
  - ⏮:** Track down
  - ⏪:** Track up
  - ▶:** Play
  - ⏹:** Stop
  - ⏮:** Fast reverse
  - ⏭:** Fast forward
  - ⏸:** Pause
  - OPEN/CLOSE ⏶:** Open/close the disc tray
  - 0, 1 to 9, +10:** Numeric keys
  - RANDOM/R:** For random playback.
- You may also use the following buttons:
- VOL +/-:** Adjusts the volume at the TX-DS797
  - MUTING:** Activates the muting function at the TX-DS797

## Controlling an Onkyo DVD player

The **RI** connector of the Onkyo DVD player must be connected to the TX-DS797 (see page 14).

### 1. Press the DVD MODE button.

The DVD MODE button lights green.

### 2. Press the desired operation button.

The buttons shaded in the figure to the left are the operation buttons that can be used to control an Onkyo DVD player.

#### Operation buttons:

**ON:** Turns the DVD player on and off

**STDBY:** Turns the DVD player off. (Some sets may not respond to this button. In this case, use the ON button to put the DVD player in the standby state.)

**SETUP:** Displays the menu

**Δ/∇/◀/▶:** Moves the cursor

**ENTER:** Confirms the selection

**RETURN:** Return button

**TOP MENU or MENU:** Displays the menu screen(s) recorded on DVD media.

**DISC +/-:** Selects a disc in the DVD changer.

**AUDIO:** Press repeatedly to select an audio and/or language track recorded on a DVD-Audio/Video.

**ANGLE:** Press repeatedly to select a camera angle when a DVD-Video is recorded with multiple angle playback.

**SUBTITLE:** Press repeatedly to select one of the subtitle languages recorded on a DVD-Video.

**SEARCH:** Press to find the specific section on a disc where you want to start playback.

**RANDOM/R:** Press to start random playback.

**⏮:** Chapter/Track down

**⏭:** Chapter/Track up

**▶:** Play

**⏹:** Stop

**⏪:** Fast reverse

**⏩:** Fast forward

**⏸:** Pause

**OPEN/CLOSE ▲:** Open/close the disc tray

**0, 1 to 9, +10:** Numeric keys

You may also use the following buttons:

**VOL Δ/∇:** Adjusts the volume at the TX-DS797

**MUTING:** Activates the muting function at the TX-DS797

#### Note:

When operating an Onkyo DVD player directly with the remote controller without connecting the **RI** terminals, pre-programming is necessary (see page 60).

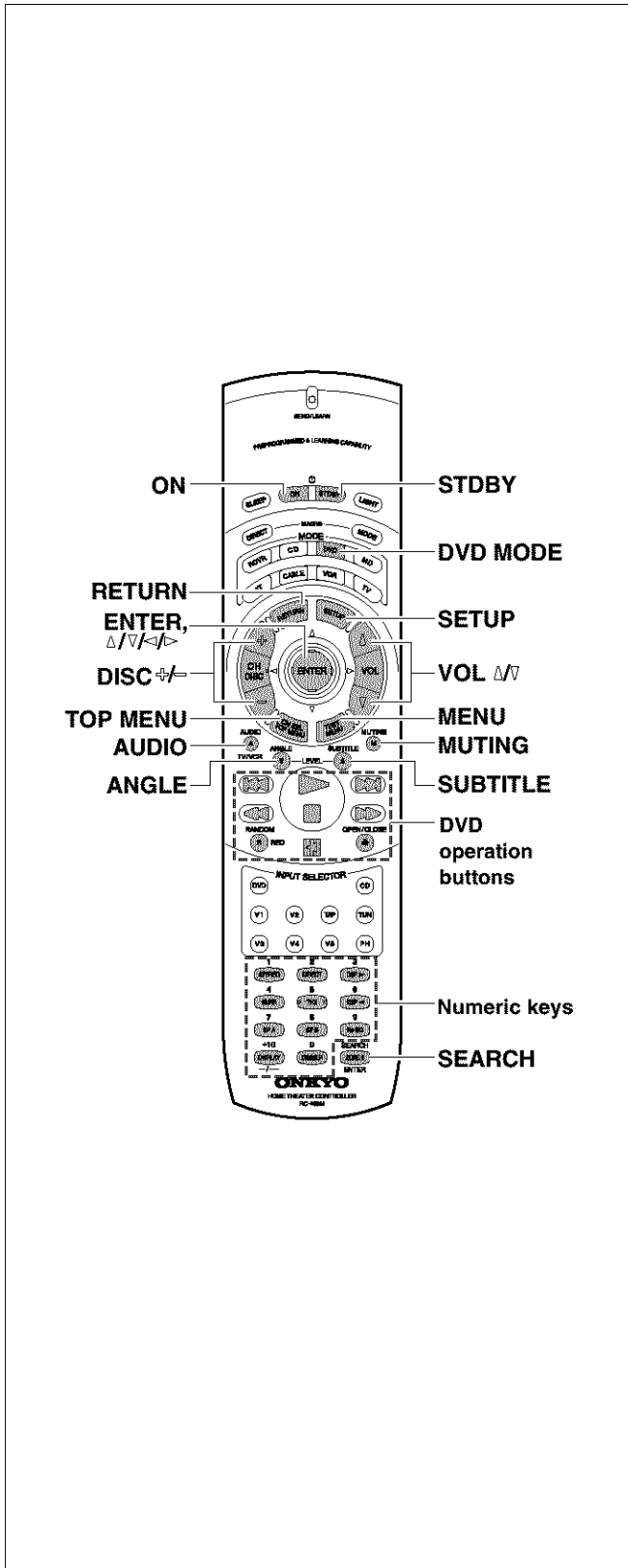

# Using remote controller

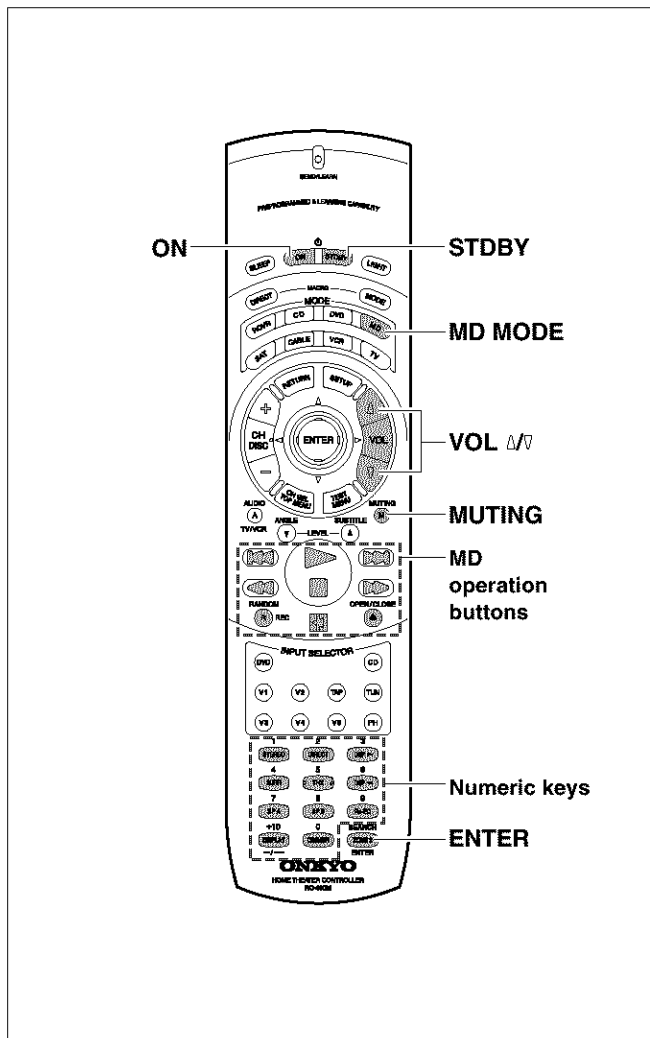

## Controlling an Onkyo MD recorder

The **RI** connector of the Onkyo MD recorder must be connected to the TX-DS797 (see page 14).

### 1. Press the MD MODE button.

The MD MODE button lights green.

### 2. Press the desired operation button.

The buttons shaded in the figure to the left are the operation buttons that can be used to control an Onkyo MD recorder.

#### Operation buttons:

**ON:** Turns on and off the MD player (same as **STDBY** button on the remote controller).

: Track down

: Track up

: Play

: Stop

: Fast reverse

: Fast forward

**R (Rec):** Record

: Pause

: Eject the disc

**1 to 9, 0, --/--:** Numeric keys

**ENTER:** Enters the settings

You may also use the following buttons:

**VOL** : Adjusts the volume at the TX-DS797

**MUTING:** Activates the muting function at the TX-DS797

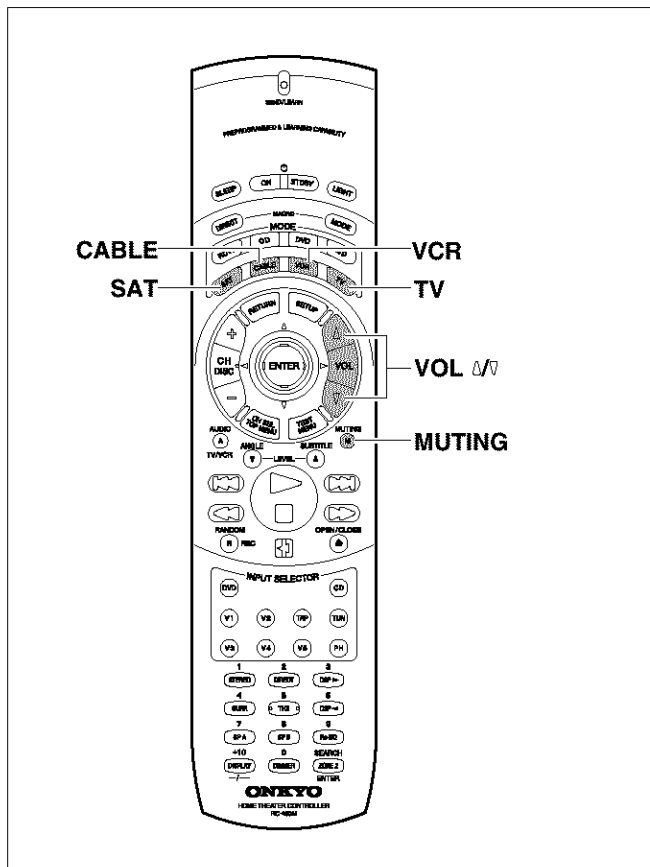

## SAT, CABLE, VCR, and TV MODE buttons

No preset codes are programmed into the SAT, CABLE, VCR, and TV MODE buttons. You can use these buttons to program the remote controller signals of other devices.

There are two methods. One method is selecting the name of a different brand from the table, entering the setting number listed, and calling up the pre-programming code (see page 61). The other method is learning the commands from the other brand's remote control directly into this remote controller (see page 64).

When in the SAT, CABLE and VCR mode, you may use the following buttons:

**VOL** : Adjusts the volume at the TX-DS797

**MUTING:** Activates the muting function at the TX-DS797

# Learning a pre-programming code

The remote controller has three learning functions. One is entering the signal number for a remote controller of another brand that is pre-programmed. Another is a normal learning function that enables the remote controller to learn the codes from other remote controllers. And the last is a macro learning function that enables you to program a series of operations into the remote controller so that the operations can all be performed at once by pressing one button.

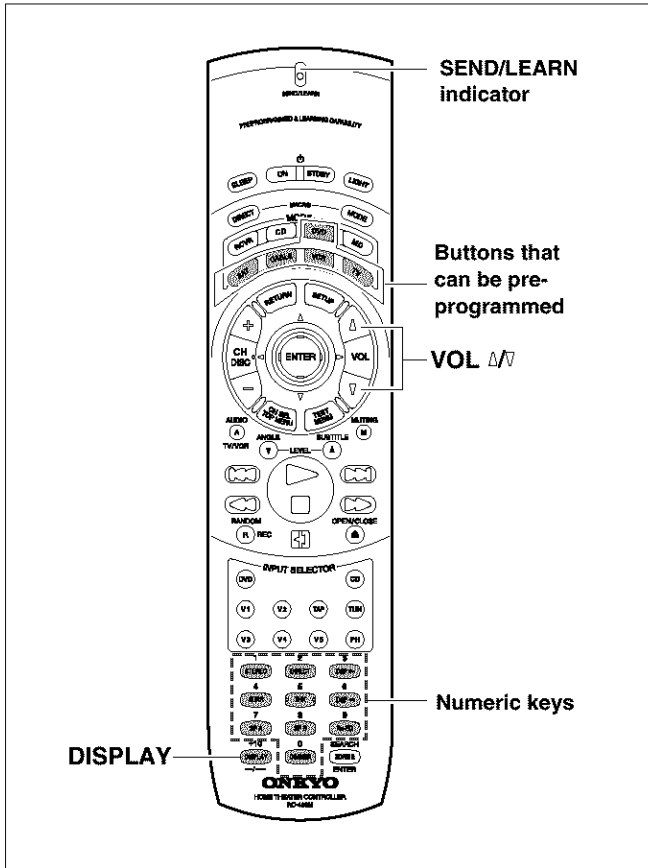

**Caution**  
With some brand's components, some buttons may not work correctly. In this case, program the command separately.

## Learning a pre-programming code

By learning a pre-programming code, you can make the RC-460M remote controller able to operate a product from another brand. The buttons that are used for operation are given on the next page.

1. Find the 3-digit number for the brand name of the component that you want to operate in the table on the next page.
2. Turn on the component that you want to operate (i.e. DVD, satellite tuner, or television).
3. While holding down the MODE button on the RC-460M that you want to program, press the DISPLAY button, and then release both buttons.

The SEND/LEARN indicator lights when the MODE button is pressed and turns off when the DISPLAY button is pressed. Wait until the indicator turns off before releasing both buttons. Then the SEND/LEARN indicator lights again.

4. Within 30 seconds, enter the 3-digit code number.  
The SEND/LEARN indicator flashes twice slowly. If the SEND/LEARN indicator quickly flashes three times, then either a mistaken 3-digit code was entered or an incorrect operation was performed. If this occurs, return to step 3.

5. Press the button that you programmed and check if the system operates correctly.
  - If the component does not operate properly, return to step 3 and repeat the steps above.
  - If it still does not operate properly, then program the commands one by one to the buttons on the RC-460M remote controller.

**When entering the code of Onkyo DVD players:**  
There are three SETTING numbers. Choose the SETTING number according to how you will be using the DVD player.

**No. 601/613:** These codes are for operating the Onkyo DVD player by pointing the remote controller directly at it, either because it does not have an **RI** terminal, or it does but you are not using an **RI** cable and connecting it. First enter 601 and if it does not operate properly, enter 613.

**No. 600:** This code is for Onkyo DVD players that have an **RI** terminal that you are connecting to the TX-DS797 with an **RI** cable. You will then operate the DVD player by pointing the remote controller at the remote control sensor on the TX-DS797. You do not need to enter this code because it is factory preset. However, if the code has been changed to 601 or 613, then you will need to change it back to 600.

# Learning a pre-programming code

## Pre-programming codes

### Note:

If more than one code is given in the table, try the code one by one until you reach the code for your component (i.e. if the first code does not work, then try the next).

### DVD

BRAND	SETTING No.
DENON	602, 609
HITACHI	603
JVC	604
KENWOOD	605
MAGNAVOX	606, 613
MARANTZ	607
MITSUBISHI	608, 613
ONKYO	600, 601, 613
PANASONIC	609
PIONEER	610
PROSCAN	611
RCA	611
SONY	612
TOSHIBA	613
YAMAHA	609, 614
ZENITH	613, 615

### SAT

BRAND	SETTING No.
ECHOSTAR	700
GENERAL INSTRUMENTS	701
HITACHI	702
HUGHES NETWORK SYSTEMS	703
PANASONIC	704
PRIMESTAR	705
PROSCAN	706, 707
RCA	706, 707
SONY	708
TOSHIBA	709

### CABLE

BRAND	SETTING No.
GENERAL INSTRUMENTS	500
GEMINI	501
HAMLIN	502, 503, 504, 505
JERROLD	500, 506, 507, 508, 509, 510, 511, 512, 513, 514
MACOM	515, 516, 517
MAGNAVOX	518
OAK	519, 520, 521
PANASONIC	522, 523
PHILIPS	524, 525, 526, 527, 528, 529
PIONEER	530, 531
SCIENTIFIC ATLANTA	532, 533, 534
SAMSUNG	535
TOCOM	536
ZENITH	537, 538

### VCR

BRAND	SETTING No.
AIWA	300, 301, 302
AKAI	303, 304, 305, 306, 307
BAIRD	308
BELL & HOWELL	309
BLAUPUNKT	310
CGM	311, 312, 313
COLTINA	314
DAEWOO	315, 316
DIGITAL	317
EMERSON	318, 319, 320, 321, 322
FENNER	323
FISHER	324, 325, 326, 327
FUJITSU GENERAL	328
FUNAI	329
GE	330, 331
GO VIDEO	332, 336, 337
GOLDSTAR	333, 334
GOODMANS	335
GRUNDIG	338
HITACHI	339, 340, 341
JVC	342, 343, 344, 345, 346, 347, 348, 349, 350
LOEWE	351, 352
MAGNAVOX	353, 354, 355
MITSUBISHI	356, 357, 358, 359, 360, 361, 362, 363, 364
NEC	365, 366, 367
NOKIA	313
NORDMENDE	368, 369, 370
OKANO	371, 372
ORION	319, 373
PANASONIC	374, 375, 376, 377, 378
PHILIPS	353, 379, 380
PHONOLA	311
PIONEER	381
RCA	382
SABA	383
SAMSUNG	384, 385, 386, 387, 388, 389, 390
SANYO	391, 392, 393
SCOTT	394
SELECO	395
SHARP	396, 397, 398, 399
SHINTOM	400
SIEMENS	401
SONY	402, 403, 404, 405, 406, 407, 408, 409, 410, 411, 412, 413
SYMPHONIC	414
TEKNIKA	414, 415
TELEFUNKEN	416, 417
TOSHIBA	418, 419, 420
WHITE WESTINGHOUSE	333
WATSON	421
ZENITH	422

### TV

BRAND	SETTING No.
AIWA	100, 101
AKAI	102, 103, 104
AUDIOSONIC	105
BELL & HOWELL	106
BLAUPUNKT	107
BRIONVEGA	108, 109
CENTURION	110
COLTINA	111, 112, 113
CORONAD	114
CROWN	115, 116
DAEWOO	117, 118, 119, 120, 121
DUAL	122
EMERSON	123, 124, 125, 126, 127
FENNER	128, 129
FERGUSON	130, 131
FISHER	132
FUNAI	133, 134, 135
FUJITSU GENERAL	136, 137, 138
GE	139, 140, 141
GOLDSTAR	142, 143
GOODMANS	144
GRUNDIG	145, 146
HITACHI	147, 148, 149, 150
HYPER	151
INNO HIT	152
IRRADIO	103
JVC	153, 154, 155, 156, 157
KENDO	158
KTV	159, 160
LUXOR	161
MAGNAVOX	162, 163
MARANTZ	164
MARK	165
MATSUI	166, 167, 168, 169
MITSUBISHI	170, 171, 172, 173
MIVAR	174, 175
NEC	176, 177
NOKIA	178, 179, 180, 181
OCEANIC	181
NORDMENDE	182, 183
OKANO	152
ORION	184, 185, 186
PANASONIC	187, 188, 189, 190
PHILIPS	152, 162, 191
PIONEER	192, 193
PROSCAN	194
QUASAR	195
RADIO SHACK	196
RCA	110, 141, 197, 198, 199, 200
SABA	182, 183, 201
SAMSUNG	202, 203, 204, 205, 206, 207, 208
SANYO	209, 210, 211, 212
SCHNEIDER	103
SEARS	213
SELECO	214, 215
SHARP	216, 217
SONY	218, 219, 220, 221, 222, 223
SYMPHONIC	224, 225
TELEFUNKEN	201, 226, 227
THOMSON	228
TOSHIBA	213, 229
UNIVERSUM	230
ZENITH	231, 232

# Operating your programmed remote controller

After performing the procedure given above, the following modes become enabled for use.

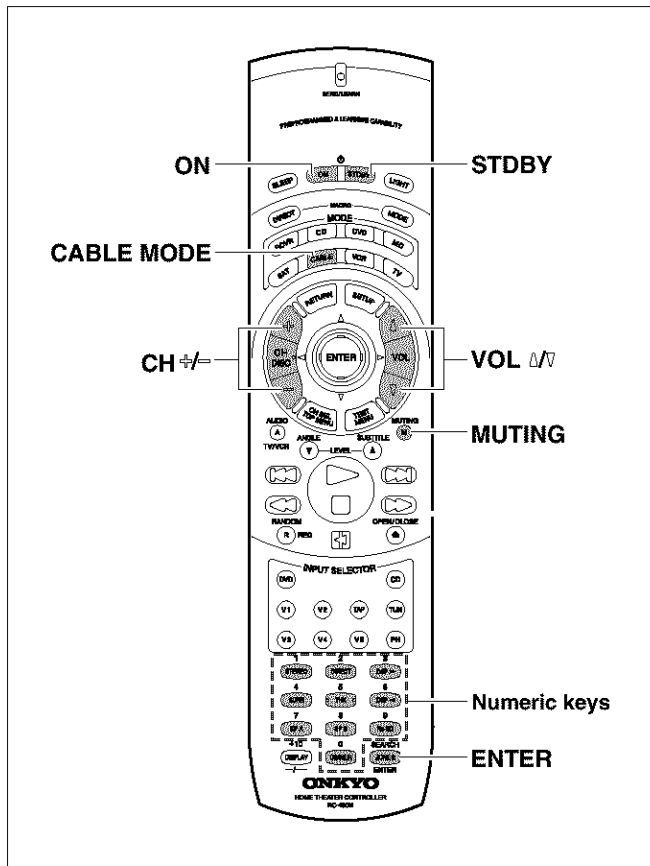
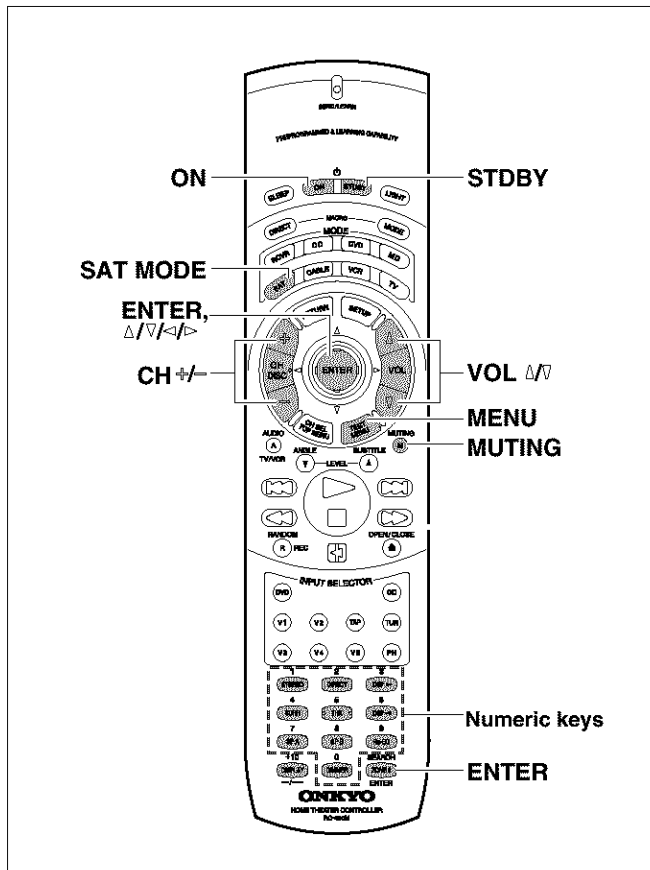

## DVD MODE (DVD Player Mode)

Buttons with programmed usage and operations are the same as the operational buttons on page 58.

## SAT MODE (Satellite Tuner Mode)

1. Press the **SAT MODE** button.

The SAT button lights green.

2. Press the **desired operation button**.

The buttons shaded in the figure to the left are the operation buttons that can be used to control your satellite tuner unit.

**The buttons given below have operations programmed into them.**

**ON:** Turns on and off the satellite tuner unit (same as **STDBY** button on the remote controller)

**CH +/-:** Moves up and down the preset channel numbers

**Δ/∇/◀/▶:** Moves the cursor

**ENTER:** Confirms the selection

**MENU:** Displays the menu

**0,1 to 9:** Numeric keys

**ENTER:** Confirm

You may also use the following buttons:

**VOL Δ/∇:** Adjusts the volume at the TX-DS797

**MUTING:** Activates the muting function at the TX-DS797

## CABLE MODE (Cable Mode)

1. Press the **CABLE MODE** button.

The CABLE button lights green.

2. Press the **desired operation button**.

The buttons shaded in the figure to the left are the operation buttons that can be used to control your cable TV unit.

**The buttons given below have operations programmed into them.**

**ON:** Turns on and off the cable TV unit (same as **STDBY** button on the remote controller)

**CH +/-:** Moves up and down the preset channel numbers

**0,1 to 9:** Numeric keys

**ENTER:** Confirm

You may also use the following buttons:

**VOL Δ/∇:** Adjusts the volume at the TX-DS797

**MUTING:** Activates the muting function at the TX-DS797

# Operating your programmed remote controller

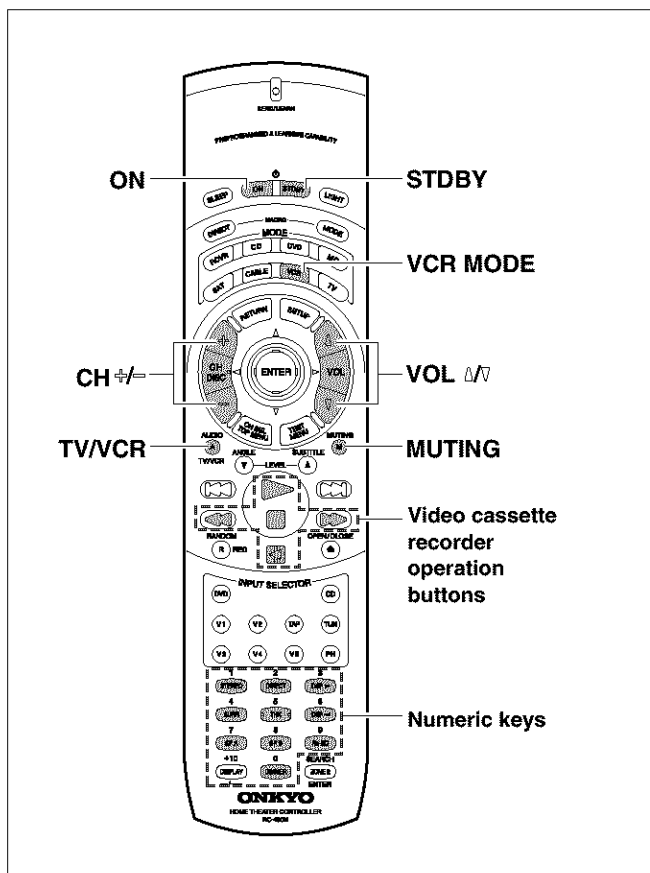

## VCR MODE (VCR Mode)

1. Press the **VCR MODE** button.  
The VCR button lights green.
2. Press the **desired operation button**.  
The buttons shaded in the figure to the left are the operation buttons that can be used to control your VCR.

The buttons given below have operations programmed into them.

**ON:** Turns on and off the VCR (same as **STDBY** button on the remote controller)

**CH +/-:** Moves up and down the preset channel numbers

**TV/VCR:** Switches the AV input for the VCR

▶: Play

□: Stop

◀◀: Rewind

▶▶: Fast Forward

⏸: Pause

**0,1 to 9, +10:** Numeric keys

You may also use the following buttons:

**VOL +/-:** Adjusts the volume at the TX-DS797

**MUTING:** Activates the muting function at the TX-DS797

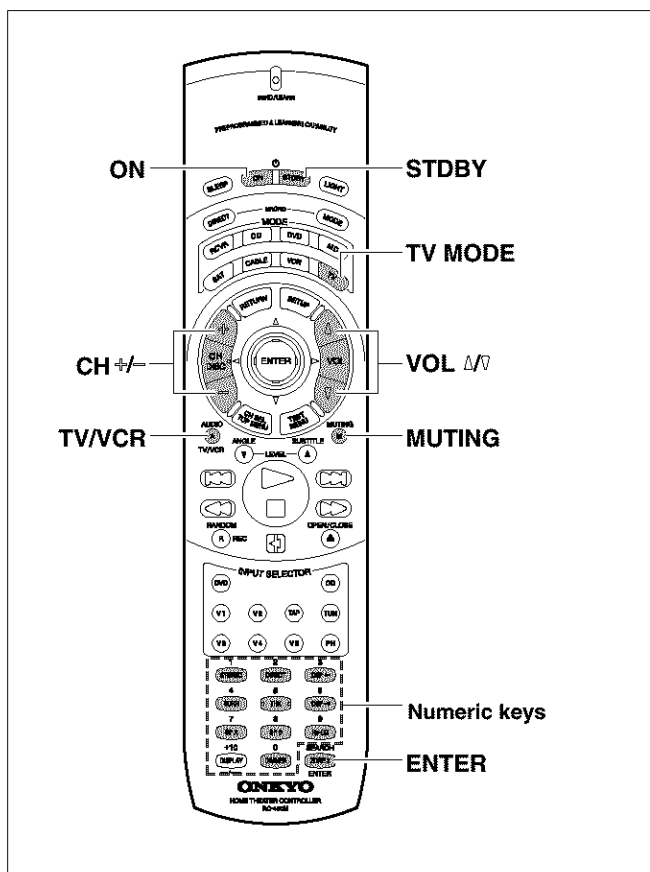

## TV MODE (TV Mode)

1. Press the **TV MODE** button.  
The TV button lights green.
2. Press the **desired operation button**.  
The buttons shaded in the figure to the left are the operation buttons that can be used to control your television.

The buttons given below have operations programmed into them.

**ON:** Turns on and off the television (same as **STDBY** button on the remote controller)

**CH +/-:** Moves up and down the television channels

**TV/VCR:** Switches the TV/VCR input for the television

**0,1 to 9, +10:** Numeric keys

**ENTER:** Confirm

**VOL +/-:** Adjusts the volume at the television

**MUTING:** Activates the muting function at the television

# Programming the commands of remote controllers for other devices into the remote controller

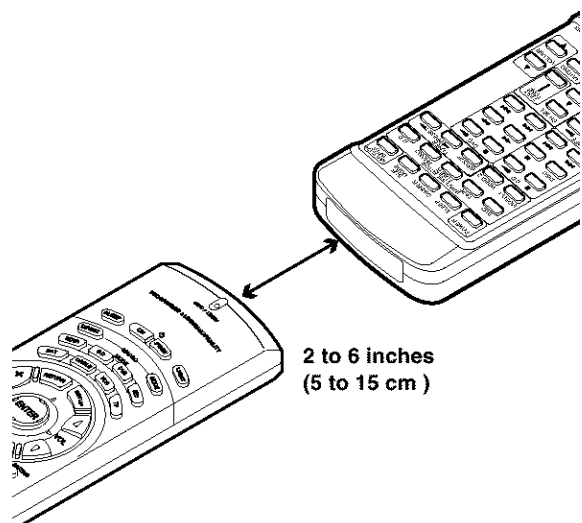

## Programming procedure

When programming the commands of another remote controller to the RC-460M remote controller, you must first decide under which MODE button you want the commands to be linked. In general, you will select the MODE button that corresponds to the component you are programming. For example, if you are programming the functions from a remote controller for a compact disc player, you would choose the CD MODE button. Then, by pressing the CD MODE button, the buttons on the RC-460M remote controller will change to the commands you program here to operate the compact disc player.

After programming which MODE button to use, you will then transfer the separate commands from the other remote controller over to the RC-460M remote controller one at a time. Each command is then programmed to a different button on the RC-460M remote controller. Any button is programmable for this step except for the eight MODE buttons (RCVR, CD, DVD, MD, SAT, CABLE, VCR, and TV), the two MACRO buttons (DIRECT and MODE), and the LIGHT button.

Even after the commands have been memorized, keep your old remote controller in a safe place. If for some reason the commands are lost (e.g., when the batteries run down), it will be necessary to memorize them once again.

**1. Place the remote controller and the remote controller for the other device facing each other at a distance of 2 to 6 inches (5 to 15 cm) apart.**

**2. While pressing and holding down the desired MODE button on the remote controller, press the ENTER button and then release both buttons.**

When you press and hold down the MODE button, the SEND/LEARN indicator lights. When you press the ENTER button, the lamp turns off. When you release the buttons, the lamp lights again.

**3. Press and release the button on the remote controller to which you want to transfer the next command.**

You may select any button but the eleven ones indicated in the figure below. When you press the button, the SEND/LEARN indicator turns off. When you release the button, the indicator lights again.

If you press the wrong button by mistake, press that same button again. The SEND/LEARN indicator flashes twice, and the remote controller exits the programming mode.

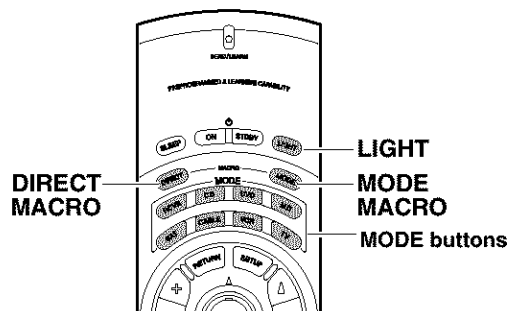
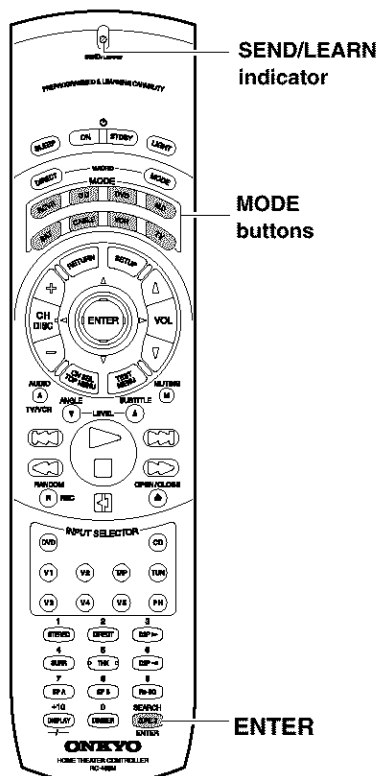

■ : Buttons that cannot be programmed.



# Programming the commands of remote controllers for other devices into the remote controller

---

- 4. Press and hold down the button (that corresponds to the command you are programming) on the remote controller of the other device until the SEND/LEARN lamp on the remote controller flashes twice.**

After flashing twice, the SEND/LEARN indicator will light again.

- 5. Repeat Steps 3 and 4 to transfer all the commands you desire from the other remote controller and program them to buttons on the remote controller under the same MODE.**

Repeat Steps 2 through 4 to program commands to a different MODE (e.g., when programming from a different remote controller).

- 6. Press the MODE button that you pressed in step 2 to complete the programming.**

- 7. Operate the newly programmed buttons to make sure the learning function was performed properly.**

## Notes:

- The remote controller codes for Onkyo compact disc players, cassette tape decks, DVD players, and mini disc recorder have already been programmed into buttons on the remote controller. You may, however, use these buttons to program the codes for other remote controllers. If you wish to restore the Onkyo preset codes after you program new codes, you must first erase the new codes (see page 66).
- The remote controller has 408 memory slots (8 modes × 51 buttons). Some remote controllers may have more commands that can be remembered by the remote controller. In such cases, it will be necessary for you to determine which commands are more important than others.
- If no button is pressed for more than 30 seconds during the programming, or if you perform an invalid operation during programming, the SEND/LEARN indicator flashes three times quickly, and the remote controller exits the programming mode. Resume from Step 2.
- If a failure occurs during programming, the SEND/LEARN indicator flashes three times quickly, and the remote controller exits the programming mode. Resume from Step 3.
- If a failure occurs five times in row during programming, the remote controller exits the programming mode. Resume from Step 3.
- If you try to program beyond the learning capacity of the remote controller, the SEND/LEARN indicator flashes six times quickly, and the remote controller exits the programming mode. Try programming under a different MODE button.
- When you want to program a command to a button to which you have already programmed a command, simply follow the same procedure given and programming for that button will be overwritten.
- The remote controller uses infrared rays to send its commands, as do most other remote controllers. Though most remote controller codes can be memorized by the remote controller, be aware that some remote controllers use a system that is quite different from the remote controller and therefore may not be able to be programmed.
- Some remote controllers have a single button that performs multiple functions (for example, the function may change each time the button is pressed). If this is the case, each function must be programmed to a separate button on the remote controller.
- Once you have transferred the commands from the other remote controller, refer to the instruction manual that came with that product for instructions on how to operate that product.
- Make sure both the remote controller and the other remote controller have new batteries. If either of them has batteries that are low, you may not be able to program the commands of the other remote controller properly into the remote controller.

See page 70 for how to erase the memorized commands from all buttons.

# Programming the commands of remote controllers for other devices into the remote controller

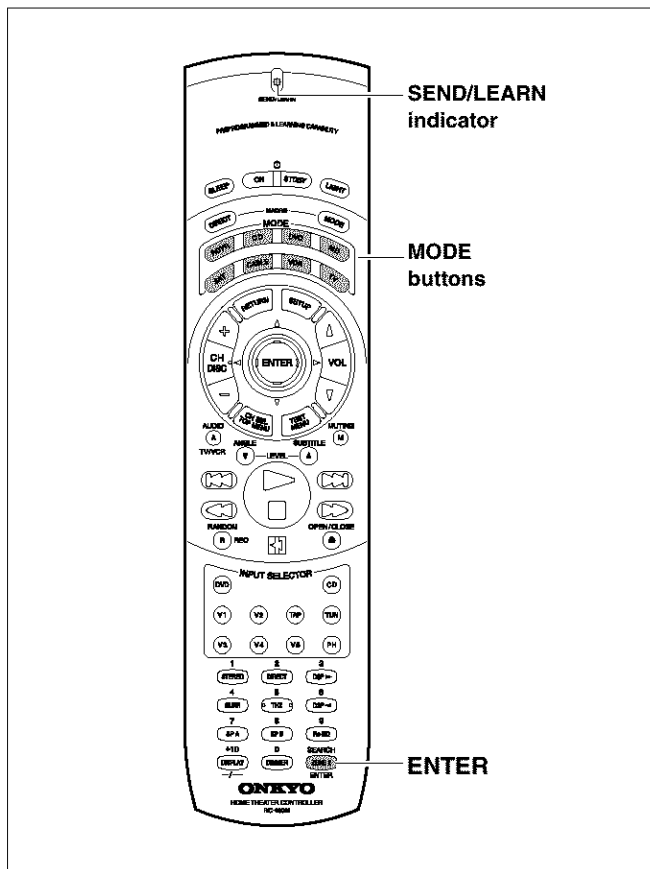
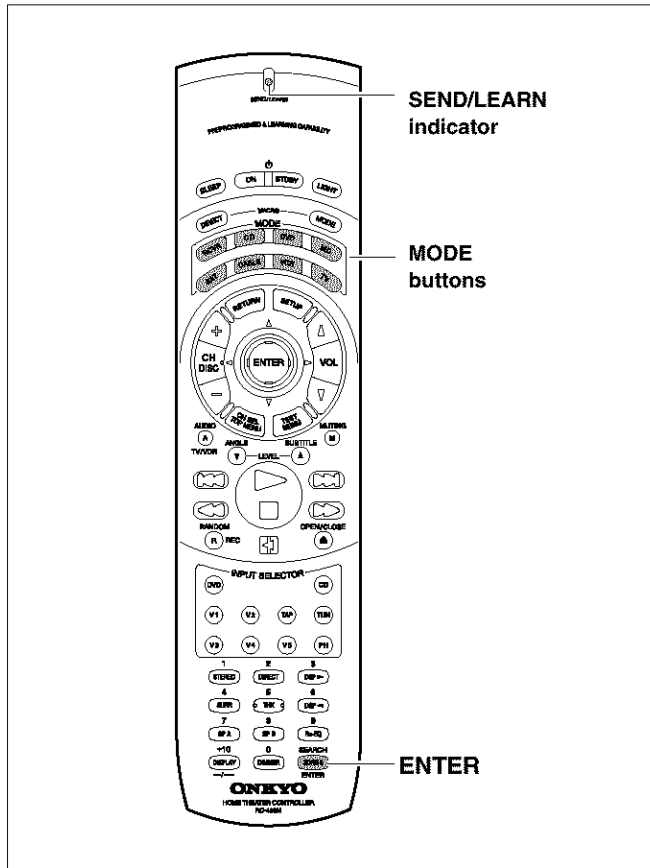

## Erasing the programmed command from one button

You can only erase memorized commands and not preset ones.

1. **Press and hold down the desired MODE button for the command, press the ENTER button, and then release both buttons.**

When you press the MODE button, the SEND/LEARN indicator lights. When you press the ENTER button, the lamp turns off. When you release the buttons, the lamp lights again.

2. **Press and release the button for the command you wish to erase.**

When you press the button, the SEND/LEARN indicator turns off. When you release the button, the lamp lights again.

3. **Press and release the same button again.**

The SEND/LEARN lamp flashes twice slowly. The memorized command is erased.

### Note:

If no button is pressed for more than 30 seconds during the erasing procedure, the SEND/LEARN indicator flashes three times quickly, and the remote controller exits the erasing mode. Resume from Step 1.

## Erasing all the commands programmed under a MODE button

1. **Press and hold down the desired MODE button, press the ENTER button twice, and then release both buttons.**

When you press the MODE button, the SEND/LEARN indicator lights. When you press the ENTER button, the lamp turns off. When you release the buttons, the lamp flashes twice slowly and then lights again.

2. **Press and release the same MODE button again.**

When you release the button, the SEND/LEARN indicator flashes twice slowly. This erases all the commands memorized to the MODE button.

### Notes:

- If no button is pressed for more than 30 seconds during the erasing procedure, the SEND/LEARN indicator flashes three times quickly and the remote controller exits the erasing mode. Resume from Step 1.
- If you perform an invalid operation during erasing, the SEND/LEARN indicator flashes three times quickly, and the remote controller exits the erasing mode. Resume from Step 1.
- If many commands have been programmed to the MODE button, then the SEND/LEARN indicator may remain lit for up to 20 seconds during Step 2. This is not a malfunction.

# Using a Macro function

## What is a Macro function?

A Macro function enables you to program a series of button operations (up to 16) on the remote controller into a single button. For example, to play a compact disc player connected to the TX-DS797 normally, you must perform the following steps:

1. Press the RCVR MODE button.
2. Press the ON button.
3. Press the CD (INPUT SELECTOR) button.
4. Press the CD MODE button.
5. Press the playback (▷) button.

By using the macro function, you can perform the above five operations by **only pressing two buttons**.

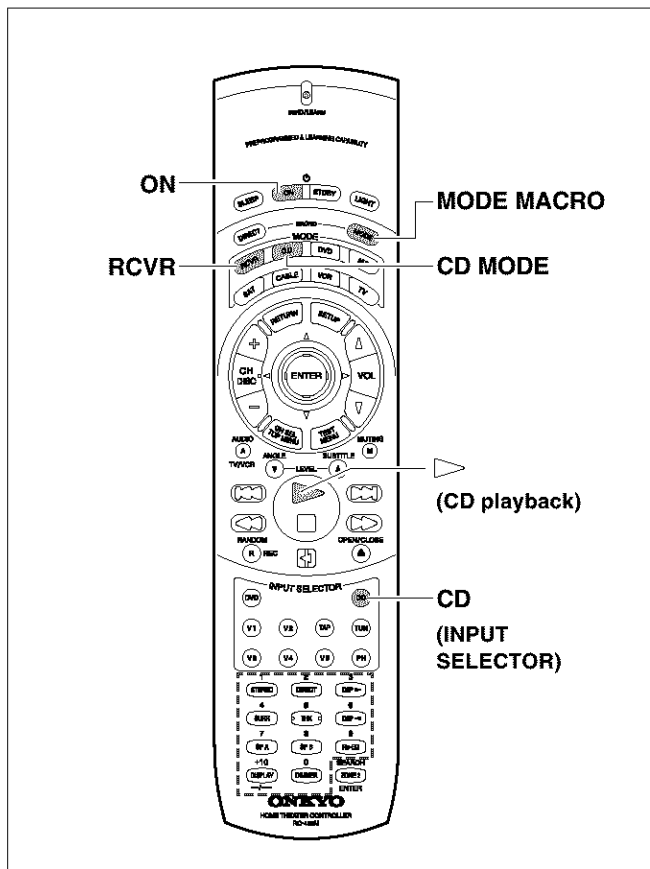

### Tips:

- If you erase or change the command of a button programmed in a macro, that operation of that button will no longer work in the macro. In this case, it will be necessary for you to reprogram the macro in order to avoid incorrect operation.
- The codes programmed into a macro will be transmitted at an interval of 0.5 seconds. However, some devices may not be able to complete one operation in 0.5 seconds and may miss the next code. In this case, after pressing one operation button, you can press the same MODE button again before pressing the next operation button to add another 0.5 seconds between the two operations.

## Programming a Macro function

You can program a different macro into the MODE MACRO button for each of the eight MODE buttons. The macro is then executed by pressing the appropriate MODE button and then pressing the MODE MACRO button. For example, to program the macro described above into the CD MODE button, perform the steps given below.

1. Press and hold down the desired MODE button (in this case, the CD MODE button), press the MODE MACRO button, and then release both buttons.

When you press the CD MODE button, the SEND/LEARN indicator lights and the CD MODE button lights green. When you press the MODE MACRO button, the indicator turns off. When you release the buttons, the indicator flashes and lights again.

2. Press the operation buttons you wish to program in order (in this case, press RCVR MODE → ON → CD (INPUT SELECTOR) → CD MODE → playback (▷) button).

When you press each button, the SEND/LEARN indicator turns off. When you release the button, the indicator lights.

3. Press the MODE MACRO button to complete the programming.

The SEND/LEARN indicator flashes twice slowly.

4. Run the macro to check to see if the macro has been properly programmed.

### Notes:

- You may program up to 16 button operations into each macro function. If you try to program a 17th operation, it will be ignored, and programming is stopped.
- If no button is pressed for more than 30 seconds during the programming, the SEND/LEARN indicator flashes three times quickly, and the remote controller exits the programming mode. Resume from Step 1.
- If you perform an invalid operation during programming, the SEND/LEARN indicator flashes three times quickly, and the remote controller exits the programming mode. Resume from Step 1.

## Running a Macro function

Perform the procedure below to run a macro function that you have programmed into the remote controller. After programming a macro, you should always run it at least once to make sure that it has been programmed properly.

1. Point the remote controller at the TX-DS797 and press the CD MODE button.
2. Press the MODE MACRO, and verify that the devices operate properly.

It may take a while for the macro to finish transmitting, so be sure to continue pointing the remote controller at the device until the SEND/LEARN indicator turns off.

# Using a Macro function

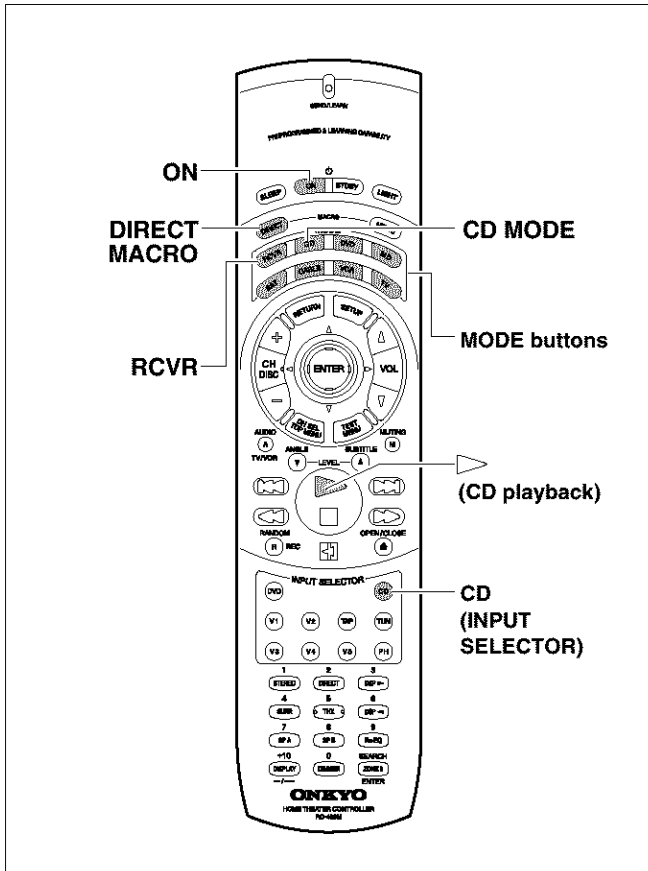

### Tips:

- If you erase or change the command of a button programmed in the direct macro, that operation of that button will no longer work in the macro. In this case, it will be necessary for you to reprogram the direct macro in order to avoid incorrect operation.
- The codes programmed into a direct macro will be transmitted at an interval of 0.5 seconds. However, some devices may not be able to complete one operation in 0.5 seconds and may miss the next code. In this case, after pressing one operation button, you can press the same MODE button again before pressing the next operation button to add another 0.5 seconds between the two operations.

## Programming the Direct Macro function

With the direct macro function, you can program a series of button operations as a macro into the DIRECT MACRO button so the macro can be executed with just one touch. Note that for the direct macro function, only one macro can be programmed. For example, to program the macro described on the previous page for the DIRECT MACRO button, perform the steps given below.

1. **Press and hold down any one of the eight MODE buttons, press the DIRECT MACRO button, and then release both buttons.**

When you press the MODE button, it lights green and the SEND/LEARN indicator lights. When you press the DIRECT MACRO button, the indicator turns off. When you release the buttons, the indicator flashes briefly and then lights again.

2. **Press the operation buttons you wish to program in order (in this case, press RCVR MODE → ON → CD (INPUT SELECTOR) → CD MODE → playback (▷) button).**

When you press each button, the SEND/LEARN indicator turns off. When you release the button, the indicator lights.

3. **Press the DIRECT MACRO button to complete the procedure.**

The SEND/LEARN indicator flashes twice slowly.

4. **Check to see if the macro has been properly programmed.**

### Notes:

- You may program up to 16 button operations into the direct macro function. If you try to program a 17th operation, it will be ignored, and programming is stopped.
- If no button is pressed for more than 30 seconds during the programming, the SEND/LEARN indicator flashes three times quickly, and the remote controller exits the programming mode. Resume from Step 1.
- If you perform an invalid operation during programming, the SEND/LEARN indicator flashes three times quickly, and the remote controller exits the programming mode. Resume from Step 1.

## Running a Direct Macro function

Perform the procedure below to run a direct macro function that you have programmed into the remote controller. After programming a direct macro, you should always run it at least once to make sure that it has been programmed properly.

**Point the remote controller at the TX-DS797 and press the DIRECT MACRO button.**

It may take a while for the macro to finish transmitting, so be sure to continue pointing the remote controller at the device until the SEND/LEARN indicator turns off.

# Using a Macro function

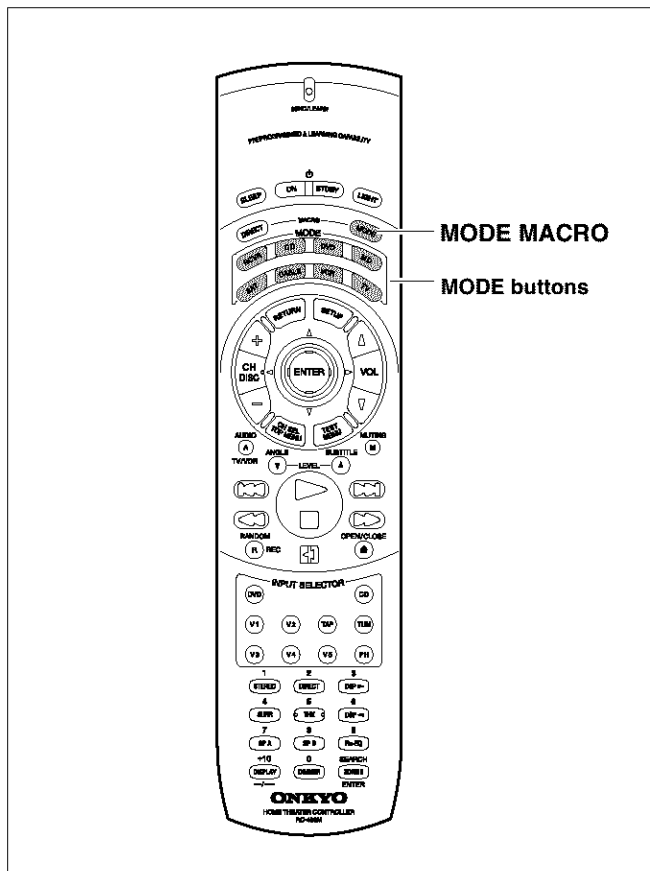

## Erasing a macro from the MODE MACRO button

- 1. Press and hold down the desired MODE button, press the MODE MACRO button, and then release both buttons.**  
When you press the MODE button, it lights green and the SEND/LEARN indicator lights. When you press the MODE MACRO button, the indicator turns off. When you release the buttons, the indicator flashes once.
- 2. Press the MODE MACRO button again.**  
The SEND/LEARN indicator flashes twice slowly. The macro programmed to the MODE button pressed in Step 1 above is erased.

- Notes:**
- If no button is pressed for more than 30 seconds during the erasing procedure, the SEND/LEARN indicator flashes three times quickly, and the remote controller exits the erasing mode. Resume from Step 1.
  - Be aware that if you press a button other than MODE MACRO button in Step 2, then you will in effect be overwriting the previous macro with a new macro.

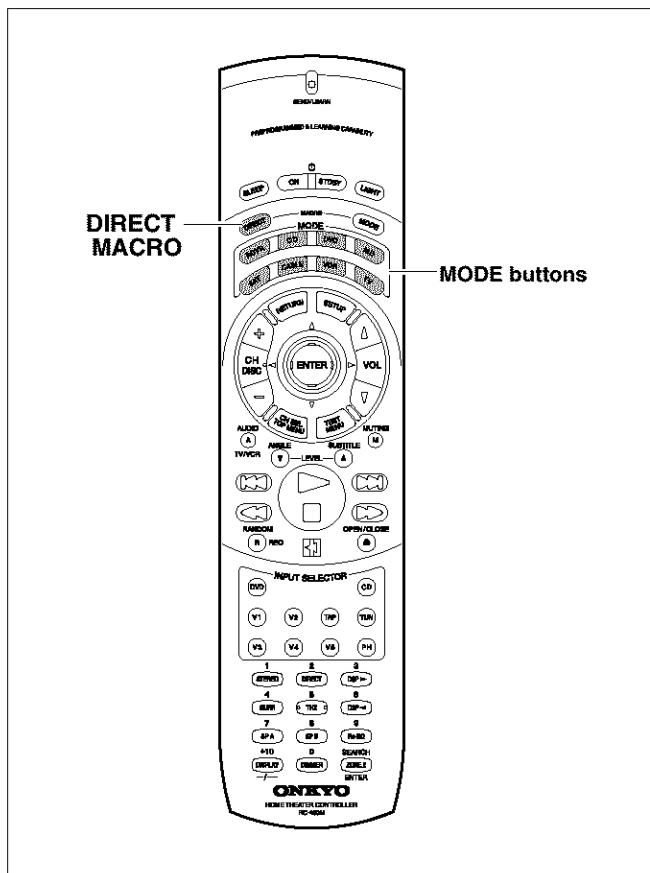

## Erasing a direct macro from the DIRECT MACRO button

- 1. Press and hold down any one of the eight MODE buttons, press the DIRECT MACRO button, and then release both buttons.**  
When you press the MODE button, it lights green and the SEND/LEARN indicator lights. When you press the DIRECT MACRO button, the indicator turns off. When you release the buttons, the indicator flashes once.
- 2. Press the DIRECT MACRO button again.**  
The SEND/LEARN indicator flashes twice slowly. The macro programmed to the DIRECT MACRO button is erased.

- Notes:**
- If no button is pressed for more than 30 seconds during the erasing procedure, the SEND/LEARN indicator flashes three times quickly, and the remote controller exits the erasing mode. Resume from Step 1.
  - Be aware that if you press a button other than DIRECT MACRO button in Step 2, then you will in effect be overwriting the previous direct macro with a new direct macro.

# Using a Macro function

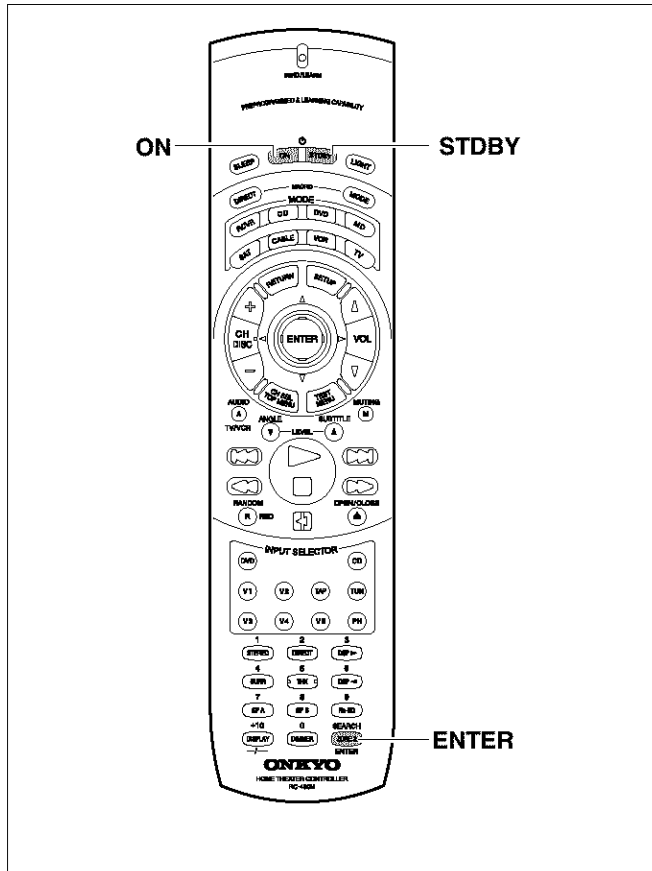

## Erasing all commands and macros that have been programmed

This procedure will erase all the commands and macros that you have programmed into the remote controller and return it to its default settings. This operation will not affect the preset settings of the remote controller.

1. Open the battery cover and remove the batteries from the remote controller.
2. While pressing and holding down the ON and STDBY buttons, re-insert the batteries in their correct orientation, and then release both buttons.

The SEND/LEARN indicator flashes slowly.

3. Press the ENTER button.

The SEND/LEARN indicator lights up for about ten seconds and then turns off.

All programmed commands and macros are erased and the remote controller returns to its factory presets.

### Notes:

- Proceed to Step 3 immediately after Step 2; otherwise, the batteries will be consumed quickly.
- If you press any button other than the ENTER button in Step 3, nothing will be erased. In this case, resume from Step 1.

## Macro mode programming memo:

MACRO	MODE MACRO ↓ RCVR	MODE MACRO ↓ CD	MODE MACRO ↓ DVD	MODE MACRO ↓ MD	MODE MACRO ↓ SAT	MODE MACRO ↓ CABLE	MODE MACRO ↓ VCR	MODE MACRO ↓ TV	DIRECT MACRO
Operation 1									
Operation 2									
Operation 3									
Operation 4									
Operation 5									
Operation 6									
Operation 7									
Operation 8									
Operation 9									
Operation 10									
Operation 11									
Operation 12									
Operation 13									
Operation 14									
Operation 15									
Operation 16									

# Specifications

## AMPLIFIER SECTION

Continuous Average Power output (FTC)

**All channels:** **100 watts per channel min. RMS at 8 ohms, 2 channels driven from 20 Hz to 20 kHz with no more than 0.08% total harmonic distortion. 130 watts min. RMS at 6 ohms, 2 channels driven from 1 kHz with no more than 0.1% total harmonic distortion.**

Continuous Power output (DIN)	135 watts at 6 ohms
Maximum Power output (EIAJ)	160 watts at 6 ohms
Dynamic Power Output (Stereo)	2 × 250 watts at 3 ohms 2 × 210 watts at 4 ohms 2 × 130 watts at 8 ohms
Total Harmonic Distortion:	0.08% at rated power 0.08% at 1 Watt output
IM Distortion:	0.08% at rated power 0.08% at 1 Watt output
Damping Factor:	60 at 8 ohms
Input Sensitivity and Impedance	
PHONO:	2.5 mV, 50 kohms
LINE (CD, TAPE, DVD, VIDEO 1-5):	200 mV, 50 kohms
MULTICHANNEL INPUT (FRONT L/C/R, SURROUND L/R, SURROUND BACK L/R):	200 mV, 50 kohms
(SUBWOOFER):	36 mV, 50 kohms
COAXIAL 1, 2, 3 (DIGITAL):	0.5 Vp-p, 75 ohms
DVD, VIDEO 1, 2, 3, 4, 5:	1 Vp-p, 75 ohms 1 Vp-p, 75 ohms (Y) 0.28 Vp-p, 75 ohms (C)
COMPONENT VIDEO 1, 2:	1 Vp-p, 75 ohms (Y) 0.7 Vp-p, 75 ohms (Pb, Pr)
Output Level and Impedance	
Rec out (TAPE, VIDEO 1, 2):	200 mV, 470 ohms
Pre out:	1 V, 470 ohms
ZONE 2 OUT:	100mV, 470 ohms
VIDEO (VIDEO 1, 2, MONITOR OUT, ZONE 2 OUT):	1 Vp-p, 75 ohms 1 Vp-p, 75 ohms (Y) 0.28 p-p, 75 ohms (C) 1 Vp-p, 75 ohms (Y) 0.7 Vp-p, 75 ohms (Pb, Pr)
COMPONENT VIDEO OUT:	0.7 Vp-p, 75 ohms (Pb, Pr)
Phono Overload:	120 mV RMS at 1 kHz, 0.5% T.H.D.
Frequency Response:	10 Hz to 100 kHz : +1/-3 dB (CD in Direct mode)
RIAA Deviation:	20 Hz to 20 kHz : ±0.8 dB
Tone Control	
Bass:	±10 dB at 50 Hz
Treble:	±10 dB at 20,000 Hz
Signal-to-Noise Ratio (Stereo)	
Phono:	80 dB (IHF A, 5 mV input)
CD/Tape:	110 dB (IHF A, 0.5 V input)

## TUNER SECTION

FM

Tuning Range:	87.5 — 108.0 MHz (50 kHz steps)
Usable Sensitivity	
Mono:	11.2 dBf, 1.0 μV (75 ohms IHF) 0.9 μV (75 ohms DIN)
Stereo:	17.2 dBf, 2.0 μV (75 ohms IHF) 23 μV (75 ohms DIN)
50 dB Quieting Sensitivity	
Mono:	17.2 dBf, 2.0 μV (75 ohms)
Stereo:	37.2 dBf, 20 μV (75 ohms)
Capture Ratio:	2.0 dB
Image Rejection Ratio	
USA & Canadian models:	40 dB
Other area models:	85 dB
IF Rejection Ratio:	90 dB
Signal-to-Noise Ratio	
Mono:	76 dB
Stereo:	70 dB
Alternate Channel Attenuation:	55 dB
Selectivity:	50 dB (DIN)
AM Suppression Ratio:	50 dB
Total Harmonic Distortion	
Mono:	0.2%
Stereo:	0.3%
Frequency Response:	30 Hz — 15 kHz, ±1.0 dB
Stereo Separation:	45 dB at 1 kHz 30 dB at 100 Hz — 10 kHz

AM

Tuning Range	
USA & Canadian models:	530 to 1,710 kHz (10-kHz steps)
European & Australian models:	522 to 1,611 kHz (9-kHz steps)
Worldwide models:	531 to 1,602 kHz (9-kHz steps) 530 to 1,710 kHz (10-kHz steps)
Usable Sensitivity:	30 μV
Image Rejection Ratio:	40 dB
IF Rejection Ratio:	40 dB
Signal-to-Noise Ratio:	40 dB
Total Harmonic Distortion:	0.7%

## GENERAL

Power Supply	
USA & Canadian models:	AC 120 V, 60 Hz
European & Australian models:	AC 230-240 V, 50 Hz
Some Asian models:	AC 220-230 V, 50/60 Hz
Worldwide models:	AC 220-230 and 120 V switchable, 50/60 Hz
Power Consumption	
USA & Canadian models:	6.8 A
Other models:	550 W
Dimensions (W × H × D):	435 × 175 × 459 mm 17-1/8" × 6-7/8" × 18-1/16"
Weight	
USA & Canadian models:	35.9 lbs.
Other models:	17.3 kg

## REMOTE CONTROLLER

Transmitter:	Infrared
Signal range:	Approx. 16 ft., 5 meters
Power supply:	Two "AA" batteries (1.5 V × 2)

Specifications and features are subject to change without notice.

# Troubleshooting guide

If a problem occurs while you are using the remote controller, first try to operate the controls on the front panel of the TX-DS797 to make sure that it is not due to a malfunction (or worn out batteries) in the remote controller.

## POWER

### Power shuts off immediately after power on.

- Amplifier protection circuitry has been activated.  
→ Remove the power cord from outlet immediately. Contact your Onkyo service center.

### No power.

- Power cord is disconnected.  
→ Connect power cord.
- External noise is affecting the internal microcomputer.  
→ Turn the power button off and then on again or remove the power cord from the outlet and then plug it in again.
- Internal fuse is blown.  
→ Contact your Onkyo Service Center.

### Power turns on but no sound.

- “Muting” is displayed.  
→ Press the MUTING button on the remote controller to turn it off.
- Bad connections or wiring.  
→ Check connections, speaker cables, etc.
- Amplifier protection circuitry has been activated.  
→ Contact your Onkyo Service Center.

### The sound of the playback source is not heard.

- Input selector is not set properly.  
→ Set to correct input source.
- Headphones are connected.  
→ Lower volume and then disconnect headphones.

## SPEAKERS

### No sound from the center speaker, or at very low volume.

- Speaker cable is not connected.  
→ Check the connection between the amplifier and the speaker.
- Listening mode is set to Stereo or Direct.  
→ Set the Listening mode to any mode other than Stereo or Direct. The output to the center speaker may differ depending on the listening mode.
- Center speaker level is set to minimum.  
→ Set the Center speaker level to the appropriate volume (page 31).
- The Center setting of the Speaker Config submenu is set to “None.”  
→ Set the Center setting at the Speaker Config submenu to “Large” or “Small” (see page 29).

### No sound or very low volume from subwoofer.

- Subwoofer is set to “No.”  
→ Check the speaker setting (pages 29, 40).
- Subwoofer speakers output level setting is improper.  
→ Check the output level of the Subwoofer using the test tone.

### Low frequency humming is heard.

- Not properly grounded.  
→ Check outer conductor of input plugs.
- Turntable motor is not properly grounded.  
→ Check for proper ground connection.
- Audio connection cables on the rear panel are connected incorrectly.  
→ Adjust the placement of the cable to reduce hum.

### Howling is heard when the volume is turned up.

- Turntable and speakers are located too close together.  
→ Move them farther apart.

### Rough or scratchy sound is heard. High range is not clear.

- The needles of turntable is dirty or worn, or a problem exists with a connected component.  
→ Refer to the instruction of the connected components and check for problem.
- Treble control is too high.  
→ Turn treble down (see page 40).

### No sound is output from the surround back speakers.

- The setting for the surround back speakers does not match the actual configuration.  
→ Check the Surr Back Out setting (OSD MenuSpeaker Setup → Speaker Config). If one surround back speaker is connected, select “1 ch,” and if two surround back speakers are connected, select “2 ch” (page 29).

## FM/AM TUNER

### AM stations cannot be received.

- AM loop antenna is not connected.  
→ Connect the included AM loop antenna to the AM antenna terminals.

### Buzzing noise on AM stations (particularly noticeable at night or with weak stations).

- Noise from electrical apparatus such as fluorescent lamp.  
→ Move the AM loop antenna to different position.  
→ Set up an outdoor AM antenna.

### Noise is heard at high-pitched sounds on AM stations.

- Noise from TV set.  
→ Place the AM loop antenna as far as possible from the TV.  
→ Move unit away from TV set.

### Crackling noise on both AM and FM stations.

- Noise caused by fluorescent lamp being turned on and off.  
→ Move antenna as far as possible from the fluorescent lamp.
- Noise from automobile ignition.  
→ Install an FM outdoor antenna as far as possible from the road.  
→ Change the position or direction of the outdoor antenna.

### The indicators light for stereo reception, but sound is distorted and stereo separation is bad.

- Station is too strong.  
→ Change to FM indoor antenna.
- Multiple reflection of the radio waves because of tall buildings or mountains.  
→ Use antenna that has better directivity and select a point where distortion is least.

### Indicators for stereo reception flicker and hiss is heard on FM stations.

- Station is too weak.  
→ Install an outdoor FM antenna.
- Stereo FM broadcasts cover only about half the distance of an ordinary broadcast.  
→ Change the position or direction of the outdoor antenna.

### No preset station is recalled.

- Power cord has been unplugged or the POWER switch has been turned off for a long time.  
→ The memory contents are lost. Store all stations again.



# Troubleshooting guide

## VIDEO and AUDIO

### Desired picture does not appear.

- Improper connection.  
→ Check the connection again. Insert the plugs and connectors completely.

### No OSD Menu display.

- Improper connection.  
→ Check connections.
- OSD Menu is displayed when monitor is connected to VIDEO or S VIDEO of MONITOR OUT.  
→ Confirm connections (see page 18).

### No sound, or sound of the selected source is not heard.

- Input Setup menu settings are incorrect.  
→ Check settings (see page 33).

### No picture appears on the TV screen (or monitor).

- TV (or monitor) is not set to receive the output signals from the receiver.  
→ Set the TV (or monitor) to the receiver input.
- Video cable is not connected securely.  
→ Check connections.
- You have connected to the COMPONENT VIDEO connectors but the TX-DS797 is not set properly.  
→ Check the Video Setup submenu of the Input Setup menu (page 35).

## REMOTE CONTROLLER

### Front panel controls function but remote controller controls do not.

- No batteries in remote controller.  
→ Insert batteries.
- Batteries have worn out.  
→ Replace batteries.
- Remote controller is not pointed at the remote sensor of the TX-DS797.  
→ Point the remote controller at the remote sensor of the TX-DS797.
- Remote controller is too far from the TX-DS797.  
→ Operate the remote controller within 16 feet (5 meters).
- Remote controller is functioning in a different mode  
→ Press the RCVR MODE button.

## OTHER

### LATE NIGHT function cannot be used.

- Playback source is not Dolby Digital encoded.  
→ Check that the DOLBY DIGITAL indicator lights up on the display.

### Re-EQ function cannot be used.

- Listening mode is set to Theater-Dimensional, Direct, PL II Music, or Neo:6 Music.  
→ See page 43.

### Parameter cannot be set for Front Effect etc.

- Parameter may not be able to be set depending on the listening mode.  
→ See table on page 43.

### Multichannel audio is not output.

- To listen to multichannel audio, “Yes” must be selected in the “Multichannel” in the Multichannel setup sub-menu of the Input Setup menu. Also, it is necessary to select Multichannel with the AUDIO SELECTOR button.  
→ Check that the component is connected to the MULTI CHANNEL INPUT port and check the Setup menu settings.

### Components in remote zone (Zone 2) do not operate properly.

- Components are incorrectly connected.  
→ Check connections.
- Objects are interfering with remote controller signals.  
→ Move interfering objects away from path of remote controller signals.

## If one of the messages shown below appears

### “Not available with headphones use”

The operation is not allowed because headphones are plugged into the TX-DS797.

### “Not available with Multichannel use”

Cannot be used while the multi-channel output is being used.

### “Not available in this Sp Config”

Will not work with the current speaker configuration settings.

### “Not available in Zone 2 mode”

The operation is not allowed because the Zone 2 mode is turned on.

### “Only available with Dolby D”

No setting other than Dolby Digital can be set.

### “Not available in this Listening mode”

Will not work with the current listening mode.

### “Not available with this signal”

The listening mode cannot be selected with the current input source.

### “Not available with Muting”

Will not work because the muting is activated.

### “Zone 2 is not On”

Will not work because the Zone 2 has not been turned on.

Also refer to the respective instruction manuals of the compact disc player, DVD player, video cassette recorder, TV monitor, etc., that compose your entertainment system.

The TX-DS797 contains an internal microcomputer that performs high-level operations. However, on extremely rare occasions, noise or interference from an external source or static electricity may cause faulty operation. If this occurs, unplug the power cord from the wall outlet, wait five or more seconds, and then plug it back in. This should correct the situation.

- \* To reset the surround mode and other settings to the factory default settings, hold down the VIDEO 1 button with the TX-DS797 turned on and then press the STANDBY/ON button. “CLEAR” appears in the front display and the TX-DS797 enters the standby state.

# Memo

---

# Memo

---

---

## **ONKYO CORPORATION**

Sales & Product Planning Div. : 2-1, Nisshin-cho, Neyagawa-shi, OSAKA 572-8540, JAPAN  
Tel: 072-831-8111 Fax: 072-833-5222

### **ONKYO U.S.A. CORPORATION**

18 Park Way, Upper Saddle River, N.J. 07458, U.S.A.  
Tel: 201-785-2600 Fax: 201-785-2650 <http://www.onkyousa.com>

### **ONKYO EUROPE ELECTRONICS GmbH**

Industriestrasse 20, 82110 Germering, GERMANY  
Tel: 089-849-320 Fax: 089-849-3265 E-mail: [info@onkyo.de](mailto:info@onkyo.de)

### **ONKYO CHINA LIMITED**

Units 2102-2107, Metroplaza Tower I, 223 Hing Fong Road, Kwai Chung,  
N.T., HONG KONG Tel: 852-2429-3118 Fax: 852-2428-9039

