

# SHARP®

## LC-30HV2U

LIQUID CRYSTAL TELEVISION  
TÉLÉVISEUR ACL  
TELEVISOR CON PANTALLA DE  
CRISTAL LIQUIDO  
TELEVISOR DE CRISTAL LÍQUIDO

OPERATION MANUAL  
MODE D'EMPLOI  
MANUAL DE OPERACIÓN  
MANUAL DE OPERAÇÃO

# AQUOS

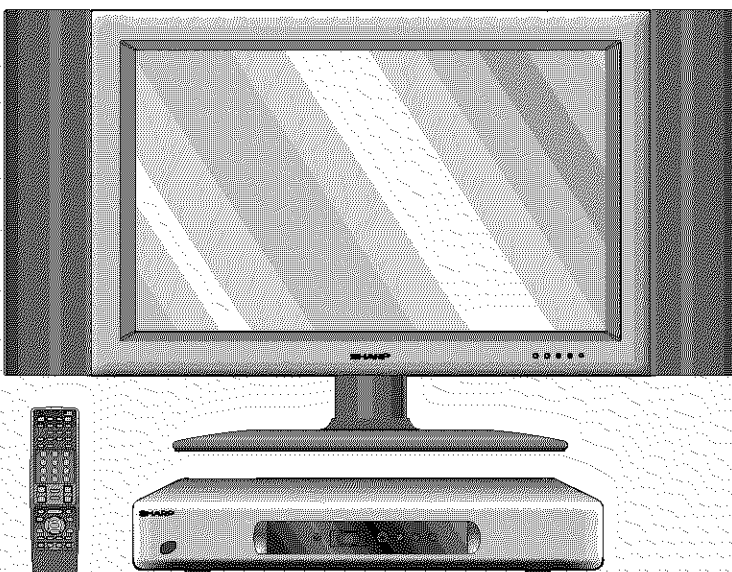

ENGLISH

FRANÇAIS

ESPAÑOL

PORTUGUÊS

# LC-30HV2U

## LIQUID CRYSTAL TELEVISION

### ENGLISH

## OPERATION MANUAL

# IMPORTANT INFORMATION

**WARNING:** TO REDUCE THE RISK OF FIRE OR ELECTRIC SHOCK, DO NOT EXPOSE THIS PRODUCT TO RAIN OR MOISTURE.



### CAUTION

RISK OF ELECTRIC SHOCK.  
DO NOT OPEN.



The lightning flash with arrow-head symbol, within an equilateral triangle, is intended to alert the user to the presence of uninsulated "dangerous voltage" within the product's enclosure that may be of sufficient magnitude to constitute a risk of electric shock to persons.



The exclamation point within a triangle is intended to alert the user to the presence of important operating and maintenance (servicing) instructions in the literature accompanying the product.

CAUTION: TO REDUCE THE RISK OF ELECTRIC SHOCK,  
DO NOT REMOVE COVER (OR BACK).  
NO USER-SERVICEABLE PARTS INSIDE.  
REFER SERVICING TO QUALIFIED SERVICE  
PERSONNEL.

### CAUTION:

This product satisfies FCC regulations when shielded cables and connectors are used to connect the unit to other equipment. To prevent electromagnetic interference with electric appliances such as radios and televisions, use shielded cables and connectors for connections.

### IMPORTANT:

To aid reporting in case of loss or theft, please record the TV's model and serial numbers in the space provided. The numbers are located at the rear of the TV.

Model No.:

Serial No.:

U.S.A ONLY

## IMPORTANT INFORMATION

**WARNING:** FCC Regulations state that any unauthorized changes or modifications to this equipment not expressly approved by the manufacturer could void the user's authority to operate this equipment.

U.S.A ONLY

**CAUTION:** TO PREVENT ELECTRIC SHOCK, MATCH WIDE BLADE OF PLUG TO WIDE SLOT, FULLY INSERT.

"Note to CATV system installer: This reminder is provided to call the CATV system installer's attention to Article 820-40 of the National Electrical Code that provides guidelines for proper grounding and, in particular, specifies that the cable ground shall be connected to the grounding system of the building, as close to the point of cable entry as practical."

This product utilizes tin-lead solder, and fluorescent lamp containing a small amount of mercury. Disposal of these materials may be regulated due to environmental considerations. For disposal or recycling information, please contact your local authorities or the Electronic Industries Alliance: [www.eia.org](http://www.eia.org)

### CAUTION:

DO NOT PLACE THIS PRODUCT ON AN UNSTABLE CART, STAND, TRIPOD, BRACKET, OR TABLE. THE PRODUCT MAY FALL CAUSING SERIOUS PERSONAL INJURY AND SERIOUS DAMAGE TO THE PRODUCT. USE ONLY WITH A CART, STAND, TRIPOD, BRACKET, OR TABLE RECOMMENDED BY THE MANUFACTURER OR SOLD WITH THE PRODUCT. FOLLOW THE MANUFACTURER'S INSTRUCTIONS WHEN INSTALLING THE PRODUCT AND USE MOUNTING ACCESSORIES RECOMMENDED BY THE MANUFACTURER. A PRODUCT AND CART COMBINATION SHOULD BE MOVED WITH CARE. QUICK STOPS, EXCESSIVE FORCE, AND UNEVEN SURFACES MAY CAUSE THE PRODUCT AND CART COMBINATION TO OVERTURN.



**NOTE:** This equipment has been tested and found to comply with the limits for a class B digital device, pursuant to Part 15 of the FCC Rules. These limits are designed to provide reasonable protection against harmful interference in a residential installation. This equipment generates, uses, and can radiate radio frequency energy and, if not installed and used in accordance with the instructions, may cause harmful interference to radio communications. However, there is no guarantee that interference will not occur in a particular installation. If this equipment does cause harmful interference to radio or television reception, which can be determined by turning the equipment off and on, the user is encouraged to try to correct the interference by one or more of the following measures:

- Reorient or relocate the receiving antenna.
- Increase the separation between the equipment and receiver.
- Connect the equipment into an outlet on a circuit different from that to which the receiver is connected.
- Consult the dealer or an experienced radio/TV technician for help.

### [For Canadian model]

This Class B digital apparatus complies with Canadian ICES-003.

## FEDERAL COMMUNICATIONS COMMISSION DECLARATION OF CONFORMITY

This device complies with part 15 of the FCC Rules. Operation is subject to the following two conditions: (1) This device may not cause harmful interference, and (2) this device must accept any interference received, including interference that may cause undesired operation.

Product Name: LIQUID CRYSTAL TELEVISION

Model Number: LC-30HV2U

Product Category: Class B Personal Computers & Peripherals

Responsible Party Name:

Address: SHARP ELECTRONICS CORPORATION  
Sharp Plaza, Mahwah, New Jersey 07430

Phone: 1-800-BE-SHARP

For Business Customers: URL <http://www.sharpusa.com>

# DEAR SHARP CUSTOMER

---

Thank you for your purchase of the Sharp Liquid Crystal Television. To ensure safety and many years of trouble-free operation of your product, please read the Safety Precautions carefully before using this product.

## IMPORTANT SAFETY PRECAUTIONS

---

Electricity is used to perform many useful functions, but it can also cause personal injuries and property damage if improperly handled. This product has been engineered and manufactured with the highest priority on safety. However, improper use can result in electric shock and/or fire. In order to prevent potential danger, please observe the following instructions when installing, operating and cleaning the product. To ensure your safety and prolong the service life of your Liquid Crystal Television, please read the following precautions carefully before using the product.

- Read instructions —All operating instructions must be read and understood before the product is operated.
- Keep this manual in a safe place —These safety and operating instructions must be kept in a safe place for future reference.
- Observe warnings —All warnings on the product and in the instructions must be observed closely.
- Follow instructions —All operating instructions must be followed.
- Attachments —Do not use attachments not recommended by the manufacturer. Use of inadequate attachments can result in accidents.
- Power source —This product must operate on a power source specified on the specification label. If you are not sure of the type of power supply used in your home, consult your dealer or local power company. For units designed to operate on batteries or another power source, refer to the operating instructions.
- AC cord protection —The AC cords must be routed properly to prevent people from stepping on them or objects from resting on them. Check the cords at the plugs and product.
- Overloading —Do not overload AC outlets or extension cords. Overloading can cause fire or electric shock.
- Entering of objects and liquids —Never insert an object into the product through vents or openings. High voltage flows in the product, and inserting an object can cause electric shock and/or short internal parts. For the same reason, do not spill water or liquid on the product.
- Servicing —Do not attempt to service the product yourself. Removing covers can expose you to high voltage and other dangerous conditions. Request a qualified service person to perform servicing.
- Repair —If any of the following conditions occurs, unplug the AC cord from the AC outlet, and request a qualified service person to perform repairs.
  - a. When the AC cord or plug is damaged.
  - b. When a liquid was spilled on the product or when objects have fallen into the product.
  - c. When the product has been exposed to rain or water.
  - d. When the product does not operate properly as described in the operating instructions.

Do not touch the controls other than those described in the operating instructions. Improper adjustment of controls not described in the instructions can cause damage, which often requires extensive adjustment work by a qualified technician.
  - e. When the product has been dropped or damaged.
  - f. When the product displays an abnormal condition. Any noticeable abnormality in the product indicates that the product needs servicing.
- Replacement parts —In case the product needs replacement parts, make sure that the service person uses replacement parts specified by the manufacturer, or those with the same characteristics and performance as the original parts. Use of unauthorized parts can result in fire, electric shock and/or other danger.
- Safety checks —Upon completion of service or repair work, request the service technician to perform safety checks to ensure that the product is in proper operating condition.
- Wall or ceiling mounting —When mounting the product on a wall or ceiling, be sure to install the product according to the method recommended by the manufacturer.
- Polarization —The product may be equipped with a polarized alternating current line plug (a plug having one blade wider than the other). This plug will fit into the AC outlet only one way. This is a safety feature. If you are unable to insert the plug fully into the outlet, try reversing the plug. If the plug should still fail to fit, contact your electrician to replace your obsolete outlet. Do not defeat the safety purpose of the polarized plug.
- Unplug the AC cord from the AC outlet before installing the speakers.

## IMPORTANT SAFETY PRECAUTIONS

- **Cleaning**—Unplug the AC cord from the AC outlet before cleaning the product. Use a damp cloth to clean the product. Do not use liquid cleaners or aerosol cleaners.

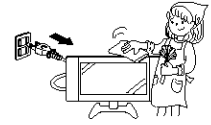

- **Water and moisture**—Do not use the product near water, such as bathtub, washbasin, kitchen sink and laundry tub, swimming pool and in a wet basement.

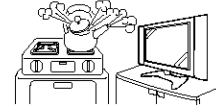

- **Stand**—Do not place the product on an unstable cart, stand, tripod or table. Placing the product on an unstable base can cause the product to fall, resulting in serious personal injuries as well as damage to the product. Use only a cart, stand, tripod, bracket or table recommended by the manufacturer or sold with the product. When mounting the product on a wall, be sure to follow the manufacturer's instructions. Use only the mounting hardware recommended by the manufacturer.



- **Ventilation**—The vents and other openings in the cabinet are designed for ventilation. Do not cover or block these vents and openings since insufficient ventilation can cause overheating and/or shorten the life of the product. Do not place the product on a bed, sofa, rug or other similar surface, since they can block ventilation openings. This product is not designed for built-in installation; do not place the product in an enclosed place such as a bookcase or rack, unless proper ventilation is provided or the manufacturer's instructions are followed.

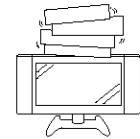

- **The Liquid Crystal panel used in this product is made of glass. Therefore, it can break when the product is dropped or applied with impact. Be careful not to be injured by broken glass pieces in case the panel breaks.**

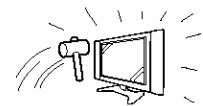

- **Heat sources**—Keep the product away from heat sources such as radiators, heaters, stoves and other heat-generating products (including amplifiers).

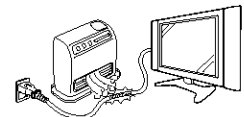

- **The Liquid Crystal panel is a very high technology product with 2,949,120 thin film transistors, giving you fine picture details. Occasionally, a few non-active pixels may appear on the screen as a fixed point of blue, green or red. Please note that this does not affect the performance of your product.**

### **Precautions when transporting the display**

When transporting the display, never carry it by holding onto the speakers. Be sure to always carry the display by two people holding it with two hands—one hand on each side of the display.

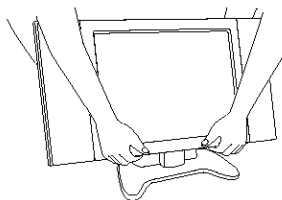

## IMPORTANT SAFETY PRECAUTIONS

- If an outside antenna is connected to the television equipment, be sure the antenna system is grounded so as to provide some protection against voltage surges and built-up static charges. Section 810 of the National Electrical Code provides information with respect to proper grounding of the mast and supporting structure, grounding of the lead-in wire to an antenna discharge unit, size of grounding conductors, location of antenna-discharge unit, connection to grounding electrodes, and requirements for the grounding electrode.

### EXAMPLE OF ANTENNA GROUNDING AS PER NATIONAL ELECTRICAL CODE

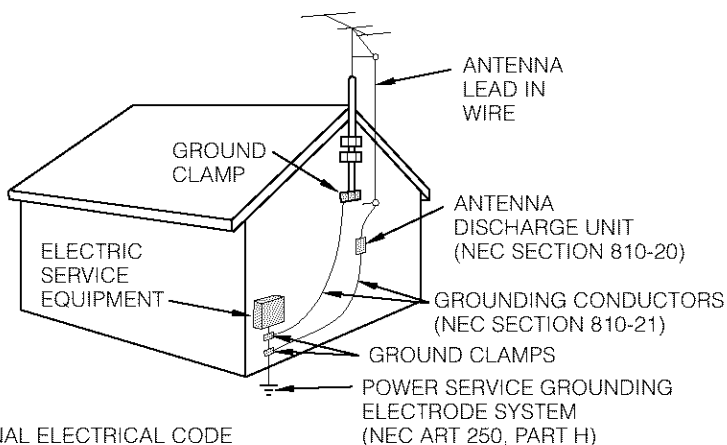

- For added protection for this television equipment during a lightning storm, or when it is left unattended and unused for long periods of time, unplug it from the wall outlet and disconnect the antenna. This will prevent damage to the equipment due to lightning and power-line surges.

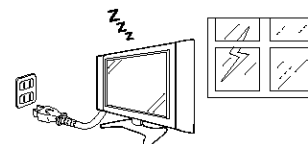

- An outside antenna system should not be located in the vicinity of overhead power lines or other electric light or power circuits, or where it can fall into such power lines or circuits. When installing an outside antenna system, extreme care should be taken to keep from touching such power lines or circuits as contact with them might be fatal.

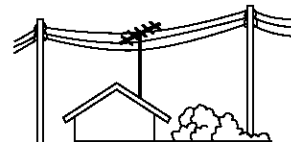

# Contents

<b>IMPORTANT INFORMATION</b> .....	<b>1</b>	<b>Using external equipment</b> .....	<b>38</b>
<b>DEAR SHARP CUSTOMER</b> .....	<b>3</b>	Watching a DVD image .....	39
<b>IMPORTANT SAFETY PRECAUTIONS</b> .....	<b>3</b>	Connecting a DVD player .....	39
<b>Contents</b> .....	<b>6</b>	Displaying a DVD image .....	39
<b>Supplied accessories</b> .....	<b>7</b>	Watching a VCR image .....	40
<b>Preparation</b> .....	<b>8</b>	Connecting a VCR .....	40
Setting the system .....	8	Displaying a VCR image .....	40
Inserting the batteries .....	9	Watching broadcasts via a Digital TV tuner ...	41
Using the remote control unit .....	9	Connecting a Digital TV tuner .....	41
Cautions regarding remote control unit .....	9	Displaying broadcasts	
<b>Part names</b> .....	<b>10</b>	via a Digital TV tuner .....	41
Display .....	10	Enjoying a game console	
AVC System .....	11	or viewing camcorder images .....	42
Remote control unit .....	12	Connecting a game console	
<b>Watching TV</b> .....	<b>13</b>	or camcorder .....	42
Basic connection .....	13	Displaying an image of the game	
Connecting the VHF/UHF antenna .....	13	console or camcorder .....	42
Connecting the cable converter .....	13	Viewing an image from a computer .....	43
Switching between Tuner A and Tuner B ...	13	Connecting a computer .....	43
Using Headphones .....	14	Displaying an image from a computer ...	43
Connecting the AC cord .....	15	Removing the speakers .....	44
Turning on the power .....	16	<b>Adjustment settings</b> .....	<b>45</b>
Turning off the power .....	16	Image position (TV/VIDEO mode only) .....	45
Initial setup .....	17	Auto Sync. adjustment (PC mode only) .....	46
Simple button operations		Fine Sync. adjustment (PC mode only) .....	46
for changing channels .....	18	Input signal source .....	47
Simple button operations		AV MODE .....	48
for changing volume/sound .....	19	View Modes for 4:3 Programs .....	49
Using FRONT SURROUND		Selecting Stretch Mode display	
on the remote control unit .....	20	(TV/VIDEO mode only) .....	50
Setting MTS/SAP stereo mode .....	21	View Mode (for PC mode) .....	51
<b>Basic adjustment settings</b> .....	<b>22</b>	Audio out .....	52
TV/VIDEO mode menu items .....	22	Sleep timer .....	52
PC mode menu items .....	23	Closed caption .....	53
Moving the picture on the screen .....	24	Parental control (setting V-CHIP level) .....	54
EZ Setup .....	25	Secret number setting for parental control	
Channel setup .....	26	(TV/VIDEO mode only) .....	58
Language setting .....	28	How to temporarily release	
Picture adjustments .....	29	the V-CHIP BLOCK .....	60
Color temperature .....	30	Reactivating the temporarily released	
Black .....	30	V-CHIP BLOCK .....	60
3D-Y/C .....	31	<b>Other viewing options</b> .....	<b>61</b>
Monochrome .....	31	Twin picture functions .....	61
Film mode (3:2 pull-down) .....	32	Learning remote control function .....	62
I/P Setting .....	32	Using the TV remote control unit	
Cool Climate .....	33	to control other devices .....	64
Vivid Color .....	33	<b>Appendix</b> .....	<b>70</b>
Sound adjustment .....	34	Troubleshooting .....	70
Power control .....	35	Computer compatibility chart .....	71
Power control for AV source .....	35	RS-232C port specifications .....	72
Power control for PC source .....	37	Specifications .....	74
		<b>Dimensional drawings</b> .....	<b>75</b>

# Supplied accessories

Make sure the following accessories are provided with the product.

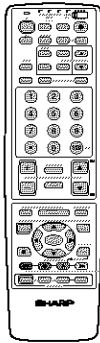
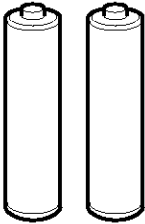
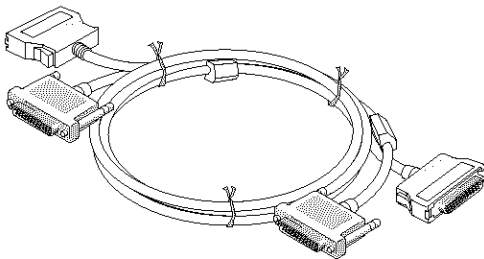
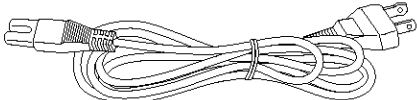
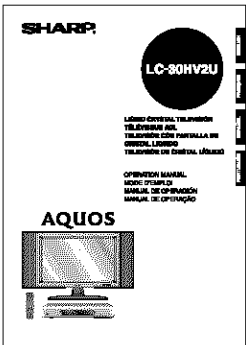
Remote control unit (× 1)	"AA" size (UM/SUM-3) Alkaline battery (× 2)
 <p>RRMCGA037WJSA</p>	 <p>UBATA0018CEZZ</p>
System cable (× 1)	AC cord (× 2)
 <p>QCNW-6117CEZZ</p>	 <p>QACCD3097CEPZ</p>
Operation manual (× 1)	
 <p>TINS-A237WJZZ</p>	

**NOTE**

- Always use the AC cord supplied with the Liquid Crystal Television and the one supplied with the AVC System for each respective unit.
- AC cord enclosed in this product is an object for 110-125V. In using it on the 125-240V AC, please consult to the following.

**SHARP ELECTRONICS CORPORATION**  
 1300 Naperville Drive, Romeoville, Illinois 60446-1091, U.S.A. TEL: 630-226-2400



# Preparation

## Setting the system

### Removing the terminal cover

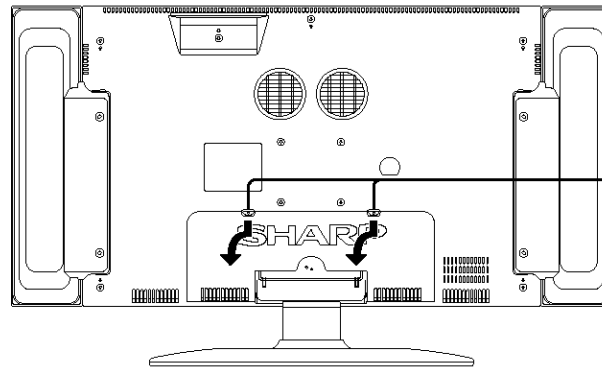

Press down the two upper hooks to remove the cover toward you.

### 1. Connecting the system cable and the AC cord to the Display

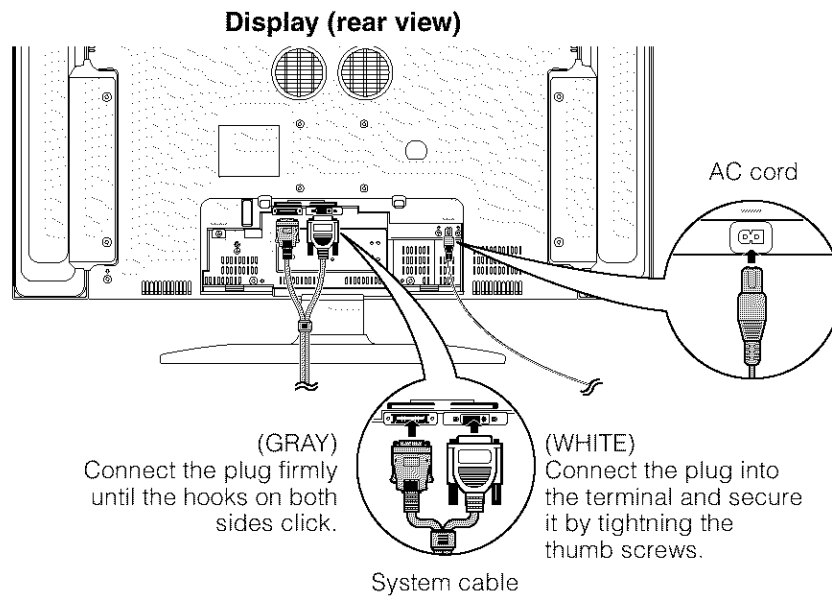

### 2. Connecting the system cable and the AC cord to the AVC System

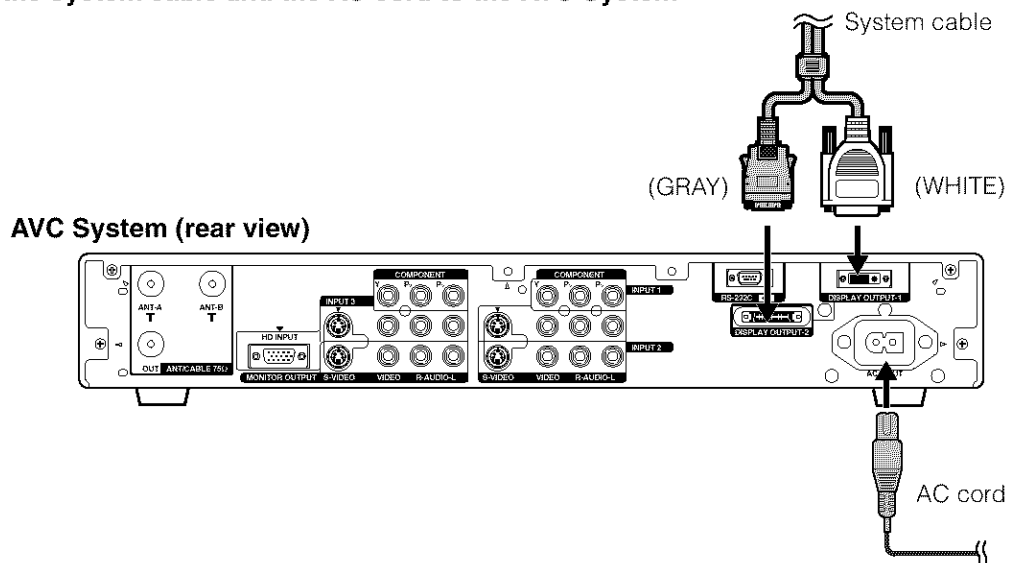

#### CAUTION

- TO PREVENT RISK OF ELECTRIC SHOCK, DO NOT TOUCH UN-INSULATED PARTS OF ANY CABLES WITH THE AC CORD CONNECTED.

## Preparation

### Inserting the batteries

If the remote control fails to operate Liquid Crystal Television functions, replace the batteries in the remote control unit.

**1** Open the battery cover.

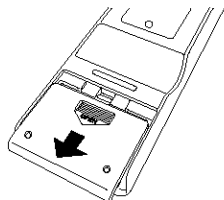

**2** Insert the batteries (two "AA" size (UM/SUM-3) Alkaline batteries, supplied with the product).

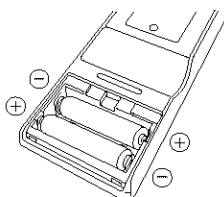

**3** Close the battery cover.

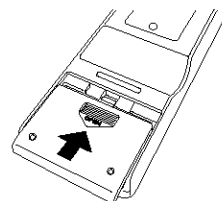

- Place the batteries with their terminals corresponding to the (+) and (-) indications in the battery compartment.

### CAUTION

Improper use of batteries can result in chemical leakage or explosion. Be sure to follow the instructions below.

- Do not use manganese batteries. When you replace the batteries, use alkaline ones.
- Place the batteries with their terminals corresponding to the (+) and (-) indications.
- Do not mix batteries of different types. Different types of batteries have different characteristics.
- Do not mix old and new batteries. Mixing old and new batteries can shorten the life of new batteries or cause chemical leakage in old batteries.
- Remove batteries as soon as they are worn out. Chemicals that leak from batteries can cause a rash. If you find any chemical leakage, wipe thoroughly with a cloth.
- The batteries supplied with this product may have a shorter life expectancy due to storage conditions.
- If you will not be using the remote control unit for an extended period of time, remove batteries from it.

### Using the remote control unit

Use the remote control unit by pointing it towards the remote control sensor on the Display. Objects between the remote control unit and the remote control sensor may prevent proper operation.

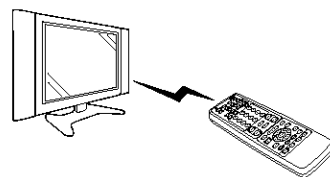

### Cautions regarding remote control unit

- Do not expose the remote control unit to shock. In addition, do not expose the remote control unit to liquids, and do not place in an area with high humidity.
- Do not install or place the remote control unit under direct sunlight. The heat may cause deformation of the remote control unit.
- The remote control unit may not work properly if the remote control sensor on the Display is under direct sunlight or strong lighting. In such cases, change the angle of the lighting or the Display, or operate the remote control unit closer to the remote control sensor.

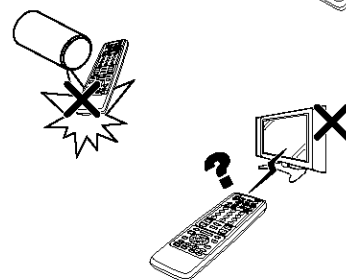

# Part names

## Display

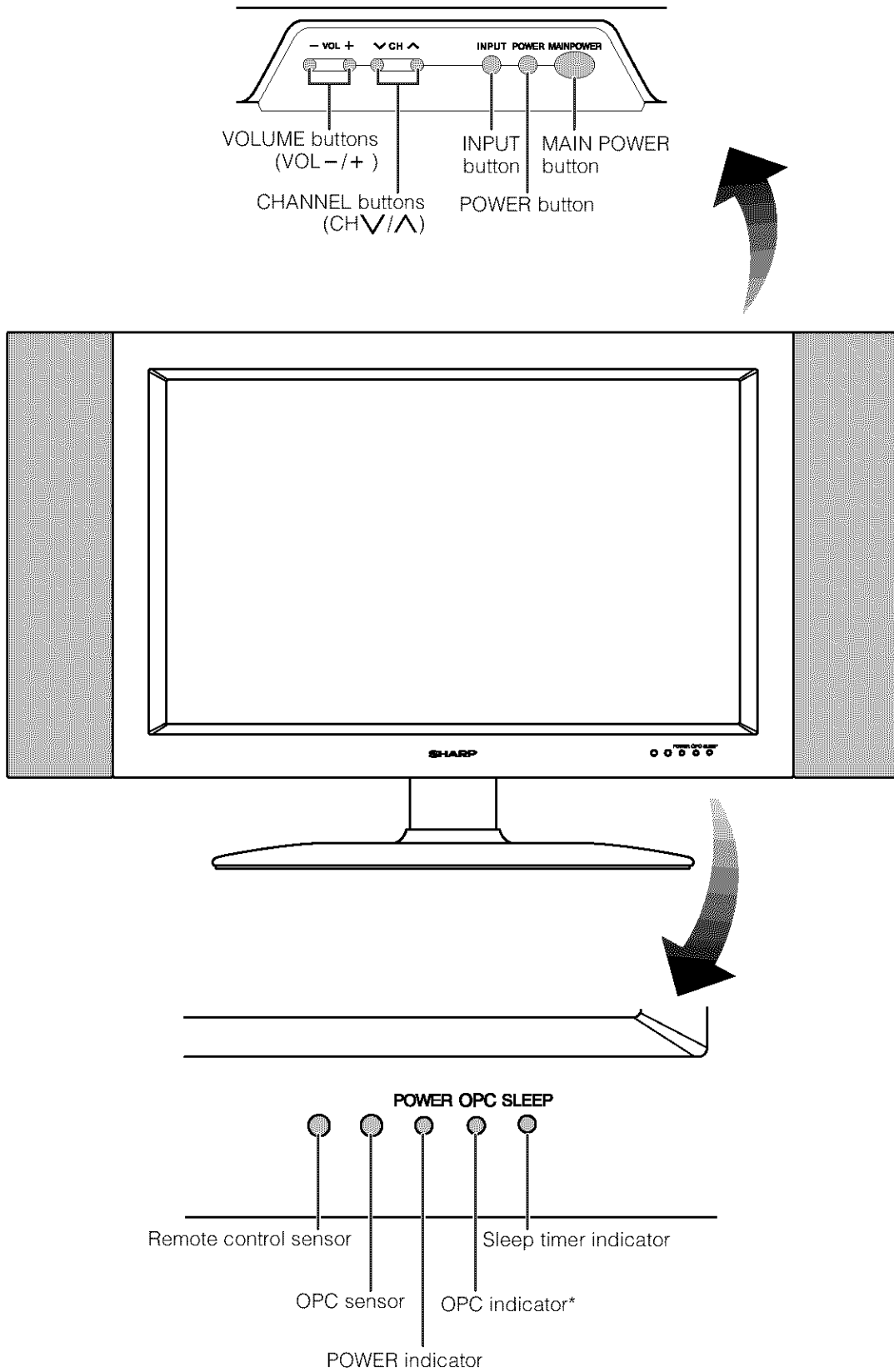

\*OPC: Optical Picture Control

## Part names

### AVC System

#### Front view

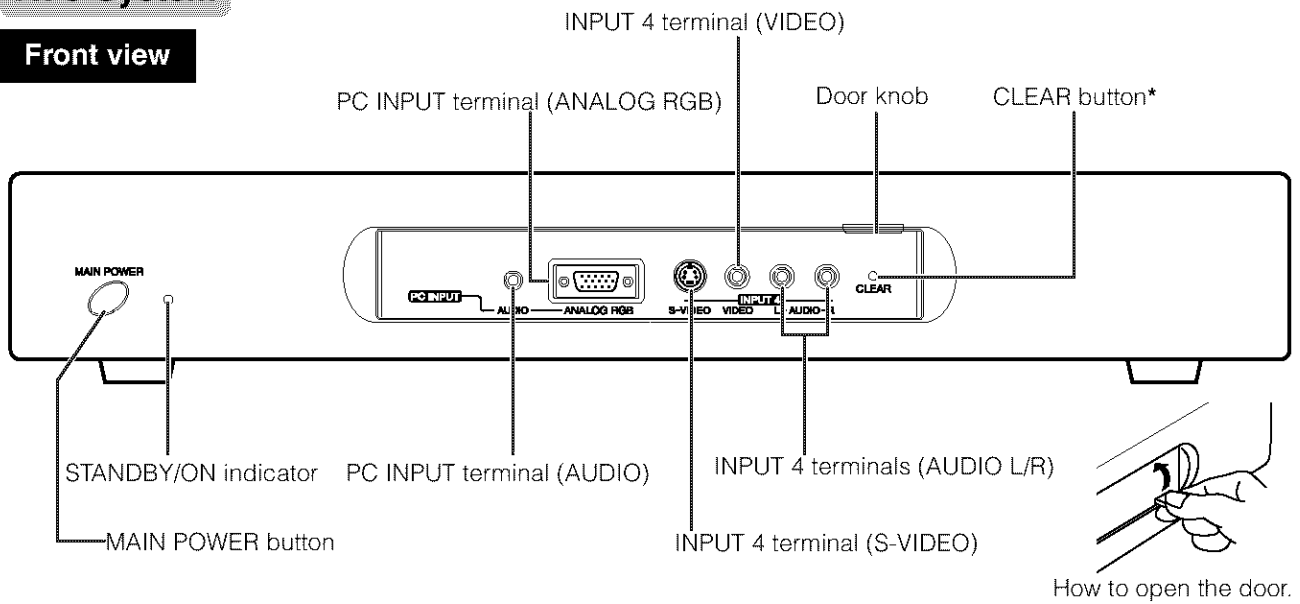

\* If you're having problems operating the AVC System and want to return to normal screen, even when it stays on (the indicator lights green), press **CLEAR** on the AVC System. Pressing **CLEAR** resets the System as shown below.

- AV MODE resets to STANDARD
- TV channel returns to initial channel setting (Air:2ch, Cable:1 or 2ch)
- Twin picture resets to normal
- Audio setting initializes
- SRS resets to off
- Image position initializes

#### NOTE

- Pressing **CLEAR** will not work if the System is in standby mode (indicator lights red).
- Pressing **CLEAR** will not delete channel preset or secret number. See Page 58 for initializing factory preset settings when you know your secret number. See Page 77 for initializing factory preset values when you have forgotten your secret number.

#### Rear view

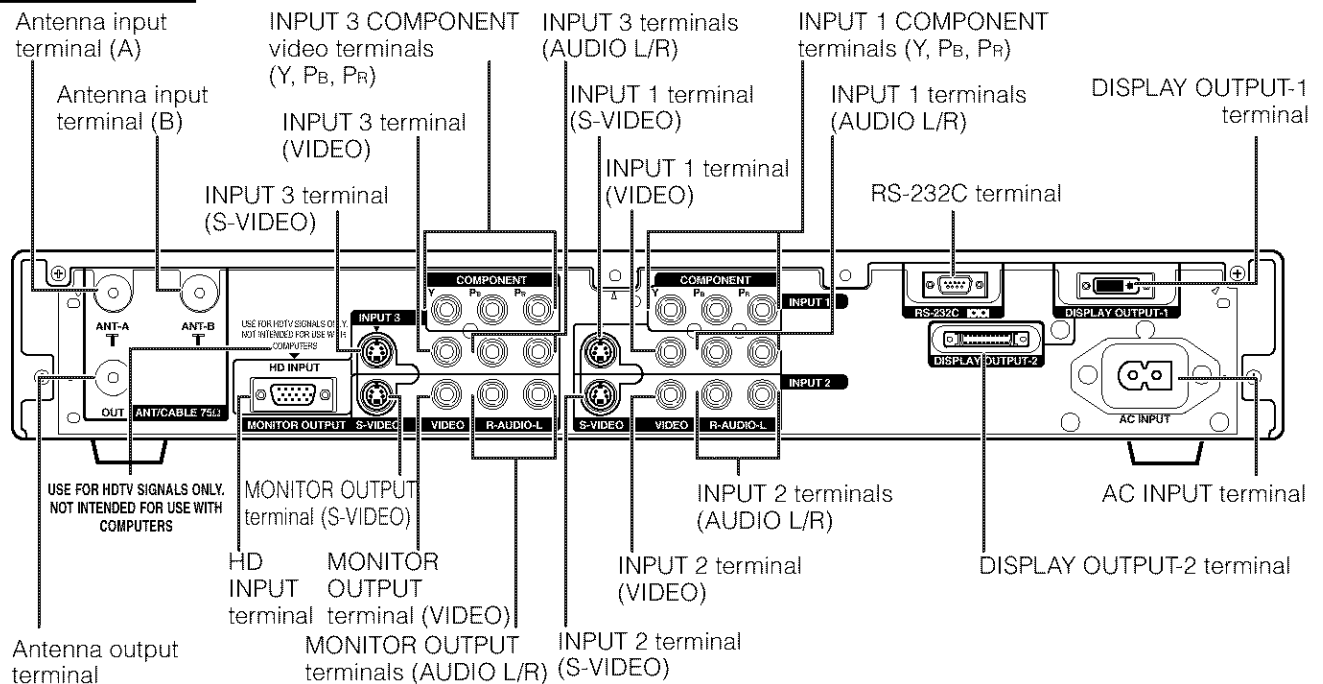

**Remote control unit**

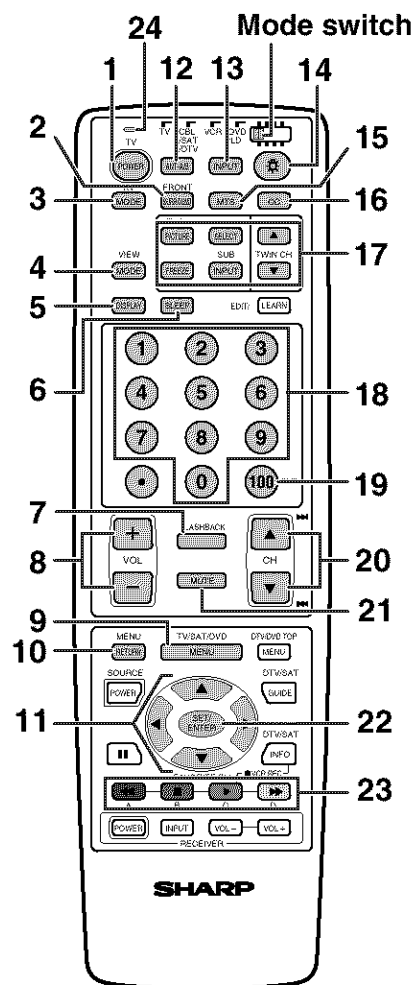

**NOTE**

- When using the remote control unit, point it at the Liquid Crystal Television.
- See pages 62 to 69 for operating buttons not listed on this page.

\* SRS and the (●)® symbol are trademarks of SRS Labs, Inc. SRS technology is incorporated under license from SRS Labs, Inc. FOCUS and the (●)® symbol are trademarks of SRS Labs, Inc. FOCUS technology is incorporated under license from SRS Labs, Inc.

**Set the mode switch to TV.**

- TV POWER:** Switch the Liquid Crystal Television power on or off.
- FRONT SURROUND:** Set SRS\* and FOCUS\* Sound System mode.
- AV MODE:** Select an audio or video setting.  
(AV mode: STANDARD, DYNAMIC, MOVIE, GAME, USER.  
PC mode: STANDARD, USER.)
- VIEW MODE:** Select the screen size.
- DISPLAY:** Display the channel information.
- SLEEP:** Set the sleep timer.
- FLASHBACK:** Return to the previous channel or input external mode.
- VOL +/-:** Set the volume.
- MENU:** Display the menu screen.
- MENU RETURN:** Return to the previous menu screen.
- ▲/▼/◀/▶:** Select a desired item on the screen.
- ANT-A/B:** Select the antenna. (A, B) (See page 13 for details.)
- INPUT:** Select a Liquid Crystal Television input source. (TV, INPUT 1, INPUT 2, INPUT 3, INPUT 4, PC)
- ☼:** When pressed all buttons on the remote control unit will light. The lighting will turn off if no operations are performed within about 5 seconds. This button is used for performing operations in dark places.
- MTS:** Select the MTS/SAP.
- CC:** Display captions during closed-caption source.
- TWIN CH buttons**  
**TWIN PICTURE:** Set the twin picture mode. Press again to return to normal screen.  
**FREEZE:** Set the still image. Press again to return to normal screen.  
**SELECT:** Select the active screen.  
**SUB INPUT:** Select an input source of sub screen.  
**TWIN CH ▲/▼:** Select the channel of sub screen.
- 0 - 9:** Set the channel.
- 100 ENT:** Select the three digit mode. Execute a command of the channel.
- CH ▲/▼:** Select the channel.
- MUTE:** Mute the sound.
- SET/ENTER:** Execute a command.
- FAVORITE CH**  
**A, B, C, D:** Select any of four preset channels. (See page 27 for details.) While watching, you can toggle the selected channels by pressing A, B, C and D.
- LED for transmission confirmation**

# Watching TV

Simple operations for watching a TV program

## Basic connection

To enjoy a clearer picture, use an outdoor antenna. The following is a brief explanation of the types of connections that are used for a coaxial cable. If your outdoor antenna uses a 75-ohm coaxial cable with an F-type connector, plug it into the antenna terminal at the rear of the AVC System.

### NOTE

- The antenna and the cable converter cannot be connected at the same time.

## Connecting the VHF/UHF antenna

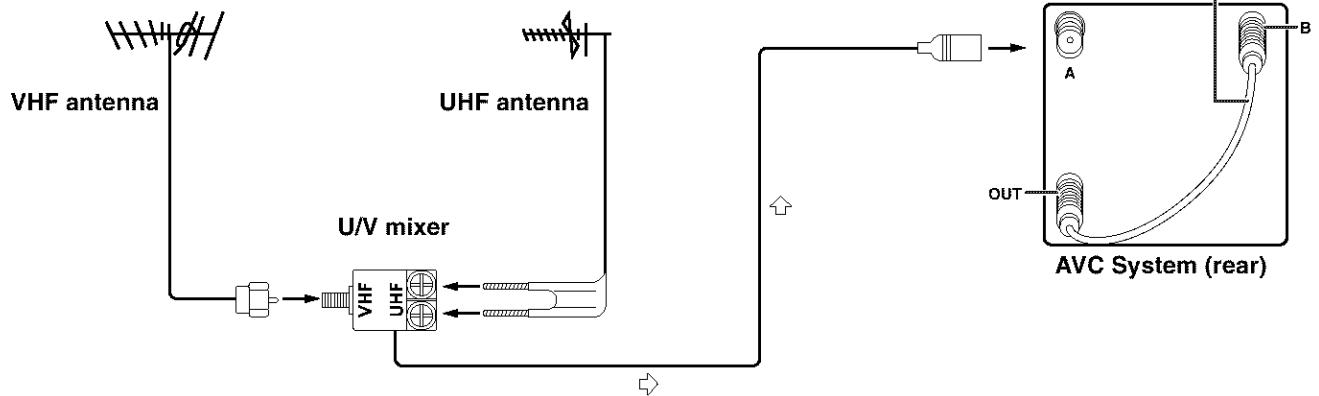

The coaxial cable is already connected at the time of purchase.

## Connecting the cable converter

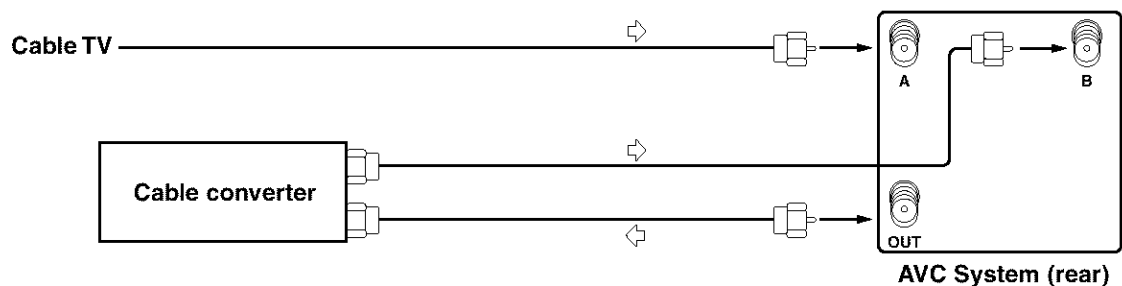

### NOTE

- Be sure connect the antenna or the cable converter as explained above. Signal reception may fail if not properly connected.
- Be sure that the cable converter output signal is assigned to the ANT-B input on the AVC System.
- How to change channels when the cable converter output signal is connected to the ANT-B input on the AVC System.
  - Press **ANT-A/B** on the remote control unit to switch to ANT-B.
  - You can view an image right after selecting the output channel on the cable converter.

## Switching between Tuner A and Tuner B

To watch broadcasts via the two tuners, you can select it by pressing **ANT-A/B** on the remote control unit.

- While watching a broadcast, press **ANT-A/B** to view the image received from the other tuner.
- Pressing **ANT-A/B** while viewing in Twin Picture mode (TV image and video image) with TV selected will display the TV image of the other tuner.
- Pressing **ANT-A/B** while viewing Twin Picture with video selected will not change the image displayed.
- Pressing **ANT-A/B** while viewing Twin Picture with two TV images displayed will not have any effect.
- Pressing **ANT-A/B** while viewing Twin Picture with two video images displayed will switch the selected screen to a TV image.

### Using Headphones

You can use a pair of headphones (3.5 mm  $\varnothing$  mini-jack) to listen to the sound.

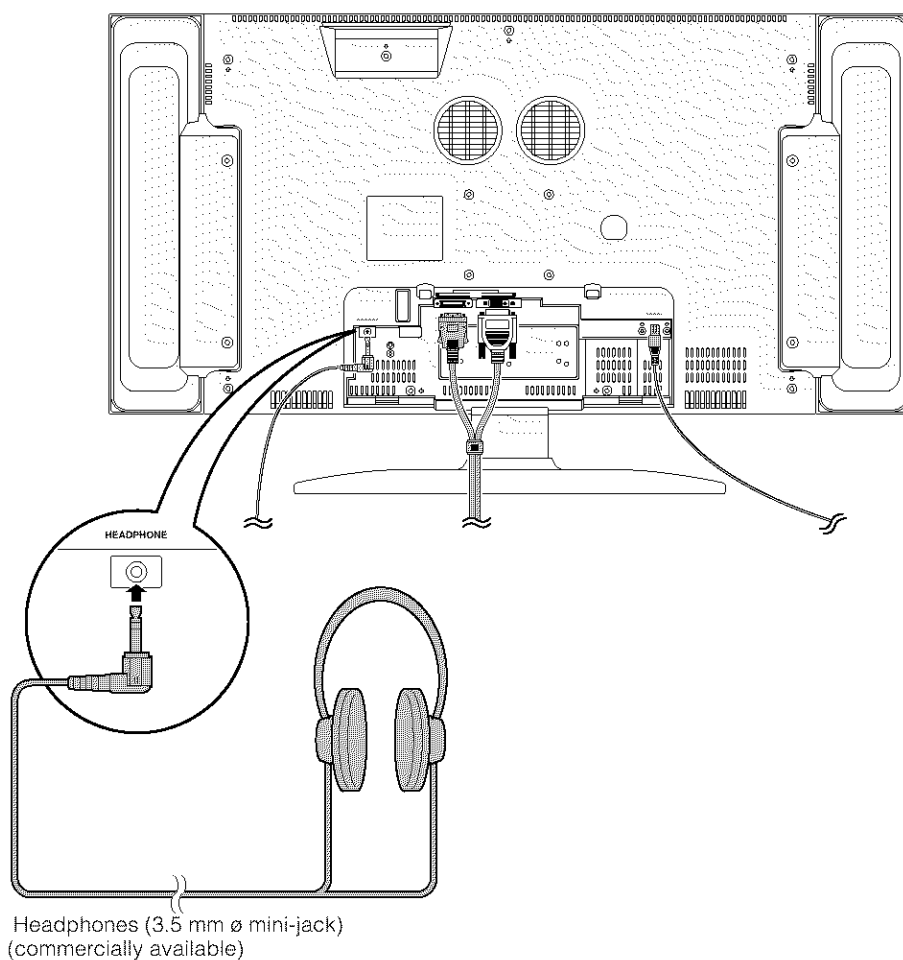

#### NOTE

- When connecting headphones, the sound from the display speakers is muted.

## Watching TV

### Connecting the AC cord

Connect the AC cord after all component connections have been completed.

#### Display (bottom view)

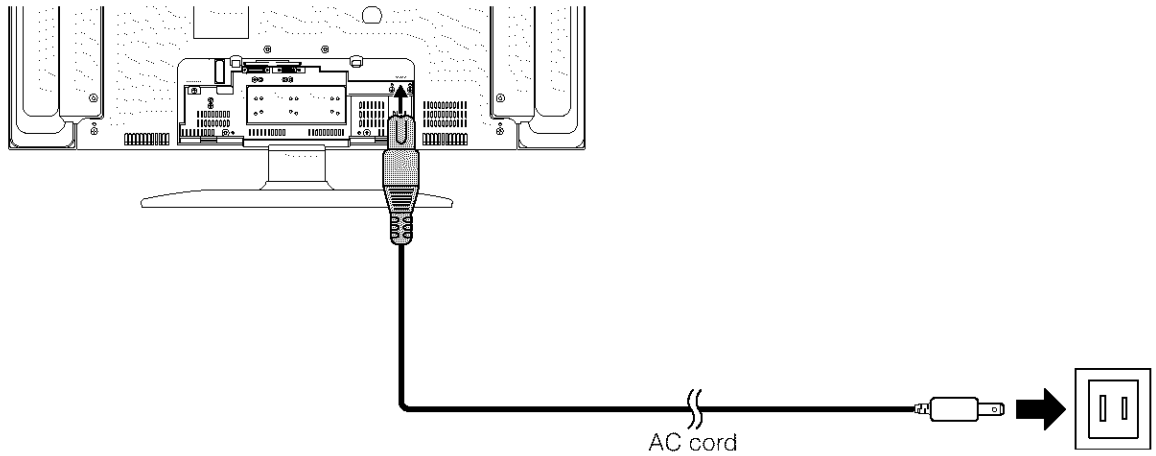

#### AVC System (rear view)

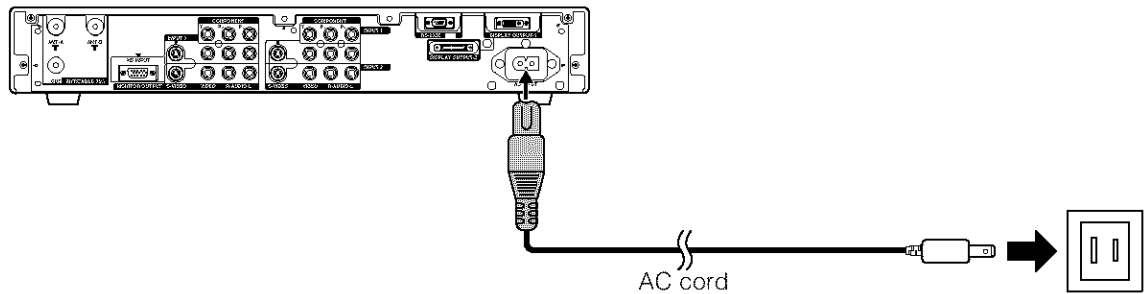

#### CAUTION

- Use only the AC cord provided.
- Do not use power supply voltage other than that indicated (AC 120 V, 60 Hz). The violation may cause fire or electric shock.

#### NOTE

- Always turn off the main power of the Display and AVC System when connecting the AC cords.
- Disconnect the AC cords from the AC outlet, Display and AVC System when the System is not going to be used for a long period of time.



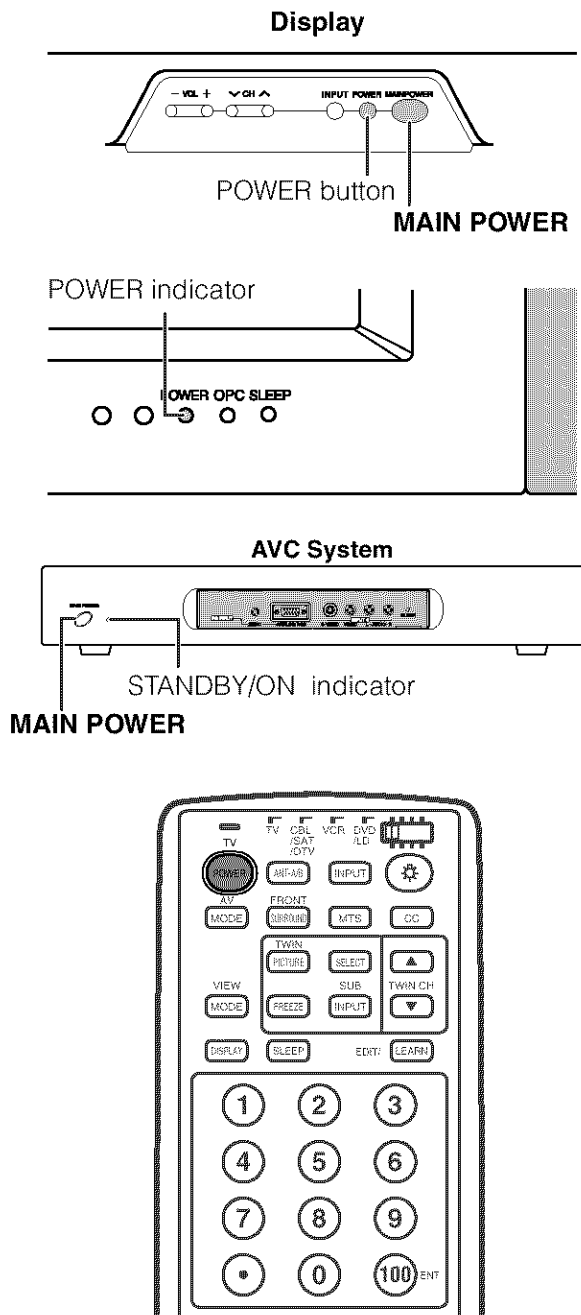

### Turning on the power

- 1 Press **MAIN POWER** on the Display.
  - The POWER indicator on the Display flashes red.
- 2 Press **MAIN POWER** on the AVC System.
  - The System turns the power on.
  - The POWER indicator on the Display lights up green and the STANDBY/ON indicator on the AVC System lights up in green.
  - If the STANDBY/ON indicator on the AVC System and the POWER indicator on the Display still light up red, press **TV POWER** on the remote control unit or **MAIN POWER** on the AVC System to turn the System on.

### First time turning on the AVC System

- 1 Press **MAIN POWER** on the AVC System.
  - The STANDBY/ON indicator on the AVC System lights up red.
- 2 Press **MAIN POWER** on the Display.
  - The System turns the power on.
  - The POWER indicator on the Display lights up green and the STANDBY/ON indicator on the AVC System lights up in green.
  - If the STANDBY/ON indicator on the AVC System and the POWER indicator on the Display still light up red, press **TV POWER** on the remote control unit or **POWER** button on the Display to turn the System on.

**NOTE**

- In this manual, "System" means the Display and AVC System.

### Turning off the power

- 1 Press **TV POWER** on the remote control unit or **POWER** button on the Display.
  - The System enters standby mode and the image on the screen disappears.
  - Both the STANDBY/ON indicator on the AVC System and the POWER indicator on the Display change from green to red.
- 2 Press **MAIN POWER** on the AVC System.
  - The STANDBY/ON indicator on the AVC System turns off and the POWER indicator on the Display flashes red.
- 3 Press **MAIN POWER** on the Display.
  - The POWER indicator on the Display turns off after approximately 5 seconds.

**NOTE**

- If you are not going to use this System for a long time, be sure to remove the AC cord from the power outlet.

### Display status indicator

Off	Power off
Flashing red	AVC System does not turn on or its AC cord is disconnected.
Red	The System is in standby mode.
Green	The System turns the power on.

### AVC System status indicator

Off	Power off
Red	Only the AVC System is in standby mode or the System is in standby mode.
Green	The System turns the power on.

### Initial setup

When you turn on the System for the first time, it will automatically memorize the broadcasting channels where you live. Perform the following steps before you press **TV POWER** on the remote control unit.

1. Insert the batteries into the remote control unit. (See page 9.)
2. Connect the antenna cable to the AVC System. (See page 13.)
3. Plug in the AC cord to the AC outlet. (See page 15.)

#### Language menu

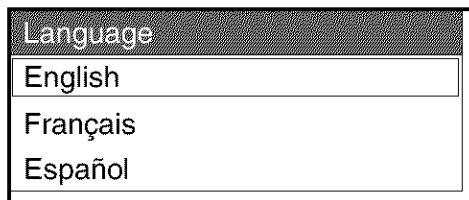

#### Antenna menu

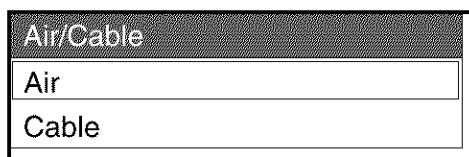

#### Searching TV channels

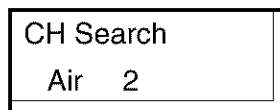

### 1. Setting a language

- ① Press **▲/▼** to select the desired language listed on the screen.
- ② Press **SET/ENTER** to enter the setting.

### 2. Setting the antenna mode

- ① Press **▲/▼** to select "Air" or "Cable" on the screen.
- ② Press **SET/ENTER** to enter the setting.

### 3. Automatic channel searching

Channel auto search makes the System look for all channels viewable in the set area.

#### NOTE

- If no channel is found, "No program found. Is antenna connected properly?" displays. And the auto channel search finishes.
- If you want to try EZ Setup again, see page 25.
- Channel search function is available for ANT-A only.
- ANT-B cannot perform channel search.
- You may need to manually add the cable converter output channel setting (fixed), when connecting the cable converter output signal to the B terminal (ANT/CABLE 75Ω) on the AVC System (rear).(See page 27.)

Display

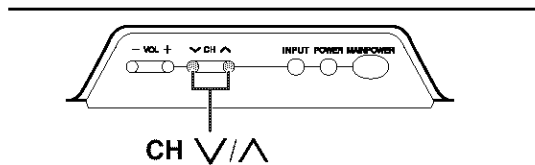

Channel display

(The image displays an example.)

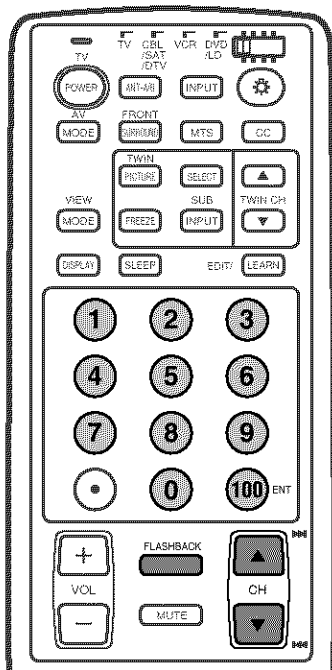

Simple button operations for changing channels

Using CH▲/▼ on the remote control unit

- Press **CH▲** to increase the channel number.
- Press **CH▼** to decrease the channel number.

NOTE

- **CH V/∧** on the Display operates the same as **CH▲/▼** on the remote control unit.

Changing channels with CH▲/▼ on the remote control unit or CH V/∧ on the Display

Air: Press **CH▲** and the channel change in the order shown below:

2→3→...→68→69→2→3...

Press **CH▼** and the channel change in the order shown below:

3→2→69→68→...→3→2...

Cable: Press **CH▲** and the channel change in the order shown below:

1→2→3→...→125→1→2→3...

Press **CH▼** and the channel change in the order shown below:

3→2→1→125→...→3→2→1→...

Using FLASHBACK on the remote control unit

Press **FLASHBACK** to switch the currently tuned channel to the previously tuned channel. Press **FLASHBACK** again to switch back to the currently tuned channel.

Using 0 – 9 and 100 on the remote control unit

Select the channels directly by pressing buttons **0** to **9** and **100**.

- The System allows you to select up to 125 channels (1 to 125). To select a channel, enter a 2 or 3-digit number.

EXAMPLE

To select a 1 or 2-digit channel number (e.g., Channel 5):

Complete the following steps within 3 seconds.

- 1 Press the **0** button.
  - Complete the step 2 within 3 seconds after the step 1.
- 2 Press the **5** button.

NOTE

- When selecting a 1-digit channel number, do not fail to press the **0** button.

To select a 3-digit channel number (e.g., Channel 115):

Complete the following steps within 3 seconds.

- 1 Press the **100** button.
  - Complete the step 2 within 3 seconds after the step 1.
- 2 Press the **1** button.
  - Complete the step 3 within 3 seconds after the step 2.
- 3 Press the **5** button.

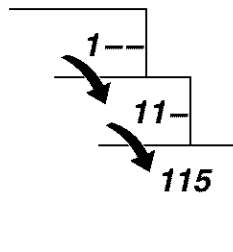
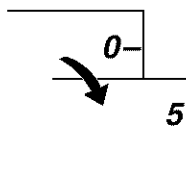

Display

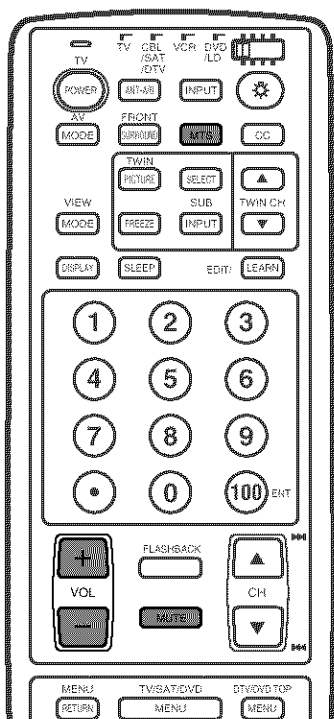
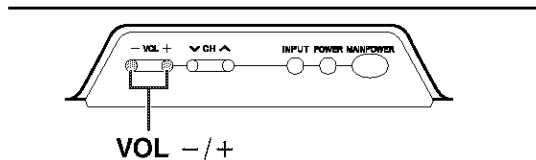

Simple button operations for changing volume/sound

Using VOL +/- on the remote control unit

- To increase the volume, press VOL +.
- To decrease the volume, press VOL -.

NOTE

- VOL -/+ on the Display operates the same as VOL +/- on the remote control unit.

Audio status

Output device	Audio out	
	Fixed	Variable
Speaker	Variable sound	Mute
MONITOR OUT	Constant as specified	Variable sound

- \* When "Audio Out" is set to "Variable", the indicator on the screen changes as shown below.

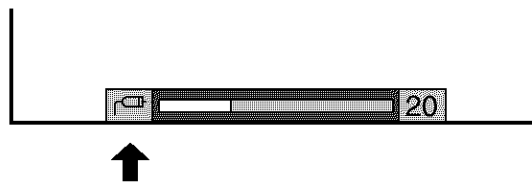

NOTE

- See page 52 for details on the audio out function.

Volume adjustment



Mute

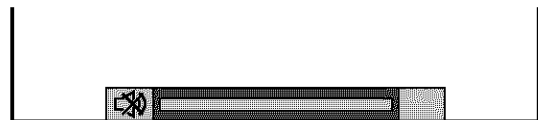

Using MUTE on the remote control unit

Mutes the current sound output.

1 Press MUTE.

- "M" has been displayed on the screen for 8 minutes, and the sound is silenced.

NOTE

- Within 8 minutes of pressing MUTE, mute can be canceled by using one of the two methods below.
  - Pressing VOL +/- on the Display or VOL +/-, MTS or MUTE on the remote control unit can also cancel the mute.
  - Changing channels can also cancel the mute.
- Mute will be canceled after 8 minutes have passed. However, the System will not suddenly output a loud sound as the volume level is set to 0 automatically.

2 Within 8 minutes, Press MUTE again to cancel the mute.

- Before 8 minutes, the volume level returns to the previous setting.
- After 8 minutes, increase the volume level by pressing VOL +/- on the Display or VOL +/- on the remote control unit.

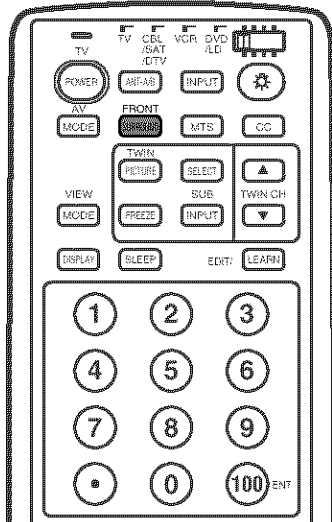

### Using FRONT SURROUND on the remote control unit

**(●)** produces SRS and FOCUS effects from the speakers.

Each time you press **FRONT SURROUND**, the mode changes among SRS, FOCUS, FOCUS + SRS and off.

#### SRS sound options

- SRS (Sound Retrieval System): Creates more a natural sound retrieving the spatial information from any stereo recording and restoring the original three-dimensional sound field.
- FOCUS: Repositions a sound image from two speakers to a more optimal listening position or height without moving them.
- FOCUS + SRS: Produces both SRS and FOCUS effects.
- off: Outputs the normal sound.

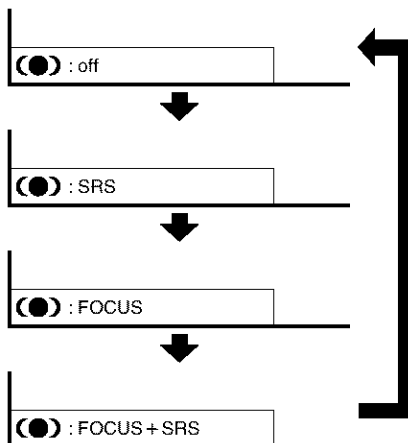

## Setting MTS/SAP stereo mode

The System has a feature that allows reception of sound other than the main audio for the program. This feature is called Multi-channel Television Sound (MTS). The System with MTS can receive mono sound, stereo sound and Secondary Audio Programs (SAP). The SAP feature allows a TV station to broadcast other information, which could be audio in another language or something completely different like weather information.

**You can enjoy Hi-Fi stereo sound or SAP broadcasts where available.**

- **Stereo broadcasts**

View programs like live sporting events, shows and concerts in dynamic stereo sound.

- **SAP broadcasts**

Receive TV broadcasts in either MAIN or SAP sound.

MAIN sound: The normal program soundtrack (either in mono or stereo).

SAP sound: Listen to second language, supplementary commentary and other information. (SAP is mono sound.)

**If stereo sound is difficult to hear.**

- Obtain a clearer sound by manually switching to fixed mono-sound mode.

**NOTE**

- Once "MONO" mode is selected, the sound remains mono even if the System receives a stereo broadcast. You must switch the mode back to "STEREO" if you want to hear stereo sound again.
- Selecting MTS while in the input mode does not change the type of sound. In this case, sound is determined by the video source.

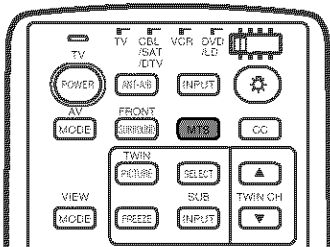

Each time you press **MTS**, MTS toggles as shown below.

(The images display examples when receiving MTS and SAP.)

**STEREO mode**

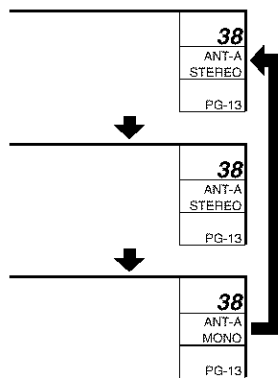

**MAIN + SAP mode**

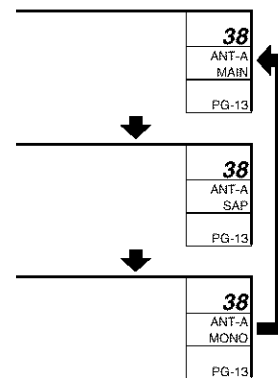

**STEREO + SAP mode**

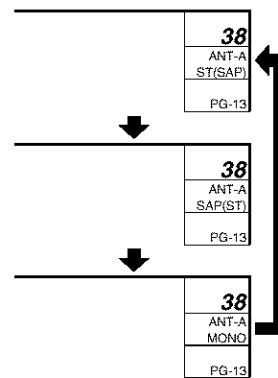

**MONO mode**

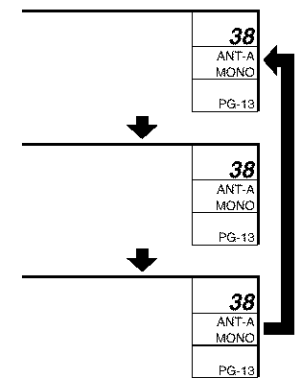

# Basic adjustment settings

## TV/VIDEO mode menu items

List of AV menu items to help you with operations.

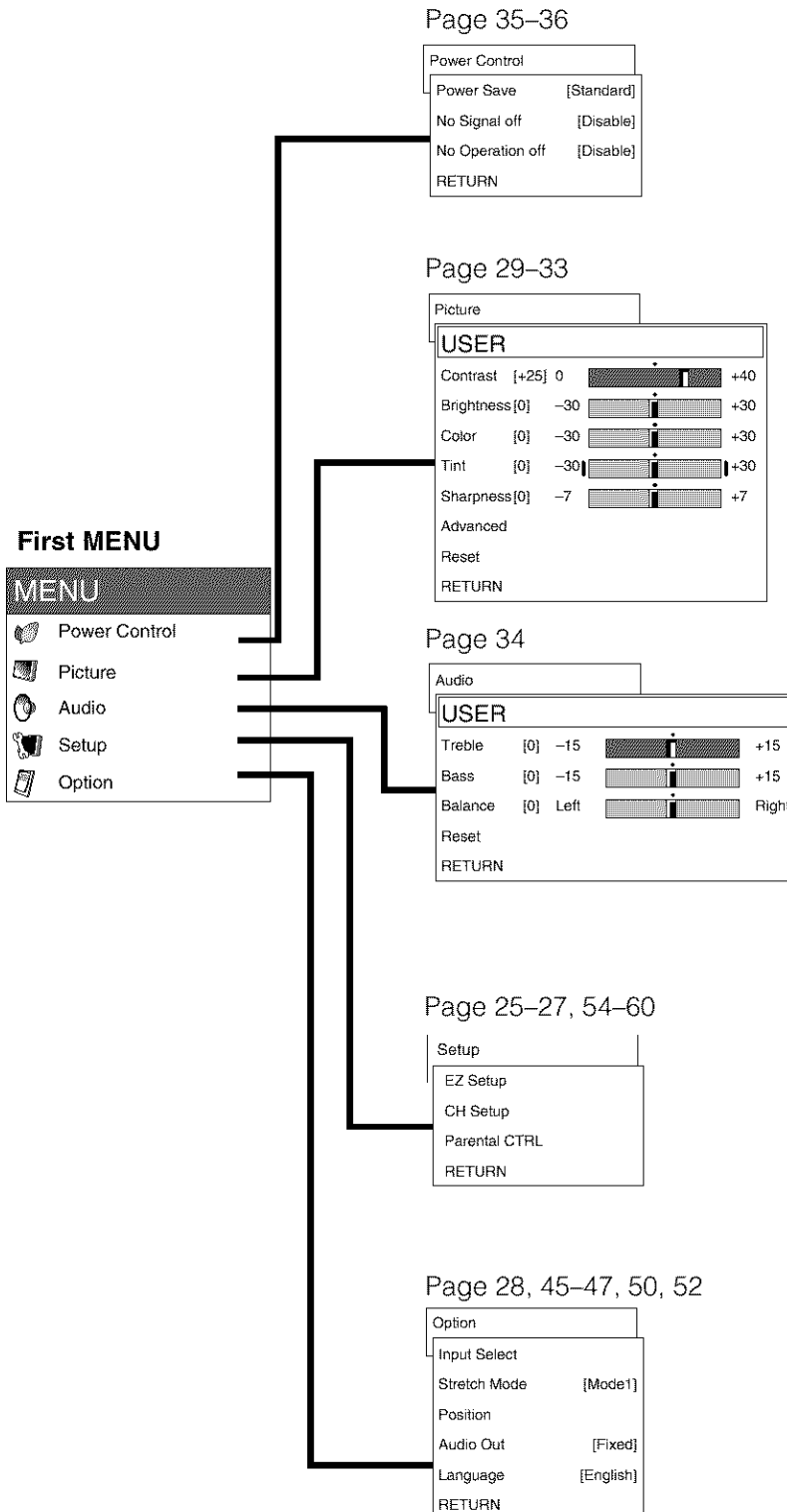

MENU	Description
<b>Power Save</b>	Save power by decreasing picture brightness.
<b>No Signal off</b>	System automatically shuts down if no signal inputs for 15 minutes.
<b>No Operation off</b>	System automatically shuts down if you do not operate the System for 3 hours.

MENU	Description
<b>Contrast</b>	Adjusts the picture between light and shade.
<b>Brightness</b>	Adjusts picture brightness.
<b>Color</b>	Adjusts color intensity.
<b>Tint</b>	Adjusts skin color to a more natural tone.
<b>Sharpness</b>	Adjusts picture sharpness.
<b>Advanced</b>	Adjusts "Color Temp", "Black", "3D-Y/C", "Monochrome", "Film Mode", "I/P Setting", "Cool Climate" and "Vivid Color".
<b>Reset</b>	All image adjustment settings return to the factory preset values.

MENU	Description
<b>Treble</b>	Adjusts the treble weaker or stronger.
<b>Bass</b>	Adjusts the bass weaker or stronger.
<b>Balance</b>	Adjusts audio output between left and right speakers.
<b>Reset</b>	All audio adjustment settings return to the factory preset values.

MENU	Description
<b>EZ Setup</b>	Automatically memorize the broadcasting channels where you live.
<b>CH Setup</b>	Sets the channel preset.
<b>Parental CTRL</b>	Sets a secret number to restrict operations.

MENU	Description
<b>Input Select</b>	Select the kind of input signal of each input source.
<b>Stretch Mode</b>	Select stretch mode display setting.
<b>Position</b>	Adjusts the horizontal/vertical position of the image displayed.
<b>Audio Out</b>	Select the type of monitor output. You can adjust volume for the main speaker or monitor output.
<b>Language</b>	Select the on screen display language.

# Basic adjustment settings

## PC mode menu items

List of PC menu items to help you with operations.

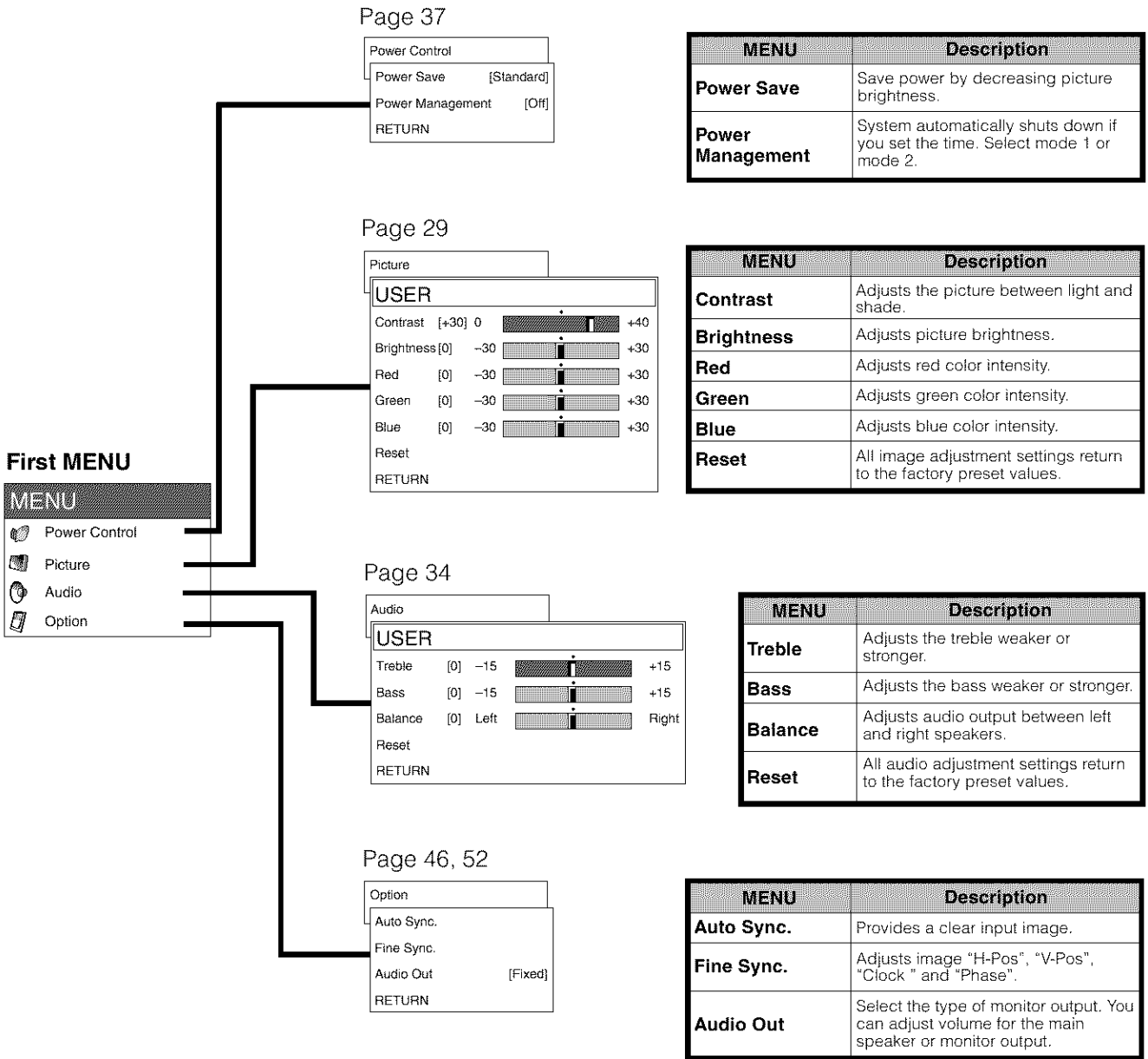



## Basic adjustment settings

### Moving the picture on the screen

You can move the picture around on the screen.

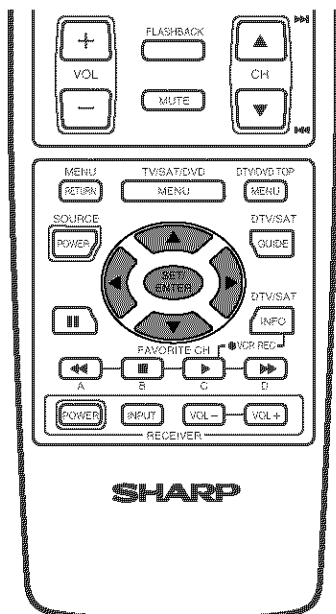

Press ▲/▼/◀/▶ to move an image on the screen to the desired position.

#### NOTE

- While pressing ▲/▼/◀/▶, an on-screen image, "Adjusting Position" displays to the desired position.
- This setting cannot be stored. Once the System shuts down or enters standby mode, the setting is erased. To move the picture around the screen again, you must perform the above procedure again.
- An on-screen image from a PC source cannot be moved around.
- Initialize the image position by pressing **SET/ENTER**.

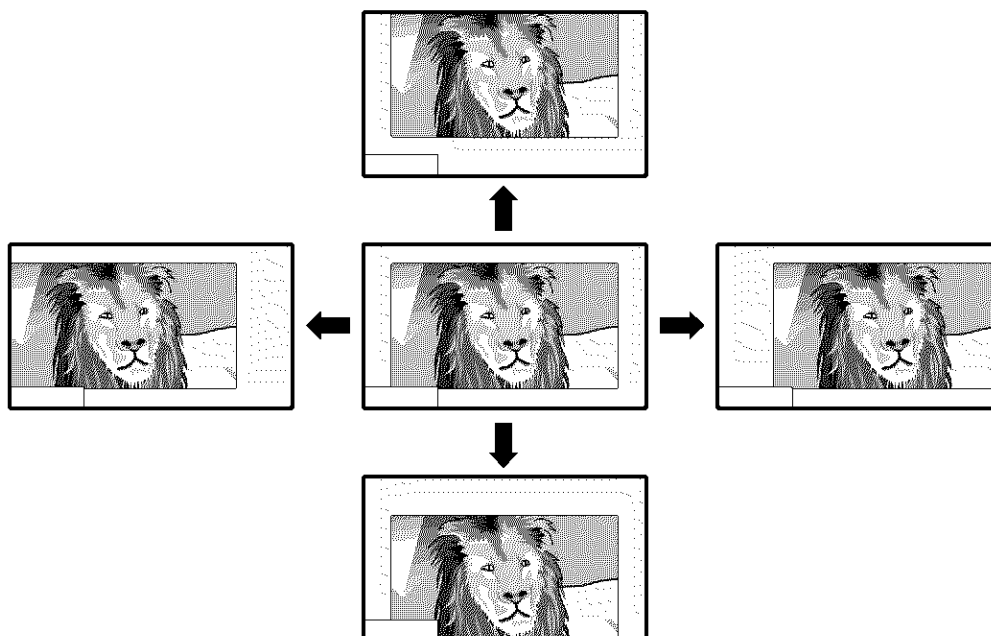

## Basic adjustment settings

### EZ Setup

You can run EZ Setup again, even after setting up the preset channels.

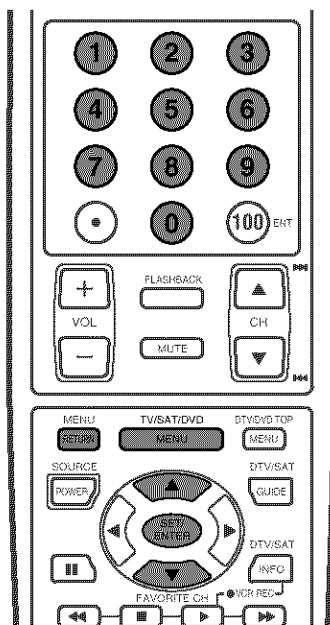

#### Secret number setting menu

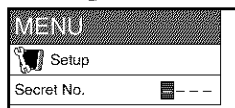

#### Setup menu

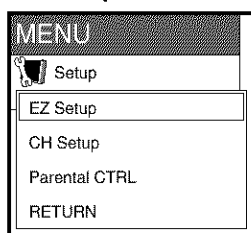

#### Language menu

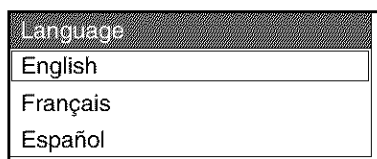

#### Antenna menu

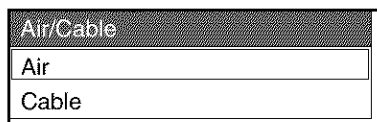

#### Searching TV channels

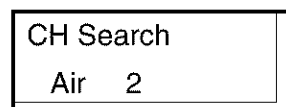

### Language setting

Select from among 3 languages: English, French and Spanish.

- 1 Press **MENU**.
- 2 Press **▲/▼** to select "Setup", and then press **SET/ENTER**.
  - Secret number setting menu displays only when "Secret No." is set. (See page 58.)
  - Setup menu displays when the "Secret No." is not set. Skip step 3.
- 3 Enter your 4-digit secret number with **0–9** to cancel the "Secret No." when you set it.
- 4 Press **▲/▼** to select "EZ Setup", and then press **SET/ENTER**.
  - Language menu displays.
- 5 Press **▲/▼** to select the desired language listed on the screen, and then press **SET/ENTER**.
  - Antenna menu displays.

#### NOTE

- Return to the previous menu by pressing **MENU RETURN**.

### 6 Antenna setting

After setting the language, perform settings for the Antenna connected.

Press **▲/▼** to select the desired item, and then press **SET/ENTER**.

- After setting the Antenna, channel search starts.

#### NOTE

- Return to the previous menu by pressing **MENU RETURN**.

### 7 Channel search

After performing language and Antenna settings, the System's channel auto search automatically looks for all viewable channels in the set area.

## Channel setup

If initial setup does not memorize all the channels in your region, follow the instructions below to manually memorize the channels.

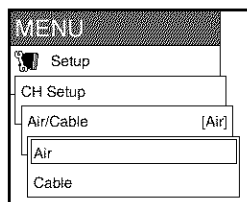
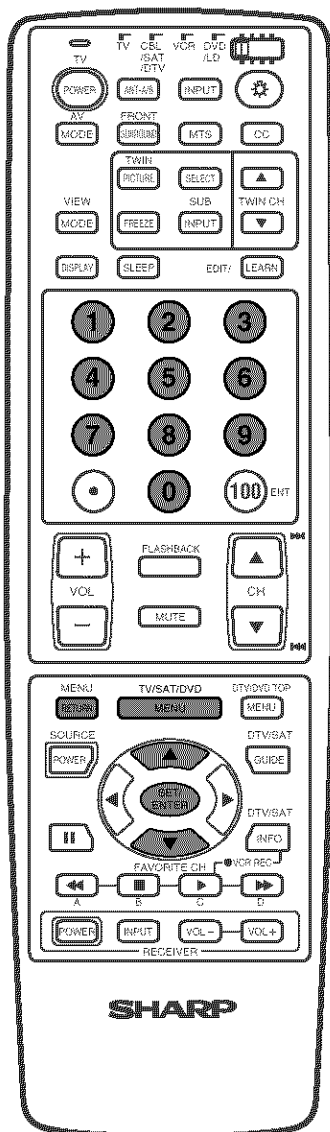

### Setting the Air/Cable

- 1 Press **MENU**.
- 2 Press **▲/▼** to select "Setup", and then press **SET/ENTER**.
  - Secret number setting menu displays only when "Secret No." is set. (See page 58.)
  - Setup menu displays when the "Secret No." is not set. Skip step 3.
- 3 Enter your 4-digit secret number with **0–9** to cancel the "Secret No." when you set it.
- 4 Press **▲/▼** to select "CH Setup", and then press **SET/ENTER**.
- 5 Press **▲/▼** to select "Air/Cable", and then press **SET/ENTER**.
- 6 Press **▲/▼** to select the desired item, and then press **SET/ENTER**.
- 7 Press **MENU** to exit the menu.

#### NOTE

- Return to the previous menu by pressing **MENU RETURN**.
- When you change the Air/Cable setting, perform channel search again.

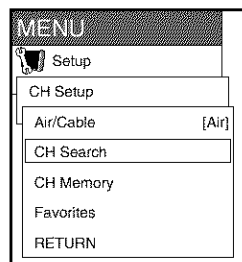

### Automatic channel searching

Channel auto search makes the System look for all channels viewable in the set area.

- 1 Press **MENU**.
- 2 Press **▲/▼** to select "Setup", and then press **SET/ENTER**.
  - Secret number setting menu displays only when "Secret No." is set. (See page 58.)
  - Setup menu displays when the "Secret No." is not set. Skip step 3.
- 3 Enter your 4-digit secret number with **0–9** to cancel the "Secret No." when you set it.
- 4 Press **▲/▼** to select "CH Setup", and then press **SET/ENTER**.
- 5 Press **▲/▼** to select "CH Search", and then press **SET/ENTER**.
  - Channel search automatically starts.
- 6 Press **MENU** to exit the menu.

#### NOTE

- Return to the previous menu by pressing **MENU RETURN**.
- Channel search function is available for ANT-A only.
- ANT-B cannot perform channel search.
- You may need to manually add the cable converter output channel setting (fixed), when the cable converter is used. (See page 27.)

## Basic adjustment settings

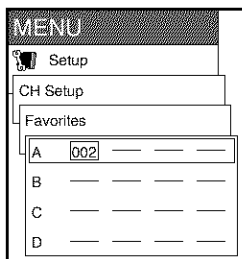
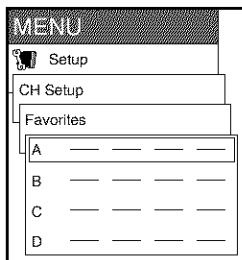
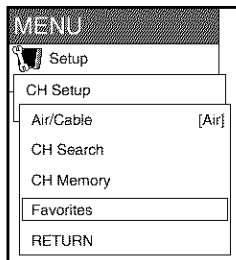
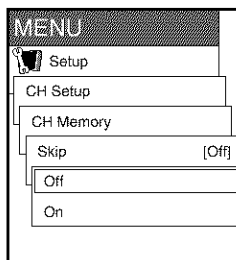
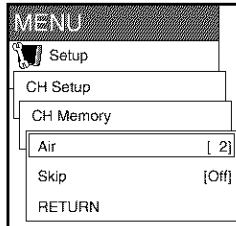
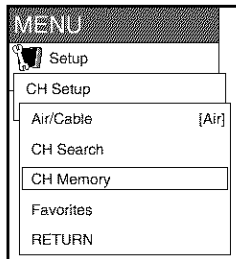
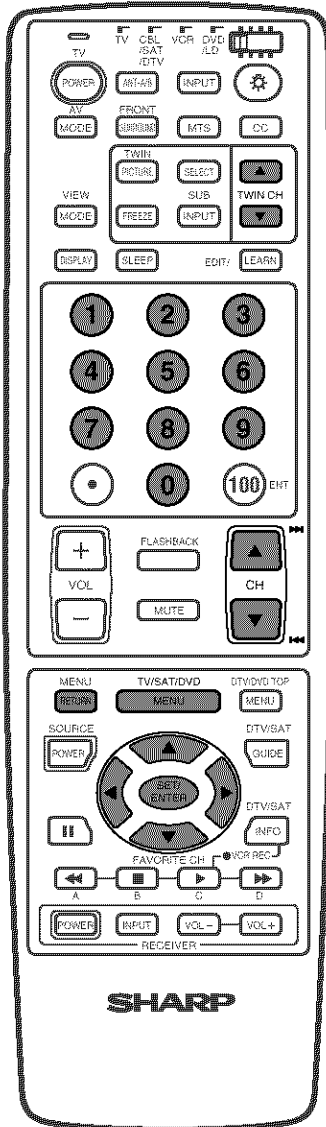

### Saving broadcast TV channels to memory

- 1 Press **MENU**.
- 2 Press **▲/▼** to select "Setup", and then press **SET/ENTER**.
  - Secret number setting menu displays only when "Secret No." is set. (See page 58.)
  - Setup menu displays when the "Secret No." is not set. Skip step 3.
- 3 Enter your 4-digit secret number with **0–9** to cancel the "Secret No." when you set it.
- 4 Press **▲/▼** to select "CH Setup", and press **SET/ENTER**.
- 5 Press **▲/▼** to select "CH Memory", and press **SET/ENTER**.
- 6 Press **▲/▼** to select "Air [2]".
- 7 Press **◀▶** to select the channel you want to skip or not.
- 8 Press **▲/▼** to select "Skip", and press **SET/ENTER**.
- 9 Press **▲/▼** to select "On" or "Off", and press **SET/ENTER**. Repeat the same steps for other channels.
  - On: Skips channels. (Channel selection disabled using **CH▲/▼** and **TWIN CH▲/▼**.)
  - Off: Does not skip channels. (Channel selection enabled using **CH▲/▼** and **TWIN CH▲/▼**.)

#### NOTE

- Return to the previous menu by pressing **MENU RETURN**.
- Channel memory function is available for ANT-A only.
- ANT-B cannot perform channel search.
- You may need to manually add the cable converter output channel setting (fixed), when the cable converter using.

### Setting the favorite channels

This function allows you to program 4 favorite channels, in 4 different categories. (A total of 16 channels.) By setting the favorite channels in advance, you can select your favorite channels easily.

- 1 Press **MENU**.
- 2 Press **▲/▼** to select "Setup", and then press **SET/ENTER**.
  - Secret number setting menu displays only when "Secret No." is set. (See page 58.)
  - Setup menu displays when the "Secret No." is not set. Skip step 3.
- 3 Enter your 4-digit secret number with **0–9** to cancel the "Secret No." when you set it.
- 4 Press **▲/▼** to select "CH Setup", and press **SET/ENTER**.
- 5 Press **▲/▼** to select "Favorites", and press **SET/ENTER**.
- 6 Press **▲/▼** to select the desired memory area(A to D), and press **SET/ENTER**.
- 7 Press **◀▶** to select the position in the area, and then press **▲/▼** to select the desired channel and press **SET/ENTER** to fix the channels. Repeat the same steps to set for other area.
- 8 Press **MENU** to exit the menu.

#### NOTE

- Return to the previous menu by pressing **MENU RETURN**.

## Basic adjustment settings

### Language setting

You can also select a language from the option menu. Select from among 3 languages: English, French and Spanish.

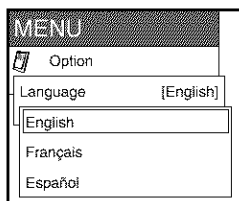
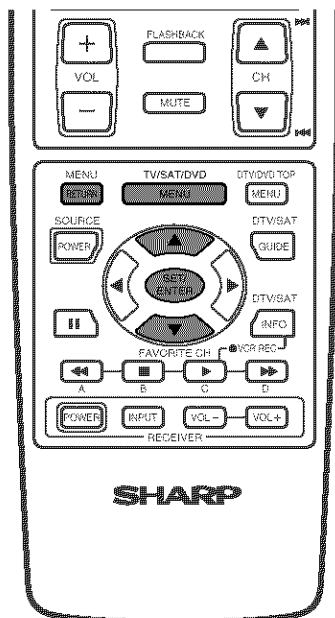

- 1 Press **MENU**.
- 2 Press **▲/▼** to select "Option", and then press **SET/ENTER**.
  - Option menu displays.
- 3 Press **▲/▼** to select "Language", and then press **SET/ENTER**.
  - Language menu displays.
- 4 Press **▲/▼** to select the desired language listed on the screen, and then press **SET/ENTER**.
- 5 Press **MENU** to exit the menu.

#### **NOTE**

- Return to the previous menu by pressing **MENU RETURN**.

## Basic adjustment settings

### Picture adjustments

Adjust the picture to your preference with the following picture settings.

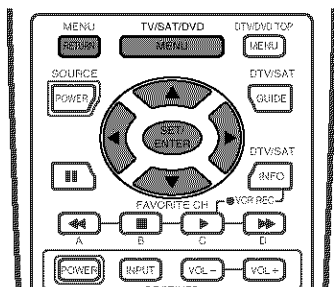
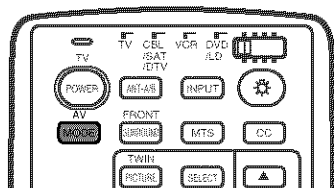

- 1 Press **MENU**.
- 2 Press **▲/▼** to select "Picture", and then press **SET/ENTER**.
  - Picture menu displays.
- 3 Press **▲/▼** to select a specific adjustment item.
- 4 Press **◀/▶** to adjust the item to your desired position.
- 5 Press **MENU** to exit the menu.

#### NOTE

- When all adjustments are set to factory preset values,
  - ① Press **▲/▼** to select "Reset", and then press **SET/ENTER**.
  - ② Press **▲/▼** to select "Yes", and then press **SET/ENTER**.
- Return to the previous menu by pressing **MENU RETURN**.
- If you select "**STANDARD**" with **AV MODE** on the remote control unit, these items will display in gray and not be selectable. See page 48.

#### Adjustments items for AV source

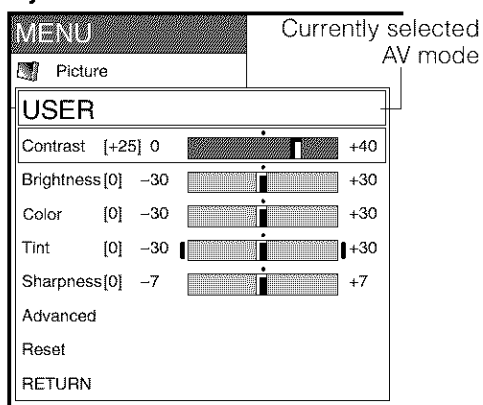

#### Adjustments items for PC source

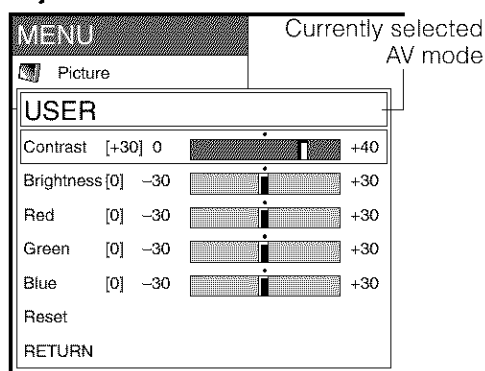

Selected item	◀ button	▶ button
<b>Contrast</b>	For less contrast	For more contrast
<b>Brightness</b>	For less brightness	For more brightness
<b>Color</b>	For less color intensity	For more color intensity
<b>Tint</b>	Skin tones become purplish	Skin tones become greenish
<b>Sharpness</b>	For less sharpness	For more sharpness

Selected item	◀ button	▶ button
<b>Contrast</b>	For less contrast	For more contrast
<b>Brightness</b>	For less brightness	For more brightness
<b>Red</b>	For weaker red	For stronger red
<b>Green</b>	For weaker green	For stronger green
<b>Blue</b>	For weaker blue	For stronger blue

#### NOTE

- Select "Advanced" and then press **SET/ENTER** to set "Color Temp", "Black", "3D-Y/C", "Monochrome", "Film mode", "I/P Setting", "Cool Climate" or "Vivid Color". See pages 30-33.

## Basic adjustment settings

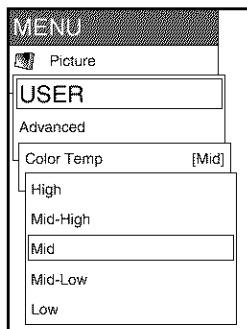
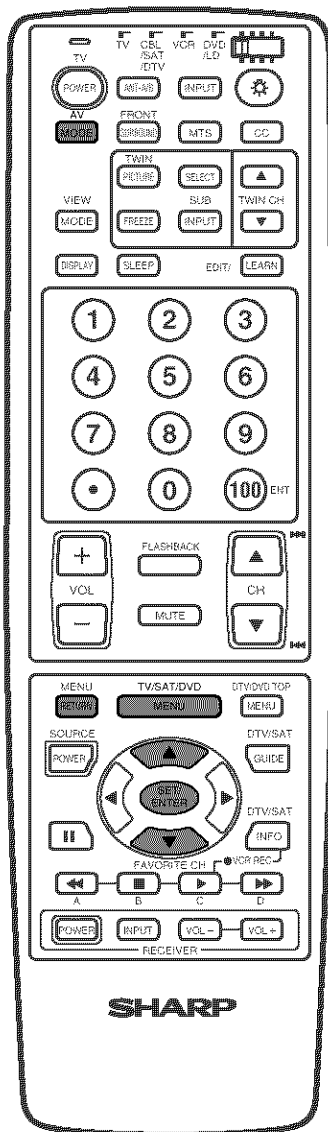

### Color temperature

Adjust the color temperature to give a better white balance.

- 1 Press **MENU**.
- 2 Press **▲/▼** to select "Picture", and then press **SET/ENTER**.
- 3 Press **▲/▼** to select "Advanced", and then press **SET/ENTER**.
- 4 Press **▲/▼** to select "Color Temp", and then press **SET/ENTER**.
- 5 Press **▲/▼** to select the desired level, and then press **SET/ENTER**.
- 6 Press **MENU** to exit the menu.

#### NOTE

- Return to the previous menu by pressing **MENU RETURN**.
- If you select "STANDARD" with **AV MODE** on the remote control unit, this item will display in gray and not be selectable. See page 48.

Selected item	Description
High	White with Bluish tone  ↑↓  White with Reddish tone
Mid-High	
Mid	
Mid-Low	
Low	

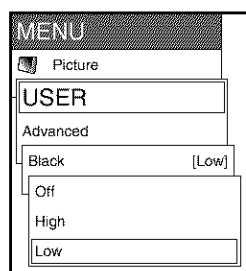

### Black

Select a level for automatically adjusting blackish tone to suit viewing conditions.

- 1 Press **MENU**.
- 2 Press **▲/▼** to select "Picture", and then press **SET/ENTER**.
- 3 Press **▲/▼** to select "Advanced", and then press **SET/ENTER**.
- 4 Press **▲/▼** to select "Black", and then press **SET/ENTER**.
- 5 Press **▲/▼** to select the desired level, and then press **SET/ENTER**.
- 6 Press **MENU** to exit the menu.

#### NOTE

- Return to the previous menu by pressing **MENU RETURN**.
- If you select "STANDARD" with **AV MODE** on the remote control unit, this item will display in gray and not be selectable. See page 48.

Selected item	Description
Off	No adjustment
High	For high detail in black portions
Low	For low detail in black portions

## Basic adjustment settings

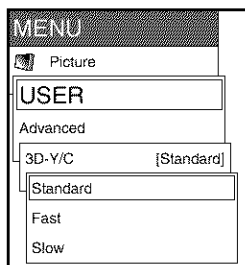
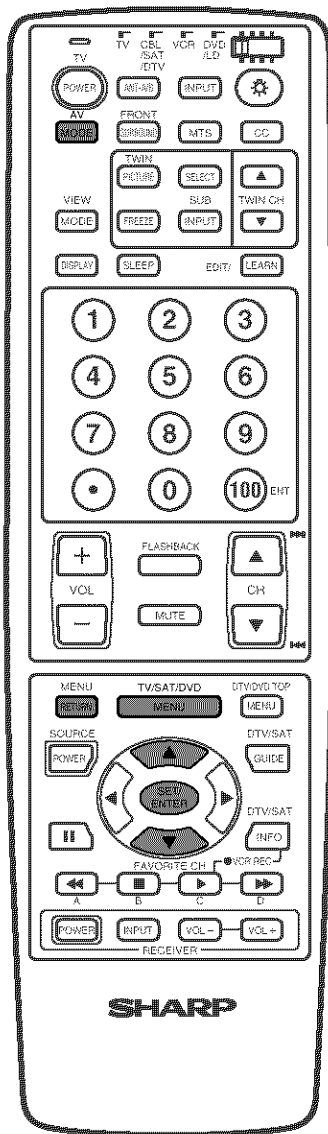

### 3D-Y/C

Provides high quality images with minimal dot crawl and cross color noise.

- 1 Press **MENU**.
- 2 Press **▲/▼** to select "Picture", and then press **SET/ENTER**.
- 3 Press **▲/▼** to select "Advanced", and then press **SET/ENTER**.
- 4 Press **▲/▼** to select "3D-Y/C", and then press **SET/ENTER**.
- 5 Press **▲/▼** to select the desired item, and then press **SET/ENTER**.
- 6 Press **MENU** to exit the menu.

#### NOTE

- Return to the previous menu by pressing **MENU RETURN**.
- If you select "STANDARD" with AV MODE on the remote control unit, this item will display in gray and not be selectable. See page 48.

Selected item	Description
Standard	Normal adjustment
Fast	For movie image
Slow	For still image

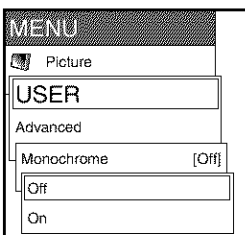

### Monochrome

For viewing a video in monochrome.

- 1 Press **MENU**.
- 2 Press **▲/▼** to select "Picture", and then press **SET/ENTER**.
- 3 Press **▲/▼** to select "Advanced", and then press **SET/ENTER**.
- 4 Press **▲/▼** to select "Monochrome", and then press **SET/ENTER**.
- 5 Press **▲/▼** to select "On", and then press **SET/ENTER**.
- 6 Press **MENU** to exit the menu.

#### NOTE

- Return to the previous menu by pressing **MENU RETURN**.
- If you select "STANDARD" with AV MODE on the remote control unit, this item will display in gray and not be selectable. See page 48.

Selected item	Description
Off	Normal color
On	For viewing in monochrome



## Basic adjustment settings

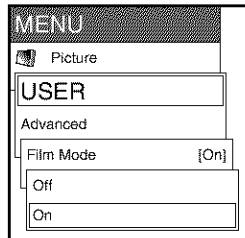
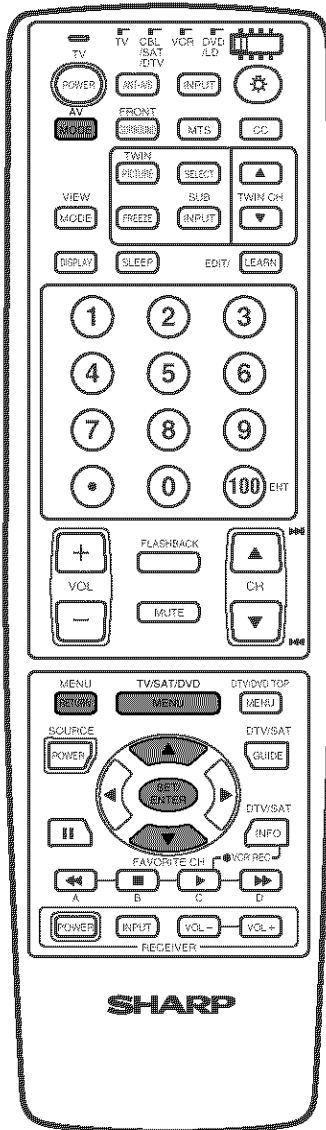

### Film mode (3:2 pull-down)

Automatically detects a film-based source (originally encoded at 24 frames/second), analyses it then recreates each still film frame for high-definition picture quality.

- 1 Press **MENU**.
- 2 Press **▲/▼** to select "Picture", and then press **SET/ENTER**.
- 3 Press **▲/▼** to select "Advanced", and then press **SET/ENTER**.
- 4 Press **▲/▼** to select "Film Mode", and then press **SET/ENTER**.
- 5 Press **▲/▼** to select "On", and then press **SET/ENTER**.
- 6 Press **MENU** to exit the menu.

#### NOTE

- Return to the previous menu by pressing **MENU RETURN**.
- If you select "STANDARD" with **AV MODE** on the remote control unit, or input sources with 1080i, 720P or 480P component signals, this item will display in gray and not be selectable. See page 48.

Selected item	Description
Off	Normal viewing mode
On	Detects, analyzes, converts film source

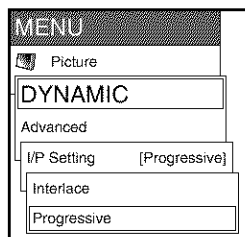

### I/P Setting

For viewing a more beautiful (high quality) picture.

#### NOTE

- I/P Setting is set to Progressive when Film Mode is "On".

- 1 Press **MENU**.
- 2 Press **▲/▼** to select "Picture", and then press **SET/ENTER**.
- 3 Press **▲/▼** to select "Advanced", and then press **SET/ENTER**.
- 4 Press **▲/▼** to select "I/P Setting", and then press **SET/ENTER**.
- 5 Press **▲/▼** to select "Interlace" or "Progressive", and then press **SET/ENTER**.
- 6 Press **MENU** to exit the menu.

#### NOTE

- Return to the previous menu by pressing **MENU RETURN**.
- If you select "STANDARD" with **AV MODE** on the remote control unit, this item will display in gray and not be selectable. See page 48.

MENU	Description
Interlace	Use this setting when you cannot get a clear picture with Progressive. (Especially suitable for media with special effects like game software.)
Progressive	Normally, you should select this setting.

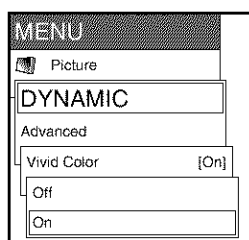
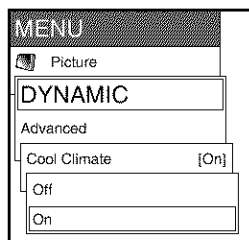
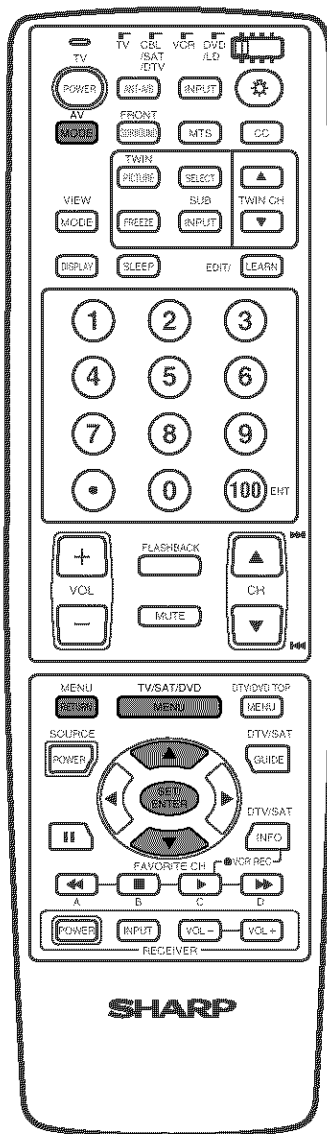

### Cool Climate

Improves the response of Liquid Crystal Panel when viewing fast-moving images. The effect is greater at low room temperatures (at or below 59°F/15°C).

- 1 Press **MENU**.
- 2 Press **▲/▼** to select "Picture", and then press **SET/ENTER**.
- 3 Press **▲/▼** to select "Advanced", and then press **SET/ENTER**.
- 4 Press **▲/▼** to select "Cool Climate", and then press **SET/ENTER**.
- 5 Press **▲/▼** to select "On", and then press **SET/ENTER**.
- 6 Press **MENU** to exit the menu.

#### NOTE

- Cool climate may cause image noise. If this occurs turn the function "Off".
- Return to the previous menu by pressing **MENU RETURN**.
- If you select "STANDARD" with **AV MODE** on the remote control unit, this item will display in gray and not be selectable. See page 48.

### Vivid Color

Sets a more brilliant color reproduction.

- 1 Press **MENU**.
- 2 Press **▲/▼** to select "Picture", and then press **SET/ENTER**.
- 3 Press **▲/▼** to select "Advanced", and then press **SET/ENTER**.
- 4 Press **▲/▼** to select "Vivid Color", and then press **SET/ENTER**.
- 5 Press **▲/▼** to select "On", and then press **SET/ENTER**.
- 6 Press **MENU** to exit the menu.

#### NOTE

- Return to the previous menu by pressing **MENU RETURN**.
- If you select "STANDARD" with **AV MODE** on the remote control unit, this item will display in gray and not be selectable. See page 48.

## Basic adjustment settings

### Sound adjustment

You can adjust the sound quality to your preference with the following settings.

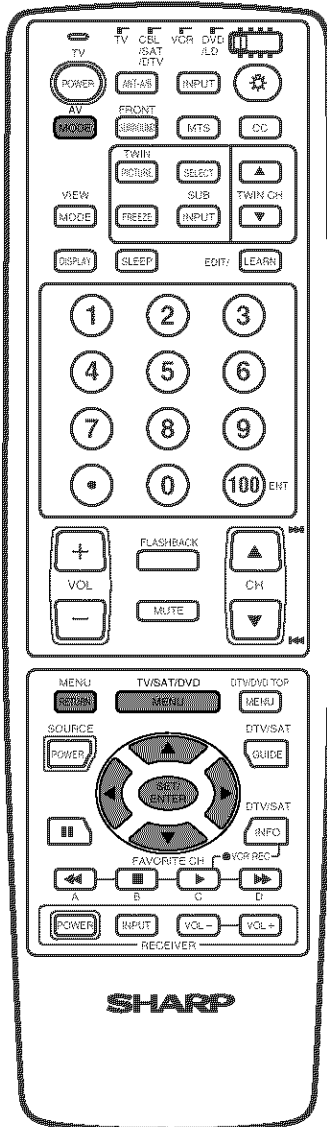

- 1 Press **MENU**.
- 2 Press **▲/▼** to select "Audio", and then press **SET/ENTER**.
  - Audio menu displays.
- 3 Press **▲/▼** to select a specific adjustment item.
- 4 Press **◀/▶** to adjust the item to your desired position.
- 5 Press **MENU** to exit the menu.

#### NOTE

- When all adjustments are set to factory preset values,
  - ① Press **▲/▼** to select "Reset", and then press **SET/ENTER**.
  - ② Press **▲/▼** to select "Yes", and then press **SET/ENTER**.
- Return to the previous menu by pressing **MENU RETURN**.
- If you select "STANDARD" with **AV MODE** on the remote control unit, these items will display in gray and not be selectable. See page 48.

Selected item	◀ button	▶ button
Treble	For weaker treble	For stronger treble
Bass	For weaker bass	For stronger bass
Balance	Decrease audio from the right speaker	Decrease audio from the left speaker

### Adjustments items for AV source

MENU				
Audio				
USER				
Treble	[0]	-15		+15
Bass	[0]	-15		+15
Balance	[0]	Left		Right
Reset				
RETURN				

## Power control

Power Control setting allows you to reduce the display brightness to save energy.

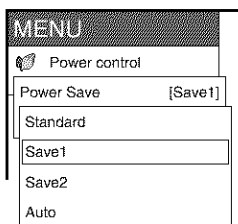
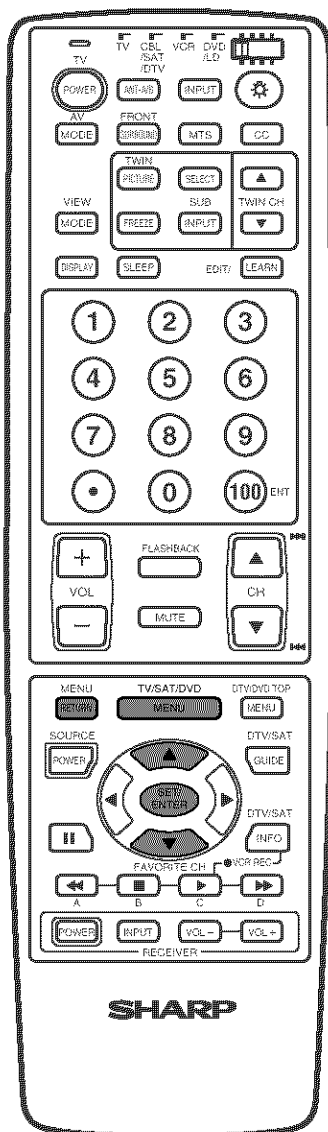

### Power control for AV source

#### Power save

When set to "Save1", "Save2" or "Auto", power consumption is reduced by decreasing picture brightness.

#### NOTE

- "Power Save" may not activate when setting to "Auto" under bright ambient light conditions.

- 1 Press **MENU**.
- 2 Press **▲/▼** to select "Power control", and then press **SET/ENTER**.
- 3 Press **▲/▼** to select "Power Save", and then press **SET/ENTER**.
- 4 Press **▲/▼** to select the desired mode, and then press **SET/ENTER**.
- 5 Press **MENU** to exit the menu.

Selected item	Description
Save1	The screen darkens slightly to conserve power consumption.
Save2	The screen darkens more significantly to conserve power consumption.
Auto	Screen brightness adjusts according to the ambient light of the room to conserve power consumption.

#### NOTE

- When setting to "Auto", make sure no object obstructs the OPC sensor, which could affect its ability to sense surrounding light.
- "Standard" is factory preset value.
- Return to the previous menu by pressing **MENU RETURN**.

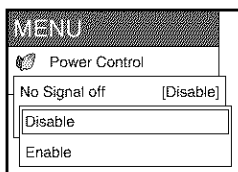

#### No Signal off

When set to "Enable", the power will automatically shut down if no signal inputs for 15 minutes.

- 1 Press **MENU**.
- 2 Press **▲/▼** to select "Power Control", and then press **SET/ENTER**.
- 3 Press **▲/▼** to select "No Signal off", and then press **SET/ENTER**.
- 4 Press **▲/▼** to select "Enable", and then press **SET/ENTER**.
- 5 Press **MENU** to exit the menu.
  - Five minutes before the power shuts down, hazard warning displays every minute.

#### NOTE

- "Disable" is factory preset value.
- Return to the previous menu by pressing **MENU RETURN**.
- **When enabled, the system will not start up again even if a signal is received.**

## Basic adjustment settings

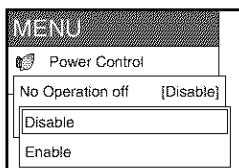
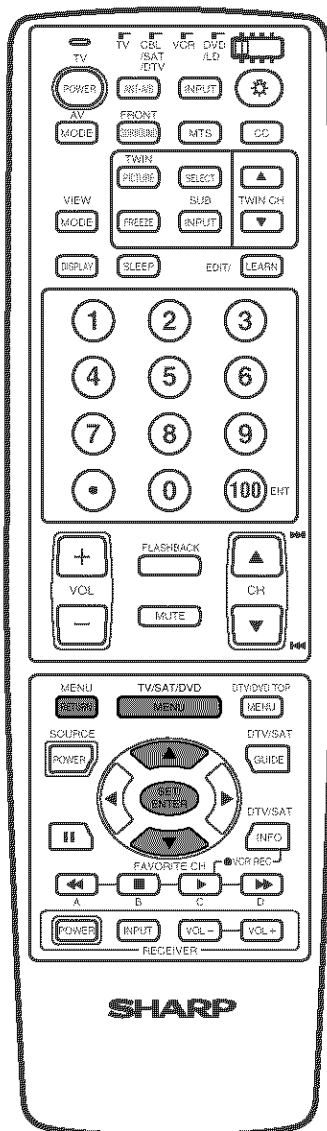

### No Operation off

When set to "Enable", the power will automatically shut down if no operation for 3 hours.

- 1 Press **MENU**.
- 2 Press **▲/▼** to select "Power Control", and then press **SET/ENTER**.
- 3 Press **▲/▼** to select "No Operation off", and then press **SET/ENTER**.
- 4 Press **▲/▼** to select "Enable", and then press **SET/ENTER**.
- 5 Press **MENU** to exit the menu.
  - Five minutes before the power shuts down, hazard warning displays every minute.

### NOTE

- "Disable" is factory preset value.
- Return to the previous menu by pressing **MENU RETURN**.

## Basic adjustment settings

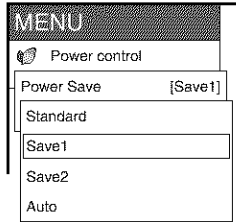
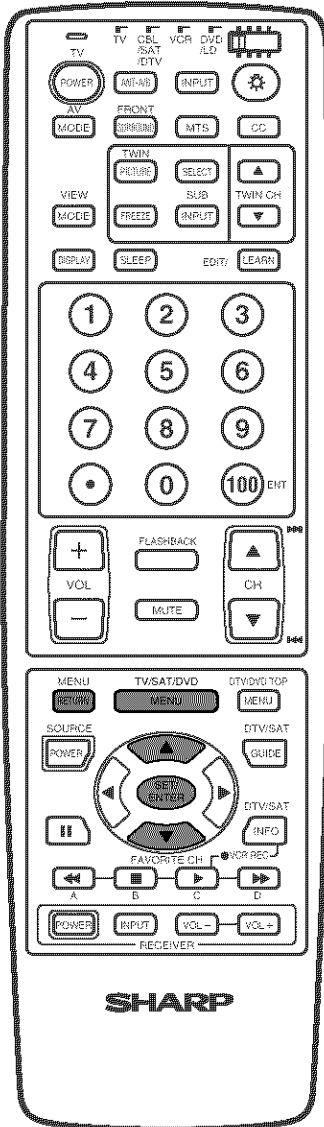

### Power control for PC source

Power control allows you to reduce display brightness and save energy.

#### Power save

- 1 Press **MENU**.
- 2 Press **▲/▼** to select "Power Control", and then press **SET/ENTER**.
- 3 Press **▲/▼** to select "Power Save", and then press **SET/ENTER**.
- 4 Press **▲/▼** to select the desired mode, and then press **SET/ENTER**.
- 5 Press **MENU** to exit the menu.

#### NOTE

- "Standard" is factory preset value.
- Return to the previous menu by pressing **MENU RETURN**.

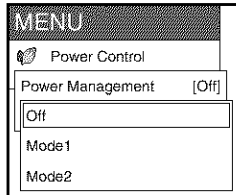

#### Power management

When set, the power will automatically shut down.

- 1 Press **MENU**.
- 2 Press **▲/▼** to select "Power Control", and then press **SET/ENTER**.
- 3 Press **▲/▼** to select "Power Management", and then press **SET/ENTER**.
- 4 Press **▲/▼** to select "Mode1" or "Mode2", and then press **SET/ENTER**.
- 5 Press **MENU** to exit the menu.

#### NOTE

- Return to the previous menu by pressing **MENU RETURN**.

Selected item	Description
<b>Off</b>	<ul style="list-style-type: none"> <li>• No power management.</li> <li>• Factory preset value.</li> </ul>
<b>Mode1</b>	<ul style="list-style-type: none"> <li>• If no signal inputs for 8 minutes, the power shuts down.</li> <li>• Even if you start using the computer and the signal inputs again, the System stays off.</li> <li>• The System turns on again by pressing <b>POWER</b> button on the Display or <b>TV POWER</b> on the remote control unit.</li> </ul>
<b>Mode2</b>	<ul style="list-style-type: none"> <li>• If no signal inputs for 8 seconds, the power shuts down.</li> <li>• When you start using the computer and the signal inputs again, the System turns on.</li> </ul>

# Using external equipment

You can connect many types of external equipment to your System, like a DVD player, VCR, Digital TV tuner, computer, game console and camcorder. To view external source images, select the input source from **INPUT** on the remote control unit or on the Display.

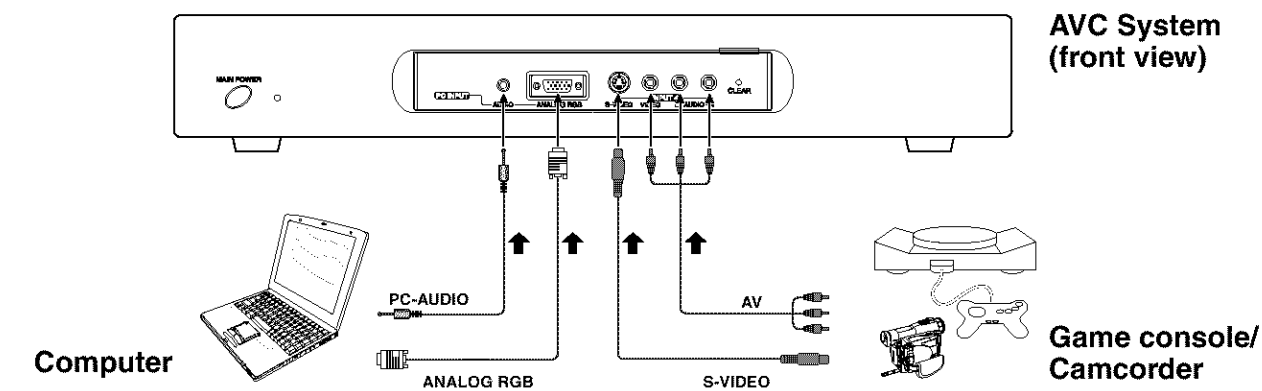
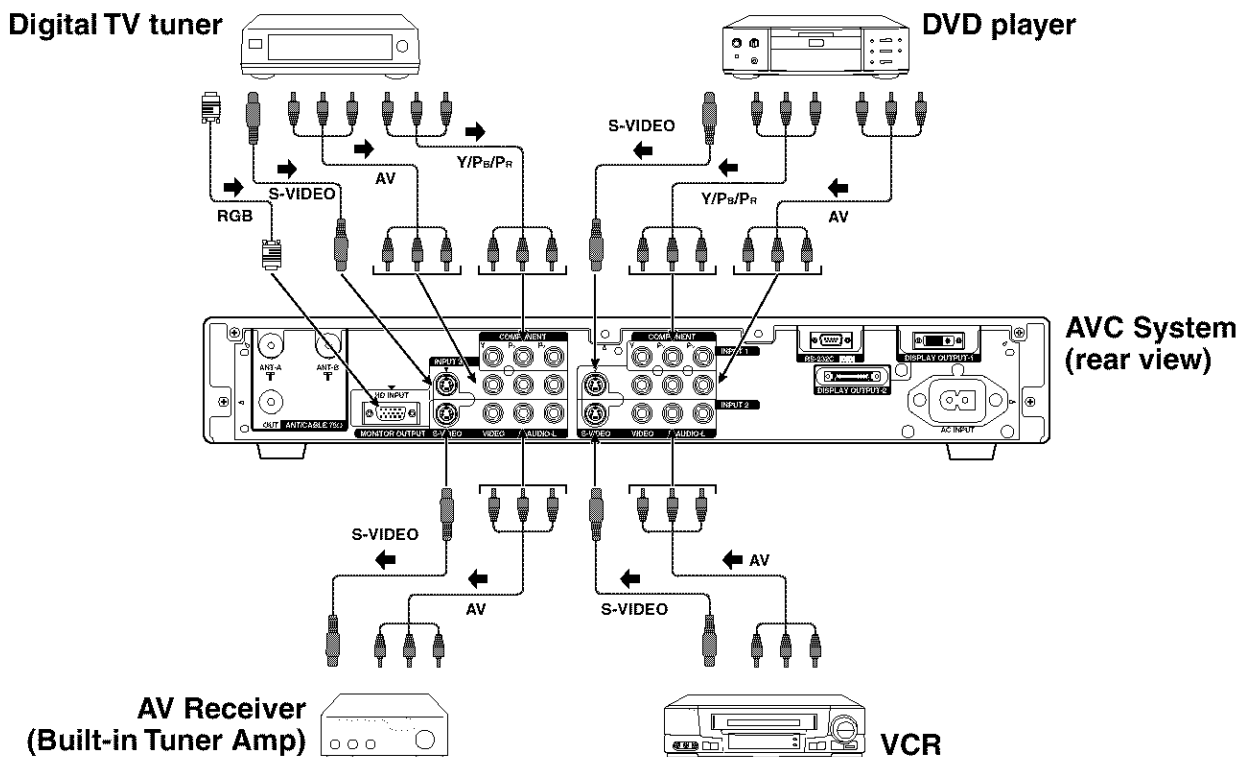

**CAUTION**

- To protect all equipment, always turn off the AVC System before connecting to a DVD player, VCR, Digital TV tuner, computer, game console, camcorder or other external equipment.

**NOTE**

- Please refer to the relevant operation manual (DVD player, computer, etc.) carefully before making connections.

## Using external equipment

### Watching a DVD image

#### Connecting a DVD player

You can use the INPUT 1 terminal when connecting to a DVD player and other audiovisual equipment.

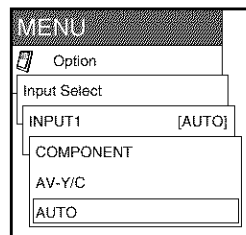
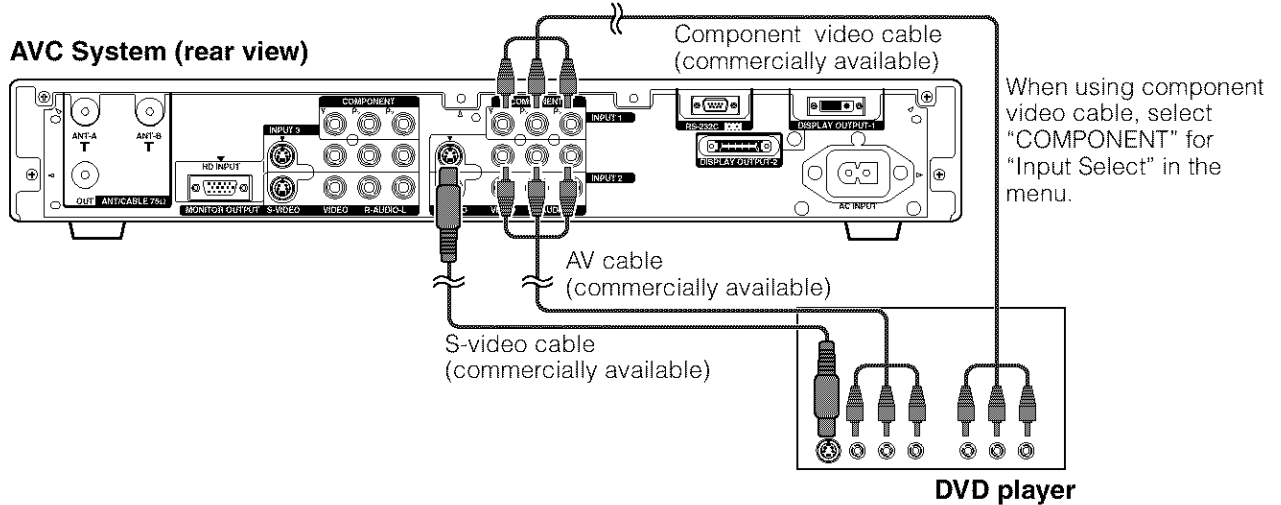

#### Displaying a DVD image

When connecting to the INPUT 1 terminal, select "INPUT1" and set the correct input signal type on "Input Select" in the menu. (See page 47.)

The setting is stored and can be selected on the "INPUT SOURCE" menu.

To watch a DVD image, select "INPUT1" from "INPUT SOURCE" menu using **INPUT** on the remote control unit or on the Display. (See page 47.)

#### NOTE

- Each time **INPUT** is pressed, the input source toggles.
- If the DVD image does not come in clearly, you may need to change the input signal type setting on the "Input Select" menu.
- Refer to your DVD player operation manual for the signal type.

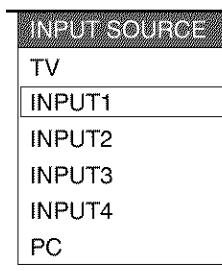
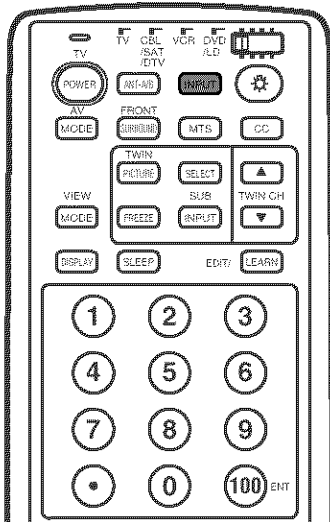



## Using external equipment

### Watching a VCR image

#### Connecting a VCR

You can use the INPUT 2 terminal when connecting a VCR and other audiovisual equipment.

#### AVC System (rear view)

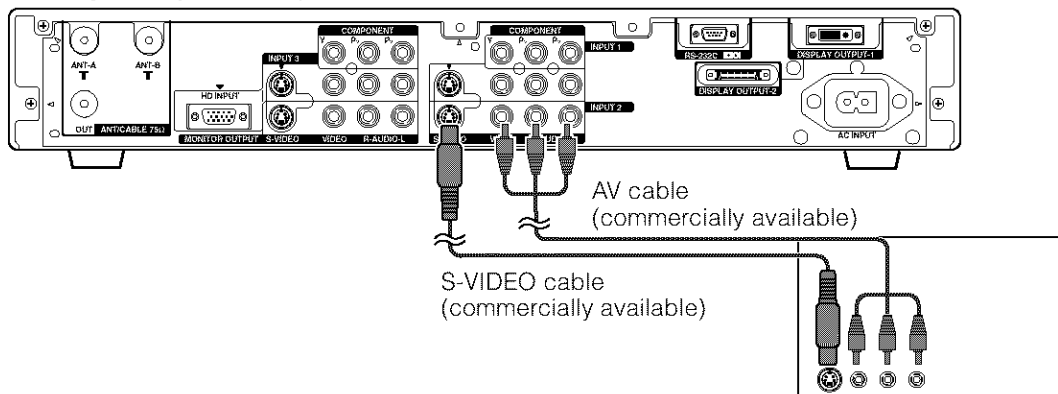

VCR

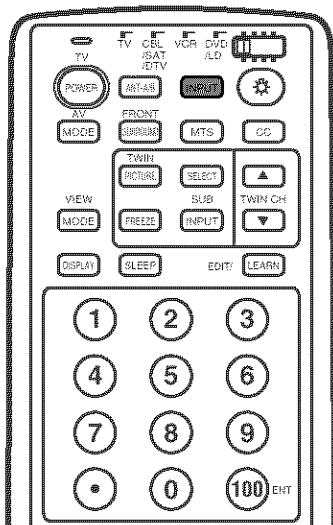

INPUT SOURCE
TV
INPUT1
INPUT2
INPUT3
INPUT4
PC

#### Displaying a VCR image

When connecting to the INPUT 2 terminals, select "INPUT2".

You only need to select the input source on the "INPUT SOURCE" menu.

To watch a VCR image, select "INPUT2" from the "INPUT SOURCE" menu using **INPUT** on the remote control unit or on the Display. (See page 47.)

#### NOTE

- Each time **INPUT** is pressed, the input source toggles.
- Refer to your VCR operation manual for the signal type.

## Watching broadcasts via a Digital TV tuner

### Connecting a Digital TV tuner

You can use the INPUT 3 terminal when connecting a Digital TV tuner and other audiovisual equipment.

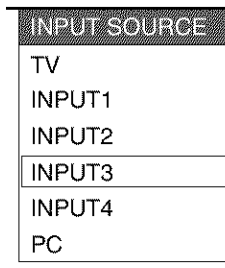
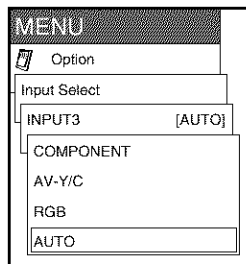
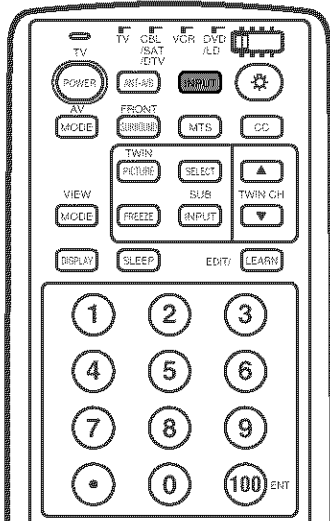
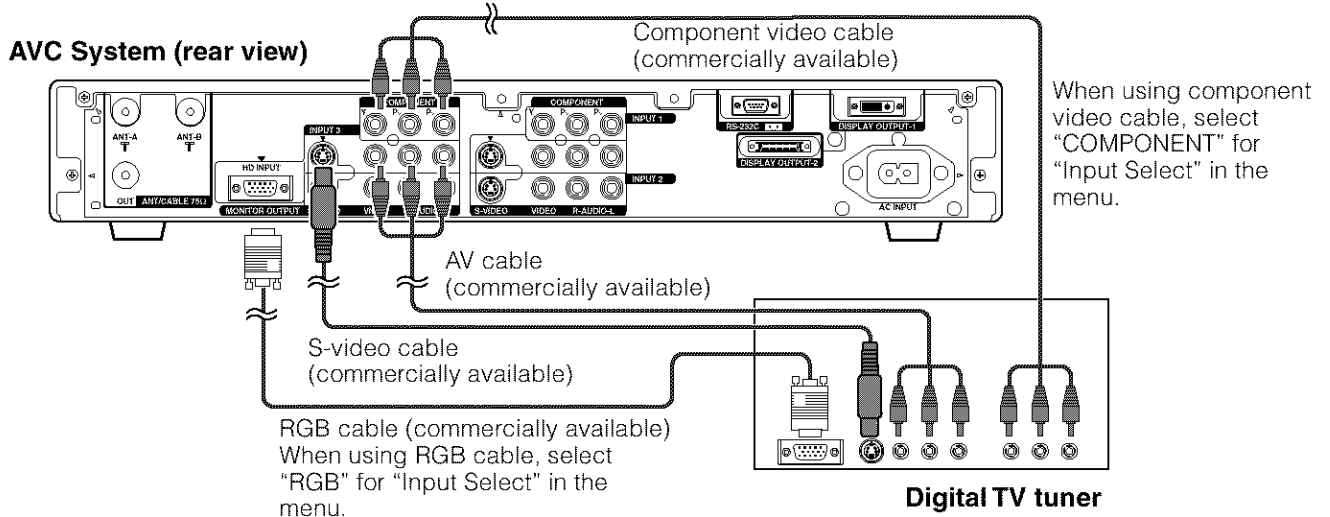

### Displaying broadcasts via a Digital TV tuner

When connecting to the INPUT 3 terminal, select "INPUT3" and set the correct input signal type on "Input Select" in the menu. (See page 47.)

The setting is stored and can be selected on the "INPUT SOURCE" menu.

To watch a Digital TV tuner image, select "INPUT3" from the "INPUT SOURCE" menu using **INPUT** on the remote control unit or on the Display. (See page 47.)

#### NOTE

- Each time **INPUT** is pressed, the input source toggles.
- If the Digital TV tuner image does not come in clearly, you may need to change the input signal type setting on the "Input Select" menu.
- Refer to your Digital TV tuner operation manual for the signal type.
- HD INPUT cannot connect to a PC. (Input resolution is compatible with 1080I and 540P.)
- Use the PC INPUT terminals on the front of the AVC System when connecting a computer. (See page 43.)
- When connecting to the HD INPUT terminal, be sure to use a commercially available RGB cable with ferrite core attached.

## Using external equipment

### Enjoying a game console or viewing camcorder images

#### Connecting a game console or camcorder

A game console, camcorder and some other audiovisual equipment are conveniently connected using the INPUT 4 terminals.

#### NOTE

- The S-video terminal has priority over the video terminals.

AVC System (front view)

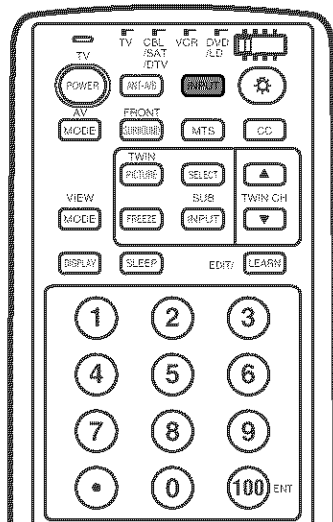
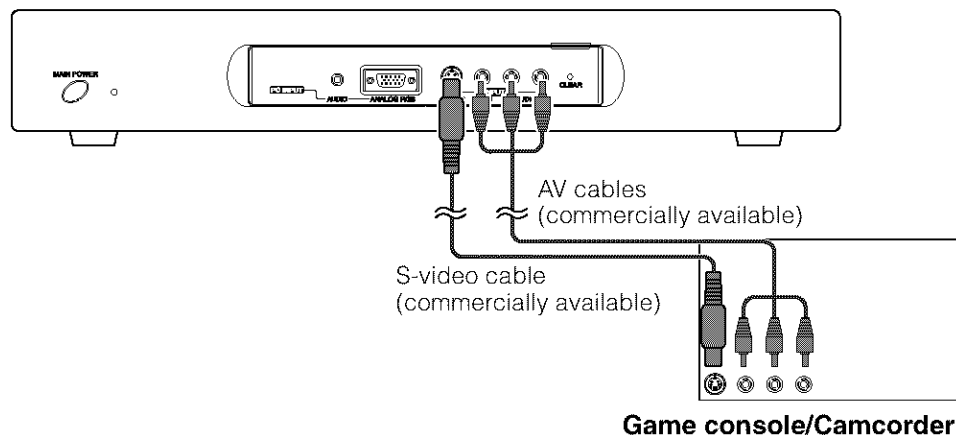

#### Displaying an image of the game console or camcorder

When connecting to the INPUT 4 terminals, select "INPUT4".

You only need to select the input source on the "INPUT SOURCE" menu.

To connect a game console or view a camcorder, select "INPUT4" from the "INPUT SOURCE" menu using **INPUT** on the remote control unit or on the Display. (See page 47.)

#### NOTE

- Each time **INPUT** is pressed, the input source toggles.

## Using external equipment

### Viewing an image from a computer

#### Connecting a computer

Use the PC terminals to connect a computer.

#### NOTE

- The PC input terminals are DDC1/2B-compatible.
- Refer to page 71 for a list of computer signals compatible with the System.

#### AVC System (front view)

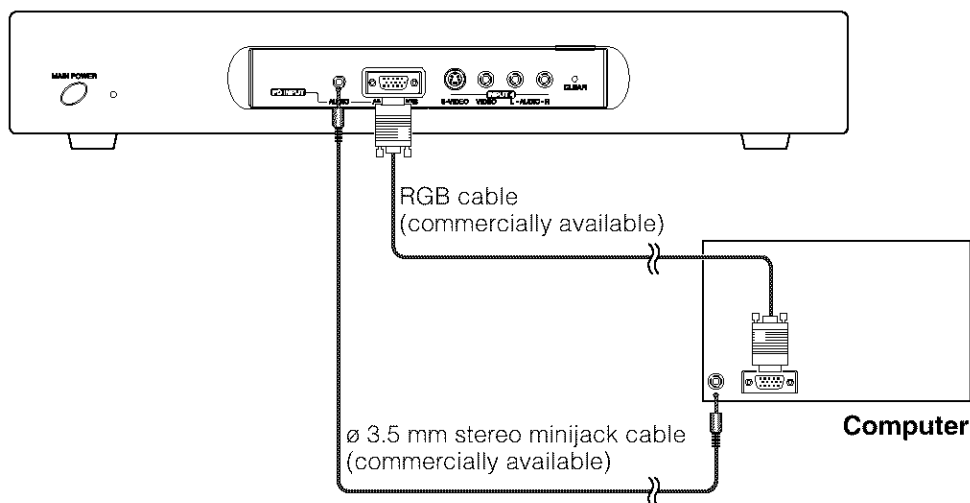

#### Signal names for 15-pin mini D-sub connector

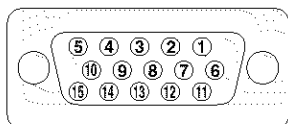

Pin No.	Signal name	Pin No.	Signal name	Pin No.	Signal name
①	R	⑥	GND (Ground)	⑪	Not connected
②	G	⑦	GND (Ground)	⑫	SDA
③	B	⑧	GND (Ground)	⑬	HD
④	Not connected	⑨	+5V	⑭	VD
⑤	CSYNC	⑩	GND (Ground)	⑮	SCL

#### NOTE

- Macintosh adaptor may be required for use for some Macintosh computers.

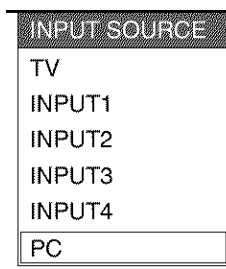
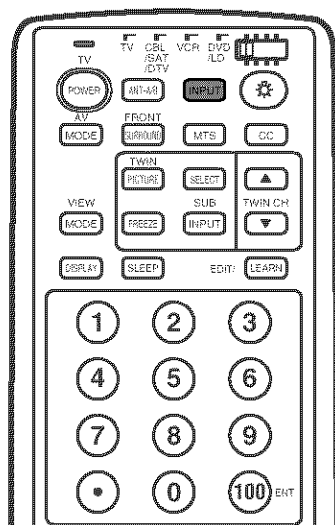

#### Displaying an image from a computer

When connecting to a computer, the correct input signal type is automatically detected. If the computer image does not come in clearly, you may need to set the Auto Sync. adjustment on the "Auto Sync." in the menu. (See page 46.)

You only need to select the input source on the "INPUT SOURCE" menu.

To view an image from a computer, select "PC" from the "INPUT SOURCE" menu using **INPUT** on the remote control unit or on the Display. (See page 47.)

#### NOTE

- Each time **INPUT** is pressed, the input source toggles.
- PC INPUT terminals cannot be used for audiovisual equipment. Use the INPUT 3 (HD) terminal on the rear of the AVC System when connecting audiovisual equipment with an RGB signal. (See page 41.)

### Removing the speakers

#### This unit has detachable type speakers.

You can detach the system speakers when using external amplifier/speakers.

#### Before attaching/detaching speakers

- Before performing work make sure to turn off the System.
- Before performing work spread cushioning over a flat surface to lay the Display on. This will prevent it from being damaged.

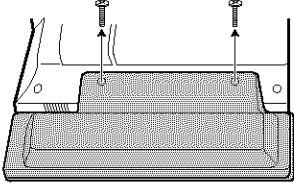
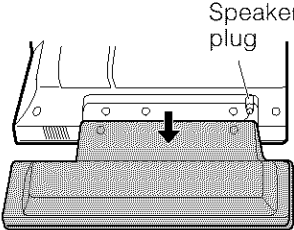
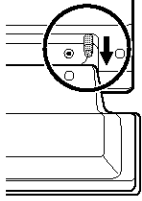
<p><b>1</b></p>  <p>Unfasten the screws used to secure the speakers in place.</p>	<p><b>2</b></p>  <p>Take hold of the speaker and slowly slide it sideways. (The speaker plug is still inserted, so make sure not to pull the speaker too far.)</p>	<p><b>3</b></p>  <p>Remove the speaker plug from the terminal on the Display. (Do not remove the plug by pulling the cord.) Now the speaker can be detached from the Display.</p>
--	---	--

#### CAUTION

- The speaker terminals on the Display is only for the attached speakers. Do not connect any third party plug or speaker to the terminal.
- Insert the speaker plug completely into the terminal.
- Do not handle or move the display by the speakers.

#### NOTE

- Perform the same steps for both left and right speakers.
- To attach the speakers, perform the above steps in reverse order.

# Adjustment settings

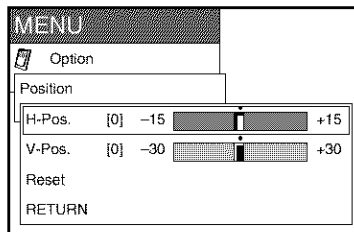
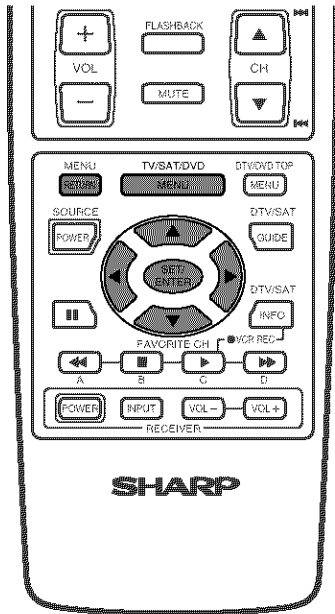

## Image position (TV/VIDEO mode only)

For adjusting a picture's horizontal and vertical position.

- 1 Press **MENU**.
- 2 Press **▲/▼** to select "Option", and then press **SET/ENTER**.
- 3 Press **▲/▼** to select "Position", and then press **SET/ENTER**.
- 4 Press **▲/▼** to select "H-Pos." or "V-Pos."
- 5 Press **◀▶** to adjust the item to your desired position.
- 6 Press **MENU** to exit the menu.

### NOTE

- For resetting all adjustment items set to the factory preset values,
  - ① Press **▲/▼** to select "Reset", and then press **SET/ENTER**.
  - ② Press **▲/▼** to select "Yes", and then press **SET/ENTER**.
- Return to the previous menu by pressing **MENU RETURN**.
- **Adjustments are stored separately according to input source.**
- You can easily move the image position as shown on page 24, but when the power is switched off the image will return to the previously memorised position.

Selected item	Description
<b>H-Pos.</b>	Centers the image by moving it to the left or right.
<b>V-Pos.</b>	Centers the image by moving it up or down.

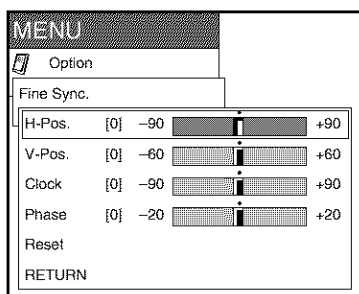
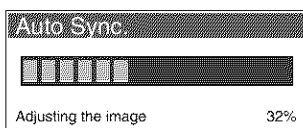
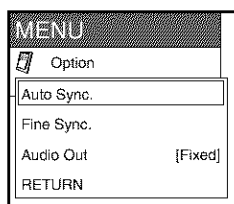
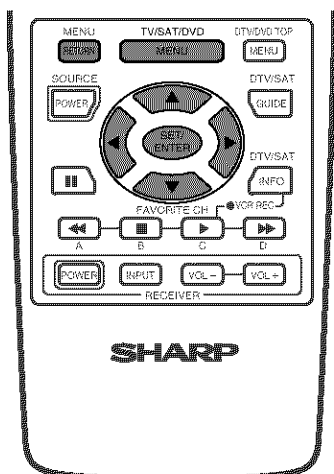

### Auto Sync. adjustment (PC mode only)

For automatically adjusting the computer image.

- 1 Press **MENU**.
- 2 Press **▲/▼** to select "Option", and then press **SET/ENTER**.
- 3 Press **▲/▼** to select "Auto Sync.", and then press **SET/ENTER**.
  - Auto Sync. starts and "Adjusting the image." displays.

#### NOTE

- Return to the previous menu by pressing **MENU RETURN**.
- When Auto Sync. is successful, "Auto Sync completed successfully" displays. If not, Auto Sync. failed.
- Auto Sync. may fail even if "Auto Sync completed successfully" displays.
- Auto Sync. may fail with a PC image composed of similar patterns or monochrome. If not successful, change the PC image and try again.
- Be sure to connect the computer to the AVC System and switch it on before starting Auto Sync.

### Fine Sync. adjustment (PC mode only)

Ordinarily you can easily adjust the picture as necessary to change image position using Auto Sync. In some cases, however, manual adjustment is needed to optimize the image.

- 1 Press **MENU**.
- 2 Press **▲/▼** to select "Option", and then press **SET/ENTER**.
- 3 Press **▲/▼** to select "Fine Sync.", and then press **SET/ENTER**.
- 4 Press **▲/▼** to select the specific adjustment item.
- 5 Press **◀/▶** to adjust the item to your desired position.
- 6 Press **MENU** to exit the menu.

#### NOTE

- When all adjustments are set to factory preset values,
  - ① Press **▲/▼** to select "Reset", and then press **SET/ENTER**.
  - ② Press **▲/▼** to select "Yes", and then press **SET/ENTER**.
- Return to the previous menu by pressing **MENU RETURN**.

Selected item	Description
<b>H-Pos.</b>	Centers the image by moving it to the left or right.
<b>V-Pos.</b>	Centers the image by moving it up or down.
<b>Clock</b>	Adjusts the clock frequency.
<b>Phase</b>	Adjusts the clock phase.

## Adjustment settings

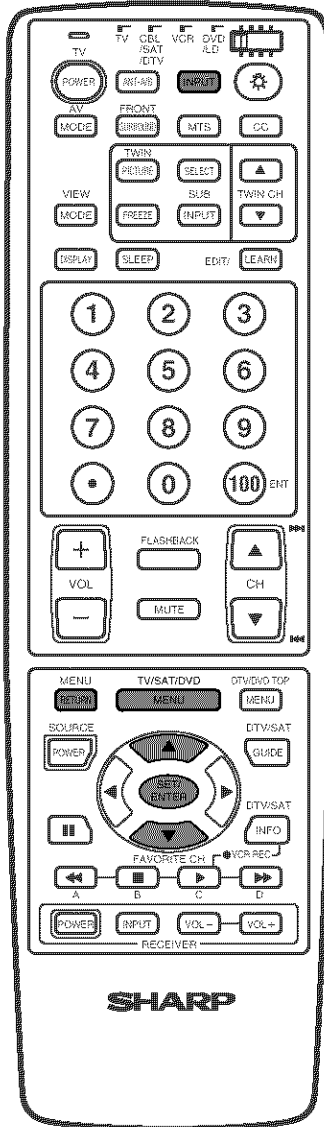

### INPUT 1 signal menu

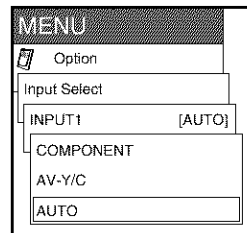

### INPUT 3 signal menu

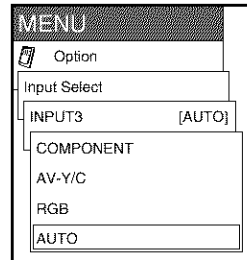

## Input signal source

### Input signal setting

For setting the signal type of external equipment.

- 1 Press **MENU**.
- 2 Press **▲/▼** to select "Option", and then press **SET/ENTER**.
- 3 Press **▲/▼** to select "Input Select", and then press **SET/ENTER**.
- 4 Press **▲/▼** to select an input source you want to set, and then press **SET/ENTER**.
- 5 Press **▲/▼** to select a signal type, and then press **SET/ENTER**.
  - If the selected signal type is incorrect, an image does not display or no color image displays.
- 6 Press **MENU** to exit the menu.

#### NOTE

- Return to the previous menu by pressing **MENU RETURN**.
- The System automatically sets input signals from "INPUT2", "INPUT4" and "PC".
- **If no image displays, try to change the signal type.**
- Check the operation manual of the external equipment for the signal type.
- Setting INPUT 1 and INPUT 3 signal selection to "AUTO" when other equipment is connected will result in the following connectivity priority.

INPUT 1	INPUT 3
1. COMPONENT VIDEO	1. COMPONENT VIDEO
2. S-VIDEO	2. S-VIDEO
3. VIDEO	3. VIDEO
	4. HD (RGB) INPUT

### INPUT SOURCE

TV  
 INPUT1  
 INPUT2  
 INPUT3  
 INPUT4  
 PC

### Input selection

Can use for selecting the input source.

- 1 Press **INPUT** on the remote control unit or on the Display.
  - INPUT SOURCE menu displays.
- 2 Hold down **INPUT** on the remote control unit or on the Display to select the input source.
  - An image from the selected source automatically displays.
  - You can also select the input source by pressing **▲/▼**.

#### NOTE

- Items grayed out are not selectable.



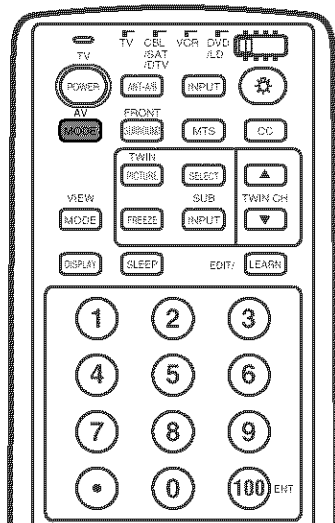

## AV MODE

AV MODE gives you five viewing options to choose from to best match environment of the System, which can vary due to factors like room brightness, type of program watched or the type of image input from external equipment.

- 1 Press **AV MODE**.
  - Present AV MODE displays.
- 2 Press **AV MODE** again before the mode displayed on the screen disappears.
  - The mode changes as shown left.

Selected item	Description
<b>STANDARD</b>	For a highly defined image in a normally bright room
<b>DYNAMIC</b>	For a clear-cut image emphasizing high contrast for sports viewing.
<b>MOVIE</b>	For a movie
<b>GAME</b>	Lowers image brightness for easier viewing
<b>USER</b>	Allows the user to customize settings as desired. You can set the mode for each input source.

### Mode selection for the INPUT 1 to 4 terminals

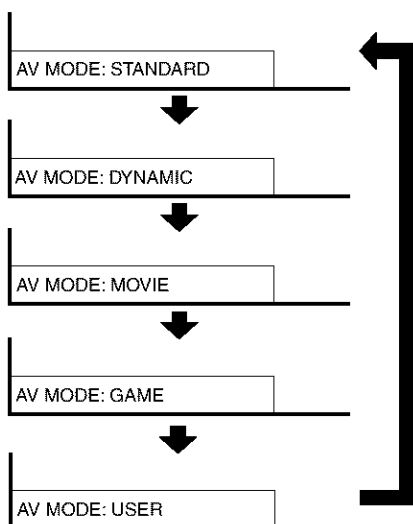

### Mode selection for the PC terminal

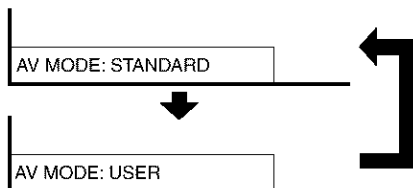

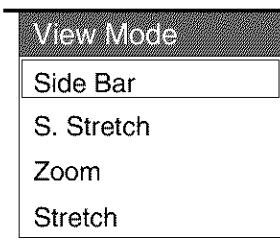
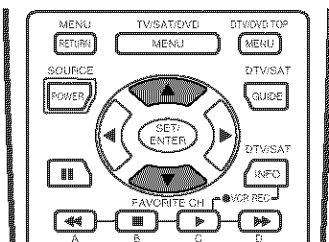
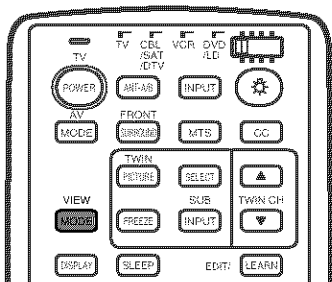

### View Modes for 4:3 Programs

- 1 Press **VIEW MODE**.
  - The View Mode menu displays.
  - The menu lists the view mode options selectable for the type of video signal currently received.
- 2 Press **VIEW MODE** or **▲/▼** while the View Mode menu is still on the screen.
  - You can sequentially select a view mode that has its own aspect ratio.

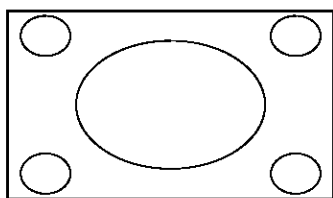
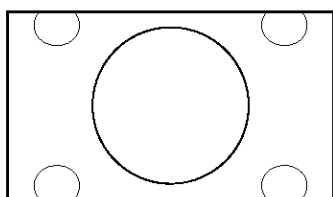
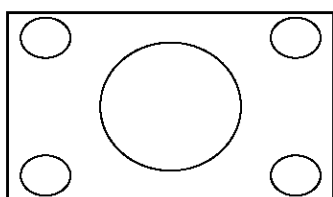
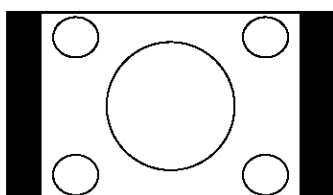

**Side Bar:** Suitable for viewing conventional 4:3 programs in their normal format.

**S.Stretch: (Smart stretch)** Suitable for stretching 4:3 programs to fill the screen.

**Zoom:** Suitable for viewing wide-screen 2.35:1 anamorphic DVDs in full screen.

**Stretch:** This mode is useful for 1.78:1 DVDs. When viewing 1.85:1 DVDs, stretch mode will still show very thin black bands at the top and bottom of the screen.

## Adjustment settings

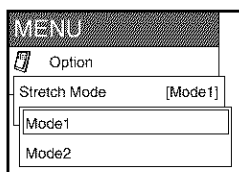
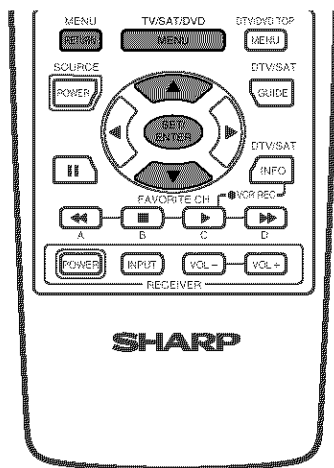

### Selecting Stretch Mode display (TV/VIDEO mode only)

Select the display type in Stretch Mode.

- 1 Press **MENU**.
- 2 Press **▲/▼** to select "Option", and then press **SET/ENTER**.
- 3 Press **▲/▼** to select "Stretch Mode", and then press **SET/ENTER**.
- 4 Press **▲/▼** to select "Mode1" or "Mode2", and then press **SET/ENTER**.
- 5 Press **MENU** to exit the menu.

#### NOTE

- Return to the previous menu by pressing **MENU RETURN**.

Selected item	Description
<b>Mode1</b>	Projects 16:9 squeeze image evenly over entire screen.
<b>Mode2</b>	Displays a 16:9 squeeze image without distortion. However, black bands appear at the top and bottom.

### Stretch Mode screen

Stretch mode  
"Mode1"



Stretch mode  
"Mode2"



# Adjustment settings

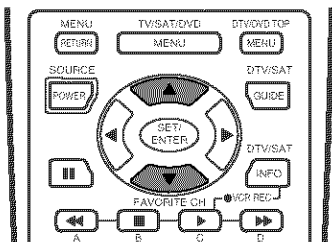
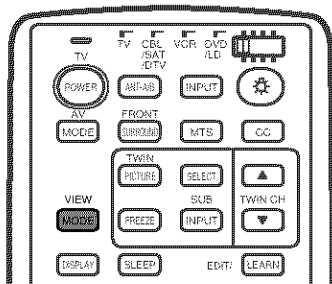

## EXAMPLE View Mode display

1280 × 768  
1024 × 768

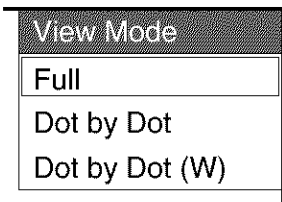

800 × 600  
640 × 480

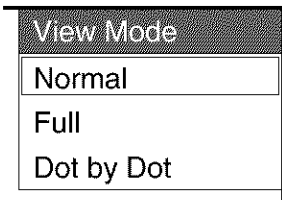

## View Mode (for PC mode)

### 1 Press **VIEW MODE**.

- The View Mode menu displays.
- The menu lists the View Mode options selectable for the type of video signal currently received.

### 2 Press **VIEW MODE** or **▲/▼** while the View Mode menu is still on the screen.

- You can sequentially select a View Mode that has its own aspect ratio.

(Some image display examples.)

<p>Input signal 1024 × 768 1280 × 768</p>	<p><b>Full</b></p> <p>Ex. 1024 × 768 Image fully fills the screen.</p>	<p><b>Dot by Dot</b></p> <p>Ex. 1024 × 768 Image with same number of pixels as input resolution.</p>	<p><b>Dot by Dot (W)</b></p> <p>Ex. 1024 × 768 For WXGA mode, select when 1280 × 768 signal is input.</p>
	<p>Select either "Dot by Dot" or "Full" when 1024 × 768 signal is input.</p>		
<p>Input signal 640 × 480 800 × 600</p>	<p><b>Normal</b></p> <p>Image size varies with signal input. (Above is example.)</p>	<p><b>Full</b></p> <p>Image fully fills the screen.</p>	<p><b>Dot by Dot</b></p> <p>Image with same number of pixels as input resolution. (Above is example.)</p>

## NOTE

- Selectable items may vary with signal input type.
- What is "Dot by Dot"?
  - This function detects the resolution of the signal from a computer and displays an image with the same number of pixels, dot by dot.
  - When a XGA WIDE (1280 × 768) signal is input, selecting "Dot by Dot (W)" enables "Dot by Dot" display.



## Adjustment settings

### Closed caption

- Your System is equipped with an internal closed caption decoder. Closed caption is the System which allows you to view conversations, narration, and sound effects in TV programs and home videos as subtitles on your Display.
- Not all programs and videos offer closed caption. Please look for the “**CC**” symbol to ensure that captions will be shown.
- “CC1” or “CC2” displays subtitles of TV dramas and news programs while allowing a full view of the picture.
- “T1” or “T2” superimposes on the picture other information (e.g. TV guide, weather) that is independent of the TV in progress.

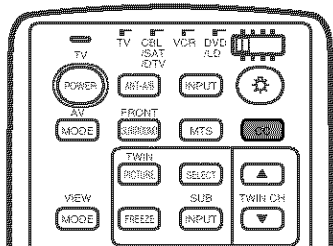

Each time you press **CC**, the closed caption toggles as shown below.

#### NOTE

- When using Twin Picture (See page 61.) and Still Image (See page 61.) functions, the right screen cannot display closed caption data.

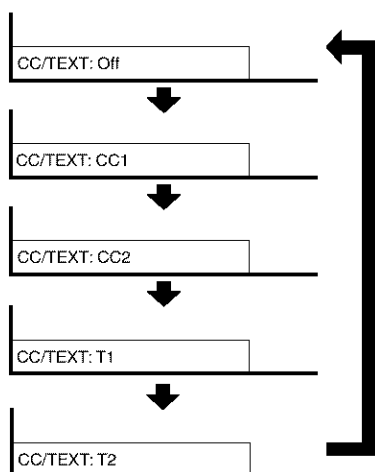

## Adjustment settings

### Parental control (setting V-CHIP level)

V-CHIP is an electronic filtering device built into your System. This tool gives parents a great degree of control over broadcasts accessed by their children. It allows parents to select programs judged suitable for child viewing while blocking ones judged not suitable. It does so automatically once you activate the V-CHIP feature in your Liquid Crystal Television.

**“V-Chip” and “Status” will not be selectable from the menu if you do not first configure your secret number.** (See page 58 for Secret number setting for parental control.)

- The U.S. has two rating systems for viewing content: TV Parental Guidelines and movie ratings.
- The TV Parental Guidelines work in conjunction with the V-CHIP to help parents screen out inappropriate television shows from their children.
- Movie ratings are used for original movies rated by the Motion Picture Association of America (MPAA) as watched on cable TV and not edited for television. The V-CHIP can also be set to block MPAA-rated movies

### Voluntary movie rating system (MPAA)

Rating		Description
Age	G	General audiences. All ages admitted.
	PG	Parental guidance suggested. Some material may not be suitable for children.
	PG-13	Parents strongly cautioned. Some material may be inappropriate for children under 13.
	R	Restricted. Under 17 requires accompanying parent or adult guardian (age varies in some jurisdictions).
	NC-17	No one 17 and under admitted.
	X	A rating that has now been superseded by NC-17.

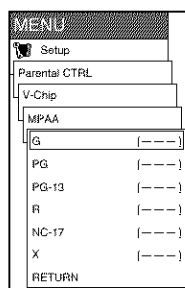

#### EXAMPLE

- If you select “PG-13”, this will automatically block the higher ratings “R”, “NC-17” and “X”.

#### NOTE

- Voluntary movie rating system only uses an age-based rating.

### TV Parental Guidelines

Rating		Content				
		FV (Fantasy violence)	V (Violence)	S (Sexual situation)	L (Adult language)	D (Sexually suggestive dialog)
Suggested age	TV-Y (All children)					
	TV-Y7 (Directed to older children)	X				
	TV-G (General audience)					
	TV-PG (Parental Guidance suggested)		X	X	X	X
	TV-14 (Parents strongly cautioned)		X	X	X	X
	TV-MA (Mature audience only)		X	X	X	

X: Content rating can be set.

## Adjustment settings

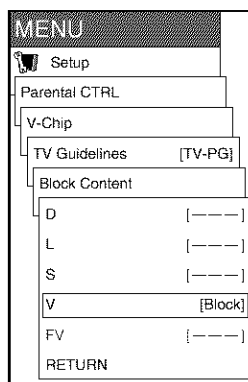
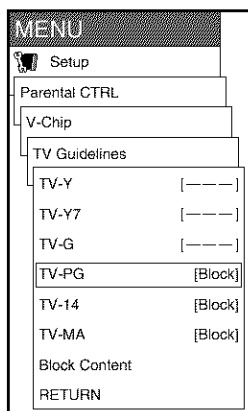
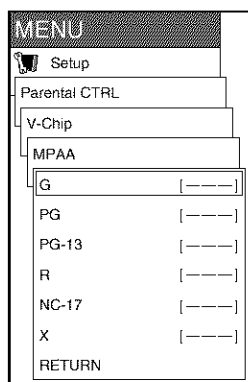
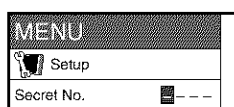
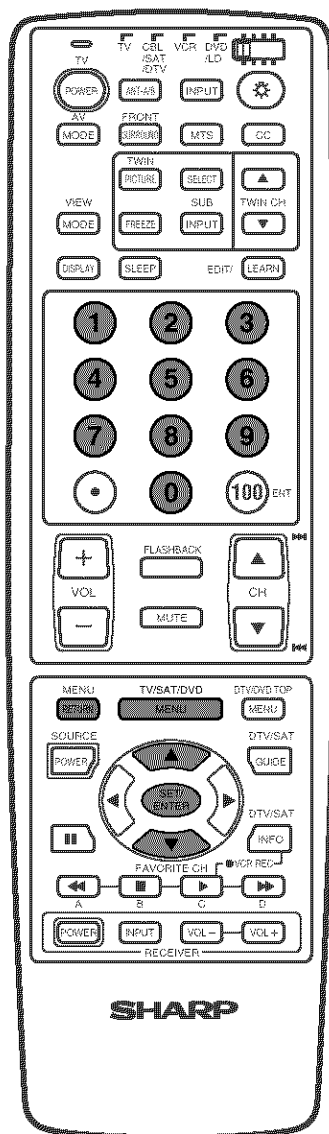

### Voluntary movie rating system (MPAA)

- 1 Press **MENU**.
- 2 Press **▲/▼** to select "Setup", and then press **SET/ENTER**.
  - Secret number setting menu displays only when "Secret No." is set. (See page 58.)
  - "V-Chip" and "Status" will not be selectable from the menu if you do not first configure your secret number. (See page 58.)
- 3 Enter your 4-digit secret number with **0–9** to cancel the "Secret No." when you set it.
- 4 Press **▲/▼** to select "Parental CTRL", and then press **SET/ENTER**.
- 5 Press **▲/▼** to select "V-Chip", and then press **SET/ENTER**.
- 6 Press **▲/▼** to select "MPAA", and then press **SET/ENTER**.
- 7 Press **▲/▼** to select the desired item, and then press **SET/ENTER** to select "Block".
  - The setting automatically enters "Block" for any ratings below your selection.
  - If Status is not set to "On" the configuration settings will not work. (See page 59.)
- 8 Press **MENU** to exit the menu.

#### NOTE

- Return to the previous menu by pressing **MENU RETURN**.

### TV Parental Guidelines (TV Guidelines)

- 1 Press **MENU**.
- 2 Press **▲/▼** to select "Setup", and then press **SET/ENTER**.
  - Secret number setting menu displays only when "Secret No." is set. (See page 58.)
  - "V-Chip" and "Status" will not be selectable from the menu if you do not first configure your secret number. (See page 58.)
- 3 Enter your 4-digit secret number with **0–9** to cancel the "Secret No." when you set it.
- 4 Press **▲/▼** to select "Parental CTRL", and then press **SET/ENTER**.
- 5 Press **▲/▼** to select "V-Chip", and then press **SET/ENTER**.
- 6 Press **▲/▼** to select "TV Guidelines", and then press **SET/ENTER**.
- 7 Press **▲/▼** to select the desired item, and then press **SET/ENTER** to select "Block".
  - The setting automatically enters "Block" for any ratings below your selection.
  - When "Block Content" is selected, its menu displays as shown left.
  - If Status is not set to "On" the configuration settings will not work. (See page 59.)
- 8 Press **MENU** to exit the menu.

#### NOTE

- Return to the previous menu by pressing **MENU RETURN**.



## Adjustment settings

### Canadian Rating Systems

- The TV rating systems in Canada are based on the Canadian Radio-Television and Telecommunications Commission (CRTC) policy on violence in television programming.
- While violence is the most important content element to be rated, the structure developed takes into consideration other program content like language, nudity, sexuality and mature themes.
- When setting the V-CHIP on the Canadian system you can chose either the Canadian English ratings or the Canadian French ratings.

### Canadian English ratings

Rating		Description
Age	E	Exempt: Includes news, sports, documentaries and other information programming; talk shows, music videos, and variety programming.
	C	Children: Intended for younger children under the age of 8 years. Pays careful attention to themes that could threaten their sense of security and well-being.
	C8+	Children over 8 years old: Contains no portrayal of violence as the preferred, acceptable, or only way to resolve conflict; nor encourage children to imitate dangerous acts which they may see on the screen.
	G	General: Considered acceptable for all age groups. Appropriate viewing for the entire family, contains very little violence, physical, verbal or emotional.
	PG	Parental Guidance: Intended for a general audience, but may not be suitable for younger children (under the age of 8) because it could contain controversial themes or issues.
	14+	Over 14 Years: Could contain themes where violence is one of the dominant elements of the storyline, but it must be integral to the development of plot or character. Language usage could be profane and nudity present within the context of the theme.
	18+	Adults: Intended for viewers 18 years and older and might contain depictions of violence, which while related to the development of plot, character or themes, are intended for adult viewing. Could contain graphic language and portrayals of sex and nudity.

### Canadian French ratings

Rating		Description
Age	E	Exempt programming.
	G	General: All ages and children, contains minimal direct violence, but may be integrated into the plot in a humorous or unrealistic manner.
	8ans +	General but inadvisable for young children: May be viewed by a wide public audience, but could contain scenes disturbing to children under eight who cannot distinguish between imaginary and real situations. Recommended for viewing with parent.
	13ans +	Over 13 years: Could contain scenes of frequent violent scenes and therefore recommended for viewing with parent.
	16ans +	Over 16 years: Could contain frequent violent scenes and intense violence.
	18ans +	Over 18 years: Only for adult viewing. Could contain frequent violent scenes and extreme violence.

## Adjustment settings

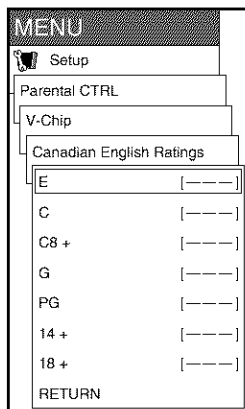
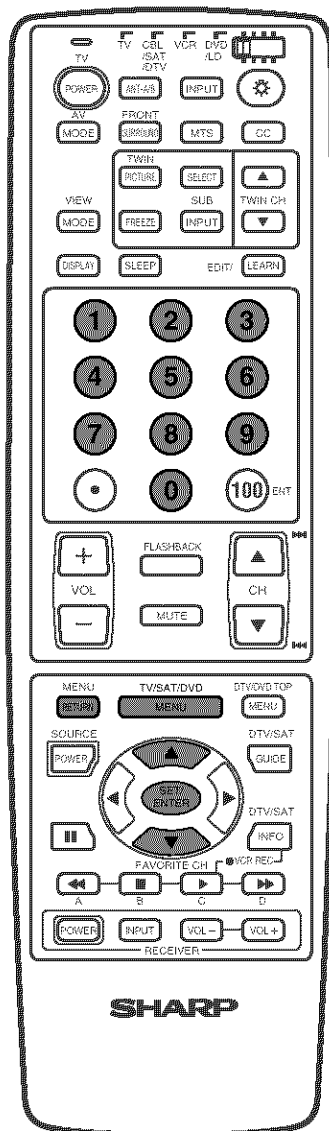

### Canadian English ratings

- 1 Press **MENU**.
- 2 Press **▲/▼** to select "Setup", and then press **SET/ENTER**.
  - Secret number setting menu displays only when "Secret No." is set. (See page 58.)
  - "V-Chip" and "Status" will not be selectable from the menu if you do not first configure your secret number. (See page 58.)
- 3 Enter your 4-digit secret number with **0–9** to cancel the "Secret No." when you set it.
- 4 Press **▲/▼** to select "Parental CTRL", and then press **SET/ENTER**.
- 5 Press **▲/▼** to select "V-Chip", and then press **SET/ENTER**.
- 6 Press **▲/▼** to select "Canadian English Ratings", and then press **SET/ENTER**.
- 7 Press **▲/▼** to select the desired item, and then press **SET/ENTER** to select "Block".
  - The setting automatically enters "Block" for any ratings below your selection.
  - If Status is not set to "On" the configuration settings will not work. (See page 59.)
- 8 Press **MENU** to exit the menu.

#### NOTE

- Return to the previous menu by pressing **MENU RETURN**.

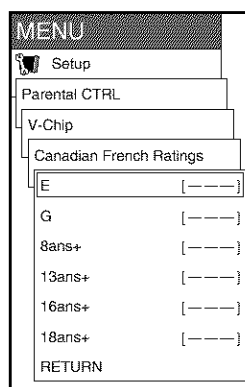

### Canadian French ratings

- 1 Press **MENU**.
- 2 Press **▲/▼** to select "Setup", and then press **SET/ENTER**.
  - Secret number setting menu displays only when "Secret No." is set. (See page 58.)
  - "V-Chip" and "Status" will not be selectable from the menu if you do not first configure your secret number. (See page 58.)
- 3 Enter your 4-digit secret number with **0–9** to cancel the "Secret No." when you set it.
- 4 Press **▲/▼** to select "Parental CTRL", and then press **SET/ENTER**.
- 5 Press **▲/▼** to select "V-Chip", and then press **SET/ENTER**.
- 6 Press **▲/▼** to select "Canadian French Ratings", and then press **SET/ENTER**.
- 7 Press **▲/▼** to select the desired item, and then press **SET/ENTER** to select "Block".
  - The setting automatically enters "Block" for any ratings below your selection.
  - If Status is not set to "On" the configuration settings will not work. (See page 59.)
- 8 Press **MENU** to exit the menu.

#### NOTE

- Return to the previous menu by pressing **MENU RETURN**.

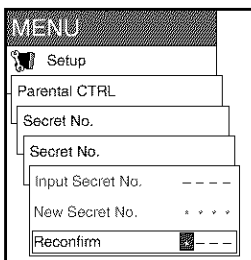
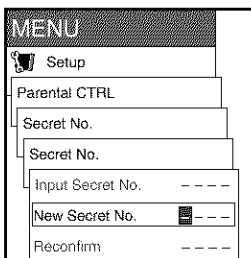
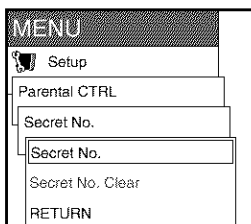
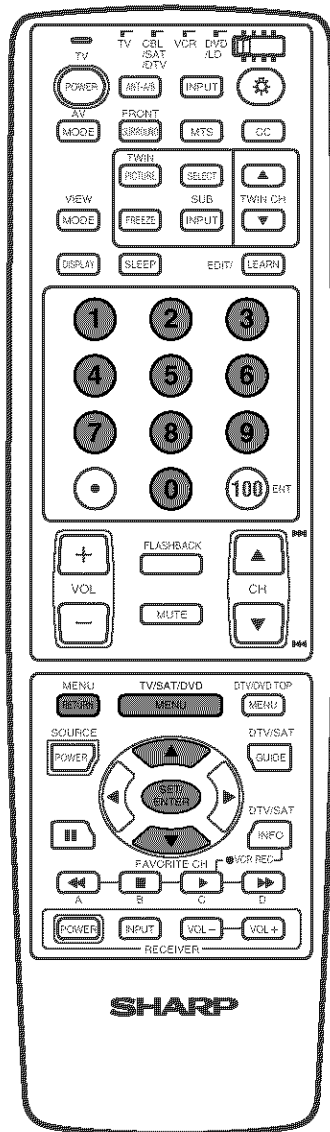

**Secret number setting menu**

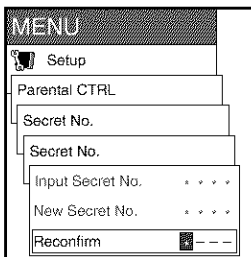
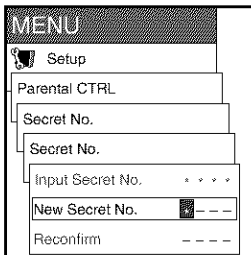
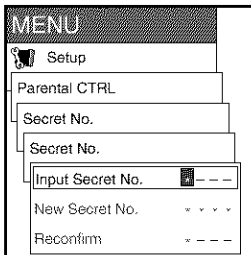
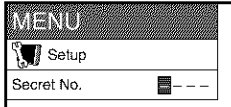

**Secret number setting for parental control (TV/VIDEO mode only)**

Allows you to use a secret number to protect certain settings from being accidentally changed.

**Setting a secret number**

- 1 Press **MENU**.
- 2 Press **▲/▼** to select "Setup", and then press **SET/ENTER**.
- 3 Press **▲/▼** to select "Parental CTRL", and then press **SET/ENTER**.
- 4 Press **▲/▼** to select "Secret No.", and then press **SET/ENTER**.
- 5 Repeat step 4 again.
- 6 Enter the 4-digit number as a secret number using **0 - 9**.
- 7 And enter the same 4-digit number on the "Reconfirm" screen as in step 6 to confirm.
  - "New Secret No. is registered." displays.
- 8 Press **MENU** to exit the menu.

**NOTE**

- Return to the previous menu by pressing **MENU RETURN**.

**Changing the secret number**

Allows you to change your current secret number.

- 1 Press **MENU**.
- 2 Press **▲/▼** to select "Setup", and then press **SET/ENTER**.
  - Secret number setting menu displays.
- 3 Enter your 4-digit secret number with **0 - 9** to cancel the "Secret No." when you set it.
- 4 Press **▲/▼** to select "Parental CTRL", and then press **SET/ENTER**.
- 5 Press **▲/▼** to select "Secret No.", and then press **SET/ENTER**.
- 6 Repeat step 5 again.
- 7 Enter the Old 4-digit number you have set using **0 - 9**.
- 8 Enter the New 4-digit number you have set using **0 - 9**.
- 9 And enter the same 4-digit number on the "Reconfirm" screen as in step 8 to confirm.
  - "New Secret No. is registered." displays.
- 10 Press **MENU** to exit the menu.

**NOTE**

- Return to the previous menu by pressing **MENU RETURN**.

## Adjustment settings

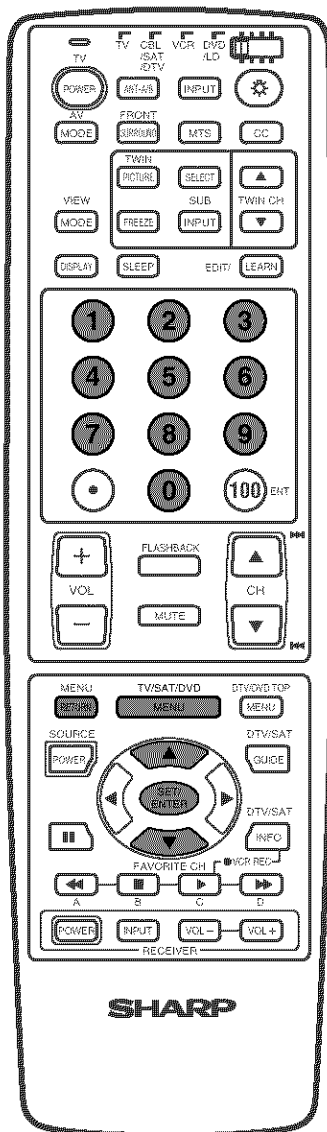

### Secret number setting menu

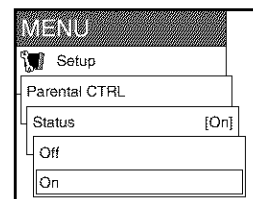
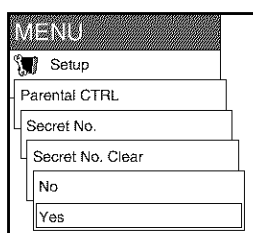
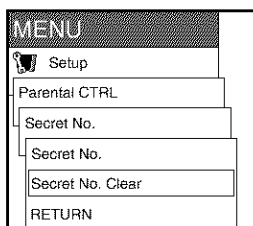
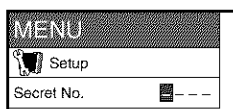

### Clearing the secret number

Allows you to clear your secret number.

- 1 Press **MENU**.
- 2 Press **▲/▼** to select "Setup", and then press **SET/ENTER**.
  - Secret number setting menu displays.
- 3 Enter your 4-digit secret number with **0–9** to cancel the "Secret No." when you set it.
  - Setup menu displays.
- 4 Press **▲/▼** to select "Parental CTRL", and then press **SET/ENTER**.
- 5 Press **▲/▼** to select "Secret No.", and then press **SET/ENTER**.
- 6 Press **▲/▼** to select "Secret No. Clear", and then press **SET/ENTER**.
- 7 Press **▲/▼** to select "Yes", and then press **SET/ENTER**.
  - Your secret number is cleared.
- 8 Press **MENU** to exit the menu.

#### NOTE

- See page 58 for re-registering with a new secret number after being cleared.
- Return to the previous menu by pressing **MENU RETURN**.
- **As a precautionary measure, make a note of your secret number and keep it in a familiar place. If you lose or forget your secret number, initialize the Liquid Crystal Television to return all settings except for the TV channel settings to factory preset values. (See page 77.)**

### Setting parental control status

Used to enable or disable the parental control function.

- 1 Press **MENU**.
- 2 Press **▲/▼** to select "Setup", and then press **SET/ENTER**.
  - Secret number setting menu displays only when "Secret No." is set. (See page 58.)
  - "V-Chip" and "Status" will not be selectable from the menu if you do not first configure your secret number. (See page 58.)
- 3 Enter your 4-digit secret number with **0–9** to cancel the "Secret No." when you set it.
- 4 Press **▲/▼** to select "Parental CTRL", and then press **SET/ENTER**.
- 5 Press **▲/▼** to select "Status", and then press **SET/ENTER**.
- 6 Press **▲/▼** to select "On" or "Off", and then press **SET/ENTER**.
  - Select "On" to enable and "Off" to disable Parental CTRL.
- 7 Press **MENU** to exit the menu.

#### NOTE

- If the secret number is cleared the Status setting automatically sets to "Off". "V-Chip" and "Status" will not be selectable from the menu.
- Return to the previous menu by pressing **MENU RETURN**.

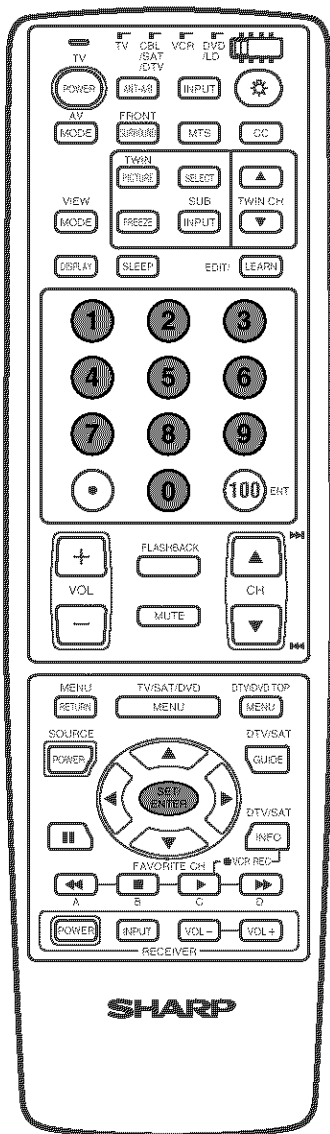

### How to temporarily release the V-CHIP BLOCK

- The V-CHIP BLOCK is working and censors a broadcast, “V-CHIP HAS BEEN ACTIVATED.” displays.

- 1 Press **SET/ENTER** while the V-CHIP is working and then the secret number setting menu displays.
- 2 Enter your 4-digit secret number with **0 – 9** and then press **SET/ENTER**. At this time V-CHIP BLOCK temporarily releases.

### Reactivating the temporarily released V-CHIP BLOCK

- You can reactivate the temporarily released V-CHIP BLOCK as shown below.

#### Method 1:

Select “Status” setting from the Parental CTRL menu to reactivate BLOCK.

#### Method 2:

Select “V-Chip” setting (“MPAA”, “TV Guidelines”, “Canadian English Ratings” or “Canadian French Ratings”) from the Parental CTRL to reactivate BLOCK.

#### Method 3:

Switch off the AVC System power.

#### NOTE

- Performing any of the three above will activate the V-CHIP BLOCK.

# Other viewing options

## Twin picture functions

Allows you to display two pictures on the screen at one time.

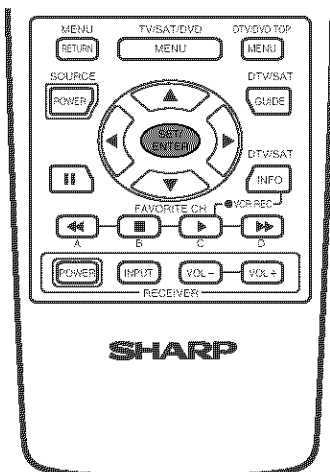
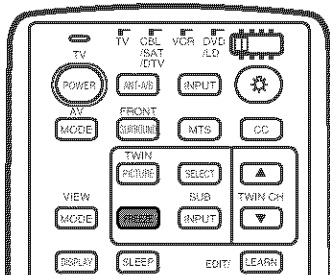
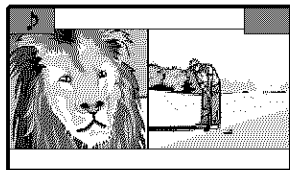
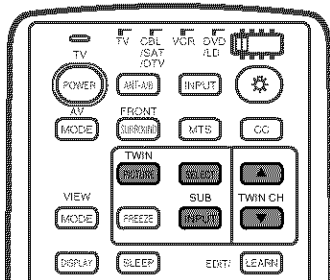

### Twin picture in all cases

You can display two same-sized pictures except when inputting from a PC INPUT terminal.

#### 1 Press **TWIN PICTURE**.

- Twin picture displays and a selected input source image displays.

#### 2 Press **SELECT** to set either screen to be active.

- "▶" displays on the active screen, which has sound output.

#### 3 Press **TWIN CH ▲/▼** to select another channel on the inactive screen.

#### 4 Press **SUB INPUT** to select another input source on the inactive screen.

- A selected image displays.

#### 5 Press **TWIN PICTURE** to exit twin picture.

### NOTE

- This function does not work under the following input conditions:
  - ① PC INPUT mode,
  - ② Two pictures from the same source (e.g. INPUT 1 and INPUT 1),
  - ③ Images from HDTV signal source.
- When this function is not available, "No dual screen display available" will display.

### Picture and still image

You can display two same-sized pictures when inputting from a AV source.

#### 1 Press **FREEZE**.

- A moving image displays on the left screen and a still image displays on the right screen. The still image is one frame captured from a moving image at the moment you press **FREEZE**.

#### 2 Update the still image by pressing **SET/ENTER**.

- Each time you press **SET/ENTER**, the image on the right screen updates.

#### 3 Press **FREEZE** to exit still image.

### NOTE

- This function does not work under the following input conditions:
  - ① PC INPUT mode,
  - ② Images from HDTV signal source.
- When this function is not available, "No still image display available." will display.

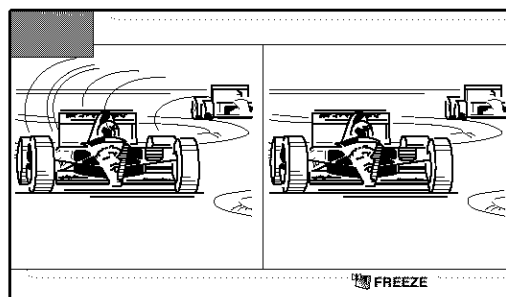

## Learning remote control function

You can operate the connected AV products (AV Receiver, Cable Box, SAT tuner, DTV, VCR, DVD, LD) using the learning function for your remote control unit. This remote control unit has the function that can memorize each remote control code.

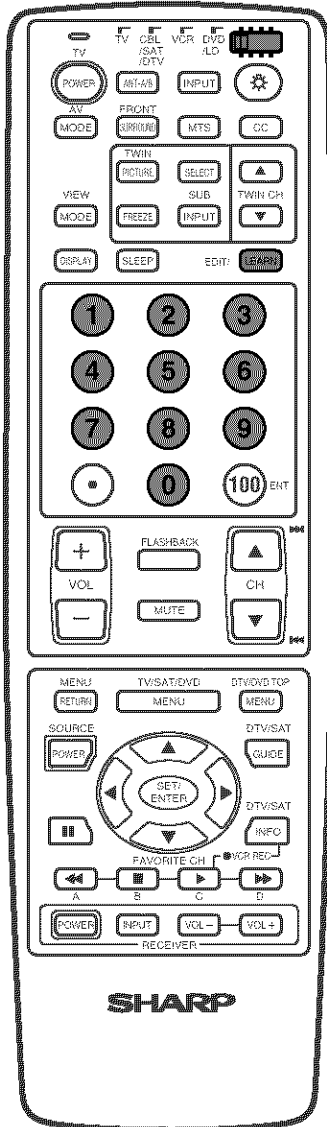

### Presetting manufacture codes

- 1 Slide the **Mode switch** to match the device to which you want to preset the remote control signal.
- 2 Press **EDIT/LEARN** and **1** at the same time.
  - LED flashes continuously.
- 3 Press **0 – 9** to enter the manufacture code. (See page 63.)
  - Preset mode is finished once the LED no longer lights up.

#### NOTE

- To stop the EDIT mode in the middle, press **EDIT/LEARN** once more.
- If **Mode switch** is switched while in EDIT mode, EDIT mode will be canceled.
- If there is no operation for over 1 minute running, exit this mode.
- When you enter a code that is not listed, LED flashes quickly.
- If the table on page 63 does not include your desired manufacturer or the remote control does not work, you can make the memory learn its signal by the learn mode.
- The initial mode is "00" (SHARP).

### Learning the remote control

- 1 Be sure to slide the **Mode switch** to match the device whose remote control signal you want to be learned.
- 2 Press **EDIT/LEARN** and **2** at the same time.
  - LED flashes continuously.
- 3 Press a button for you want to learn.
  - Refer to the assigning buttons to functions on each page.(See page 64 to 69.)
  - The LED changes from lit up to flashing state.
  - When the learn mode is finished, LED lights up once and returns to the learn mode (LED flashes continuously).

- 4 To exit learn mode, press **EDIT/LEARN**.

#### NOTE

- To stop the EDIT mode in the middle, press **EDIT/LEARN** once more.
- If **Mode switch** is switched while in EDIT mode, EDIT mode will be canceled.
- If there is no operation for over 1 minute running, exit this mode.
- If **TV POWER** is pressed over 2 seconds running (LED flashes continuously, step 2 above), the learning codes of the current **Mode switch** position clear, changing back to preset manufacturer codes. In this case, the LED turns off after 2 seconds exiting learning mode.

0.8 to 2.0 inch (2 to 5 cm)

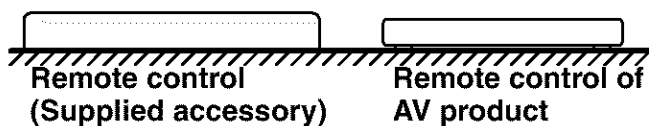

## Other viewing options

### Manufacture codes

	CATV/SAT/ DTV	VCR	DVD/LD
00	PIONEER1 (CATV)	SHARP1	SHARP (DVD)
01	PIONEER2 (CATV)	SHARP2	PIONEER (DVD)
02	JERROLD1 (CATV)	SHARP3	PANASONIC (DVD)
03	JERROLD2(CATV)	PIONEER	SAMSUNG (DVD)
04	JERROLD3 (CATV)	FISHER	SONY (DVD)
05	JERROLD4 (CATV)	FISHER	TOSHIBA (DVD)
06	JERROLD5 (CATV)	FISHER	JVC (DVD)
07	JERROLD6 (CATV)	GOLDSTAR	
08	JERROLD7 (CATV)	HITACHI1	
09	JERROLD8 (CATV)	HITACHI2	
10	JERROLD9 (CATV)	HITACHI3	
11	JERROLD10 (CATV)	MAGNAVOX2	
12	S.A.1 (CATV)	MITSUBISHI1	
13	S.A.2 (CATV)	MITSUBISHI2	
14	S.A.3 (CATV)	MITSUBISHI3	
15	S.A.4 (CATV)	MITSUBISHI4	
16	ZENITH1 (CATV)	MITSUBISHI5	
17	ZENITH2 (CATV)	MITSUBISHI6	
18	ZENITH3 (CATV)	PANASONIC1	
19		PANASONIC2	
20	PIONEER (SAT)	PANASONIC3	PIONEER (LD)
21	RCA1 (SAT)	RCA1	KENWOOD (LD)
22	RCA2 (SAT)	RCA2	PANASONIC1 (LD)
23	SONY (SAT)	RCA3	PANASONIC2 (LD)

	CATV/SAT/ DTV	VCR	DVD/LD
24		SANYO1	PHILIPS (LD)
25		SANYO2	RCA (LD)
26		SANYO3	SONY (MDP)
27		SONY (BETA)	SONY (LD)
28		SONY (VHS)	
29		SONY (8 mm)	
30	PIONEER (DTV)	TOSHIBA	
31	SHARP (DTV)	JVC1	
32		JVC2	
33		JVC3	
34		JVC4	
35		JVC5	
36		ZENITH	



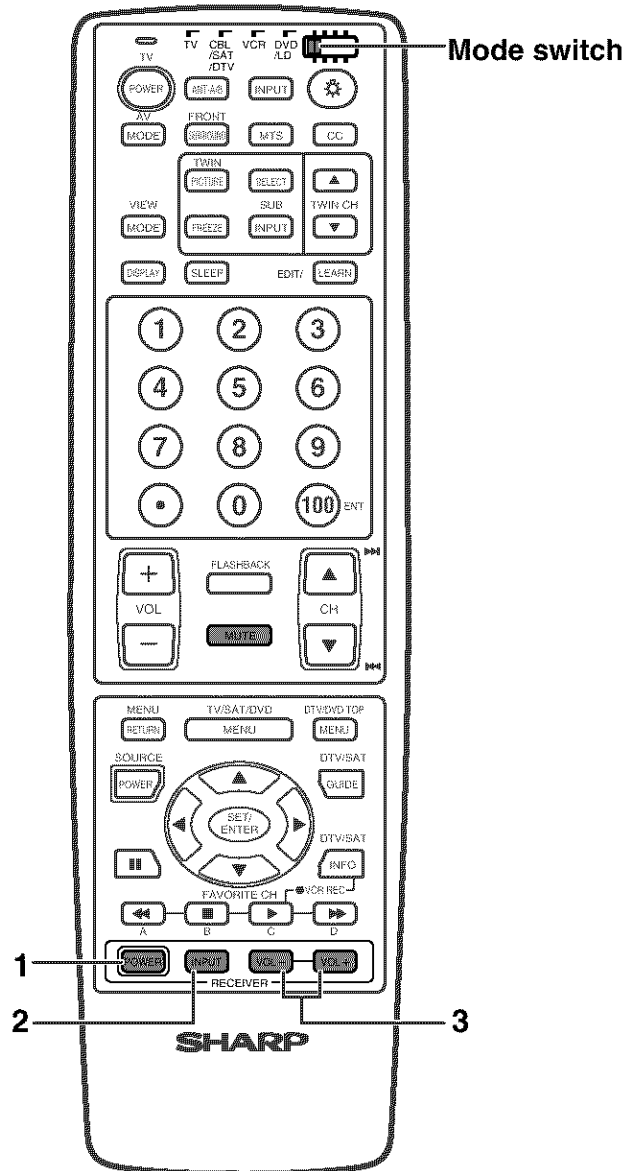

**Using the TV remote control unit to control other devices**

**Receiver control buttons**

When a SHARP receiver is connected to the display, the receiver can operate using buttons **1** to **3**. When another non-SHARP receiver is connected to the display, the signals for **1** to **3** must first be learned before operating. (See page 62.)

- 1 RECEIVER POWER (STANDBY/ON)**  
Turns receiver power on and off.
- 2 RECEIVER INPUT**  
Selects the input source connected to the receiver.
- 3 RECEIVER VOL +/-**  
Adjusts receiver volume level. Press **RECEIVER VOL +** to increase the volume and **RECEIVER VOL -** to decrease it.

**NOTE**

- **(RECEIVER) MUTE**  
Allows remote unit to learn receiver's mute signal. Use this button when the mode switch is set to something other than TV.
- The color-highlighted buttons on the remote control can learn the control signal from another device's remote control.

## Other viewing options

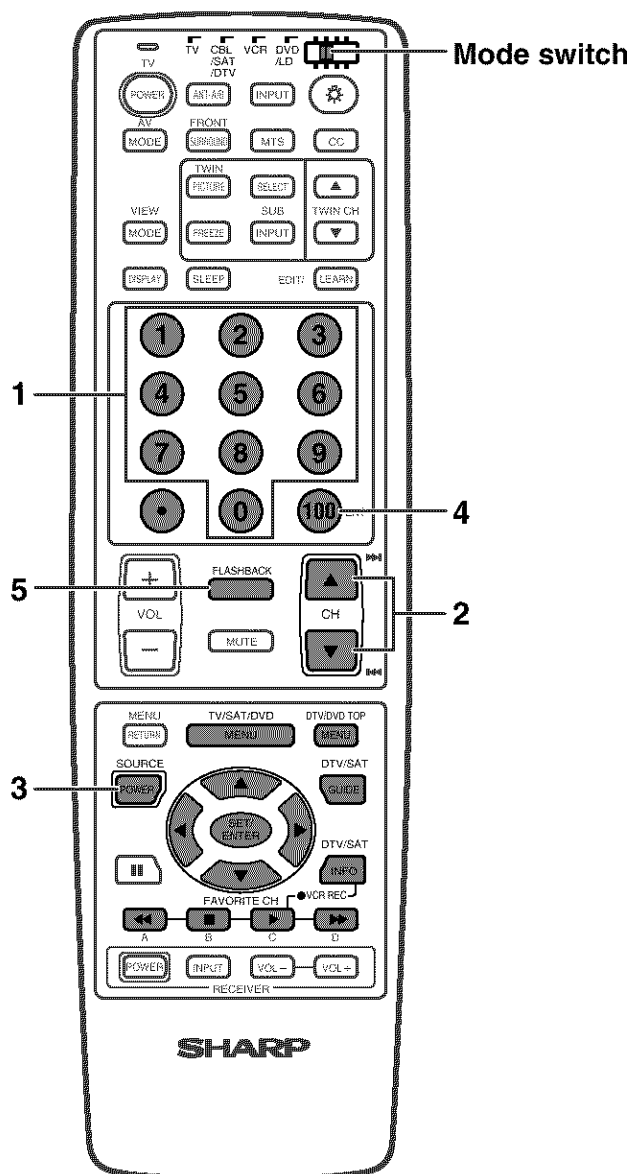

### Cable control buttons

When the **Mode switch** is set to CBL/SAT/DTV the cable converter connected to the display can operate using **1** to **5**.

Cable converters made by other manufacturers and not preset can also operate using the remote control unit if **1** to **5** have learned the functions. (See page 62.)

- 1 0 – 9**  
Press a button (or buttons) that corresponds to the channel that you wish to watch.
- 2 CH ▲/▼**  
Press **CH ▲** or **CH ▼** to tune in a higher or lower channel.
- 3 SOURCE POWER**  
Turns the cable converter power on and off.
- 4 100 ENT \***  
Fix the selected channel with the direct channel selection buttons.
- 5 FLASHBACK \***  
Press to switch between the current channel and the channel you were watching immediately before.

\* Some manufacturers do not preset **100 ENT** and **FLASHBACK**. Use these buttons to learn if necessary.

#### NOTE

- CABLE, SAT and DTV cannot be selected at the same time.
- The color-highlighted buttons on the remote control can learn the control signal from another device's remote control.

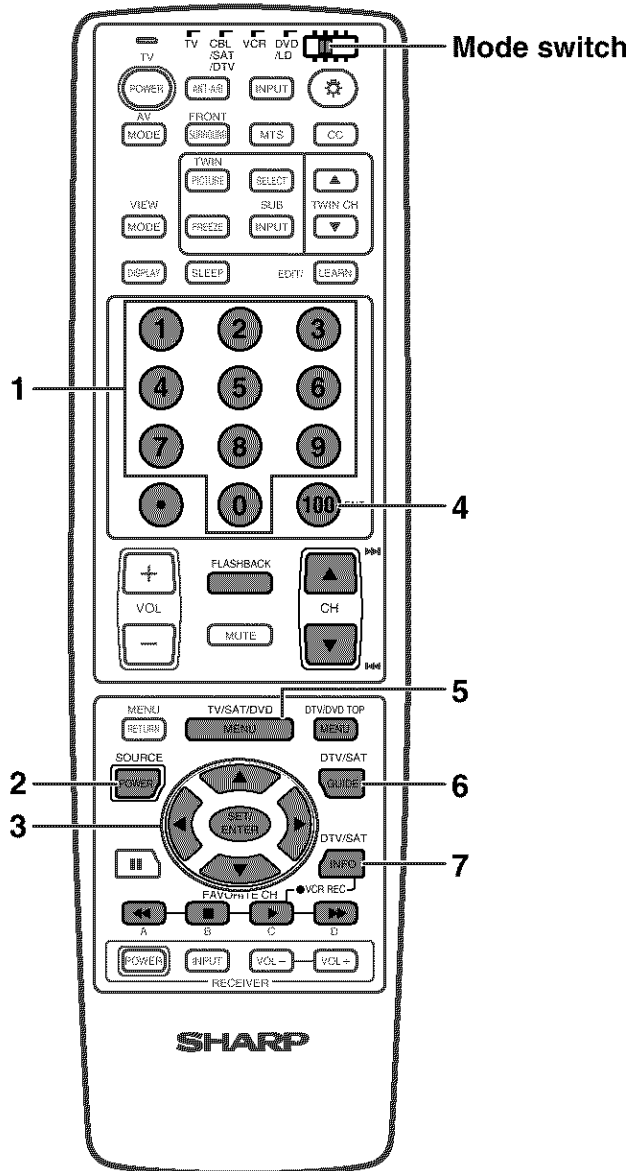

**SAT control buttons**

When the SAT is preset by the learning remote control function, the remote control unit buttons will function as shown below.

- When the **Mode switch** is set to CBL/SAT/DTV, satellite broadcast tuners made by other manufacturers and not preset can also operate with the remote control unit if **1** to **7** have learned the functions. (See page 62.)

- 0 – 9**  
Press a button (or buttons) that corresponds to the channel that you wish to watch.
- SOURCE POWER**  
Turns the Satellite broadcast tuner power on and off.
- SET/ENTER, ▲/▼/◀/▶**  
SET/ENTER: Press to activate the selected function.  
▲/▼/◀/▶: Press the button to select items on the SAT GUIDE screen or SAT MENU screen.
- 100 ENT**  
Fix the selected channel with the direct channel selection buttons.  
• Use this button to learn if necessary.
- SAT MENU**  
When this button is pressed, the satellite broadcasting menu screen will display.
- SAT GUIDE**  
When this button is pressed, the satellite broadcasting guide screen will display.
- SAT INFO**  
When this button is pressed, information on satellite broadcasting will display.  
• Use this button to learn if necessary.

**NOTE**

- CABLE, SAT and DTV cannot be selected at the same time.
- The color-highlighted buttons shown in the figure at left can learn the control signal from another device's remote control.

## Other viewing options

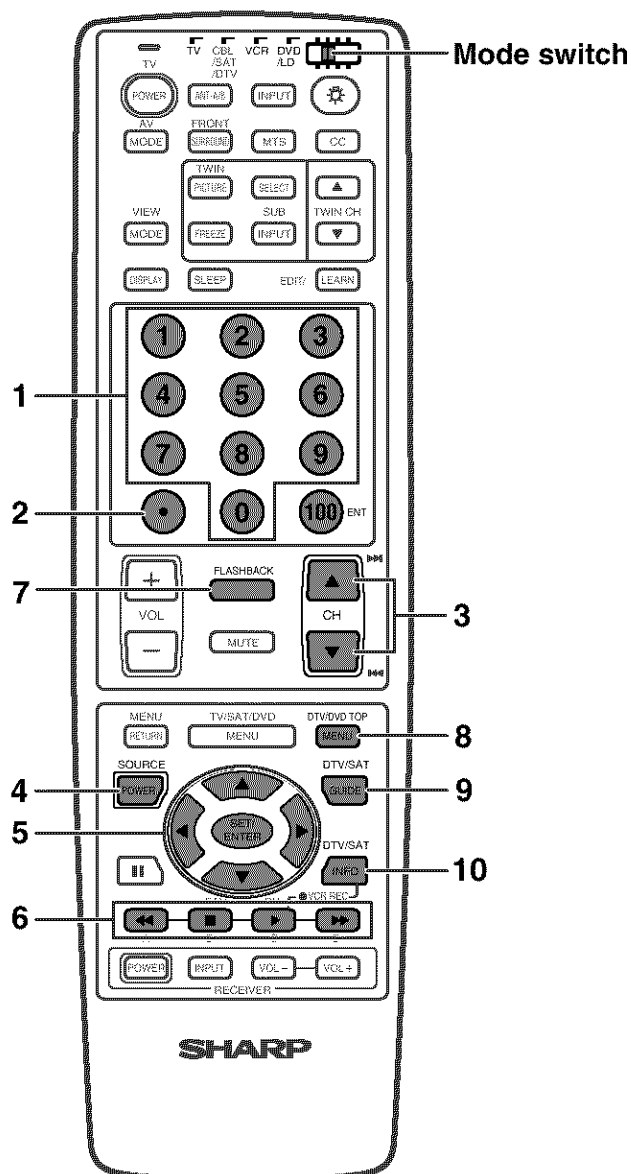

### DTV control buttons

For viewing DTV broadcasts, a digital TV tuner (commercially available) is necessary.

When the **Mode switch** is set to CBL/SAT/DTV, the remote control unit buttons will function as shown below.

- Operate the tuner using **1 to 10**.
- 1 0 – 9**  
Press a button (or buttons) that corresponds to the channel that you wish to watch.
  - 2 • (DOT)**  
Used for channel selection.
  - 3 CH ▲/▼**  
Press **CH ▲** or **CH ▼** to tune in a higher or lower channel.
  - 4 SOURCE POWER**  
Turns the digital TV tuner on and off.
  - 5 SET/ENTER, ▲/▼/◀/▶**  
SET/ENTER: Press to activate the selected function.  
▲/▼/◀/▶: Press the button to select items on the DTV MENU screen.
  - 6 FAVORITE CH/Colored (blue/green/red/yellow)**  
FAVORITE CH: Used for making FAVORITE CH settings with the digital TV tuner.  
Blue/green/red/yellow: Used to make selections from the digital TV tuner menu.
  - 7 FLASHBACK**  
Press to switch between the current channel and the channel you were watching immediately before.
  - 8 DTV/DVD TOP MENU**  
When this button is pressed, the DTV menu screen will display.
  - 9 DTV/SAT GUIDE**  
When this button is pressed, the DTV guide screen will display.
  - 10 DTV/SAT INFO**  
When this button is pressed, information on DTV will display.

### NOTE

- CABLE, SAT and DTV cannot be selected at the same time.
- The color-highlighted buttons on the remote control can learn the control signal from another device's remote control.

## Other viewing options

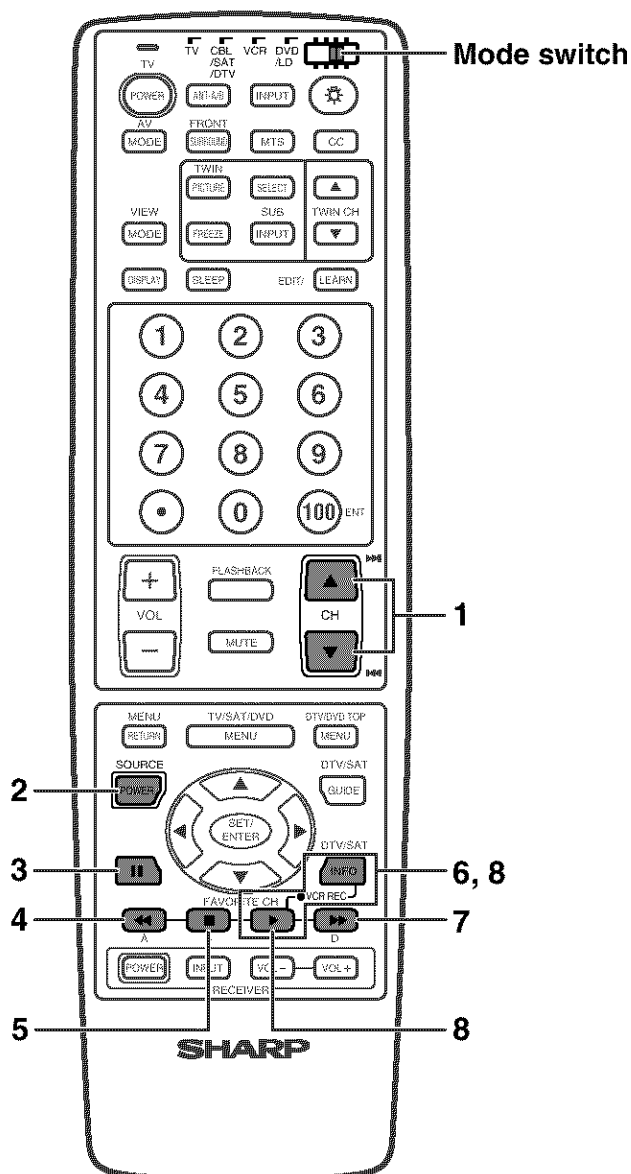

### VCR control buttons

When the VCR is preset by the learning remote control function, the remote control unit button will function as follows when the **Mode switch** of the remote control unit is set to VCR.

- When the input selector button having the same number as the input terminal connecting the VCR is pressed, the VCR can operate using **1** to **8**.
- VCR made by other manufacturers and not preset can also operate using the remote control unit if **1** to **8** have learned the functions. (See page 62.)

- CH ▲/▼**  
Press to select the channel of the TV tuner on the VCR.
- SOURCE POWER**  
Turns the power of the VCR on and off.
- ||**  
Set pauses and still pictures.
- ◀◀**  
Rewinds the tape and allows picture search.
- Stop the tape transport.
- 6, 8 VCR REC**  
Press these buttons at the same time to start recording.

#### NOTE

- Depending on the VCR manufacture, for some models, VCR REC is activated by first pressing **INFO** followed by **▶** while you keep pressing **INFO**. For other models, VCR REC is activated by following the opposite sequence; first pressing **▶** followed by **INFO** while you keep pressing **▶**. Please try both methods and use the appropriate one.

- ▶▶**  
Rapidly advances the tape and allows picture search.
- ▶**  
Selects playback.

#### NOTE

- The color-highlighted buttons on the remote control can learn the control signal from another device's remote control.

## Other viewing options

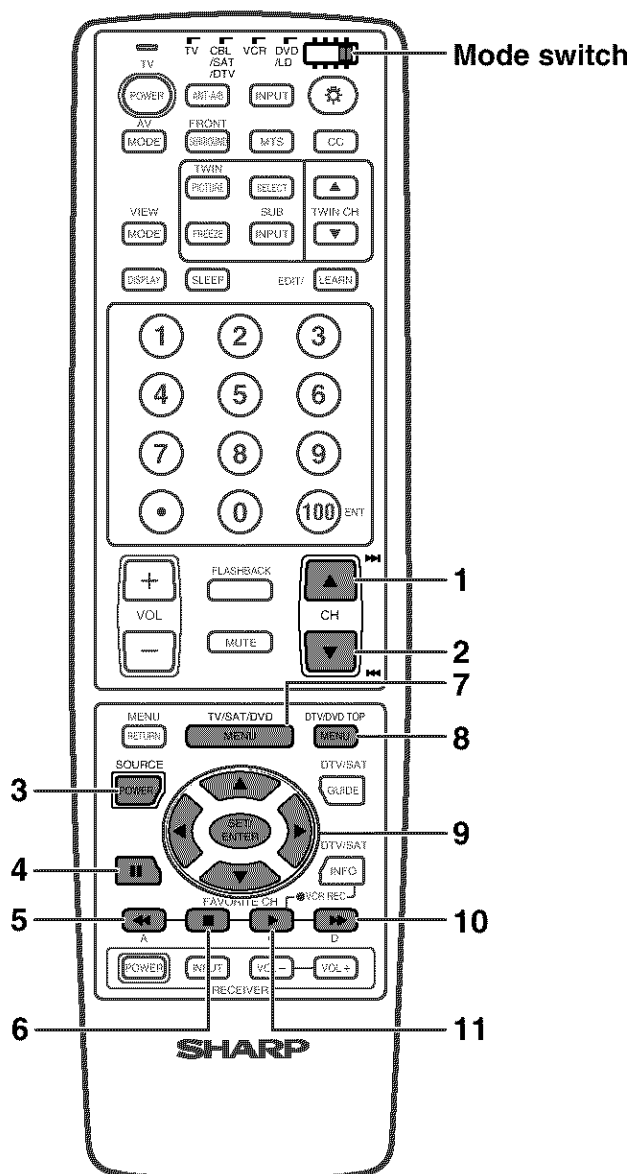

### DVD/LD control buttons

When the DVD/LD is preset by the learning remote control function, the remote control unit button will function as follows when the **Mode switch** of the remote control unit is set to DVD/LD.

- When the input selector button having the same number as the input terminal connecting a DVD player or LD player is pressed, these players can operate using **1 to 11**. (**7 to 9** are for DVD players only.)
- DVD/LD players made by other manufacturers and not preset can also operate using the remote control unit if **1 to 11** have learned the functions. (See page 62.)

- Pressing quickly once takes you to the start of the next chapter. Each time you press it, you move ahead to the start of the next chapter.
- Pressing quickly once takes you to the start of the chapter currently playing. Each time you press it, you move back to the start of the previous chapter.
- SOURCE POWER**  
Turns the power of the DVD/LD player on and off.
- Set pauses and still pictures.
- Continue pressing to go backward.
- Playback stops when pressing once. With some DVD/LD players, pressing the button twice may open the disc tray.
- DVD MENU (DVD only)**  
When this button is pressed, the DVD menu will display.
- DVD TOP MENU (DVD only)**  
When this button is pressed, the DVD top menu will display.
- SET/ENTER, ▲/▼/◀/▶ (DVD only)**  
SET/ENTER: Press to activate the selected function.  
▲/▼/◀/▶: Press the button to select items on the DVD MENU screen.
- Continue pressing for fast forward.
- Selects playback.

#### NOTE

- DVD and LD cannot be selected at the same time.
- The color-highlighted buttons on the remote control can learn the control signal from another device's remote control.

# Appendix

## Troubleshooting

Problem	Possible Solution
<ul style="list-style-type: none"> <li>No power</li> </ul>	<ul style="list-style-type: none"> <li>Make sure the Display and the AVC System are connected correctly. (See page 8.)</li> <li>Check if you pressed <b>TV POWER</b> on the remote control unit. (See page 16.) If the indicator on the Display lights up red, press <b>TV POWER</b>.</li> <li>Is the AC cord disconnected? (See page 15.)</li> <li>Has the main power been turned on? (See page 16.)</li> </ul>
<ul style="list-style-type: none"> <li>Unit cannot be operated.</li> </ul>	<ul style="list-style-type: none"> <li>External influences such as lightning, static electricity, may cause improper operation. In this case, operate the unit after first turning on the power of the Display and the AVC System, or unplugging the AC cord and replugging it in after 1 or 2 minutes.</li> </ul>
<ul style="list-style-type: none"> <li>Remote control unit does not operate.</li> </ul>	<ul style="list-style-type: none"> <li>Is the Mode switch set correctly? Slide it to the TV setting position.</li> <li>Are batteries inserted with polarity (+, -) aligned? (See page 9.)</li> <li>Are batteries worn out? (Replace with new batteries.)</li> <li>Are you using it under strong or fluorescent lighting?</li> <li>Is a fluorescent light illuminated near the remote control sensor?</li> </ul>
<ul style="list-style-type: none"> <li>Picture is cut off/with sidebar screen.</li> </ul>	<ul style="list-style-type: none"> <li>Is the image position correct? (See pages 24 and 45.)</li> <li>Are screen mode adjustments such as picture size made correctly? (See page 49)</li> </ul>
<ul style="list-style-type: none"> <li>Strange color, light color, or color misalignment</li> </ul>	<ul style="list-style-type: none"> <li>Adjust the picture tone. (See pages 29 to 33.)</li> <li>Is the room too bright? The picture may look dark in a room that is too bright.</li> <li>Check the input signal setting. (See page 47.)</li> </ul>
<ul style="list-style-type: none"> <li>Power is suddenly turned off.</li> </ul>	<ul style="list-style-type: none"> <li>Is the sleep timer set? (See page 52.)</li> <li>Check the power control settings? (See pages 35 to 37.)</li> <li>The unit's internal temperature has increased. Remove any objects blocking vent or clean.</li> </ul>
<ul style="list-style-type: none"> <li>No picture</li> </ul>	<ul style="list-style-type: none"> <li>Is connection to other components correct? (See pages 38 to 43.)</li> <li>Has setup been done correctly after connection? (See page 47.)</li> <li>Is the correct input selected? (See page 47.)</li> <li>Is a non-compatible signal being input? (See page 71.)</li> <li>Is picture adjustment correct? (See pages 29 to 33.)</li> </ul>
<ul style="list-style-type: none"> <li>No sound</li> </ul>	<ul style="list-style-type: none"> <li>Is the volume too low? (See page 19.)</li> <li>Is "Variable" selected in "Audio Out"? (See page 52.)</li> </ul>

### Use in hot and cold rooms (locations)

- When the unit is used in a low-temperature room location, the picture may leave trails or appear slightly delayed. This is not a malfunction, and the unit will recover when the temperature returns to normal.
- Do not leave the unit in a hot or cold location. Also, do not leave the unit in a location exposed to direct sunlight or near a heater, as this may cause the cabinet to deform and the Liquid Crystal panel to malfunction. (Storage temperature: -20°C to +60°C)

## Appendix

### Computer compatibility chart

Resolution	Frequency	Remarks
640 × 400	85 Hz	
720 × 400	70 Hz	
	85 Hz	
640 × 480	60 Hz	
	65 Hz	Macintosh 13" (67 Hz)
	72 Hz	
	75 Hz	
	85 Hz	
800 × 600	56 Hz	
	60 Hz	
	72 Hz	
	75 Hz	
	85 Hz	
832 × 624	74.5 Hz	Macintosh 16"
1024 × 768	60 Hz	
	70 Hz	
	75 Hz	Macintosh 19"
	85 Hz	
1280 × 768	60 Hz	
1280 × 1024	60 Hz	

Apple and Macintosh are registered trademarks of Apple Computer, Inc.  
DDC is a registered trademark of Video Electronics Standards Association.  
Power Management is a registered trademark of Sun Microsystems, Inc.  
VGA and XGA are registered trademarks of International Business Machines Co., Inc.



## RS-232C port specifications

### Computer Control of the Display

- When a program is set, the Display can be controlled from the computer using the RS-232C terminal. The input signal (computer/video) can be selected, the volume can be adjusted and various other adjustments and settings can be made, enabling automatic programmed playing.
- Attach an RS-232C cable cross-type (commercially available) to the supplied Din-D/sub RS-232C for the connections.

#### NOTE

- This operation system should be used by a person who is accustomed to using computers.

### Communication conditions

Set the RS-232C communications settings on the computer to match the display's communications conditions. The display's communications settings are as follows:

<b>Baud rate:</b>	9,600 bps
<b>Data length:</b>	8 bits
<b>Parity bit:</b>	None
<b>Stop bit:</b>	1 bit
<b>Flow control:</b>	None

### Communication procedure

Send the control commands from the computer via the RS-232C connector.

The display operates according to the received command and sends a response message to the computer.

Do not send multiple commands at the same time. Wait until the computer receives the OK response before sending the next command.

### Command format

Eight ASCII codes + CR

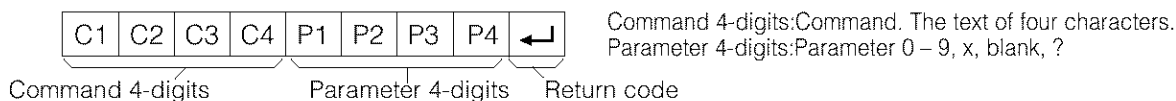

### Parameter

Input the parameter values, aligning left, and fill with blank(s) for the remainder. (Be sure that four values are input for the parameter.)

When the input parameter is not within an adjustable range, "ERR" returns. (Refer to "Response code format".)

No problem to input any numerical value for "x" on the table.

0			
0	0	0	9
-	3	0	
1	0	0	
0	0	5	5

When "?" is input for some commands, the present setting value responds.

?			
?	?	?	?

## Appendix

### Response code format

Normal response

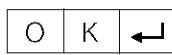

Return code (0DH)

Problem response (communication error or incorrect command)

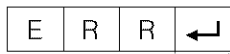

Return code (0DH)

### Command table

- About the command except being indicated here, it is outside the guarantee range of operation.

CONTROL ITEM		COMMAND	PARAMETER	CONTROL CONTENTS	
POWER SETTING		P O W E R	0 _ _ _	It shifts to standby.	
INPUT SELECTION A	TOGGLE	I T G D	x _ _ _ (Toggle)	It input-switches by the toggle. (It is the same as an input change key)	
	TV	I T V D	0 _ _ _	It input-switches to TV. (A channel remains as it is. (Last memory))	
	INPUT1-4	I A V D	* _ _ _	It input-switches to INPUT1~INPUT4.	
	PC	I P C D	x _ _ _	It input-switches to PC.	
INPUT SELECTION B	INPUT 1	I N P 1	0 _ _ _	AUTO	An input change is also included.
			1 _ _ _	AV-Y/C	
			2 _ _ _	COMPONENT	
	INPUT 3	I N P 3	0 _ _ _	AUTO	
			1 _ _ _	AV-Y/C	
			2 _ _ _	COMPONENT	
3 _ _ _	RGB				
AV MODE SELECTION		A V M D	0 _ _ _	(Toggle)	Although it can choose now, it is toggle operation in inside.
			1 _ _ _	STANDARD	
			2 _ _ _	DYNAMIC	
			3 _ _ _	MOVIE	
			4 _ _ _	GAME	
			5 _ _ _	USER	
VOLUME		V O L M	* * * _	Volume (0-60)	
POSITION	H-POSITION	H P O S	* * * _	TV/VIDEO mode. ( $\pm 15$ )	
	V-POSITION	V P O S	* * * _	PC mode. ( $\pm 90$ )	
			* * * _	TV/VIDEO mode. ( $\pm 30$ )	
	CLOCK	C L C K	* * * _	Only PC mode. ( $\pm 90$ )	
PHASE	P H S E	* * * _	Only PC mode. ( $\pm 20$ )		
VIEWMODE		W I D E	0 _ _ _	(Toggle) [TV/VIDEO]	Although it can choose now, it is toggle operation in inside.
			1 _ _ _	Side Bar [TV/VIDEO]	
			2 _ _ _	S.Stretch [TV/VIDEO]	
			3 _ _ _	Zoom [TV/VIDEO]	
			4 _ _ _	Stretch [TV/VIDEO]	
			5 _ _ _	Normal [PC]	
			6 _ _ _	Full [PC]	
			7 _ _ _	Dot by Dot [PC]	
			8 _ _ _	Dot by Dot (W) [PC]	
SRS		S R S S	0 _ _ _	(Toggle)	Toggle operation.
			1 _ _ _	off	
			2 _ _ _	SRS	
			3 _ _ _	FOCUS	
			4 _ _ _	FOCUS + SRS	
TWIN PICTURE		T W I N	0 _ _ _	One screen	
			1 _ _ _	Twin screens	
CHANNEL	DIRECT CHANNEL	D C C H	* * * _	The channel number of TV (1~125)	An input change is included if it is not TV display. In Air, 2-69ch is effective. In Cable, 1-125ch is effective.
	CH UP	C H U P	x _ _ _	The channel number of TV + 1	If it is not TV display, it will input-switch to TV.
	CH DOWN	C H D W	x _ _ _	The channel number of TV - 1	If it is not TV display, it will input-switch to TV.
ANT-A/B		A N T S	x _ _ _	(Toggle)	Change toggle operation of tuner A/B.
CC		C L C P	0 _ _ _	(Toggle)	Toggle operation of a closed caption.
			1 _ _ _	OFF	
			2 _ _ _	CC1	
			3 _ _ _	CC2	
			4 _ _ _	T1	
			5 _ _ _	T2	

#### NOTE

- If an underbar ( \_ ) appears in the parameter column, enter a space.
- If an asterisk (\*) appears, enter a value in the range indicated in brackets under CONTROL CONTENTS.
- As long as that from which the parameter ( x ) in the table is a numerical value, it may write anything.

## Appendix

### Specifications

Item		30" LIQUID CRYSTAL TELEVISION, Model: LC-30HV2U		
LCD panel		30" Advanced Super View & BLACK TFT LCD		
Number of dots		2,949,120 dots (1280 × 3 × 768dots)		
TV Function	TV-standard (CCIR)		American TV Standard NTSC System	
	Receiving Channel	VHF/UHF	VHF 2-13ch, UHF 14-69ch	
		CATV	1-125ch	
Audio multiplex		BTSC System		
Brightness		430 cd/m <sup>2</sup>		
Lamp life		60,000 hours (at normal mode)		
Viewing angles		H : 170° V : 170°		
Audio amplifier		10W × 2		
Speakers		8cm Ø 2pcs		
Terminals	AVC System	Rear	INPUT 1	S-VIDEO in, AV in, COMPONENT in
			INPUT 2	S-VIDEO in, AV in
			INPUT 3	S-VIDEO in, AV in, COMPONENT in, RGB in
			ANTENNA	75 Ω Unbalance, F Type for VHF/UHF/CATV in
			Monitor Out	Audio (Variable, Fixed), S-VIDEO out, AV out
	Front	INPUT 4	S-VIDEO, AV in	
		PC	15 Pin mini D-Sub, Audio in (3.5mm Ø jack)	
DISPLAY	Headphones	3.5mm Ø jack		
OSD language		English/French/Spanish		
Power Requirement		AC 110-240 V, 50/60 Hz		
Power Consumption	AVC System		40 W (0.6W Standby)	
	Display		114 W (0.9W Standby)	
Weight	AVC System		9.7 lbs (4.4 kg)	
	Display		41.9 lbs (19 kg)	
Accessories		Operation manual (× 1), Remote control unit (× 1), System cable (× 1), AC cord (× 2), "AA" size (UM/SUM-3) Alkaline battery (× 2)		

- As a part of policy of continuous improvement, SHARP reserves the right to make design and specification changes for product improvement without prior notice. The performance specification figures indicated are nominal values of production units. There may be some deviations from these values in individual units.

# Dimensional drawings

## Display

Unit: inch/mm

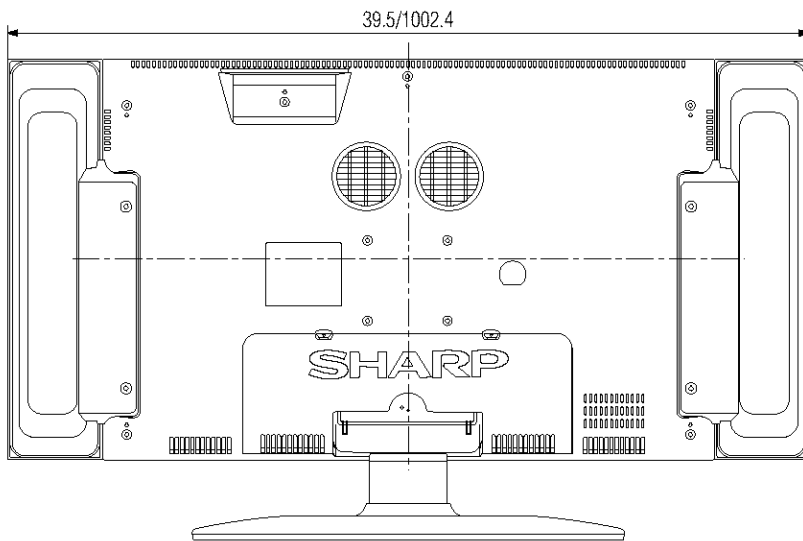
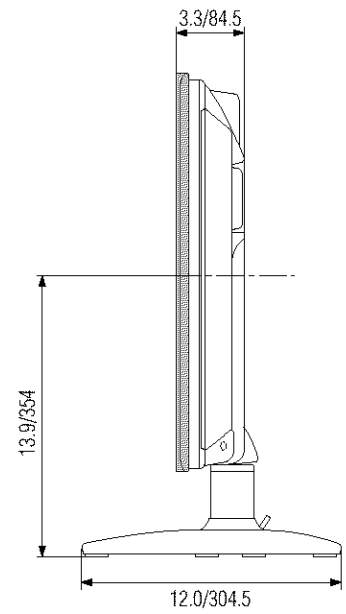
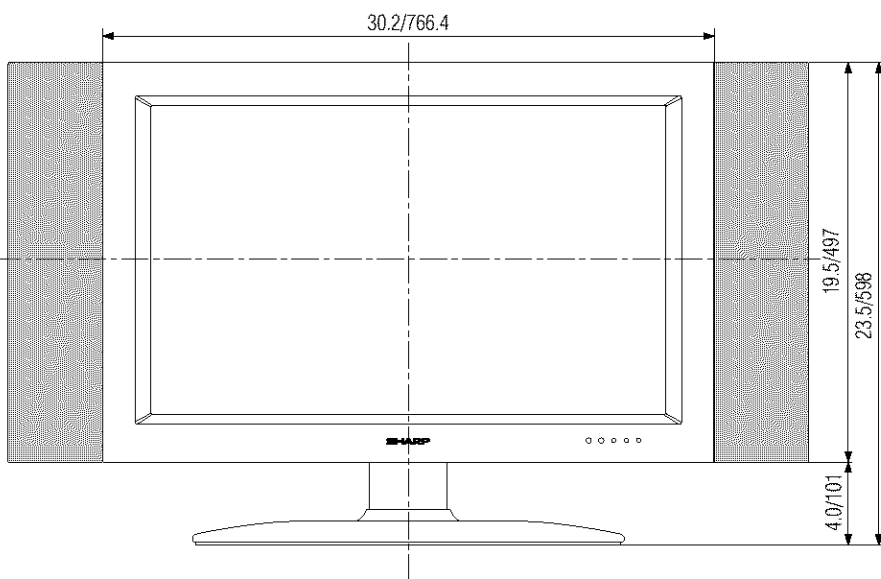
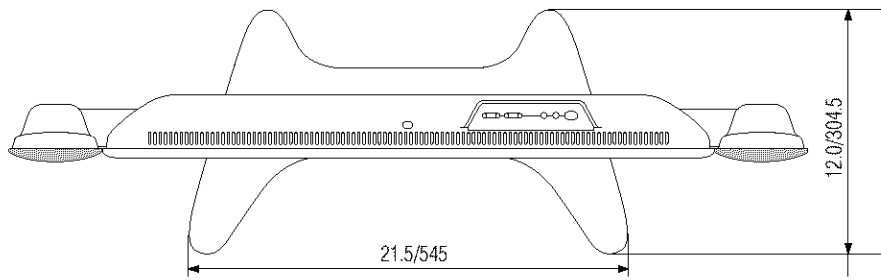

# Dimensional drawings

## AVC System

Unit: inch/mm

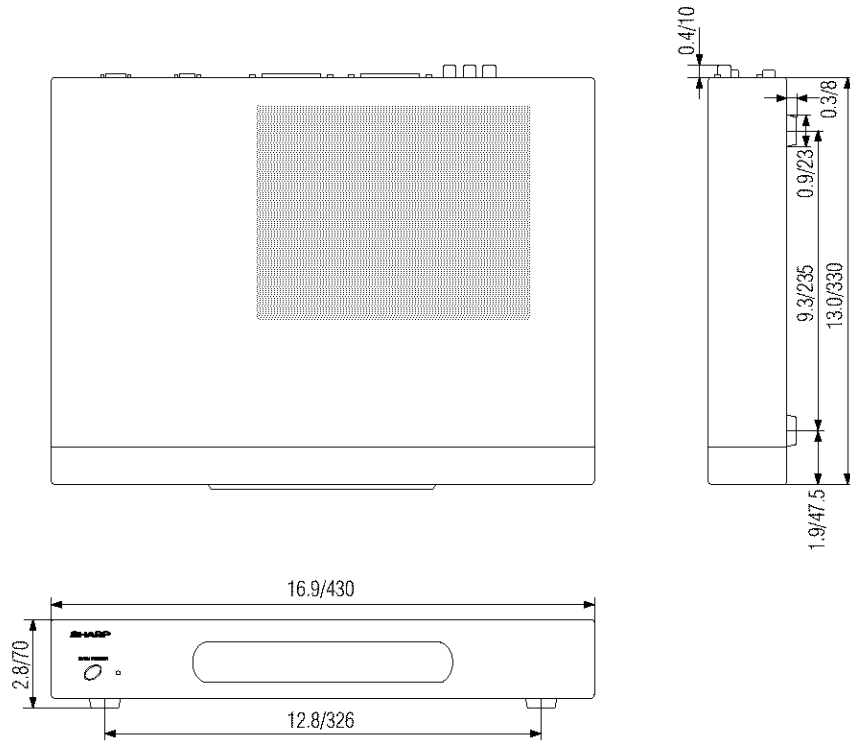

## HOW TO SET THE FACTORY PRESETS

Press and hold down **CLEAR** on the AVC System while it is in standby mode. Then press **POWER** button on the Display or **TV POWER** on the remote control unit to turn the System on.

All setting items (except TV channel) return to the factory presetting.

### NOTE

- Running the factory presetting operation also clears the secret number.

You can run the EZ Setup again by using the following steps.

- 1** Turn on the power of the Display and the AVC System.
- 2** Press **MENU**. (Make sure the menu screen displays.)
- 3** Press **▲/▼** to select "Setup".
- 4** Press **SET/ENTER**.

### NOTE

- If the secret number setting screen displays, you need to enter your secret number.
- If you forget your secret number, refer to HOW TO SET THE FACTORY PRESETS above.

- 5** Press **▲/▼** to select "EZ Setup".
- 6** Press **SET/ENTER**.

"EZ Setup completed" displays. After that, the screen changes to the TV mode.

The secret number is

--	--	--	--

### NOTE

- As a precautionary measure, make a note of your secret number above, scissor it from this manual, and keep it in a familiar place.



# Calling for Service

For location of the nearest Sharp Authorized Service, or to obtain product literature, accessories, supplies, or customer assistance, please call 1-800-BE-SHARP.

## LIMITED WARRANTY

### CONSUMER LIMITED WARRANTY

SHARP ELECTRONICS CORPORATION warrants to the first consumer purchaser that this Sharp brand product (the "Product"), when shipped in its original container, will be free from defective workmanship and materials, and agrees that it will, at its option, either repair the defect or replace the defective Product or part thereof with a new or remanufactured equivalent at no charge to the purchaser for parts or labor for the period(s) set forth below.

This warranty does not apply to any appearance items of the Product nor to the additional excluded item(s) set forth below nor to any Product the exterior of which has been damaged or defaced, which has been subjected to improper voltage or other misuse, abnormal service or handling, or which has been altered or modified in design or construction.

In order to enforce the rights under this limited warranty, the purchaser should follow the steps set forth below and provide proof of purchase to the servicer.

The limited warranty described herein is in addition to whatever implied warranties may be granted to purchasers by law. ALL IMPLIED WARRANTIES INCLUDING THE WARRANTIES OF MERCHANTABILITY AND FITNESS FOR USE ARE LIMITED TO THE PERIOD(S) FROM THE DATE OF PURCHASE SET FORTH BELOW. Some states do not allow limitations on how long an implied warranty lasts, so the above limitation may not apply to you.

Neither the sales personnel of the seller nor any other person is authorized to make any warranties other than those described herein, or to extend the duration of any warranties beyond the time period described herein on behalf of Sharp.

The warranties described herein shall be the sole and exclusive warranties granted by Sharp and shall be the sole and exclusive remedy available to the purchaser. Correction of defects, in the manner and for the period of time described herein, shall constitute complete fulfillment of all liabilities and responsibilities of Sharp to the purchaser with respect to the Product, and shall constitute full satisfaction of all claims, whether based on contract, negligence, strict liability or otherwise. In no event shall Sharp be liable, or in any way responsible, for any damages or defects in the Product which were caused by repairs or attempted repairs performed by anyone other than an authorized servicer. Nor shall Sharp be liable or in any way responsible for any incidental or consequential economic or property damage. Some states do not allow the exclusion of incidental or consequential damages, so the above exclusion may not apply to you.

THIS WARRANTY GIVES YOU SPECIFIC LEGAL RIGHTS. YOU MAY ALSO HAVE OTHER RIGHTS WHICH VARY FROM STATE TO STATE.

#### Model Specific Section

<b>Your Product Model Number &amp; Description:</b>	LC-30HV2U LCD Color Television  (Be sure to have this information available when you need service for your Product.)
<b>Warranty Period for this Product:</b>	One (1) year parts and labor from the date of purchase.
<b>Additional Item(s) Excluded from Warranty Coverage (if any):</b>	Non-rechargeable batteries.
<b>Where to Obtain Service:</b>	From a Sharp Authorized Servicer located in the United States. To find the location of the nearest Sharp Authorized Servicer, call Sharp toll free at 1-800-BE-SHARP.
<b>What to do to Obtain Service:</b>	Contact your Sharp Authorized Servicer to obtain in-home service for this Product. The Servicer will come to your home and if it is necessary to remove the Product, the Servicer will reinstall it. Be sure to have <b>Proof of Purchase</b> available.

# SHARP®

## SHARP ELECTRONICS CORPORATION

Sharp Plaza, Mahwah, New Jersey 07430-2135

## SHARP CORPORATION



**LIMITED WARRANTY**

*Consumer Electronics Products*

**Congratulations on your purchase!**

Sharp Electronics of Canada Ltd. (hereinafter called "Sharp") gives the following express warranty to the first consumer purchaser for this Sharp brand product, when shipped in its original container and sold or distributed in Canada by Sharp or by an Authorized Sharp Dealer:

Sharp warrants that this product is free, under normal use and maintenance, from any defects in material and workmanship. If any such defects should be found in this product within the applicable warranty period, Sharp shall, at its option, repair or replace the product as specified herein.

This warranty shall not apply to:

- (a) Any defects caused or repairs required as a result of abusive operation, negligence, accident, improper installation or inappropriate use as outlined in the owner's manual.
- (b) Any Sharp product tampered with, modified, adjusted or repaired by any party other than Sharp, Sharp's Authorized Service Centres or Sharp's Authorized Servicing Dealers.
- (c) Damage caused or repairs required as a result of the use with items not specified or approved by Sharp, including but not limited to head cleaning tapes and chemical cleaning agents.
- (d) Any replacement of accessories, glassware, consumable or peripheral items required through normal use of the product including but not limited to earphones, remote controls, AC adapters, batteries, temperature probe, stylus, trays, filters, belts, ribbons, cables and paper.
- (e) Any cosmetic damage to the surface or exterior that has been defaced or caused by normal wear and tear.
- (f) Any damage caused by external or environmental conditions, including but not limited to transmission line/power line voltage or liquid spillage.
- (g) Any product received without appropriate model, serial number and CSA/cUL markings.
- (h) Any products used for rental or commercial purposes.
- (i) Any installation, setup and/or programming charges.

Should this Sharp product fail to operate during the warranty period, warranty service may be obtained upon delivery of the Sharp product together with proof of purchase and a copy of this LIMITED WARRANTY statement to an Authorized Sharp Service Centre or an Authorized Sharp Servicing Dealer. In home warranty service may be provided at Sharp's discretion on any Sharp television with the screen size of 27" or larger and on any Sharp Over-the-Range Microwave Oven.

This warranty constitutes the entire express warranty granted by Sharp and no other dealer, service centre or their agent or employee is authorized to extend, enlarge or transfer this warranty on behalf of Sharp. To the extent the law permits, Sharp disclaims any and all liability for direct or indirect damages or losses or for any incidental, special or consequential damages or loss of profits resulting from a defect in material or workmanship relating to the product, including damages for the loss of time or use of this Sharp product or the loss of information. The purchaser will be responsible for any removal, reinstallation, transportation and insurance costs incurred. Correction of defects, in the manner and period of time described herein, constitute complete fulfillment of all obligations and responsibilities of Sharp to the purchaser with respect to the product and shall constitute full satisfaction of all claims, whether based on contract, negligence, strict liability or otherwise.

**WARRANTY PERIODS:**

	Parts & Labour (exceptions noted)
Audio Products	1 year
Camcorder	1 year
DVD Products	1 year
LCD Projector	1 year (lamp 90 days)
LCD TV	1 year
Microwave Oven	2 years (magnetron component-3 additional years)
Television Products	1 year (picture tube component-1 additional year)
VCR Product	1 year
Vacuum Cleaner	1 year

To obtain the name and address of the nearest Authorized Sharp Service Centre or Dealer, please contact:  
SHARP ELECTRONICS OF CANADA LTD. 335 Britannia Road East Mississauga, Ontario L4Z 1W9

For more information on this Warranty, Sharp Extended Warranty Offers, Sharp Canada Products, Accessory Sales, Dealer or Service Locations, Tronto please call (905) 568-7140  
Visit our Web site: [www.sharp.ca](http://www.sharp.ca)





**SHARP**<sup>®</sup>  
**SHARP ELECTRONICS CORPORATION**

Sharp Plaza, Mahwah, New Jersey 07430-2135

**SHARP CORPORATION**

Printed on post-consumer recycled paper.  
Imprimé sur du papier recyclé.  
Impreso en papel reciclado.  
Impresso em papel reciclado pós utilização.

Printed in Japan  
Imprimé au Japon  
Impreso no Japão  
TINS-A237WJZZ  
02P04-JKG