

Electric Ranges



Owner's Guide

CONTENTS

GENERAL INFORMATION..... 3-22

Avoid Service Checklist 23-26

the *LOOK* of better performance



Product Registration

Register Your Product

The **PRODUCT REGISTRATION CARD** should be filled in completely, signed and returned to Frigidaire Company.

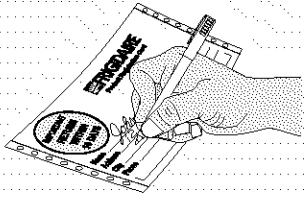

Thank you for choosing this appliance. The information contained within this **Owner's Guide** will instruct you on how to properly operate and care for your range. Please read through the information contained in your literature pack to learn more about your new appliance.

This Owner's Guide contains general operating instructions for your range and feature information for several models. Your range **may not** have all the described features.

Note: The instructions appearing in this Owner's Guide are not meant to cover every possible condition and situation that may occur. Common sense and caution must be practiced when installing, operating and maintaining any appliance.

Versión en español

Si desea obtener una copia en español de este Manual del Usuario, sírvase escribir a la dirección que se incluye a continuación. Solicite la P/N 318201146.

Spanish Owner's Guides
Frigidaire Company
P.O. Box 9061
Dublin, Ohio 43017-0961

General Information

	Page
IMPORTANT SAFETY INSTRUCTIONS	4-5
INSTALLATION INSTRUCTIONS	6-7
OVEN LIGHT	7
SURFACE LIGHT	7
CIRCUIT PROTECTION	8
SELECTING SURFACE COOKING UTENSILS	8
SETTING SURFACE CONTROLS	8
CONVECTION ROASTING	9
AIR CIRCULATION IN THE OVEN	9
CONVECTION COOKING	9
INDICATOR LIGHT	10
OVEN BAKING	10
BROILING	11
OVEN SETTINGS	11
CERAMIC GLASS COOKTOP	12
Types of heating units used	12
Hot surface indicator light	13
Setting Warm Zone Controls	13
Special caution for aluminum foil and aluminum cooking utensils	14
Things to remember	14
Use and care of glass surface	14-15
CLEANING THE APPLIANCE	16-19
TO REMOVE AND REPLACE THE OVEN DOOR	19
REMOVABLE OUTER DOOR GLASS PANEL	20
TO REMOVE/REPLACE STORAGE DRAWER	20
NOTES	21-22

SOME MODELS

PLEASE DO THIS NOW!

The **PRODUCT REGISTRATION CARD** should be filled in completely, signed, and returned. This information will register your product and help us to serve you quickly in the future if the occasion should demand.

Record the model and serial numbers of this appliance in the space provided below. These numbers are shown on the serial plate located at the right of the range frame and are visible when the drawer is open.

Model No.:

Serial No.:

Date Purchased:

Record these numbers for future reference.

IMPORTANT

Keep a copy of your bill of sale. The date on the bill establishes the warranty period should service be required. Place it where it can be easily retrieved. If service is performed, while the appliance is under warranty you may have to show your bill of sale.

IMPORTANT SAFETY INSTRUCTIONS

Read all instructions before using this appliance.
Save these instructions for future reference.

This guide contains important safety symbols and instructions. Please pay special attention to these symbols and follow all instructions given. Here is a brief explanation of these symbols.

⚠️WARNING This symbol will help you to situations that may cause serious bodily harm, death or property damage.

⚠️CAUTION This symbol will help you to situations that may cause bodily injury or property damage.

- **Remove all tape and packaging wrap before using the range. Destroy the carton and plastic bags after unpacking the range.** Never allow children to play with packaging material.
- **Proper Installation — Be sure your appliance is properly installed and grounded by a qualified technician in accordance with the National Electrical Code ANSI/NFPA No. 70 — latest edition and local code requirements.** Install only per installation instructions provided in the literature package for this range.

Ask your dealer to recommend a qualified technician and an authorized repair service. Know how to disconnect the electrical power to the range at the circuit breaker or fuse box in case of an emergency.

- **User Servicing — Do not repair or replace any part of the appliance unless specifically recommended in the manuals.** All other servicing should be done only by a qualified technician to reduce the risk of personal injury and damage to the range.
- **Never modify or alter the construction of a range by removing panels, wire covers or any other part of the product.**

⚠️WARNING Stepping, leaning or sitting on the door or drawer of this range can result in serious injuries and may also cause damage to the range. Do not allow children to climb or play around the range. The weight of a child on an open door may cause the range to tip, resulting in serious burns or other injury.

⚠️WARNING Do not use the oven for storage.

- **Storage in or on Appliance — Flammable materials should not be stored in an oven, near surface units or in the storage drawer.** This includes paper, plastic and cloth items, such as cookbooks, plasticware and towels, as well as flammable liquids. Do not store explosives, such as aerosol cans, on or near the range. Flammable materials may explode and result in fire or property damage.

⚠️CAUTION Do not store items of interest to children in the cabinets above a range or on the backguard of a range.

- **Do not leave children alone. Children should not be left alone or unattended in the area where an appliance is in use.** They should never be allowed to sit or stand on any part of the appliance.

- **DO NOT TOUCH SURFACE UNITS, AREAS NEAR THESE UNITS, OVEN HEATING ELEMENTS OR INTERIOR SURFACES OF THE OVEN.** Both surface units and oven heating elements may be hot even though they are dark in color. Areas near surface units may become hot enough to cause burns. During and after use, do not touch, or let clothing or other flammable materials touch these areas until they have had sufficient time to cool. Among these areas are the cooktop, surfaces facing the cooktop, the oven vent openings and surfaces near these openings, oven door and window.

- **Wear Proper Apparel — Loose-fitting or hanging garments should never be worn while using the appliance.** Do not let clothing or other flammable materials contact hot surfaces.

⚠️WARNING Never use your appliance for warming or heating the room.

- **Do Not Use Water or Flour on Grease Fires — Smother the fire with a pan lid, or use baking soda, a dry chemical or foam-type extinguisher.**
- **When heating fat or grease, watch it closely.** Fat or grease may catch fire if allowed to become too hot.
- **Use Only Dry Pot holders — Moist or damp pot holders on hot surfaces may result in burns from steam.** Do not let the pot holders touch hot heating surface units or interior oven elements. Do not use a towel or other bulky cloth instead of a pot holder.
- **Do Not Heat Unopened Food Containers — Build-up of pressure may cause the container to burst and result in injury.**
- **Remove the oven door from any unused range if it is to be stored or discarded.**
- **IMPORTANT — Do not attempt to operate the oven during a power failure. If the power fails, always turn the oven off.** If the oven is not turned off and the power resumes, the oven will begin to operate again. Food left unattended could catch fire or spoil.

⚠️CAUTION Electronic controllers can be damaged by cold temperatures. When you use your range for the first time, or if it has not been used for a long period of time, make sure that it has been exposed to a temperature above 32°F/0°C for at least 3 hours before connecting it to the power supply.

IMPORTANT SAFETY INSTRUCTIONS (continued)

IMPORTANT INSTRUCTIONS FOR USING YOUR COOKTOP

- **Know which knob controls each surface heating unit.**
- **Use Proper Pan Size** — This appliance is equipped with one or more surface units of different sizes. Select utensils having flat bottoms large enough to cover the surface unit. The use of undersized utensils will expose a portion of the surface heating unit to direct contact and may result in ignition of clothing. Proper relationship of utensil to the surface unit will also improve efficiency.
- **Utensil Handles Should Be Turned Inward and Should Not Extend Over Adjacent Surface Units** — To reduce the risk of burns, ignition of flammable materials, and spillage due to unintentional contact with the utensil.
- **Never Leave Surface Units Unattended** — Boilovers cause smoking and greasy spillovers that may ignite, or a pan that has boiled dry may melt.
- **Protective Liners** — Do not use aluminum foil to line oven bottom or any other part of the range. Only use aluminum foil as recommended for baking if used as a cover placed on the food. Any other use of protective liners or aluminum foil may result in a risk of electric shock or fire or a short circuit.
- **Glazed Cooking Utensils** — Only certain types of glass, glass/ceramic, ceramic, earthenware, or other glazed utensils are suitable for range top service without breaking due to the sudden change in temperature. Check the manufacturer's recommendations for range top use.

FOR GLASS COOKTOPS ONLY

- **Do Not Cook on Broken Cooktop** — If cooktop should break, cleaning solutions and spillovers may penetrate the broken cooktop and create a risk of electric shock. Contact a qualified technician immediately.
- **Clean cooktop with Caution** — If a wet sponge or cloth is used to wipe spills on a hot cooking area, be careful to avoid a steam burn. Some cleaners can produce harmful fumes if applied to a hot surface.

IMPORTANT INSTRUCTIONS FOR USING YOUR OVEN

- **Use Care When Opening Door** — Stand to the side of the range when opening the door of a hot oven. Let hot air or steam escape before you remove or replace food in the oven.
- **Keep Oven Vent Ducts Unobstructed.** The oven is vented between the cooktop and the backguard. Touching the surfaces in this area when the oven is operating may cause severe burns. Also, do not place plastic or heat-sensitive items on or near the oven vent. These items could melt or ignite.

- **Placement of Oven Racks.** Always place oven racks in desired location while oven is cool. Remove all utensils from the rack before removing rack. If rack must be moved while oven is hot, use extreme caution. Use pot holders and grasp the rack with both hands to reposition. Do not let pot holders contact the hot oven element or interior of the oven.
- **Do not use the broiler pan without its insert.** The broiler pan and grid allow dripping fat to drain and be kept away from the high heat of the broiler.
- **Do not cover the broiler grid with aluminum foil.** Exposed fat and grease could ignite.
- **Do not touch a hot light bulb with a damp cloth.** Doing so could cause the bulb to break. Disconnect the range or turn off the power to the range before removing and replacing light bulb.

IMPORTANT INSTRUCTIONS FOR CLEANING YOUR RANGE

- **Clean the range regularly to keep all parts free of grease that could catch fire.** Exhaust fan ventilation hoods and grease filters should be kept clean. Do not allow grease to accumulate on hood or filter. Greasy deposits in the fan could catch fire. When flaming food under the hood, turn the fan on. Refer to the hood manufacturer's instructions for cleaning.
- **Cleaners/Aerosols** — Always follow the manufacturer's recommended directions for use. Be aware that excess residue from cleaners and aerosols may ignite causing damage and/or injury.

SELF-CLEANING OVENS:

- **Clean in the self-cleaning cycle only the parts of the oven listed in this owner's guide.** Before self-cleaning the oven, remove the broiler pan and any utensils stored in the oven.
- **Do not clean the oven door gasket.** Care should be taken not to rub, damage or move the gasket.
- **Do not use oven cleaners.** No oven cleaner or oven liner protective coating of any kind should be used in or around any part of the oven.
- **Remove oven racks.** Oven racks color will change if left in the oven during a self-cleaning cycle.

SAVE THESE INSTRUCTIONS

Installation Instructions

INSTALLATION AND SERVICE MUST BE PERFORMED BY A QUALIFIED TECHNICIAN.

IMPORTANT: SAVE FOR THE LOCAL ELECTRICAL INSPECTOR'S USE. READ AND SAVE THESE INSTRUCTIONS FOR FUTURE REFERENCE.

Clearances and Dimensions

- Provide adequate clearances between the range and adjacent combustible surface (1/2" (1.3 cm)) to the cabinet side walls and the rear wall).
- Location—Check location where the range will be installed. Check for proper electrical supply and the stability of floor.
- Dimensions that are shown must be used. Given dimensions provide minimum clearance. Contact surface must be solid and level.

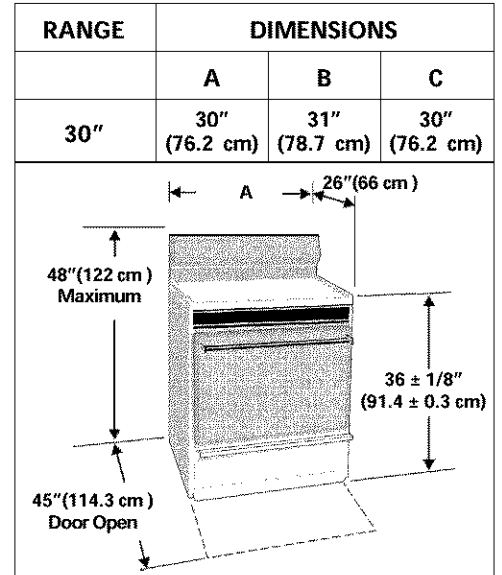
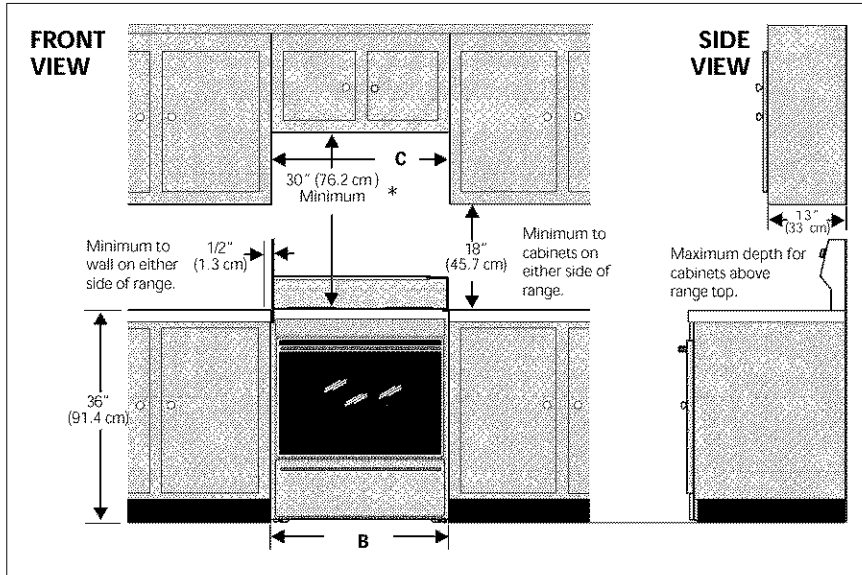

* 30" (76.2cm) MINIMUM CLEARANCE BETWEEN THE TOP OF THE COOKING SURFACE AND THE BOTTOM OF AN UNPROTECTED WOOD OR METAL CABINET; OR 24" (61cm) MINIMUM WHEN BOTTOM OF WOOD OR METAL CABINET IS PROTECTED BY NOT LESS THAN 1/4" (0.64cm) FLAME RETARDANT MILLBOARD COVERED WITH NOT LESS THAN 0.015" (0.038cm) STAINLESS STEEL, 0.024" (0.061cm) ALUMINUM OR 0.020" (0.051cm) COPPER. 1/2" (1.3cm) CLEARANCE IS THE MINIMUM FOR THE REAR AND SIDES OF THE RANGE. FOLLOW ALL DIMENSION REQUIREMENTS PROVIDED ABOVE TO PREVENT PROPERTY DAMAGE, POTENTIAL FIRE HAZARD, AND INCORRECT COUNTER TOP AND CABINET CUTS.

TO ELIMINATE THE RISK OF BURNS OR FIRE BY REACHING OVER HEATED SURFACE UNITS, CABINET STORAGE SPACE LOCATED ABOVE THE SURFACE UNITS SHOULD BE AVOIDED. IF CABINET STORAGE IS TO BE PROVIDED, THE RISK CAN BE REDUCED BY INSTALLING A RANGE HOOD THAT PROJECTS HORIZONTALLY A MINIMUM OF 5" (12.7cm) BEYOND THE BOTTOM OF THE CABINETS.

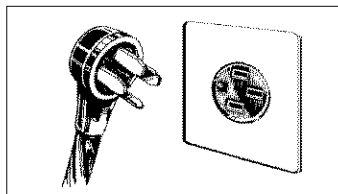

Electrical Hook-Up

This appliance must be connected to a grounded 120/240 volt or 120/208 volt Range outlet. If no outlet is available, have one installed by a qualified electrician.

Location

Set your new range 1/2" (1.3 cm) away from the rear wall and line it up with the kitchen counters. Make sure there is at least 1/2" (1.3 cm) of clearance between each side of the range and the kitchen counters. Allow 3" (7.6 cm) min. clearance between your range and the refrigerator, if they are side by side.

Leveling

For good baking results, your range should be level. Screw type leveling legs are provided at each corner of the range at the base. Remove the storage drawer to adjust the leveling legs. (Refer to Storage Drawer section).

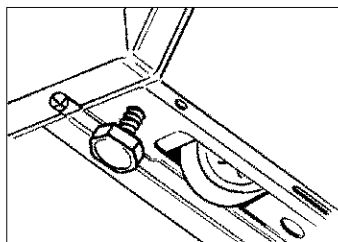

Installation Instructions (continued)

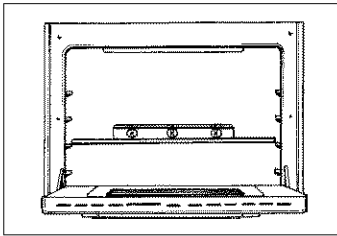

To level the range:

1. Use a 1-1/4" open end key or an adjustable wrench to equally unscrew the four leveling legs two to three turns each.
2. Install an oven rack in the center of the oven.
3. Move the range to its final position, then put a spirit level on the rack to check for levelness. Take two readings, one with the level placed diagonally first in one direction, and then the other.
4. Use the 1-1/4" key or wrench to adjust the leveling legs. Turn each one until the range stands firm without wobbling.
5. Some models are supported by smooth glide rollers to facilitate moving.

If floor is flat and level, open the drawer and lower the front roller locking levers (some models) to prevent the range from moving.

If floor is not flat or level or if this model has rollers without locking levers, use the 4 leveling legs to level, support and prevent the range from moving.

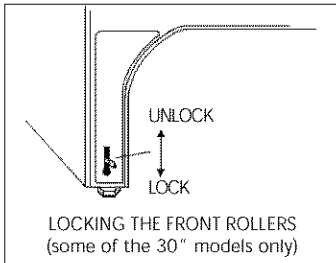

Oven Light



Do not turn the oven light on during the self-cleaning cycle. High temperature will reduce lamp life.

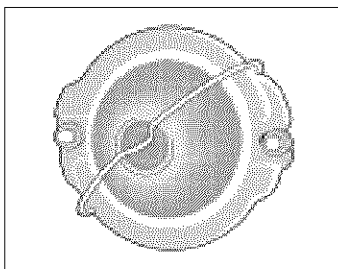

On some models an interior oven light will turn on automatically when the oven door is opened.

The oven light may be turned on when the door is closed by using the oven light switch located on or underneath the control panel.

On a self clean oven the lamp is covered with a glass shield held in place by a wire holder.

THIS GLASS SHIELD MUST BE IN PLACE WHENEVER THE OVEN IS IN USE.

To replace the light bulb:

CAUTION: BE SURE OVEN IS COOL.

1. Turn the power off at the main source.
2. Wear a leather-faced glove for protection against possible broken glass.
3. Replace bulb with a 40 watt appliance bulb only.
4. For self-cleaning oven, press wire holder to one side to release glass shield, change bulb and be sure to replace glass shield.

Surface Light

(some models)



BE SURE ALL SURFACE ELEMENT CONTROL KNOBS ARE TURNED TO OFF "O" AND ELEMENTS ARE COOL.

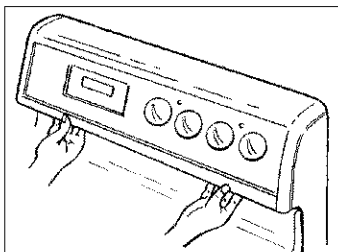

Use switch located on or underneath the control panel to turn the surface light ON/OFF.

Replace the surface light, if after repeated attempts to turn it on you are not successful.

SURFACE LIGHT REPLACEMENT (some models)

To remove and replace the fluorescent light:

1. Place your fingers under the tube at approx. 8" (20.3 cm) from each end.
2. To remove, turn the tube 90° then pull it down and out of its sockets.
3. To replace the tube, engage the new tube into the sockets, then rotate and snap the tube in place. Turn on the surface light to make sure it will lit.

Circuit Protection

As a protection against surcharge, a 15 amp, 120 volt fuse is provided for each of the electric outlet(s) (2 max.) located on top of the control panel. To access the fuse(s) raise the control panel cover. Models with no electric outlet have no fuse.

Selecting Surface Cooking Utensils

For best results and energy conservation, choose cooking utensils that have these characteristics:

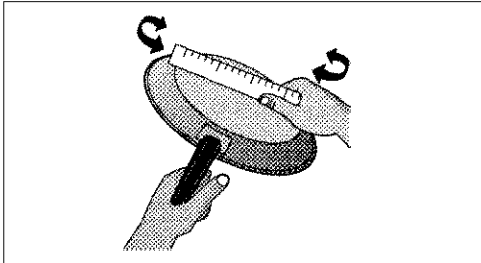

Pans should have flat bottoms that make good contact with the entire surface element. Check for flatness by rotating a ruler across the bottom. There should be no gaps between the pan and ruler.

Note: Always use a utensil for its intended purpose. Follow manufacturer's instructions. Some utensils were not made to be used in the oven or on the cooktop.

***GOOD**

- Flat bottom and straight sides.
- Tight fitting lids.
- Weight of handle does not tilt pan. Pan is well balanced.
- Pan sizes match the amount of food to be prepared and the size of the surface element.
- Made of material that conducts heat well.
- Easy to clean.

* Specialty pans such as lobster pots, griddles and pressure cookers may be used but must conform to the above recommended cookware requirements.

POOR

- Curved and warped pan bottoms.
- Pan overhangs unit by more than 2.5 cm (1").
- Heavy handle tilts pan.
- Pan is smaller than element.

Setting Surface Controls

NOTE: Control knob shown is typical only.

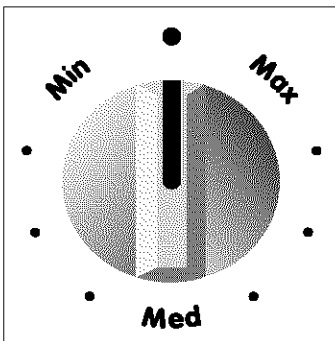

1. Place the pan on the surface element.
2. Push in and turn the surface element control knob to desired setting.
3. The surface signal light will glow when one or more elements are turned on. Always turn the element off before removing the pan.

The suggested settings found in the chart below are based on cooking in medium-weight aluminum pans with lids. Settings may vary when using other types of pans.

Note: The size and type of utensil used, and the amount and type of food being cooked will influence the setting needed for best cooking results.

CAUTION Do not place plastic items such as salt and pepper shakers, spoon holders or plastic wrappings on top of the cooktop when it is in use. These items could melt or ignite. Pot holders, towels or wood spoons could catch fire if placed too close to the element.

AUTOMATIC LOCK OFF OF THE SURFACE ELEMENTS (30" models with a self-cleaning oven only)

During the self-clean cycle, the surface elements, when used, are subjected to high heat. To ensure maximum element life, a safeguard locks off the use of the surface elements during the self-clean cycle. Once the oven cleaning cycle is complete and the oven door can be opened, the surface elements can be utilized.

Setting	Type of Cooking
MAX	Start most foods, bring water to a boil, pan broiling.
MEDIUM	Maintain a slow boil, thicken sauces and gravies, steam vegetables.
MEDIUM LOW	Keep foods cooking, poach, stew.
MIN	Keep warm, melt, simmer.

Roasting in Speed Bake mode (some models)

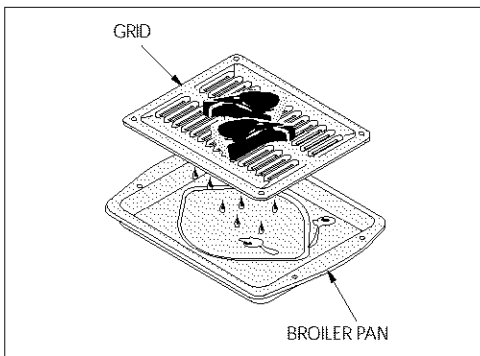

When roasting in Speed Bake mode use the broiler pan and grid. The broiler pan will catch grease spills and the grid will help prevent grease splatters.

1. Place oven rack on bottom or next-bottom rack position.
2. Place the grid in the broiler pan. DO NOT use the broiler pan without the grid; do not cover the grid with aluminum foil.

Air Circulation in the Oven

For good air circulation in the oven and best baking results, center pans as much as possible. Allow 2" to 4" (5.1 to 10.2 cm) around the utensil(s) for proper air circulation and be sure pans do not touch each other, the door, sides or back of oven. The hot air must circulate around the pans for even heat to reach all parts of the oven.

If using multiple pans, stagger as shown. If using one pan, place in center of oven.

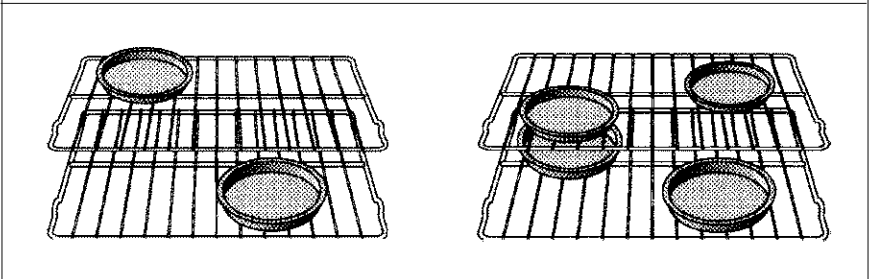

Speed Bake Cooking System (some models)

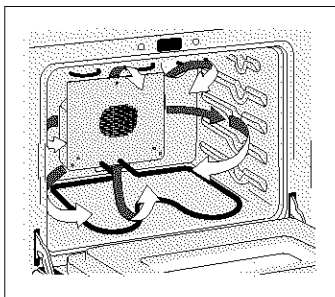

The Speed Bake mode uses a fan located in the rear wall of the oven to circulate heated air around the food to be cooked. The controlled air flow pattern quickly seals the food surface retaining the natural juices and flavor. This method of cooking enables you to obtain the best culinary results when baking, thawing, dehydrating and roasting foods.

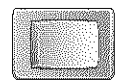

The **Speed Bake Switch** on the control panel turns the speed bake function on/off. The pilot light is on when the oven fan is in operation.

Pilot light

NOTE: The fan motor automatically turns off when the oven door is opened while oven is in speed bake mode and resumes when the door is closed again.

Speed Bake notes:

1. When using Speed Bake mode most recipes can be achieved by reducing cooking times. (See table Cooking Guide for Speed Bake Cooking System).
2. Multiple pan cooking is improved when Speed Bake mode is used.
3. Defrosting is quicker in Speed Bake mode when compared to regular radiant cooking.
4. Preheating the oven is not necessary when using Speed Bake mode except when baking breads, cakes, biscuits etc.

Cooking Guide for Speed Bake Cooking System	
Food	Cooking Time Reduction
Meats	15% (or 5 mins/lb)
Poultry	30% (or 10 mins/lb)
Frozen Foods	20%
Biscuits	30%
Baked Potatoes	30%
Pies	30%

Indicator Light

Some models have an indicator light for each heating unit, other models have an indicator light for each pair of heating units.

The indicator light glows as soon as a heating unit is turned on. Check if the indicator light glows when the control knob of the individual heating unit is turned on. If the knob is set to a very low temperature setting, the indicator may glow and yet, the heating unit may not be heating at all. If this happens, turn the knob to a higher setting until the heating unit comes on.

When cooking is finished, a quick glance at the indicator lights is an easy check to be sure all the control knobs have been turned to **OFF** "●".

Oven Baking

For best cooking results, heat the oven before baking cookies, breads, cakes, pies or pastries, etc... There is no need to preheat the oven for roasting meat or baking casseroles.

The cooking times and temperatures needed to bake a product may vary slightly from your previously owned appliance.

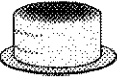
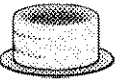
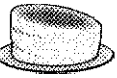
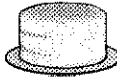
Baking Problems and Solutions Chart		
Baking Problems	Causes	Corrections
<p>Cookies and biscuits burn on the bottom.</p> 	<ul style="list-style-type: none"> • Cookies and biscuits put into the oven before the preheating time is completed. • Oven rack overcrowded. • Dark pan absorbs heat too fast. 	<ul style="list-style-type: none"> • Allow oven to preheat to the selected temperature before placing food in oven. • Choose pan sizes that will permit 2" to 4" (5.1 cm to 10.2 cm) of air space on all sides when placed in the oven. • Use a medium-weight aluminum baking sheet.
<p>Cakes too dark on top or bottom.</p> 	<ul style="list-style-type: none"> • Cakes put into the oven before preheating time is completed. • Rack position too high or low. • Oven too hot. 	<ul style="list-style-type: none"> • Allow oven to preheat to the selected temperature before placing food in the oven. • Use proper rack position for baking needs. • Set oven temperature 25°F/12°C lower than recommended.
<p>Cakes not done in the center.</p> 	<ul style="list-style-type: none"> • Oven too hot. • Incorrect pan size. • Pan not centered in oven. 	<ul style="list-style-type: none"> • Set oven temperature 25°F/12°C lower than recommended. • Use pan size suggested in recipe. • Use proper rack position and place pan so there is 2" to 4" (5.1 cm to 10.2 cm) of space on all sides of pan.
<p>Cakes not level.</p> 	<ul style="list-style-type: none"> • Range not level. • Pan too close to oven wall or rack overcrowded. • Pan warped. 	<ul style="list-style-type: none"> • Place a marked glass measuring cup filled with water on the center of the oven rack. If the water level is uneven, refer to the installation instructions for leveling the range. • Be sure to allow 2" to 4" (5.1 cm to 10.2 cm) of clearance on all sides of each pan in the oven. • Do not use pans that are dented or warped.
<p>Foods not done when cooking time is up.</p> 	<ul style="list-style-type: none"> • Oven too cool. • Oven overcrowded. • Oven door opened too frequently. 	<ul style="list-style-type: none"> • Set oven temperature 25°F/12°C higher than suggested and bake for the recommended time. • Be sure to remove all pans from the oven except the ones to be used for baking. • Open oven door only after shortest recommended baking time.

Broiling

Broiling is a method of cooking tender cuts of meat by direct heat under the broil element of the oven.

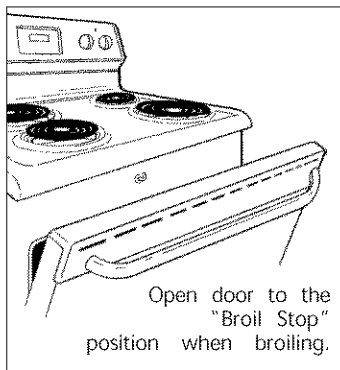

Preheating

Preheating is suggested when searing rare steaks. (Remove the broiler pan before preheating. Foods will stick if placed on hot metal.) To preheat, set the oven control(s) to BROIL as instructed in the Owner's Guide. Wait for the element to become red-hot, usually about 2 minutes. Preheating is not necessary when broiling meats well-done.

To Broil

Broil on one side until the food is browned; turn and cook on the second side. Season and serve. Always pull rack out to the "stop" position before turning or removing food.

Determining Broiling Times

Broiling times vary, so watch the food closely. Time not only depends on the distance from the element, but on the thickness and aging of meat, fat content and doneness preferred. The first side usually requires a few minutes longer than the second. Frozen meats also require additional time.

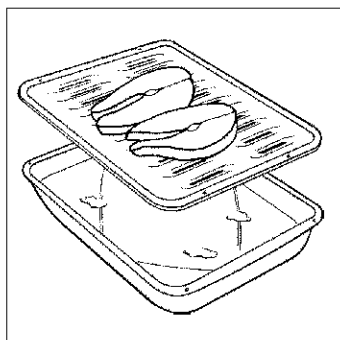

Broiling Tips

The broiler pan and its grid allow dripping grease to drain and be kept away from the high heat of the broiler.

Always pull oven rack out to the "stop" position before turning or removing food.

DO NOT use the pan without its grid. DO NOT cover the grid with foil. The exposed grease could ignite.

CAUTION Should an oven fire occur, close the oven door and turn off the oven. If the fire continues, throw baking soda on the fire or use a fire extinguisher. **DO NOT** put water or flour on the fire. Flour may be explosive.

Storing Broiler Pan & Grids

Set broiler pan and grid on the supports and slide back.

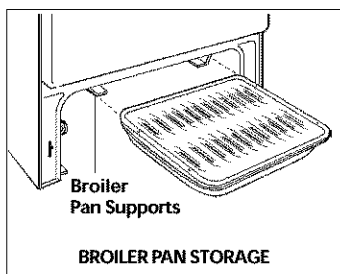

Broiler Clean-Up Tips:

- To make cleaning easier, line the bottom of the broiler pan with aluminum foil. **DO NOT** cover the broiler grid with foil.
- To prevent grease from baking on, remove the broiler pan from the oven as soon as cooking is completed. Use hot pads because the broiler pan is extremely hot. Pour off grease. Soak the pan in HOT, soapy water.
- Clean the broiler pan as soon as possible after each use. If necessary, use soap-filled steel wool pads. Heavy scouring may scratch the grid.

Oven Settings

For oven settings, refer to the timer section or the electronic oven control.

Ceramic Glass Cooktop (some models)

The ceramic-glass cooktop has electric heating coils located below the ceramic glass surface. The design of the glass cooktop outlines the area of the surface heating unit below. Most importantly, make sure the diameter of the pan matches the diameter of the surface unit. Heat is transferred up through the surface of the cooktop. Only flat-bottomed pans should be used. The type and size of the cookware, number of surface units in use and the settings of the surface units are factors that will affect the amount of heat that will spread to areas surrounding the units. The areas surrounding the units may become hot enough to cause burns.

The cooktop should not be used as a cutting board or work surface. Dropping heavy or hard objects on the cooktop may crack it. Pans with rough bottoms may scratch the cooktop surface. Placing foods directly on the smoothtop surface (without cooking utensils) is not recommended as difficult cleaning will result and foods may smoke and cause a potential fire hazard. Never use the griddle or similar cooking sheet on the ceramic glass cooktop.

TYPES OF HEATING UNITS USED

Depending on model, two types of heating units may be found under the ceramic glass cooktop:

- regular (single coil) radiant elements of various diameters or shapes, plus expandable type (double coils) radiant elements of various diameters or shapes.
- halogen elements of various diameters or shapes.

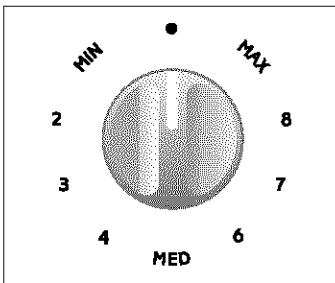

REGULAR RADIANT HEATING UNITS (some models)

The ceramic glass design shows the location of the heating surfaces.

Control knobs are used to set the heat power levels; knobs need first to be pressed in when at OFF position, then turned to the desired heat settings.

A glowing red surface unit extending beyond the bottom edge of the cooking utensil indicates the utensil is too small for the unit. The control knob does not have to be set exactly on a particular mark. Use the marks as a guide and adjust the control knob as needed. The hot surface and surface indicator lights will glow.

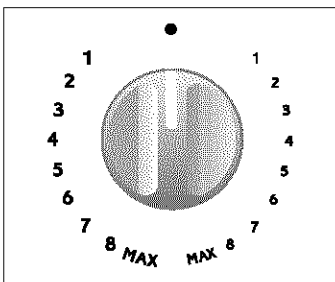

EXPANDABLE RADIANT HEATING UNITS (some models)

This heating unit combines the characteristics of a small and a large regular radiant heating unit. Its principal advantage is to allow small and large utensils to be used on the same heating unit, therefore increasing the cooktop flexibility.

Heat power levels are adjusted by a special control knob that has a dual set of graduations; for small utensils use the small graduations; the inner surface only will be heating. For larger utensils use the larger graduations; the whole surface will be heating.

The hot surface and surface indicator lights will glow when the heating unit is turned ON.

HALOGEN HEATING UNITS (some models)

The halogen element is similar to the radiant element with the addition of a halogen lamp to the heating coil. The lamp immediately heats up and glows bright red when the element is turned on. Cook time is improved.

10-Step Halogen Element (some models)

The control for this type of element can be set in 10 different heating positions. Each position causes the element to operate continuously at a fixed power output "MIN or LOW" is the lowest setting, "MAX or HI" is the highest.

Infinite Step Halogen Element (some models)

The control for this type of element can be set anywhere between positions "MIN or LOW" and "MAX or HI".

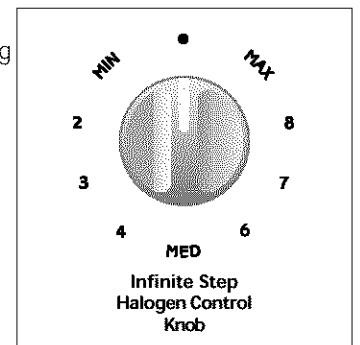
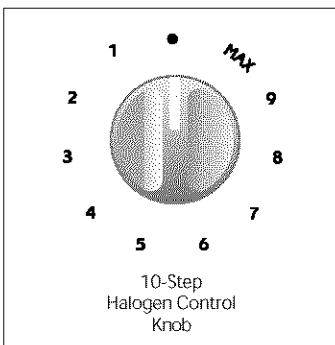

Ceramic Glass Cooktop (some models) (continued)

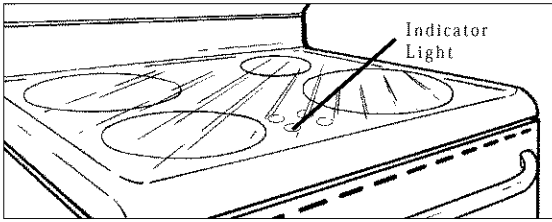

HOT SURFACE INDICATOR LIGHT (some models)

Some models have an indicator light located on the ceramic glass cooktop that glows as soon as the glass begins to warm up. When the heating unit is turned off, it will continue to glow as long as the glass remains warm enough to cause burns. Other models have 4 hot surface indicators (one per element) arranged in a cluster. Their location is as shown in the illustration above.

SETTING WARM ZONE CONTROLS (some models)

To Operate the Warm Zone

Your range is equipped with a warm zone. The purpose of the warm zone is to keep hot cooked foods at serving temperature. Always start with hot food. It is not recommended to heat cold food on the warm zone.

Use the warm zone to keep cooked foods hot such as: vegetables, gravies, casseroles, soups, stews, breads, pastries and oven-safe dinner.

All food placed on the warm zone should be covered with a lid or aluminum foil to maintain quality. For best results, when warming pastries or breads, the cover should have an opening to allow moisture to escape. **Do not use plastic wrap to cover food. Plastic may melt onto the surface and be very difficult to clean.**

Use only dishware, utensils and cookware recommended for oven and cooktop use on the warm zone.

CAUTION Unlike the surface elements, the warm zone will not glow red when it is hot.

CAUTION Always use potholders or oven mitts when removing food from the warm zone as cookware and plates will be hot.

Indicator Lights

The **surface indicator light** is located below the warm zone control. It turns on when the control is set, and stays on until the control is turned off. The **hot surface indicator light**, located under the glass cooktop, will come on when the control is set and will continue to glow until the glass cooktop has cooled down to a moderate level.

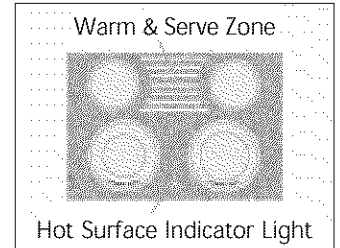

To Set the Warm Zone Control

1. To set the control, push in and turn the knob. The temperatures are approximate, and are designated by HI, MED and LO. However, the control can be set at any position between HI and LO for different levels of heating.
2. When done, turn the control to OFF. The warm zone will remain warm until the **hot surface indicator light** goes off.

Temperature Selection

Refer to the chart for recommended heating levels. If a particular food is not listed, start with the medium level, and adjust as needed. Most foods can be kept at serving temperatures by using the medium level.

Warm Zone Recommended Food Settings Chart

Food Item	Heating Level
Breads/Pastries	LO
Casseroles	LO
Dinner Plates with Food	LO
Eggs	LO
Gravies	LO
Meats	MED
Sauces	MED
Soups (cream)	MED
Stews	MED
Vegetables	MED
Fried Foods	HI
Hot Beverages	HI
Soups (liquid)	HI

Ceramic Glass Cooktop (some models) (continued)

SPECIAL CAUTION FOR ALUMINUM FOIL AND ALUMINUM COOKING UTENSILS

1) Aluminum foil

Use of aluminum foil will damage the cooktop. Do not use under any circumstances.

2) Aluminum utensils

The melting point of aluminum being much lower than that of other metals, care must be taken when aluminum pots or pans are used. If allowed to boil dry, not only will the utensil be ruined, but also permanent damage in the form of breakage, fusing or marking may affect the ceramic glass surface.

THINGS TO REMEMBER

1. AVOID using bleach and don't use ammonia to clean the ceramic surface.
2. Do not put plastic items on warm cooking areas.
3. Never slide oven racks across cooktop surface. They may scratch or metalmark the cooktop.
4. **If cooktop should break, do not use cooktop or attempt to clean it. Call your authorized service technician immediately.**
5. Never use a trivet or metal stand between the cooking utensil and the ceramic cooktop. The ceramic surface may be scratched, metal marked or etched by such items.
6. Sugary spills can cause pitting of your cooktop surface. Therefore, you must begin cleaning the spills while the cooktop is still hot. Use caution when following the steps below.
 - a) Turn off all surface units and remove all pans immediately.
 - b) Wearing an oven mitt, use a razor blade scraper to scrape the hot spill out of the cooking zone to a cooler area on the cooktop.
 - c) Allow the cooktop to cool.

USE AND CARE OF GLASS SURFACE

Problem	Cause	To Prevent	To Remove
Fine "brown lines" (tiny scratches or abrasions which have collected soil)	Coarse particles (salt, sand, sugar or grit) between bottom of cookware and cooktop that are not removed before cooking. Using incorrect cleaning materials.	Clean cooktop after every use. Daily use of cleaner cream.	Tiny scratches are not removable. They can be minimized by continual use of cleaner cream. Such scratches do not affect cooking.
Metal marking (mark or black marks).	Sliding or scraping metal utensils or oven shelves across cooktop.	Do not slide cookware across cooktop.	Apply cleaner cream with dampened paper towel to a cooled surface.
Brown streaks and specks.	Cleaning with a sponge or dishcloth that has been used for other kitchen tasks.	Use cleaner cream with clean, damp paper towel.	Use a small amount of cleaner cream with clean, damp paper towel.

NOTE: Due to the high intensity of heat generated by the surface elements, the glass surface will turn green when the element will be turned off. This phenomenon is normal and the glass will come back to its original white color after it has completely cooled down. (White glass cooktops only).

Ceramic Glass Cooktop (some models) (continued)

USE AND CARE OF GLASS SURFACE (continued)

CLEANING MATERIALS FOR CERAMIC GLASS COOKTOP

Some cleaning materials may contain an ingredient which can damage the cooktop. Use recommended materials only (see below). Cleaner cream should be used regularly. First use recommended products listed below, then use cleaner cream.

Use only recommended cleaning products and follow these basic cleaning suggestions.

1. BEFORE THE COOKTOP IS USED. Thoroughly clean and saturate the cooktop with cleaner cream.
 - a) Dampen clean paper towel and clean unit.
 - b) Wipe off with another clean, damp paper towel; then wipe dry.
2. For normal daily cleaning, apply a dab of cleaner cream in the center of each unit-area to be cleaned. Start with approximately 1/8 teaspoon. (Apply more if needed). Then, proceed as stated above in (a and b).
3. Make sure bottom of cookware and cooking area are clean and dry.
4. Select heat settings and cookware large enough for food and liquid. This stops boilovers and spattering.
5. Wipe up food spills and spatters before they burn into surface.

IMPORTANT Regularly use cleaner cream. If you run out of cleaner cream, use one of the cleansers listed. Be sure to get a new supply of cleaner cream.

CAUTION Never mix cleaning products! Mixtures may interact, with damaging or hazardous results.

DO USE ON CERAMIC GLASS COOKTOP

1. Baking soda.
2. Non-impregnated plastic and nylon pads.
3. For burned on material, scrape with single-edged razor blade, held at a 30° angle.
4. Ceramic glass cleaning cream.

DO NOT USE ON CERAMIC GLASS COOKTOP

1. Avoid pads, that can leave marks and scratches.
2. Avoid heavy-duty cleansing powders, these can scratch, depending on their abrasiveness and cleaning pressure applied.
3. Avoid chemical oven cleaners. These can etch the cooktop surface and are caustic.
4. Avoid rust stain removers containing hydrofluoric acid.
5. Avoid using bleach and don't use ammonia.

SPECIAL CLEANING INSTRUCTIONS FOR MINERAL DEPOSITS AND DISCOLORATIONS

Problem: A gray brown stain that is not removed when using cleaner cream.

Cause: Condensation, when cooking, often collects and drips from cookware. The minerals found in water supply and foods may cause a gray or brown film to develop on cooktop. This film is so thin it cannot be felt and appears to be under cooktop.

To Prevent: Daily and proper use of cleaner cream.

To Remove:

- Wet surface with water and sprinkle on cleaner cream.
- Scrub with clean, damp paper towel until stain disappears.
- Clean remaining paste away with damp paper towel.
- Apply dab of cleaner creme and polish with a clean paper towel.

WARNING

- Do not use cleansers on a heated surface. Fumes could be hazardous. Wait for area to cool before cleaning.
- Do not use cleaner cream to clean porcelain, paint or aluminium.

Cleaning the Appliance

Before cleaning any part of the range, make sure all heating elements are turned to OFF "●" and are cool.

Exterior Cleaning

Clean range after each use to prevent sticky grease built-up and spills from cooking on. Wash with hot, soapy water and a clean cloth. Wipe with a soft cloth or paper towel.

Do not use abrasives, steel wool, cleaners containing ammonia, acids or commercial oven cleaners on any exterior parts of the range, except the porcelain enamel cooktop. If a metal cleaner or polish is used on metal trim, be sure the label specifies that it is safe for use on chrome and aluminium.

Control Panel

Control knobs (some models)

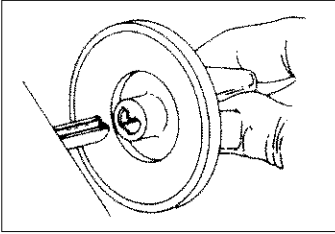

If the control panel needs cleaning turn the control knobs to OFF "●", then pull knobs straight off the shafts.

Most cleaning of your steel/aluminum control panel can be done using a clean cloth with warm soapy water or other mild household cleaners.

Sometimes, applying few drops of a recommended cooktop cleaning/polishing cream (with silicone) will remove any remaining soil and will leave a protective coating which will keep your range looking like new.

Cooktop cleaning/polishing cream can be purchased through authorized service centers or major department stores.

Models with glass panel:

Use a clean cloth or a sponge with warm, soapy water or paper towel and spray glass cleaner to clean the glass panel. Be careful not to let water/cleaner go behind the glass or near the knob activated controls.

Replace knobs; engage the flat surface inside the knob cavity with the flat on the shaft. Push knobs onto the shafts.

Coil Surface Elements (some models)

Prior to cleaning the coil elements make sure they are cold and that control knobs are turned to OFF "●".

Warning: Never leave covers on the coil elements as they could be permanently damaged if the coil is turned on by accident.

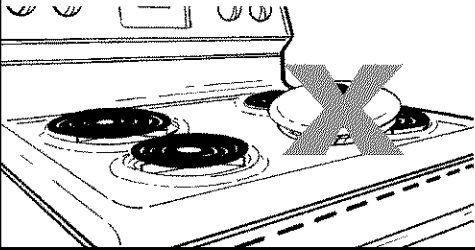

Coil Elements and Drip Bowls

Coil elements clean themselves when they are turned on.

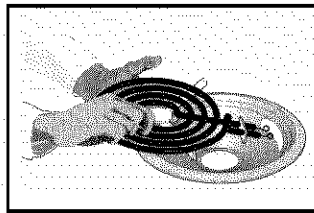

Coil elements and drip bowls are removable and allow to clean the drip bowls.

To remove a coil element, push against the front edge and lift element up and out.

To clean by hand, wash the drip bowls in hot sudsy water. For hard to remove spots, use a nylon scrubber with soap. Rinse and dry while still warm.

⚠ WARNING Never immerse coil elements in water.

SURFACES	CLEANING AGENTS	INSTRUCTIONS
Porcelain Enamel (Cooktop, Surface under cooktop)	Mild cleaners or soap-filled steel wool pads.	Use a damp sponge or dampened soap pad, rinse and dry.
Insert – Control panel	Hot, soapy water or cleaner cream.	Use a clean, soapy, dampened cloth or paper towel, remove soil and dry. Do not use abrasive products.

Cleaning the Appliance (continued)

Porcelain enamel cooktop cleaning instructions.

⚠WARNING DO NOT use a cooktop cleaner on a hot cooktop. The fumes can be hazardous to your health, and can chemically damage the cooking surface.

⚠CAUTION Before Cleaning the surface cooktop, be sure the controls are turned to OFF and the cooktop is cool.

⚠CAUTION DO NOT use commercial oven cleaners on the exterior surfaces including range top and door frame.

PORCELAIN ENAMEL COOKTOP CLEANING

Correct and consistent cleaning is essential to maintaining your porcelain enamel cooktop. If food spills and grease spatters are not removed, they may burn onto the surface of the cooktop and cause permanent discoloration.

DAILY CLEANING

For normal soil:

1. Allow cooktop surface to cool.
2. Wipe off spills and spatters using a clean paper towel or a clean cloth with warm, soapy water.
3. If needed, use a soapy steel wool pad or other mild household cleaners.
4. Be sure to rinse off the cleaners or the porcelain may become damaged during future heating.

For heavy, burned-on soil:

1. Allow cooktop surface to cool.
2. Use a soap filled scouring pad with warm water or cover heavily soiled spots with a solution of clear water and ammonia. Scour gently. Rinse and wipe dry with a clean cloth.
3. If any soil remains, apply a few drops of a recommended cooktop cleaning cream on the spots and rub gently using a clean damp cloth or scouring pad. Buff with a dry cloth until all soil and cream are removed. Frequent cleaning with the cooktop cleaning cream leaves a protective coating which helps in preventing scratches and abrasions.

For sugary spillovers:

Sugary spills can chemically damage your cooktop surface. Therefore, you must begin cleaning the spills while the cooktop is still hot. Use caution when following the steps below.

1. Turn off all surface units and remove all pans immediately.
2. Wearing an oven mitt, wipe up carefully or move hot spills away from the element area with a clean damp cloth.
3. Allow the cooktop to cool. Follow the instructions above for heavy, burned-on soil.

COOKTOP CLEANING/POLISHING CREAM can be purchased through authorized service centers or major department stores.

Cleaning the Appliance (continued)

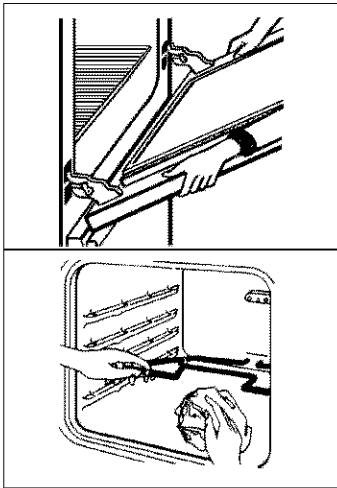

Cleaning the Regular Oven (Non self-clean oven)

Make sure the oven is cool and that all control knobs are at **OFF** "●" position. Cleaning the oven is a lot easier when the door is removed.

1. Remove the oven door.
2. Empty the oven including the racks.
3. You can wash the broiler pan, grid and racks in the kitchen sink.
4. Clean oven lining thoroughly with soap and a wet cloth and wipe with a dry cloth.

To remove burned-on fat on oven walls, moisten soiled parts with household ammonia, using a wet cloth. Follow suggested manufacturer's cleaning method. (Do not remove the oven door when using ammonia.)

Complete cleaning with a damp cloth and use a fine steel wool or scouring agent if necessary.

The lower element can be moved up for cleaning purposes.

5. Replace racks in the oven. Reinstall oven door.

Cleaning the Self-Clean Oven (some models)

Adhere to the following cleaning precautions:

- Allow the oven to cool before cleaning.
- Wear rubber gloves when cleaning any exterior parts of the oven manually.



During the self-cleaning cycle, the outside of the wall oven can become very hot to the touch. **DO NOT** leave small children unattended near the appliance.



The health of some birds is extremely sensitive to the fumes given off during the self-clean cycle of any range. Move birds to another well ventilated room.



Before cleaning any part of the oven, be sure the electronic oven control is turned off or else push **CANCEL** pad. Wait until the oven is cool.

DO NOT use commercial oven cleaners or oven protective coatings in or around any part of the self-cleaning oven. **DO NOT** clean the oven door gasket. The gasket on the oven door is essential for a good seal. Care should be taken not to rub, damage or move the gasket. **DO NOT** use any cleaning materials on the gasket. Doing so could damage it. **DO NOT** use aluminum foil to line the oven bottom. This may affect cooking or foil could melt and damage the oven surface.

A self-cleaning oven cleans itself with high temperatures (well above cooking temperatures) which eliminate soil completely or reduce it to a fine powdered ash you can whisk away with a damp cloth.

Preparing the Oven for Self-Cleaning

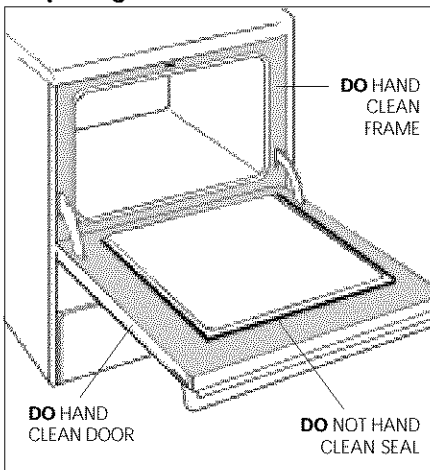

1. Remove any excess spillovers in the oven cavity before starting the self-cleaning cycle. To clean, use hot soapy water and a cloth. Large spillovers can cause heavy smoke or fire when subjected to high temperatures. **DO NOT** allow food spills with a high sugar or acid content (such as tomatoes, sauerkraut, fruit juices or pie filling) to remain on the surface as they may cause a dull spot even after cleaning.
2. Clean any soil from the oven frame and the door liner (see illustration). These areas heat sufficiently during a self-clean cycle to burn soil on. Clean with soap and water.
3. Remove the broiler pan and insert, all utensils and any foil. These items do not withstand high cleaning temperatures.
4. Oven racks may be left in the oven or may be removed. If they go through the clean cycle, their color will turn slightly dull. After the cycle is completed and the oven has cooled, rub the sides of the racks with wax paper or a cloth containing a small amount of baby oil or salad oil. This will make the racks glide easier.

Cleaning the Appliance

(Continued)

AUTOMATIC LOCK OFF OF THE SURFACE ELEMENTS

(30" models with a self-cleaning oven only)

During the self-clean cycle, the surface elements, when used, are subjected to high heat. To ensure maximum element life, a safeguard locks off the use of the surface elements during the self-clean cycle. Once the oven cleaning cycle is complete and the oven door can be opened, the surface elements can be utilized.

What to Expect During Cleaning

While the oven is in operation, the oven heats to temperatures much higher than those used in normal cooking. Sounds of metal expansion and contraction are normal. Odor is also normal as the food soil is being removed. Smoke may appear through the oven vent, located on the top of the control panel.

If heavy spillovers are not wiped up before cleaning, they may flame and cause more smoke and odor than usual. This is normal and safe and should not cause alarm. If available, use an exhaust fan during the self-cleaning cycle.

NOTE: A smoke eliminator in the oven vent converts most of the soil into a colorless vapor.

Setting the Controls for a Clean Cycle

For the setting of the clean cycle, refer to the section on the timer or Electronic oven control.

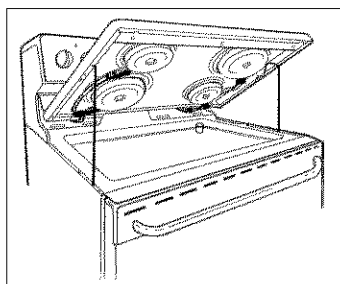

Upswept lift cooktop (some models)

On some models, the cooktop, when equipped with coil elements, can be raised to facilitate cleaning of the panel.

To raise the cooktop, grab the sides and lift from the front. Use the two sliding wire supports located on each side of the cooktop and pull them toward you, to the lock position, in order to maintain the cooktop in the raised position while cleaning the panel.



Lower the cooktop slowly; be careful not to pinch fingers. Do not let the cooktop fall freely, as this may damage the porcelain finish.

To Remove and Replace the Oven Door

1. Open the door fully.
2. Pull up the lock located on both hinge supports and engage them in the hook of the hinge levers. You may have to apply a little downward pressure on the door to pull the locks fully over the hooks.
3. Grab the door by the sides, pull the bottom of the door up and toward you to disengage the hinge supports.

Keep pulling the bottom of the door toward you while rotating the top of the door toward the range to completely disengage the hinge levers.

4. Proceed in reverse to reinstall the door.

Make sure the hinge supports are fully engaged before unlocking the hinge levers.

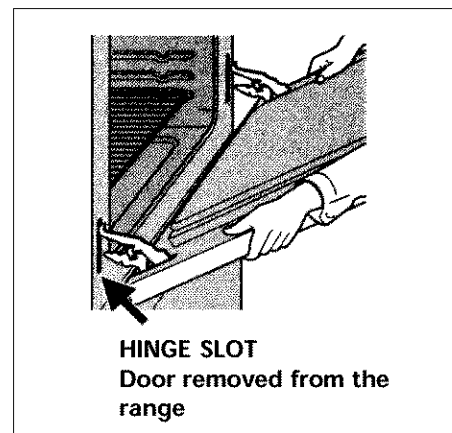
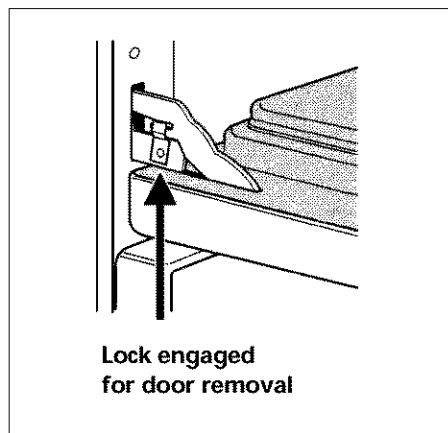
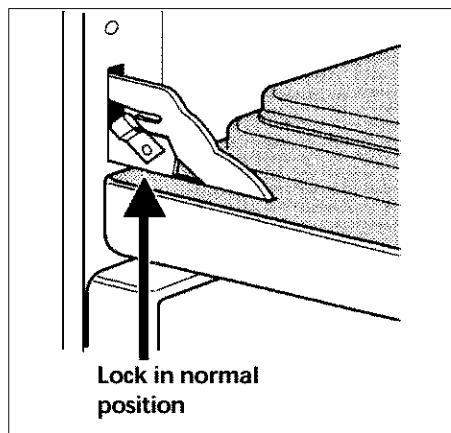

Removable Outer Door Glass Panel (some models)

Applicable only to models with an external glass panel not held with a frame. This design allows you to clean the inside face of the exterior door panel as well as the hidden face of the door inner glass.

To remove the external door glass panel:

1. Pull the door off the range and lay the door flat.
2. Using a screwdriver, remove the screws fastening the glass lower metal support rail to the underside of the door. Remove the support rail.
3. Grab both sides of the glass panel and slowly pull it out of the door upper moulding. Lay the glass flat.

!CAUTION Handle the glass panel with care. When dropped on a corner the glass panel may shatter in multiple fragments and you could get hurt.

To replace the external door panel:

1. Grab the sides of the glass panel and carefully insert the glass into the door top moulding.
2. Replace the glass support rail and the locking screws.
3. Replace the door onto the range.

To Remove/Replace Storage Drawer

To remove the Drawer:

Push down the left latch and pull up the right latches. Pull drawer out of range.

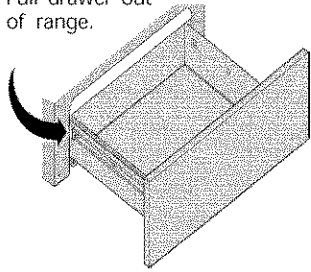

To Remove/Replace the Storage Drawer with Extendable Glides (some models)

Use the storage drawer for storing cooking utensils. The drawer can be removed to facilitate cleaning under the range. Use care when handling the drawer.

To Remove the Drawer:

1. Pull out the empty drawer until it stops.
2. Push down the left glide latch and pull up the right glide latch.
3. Pull drawer out of the range.

To Replace the Drawer:

1. Slide the drawer rails over the glides.
2. Push the drawer back into the range.

To Remove/Replace the Storage Drawer with Rollers (some models)

To Remove the Drawer:

1. Pull the empty drawer out to the roller guide stop.
2. Tilt the drawer up and pull it out over the rollers.

To Replace the Drawer:

1. Insert the rear end of the drawer into the opening.
2. Fit the drawer end rollers onto the guide rails.
3. Push the drawer in until it stops, then lift to allow the rollers to clear the roller guide stop, and push in.

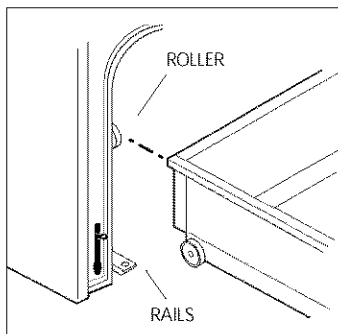

AVOID SERVICE CHECK LIST

Before you call for service - read this

You may save the cost and inconvenience of an unnecessary service call by first reviewing this easy to use Avoid-Service Check List of the most frequently encountered situations that are not the result of defective workmanship or materials.

You will be charged for a service call while the appliance is in warranty if the problem is not caused by defective product workmanship or materials.

Your new appliance is a carefully engineered product. Many times, what appears to be a reason to call for service requires nothing more than a simple adjustment you can easily make in your own home or is normal operating characteristic of appliance under certain conditions.

This list is applicable to a variety of models; some of the items will not necessarily apply to your appliance.

PROBLEM	POSSIBLE CAUSE / SOLUTION
----------------	----------------------------------

INSTALLATION

Range is not level.	Poor installation. See the suggested levelling instruction in the "General Information" section of this manual. When oven is level, cooktop may not appear to be level with counter top if the latter is not level.
	Be sure floor is level and can adequately support range. Contact carpenter to correct sagging or sloping floor.
	Kitchen cabinets misalignment may make range appear to be unlevel. Be sure cabinets are square and have sufficient room for range clearance (1.3 cm (1/2") each side).

RANGE DOES NOT OPERATE

Entire range does not operate.	House fuse has blown or circuit breaker has tripped. Check and/or replace fuse or reset circuit breaker.
	Cord/plug not plugged into wall outlet. Make sure cord plug is plugged tightly into outlet (Canada only).
	Power outage. Check house lights to be sure.
Oven does not operate.	No power to range. See steps "Entire range does not operate" above.
	Oven selector control knob (some models) set between two positions. Turn selector control knob to BAKE or BROIL, etc. and make sure surface signal lights turn on.
	Make sure the oven temperature control knob is set to the desired temperature.
	Oven control beeps and displays -F1- or -F3-. Electronic control has detected a fault condition. Push the CANCEL pad to clear the display and stop the beeping. Reprogram the oven. If fault recurs, record the fault number push the CANCEL pad and contact an authorized servicer.

PROBLEM

POSSIBLE CAUSE / SOLUTION

RANGE DOES NOT OPERATE (continued)

Surface elements do not heat.	No power to range. Check steps "Entire range does not operate" above.
	Control knobs set too low. At very low heat settings of the control knobs, the surface signal light may come on; however, surface unit does not operate. Turn the control knob to a slightly higher setting until the elements start heating.
	Coil elements not seated properly in terminals. Turn temperature control knobs to OFF. Pull out and lift up coil elements. Straighten terminals on end of coil element if necessary. Replace elements properly into the element block.
	Incorrect surface control knob turned on. Make sure the correct surface control is on for the surface unit to be used.
	Burned-out light bulb. See "Oven Lamp" in the "General Information" section.
Control panel light does not operate (some models).	Lamp loose in sockets or burned-out. See Fluorescent Lamp in General Information section.

SURFACE UNITS

Surface elements too hot or too cold.	Raise or lower setting until proper amount of heat is obtained.
	Use only flat bottom, evenly balanced, medium or heavyweight cookware. Pans having a flat bottom heat better than warped pans. Cookware material affects heating. Heavy and medium weight pans heat evenly. Because lightweight pans heat unevenly, foods may burn easily.
Liquids boil at LOW setting of surface units.	Incorrect setting of the control knob. Turn control knob to a lower setting.
	Cooking on right rear element. When the oven is operating, heated air escapes through the oven vent located directly under the right rear end coil element or little behind it. This will increase the heat input.

CERAMIC GLASS COOKTOP (some models)

Scratches or abrasions on cooktop surface.	See "Ceramic Glass Cooktop" section in "General Information" section.
--	---

NOTE: Clean sugary food spills on the heating surfaces as soon as possible, as these can cause cratering of these surfaces when hot.

PROBLEM

POSSIBLE CAUSE / SOLUTION

POOR BAKING RESULTS

Baked goods too done or not done enough.

Actual oven temperature and cooking times may vary from recipe or box instruction. If this is a new range, temperatures may differ from your old range. Older ovens may drift in temperature. You may have to adjust your favorite recipe times and temperatures.

Use the pan size recommended in the recipe. Except when baking pies or breads, set the oven temperature control 13°C (25°F) lower when using glass pans.

Baked foods not evenly browned and/or raised.

A covered pan should not be used for baking, unless specified in the recipe. Foods baked in covered pans do not brown well.

Use clean, shiny pans. Blackened pans may cause burning of bottom. Use flat bottom pans. Warped pans may cause uneven baking.

If bottom of foods burns, raise the rack. If top of foods is too brown, lower the rack.

Baking time too long.

Frequently opening the oven door to check doneness. Oven temperature drops 10°C (18°F) or more each time door is opened. Set for shortest baking time and check baking process only at end of set time. Check baking progress through the window if available.

Placing a very large pan or several smaller pans very close together on one rack does not allow proper circulation of the oven air around the pans. A cookie sheet or sheet pan should not cover the entire oven rack. Allow at least 5.1 cm (2 in.) of space for air circulation on all sides of baking pan(s) and between pans and sides of the oven. When two racks are used, stagger pans so one is not directly above the other.

It will take approximately 10 minutes for the oven to reach the temperature setting. Better results will be obtained by preheating the oven before placing foods to be baked.

Oven steaming.

Moist foods may cause oven steaming. Cover the dish if appropriate for the food being cooked.

PROBLEM

POSSIBLE CAUSE / SOLUTION

BROILING

Oven smokes excessively during broiling.

Open the door to the broil stop position.

Add 3 to 4 cups of water in the broiler pan to completely cover the bottom of the pan. Position food on grid and broil. The water catches the grease from the broiling food, cools the grease and reduces smoking.

Meat too close to the element. Lower the rack.

Remove excess fat from the meat. Slash remaining fat edges to prevent curling; do not cut into lean.

Always place the grid on the broiler pan with the slots down to allow grease to drip into the pan.

Grease has built up on oven surfaces. Regular cleaning is mandatory when broiling frequently. Old grease or food spatters cause excessive smoking.

SELF-CLEANING OVEN (some models)

Self-clean cycle does not work.

Follow steps specified in this manual for appropriate settings of controls.

Door was not closed properly. Close door and start appropriate clean cycle again.

Soil not completely removed after self-cleaning cycle.

Failure to clean the bottom or front top of oven or door area, these surfaces get hot enough to burn on residue. Self cleaning of area underneath a closed door is not efficient. Clean these areas before the self-cleaning cycle is started. Burned on residue may be cleaned with a stiff nylon brush and water or nylon scrubber. Be careful not to damage the oven seal.

Clean cycle too short. Put oven through an additional cycle.

Check for temporary loss of power. Reset the controls and put the oven through another self-clean cycle.

AVOID TRANSPORTATION DAMAGE TO YOUR RANGE

If you have to move your range into/out of your residence or when moving to a new home, it is suggested that you take the following precautions:

1. Screw in the leveling legs under the range.
2. Remove the racks and other utensils from the oven, and from the lower drawer.
3. Use adhesive tape to firmly secure the door and the drawer to the side panels. Also attach the electric power cord in the same manner.
4. Use a two-wheeled dolly with strap and fasten the range to it. Cover the appliance with a heavy blanket to prevent scratches and dents.
5. Avoid pulling or pushing the control panel when moving the appliance. If the range is equipped with an electronic controller, make sure that it has been exposed to a temperature above 0°C (32°F) for at least 3 hours before connecting it to the power supply, if moved during cold weather.

Notes

FRIGIDAIRE ELECTRIC RANGE WARRANTY

Your Frigidaire product is protected by this warranty

	WARRANTY PERIOD	WCI, THROUGH ITS AUTHORIZED SERVICERS, WILL:	THE CONSUMER WILL BE RESPONSIBLE FOR:
FULL ONE-YEAR WARRANTY	One year from original purchase date.	Pay all costs for repairing or replacing any parts of this appliance which prove to be defective in materials or workmanship.	Costs of service calls that are listed under NORMAL RESPONSIBILITIES OF THE CONSUMER.*
LIMITED 2ND - 5TH YEAR WARRANTY (Glass Smoothtop, Seal & Elements)	Second through fifth years from original purchase date.	Provide a replacement for any defective surface heating element, deteriorated rubberized-silicone seal (upswept models only), or glass smoothtop that cracks due to thermal breakage (not customer abuse).	Diagnostic costs and any transportation and labor costs which are required because of service.
LIMITED WARRANTY (Applicable to the State of Alaska)	Time periods listed above.	All of the provisions of the full and limited warranties above and the exclusions listed below apply.	Costs of the technician's travel to the home and any costs for pick up and delivery of the appliance required because of service.

Your appliance is warranted by Frigidaire Home products, a division of White Consolidated Industries, Inc. We authorize no person to change or add to any of our obligations under this warranty. Our obligations for service and parts under this warranty must be performed by Frigidaire Home products Consumer Services or an authorized Frigidaire servicer.

*NORMAL RESPONSIBILITIES OF THE CONSUMER

This warranty applies only to products in ordinary household use, and the consumer is responsible for the items listed below:

1. Proper use of the appliance in accordance with instructions provided with the product.
2. Proper installation by an authorized servicer in accordance with instructions provided with the appliance and in accordance with all local plumbing, electrical and/or gas codes.
3. Proper connection to a grounded power supply of sufficient voltage, replacement of blown fuses, repair of loose connections or defects in house wiring.
4. Expenses for making the appliance accessible for servicing, such as removal of trim, cupboards, shelves, etc., which are not a part of the appliance when it was shipped from the factory.
5. Damages to finish after installation.
6. Replacement of light bulbs and/or fluorescent tubes (on models with these features).

EXCLUSIONS

This warranty does not cover the following:

1. CONSEQUENTIAL OR INCIDENTAL DAMAGES SUCH AS PROPERTY DAMAGE AND INCIDENTAL EXPENSES RESULTING FROM ANY BREACH OF THIS WRITTEN OR ANY IMPLIED WARRANTY.
Note: Some states do not allow the exclusion or limitation of incidental or consequential damages, so this limitation or exclusion may not apply to you.
2. Service calls which do not involve malfunction or defects in workmanship or material, or for appliances not in ordinary household use. The consumer shall pay for such service calls.
3. Damages caused by services performed by persons other than authorized Frigidaire servicers; use of parts other than Frigidaire Home Products Genuine Renewal Parts; obtained from persons other than such servicers; or external causes such as abuse, misuse, inadequate power supply or acts of God.
4. Products with original serial numbers that have been removed or altered and cannot be readily determined.

IF YOU NEED SERVICE

Keep your bill of sale, delivery slip, or some other appropriate payment record. The date on the bill establishes the warranty period should service be required. If service is performed, it is in your best interest to obtain and keep all receipts. This written warranty gives you specific legal rights. You may also have other rights that vary from state to state. Service under this warranty must be obtained by following these steps, in order:

1. Contact Frigidaire Home Products Consumer Services or an authorized Frigidaire servicer.
2. If there is a question as to where to obtain service, call or write our Consumer Relations Department at:

Frigidaire Home Products Consumer Relations
P.O. Box 212378
Augusta, Georgia 30917-2378
(800) 944-9044



Product features or specifications as described or illustrated are subject to change without notice. All warranties are made by White Consolidated Industries, Inc. This warranty applies only in the 50 states of the U.S.A. and Puerto Rico.