

Mounting Wall Bracket

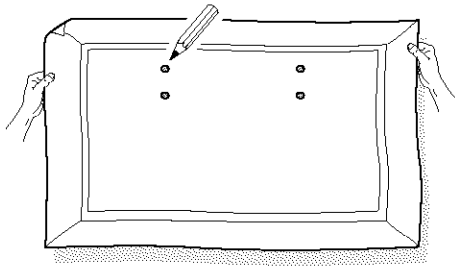

fig. 1

Note: the enclosed template can be used for general positioning only (fig. 1).

Mounting to sheetrock wall

Note: Bracket can only be used with standard 16" spaced wood wall studs.

Bracket must be positioned so that the bracket is fastened firmly to studs at each end.

All required hardware is included.

Note: Because the Receiver Unit's power cord is 6', when determining the Display Unit mounting location, the distance to the nearest AC power outlet must be considered.

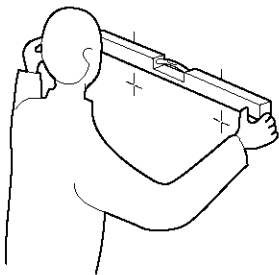

fig. 2

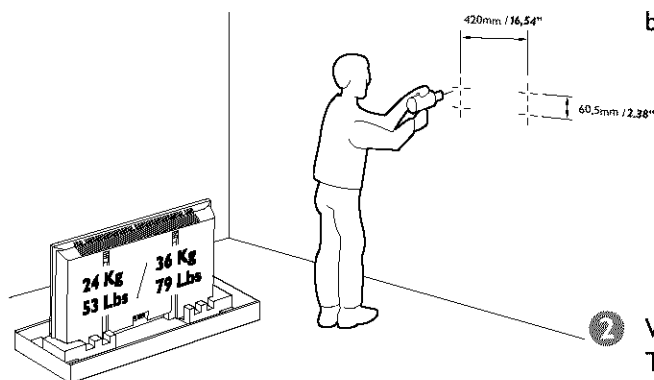

fig. 3

- 1 Determine desired location to mount Display Unit. Within this area, locate the two 16.54" spaced wall studs that must be used as the Wall Bracket mounting location. (fig. 1 and 2)

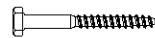

fig. 4

- 2 With the Wall Bracket held in place, ensure it is properly leveled. Then, mark where the four holes must be drilled. (fig. 2)

Note: Use only the holes in Bracket.

- 3 Remove the Wall Bracket, and using a 13/64" wood drill bit, drill the four holes. (fig. 3)

- 4 Reposition the Wall Bracket, and with four lag bolts (fig. 4), secure into place. Tighten with 13mm or 1/2" socket wrench. (fig. 5)

Note: Do not use plastic wall anchors with these lag bolts.

Note: Lag bolts must be fastened and centered securely into the stud.

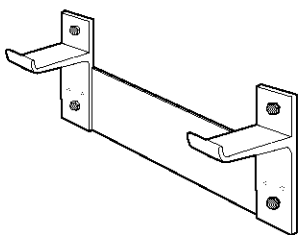
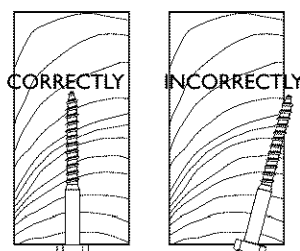
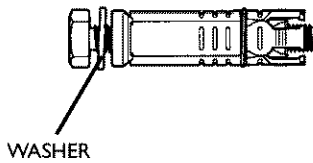

fig. 5





Mounting to concrete wall

- 1 Determine desired location to mount Display Unit. Use the enclosed template for alignment purposes. (fig. 1)
- 2 With the Wall Bracket held in place, ensure it is properly leveled. Then, mark where the four holes must be drilled. (fig. 4)
- 3 Remove the Wall Bracket, and using a 5/8" masonry drill bit, drill the four holes. (fig. 2)
- 4 Insert a concrete anchor (with bolt) into each hole.
- 5 Firmly tighten each bolt. Then, remove the bolts.
- 6 Reposition the Wall Bracket, and with the four bolts (and washers), secure into place.

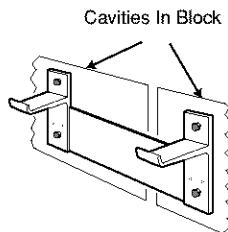

Fig. 1

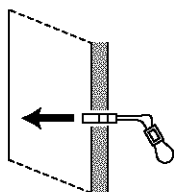

Fig. 2

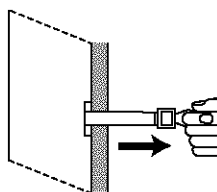

Fig. 3

Mounting to concrete block wall

- 1 Determine desired location to mount the Display Unit. Within this area, position the Wall Bracket so that the four end mounting holes are located over the cavities of the concrete blocks (refer to Figure 1)

- 2 With the Wall Bracket held in place, ensure it is properly leveled. Then, mark where the four holes are to be drilled.

Note: Use only the four outside or end holes in the Bracket.

- 3 Remove the Wall Bracket and reconfirm that the marks made in the previous step are located in the cavities of the concrete blocks. Relocate the marks as required to ensure that they are in the cavities of the concrete blocks.

- 4 With a 1/2" masonry drill bit, drill the four holes.

- 5 Hinge the plastic legs of the toggle bolt into the channel of the metal end of the toggle bolt so it can fit into the 1/2" hole drilled in the wall (refer to Figure 2).

- 6 Insert the toggle bolt into the hole in the wall and push it in until it is in the cavity of the block.

- 7 With the plastic pull ring of the toggle bolt, pull the metal end of the toggle bolt firmly against the back of the cavity of the concrete block (refer to Figure 3).

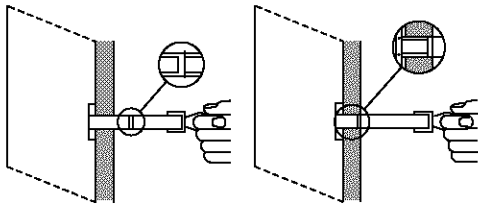

Fig. 4

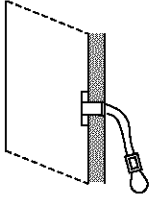

Fig. 5

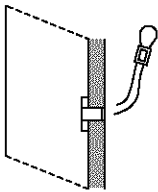

Fig. 6

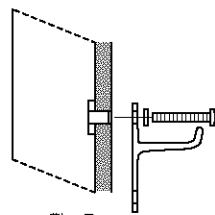

Fig. 7

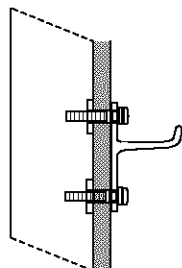

Fig. 8

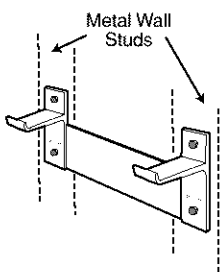

Fig. 1

Holes Centered In
Metal Wall Studs

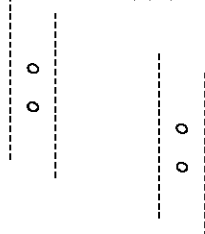

Fig. 2

- 8 While holding the plastic pull ring, slide the plastic retaining sleeve towards the wall until it fits into the hole in the wall. This will hold the toggle bolt in the wall while the Wall Bracket is mounted (refer to Figure 4).
- 9 Push down on the lower plastic leg of the toggle bolt and break it off flush with the wall (refer to Figure 5).
- 10 Push up on the upper plastic leg of the toggle bolt and break it off flush with the wall (refer to Figure 6).
- 11 Install the remaining 3 toggle bolts in the remaining holes the same way that the first one was installed.
- 12 Position the Wall Bracket in place and install the four 1/4-20 bolts, including washers, in each of the outside corner holes. Do not tighten completely (refer to Figure 7).
- 13 Confirm that the Wall Plate is level, then tighten the bolts securely (refer to Figure 8).

Mounting to metal stud wall

- 1 Determine desired location to mount the Display Unit. Within this area, locate the two 16.54" spaced metal wall studs that must be used as the Wall Bracket mounting location.
- 2 Locate the center of both wall studs at the height that the Wall Bracket is to be mounted.
- 3 With the Wall Bracket held in place, ensure it is properly leveled. Then, mark where the four holes are to be drilled.

Note: Use only the four outside or end holes in the Bracket (refer to Figure 1).

- 4 Remove the Wall Bracket and reconfirm that the marks made in the previous step are located in the center of the metal wall studs. Relocate the marks as required to ensure that they are in the center of the metal wall studs (refer to Figure 2).

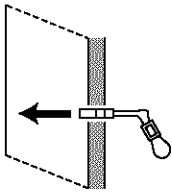

Fig. 3

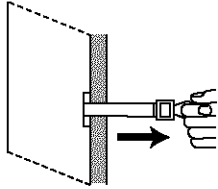

Fig. 4

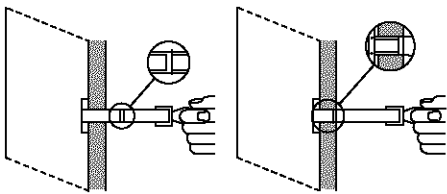

Fig. 5

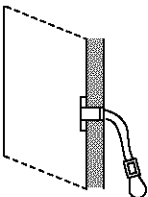

Fig. 6

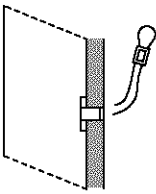

Fig. 7

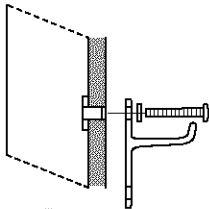

Fig. 8

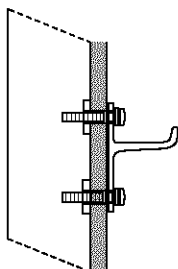
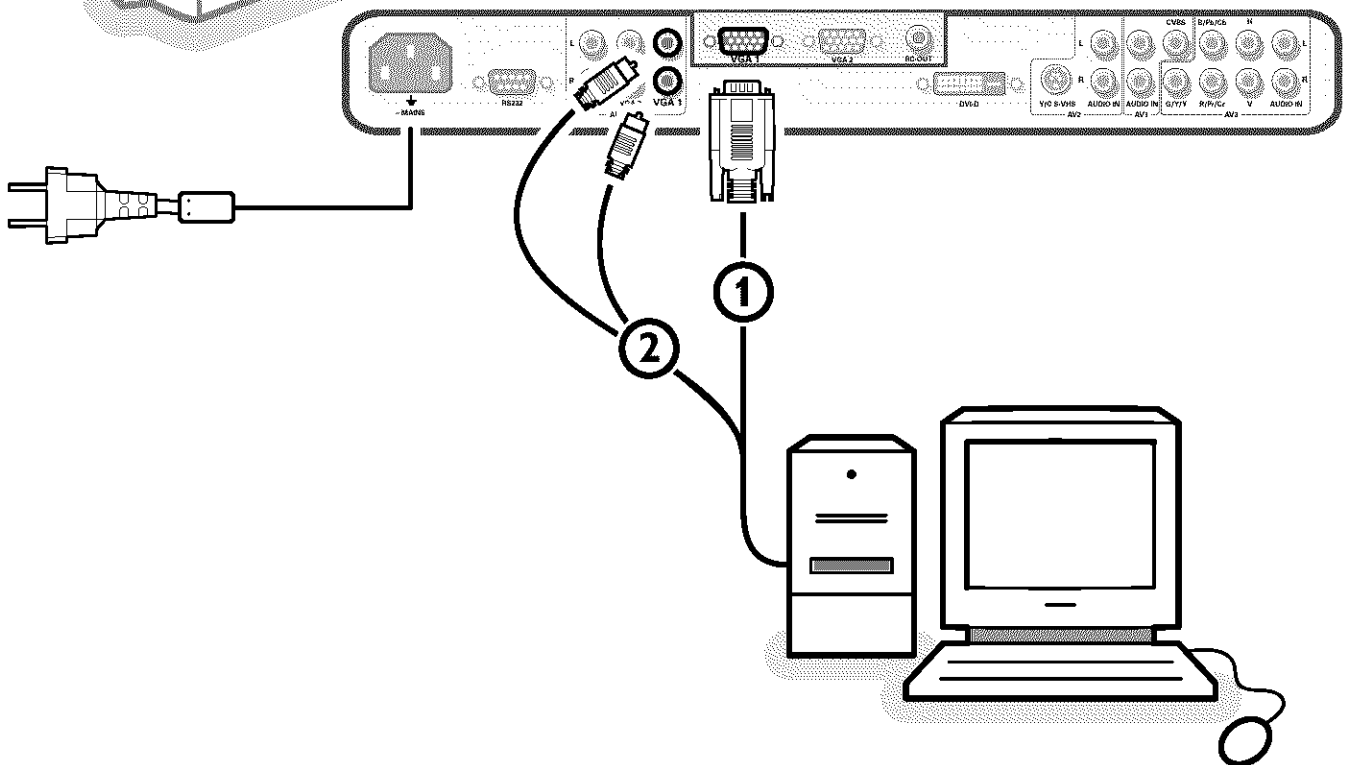
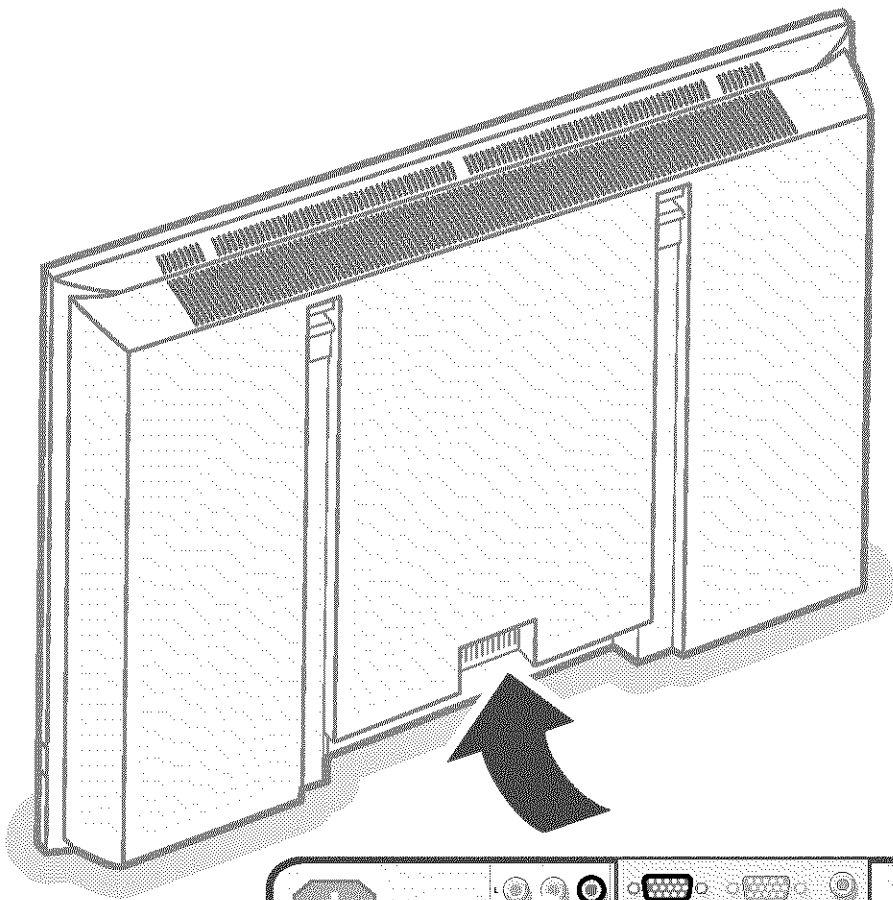

Fig. 9

- 5 With a 1/2" drill bit, drill the four holes. A smaller pilot hole may be required if the 1/2" drill bit bends the metal stud instead of piercing it.
- 6 Hinge the plastic legs of the toggle bolt into the channel of the metal end of the toggle bolt so it can fit into the 1/2" hole drilled in the wall (refer to Figure 3).
- 7 Insert the toggle bolt into the hole in the wall and push it in past the metal stud (refer to Figure 3).
- 8 With the plastic pull ring of the toggle bolt, pull the metal end of the toggle bolt firmly against the back of the metal stud (refer to Figure 4).
- 9 While holding the plastic pull ring, slide the plastic retaining sleeve towards the wall until it fits into the hole in the wall. This will hold the toggle bolt in the wall while the Wall Bracket is mounted (refer to Figure 5).
- 10 Push down on the lower plastic leg of the toggle bolt and break it off flush with the wall (refer to Figure 6).
- 11 Push up on the upper plastic leg of the toggle bolt and break it off flush with the wall (refer to Figure 7).
- 12 Install the remaining 3 toggle bolts in the remaining holes the same way that the first one was installed.
- 13 Position the Wall Bracket in place and install the four 1/4-20 bolts, including washers, in each of the outside corner holes. Do not tighten completely (refer to Figure 8).
- 14 Confirm that the Wall Plate is level, then tighten the bolts securely (refer to Figure 9).



Return your Warranty Registration card today to ensure you receive all the benefits you're entitled to.

Once your PHILIPS purchase is registered, you're eligible to receive all the privileges of owning a PHILIPS product. So complete and return the Warranty Registration Card enclosed with your purchase at once, and take advantage of these important benefits.

Warranty Verification

Registering your product within 10 days confirms your right to maximum protection under the terms and conditions of your PHILIPS warranty.

Owner Confirmation

Your completed Warranty Registration Card serves as verification of ownership in the event of product theft or loss.

Model Registration

Returning your Warranty Registration Card right away guarantees you'll receive all the information and special offers which you qualify for as the owner of your model.

PHILIPS

Congratulations on your purchase, and welcome to the "family!"

Dear PHILIPS product owner:

Thank you for your confidence in PHILIPS. You've selected one of the best-built, best-backed products available today. And we'll do everything in our power to keep you happy with your purchase for many years to come.

As a member of the PHILIPS "family," you're entitled to protection by one of the most comprehensive warranties and outstanding service networks in the industry.

What's more, your purchase guarantees you'll receive all the information and special offers for which you qualify, plus easy access to accessories from our convenient home shopping network.

And most importantly you can count on our uncompromising commitment to your total satisfaction.

All of this is our way of saying welcome-and thanks for investing in a PHILIPS product.

Sincerely,

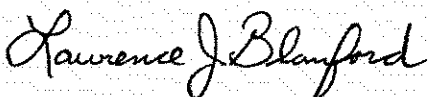

Lawrence J. Blanford
President and Chief Executive Officer

P.S. Remember, to get the most from your PHILIPS product, you must return your Warranty Registration Card within 10 days. So please mail it to us right now!



Know these **safety** symbols



 This "bolt of lightning" indicates uninsulated material within your unit may cause an electrical shock. For the safety of everyone in your household, please do not remove product covering.

 The "exclamation point" calls attention to features for which you should read the enclosed literature closely to prevent operating and maintenance problems.

WARNING: TO PREVENT FIRE OR SHOCK HAZARD, DO NOT EXPOSE THIS EQUIPMENT TO RAIN OR MOISTURE.

CAUTION: To prevent electric shock, match wide blade of plug to wide slot, fully insert.

ATTENTION: Pour éviter les choc électriques, introduire la lame la plus large de la fiche dans la borne correspondante de la prise et pousser jusqu'au fond.

For Customer Use

Enter below the Serial No., which is located on the rear of the cabinet. Retain this information for future reference.

Model No. _____

Serial No. _____



PHILIPS

Visit our World Wide Web Site at <http://www.philips.com>

IMPORTANT SAFETY INSTRUCTIONS

Read before operating equipment

1. Read these instructions.
2. Keep these instructions.
3. Heed all warnings.
4. Follow all instructions.
5. Do not use this apparatus near water.
6. Clean only with a dry cloth.
7. Do not block any of the ventilation openings. Install in accordance with the manufacturers instructions.
8. Do not install near any heat sources such as radiators, heat registers, stoves, or other apparatus (including amplifiers) that produce heat.
9. Do not defeat the safety purpose of the polarized or grounding-type plug. A polarized plug has two blades with one wider than the other. A grounding type plug has two blades and third grounding prong. The wide blade or third prong are provided for your safety. When the provided plug does not fit into your outlet, consult an electrician for replacement of the obsolete outlet.
10. Protect the power cord from being walked on or pinched particularly at plugs, convenience receptacles, and the point where they exit from the apparatus.
11. Only use attachments/accessories specified by the manufacturer.
12.  Use only with a cart, stand, tripod, bracket, or table specified by the manufacturer, or sold with the apparatus. When a cart is used, use caution when moving the cart/apparatus combination to avoid injury from tip-over.
13. Unplug this apparatus during lightning storms or when unused for long periods of time.
14. Refer all servicing to qualified service personnel. Servicing is required when the apparatus has been damaged in any way, such as power-supply cord or plug is damaged, liquid has been spilled or objects have fallen into apparatus, the apparatus has been exposed to rain or moisture, does not operate normally, or has been dropped.
15. This product may contain lead or mercury. Disposal of these materials may be regulated due to environmental considerations. For disposal or recycling information, please contact your local authorities or the Electronic Industries Alliance: www.eiae.org.
16. **Damage Requiring Service** - The appliance should be serviced by qualified service personnel when:
 - A. The power supply cord or the plug has been damaged; or
 - B. Objects have fallen, or liquid has been spilled into the appliance; or
 - C. The appliance has been exposed to rain; or
 - D. The appliance does not appear to operate normally or exhibits a marked change in performance; or
 - E. The appliance has been dropped, or the enclosure damaged.
17. **Tilt/Stability** - All televisions must comply with recommended international global safety standards for tilt and stability properties of its cabinets design.
 - Do not compromise these design standards by applying excessive pull force to the front, or top, of the cabinet which could ultimately overturn the product.
 - Also, do not endanger yourself, or children, by placing electronic equipment/toys on the top of the cabinet. Such items could unsuspectingly fall from the top of the set and cause product damage and/or personal injury.
18. **Wall Mounting** - The appliance should be mounted to a wall only as recommended by the manufacturer.
19. **Power Lines** - An outdoor antenna should be located away from power lines.
20. **Outdoor Antenna Grounding** - If an outside antenna is connected to the receiver, be sure the antenna system is grounded so as to provide some protection against voltage surges and built up static charges. Section 810 of the National Electric Code, ANSI/NFPA No. 70-1984, provides information with respect to proper grounding of the mats and supporting structure grounding of the lead-in wire to an antenna-discharge unit, size of grounding connectors, location of antenna-discharge unit, connection to grounding electrodes and requirements for the grounding electrode. See Figure below.
21. **Objects and Liquid Entry** - Care should be taken so that objects do not fall and liquids are not spilled into the enclosure through openings.

EXAMPLE OF ANTENNA GROUNDING AS PER NATIONAL ELECTRICAL CODE (NEC)

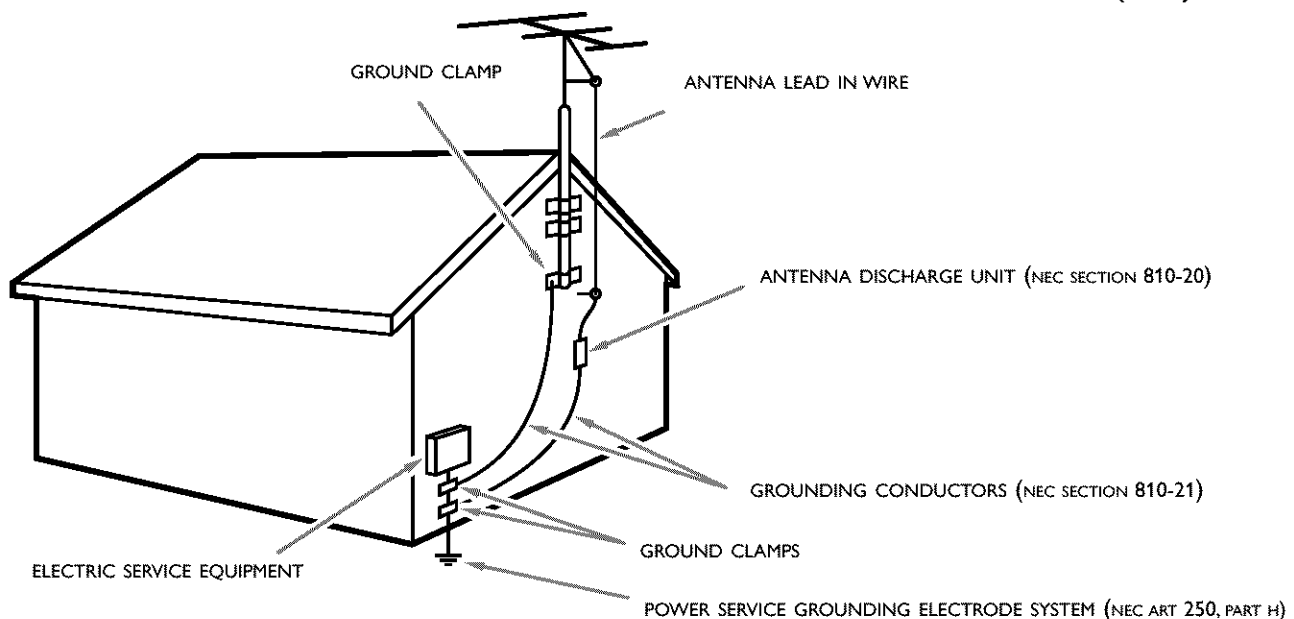

Note to the CATV system installer: This reminder is provided to call the CATV system installer's attention to Article 820-40 of the NEC that provides guidelines for proper grounding and, in particular, specifies that the cable ground shall be connected to the grounding system of the building, as close to the point of cable entry as practical.

Unpacking and wall mounting instructions

For the unpacking instructions follow the illustrated steps printed on the packaging (outside and inside). For the wall mounting instructions follow the illustrated steps ④ to ⑥ printed on the separate template and in the supplied booklet.

Make sure that the wall mount is being fixed securely enough so that it meets safety standards. The weight of the monitor (excl. packaging) is about 53 Lbs or 79 Lbs, depending on the screen size (32" or 42").

Note: stands are optional accessories. Consult your dealer.

Connect your computer

Directly to the monitor

- ① Connect one end of a VGA cable ① to the video card of the computer and the other end to the **VGA 1** connector at the rear side of the monitor. Fix the connectors firmly with the screws on the plug.
- ② In case of a Multimedia computer, connect the audio cable ② to the audio outputs of your Multimedia computer and to the **AUDIO VGA 1 R** (right) and **L** (left) inputs of the TV monitor.

VGA 2: The video connector for VGA 2 can be programmed to become an input or an output via the Setup menu, see p. 8. The function of being input or output is determined by the used mode. If the monitor is used in TV mode, the VGA 2 connector is VGA output. If the monitor is used in monitor mode, the connector is VGA input or output.

To a TV receiver box

See the handbook of the TV receiver box.

- ① Connect one end of a VGA cable to the video card of the computer and the other end to the **PC/MAC IN** connector at the rear side of the TV receiver box. Fix the connectors firmly with the screws on the plug.
- ② In case of a Multimedia computer, connect the audio cable to the audio outputs of your Multimedia computer and to the **AUDIO IN R** (right) and **L** (left) inputs of the TV receiver box.

Note: Only use the VGA cable supplied with the monitor.

Daisy chaining

The Loop Through facility makes it possible to make a daisy chain with a second monitor.

- ③ Connect one end of another VGA cable to the **VGA 2** connector at the rear side of the monitor and the other end to the **VGA 1** connector of a second monitor.
- ④ In case of a Multimedia computer, also connect audio cables to the **AUDIO L** and **R** outputs of the original monitor and to the **AUDIO L** and **R** inputs of the second monitor.

The RC out jack next to the VGA 2 connector makes it possible to daisy chain remote control signals to other equipment.

This output cannot be used to daisy chain a second monitor.

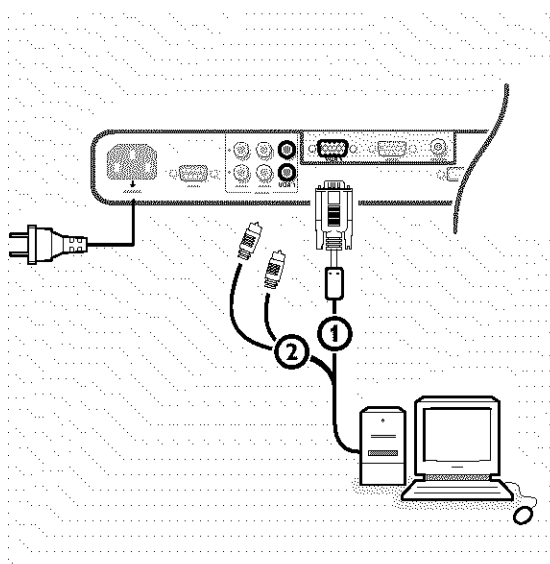

Computer Display modes

VGA	640x480	60, 72, 75, 85 Hz
Wide VGA	848x480	60 Hz
Wide VGA	852x480	60 Hz
MAC	640x480	66.67 Hz
MAC	832x624	74.55 Hz
MAC	1024x768	74.93 Hz
MAC	1152x870	75 Hz
SVGA	800x600	56, 60, 72, 75, 85 Hz
XGA	1024x768	60, 70, 75, 85 Hz
SXGA	1280x1024	60 Hz, 72 Hz (not with DVI-D source)

When a VGA computer is connected, the display selection is made automatically.

A message is displayed when the monitor does not support the connected VGA mode. Switch your computer to a correct display mode.

Operation

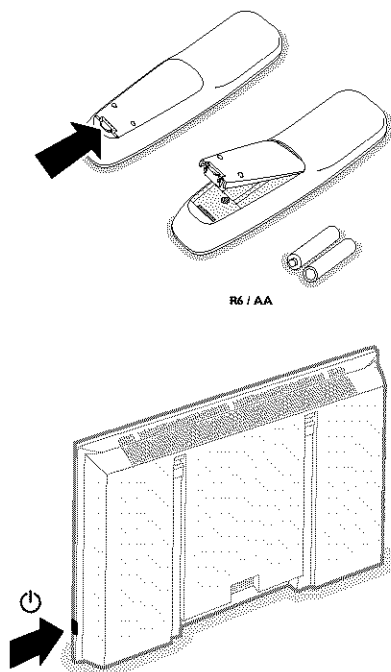

- 1 Insert the mains plug** supplied into the mains inlet at the back of the monitor and in the wall socket. For safety, please, only use the supplied rim-earthed mains cord which has to be inserted in a grounded socket.
 - 2 Remote control:** remove the cover of the battery compartment. Insert the 2 batteries supplied (Type LR6/AA-1.5V).
The batteries supplied do not contain the heavy metals mercury and cadmium. Nevertheless in many countries batteries may not be disposed of with your household waste. Please check on how to dispose of batteries according to local regulations.
 - 3** Make sure that your TV receiver box and/or PC are switched on and that your PC is in the correct display mode.
 - 4 Switch the monitor on :** Press the power key  at the right side of the monitor.
A green indicator lights up and the screen comes on.
When the monitor does not receive a supported VGA signal and is not connected to a receiver box, the screen switches to standby and the red indicator lights up.
- When you switch on your monitor **for the first time**, and the monitor is not connected to a TV receiver box, the language menu automatically appears on the screen. The explanation appears in different languages one at a time.
- Follow the instructions on screen to select the correct language or see Setup menu, Language, p. 8.

Use of the remote control

VGA

press repeatedly to select your computer connected to the **VGA 1** or **2** connector or to the **DVI-D** connector.

AV1, AV2, AV3

press to select the peripherals connected to the connector indicated on the monitor.

BRIGHTNESS +/-

to adjust the brightness level of the picture

CONTRAST +/-

to adjust the contrast level of the picture

ZOOM ON/OFF

to activate/de-activate the zoom function. See p. 7.

ZOOM IN/OUT to adjust the zoom factor and to change the magnification of the picture when zoom is activated. See p. 7.

 to switch to standby or on again

MENU to switch the menu on/off
cursor buttons to select your choice and to alter a selected adjustment.

OK to activate your choice

 press - or + to adjust the volume

Mute button

Mute the sound or restore it

CH/PR Program selection

To browse through the sources selected.

AV MUTE to mute the picture and the sound or restore it (if the monitor is used in monitor mode).

When activated a green indicator starts blinking in front of the monitor.

Picture format

See Picture 2 menu, p. 7.

Press the  button to switch between the different picture formats.

On screen information

When the monitor is used in the monitor mode, information about the active source (**AV1, AV2, AV3, VGA1, VGA2** or **DVI-D**), and the supported video, **VGA** or **HD**-format of the selected source is displayed on the screen together with the selected picture format and icons informing about selected sound mode and **AV** or audio mute.

Use of the menus and the menu system

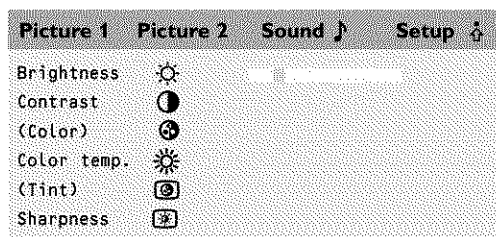

- 1 Press the **MENU** button on the remote control to summon the different menu headers.
- 2 Press the cursor left/right to move the cursor horizontally through the menu headers.
- 3 Press the cursor down to access the menu.
In case of a slider, move the cursor left/right to adjust.
In case of a list with options, move the cursor right to enter and use the cursor up/down to select an option.
Press the cursor left to leave the options list.
- 4 Press the **MENU** button again to switch off the menu.

*Note: Sometimes not all the menu items are visible on the screen.
Press the cursor down until all the items are displayed.*

Only when the US English language has been selected (see Setup menu, Language, p. 8), the menu items will be displayed with additional icons.

Operation

Press the **MENU** button on the remote control to summon the main menu.

Picture 1 menu

Brightness

This control allows you to adjust the brightness level of the picture.

Contrast

This control allows you to adjust the contrast level of the picture.

Color (only available when the source is **AV1**, **AV2** or **AV3 YCbCr**)

This control allows you to adjust the saturation level of the colors to suit your personal preference.

Color temperature

This control allows you to select the color temperature of the picture.

Move the cursor up/down to make a selection.

Press the cursor left to return to the Picture 1 menu.

Tint (only with **NTSC** signals and when the source is **AV1** or **AV2**)

This control allows you to compensate for the color variations in **NTSC** encoded transmissions.

Sharpness

This control allows you to adjust the edge definition of a picture.

SD video-mode

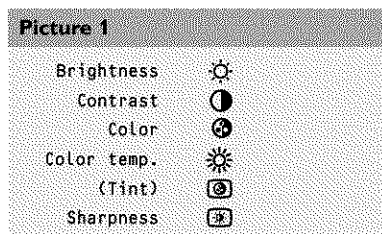

VGA-mode + HD video mode

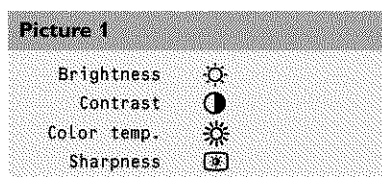

SD video-mode

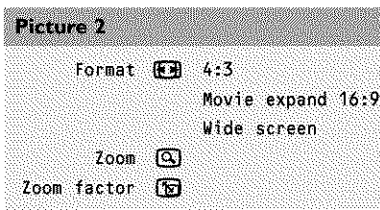

VGA-mode + HD video mode

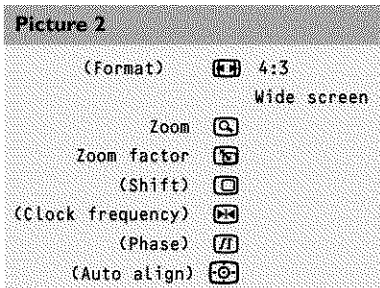

4:3 VGA-mode

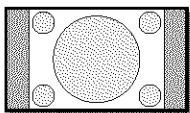

4:3

SD video-mode

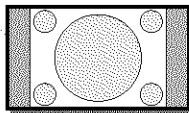

4:3

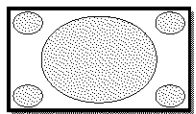

Wide screen

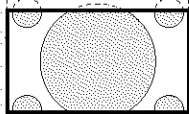

Movie expand 16:9

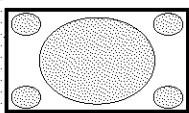

Wide screen

Picture 2 menu

Zoom

Select **Zoom On** to activate the zoom function.

You may also activate the zoom function with the **ZOOM ON/OFF** button on the remote control.

If no zoom is active, press the cursor left/right, up/down to select which part of the screen will be zoomed.

Zoom factor

Select **Zoom factor** and press the cursor left/right to adjust the zoom factor and to change the magnification of the picture.

If zoom is not active, changing the magnification factor will have no effect on the displayed picture.

Format (only available in 4:3 VGA mode and SD video mode)

Select **Format** to summon a list of **available** display formats.

Press the cursor up/down to select another display format: 4:3,

Movie expand 16:9 or Wide screen.

Note: Movie expand 16:9 is not available in VGA mode.

Shift (only available in VGA mode on VGA1 or VGA2 and in one of the HD modes. See *Connect Peripheral Equipment*, p. 9.)

This control allows you, when necessary, to move the picture in a horizontal or vertical way.

- 1 Use the cursor left/right, up/down to adjust.
- 2 Press the **OK** button when done.

Clock frequency (only available in VGA mode on VGA 1 or VGA 2.

See *Connect Peripheral equipment*, p. 9.)

This control allows you, when necessary, to adjust the values of the clock frequency so that especially text can be displayed with an optimal overall sharpness.

Use the cursor left/right to adjust.

Phase (only available in VGA mode on VGA 1 or VGA 2.

See *Connect Peripheral equipment*, p. 9.)

This control allows you, when necessary, to adjust the pixel phase of the picture to avoid picture interference.

Use the cursor left/right to adjust.

Auto align (only available in VGA mode on VGA1 or VGA2 and in one of the HD modes. See *Connect Peripheral Equipment*, p. 9.)

This control allows you to automatically adjust the shift, the clock frequency and the phase in VGA mode and the shift in HD modes.

Press **OK** to execute.

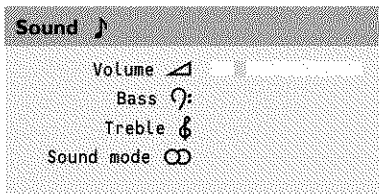

Sound menu

Volume

This control allows you to adjust the volume level of the sound from the speakers.

Bass

Bass attenuates or amplifies the low-frequency response of the sound from the loudspeakers.

Treble

Treble attenuates or amplifies the high-frequency response of the sound from the loudspeakers.

Sound mode

This control allows you to switch between mono and stereo sound.

Note: Bass, Treble and Sound mode will not be available in VGA loop through mode, i.e. when a TV receiver box is connected to the monitor and a VGA source is selected.

Setup menu

Language

- ① Use the cursor down to select **Language**.
- ② Press the cursor right to enter the list of selectable languages.
- ③ Use the cursor up/down to scroll through the list and to bring up other languages which are not displayed on the screen at present.

Note: Only with the US English language, the menu items will be displayed with additional icons.

Power savings

This control allows you to overrule the automatic power savings feature. In case **Power savings** is switched **Off**, the power always remains on until the monitor is forced to standby.

- ① Use the cursor down to select **Power savings**.
- ② Press the cursor left/right to select **On** or **Off**.

AV3

This control allows you to set the AV3 input to HD-RGB, YCbCr or HD-YPbPr. When having selected **Auto**, the monitor makes the selection automatically between YCbCr, HD-YPbPr or HD-RGB.

See also p. 9, Equipment with Component Video Output connectors.

- ① Use the cursor down to select **AV3**.
- ② Press the cursor right to enter the list with options.
- ③ Press the cursor up/down to select one of the options.

VGA2

This control allows you to select whether to set the VGA2 connector as input, output or even HD-input.

- ① Use the cursor down to select **VGA2**.
- ② Press the cursor right to enter the list with options: **VGA IN**, **VGA OUT** or **HD IN**.
- ③ Press the cursor up/down to select one of the options.

Note: AV3 and VGA2 will not be available in VGA loop through mode, i.e. when a TV receiver box is connected to the monitor and a VGA source is selected.

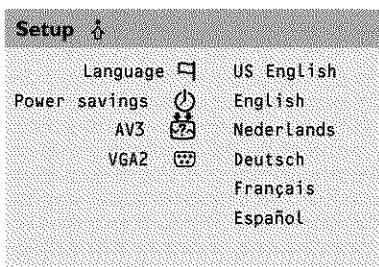

Connect Peripheral Equipment

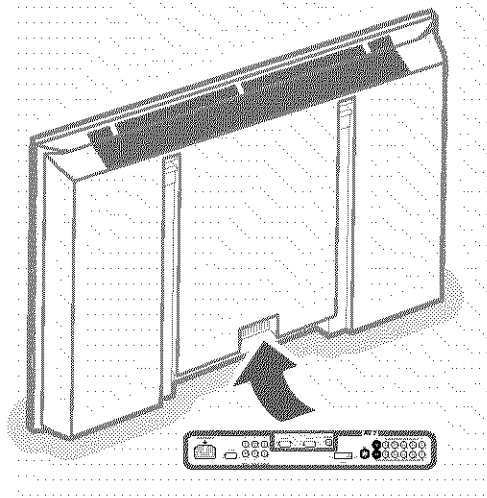

You may connect 3 possible VGA sources (**VGA1**, **VGA2** or **DVI-D**) and 3 possible video sources (**AV1**, **AV2** and **AV3**) to the monitor. The following diagrams show you where you can connect your peripheral equipment.

Note: in case the monitor is operating in combination with a TV receiver box (TV mode), the AV inputs on the monitor will be disabled and the VGA2 connector becomes an output.

Equipment with Y/C-SVHS output connectors

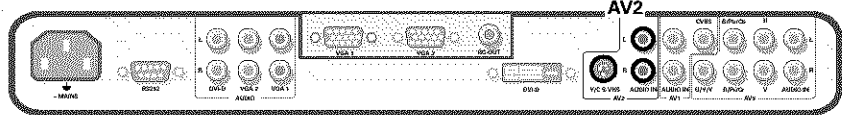

- 1 Connect the video cable to the **AV2** connector.
- 2 Connect the audio cables to the equipment's **AUDIO L** and **R** sockets and to the **AUDIO L** and **AUDIO R AV2** sockets on the monitor.

Equipment with CVBS output connectors

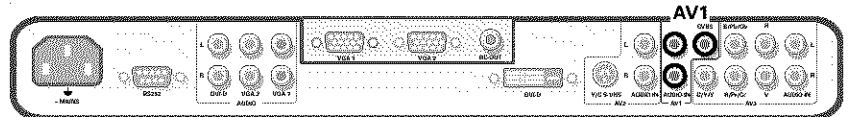

- 1 Connect the video cable to the **AV1** connector.
- 2 Connect the audio cables to the equipment's **AUDIO L** and **R** sockets and to the **AUDIO L** and **RAV1** sockets on the monitor.

Equipment with Component Video Output connectors

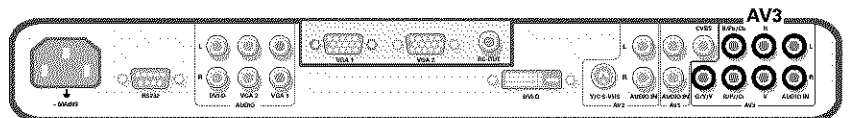

Note: AV3 can handle the following video signals: YCbCr, HD-YpPr and HD-RGB. The discrimination between the various input formats and the appropriate video processing is done automatically. It is however possible to overrule the automatic detection. See Setup menu, p. 8.

- 1 Connect the video cables of your equipment with YPbPr output with composite sync on Y, or of your equipment with YCbCr output with composite sync on Y to the YPbPr, resp. YCbCr input **AV3 IN** sockets of the monitor.
- 2 Connect the video cables of your equipment with RGB output with separate Horizontal and Vertical sync to the RGB input sockets and to the H and V sockets **AV3** of the monitor.
- 3 Connect the audio cables to the equipment's **AUDIO L** and **R** sockets and to the **AUDIO IN L** and **AUDIO IN R AV3** sockets on the monitor.

Note: when High Definition signals are inputted to the monitor via the YPbPr/RGB input, the monitor switches to the HD Video Mode.

The following HD and SD video modes are supported by the monitor on the YPbPr, RGB and VGA2 HD input:

1920x1080/60i 720x480/60P
1280x720/60P 720x576/50P

The following SD video modes are supported by the monitor on the YCbCr input:

720x480/60i
720x576/50i

Note: you should make the correct selection for AV3 in the Setup menu, p. 8.

High Definition equipment with VGA connector

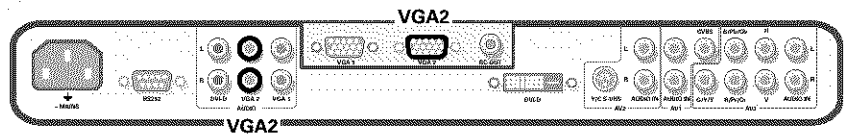

- 1 Connect the VGA output of your equipment to the **VGA2** connector.
- 2 Connect the audio cables to the equipment's **AUDIO L** and **R** sockets and to the **VGA2 AUDIO L** and **R** sockets on the monitor.

*Note: you should select **HD IN** for **VGA2** in the Setup menu. (See p. 8.)*

Digital DVI output of your PC (DVI-D) or DVD player

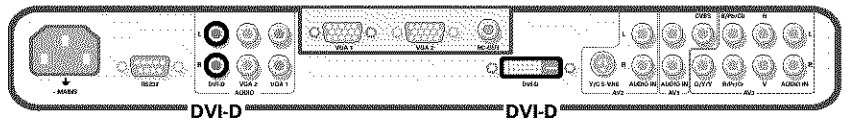

- 1 Connect the Digital DVI output of your PC or DVD-player to the **DVI-D** connector.
- 2 Connect the audio cables to the **DVI-D AUDIO L** and **R** sockets on the monitor.

RC out connector

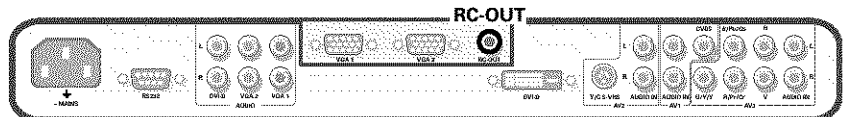

This connector allows you to daisy chain remote control signals to other equipment (e.g. AV receiver, IR repeater) which have an electrical RC in.

Note: it is not possible to daisy chain a second monitor.

Serial I/O port RS232

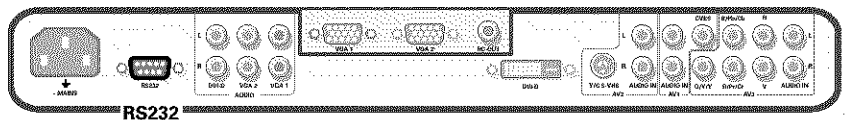

The RS232 connector is only to be used with the monitor as stand alone. This connector allows you to control the monitor via your PC (as a replacement of the remote control).

Note: This connector can also be used for dealer service tools.

Tips

Ambient temperature

Do not hang up the monitor above a central heating or other heating sources.

Care of the screen

Clean the anti-reflex coated flat glass screen with a slightly damp soft cloth. Do not use abrasives solvents as it can damage the glass surface of the screen.

Plasma Display characteristics

Caution: A video source (such as a video game, DVD, or TV information channel) which shows a constant non-moving pattern on the TV screen, can cause damage to the screen. When your Flat-TV is continuously used with such a source, the pattern of the non-moving portion of the game (DVD, etc.) could leave an image permanently on the screen. When not in use, turn the video source **OFF**. Regularly alternate the use of such video sources with normal TV viewing.

When switching over to another picture after having displayed the same still picture for a long time (many hours), it may happen that some parts from the previous picture will remain on screen due to a kind of memory effect. This ghost picture will disappear after some time. To avoid this effect change the pictures regularly or for PC use you can turn on a screen saver in your computer.

Philips has built in an automatic shift of the picture in video mode every 5 minutes to decrease this effect and to prolong the life of the screen.

Very incidentally and after a longer period of unuse (approx. 1 year) the screen may display some strange color deficiencies.

This is quite normal for plasma displays and these effects will disappear after the set has been turned on for some time.

A plasma display consists of more than 3.1 Million color pixels. It is within industry standards that very few pixels (< 0.001%) may be defective, even for a new set. There is however no reason to doubt about the quality of the set.

The plasma display technology operates with rare gases which are being influenced by air pressure.

Up to an altitude of 6562 ft above sea-level, the display is functioning fine. Operating the set at a higher altitude, the picture becomes unstable and the picture performance is deteriorating. After bringing the set below 6562 ft it works fine again. Transportation has no influence.

Control of peripheral equipment

The infrared radiation of the screen may influence the reception sensitivity of other peripherals. Solution: replace the batteries of the remote control or change position of other equipment. E.g. keep away a wireless headphone from within a radius of 4.92 ft.

No stable or not synchronized VGA picture

Check if you have selected the correct display mode in your PC. See p.4, Computer display modes.

No picture or no sound

Are the supplied cables connected properly? (The power cable to the display, the VGA cables, the audio cables,...) Is your PC switched on?

Do you see a black screen and the indicator in front of the monitor lights up green, this means that the display mode is not supported.

Switch your VGA source to a correct mode.

Remote control

If your monitor no longer responds to the remote control, the batteries may be exhausted.

If your problem is not solved:

Switch your monitor off and then on again.

Never attempt to repair a defective monitor yourself.

Check with your dealer or call a TV technician.

Transport

Keep the original packaging to transport the monitor if needed.

End of life directives

Philips is paying a lot of attention to produce environmentally-friendly in green focal areas. Your new monitor contains materials which can be recycled and reused.

At the end of its life specialized companies can dismantle the discarded monitor to concentrate the reusable materials and to minimize the amount of materials to be disposed of.

Please ensure you dispose of your old monitor according to local regulations.

How to dispose of batteries ?

The batteries supplied do not contain the heavy metals mercury and cadmium. Nevertheless in many countries batteries may not be disposed of with your household waste. Please ensure you dispose of batteries according to local regulations.

Miscellaneous

- . Ambient temperature: + 5~ + 40°C
- . Maximum operating altitude: 2000 m/6562 ft (min. pressure 800h Pa)
- . Mains: AC 95-264V 50/60 Hz
- . Power consumption:
 - ± 250 W (32") or ± 320 W (42")
- . Standby consumption: < 2 W
- . Weight (excl. packaging)
 - Display: 53 (32") or 79 (42") Lbs
- . Dimensions (wxhxd):
 - Display: 38 x 20,2 x 3,5 inch (32") or 47,8 x 25,9 x 3,5 inch (42")
- . Wall mounting bracket included