

Panasonic®

DVD VIDEO RECORDER

Operating Instructions

Model No. **DMR-HS2**



Dear customer

Thank you for purchasing this product. For optimum performance and safety, please read these instructions carefully.

Before connecting, operating or adjusting this product, please read these instructions completely. Please keep this manual for future reference.

Region number supported by this unit

Region numbers are allocated to DVD players and software according to where they are sold.

- The region number of this unit is "1".
- The unit will play DVDs marked with labels containing "1" or "ALL".

Example:



For U.S.A.

The warranty can be found on page 72.

For Canada

The warranty can be found on page 73.



This manual was printed with soy based ink.

En las páginas 74 y 75 hay una guía de referencia rápida en español.

CAUTION!

THIS PRODUCT UTILIZES A LASER.
 USE OF CONTROLS OR ADJUSTMENTS OR PERFORMANCE OF PROCEDURES OTHER THAN THOSE SPECIFIED HEREIN MAY RESULT IN HAZARDOUS RADIATION EXPOSURE.
 DO NOT OPEN COVERS AND DO NOT REPAIR YOURSELF. REFER SERVICING TO QUALIFIED PERSONNEL.

WARNING:

TO REDUCE THE RISK OF FIRE, ELECTRIC SHOCK OR PRODUCT DAMAGE, DO NOT EXPOSE THIS APPARATUS TO RAIN, MOISTURE, DRIPPING OR SPLASHING AND THAT NO OBJECTS FILLED WITH LIQUIDS, SUCH AS VASES, SHALL BE PLACED ON THE APPARATUS.



CAUTION
 RISK OF ELECTRIC SHOCK
 DO NOT OPEN



CAUTION: TO REDUCE THE RISK OF ELECTRIC SHOCK, DO NOT REMOVE SCREWS. NO USER-SERVICEABLE PARTS INSIDE. REFER SERVICING TO QUALIFIED SERVICE PERSONNEL.



The lightning flash with arrowhead symbol, within an equilateral triangle, is intended to alert the user to the presence of uninsulated "dangerous voltage" within the product's enclosure that may be of sufficient magnitude to constitute a risk of electric shock to persons.



The exclamation point within an equilateral triangle is intended to alert the user to the presence of important operating and maintenance (servicing) instructions in the literature accompanying the appliance.

THE FOLLOWING APPLIES ONLY IN THE U.S.A.:

FCC Note:

This equipment has been tested and found to comply with the limits for a Class B digital device, pursuant to Part 15 of the FCC Rules. These limits are designed to provide reasonable protection against harmful interference in a residential installation. This equipment generates, uses, and can radiate radio frequency energy and, if not installed and used in accordance with the instructions, may cause harmful interference to radio communications. However, there is no guarantee that interference will not occur in a particular installation. If this equipment does cause harmful interference to radio or television reception, which can be determined by turning the equipment off and on, the user is encouraged to try to correct the interference by one or more of the following measures:

- Reorient or relocate the receiving antenna.
- Increase the separation between the equipment and receiver.
- Connect the equipment into an outlet on a circuit different from that to which the receiver is connected.
- Consult the dealer or an experienced radio/TV technician for help.

FCC Caution: To assure continued compliance, follow the attached installation instructions and use only shielded interface cables when connecting to peripheral devices. Any changes or modifications not expressly approved by the party responsible for compliance could void the user's authority to operate this equipment.



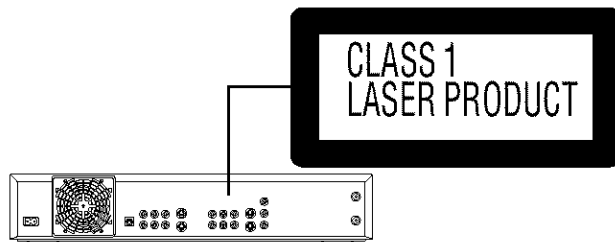

This device complies with Part 15 of the FCC Rules. Operation is subject to the following two conditions: (1) This device may not cause harmful interference, and (2) this device must accept any interference received, including interference that may cause undesired operation.

<p>CAUTION - VISIBLE AND INVISIBLE LASER RADIATION WHEN OPEN. AVOID DIRECT EXPOSURE TO BEAM. (FDA 21 CFR)</p> <p>CAUTION - VISIBLE AND INVISIBLE LASER RADIATION WHEN OPEN. AVOID EXPOSURE TO BEAM. (IEC60825-1)</p> <p>ATTENTION - RAYONNEMENT LASER VISIBLE ET INVISIBLE EN CAS D'OUVERTURE. EXPOSITION DANGEREUSE AU FASCEAU.</p> <p>ADVARSEL - SYNLIG OG USYNLIG LASERSTRÅLING VED ÅBNING. UNDGÅ UDSÆTTELSE FOR STRÅLING.</p> <p>VARO! - AVATTAESSA OLET ALLTIINA NÄKYVÄÄ JA NÄKYMÄTÖN LASERSÄTEILYLLÄ. ÄLÄ KATSO SÄTEESEEN.</p> <p>VARNING - SYNLIG OCH USYNLIG LASERSTRÅLNING NÄR DENNA DEL ÄR ÖPPNAD. BETRÄKTA EJ STRÅLEN.</p> <p>ADVARSEL - SYNLIG OG USYNLIG LASERSTRÅLING NÄR DEKSEL ÅPNES. UNNGÅ EKSPONERING FOR STRÅLEN.</p> <p>VORSICHT - SICHTBARE UND UNSICHTBARE LASERSTRAHLUNG, WENN ABDECKUNG GEÖFFNET. NICHT DEM STRAHL AUSSETZEN.</p> <p>注意 - 打开时有可见及不可见激光辐射。避免激光束照射。</p> <p>注意 - ここを開くと可視及び不可視のレーザー光が出ます。ビームを直接見たり、照らしたりしないでください。 RQLS0233</p>	(Inside of product)
---	---------------------

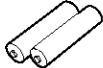

Accessories

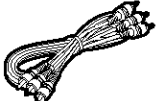
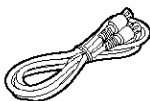
Please check and identify the supplied accessories. Use numbers indicated in parentheses when asking for replacement parts.
Only for U.S.A.: To order accessories contact 1-800-332-5368 or web site (<http://www.panasonic.com>).
Only for Canada: To order accessories, call the dealer from whom you made your purchase.

- 1 Remote control (EUR7615KF0) 
- 2 Batteries for remote control 
- 1 AC power supply cord (RJA0065-A) 
- 1 Audio/Video cable (VJA0788) 
- 1 75 Ω coaxial cable (VJA1091) 
- 1 Cleaning cloth for cleaning the mirror section on the front of the unit (RFE0088-1) 
- 1 DVD-RAM disc 

Note
 The included AC power supply cord is for use with this unit only. Do not use it with other equipment.
(U.S.A. only)
Product Registration Card
 Please complete and return the included product registration card, or register via the Internet at: <http://www.prodreg.com/panasonic/>

IMPORTANT SAFETY INSTRUCTIONS

Read these operating instructions carefully before using the unit. Follow the safety instructions on the unit and the applicable safety instructions listed below. Keep these operating instructions handy for future reference.

- 1) Read these instructions.
- 2) Keep these instructions.
- 3) Heed all warnings.
- 4) Follow all instructions.
- 5) Do not use this apparatus near water.
- 6) Clean only with dry cloth.
- 7) Do not block any ventilation openings. Install in accordance with the manufacturer's instructions.
- 8) Do not install near any heat sources such as radiators, heat registers, stoves, or other apparatus (including amplifiers) that produce heat.
- 9) Do not defeat the safety purpose of the polarized or grounding-type plug. A polarized plug has two blades with one wider than the other. A grounding-type plug has two blades and a third grounding prong. The wide blade or the third prong are provided for your safety. If the provided plug does not fit into your outlet, consult an electrician for replacement of the obsolete outlet.
- 10) Protect the power cord from being walked on or pinched particularly at plugs, convenience receptacles, and the point where they exit from the apparatus.
- 11) Only use attachments/accessories specified by the manufacturer.
- 12) Use only with the cart, stand, tripod, bracket, or table specified by the manufacturer, or sold with the apparatus. When a cart is used, use caution when moving the cart/apparatus combination to avoid injury from tip-over.
- 13) Unplug this apparatus during lightning storms or when unused for long periods of time.
- 14) Refer all servicing to qualified service personnel. Servicing is required when the apparatus has been damaged in any way, such as power-supply cord or plug is damaged, liquid has been spilled or objects have fallen into the apparatus, the apparatus has been exposed to rain or moisture, does not operate normally, or has been dropped.



This unit has an internal hard disk capable of recording and playback (referred to hereon as HDD). In order to prevent damage to the HDD or to hard disk contents, the recording of noise or interruption of normal functioning, you are advised to take the following precautions when installing or using the unit:

- Do not expose to vibration or rough treatment.
- Do not place in an enclosed area so that the rear cooling fan and the cooling vents on the side are covered up.
- Do not place in an area where the changes in temperature are extreme. Sudden, extreme changes in temperature may cause condensation (→below). Using the unit when there is condensation inside will damage the HDD and may lead to breakdown. Use of the unit in areas subject to temperature changes of more than 20 degrees an hour is not recommended.
- Do not place in areas with high humidity.
- Do not place the unit in any orientation other than horizontal.
- Do not disconnect the AC plug from the household AC outlet while the unit is on, shut off the electricity supply to the area in which the unit is installed or move the unit while it is on.
 - If moving the unit, first turn the power "OFF"* and remove the AC plug from the household AC outlet. Wait 2 minutes before moving.
 - * Press [⏻, DVD POWER] and confirm that "BYE" disappears from the display.

- **Conditions contributing to the occurrence of condensation**
In any of the cases listed below, allow the unit to adjust to the room temperature by leaving it for approximately 2 hours with the power on.
 - When the room is steamy or the humidity is high
 - If there is a sudden change in temperature, for example:
 - The unit is moved from a cold to a warm place or vice versa.
 - A heater is used to warm the area up quickly in winter or an air conditioner is used to cool the area quickly in summer.
 - The air from an air conditioner flows directly onto the unit (please take action to ensure this does not happen).

- **In the event of a power failure**
If a power failure occurs, contents in the process of playback/recording as well as already recorded, saved or dubbed HDD contents may be damaged.

- **Safeguards against accidental loss**
Data may be lost if the HDD suffers damage. Any contents you wish to keep permanently should be dubbed or transferred to DVD-RAM or DVD-R.

The HDD in this unit reserves a part of the storage space for use as a system management area.

Before moving the unit, ensure the disc tray is empty. Failure to do so will risk severely damaging the disc and the unit.

In order to maximize the efficacy of recording using this unit, a variable bit rate recording system is used. This system may sometimes show the amount of time remaining for recording as being more or less than the amount of time remaining.

- If the remaining time is insufficient, erase any unwanted programs to create enough space before starting recording.
- When erasing programs, you should aim to create ample space on the storage media for the intended program. This is because the time available for recording may not increase in exact proportion to the time represented by the programs you erase.

CAUTION:
TO PREVENT ELECTRIC SHOCK MATCH WIDE BLADE OF PLUG TO WIDE SLOT, FULLY INSERT.

Do not place the unit on amplifiers or equipment that may become hot.

The heat can damage the unit.

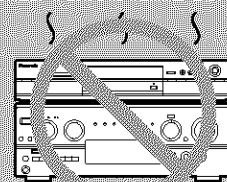

CAUTION!
DO NOT INSTALL, OR PLACE THIS UNIT, IN A BOOKCASE, BUILT-IN CABINET OR IN ANOTHER CONFINED SPACE. ENSURE THE UNIT IS WELL VENTILATED. TO PREVENT RISK OF ELECTRIC SHOCK OR FIRE HAZARD DUE TO OVERHEATING, ENSURE THAT CURTAINS AND ANY OTHER MATERIALS DO NOT OBSTRUCT THE VENTILATION VENTS.

DO NOT PLACE THIS APPARATUS INTO AN AUDIO RACK, BOOK SHELF OR SIMILAR LOCATION BECAUSE OF HEAT FROM THIS APPARATUS.

DO NOT BLOCK ANY OF THE VENTILATION OPENINGS. INSTALL IN ACCORDANCE WITH THE MANUFACTURER'S INSTRUCTIONS.

THE FOLLOWING APPLIES ONLY IN THE U.S.A.
Note to CATV system installer:

This reminder is provided to call the CATV system installer's attention to Article 820-40 of the NEC that provides guidelines for proper grounding and, in particular, specifies that the cable ground shall be connected to the grounding system of the building, as close to the point of cable entry as practical.

Features

This unit allows recording of high quality video on HDD and DVD-RAM, the compact and durable digital media with fast random access. This media also out performs past tape formats in ease of operation.

■ Maximum 52 hours on HDD (Hard Disk Drive) (→page 19)

This model is installed with a high capacity 40 GB hard disk capable of recording a maximum of 52 hours (6 hours continuously). The same functions are available with HDD as with DVD-RAM and editing/recording of visual data from hard disk to DVD-RAM/R is easy-to-perform.

■ DV Automatic Recording (→page 31)

Simply connect a digital video camera using a single cable and you can organize your DV tapes into play lists on the HDD or DVD-RAM. (You cannot connect a personal computer to the unit.)

■ Auto Renewal Recording (→page 36)

If you record a program onto HDD repeatedly everyday or every week using timer recording, the unit will record the new program over the old one.

■ Relief Recording (→page 35)

When timer recording to DVD-RAM or DVD-R, the unit will compare the remaining space on the disc and the time necessary for recording. If space is insufficient the unit will record the program to HDD instead (there is no relief recording function the other way, i.e. from HDD to DVD-RAM or DVD-R).

■ Enjoy still pictures (JPEG) (→pages 25 and 46–49)

- It is possible to display still pictures (→page 9) taken with a digital camera either in a list or one by one.
- It is possible to save still pictures from a PC card onto DVD-RAM (also onto HDD).
- You may alter the print settings (DPOF) for still pictures from a PC card.

■ Watch a program while you are recording it (→page 21) **HDD RAM**

Chasing play

You can watch a program from the start while you are still recording it. **Simultaneous rec and play**

You can record a program while watching one you recorded previously.

Time Slip

- You can jump back to review a piece of action you missed while recording by pressing the time slip button (can be set between 1 minute and 999 minutes with HDD, 1 minute and 360 minutes with DVD-RAM in units of one minute.)
- During playback, it is possible to jump an amount of time (specified by you) to the scene you wish to view.

■ Maximum 12 hours on DVD-RAM

- Using a double sided, 9.4 GB DVD-RAM allows you to record a maximum of 12 hours (6 hours continuously).
- When using a 4.7 GB DVD-RAM or a DVD-R, you can get 1 hour recording using the XP high picture quality mode, 2 hours with the regular SP mode, 4 hours with the long LP mode, and 6 hours with the extra long EP mode.
- You can also use the FR (Flexible Recording) mode to fit recordings efficiently onto the available space on the disc (→page 19).

■ Make your own DVD-Video

- Finalizing a DVD-R that has been recorded on produces an original DVD-Video in accordance with DVD-Video standards (→page 8).
- In addition to DVD-Video movie software, this unit can also play other types of discs including audio CDs and Video CDs. This means that this unit has the potential to play a central role in your home entertainment, from high-end home theater through to CD playback.

■ Exceptional sound and picture quality when recording

- Audio is recorded using Dolby Digital stereo, enabling high quality sound recordings. When recording in XP mode it is possible to use LPCM (2 channel) to achieve sound recordings of even higher quality.
- The encoder system used for recording is called "Hybrid VBR" and allows high quality recordings.

■ Progressive Scan

By connecting the component video terminal of this unit to a progressive scan television, it is possible to enjoy the high quality picture rendered by the progressive scan function.

■ Fast access to the program you want to watch (→page 26) **HDD RAM DVD-R**

Use the Direct Navigator to find a program you have recorded and start play.

■ Editing your recording **HDD RAM**

- It is possible to divide up a recorded program (→page 40).
- Use play lists (→page 27) to select your favorite scenes and rearrange them to play in any order you like.

■ The FUNCTIONS window shows you most of the features you can use (→page 53)

The FUNCTIONS window has most of the features and functions you are likely to use regularly. Just select the icon for the operation you want to perform.

Explanatory notes

Symbols used in these operating instructions

■ Troubleshooting



is used to indicate ways to fix potential problems.

■ Discs you can use

The features you can use with the different types of discs are indicated as follows.



For your reference

- **DVD-R** indicates DVD-R that have not yet been finalized (→page 38). DVD-R that have been finalized can use the same features as DVD-Video. (Refer to features indicated **DVD-V**.)
- Functions that can use the PC card (→page 9) are indicated by **CARD**.

Operation

- These operating instructions describe operations mainly using the remote control.
- The explanations herein are given on the basis that the connecting up (→pages 11 and 55-59) and settings have already been carried out as prescribed in this manual.

Displays

The displays shown in these instructions are examples only. Actual displays depend on the disc or card and the operations you are performing.

Should the AC power supply cord come loose by accident or for any other reason the power supply is cut off while recording or editing is taking place, the contents of the HDD or disc may be lost.

Table of contents

Getting started

Accessories	2
IMPORTANT SAFETY INSTRUCTIONS	3
Features	4
Explanatory notes	4
Control reference guide	6
Disc information	8
PC card	9
Still pictures (JPEG)	9
Disc handling	10

Setting up

STEP 1 The remote control	10
STEP 2 Antenna and television connections	11
STEP 3 Plug-in Auto Tuning	12
If Plug-in Auto Tuning fails	13
Adding and deleting channels	13
STEP 4 VCR Plus+ guide channel settings	14
Other channel settings	15
STEP 5 Selecting TV screen type	16
STEP 6 Television operation	17

Recording

Recording television programs	18
Inserting discs	18
Notes on recording	19
Watching the television while recording	20
Flexible Recording	
—recording the best quality pictures in a set time	20
One Touch Recording—Specify a time to stop recording	20
Playing while you are recording	21
Playing from the beginning of the program you are recording	
—Chasing play	21
Simultaneous rec and play	21
Reviewing the recorded images while recording	
—Time Slip	21

Playing back

Playing discs	22
When a menu screen appears on the television	23
Starting play from where you stopped it	
—Resume Function	23
Skipping programs and commercials	24
Skipping	24
Starting play from a selected program, title,	
chapter, or track	24
Selecting an amount of time to skip—Time Slip	24
Skipping a minute forward—CM Skip	24
Playing still pictures (JPEG)	25
Using the Direct Navigator	26
To erase a program that is being played back	26
Playing play lists	27
Playing play lists	27
Playing play list scenes	27
To erase a play list or a play list scene during playback	27
Other methods of play	28
Marking positions directly—MARKER	28
Using on-screen menus to mark positions	28
Program play	29
Random play	29
Fast forward and rewind—SEARCH	29
Slow-motion play	29
To play DVD-R recorded on this unit on other players	29
Changing audio	30

Dubbing

Recording from an external device	31
Recording from a video cassette recorder	31
DV Automatic Recording (DV AUTO REC)	31
Dubbing programs or play list	32
One Touch Dubbing (HDD → DVD)	33

Timer recording

Timer recording	34
Using VCR Plus+ codes to make timer recordings	34
Manually programming timer recordings	35
Auto Renewal Recording	36
Check programs	36
Change or delete the program	37

Editing

HDD, Disc setting	38
Editing programs	40
Editing play lists	42
Creating play lists	44
Entering text	45
Editing still pictures (JPEG)	46

Advanced operation

Using on-screen menus	50
Common procedures	50
Disc menu	50
Play menu	51
Audio menu	51
Video menu	52
Using the FUNCTIONS window	53
On-screen displays	54
Changing the information displayed	54
Display examples (HDD)	54
Home Theater	55
Connecting a cable TV box/satellite receiver	56
Connecting an amplifier or system component	57
Connecting other video equipment	58
Other antenna connections	59
Other antenna connection to the unit	59
Other antenna connection from the unit to the television	59
Changing the unit's settings	60
Summary of settings	60
Common procedures	62
Entering a password (Ratings)	62
Digital Audio Output	62
Audio channel for DV input	63
Clock settings	64
Changing the remote control code	65

Reference

Glossary	66
Error messages	67
Troubleshooting guide	68
Maintenance	70
Specifications	71
Product Service	71
Limited Warranty (ONLY FOR U.S.A.)	72
Limited Warranty (ONLY FOR CANADA)	73
Guía de referencia rápida en español	
(Spanish Quick Reference)	74
Index	Back cover

Remote control

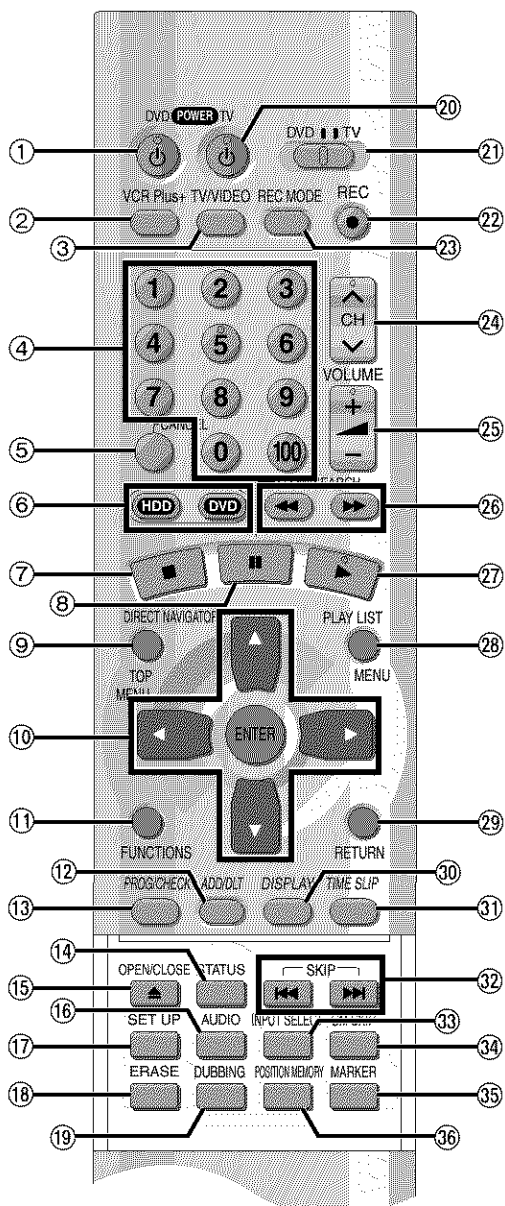

How to open the remote control

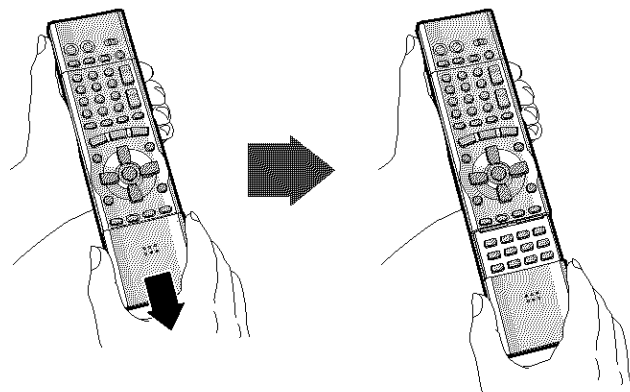

Hold both sides of the remote control's cover to open it. (You can also open it by pressing on the center of it and sliding it down.)

- ① **POWER button** (⏻, DVD **POWER**) 12
Press to switch the unit from on to standby mode or vice versa. In standby mode, the unit is still consuming a small amount of power.
- ② **VCR Plus+ button** (VCR Plus+) 34
- ③ **Television input mode selector** (TV/VIDEO) 17
- ④ **Numbered buttons** (1–9, 0, 100)
• See also DVD/TV switch (⑳).
• When selecting a title, chapter, track, program, or play list
RAM **DVD-R** **DVD-V** **CD** **VCD**
e.g., "5": [0] → [5]
"15": [1] → [5]
• When selecting a hard disk item, a page of play list scene, or a still picture
CARD **HDD** **RAM**
e.g., "5": [0] → [0] → [5]
"15": [0] → [1] → [5]
• When selecting a television channel
e.g., "5": [0] → [5]
"15": [1] → [5]
"115": [100] → [1] → [5]
- ⑤ **Cancel button** (CANCEL) 29
- ⑥ **Drive select buttons** (HDD, DVD) 19
- ⑦ **Stop button** (■) 19
- ⑧ **Pause button** (⏸) 19
- ⑨ **Top menu and Direct Navigator button** (TOP MENU, DIRECT NAVIGATOR) 23, 26
- ⑩ **Cursor buttons** (▲, ▼, ◀, ▶)/Enter button (ENTER) 13
- ⑪ **Functions button** (FUNCTIONS) 53
- ⑫ **Manual channel adding and deleting button** (ADD/DLT) 13
- ⑬ **Manual programming and check button** (PROG/CHECK) 35
- ⑭ **On-screen display button** (STATUS) 54
- ⑮ **Disc tray open/close button** (▲ OPEN/CLOSE) 19
- ⑯ **Audio button** (AUDIO) 30
- ⑰ **Setup button** (SET UP) 13
- ⑱ **Program/play list/still picture erase button** (ERASE) 25, 26, 27
- ⑲ **Dubbing button** (DUBBING) 33
- ⑳ **TV power on/off button** (⏻, **POWER** TV) 17
- ㉑ **DVD/TV switch** (DVD, TV) 17
• When selecting the receiving channel on this unit using channel button (㉒) and numbered buttons (④) or inputting using numbered buttons (④), make sure you switch [DVD, TV] to "DVD".
• When selecting the receiving channel for the television using channel button (㉒) and numbered buttons (④), make sure you switch [DVD, TV] to "TV".
- ㉒ **Recording button** (● REC) 19
- ㉓ **Recording mode button** (REC MODE) 19
- ㉔ **Channel buttons for recorder and TV** (▲ ▼, CH) 17, 19
- ㉕ **TV volume buttons** (+, –, VOLUME) 17
- ㉖ **Slow/search buttons** (◀◀, ▶▶ SLOW/SEARCH) 29
- ㉗ **Play button** (▶) 23
- ㉘ **Menu and Play List button** (MENU, PLAY LIST) 23, 27
- ㉙ **Return button** (RETURN) 13
- ㉚ **Display button** (DISPLAY) 50
- ㉛ **Time slip button** (TIME SLIP) 21
- ㉜ **Skip buttons** (◀◀, ▶▶ SKIP) 24
- ㉝ **Input select button** (INPUT SELECT) 31
- ㉞ **One-minute skip button** (CM SKIP) 24
- ㉟ **Marker button** (MARKER) 28
- ㊱ **Position memory button** (POSITION MEMORY) 23

Main unit

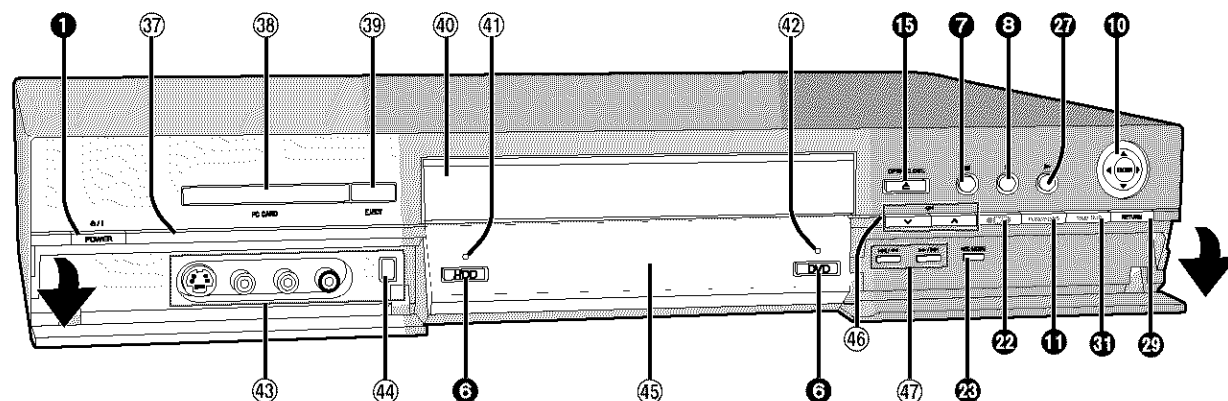

Controls such as ❶ function the same as the buttons on the remote control.

❶ Remote control signal sensor	10	❸ L2 input terminals (L2)	58
❷ PC card slot (PC CARD)	25	❹ DV input terminal (DV INPUT)	58
❸ Card eject button (EJECT)	25	❺ Display	
❹ Disc tray	18	❻ Channel buttons for recorder (v ^, CH)	19
❺ HDD record lamp	18	❼ Skip/Slow/Search buttons (⏪/⏩, ⏮/⏭)	24, 29
❻ DVD record lamp	18		
		❻ L2 input terminals (L2)	58
		❼ DV input terminal (DV INPUT)	58
		❽ Display	
		❾ Channel buttons for recorder (v ^, CH)	19
		❼ Skip/Slow/Search buttons (⏪/⏩, ⏮/⏭)	24, 29

The unit's display

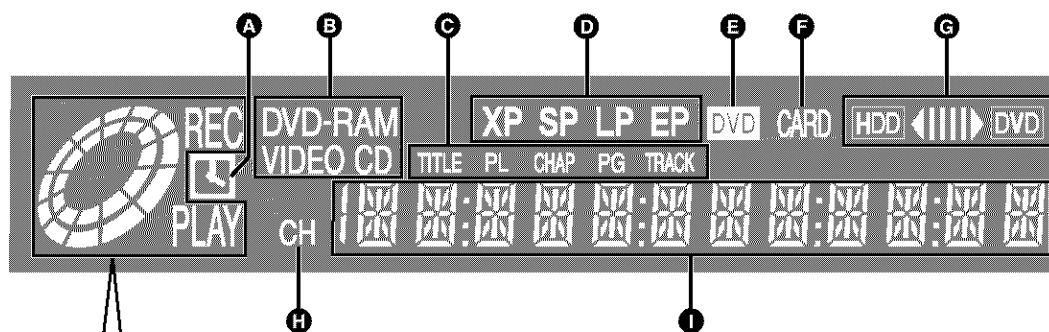

Center circle (e.g., DVD-RAM)

Rotating (REC): recording

Stopped (REC): recording paused



Rotating (REC, PLAY):

Chasing play or simultaneous rec and play is in progress



Rotating (PLAY): playing

Stopped (PLAY): play paused

"PLAY" flashes:
the resume function (→page 23)
is working



A Timer recording display

On: When timer recording is on standby (→page 34)

Flashes: When the unit couldn't go to timer recording standby

B Disc type

C The display mode of the main display section

TITLE: Title number

CHAP: Chapter number

TRACK: Track number

PG: Program number

PL: Play list number

D Recording mode (→page 19)

E DVD indicator

Flashes: When you press [⏻, DVD POWER] to turn the unit off until it actually turns off

F Card indicator

On: When a PC card is set in the unit (→page 25)

Flashes: When a PC card is being read/written to

G Dubbing direction indicator

H Channel



I Main display section

Recording and play counter, and other miscellaneous messages

Note

A half mirror is used for the unit display so the display may occasionally be difficult to see depending on surrounding conditions.

Discs you can use for recording and play

	
DVD-RAM 4.7 GB/9.4 GB, 12 cm (5") 2.8 GB, 8 cm (3")	DVD-R 4.7 GB for General Ver. 2.0

- This unit is not compatible with:
 - 12-cm (5"), 2.6- and 5.2-GB DVD-RAM
 - 3.95- and 4.7-GB DVD-R for Authoring
 - DVD-RAM not recorded following the Video Recording Standard
 - Unfinalized DVD-R recorded on other equipment
- This unit is compatible with the Content Protection for Recordable Media (CPRM → page 66) system so you can record broadcasts that allow one copy, such as some CATV broadcasts, onto 4.7 GB/9.4 GB DVD-RAM (these are CPRM compatible). It is not possible to record onto DVD-R or 2.8-GB DVD-RAM.
- We recommend using Panasonic discs as they have been confirmed to be compatible with this unit. Other discs may not perform correctly.
- Do not allow the disc to become dirty or scratched. Fingerprints, dirt, dust, scratches or deposits of cigarette smoke on the recording surface may make it impossible to use the disc for recording.
- Discs with programs recorded in PAL already cannot be recorded on using this unit.

DVD-RAM

- **DVD-RAM recorded on this unit may not be compatible with other DVD players, including some Panasonic players. Consult the manual for the player to determine compatibility with these DVD-RAM disc.**
- This unit is compatible with both non-cartridge and cartridge DVD-RAM, but the write-protect tabs on cartridge-type discs give better protection to your recordings.
- Picture aspect ratios, regular 4:3 or widescreen 16:9, are recorded as they are received.

DVD-R

- **In order to play a DVD-R recorded using this unit on another playback source, the disc must first be finalized (→page 38).**
- Once a DVD-R is finalized, it becomes DVD-Video.
- You can record onto the available space on the disc and perform editing functions, such as giving titles to discs and programs and erasing programs before finalizing.
- When programming is erased from a DVD-R, that space does not become available. Once an area on a DVD-R is recorded on, that area is no longer available for recording, whether the recording is erased or not.
- It takes about 30 seconds for the unit to complete recording management information after recording finishes.
- This unit optimizes the DVD-R for each recording. Optimizing is carried out when you start recording after inserting the disc or turning on the unit. Recording onto the disc may become impossible if optimizing is carried out too many times.
- Play may be impossible in some cases due the condition of the recording.
- The video is recorded in a 4:3 aspect irrespective of the video signal input.



Play-only discs

			
DVD-Video		Audio CD	Video CD

- The producer of the material can control how DVD-Video and Video CDs are played. This means that you may not be able to control play of a disc with some operations described in these operating instructions. Read the disc's instructions carefully.
- This unit can play CD-DA (digital audio) and Video CD format (Video CD Format 2.0 or above), audio CD-R and CD-RW that have been finalized upon completion of recording. It may not be able to play some CD-R or CD-RW due to the condition of the recording.
- This unit cannot record onto CD-R or CD-RW.

DVD-Video

- **Audio format**

	Dolby Digital (→page 66) This unit can play Dolby Digital in stereo (2 channels). Connect an amplifier with a built-in Dolby Digital decoder to enjoy surround sound.
	DTS Digital Surround (→page 66) Connect this unit to equipment that has a DTS decoder to enjoy DVDs with this mark.

Discs that cannot be played

- DVD-Video with a region number other than "1" or "ALL"
- Some DVD-RAM (→left) • Some DVD-R (→left) • PAL discs
- DVD-ROM • DVD-RW • DVD-Audio • +RW • CD-ROM • CDV
- CD-G • Photo CD • CVD • SVCD • SACD • MV-Disc • PD
- Divx Video Disc, etc.

Protection



You can protect the contents of your discs in the following ways.

- **Cartridge-protect:**
With the write-protect tab in the protect position, you cannot record to, edit, or erase from the disc. (Type 1, 2, and 4 cartridge discs)
- **Disc-protect (→page 38)**
- **Program-protect (→page 40)**

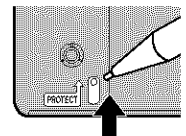

The manufacturer accepts no responsibility and offers no compensation for loss of recorded or edited material due to a problem with the HDD or disc, and accepts no responsibility and offers no compensation for any subsequent damage caused by such loss.

Examples of causes of such losses are:

- A disc recorded and edited with this unit is played in a DVD recorder or computer disc drive manufactured by another company.
- A disc used as described above and then played again in this unit.
- A disc recorded and edited with a DVD recorder or computer disc drive manufactured by another company is played in this unit.

PC card

PC cards capable of displaying and saving

- SD Memory Card*
- Multi Media Card*
- Compact Flash*
- Smart Media*
- Memory Stick*
- ATA Flash PC card

*A PC card adapter conforming to PC card standards is necessary.

- **Compatible with:** FAT 12 or FAT 16
- This unit is compatible with Type II PC cards. Do not insert any other type of PC card.
- This unit is not compatible with card type hard disks (Microdrives etc).
- Use this unit to format a PC card when using for the first time (→page 48). Note that the PC card may no longer be usable on other equipment once formatted on this unit.
- This unit operates in accordance with the Digital Print Order Format (→ DPOF, page 66). (PC card only)
- Only use the memory cards recommended above.

■ Regarding Write Protect

For cards that come provided with a write protect switch, if the switch is on it will not be possible to write, erase or format the card.

■ The card indicator (CARD) in the display

Please carry out insertion and removal of the PC card after turning the unit off.

The indicator flashes when the data is being written to or read from the card. Do not turn off the power or remove the card at such a time. Should you do so, the unit may malfunction or the contents of the card may be damaged.

Still pictures (JPEG)

- This unit is compatible with DCF* based, still picture (JPEG) files recorded using a digital camera.

*Design rule for Camera File system: unified standard established by Japan Electronics and Information Technology Industries Association (JEITA).

• Picture definition:

Compatible in the range 320 × 240 – 6144 × 4096 (sub sampling is 4:2:2 or 4:2:0)

- This unit can handle a maximum of **300 folders** (including header folders) and **3,000 files**. Files and folders with numbers which exceed the maximum cannot be displayed, copied or erased.
- This unit displays only still pictures conforming to DCF standards and JPEG still pictures. It cannot display moving pictures, MOTION JPEG and other such formats, still pictures other than JPEG (i.e. TIFF) or play associated sound.
- When there are a lot of folders and files, it may take a long time to display, copy or erase.
- Folder titles that were input on equipment other than this unit may not be displayed properly.
- When saving still pictures on HDD, it is recommended that you copy them to the PC card or DVD-RAM also. (→ page 46).

Folders that can be displayed/saved



Still pictures (denoted as Filename : xxxxxxxx.JPG) saved

in folders () as shown below can be displayed/saved.

Folders (including the still pictures inside those folders) below the compatible folder cannot be displayed or saved.

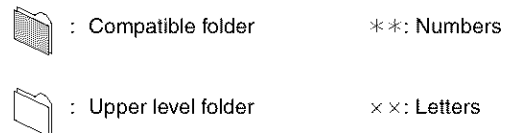

• PC card

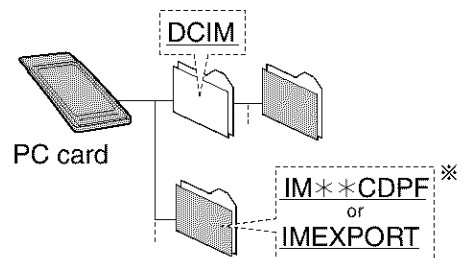

• DVD-RAM

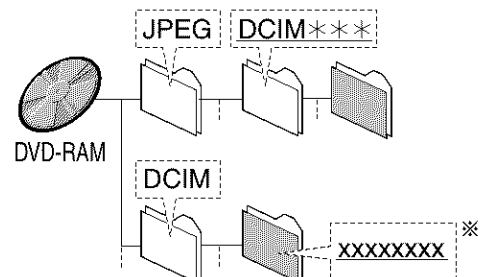

Note

- You may select any underlined folder for display. (→page 46).
- Copying cannot be carried out to folders (※) made on other equipment (→page 46).
- The folder cannot be displayed if the numbers are all "0" (e.g., DCIM 000 etc).

Do not use irregularly shaped discs, such as heart-shaped. (These can damage the unit.)

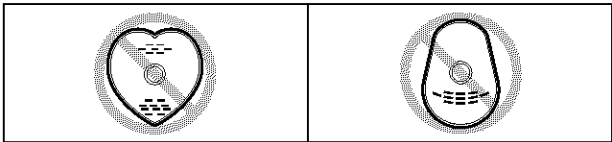

How to hold a disc

Do not touch the recorded surface.

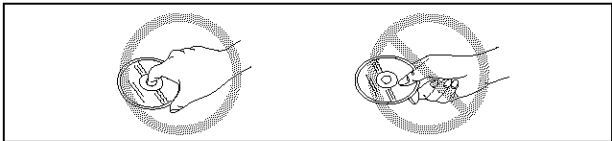

If there is dirt or condensation on the disc



Moisture may condense on discs after they are brought inside from the cold.

DVD-RAM and DVD-R

Clean only with the DVD-RAM/PD disc cleaner available as an optional accessory, part number LF-K200DCA1.

Do not use cleaners or cloths for CDs to clean DVD-RAM and DVD-R.

DVD-Video, CD, Video CD

Wipe with a damp cloth and then wipe dry.

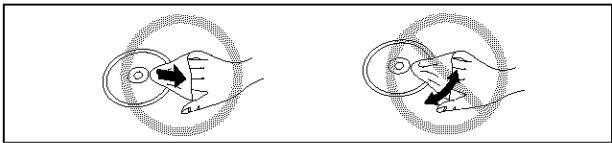

Handling precautions

- Do not write on the label side with a ball-point pen or other writing instrument.
- Do not use record cleaning sprays, benzene, thinner, static electricity prevention liquids or any other solvent.
- Do not attach labels or stickers to discs. (Do not use discs with exposed adhesive from tape or left over peeled-off stickers.)
- Do not use scratch-proof protectors or covers.
- Do not use discs printed with label printers available on the market.
- Do not use discs that are badly warped or cracked.

Do not place or store discs in the following places

- Locations exposed to direct sunlight
- Humid or dusty locations
- Locations directly exposed to a heat vent or heating appliance

STEP 1 The remote control

Batteries

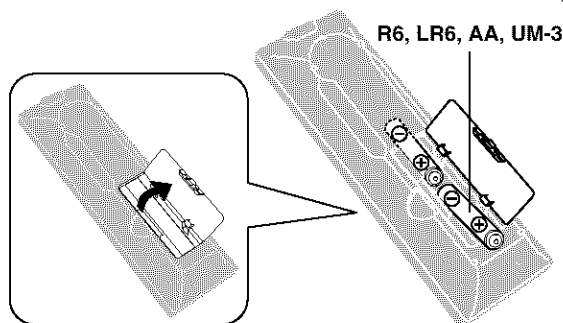

- Insert so the poles (+ and -) match those in the remote control.
- Do not use rechargeable type batteries.

Do not:

- mix old and new batteries.
 - use different types at the same time.
 - heat or expose to flame.
 - take apart or short circuit.
 - attempt to recharge alkaline or manganese batteries.
 - use batteries if the covering has been peeled off.
- Mishandling of batteries can cause electrolyte leakage which can damage items the fluid contacts and may cause a fire.

Remove if the remote control is not going to be used for a long period of time. Store in a cool, dark place.

Note

If you cannot operate the unit or television using the remote control after changing the batteries, please re-enter the codes (television → page 17, main unit → page 65).

Use

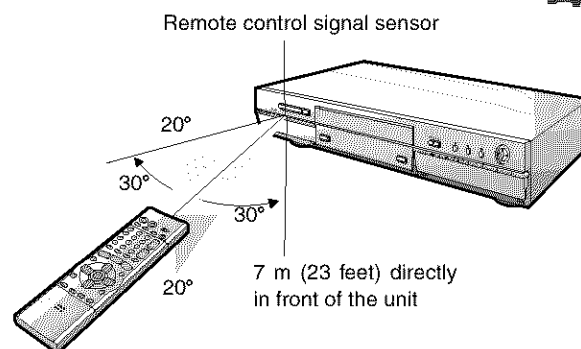

Aim at the sensor avoiding obstacles, at a maximum range of 7 m (23 feet) directly in front of the unit.

STEP 2 Antenna and television connections

Preparation

- Refer to the television's operating instructions.
- Turn the television off and disconnect its AC power supply cord.

To enjoy sound through other audio equipment

You can output digital signals from this unit's DIGITAL AUDIO OUT terminal, enabling you to enjoy the powerful surround effects found on discs recorded with Dolby Digital or DTS. Connect an amplifier with built-in decoders. See page 57 for connection examples.

To enjoy CATV (→page 56)

(You need to subscribe to a cable TV or satellite TV service to enjoy viewing their programming.)

To enjoy progressive video

- Connect to the component video (480P) input terminals on a television compatible with this unit's copy guard system. (Video will not be displayed correctly if connected to an incompatible television.)
- Set "TV Type" to "480P" in STEP 5 Selecting TV screen type (→page 16).
- When playing back, select Video in the on-screen menu and set "Transfer" according to the type of material being played (→page 52).

For your reference

All Panasonic televisions that have 480P input terminals are compatible. Consult the manufacturer if you have another brand of television.

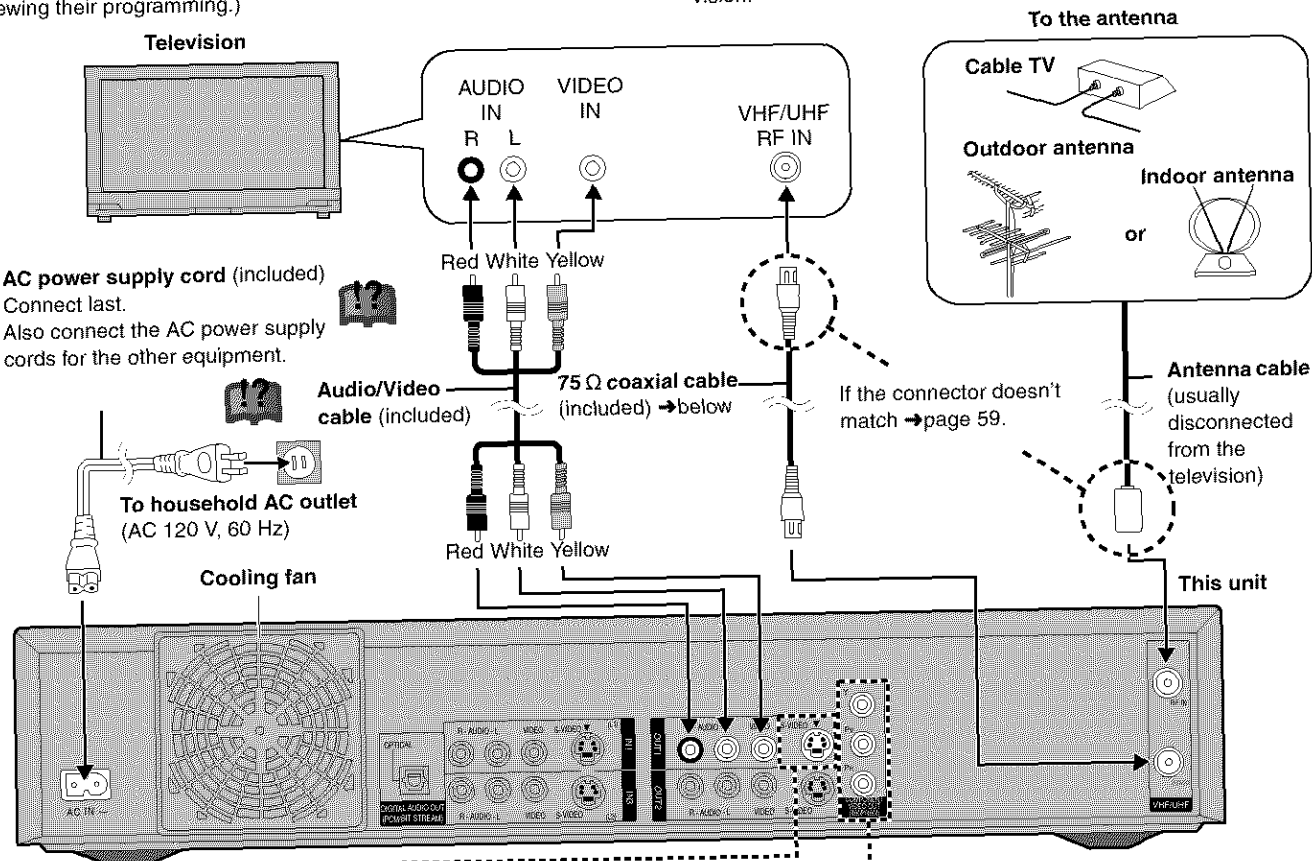

S-VIDEO OUT terminal

The S-VIDEO OUT terminal achieves a more vivid picture than the VIDEO OUT terminal by separating the chrominance (C) and luminance (Y) signals. (Actual results depend on the television.)

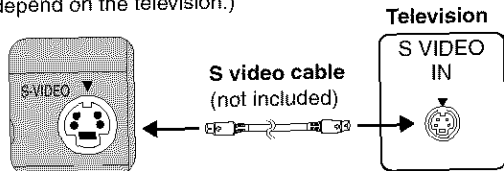

When making this connection, ensure you connect the audio cables to the corresponding audio input terminals on the television.

75 Ω coaxial cable

- The signal from the antenna passes through this unit and along the 75 Ω coaxial cable to the television even when this unit is turned off. You don't have to connect the antenna to the television.
- The picture and sound signal from this unit does not go through the 75 Ω coaxial cable to the television. Make sure you connect one of the following terminals on this unit to the television: the AUDIO/VIDEO terminal, the S-VIDEO OUT terminal or the COMPONENT VIDEO OUT terminal. If the television has none of these terminals, consult your local dealer.

Conserving power

This unit consumes a small amount of power, even when it is off (standby). To save power when the unit is not to

COMPONENT VIDEO OUT terminal

These terminals can be used for either interlace or progressive output and provide a purer picture than the S-VIDEO OUT terminal. Connection using these terminals outputs the color difference signals (P_B/P_R) and luminance signal (Y) separately in order to achieve high fidelity in reproducing colors.

- The description of the component video input terminals depends on the television or monitor (e.g. Y/P_B/P_R, Y/B-Y/R-Y, Y/C_B/C_R). Connect to terminals of the same color.

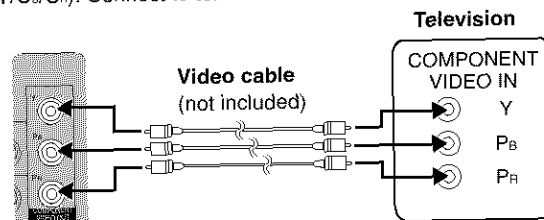

When making this connection, ensure you connect the audio cables to the corresponding audio input terminals on the television.

Do not connect the unit through a video cassette recorder

Video signals fed through video cassette recorders will be affected by copyright protection systems and the picture

STEP 3 Plug-in Auto Tuning

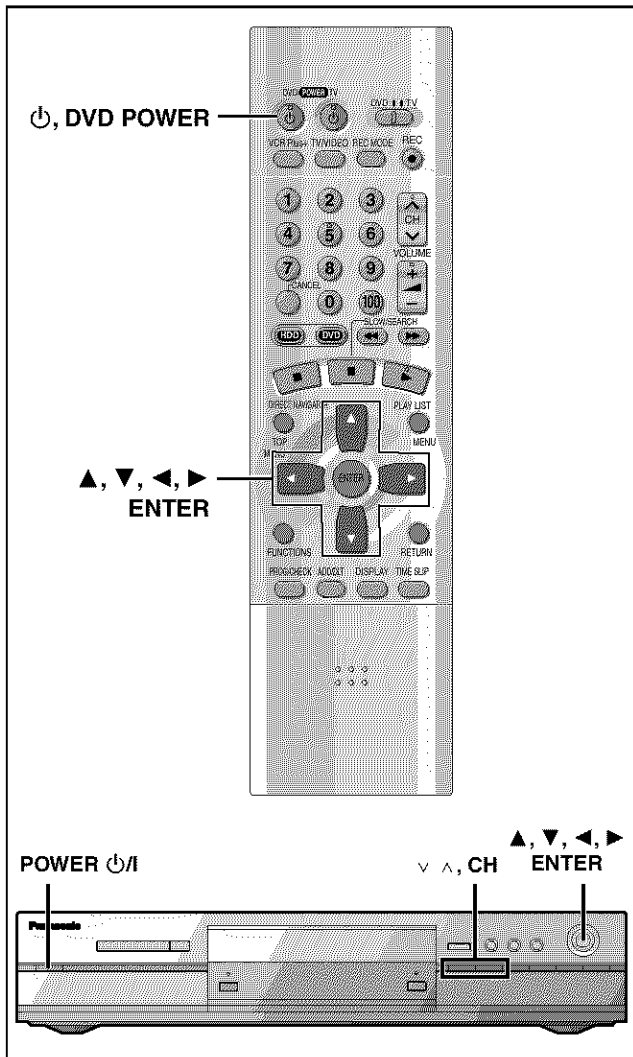

After plugging the unit into your household AC outlet and pressing [⏻, DVD POWER] to turn the unit on for the first time, the unit automatically tunes in all the channels it can receive and sets the clock.

The unit automatically determines the type of transmission (air or cable) and puts them into channels as follows.

• **TV Mode**

Band	Air
VHF	2-13
UHF	14-69

• **CATV Mode**

Band	Cable
VHF	2-13
CATV LOW BAND	95-99
CATV MID/SUPER BAND	14-36
CATV HYPER BAND	37-65
ULTRA BAND	66-94 100-125
SPECIAL CATV CHANNEL	1

Preparation

- Confirm that the antenna is connected correctly.
- Turn on the television and select the appropriate video input to suit the connections to this unit.

1 Press [⏻, DVD POWER] to turn the unit on.

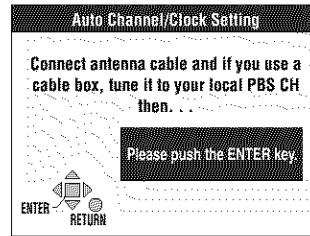

2 Press [ENTER].

Plug-in Auto Tuning starts and the unit puts the stations it can receive into channels.

The unit then proceeds with Auto Clock Setting. The time is displayed when finished. If the clock is an hour slower or faster than the actual time, go to "Time Zone Adjust" to correct it (→page 64).

3 When the display shows the correct time Press [ENTER] to complete Plug-in Auto Tuning.

If the unit couldn't find any channels

Press [ENTER] to start Plug-in Auto Tuning again. If the channels still aren't tuned, set "Antenna System" manually and proceed to "Auto Channel Setting" (→page 13, "If Plug-in Auto Tuning fails").

If unnecessary channels are set or necessary channels are not set

Refer to page 13, "Adding and deleting channels".

If the unit couldn't set the clock automatically

Press [ENTER] to show the "Manual Clock Setting" screen. Set the time manually (→page 64).

To start Plug-in Auto Tuning again (after relocation, for example)

Antenna system, channel caption, and VCR Plus+ guide channel settings all revert to the default values when you perform the procedure below. Timer recording settings are also cleared.

When the unit is on and stopped

- ① **Press and hold [v, CH] and [^, CH] on the main unit for about five seconds.**
The unit turns off.
- ② **Press [⏻, DVD POWER] to turn the unit on.**
Press [ENTER] to start Plug-in Auto Tuning.

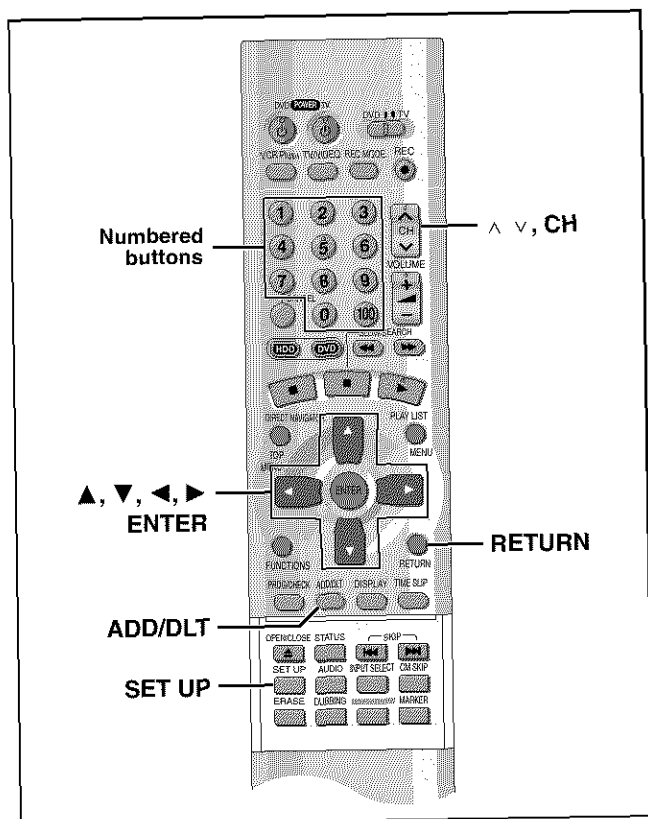

If Plug-in Auto Tuning fails

- 1 Press [SET UP] to show the menus.

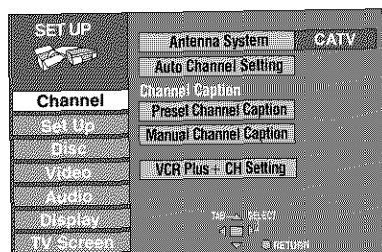

- 2 Press [▲, ▼] to select "Channel" and press [▶].

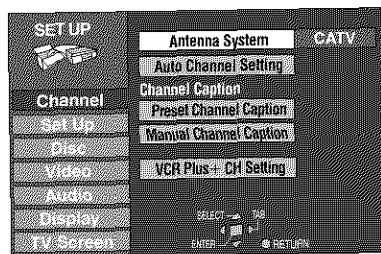

- 3 Press [▲, ▼] to select "Antenna System" and press [ENTER].

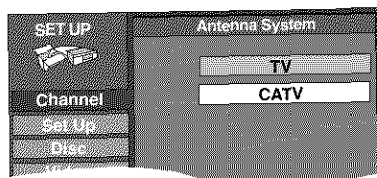

- 4 Press [▲, ▼] to select "TV" or "CATV" and press [ENTER].

TV:TV broadcast (2CH-69CH)

CATV:CATV broadcast (1CH-125CH)

The screen shown in step 2 reappears.

- 5 Press [▲, ▼] to select "Auto Channel Setting" and press [ENTER].

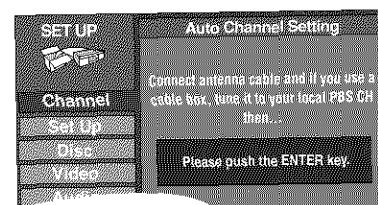

If you have not yet set the clock, the "Auto Channel/Clock Setting" screen appears.

- 6 Press [ENTER].

Auto setting starts. This takes a few minutes. (To stop auto channel setting, press [RETURN].) When finished, the Complete screen or time display is shown. Press [ENTER].

To return to the previous screen

Press [RETURN].

When you are finished

Press [SET UP].

Adding and deleting channels

While this unit is receiving the antenna signal (but not during recording):

- 1 Press the numbered buttons to select a channel.

e.g., "5": [0] → [5]

"15": [1] → [5]

"115": [100] → [1] → [5]

Unit's display



- You can also use [▲, ▼, CH] when you are going to delete a channel.

- 2 Press [ADD/DLT].

The channel is **deleted** if it was set or **added** if it was not set.

e.g.,

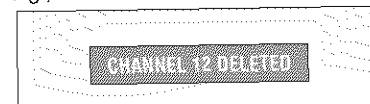

Repeat steps 1 and 2 as necessary.

STEP 4 VCR Plus+ guide channel settings

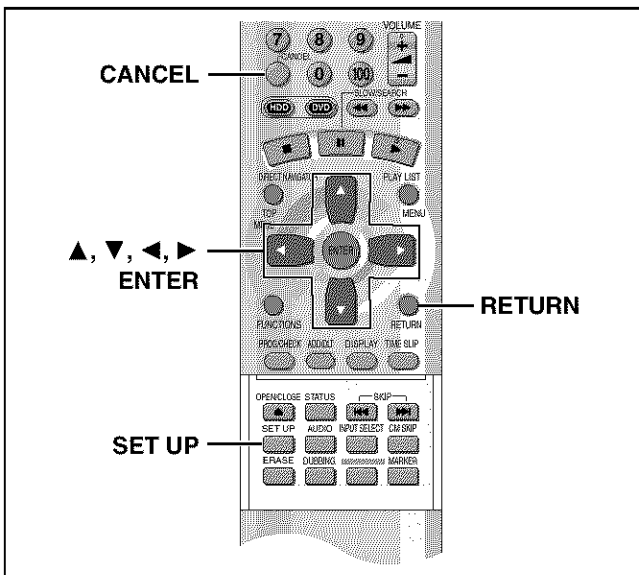

Set these guide channels so you can use VCR Plus+ codes for timer recording. Before starting the settings, prepare a chart showing the channels, station names, and guide channels.

e.g.,

Station name	Guide channel	Channel number	
CBS	04	04	→ A
HBO	33	15	→ B
Nickelodeon	38	20	→ C

Look up the guide channels for the stations in magazines.

Write down all the stations you can receive.

- A** The guide channel and channel numbers correspond so you do not have to change the setting.
- B** In step 5, enter channel 15 next to Guide Channel 33.
- C** In step 5, enter channel 20 next to Guide Channel 38.

1 Press [SET UP] to show the menus.

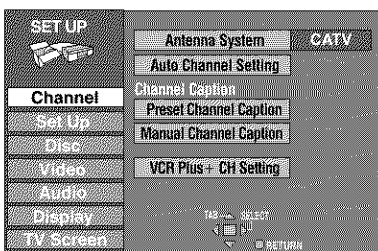

2 Press [▲, ▼] to select "Channel" and press [▶].

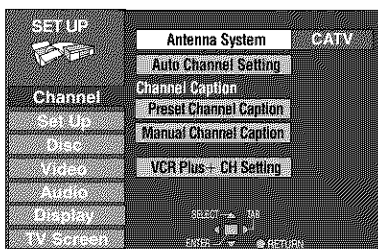

3 Press [▲, ▼] to select "VCR Plus+ CH Setting" and press [ENTER].

e.g., when the current antenna system is CATV.

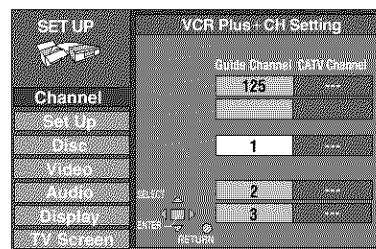

4 Press [▲, ▼] to select the guide channel you want to set and press [▶].

When selecting the guide channel, press and hold [▲, ▼] to scroll the screen up and down.

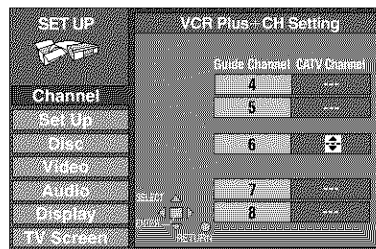

5 Press [▲, ▼] to select the channel corresponding to the guide channel and press [◀].

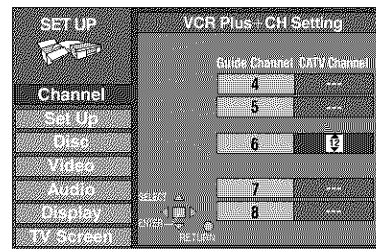

To delete a number, press [CANCEL]. Repeat steps 4 and 5 as necessary.

6 Press [ENTER].

The "Channel" screen reappears.

To return to the previous screen
Press [RETURN].

When you are finished
Press [SET UP].

VCR Plus+ and PlusCode are registered trademarks of Gemstar Development Corporation. The VCR Plus+ system is manufactured under license from Gemstar Development Corporation.

Pats. 5,307,173; 5,335,079; 4,908,713; 4,751,578; and 4,706,121

Other channel settings

- 1 Press [SET UP] to show the menus.
- 2 Press [▲, ▼] to select “Channel” and press [▶].

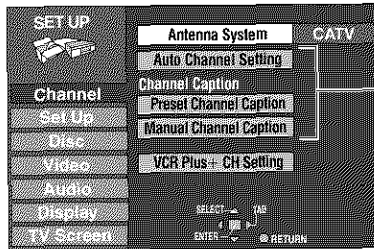

Proceed with the steps described below.

Auto Channel Setting

Check the antenna system. Automatic setting is performed based on the current antenna system (→page 13).

- 3 Press [▲, ▼] to select “Auto Channel Setting” and press [ENTER].

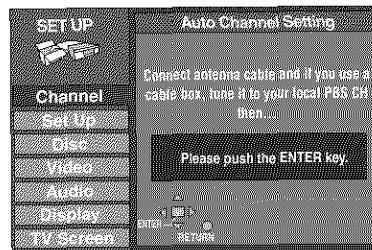

If you have not yet set the clock, the “Auto Channel/Clock Setting” screen appears.

- 4 Press [ENTER].

Auto setting starts. This takes a few minutes. (To stop auto channel setting, press [RETURN].) When finished, the Complete screen or time display is shown. Press [ENTER].

Preset Channel Caption

- 3 Press [▲, ▼] to select “Preset Channel Caption” and press [ENTER].

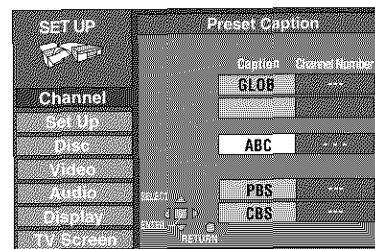

- 4 Press [▲, ▼] to select the caption and then press [▶].

You can choose from the following captions.

ABC, PBS, CBS, CNN, FOX, ESPN, NBC, HBO, A&E, AMC, FAM, MAX, MTV, SHOW, TBS, USA, TNT, CBC, UPN, CTV, WB, TSN, DSC, GLOB

- The screen scrolls a page at a time if you press and hold [▲, ▼].

- 5 Press [▲, ▼] to select the channel corresponding to the caption and then press [◀].

- Channels are not displayed if they do not contain a station or if captions have been added manually.
- To delete the channel number, press [CANCEL].
- Repeat steps 4 and 5 as necessary.

- 6 Press [ENTER].

The “Channel” screen reappears.

Manual Channel Caption

- 3 Press [▲, ▼] to select “Manual Channel Caption” and press [ENTER].

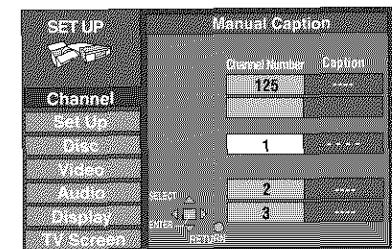

- 4 Press [▲, ▼] to select the channel and then press [▶].

- Channels are not displayed if they do not contain a station or if preset captions have been added.

- 5 Press [▲, ▼] to select the first character and then press [▶].

- You can choose from the following characters: A–Z, 0–9, -, &, !, /, (space)
- To delete the caption, press [CANCEL].
- Repeat step 5 to enter the other characters.

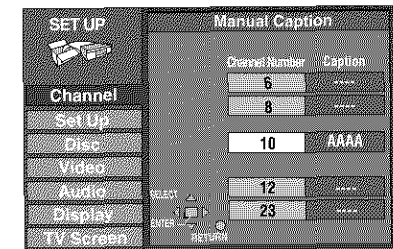

- 6 Press [◀, ▶] to return to the Channel Number column when you are finished.

Repeat steps 4, 5, and 6 as necessary.

- 7 Press [ENTER].

The “Channel” screen reappears.

To return to the previous screen

Press [RETURN].

When you are finished

Press [SET UP].

STEP 5 Selecting TV screen type

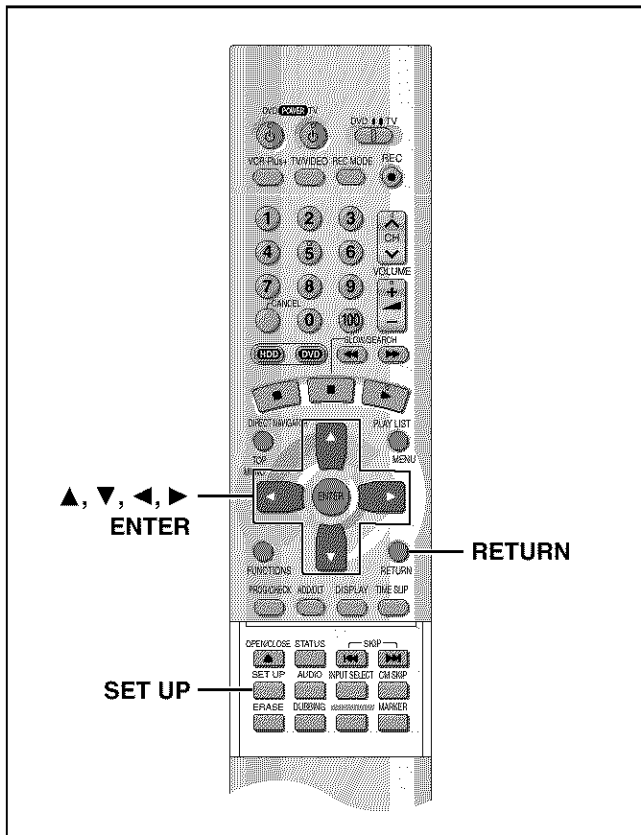

Change the settings if you:

- Connect the unit to a widescreen 16:9 aspect television.
→ Set "TV Aspect" to "16:9".
- Connect the unit through the COMPONENT VIDEO OUT terminals (→ page 11) to a television compatible with progressive video signals (480P).
→ Set "TV Type" to "480P".

1 Press [SET UP] to show the menus.

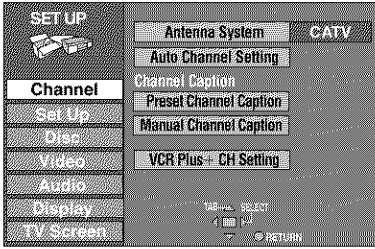

2 Press [▲, ▼] to select "TV Screen" and press [▶].

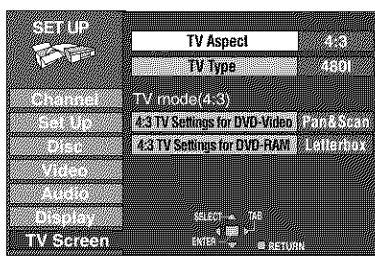

TV Aspect

3 Press [▲, ▼] to select "TV Aspect" and press [ENTER].

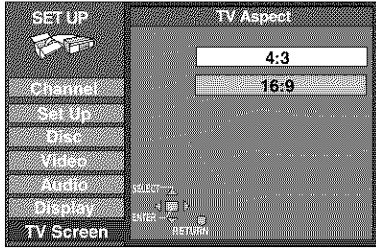

4 Press [▲, ▼] to select "16:9" and press [ENTER].

TV Type

3 Press [▲, ▼] to select "TV Type" and press [ENTER].

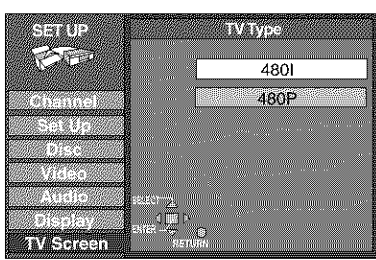

4 Press [▲, ▼] to select "480P" and press [ENTER].

- When playing back, select Video in the on-screen menu and set "Transfer" according to the type of material being played (→ page 52).

To return to the previous screen

Press [RETURN].

When you are finished

Press [SET UP].

■ Regarding Progressive Television Picture

Progressive image aspect (height to width ratio) is set at a standard 16:9. DVD-Video which has been set at 16:9 will be displayed correctly. However, 4:3 video material (→ below) will be stretched to the right and left when displayed.

To view the picture at the right aspect

- For televisions that allow the aspect of progressive images to be adjusted, use the function provided on the television and adjust as necessary.
- For televisions which do not allow the aspect of progressive images to be adjusted, please turn OFF "Progressive" (→ page 52).

4:3 video materials are usually found

- In general television broadcasts (excluding some wide picture broadcasts) and any pictures from discs that recorded such programs.
- In DVDs with an aspect ratio of 4:3 indicated on the jacket.
- DVD-R or Video CD pictures

STEP 6 Television operation

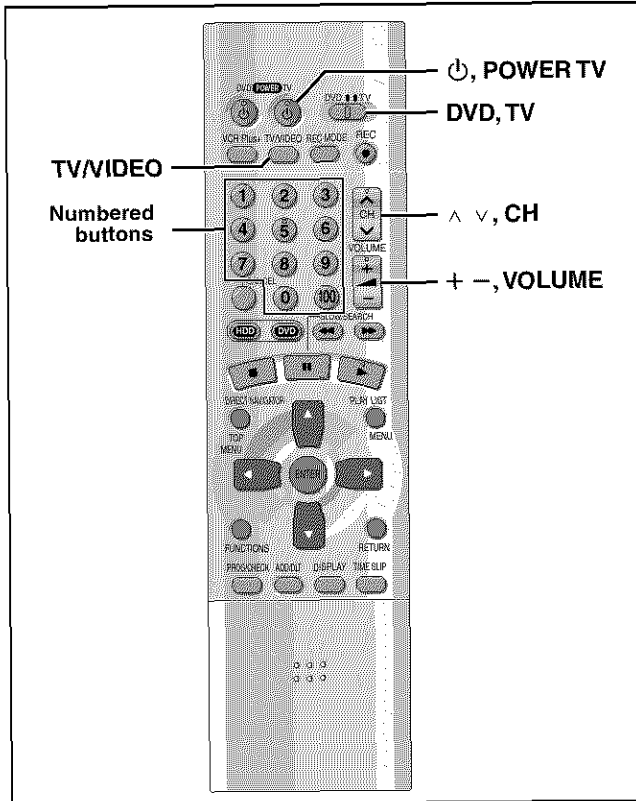

You can control televisions by entering the remote control code.

- 1** Refer to the chart right for the code for your television.
- 2** Press and hold [**⏻**, POWER TV] and enter the two-digit code with the numbered buttons.

- e.g., 01, press [0] → [1].
- Test by turning on the television and changing channels. Repeat the procedure until you find the code that allows correct operation.

Note

- If your television brand is not listed or if the code listed for your television does not allow control of your television, this remote control is not compatible with your television.
- This remote control works with most recently manufactured televisions, but may not be able to control older models.

Code No.	Manufacturer
01	Panasonic/National QUASAR
02	Panasonic/National QUASAR
03	MAGNAVOX SYLVANIA PHILIPS (RC-5)
04	ZENITH
05	THOMSON RCA GE
06	SHARP
07	SHARP
08	SONY
09	TOSHIBA
10	SANYO FISHER
11	JVC
12	HITACHI
13	mitsubishi
14	SAMSUNG
15	GOLDSTAR/LG
16	GOLDSTAR/LG
17	GOLDSTAR/LG
18	SAMSUNG
19	SAMSUNG

■ Operation

Point the remote control at the television.

Operation	Button
On and off	[⏻ , POWER TV]
Video input mode	[TV/VIDEO]
Channels	(Switch [DVD, TV] to "TV".) [^ v , CH] or Numbered buttons e.g., Channel "5": [0] → [5]
Volume	[+ - , VOLUME]

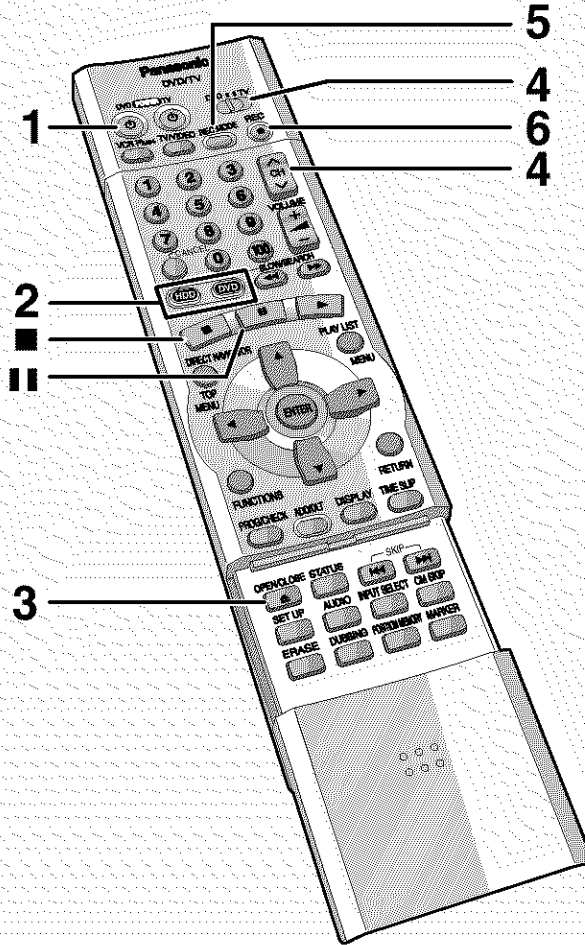
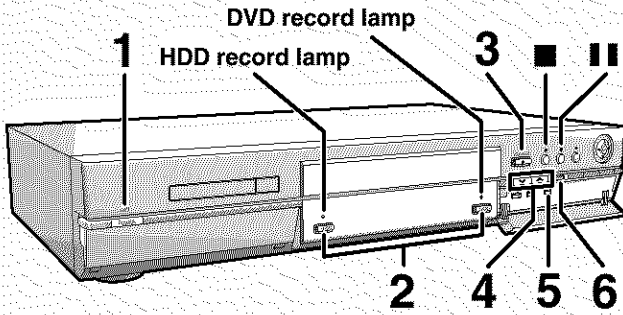

Inserting discs

RAM DVD-R



Cartridge discs

Insert inside the tray's guides.

Insert label-up with the arrow facing in. (Load double-sided discs so the label for the side you want to record is facing up.)

- When using 8 cm (3") DVD-RAM, remove the disc from the cartridge and insert it, making sure you align it with the groove.

Non-cartridge discs

Insert label-up. (Load double-sided discs so the label for the side you want to record is facing up.)

Subsequent to page 20, reference is made to steps 1-3 only where necessary.

1 Press [⏻, DVD POWER] to turn the unit on.

2 Press [HDD] or [DVD] to select the recording drive (→Drive, page 66).

The HDD or DVD button lights up on the unit.

- It is not possible to record to both HDD (Hard Disk Drive) and DVD drive simultaneously.

3 If you selected the DVD drive Press [▲, OPEN/CLOSE] to open the tray and insert a disc.

- Press the button again to close the tray.
- It is not possible to record continuously from one side of a double sided disc to the other. You will need to eject the disc and turn it over.
- If you put a disc in while the HDD is selected, the DVD button on the unit will flash while the unit reads the disc.

4 Ensure [DVD, TV] is switched to “DVD” and press [∧ ∨, CH] to select the channel.

e.g., when you select channel 4



5 Press [REC MODE] to select the recording mode.



- Select “XP”, “SP”, “LP”, or “EP” (→ see right).
- To record sound using LPCM (possible only in XP mode): Select “LPCM” in “Audio Mode for XP Recording” (the picture quality may go down slightly). (→page 61)

6 Press [●, REC] to start recording.

The HDD or DVD record lamp on the main unit lights up.

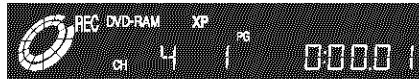

Program information (e.g., time and date) is registered in the program list (→page 26).

- To enable playback your DVD-R on compatible equipment, it is necessary to finalize it (→page 38).

To pause recording

Press [⏸]. Press again to restart recording.

To stop recording

Press [■].

You can record while the unit is on standby for timer recording, but once the time for the timer recording to begin is reached, any recording taking place will stop and the timer recording will begin.

Note

- Recording will take place on open space in the HDD or on disc. Data will not be overwritten.
- It is possible to watch playback from one drive while recording from another (editing is not possible).
- If there is no space left on the recording drive, you will need to erase unwanted programs (in the case of HDD and DVD-RAM) or use a new disc (→ “Erase Program”, page 40).
- You cannot change the channel or recording mode during recording. You can change them while recording is paused, but the material is recorded as a separate program.
- You can record up to 250 programs on HDD, 99 on one disc. (1 program may be recorded continuously for a maximum of 6 hours).

- When using a DVD-RAM for the first time with this unit, format it to ensure accurate recording (→“Format”, page 38).
- There are limitations when recording to DVD-R (→page 8).
- When recording MTS sound onto DVD-R or recording using LPCM, only one of either the main channel or the sub channel can be recorded. Select at “Select MTS for DVD-R or LPCM” (→page 61).

Notes on recording

Recording modes and approximate recording times in hours

Storage Media / Mode	HDD (40 GB)	DVD-RAM		DVD-R (4.7 GB)
		Single-sided (4.7 GB)	Double-sided (9.4 GB)	
XP (High quality)	8.5	1	2	1
SP (Normal)	17	2	4	2
LP (Long play)	34	4	8	4
EP (Extra long play)	52	6	12	6

• **FR (Flexible Recording Mode)** can be set when using timer recording or when dubbing.

–When carrying out timer recording or flexible recording to HDD.

FR automatically adjusts the recording mode to enable the program to fit exactly into the space of an unused DVD-RAM/R (4.7 GB).

–When carrying out timer recording or flexible recording to DVD-RAM/R.

FR compares the length of the program to be recorded with the available space on the disc. Based on this, it automatically selects the recording mode that will fit the program most accurately into the remaining space while maintaining the best possible picture quality. For example, when recording a 90-minute program onto a new DVD-RAM disc, FR automatically selects a recording rate between “XP” and “SP”.

–When dubbing

The unit automatically adjusts the recording mode during dubbing so that the program fits into the space available while maintaining as closely as possible the original picture quality.

- If there are still pictures stored in the selected drive, recording times may vary from those given in the table above.

Recording/Dubbing/Transferring of a program

This unit incorporates copyright protection technology for recording equipment known as CPRM (→page 66). With some programs recording, dubbing and/or transferring may not be possible.

Recording limit	Usable Media	
No recording limit	Record → HDD	Dub → RAM, DVD-R
	Record → RAM	Dub → HDD
	Record → DVD-R	Dub → ✗ You cannot dub.
Recording limited to one time	Record → HDD	Transfer → RAM
	Record → RAM	Dub → HDD*
	Record → ✗	You cannot record on DVD-R.
Recording not possible	Record → ✗	You cannot record/dub on any media.

* Can be dubbed to HDD but cannot be played back.

Transfer: this is when a program is moved to another storage media. The original program will be erased.

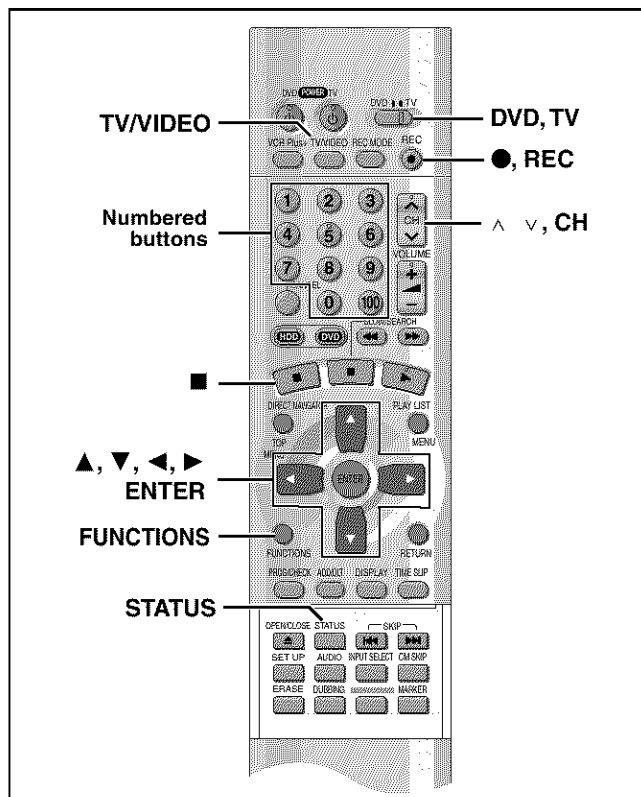

Watching the television while recording

HDD RAM DVD-R

Pictures being recorded are unaffected.

- ① Switch [DVD, TV] to "TV".
- ② Press [TV/VIDEO] to change the television's input mode to "TV".
- ③ Press [^ v, CH] to change channels.
 - You can also select the channel with the numbered buttons
 - e.g., "5": [0] → [5]
 - "15": [1] → [5]
 - "115": [100] → [1] → [5]

Flexible Recording—recording the best quality pictures in a set time

HDD RAM DVD-R

The unit calculates a recording rate that enables the recording to fit in the time you set (within the remaining time on the HDD or disc) and with the best possible picture quality.

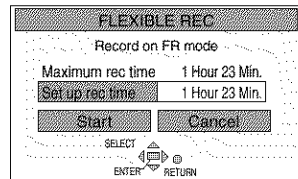
- 1 While stopped
Press [FUNCTIONS].
The FUNCTIONS window appears (→page 53).
- 2 Press [▲, ▼, ◀, ▶] to select "FLEXIBLE REC" and then [ENTER].

- 3 Press [◀, ▶] to select "Hour" or "Min." and press [▲, ▼] to change the recording time.
- 4 To start recording
Press [▲, ▼, ◀, ▶] to select "Start" and press [ENTER].
Recording starts.

Note

It may not be possible to record to the finish of the program if the remaining time doesn't allow.

For your reference

- Press [STATUS] during recording to show the remaining time.
- It is not possible to change channel or recording mode while Flexible Recording is paused.
- Recording time reduces if you repeatedly pause recording.
- The time setting is possible up to 6 hours.

One Touch Recording—Specify a time to stop recording

HDD RAM DVD-R

This is a simple way of specifying a time to stop recording when you are in a hurry or before you go to bed. You can set the time up to 4 hours in advance.

During recording

Press [●, REC] to select the recording time.

Each time you press the button: e.g.,

0:30 → 1:00 → 1:30 → 2:00 → 3:00
 ↑ (Counter) ← 4:00 ←



To cancel

During recording, press [●, REC] until the counter appears. (Recording continues.)

For your reference

- Press [STATUS] to show the time remaining until recording finishes.
- This does not work during timer recordings or while using Flexible Recording (→ above).
- Recording stops and the set time is cleared if you press [■].
- The set time is cleared if you change the recording mode or channel while recording is paused.

Playing while you are recording

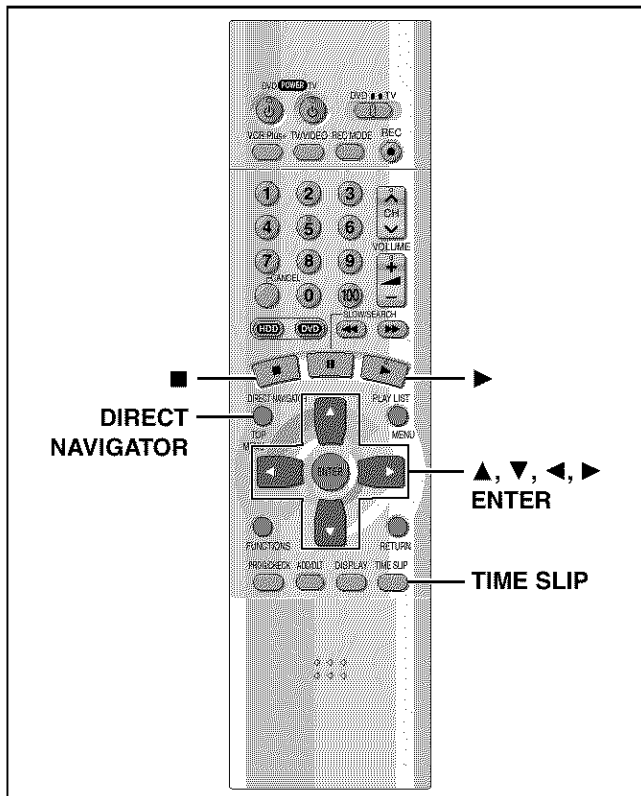

Playing from the beginning of the program you are recording—Chasing play

HDD RAM

During recording

Press **[▶]** (PLAY).

Play starts from the beginning of the program being recorded.

e.g., while recording program 2 (sport)

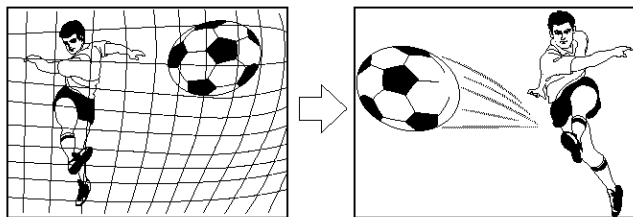

You are recording a **sports program** (2) and you want to watch it from the beginning.

The same **sports program** is played back from the beginning. (Recording continues.)

Note

- Sound is not output while fast-forwarding.
- Play cannot be started until at least 2 seconds after recording starts.
- You cannot catch up to the point currently being recorded using fast-forward. If you wish to view the program as it is being recorded, press **[■]** to stop play.

To stop play and recording

- 1 Press **[■]**. (Play stops.)
Wait 2 seconds.
- 2 Press **[■]**. (Recording stops.)
• To stop timer recording, press **[■]**, then **[ENTER]** within 5 seconds.

Simultaneous rec and play

HDD RAM

You can play a program previously recorded.

1 During recording
Press **[DIRECT NAVIGATOR]**.

The program list (→page 26) appears.

2 Press **[▲, ▼]** to select a program and press **[ENTER]**.

e.g., while recording program 2 (sport)

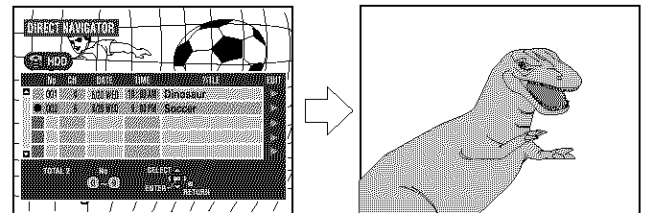

You want to watch the **movie** you recorded yesterday (program 1)

Program 1 is played back while program 2 (sport) is being recorded.

Note

- Sound is not output while fast-forwarding.
- You cannot edit programs during simultaneous rec and play (→page 40).

Reviewing the recorded images while recording—Time Slip

HDD RAM

You can play the program being recorded to check that it is being recorded correctly. You can also check parts that were recorded previously.

1 During recording
Press **[TIME SLIP]**.

- Images from 30 seconds previous are displayed. You will hear the playback audio.

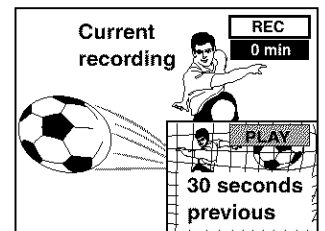

2 Within 5 seconds
Press **[▲, ▼]** to enter the time and press **[ENTER]**.

e.g., Go back 5 minutes

- Press **[▲, ▼]** to alter in one-minute units. Press and hold **[▲, ▼]** to alter in 10-minute units.

HDD:

maximum 999 minutes

RAM:

maximum 360 minutes

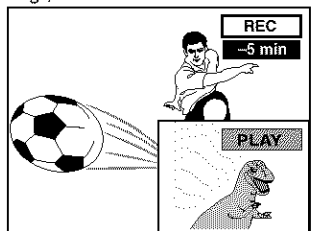

The playback display is shown on the full screen after 5 seconds.

Note

The recording and play images cannot be shown at the same time if you set "TV Type" to "480P" (→page 16).

Playing discs

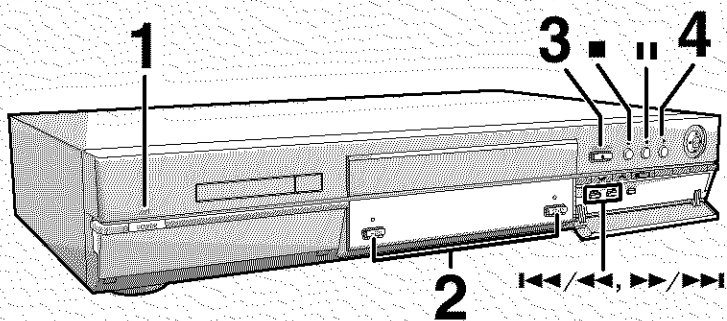

Regarding the HDD (Hard Disk Drive)
 When using this unit for the first time, the HDD has nothing recorded on it. You must record a program etc to the HDD before you can enjoy playback.

Playing back

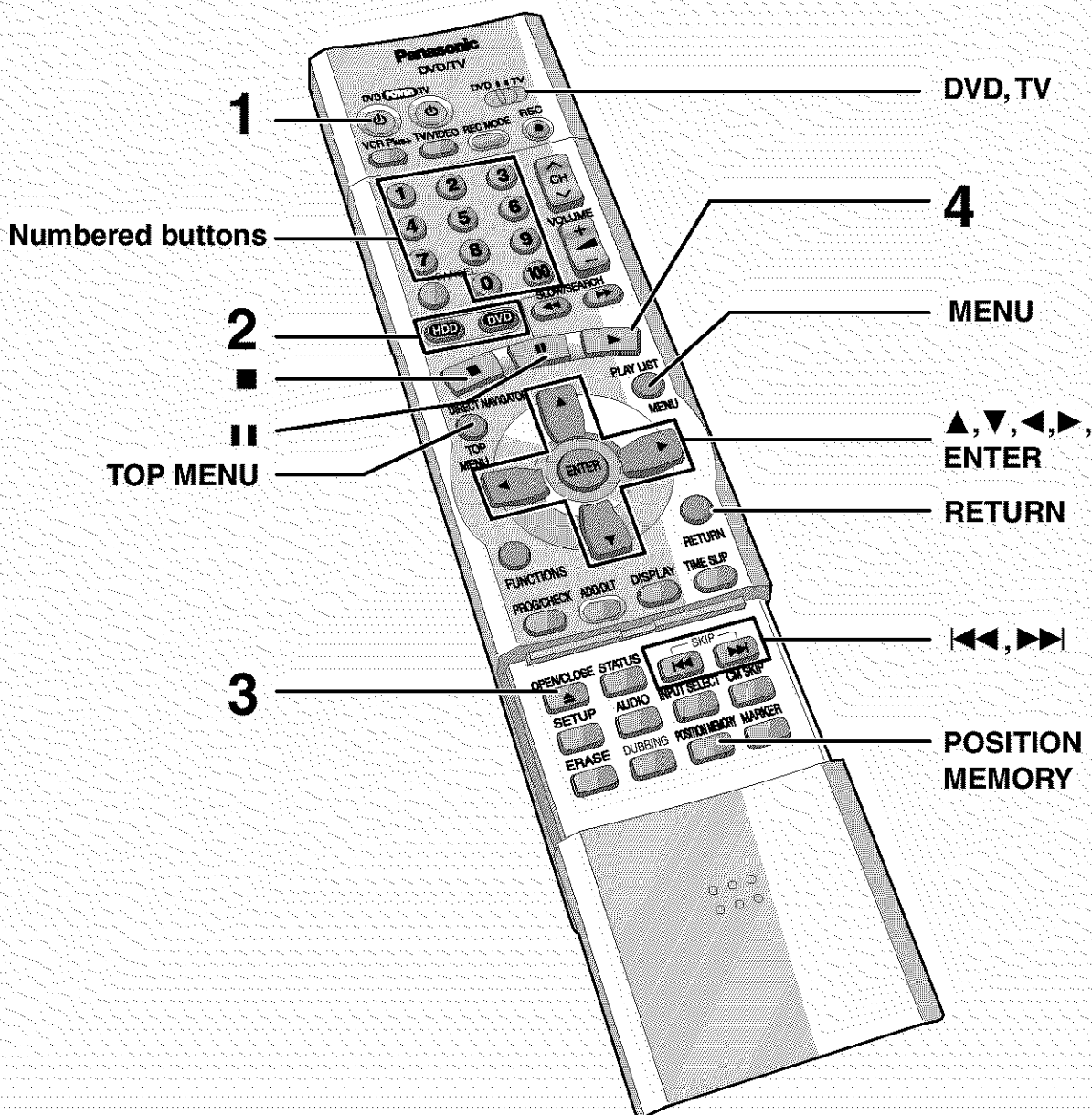

Auto power-off

The unit switches to standby after about 6 hours in the stop mode. You can turn this feature off or change the time to 2 hours (→ page 60, Set Up—Off Timer).

Subsequent to Resume Function (→ right), reference is made to steps 1-3 only where necessary.

- 1 Press [⏻, DVD POWER] to turn the unit on.**
- 2 Press [HDD] or [DVD] to select the playback drive (→ Drive, page 66).**
The HDD or DVD button lights up on the unit.
 - It is not possible to playback both HDD (Hard Disk Drive) and DVD drive simultaneously.
- 3 If you selected the DVD drive Press [▲, OPEN/CLOSE] to open the tray and insert a disc (→page 18).**
 - Press the button again to close the tray.
 - Insert label-up. (Load double-sided discs so the label for the side you want to play is facing up.)
 - It is not possible to play continuously from one side of a double-sided disc to the other. You will need to eject the disc and turn it over.
 - When using 8 cm (3") DVD-RAM, remove the disc from the cartridge and insert it, making sure you align it with the groove.
 - If you put a disc in while the HDD is selected, the DVD button on the unit will flash while the unit reads the disc.
 - If Cartridge Protection is activated (→page 8), pressing [▲, OPEN/CLOSE] will cause playback to begin automatically.
- 4 Press [▶] (PLAY).**
The unit takes some time to read the disc before play starts.
 - If the resume function (→ right) is not active, playback will begin from the most recently recorded program.
 - If you want to play the beginning of the disc (e.g., the first program, chapter or title), select "PLAY FROM TOP" in the FUNCTIONS window (→page 53).

To stop play

Press [■] (When "PLAY" flashes → Resume Function, right).

- The screen saver on the right may appear when you stop play. Press [■] again and you can use this unit's tuner to watch television.



To pause play

Press [⏸].

Press again to restart play.

Note

- If you select another drive while playback is in progress, playback will be stopped. If using DVD-Video, the contents of the menu screen may be returned to their initial state.
- If a disc is loaded and DVD drive is selected, the unit will come on and play will start when you press [▶] (PLAY).
- When you play a disc with an audio-only track, the video from the previous disc may continue to be shown on the television.
- Actual sound levels for DVD-Video are lower compared to television broadcast or playback of other discs. To avoid a sudden increase in volume level when switching from DVD-Video, reduce the volume setting before playing other sources or switching to television broadcast.

When a menu screen appears on the television

DVD-V VCD



VCD

Switch [DVD, TV] to "DVD" and

Press the numbered buttons (0, 1–9) to select an item.

e.g., "5": [0] → [5]

"15": [1] → [5]

DVD-V

Press [▲, ▼, ◀, ▶] to select an item and press [ENTER].

- You may also be able to use the numbered buttons (0, 1–9) to select an item.

Other buttons used to operate menus

Read the disc's instructions for further details about operation.

[▶▶] [▶▶/▶▶]: Shows the next menu.

[◀◀] [◀◀/◀◀]: Shows the previous menu.

[RETURN]: Shows the menu screen. [VCD]

[TOP MENU]: Shows the first menu screen. [DVD-V]

[MENU]: Shows the menu screen. [DVD-V]

Note

- Discs continue to rotate while menus are displayed. Press [■] when you have finished viewing to preserve the unit's motor and your television screen.
- If "⊘" appears on the television, the operation is prohibited by the unit or disc.
- Functions available vary from disc to disc.

Starting play from where you stopped it —Resume Function

HDD RAM DVD-R DVD-V CD VCD

(When the elapsed play time is displayed)

- 1 During play Press [■].**
The unit memorizes the position.
- 2 While "PLAY" is flashing on the display Press [▶] (PLAY).**
Play starts from where you stopped it.



To cancel the resume function

Press [■] until "PLAY" goes out.

(The position is also cleared when you turn the unit off. When the DVD drive is selected, the position is cleared if you open the disc tray.)

To start play from a memorized position after turning the unit off

Press [POSITION MEMORY] during play.

(The message "Position Memorized" appears on the television.)

Now when you press [▶] (PLAY) after switching the unit to standby and back on, play starts from the memorized position and the position is cleared.

For your reference

If you press [■] before switching the unit to standby after pressing [POSITION MEMORY] to memorize a position, play will resume from the position you pressed [■] when you press [▶] (PLAY).

DVD-R DVD-V CD VCD

- The position is memorized when you press [POSITION MEMORY] and cleared when you open the disc tray.

RAM

- Positions recorded by pressing [POSITION MEMORY] remain memorized even after the disc tray is opened.
- You cannot mark positions if the disc is write-protected.

Skipping programs and commercials

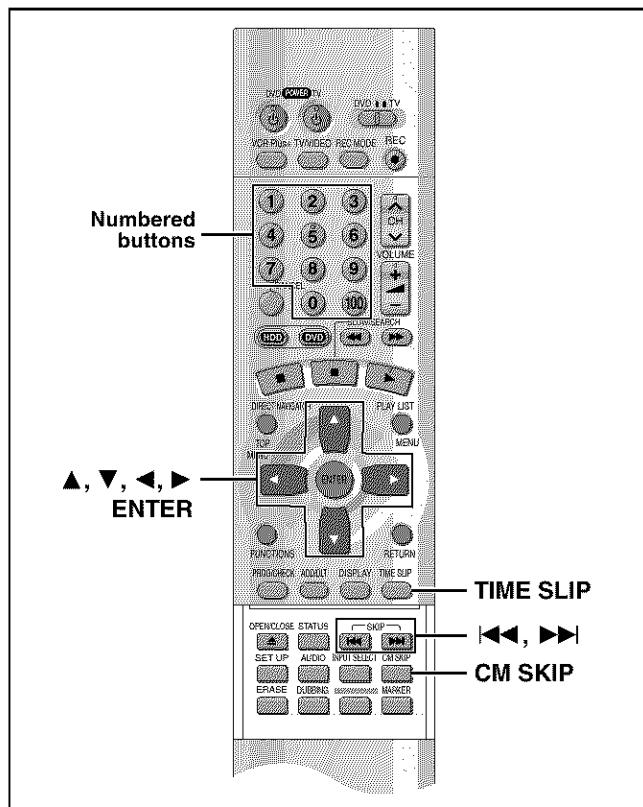

Starting play from a selected program, title, chapter, or track

HDD **RAM** **DVD-R** **DVD-V** **CD** **VCD**

During play or while stopped

Press the numbered buttons to select the item.

e.g., "5": [0] → [5] **HDD** e.g., "5": [0] → [0] → [5]
 "15": [1] → [5] "15": [0] → [1] → [5]

Note

- This may not work with some discs.
- This works only when stopped with some discs (the screen saver is on the television).



Selecting an amount of time to skip—Time Slip

HDD **RAM** **DVD-R**

1 During play
Press [TIME SLIP].

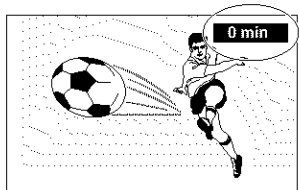

2 Within 5 seconds
Press [▲, ▼] to enter the time and then press [ENTER].

e.g., Go back to 5 minutes

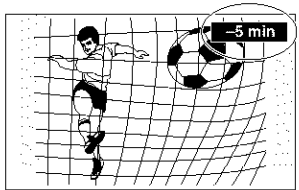

Press to alter in one-minute units. Press and hold to alter in 10-minute units (can be set between 1 minute and 999 minutes with HDD, 1 minute and 360 minutes with DVD-RAM/-R in units of one minute).

Skipping a minute forward—CM Skip

HDD **RAM** **DVD-R**

During play

Press [CM SKIP].

Play restarts from approximately a minute later.

Note

- If the start of the next program is within one minute of the point you skipped from, play restarts from the beginning of that program.
- Since the length of commercials varies, this feature may not skip commercials accurately.

Skipping

HDD **RAM** **DVD-R** **DVD-V** **CD** **VCD**

You can skip to the beginning of tracks (CD and Video CD) and chapters (DVD-Video) and restart play from there. On HDD, DVD-RAM and DVD-R, you can skip to the start of a program or to a marker (→page 28) and start play from there.

During play or while paused

Press [◀◀] or [▶▶].

- Press [◀◀/◀◀] or [▶▶/▶▶] on the main unit.

[◀◀] [◀◀/◀◀]: backward
 [▶▶] [▶▶/▶▶]: forward
 Each press increases the number of skips.

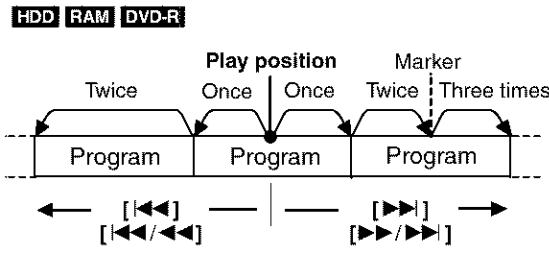
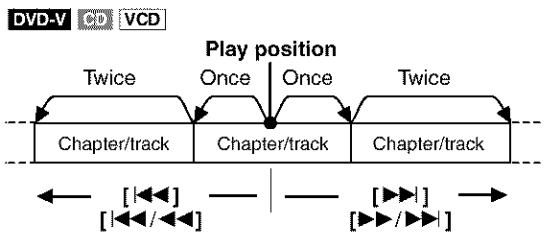

For your reference

Pressing [◀◀] [◀◀/◀◀] or [▶▶] [▶▶/▶▶] while the playback control feature on Video CDs (→page 66) is working may take you to a menu screen.

Playing still pictures (JPEG)

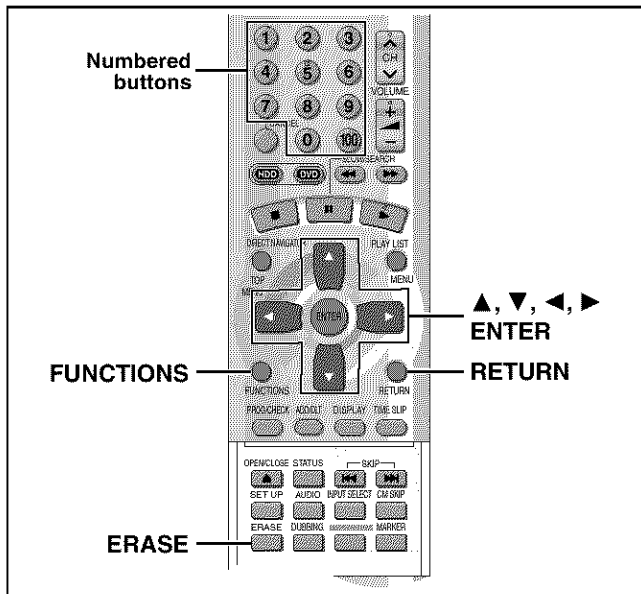

CARD HDD RAM

Inserting/Removing the PC card

Carry out insertion/removal of the PC card after turning the unit off.

When the card indicator in the unit display is flashing, the card is being read from or written to. Do not turn off the power or remove the card. Such action may result in malfunction or loss of the card's contents.

Inserting the card

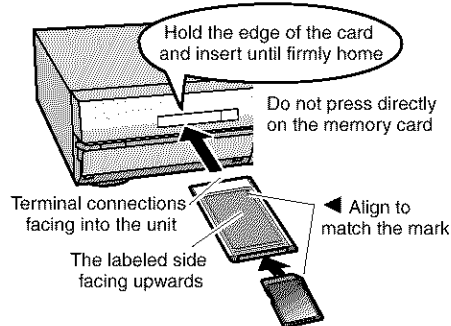

Removing the card

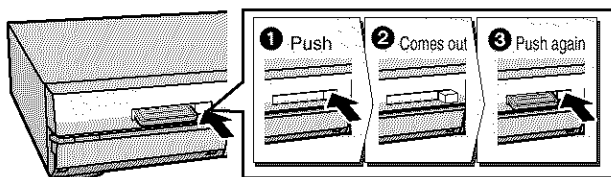

- If using the adaptor, remove the adaptor and card together.
- If the eject button does not come out
To remove the PC card, press the card in once more and then repeat steps ①-③.
- It is not possible to open the disc tray while the still pictures screen is displayed.

- 1 While stopped**
Press [FUNCTIONS].
The FUNCTIONS window appears (→page 53).
- 2 Press [▲, ▼, ◀, ▶] to select "JPEG" and press [ENTER].**
- 3 Select the still picture folder for display.**
 - ① Press [▲, ▼] to select "INPUT" and press [ENTER].
(A list of the folders in the drive appears.)
 - ② Press [◀] and [▲, ▼] to select the drive and press [▶].
 - ③ Press [▲, ▼] to select the folder and press [ENTER].

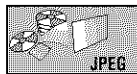

Displaying still pictures (Album Display)

You can display a list of still pictures or display pictures one by one from any folder existing on the PC card, HDD or DVD-RAM.

4 Press [▲, ▼] to select "Album" and press [ENTER].

A list of the still pictures in the folder appears.

To display still pictures one by one

Press [▲, ▼, ◀, ▶] to select a still picture and then [ENTER].

- If there are more than 10 still pictures, press [▲, ▼, ◀, ▶] to select "Next" and press [ENTER]. Select "Prev." to move back.
- You can also select a page of still pictures with the numbered buttons.

e.g., "5": [0] → [0] → [5] "15": [0] → [1] → [5]

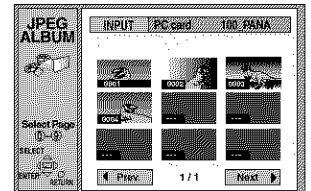

To stop still picture display

Press [RETURN]. (The still picture list containing the picture you first selected will be displayed.)

To select the next or previous still picture

While in still picture display, press [◀, ▶].

[◀]: previous still picture [▶]: next still picture

- The still picture changes every time the button is pressed.

To display still pictures one by one with constant interval (Slide Show)

The still pictures in the folder will be displayed one by one with a constant interval. The display timing can be altered in units of 1 second.

4 Press [▲, ▼] to select "Slide Show" and press [ENTER].

The still pictures in the folder appear in numerical order.

To change the display timing

- ① After step 3 at left, press [▲, ▼] to select "Settings" and press [ENTER].
- ② Press [▲, ▼] to select "Slide Show".
- ③ Press [◀, ▶] to select the desired timing between still pictures (0 - 30 seconds) (in base units of 1 second).
- ④ Press [ENTER].

To stop slide show

Press [RETURN]. (Menu screen appears.)

To select the next or previous still picture

While in still picture display, press [◀, ▶].

[◀]: previous still picture [▶]: next still picture

- The still picture changes every time the button is pressed.

To erase still pictures

(Still pictures are erased irretrievably by this procedure.)

While in still picture display

- ① Press [ERASE].
- ② Select "Erase" and press [ENTER].

To rotate the picture

While in still picture display

- ① Press [ENTER].
- ② Press [▲, ▼] to select "Rotate RIGHT" or "Rotate LEFT" and press [ENTER].

- The still picture as a whole is rotated.
- Rotation information will not be stored.

To display information about the still pictures

While in still picture display, press [ENTER].

(Date, "folder number" - "file number" and number of still pictures are displayed.)

To give a folder a title

After step 3 on the left column, you can input a folder title (→page 45, "Entering text"):

- Titles inputted using this unit will not be displayed on other equipment.

Using the Direct Navigator

Playing back

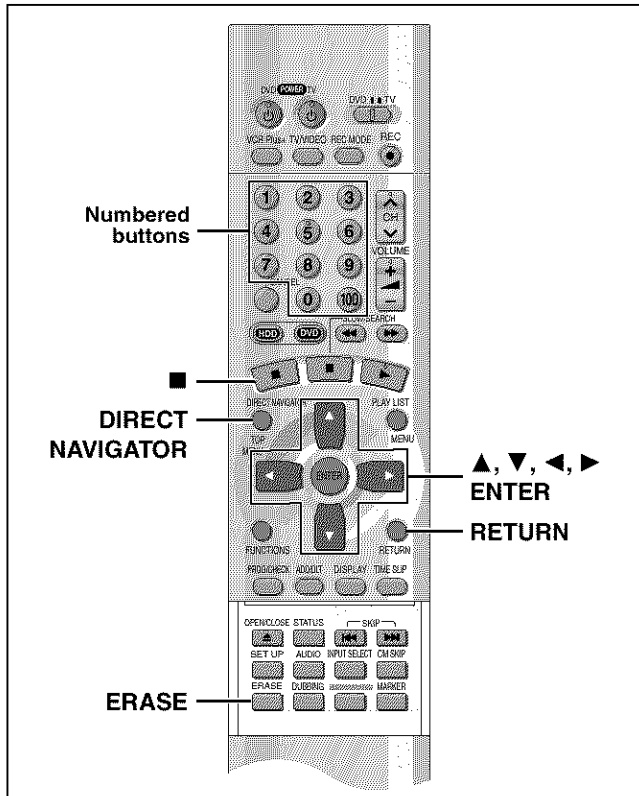

HDD RAM DVD-R

A list of programs is created as you record them. You can use this list to find programs to watch.

1 Press [DIRECT NAVIGATOR].

The highlighted program plays in the background.

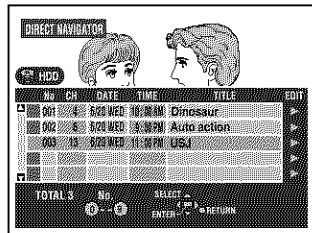

2 Press [▲, ▼] to select the program and press [ENTER].

• You can also select programs with the numbered buttons.

e.g., **HDD**

"5": [0] → [0] → [5]

"15": [0] → [1] → [5]

RAM DVD-R

"5": [0] → [5]

"15": [1] → [5]

Play of the images that were playing in the background continues.

To stop play

Press [■].

To clear the program list

Press [RETURN].

About the program list

Write-protected

Displayed when you have protected the program.

Copy-protected

Displayed when you have recorded a program that has copy protection, from CATV broadcasts, for example.

Unable to play

Displayed if you cannot play the program.

Currently recording

Displayed when the program is being recorded.

No.	CH	D
001	4	6/21
002	6	6/21
003	13	6/21
004	2	6/21
005	8	6/21
TOTAL 5		

And more...

: Programs that have been rerouted to the HDD **HDD** (→ Relief Recording, page 35)

: Programs that allow one copy **HDD**

To erase a program that is being played back

Since the program and any play lists (→ next page) created from it are erased irretrievably by this procedure, you should be certain you wish to erase before carrying it out.

- 1 During play
Press [ERASE].
A confirmation screen will be displayed.
- 2 Press [◀] to select "Erase" and press [ENTER].
Select "Cancel" and press [ENTER] to cancel.

Note

- It is not possible to erase the program when you are carrying out simultaneous rec and play (→page 21).
- The amount of space remaining on the disc does not increase even if you erase programs. **DVD-R**

Playing play lists

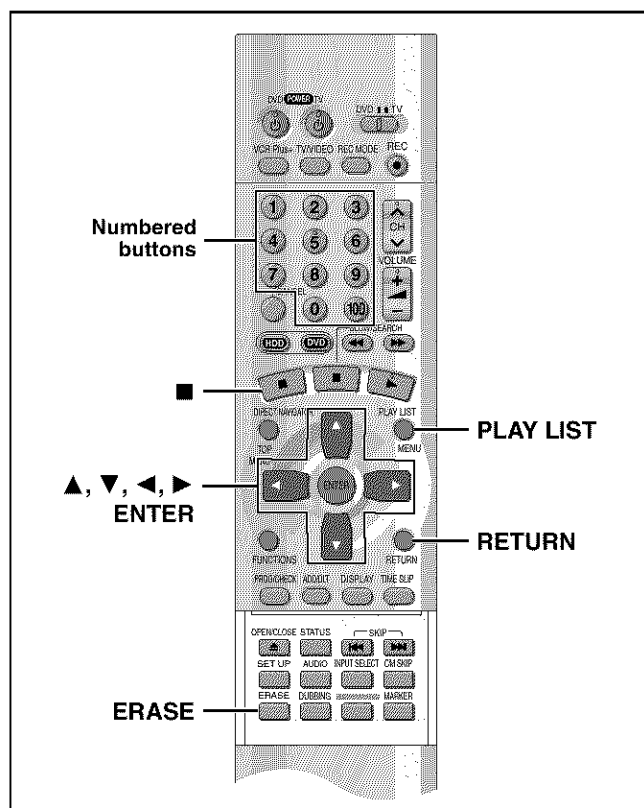

HDD RAM

Create play lists first (→page 44).

Playing play lists

- 1 While stopped
Press [PLAY LIST].
The play list appears.

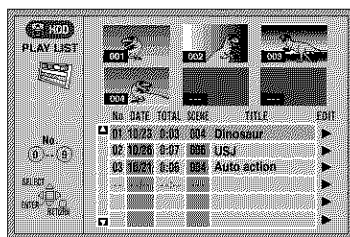

- 2 Press [▲, ▼] to select the play list and press [ENTER].
 - You can also select play lists by entering a 2-digit number with the numbered buttons.
e.g., "5": [0] → [5]
"15": [1] → [5]

All the scenes in the play list are played.

To stop play list play
Press [■]. (The play list appears.)

To clear the play list
Press [RETURN].

Playing play list scenes

- 1 While stopped
Press [PLAY LIST].
- 2 Press [▲, ▼] to select the play list that contains the scene you want to play and press [▶].

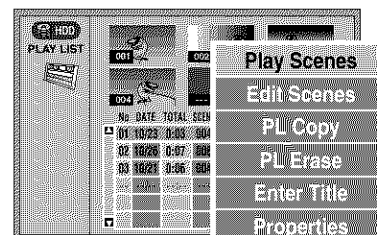

- 3 Press [▲, ▼] to select "Play Scenes" and press [ENTER].
The scene list appears.

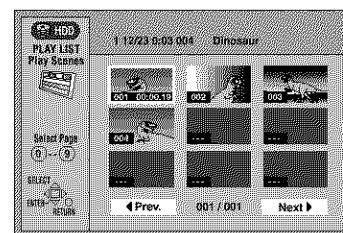

- 4 Press [▲, ▼, ◀, ▶] to select the scene and press [ENTER].
The scene you select is played.

To show scene 10 and later
Press [▲, ▼, ◀, ▶] to select "Next" and press [ENTER].
• You can also select a page of scenes by entering a 3-digit number with the numbered buttons.
e.g., "5": [0] → [0] → [5]
"15": [0] → [1] → [5]

To stop scene play
Press [■]. (The scene list appears.)

To clear the scene list
Press [RETURN].

To erase a play list or a play list scene during playback

- 1 While playing back a play list or play list scene
Press [ERASE]
A confirmation screen will be displayed.
- 2 "Erase/Cancel" or "Yes/No" will be displayed. Select "Erase" or "Yes" and press [ENTER].
Select "Cancel" or "No" and press [ENTER] to cancel.

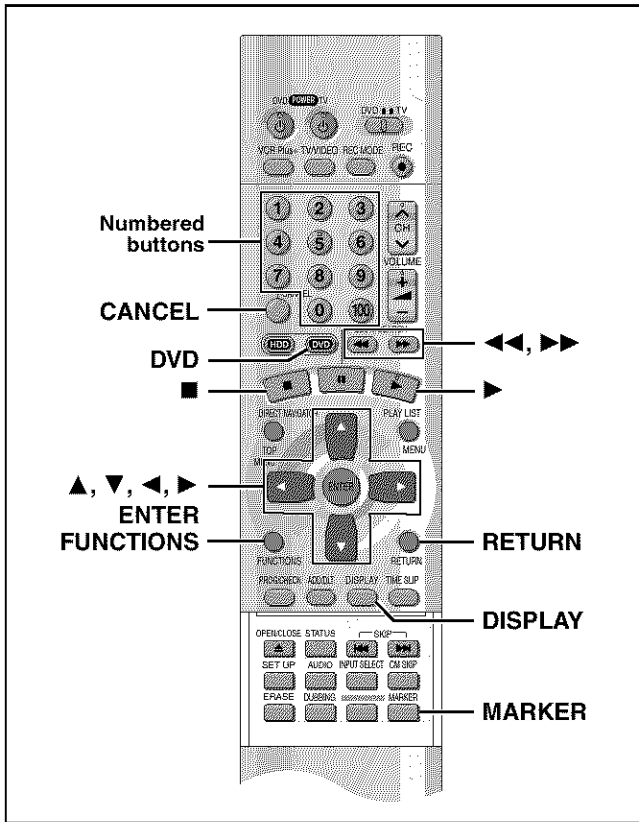

You can mark positions by pressing [MARKER]. Also use on-screen menus to mark, recall, and clear positions.

HDD RAM DVD-R

Mark up to 999 positions. The unit records the markers directly onto the disc and they remain intact even if you remove the disc.

DVD-V CD VCD

Mark up to 5 positions. The markers clear when you open the disc tray.

Marking positions directly—MARKER

During play

Press [MARKER].

One marker is added.



Using on-screen menus to mark positions

Displaying the marker icon

1 During play
Press [DISPLAY].
The on-screen menu appear. (e.g., DVD-RAM)

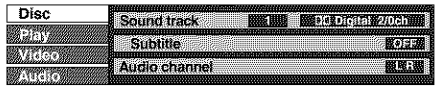

2 Press [▲, ▼] to select the “Play” and press [▶].

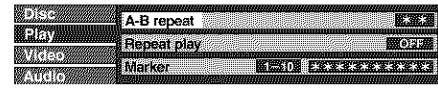

3 Press [▲, ▼] to select “Marker” and press [▶] to highlight the first asterisk (*).



Marking positions

Press [◀, ▶] to select an asterisk (*) and press [ENTER].

One marker is added.

When marking positions 11 and above

HDD RAM DVD-R

- ① Press [◀, ▶] to highlight “1-10”.
- ② Press [▲, ▼] to select “11-20”.
You can select the next group of 10 when the current group is full.
- ③ Press [▶].
The first asterisk is highlighted.
- ④ Press [ENTER] to mark a position.



Playing from a marked position

Press [◀, ▶] to select a marker number and press [ENTER].

Play starts from the marked position.

Clearing markers

Press [◀, ▶] to select a marker number and press [CANCEL].

An asterisk replaces the number and the position is cleared.

To clear the on-screen menus

Press [RETURN].

Note

- You cannot use this feature if:
 - the disc’s elapsed play time is not shown in the display.
 - you are using a play list. **HDD RAM**
 - when Disc Protection (→page 38) or Cartridge Protection (→page 8) is activated. **RAM**

- Subtitles around markers may fail to appear.
- Markers are cleared when you finalize DVD-R.
- Markers on HDD, DVD-RAM and DVD-R are ordered by time, so marker numbers can change when you add and delete them.

Program play

You can select up to 100 tracks to play in the order you choose.

Preparation

Press [DVD] to select DVD drive.

- 1 While stopped
Press [FUNCTIONS].

The FUNCTIONS window appears (→page 53).

- 2 Press [**▲**, **▼**, **◀**, **▶**] to select “PROGRAM PLAY” and press [ENTER].



- 3 Press the numbered buttons to select the track.

e.g., “5”: [0] → [5]
“15”: [1] → [5]

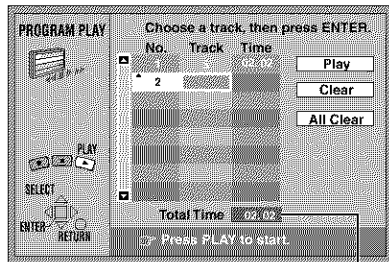

Total time of the program

Repeat step 3 to select other tracks.

- You can also use the cursor buttons to select tracks.
 - ① Press [ENTER], then press [**▲**, **▼**] to select the track. Select “ALL” to enter all tracks on the disc.
 - ② Press [ENTER].

- 4 Press [**▶**] (PLAY).

Play starts in the programmed sequence.

To move to the page before or after the one shown

Press [**◀◀**] or [**▶▶**].

To clear the programmed tracks one by one

- ① Press [**▲**, **▼**] to select the track you want to clear.
- ② Press [CANCEL].
Alternatively, press [**▲**, **▼**, **◀**, **▶**] to select “Clear” and press [ENTER].

To clear the whole program

Press [**▲**, **▼**, **◀**, **▶**] to select “All Clear” and press [ENTER].

- The whole program is also cleared when you turn the unit off, open the disc tray or change the selected drive to HDD.

To exit the program mode

- ① Press [■] during play until the program play screen is displayed.
- ② Press [RETURN].

Random play

The unit plays the tracks on a disc in random order.

Preparation

Press [DVD] to select DVD drive.

- 1 While stopped
Press [FUNCTIONS].

The FUNCTIONS window appears (→page 53).

- 2 Press [**▲**, **▼**, **◀**, **▶**] to select “RANDOM PLAY” and press [ENTER].



- 3 Press [**▶**] (PLAY).

To cancel random play

- ① Press [■] until the random play screen appears.
- ② Press [RETURN].

Fast forward and rewind—SEARCH

During play

Press [**◀◀**] or [**▶▶**].

- Press and hold [**◀◀/◀◀**] or [**▶▶/▶▶**] on the main unit.

[**◀◀**], [**◀◀/◀◀**]: Backward

[**▶▶**], [**▶▶/▶▶**]: Forward

- The speed increases up to 5 steps.
- Press [**▶**] (PLAY) to restart play.
- Audio will be heard during search. You can turn this audio off if you want to (→ page 61, Audio—Audio during Search).

Slow-motion play

While paused

Press [**◀◀**] or [**▶▶**].

- Press and hold [**◀◀/◀◀**] or [**▶▶/▶▶**] on the main unit.

[**◀◀**], [**◀◀/◀◀**]: Backward (does not work with Video CDs)

[**▶▶**], [**▶▶/▶▶**]: Forward

- The speed increases up to 5 steps.
- Press [**▶**] (PLAY) to restart play.

To play DVD-R recorded on this unit on other players

You can play DVD-R on other compatible DVD players by finalizing them on this unit (→page 38). The disc title (→page 38) and the program titles (→page 40) will appear as menus.

Changing audio

Playing back

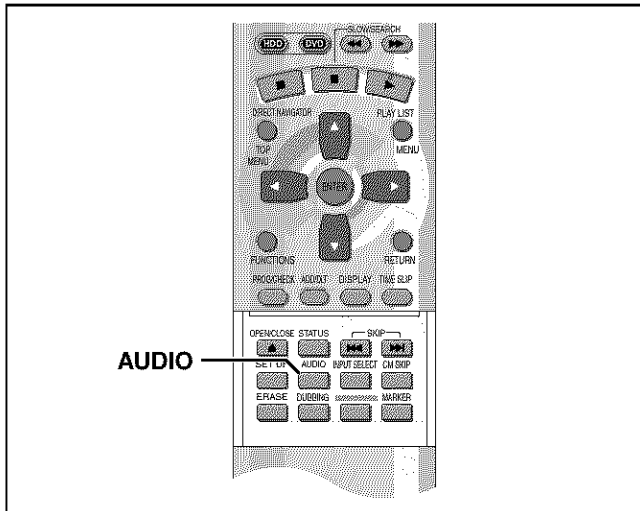

HDD RAM DVD-V VCD

You can change the audio being received or played.

During reception or play

Press **[AUDIO]**.

How the type changes depends on when you press the button.

■ When receiving MTS audio (Multi-channel Television Sound Stereo) or recording through the DV input terminal

Stereo → SAP → Mono

Depending on the type of television broadcast and sound selected, received and recorded sound is as follows:

Television broadcast \ Audio selected	Audio selected		
	Stereo	SAP	Mono
Stereo +SAP	Main audio (Stereo)*1	Secondary audio program (SAP)*2	Main audio (Monaural)
Mono +SAP	Main audio (Monaural)	Secondary audio program (SAP)*2	Main audio (Monaural)
Stereo	Stereo*1	Stereo*1	Monaural
Mono	Monaural	Monaural	Monaural

*1 Select "Mono" if reception is poor during a stereo broadcast.

*2 If recorded in this mode, main audio is also recorded. Consequently it is possible to choose between MAIN and SAP when playing back.

e.g., "Stereo" is selected

"(" appears when the unit is receiving the type of audio you selected.

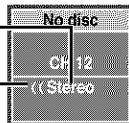

■ While playing HDD or DVD-RAM

LR → L → R

e.g., "L R" is selected



- If you have recorded an SAP broadcast by pressing [AUDIO] to select SAP
MAIN ↔ SAP

For your reference

You can change the audio for the images being played with simultaneous rec and play and Time Slip.

■ While playing DVD-R

You cannot change audio type.

■ While playing DVD-Video

You can change the audio channel number each time you press the button. This allows you to change things like the soundtrack language.



e.g., English is the selected language.



The language is switched to French.

■ While playing Video CD

LR → L → R

e.g., "L R" is selected



Note

If you cannot change the audio type when you have used only an optical digital cable for connection, set "Dolby Digital" to "PCM" (→page 62). Alternatively, you may connect to an amplifier with an audio/video cable and change the input on the amplifier to suit the connection.

Note

- If you alter the sound setting during recording, the sound will be altered in the recording itself also.
- It will not be possible to alter the sound by pressing [AUDIO] in the following cases:
 - When the DVD drive is selected and a DVD-R is in the disc tray.
 - When recording mode is XP and LPCM has been selected in the SETUP menu, Audio Mode for XP Recording (→page 61).
- You cannot change audio type while recording with DVD-R or recording on DVD-RAM with LPCM sound. You can use the SETUP menus to select which audio type of an SAP broadcast is recorded, either "Main" or "SAP" (→page 61, Audio—Select MTS for DVD-R or LPCM).
- When recording through the DV input terminal, the unit records the audio data as is from the tape, irrespective of the type you select with [AUDIO] (→page 61, "Select Audio CH for DV input").

Recording from an external device

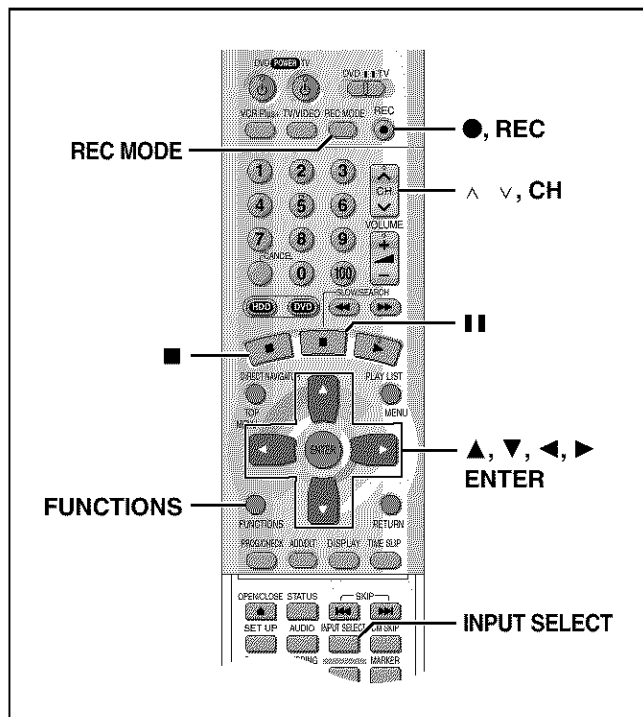

Recording from a video cassette recorder

HDD RAM DVD-R

Preparation

- Connect a video cassette recorder to this unit's input terminals (→page 58).
- Connect DV equipment through the DV input terminal for better results. Before connecting, turn this unit and the equipment to be connected off. After connecting, turn the DV equipment on before turning the unit on.

- 1 While stopped**
Press **[INPUT SELECT]** to select the input channel for the equipment you have connected.
Select L1, L2, L3 or DV.
• You can also select the input channel by pressing [**^** **v**, **CH**].
- 2 Press [REC MODE]** to select the recording mode (XP, SP, LP or EP).
- 3 Start play on the other equipment.**
- 4 Press [●, REC]** at the point you want to start recording.
Recording starts.

To skip unwanted parts

Press **[II]** to pause recording. (Press again to restart recording.)

To stop recording

Press **[■]**.

Note

- If flexible recording (→page 20) is used instead of steps 2 and 4, settings can be made so that recording continues to the end of the video.
- In the case of some DV equipment (e.g., Digital Video Camera), pictures and sound may not be received properly.
- The audio recorded through the DV Input terminal is the audio selected at "Select Audio CH for DV input" (→page 61).

Almost all videos and DVD software on sale have been treated to prevent illegal copying. Any software that has been so treated cannot be recorded using this unit.

DV Automatic Recording (DV AUTO REC)

HDD RAM

If you connect a DV equipment (e.g., Digital Video Camera) to the DV input terminal on the front of the unit (→page 58) and record, automatic generation of programs and play lists is possible.

Preparation

- Turn off this unit and the equipment to be connected. Only turn the power on again after connecting the equipment to the DV Input terminal (→page 58, **A**).
- Pause play of the DV equipment at the point you want recording to start.

- 1 While stopped**
Press **[REC MODE]** to select the recording mode (XP, SP, LP or EP).
- 2 Press [FUNCTIONS].**
The FUNCTIONS window appears (→page 53).
- 3 Press [**▲**, **▼**, **◀**, **▶**] to select "DV AUTO REC" and then [ENTER].**
DV AUTO REC screen appears.
(The DV equipment pauses automatically if it was playing.)
- 4 Press [**◀**, **▶**] to select "Rec" and then [ENTER].**
Recording starts.

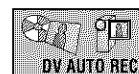

To stop recording

Press **[■]**.

When recording finishes

The confirmation screen appears. Press **[ENTER]** to finish DV auto recording.

Note

- If recording does not begin or is interrupted, check the connections and settings of the equipment.
- It is not possible to carry out Chasing play or Simultaneous rec and play of the program that are being recorded.
- The DV equipment name may not be shown correctly.
- If "Cannot detect DV connection" is displayed on the television, turn the DV equipment off and on once again.
- You cannot start recording until the images from the DV equipment appear on the television.
- Do not operate the DV equipment during recording, as this will cause recording to stop.
- Recording may not be performed as desired if the time codes on the tape in the DV equipment are not successive.
- During copying, a marker is automatically assigned to points in the original recording where recording was stopped or paused.
- The date and time information on the tape of the DV equipment will not be recorded.
- Depending on the equipment, the DV Automatic Recording may not operate properly.
- The audio recorded is the audio selected at "Select Audio CH for DV input" (→page 61).

Dubbing programs or play list

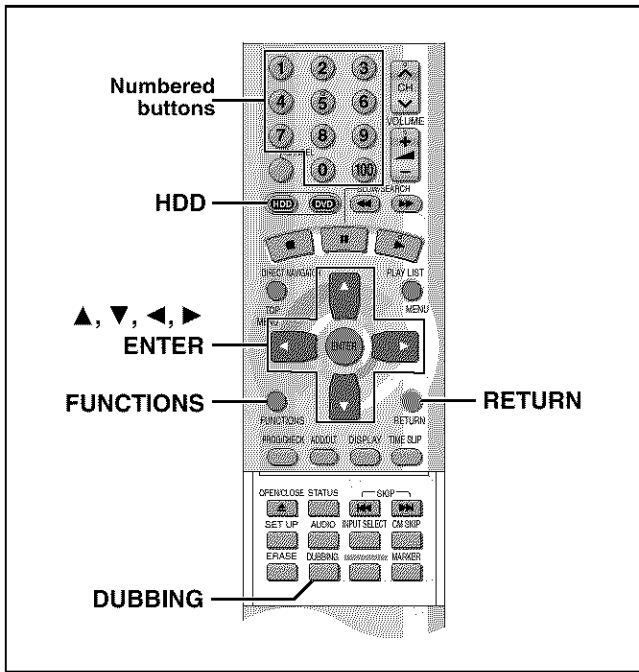

HDD | RAM | DVD-R

- It is possible to dub a program or play list to another drive.
- Dubbing a play list will create a program.
- You can dub a maximum of 250 programs to HDD and 99 programs to DVD-RAM or DVD-R.

Preparation

Press [HDD] to select HDD drive.

- You can select the kind of picture display using "Dubbing Aspect" (→page 61).
- When dubbing SAP broadcast using a recording mode other than "High Speed", the kind of sound may be selected at "Select dubbing Audio to DVD-RAM".
- When dubbing SAP broadcast to DVD-R or dubbing sound using LPCM, the setting at "Select MTS for DVD-R or LPCM" is given priority (→ Audio, page 61).

1 While stopped
Press [FUNCTIONS].

The FUNCTIONS window appears (→page 53).

2 Press [▲, ▼, ◀, ▶] to select "DUBBING" and press [ENTER].



e.g., Dubbing from HDD to DVD-RAM

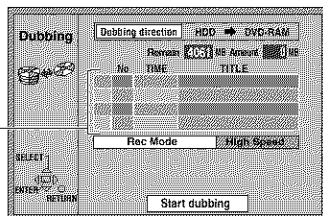

Dubbing list table

3 Select the dubbing direction.

- ① While selecting "Dubbing direction" Press [ENTER].
- ② Press [▲, ▼] to select the dubbing direction and press [ENTER].

4 Select items for dubbing.

- ① Press [▲, ▼] to select the dubbing list table and press [ENTER]. Dubbing List appears.

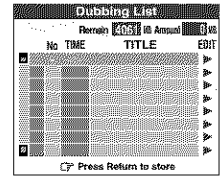

- ② Press [▲, ▼] to select "--:--:" and press [ENTER]. Dubbing select screen appears.

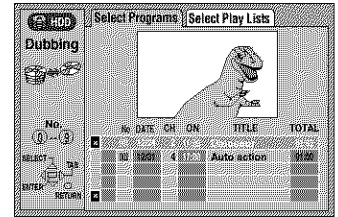

- ③ Press [◀, ▶] to select "Select Programs" or "Select Play Lists".
- ④ Press [▲, ▼] to select the program or play list for dubbing and press [ENTER].

- Repeat steps 4-② to 4-④ to register more than one. (Check that the dubbing list "Amount" does not exceed the "Remain" indicated).

- You can also select the program or play list with the numbered buttons (0, 1-9).

e.g., **HDD programs or Play lists**

"5": [0] → [0] → [5]

"15": [0] → [1] → [5]

DVD-RAM programs

"5": [0] → [5]

"15": [1] → [5]

- ⑤ Press [RETURN].

Return to step 2.

5 Select the recording mode.

- ① Press [▲, ▼] to select "Rec Mode" and press [ENTER].
- ② Press [▲, ▼] to select the recording mode and press [ENTER].

Dubbing direction	Recording mode					
	High Speed	XP	SP	LP	EP	FR
HDD → RAM	○*1	○	○	○	○	○
HDD → DVD-R	×	○	○	○	○	○
RAM → HDD	○*2	×	×	×	×	×

*1 Cannot be selected for programs with recording limit or play list.

*2 Cannot be selected for play list.

6 While the screen in step 2 is displayed

Press [▲, ▼] to select "Start dubbing" and press [ENTER].

The confirmation screen will be displayed.

Press [◀, ▶] to select "Yes" and press [ENTER] to start dubbing.

To stop dubbing

Press and hold [RETURN] for 3 seconds.

- Stopping dubbing in High Speed mode partway through will cancel the recording and any data recorded up to that point will be lost. In all other recording modes, if dubbing is stopped partway through, the part recorded up to that point will be recorded as one complete program.

To add or remove from the dubbing list

While the Dubbing List (→ step 4-①) is displayed

- ① Press [▲, ▼] to select the dubbing list and press [▶].

- ② Press [▲, ▼] to select an item and press [ENTER].

- If you select "Add", carry out steps 4-③ and 4-④. Addition will take place above the program selected in step ①.

















- If you select "Erase" or "Erase All", a confirmation screen will be displayed. Press [◀, ▶] to select "Yes" or "No" and press [ENTER] (Return to Dubbing List).

Note

- The contents of dubbing lists will remain in the memory even after the power has been turned off. In the case of the DVD drive, the contents are erased if [▲] is pressed. However, note that if programs and play lists are erased, all the dubbing lists will also be erased.
- It is not possible to activate timer recording during dubbing.
- Even if you select a higher picture quality recording mode than that of the dubbing source, it will not be possible to obtain picture quality better than the dubbing source (although selection may be effective in combating loss in picture quality during recording).
- When dubbing a program, playlists made from that program will not be dubbed.
- The program settings (protect, etc) are reproduced in the dubbed material. (If you select a recording mode other than "High Speed", markers are not reproduced).
- Still pictures in programs and play lists (displayed with an  in the Dubbing select screen) cannot be dubbed. **RAM**

Recording Limits

Some programs may not be recordable or may have limits on number of times they can be dubbed. Refer to the table below for details about storage media and associated limits.

Recording limit	Usable Media for dubbing/transferring
No recording limit	   
	  
	   You cannot dub.
Recording limited to one time	  
	   *
	 You cannot record on DVD-R.

* Can be dubbed to HDD but cannot be played back.

- If a program with recording limitations is dubbed from HDD to DVD-RAM, the program is transferred (i.e. it is moved to another storage media). The original program (including play list scenes made from that program) are erased. When a program with recording limitations enters a dubbing list, " (Transfer) is displayed and a message screen is displayed when dubbing.
- Programs with recording limitations and play lists cannot be registered on the same dubbing list.
- Play lists made from programs with recording limitations cannot be dubbed.

One Touch Dubbing (HDD → DVD)

Programs and play lists currently being played back on HDD can simultaneously be dubbed to DVD-RAM or DVD-R.

Preparation

Press [HDD] to select HDD drive.

- 1 During play or while paused**
Press [DUBBING].

The confirmation screen appears.

- 2 Press [◀, ▶] to select "Yes" and press [ENTER].**

To stop dubbing

Press and hold [RETURN] for 3 seconds.

- Stopping dubbing in High Speed mode partway through will cancel the recording and any data recorded up to that point will be lost. In all other recording modes, if dubbing is stopped partway through, the part recorded up to that point will be recorded as one complete program.

Note

- This function works while either the program list or play list screen is being displayed.
- Usually, dubbing takes place using "High Speed" mode for DVD-RAM or the recording mode of the dubbing source for DVD-R. However, with the following exceptions the recording mode is changed automatically to "FR":
 - when the program will not fit onto the disc if recorded using the recording mode of the dubbing source.
 - when dubbing play lists.
- It is not possible to activate timer recording during dubbing.
- Programs with recording limitations (including play lists made from those programs) cannot be dubbed.

Timer recording

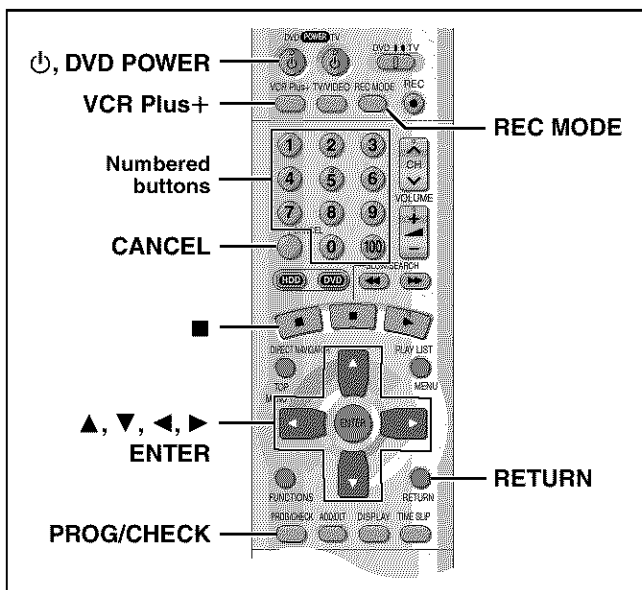

3 Press [ENTER].

The timer recording setting screen appears. Confirm the program and make corrections if necessary using [▲, ▼, ◀, ▶].

- To select the recording drive
 - ① Press [◀, ▶] to select "DRIVE".
 - ② Press [▲, ▼] to select "HDD" or "DVD".
- To change the recording mode

Press [REC MODE].
- To enter the title of the program

Press [◀, ▶] to select "Enter Title" (→page 45) and press [ENTER].

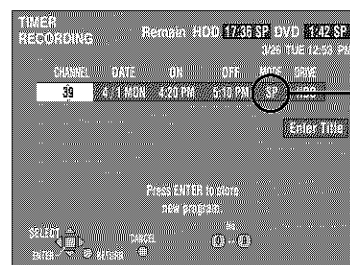

The current recording mode (shown on the unit's display) is automatically selected.

▽ When you press [ENTER]

The timer recording list appears.

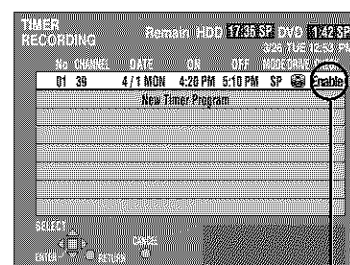

Displayed if the recording can fit in the remaining space on the HDD or disc.

Repeat steps 1–3 to program other recordings.

4 Press [RETURN].

The timer recording list disappears and the unit enters Timer Recording standby mode ("□" appears on the unit display).

- The unit is not off. To save power, turn the unit off by pressing [⏻, DVD POWER].

Note

- The actual time recorded may be longer than the program itself when television programs are recorded using VCR Plus+.
- If the recording mode is not selected, the default setting will be the setting on the unit at the time of setting timer recording (except for when "XP" is selected, in which case the recording will be made in "FR").
- "Invalid Entry" is displayed when you enter the wrong code. Reenter the code.
- "All timer programs are occupied." appears if there are already 32 programs.

Timer recording

HDD RAM DVD-R

Preparation

- Ensure the clock (and guide channels for VCR Plus+ recording, → page 14) are set correctly.
- Cancel Disc Protection (→page 38) or Cartridge Protection (→page 8) if they are currently set. **RAM**

Using VCR Plus+ codes to make timer recordings

Entering VCR Plus+ codes is an easy way of programming the unit for recording. You can find these codes in newspapers and magazines. You can enter up to 32 programs up to a month in advance.

1 Press [VCR Plus+].

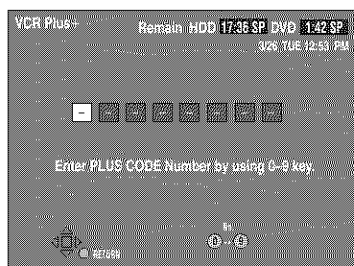

2 Press the numbered buttons to enter the VCR Plus+ code.

Press [◀] to move back to correct a digit.



Manually programming timer recordings

You can enter up to 32 programs up to a month in advance. Each daily or weekly program is counted as one program.

1 Press [PROG/CHECK].

The timer recording list appears.

A line that is ready for programming is highlighted.

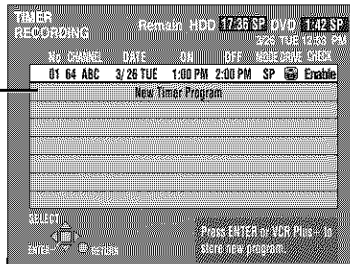

2 Press [ENTER].

The timer recording setting screen appears.

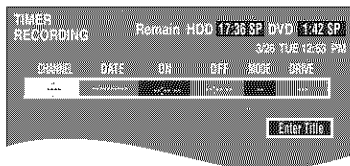

3 Press [▶] to move through the items and change the items with [▲, ▼].

- The current settings are shown each time you press [▶].
- You may use the numbered buttons to enter the CHANNEL, DATE, ON (Start Time), and OFF (Finish Time).

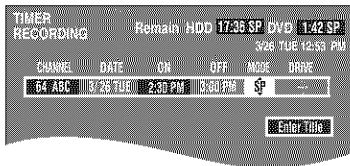

• CHANNEL (Channel number and caption)

• DATE

Current date---→the day before one month later→
SUN-SAT→MON-SAT→MON-FRI→
WEEKLY SUN---→WEEKLY SAT (→Return to Current date)

• ON (Start time)/OFF (Finish time)

The time increases or decreases in 30-minute increments if you hold the button.

• MODE (Recording mode →page 19)

SP→XP→FR→EP→LP (→Return to SP)

• DRIVE

HDD↔DVD

• RENEW

(Only when you set daily or weekly recording onto HDD
→page 36, Auto Renewal Recording)
ON↔OFF

• Enter Title

Select "Enter Title" using [◀, ▶] and press [ENTER] (→page 45).

4 Press [ENTER] when you have finished programming the timer.

The timer recording list reappears.

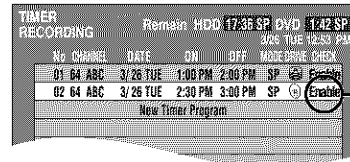

Displayed if the recording can fit in the remaining space on the disc.

- Press [▲, ▼] to select "New Timer Program" and repeat steps 2- 4 to program other recordings.

5 Press [PROG/CHECK] or [RETURN].

The timer recording list disappears and the unit enters Timer Recording standby mode ("□" appears on the unit display). The unit is not off. To save power, turn the unit off by pressing [⏻, DVD POWER].

Notes on timer programming

To cancel the unit from recording standby

Cancel all the timer recording programs using [CANCEL] (→page 37).

To stop recording when recording has already begun

While the recording drive is selected

Press [■], then [ENTER] within 5 seconds.

(Recording stops.)

- The remaining time displayed is based on the current recording mode.
- Scheduled timer recordings will be activated even if playback or other recording is already taking place.
- When recording more than one program in a row, for HDD and DVD-RAM the first few seconds, and for DVD-R about the first 30 seconds of all programs from the second one onwards will not be recorded.
- Timer recording will not be activated if editing, dubbing or Plug-in Auto Tuning (→page 12) is being carried out.
- If you set DST (Daylight Saving Time) to ON when manually setting the clock (→page 64), timer recording may not work when summer switches to winter and vice versa.
- When timer recording starts, the record lamp (→page 7, Main unit) lights, even if the unit is off.

Relief Recording

When the recording drive is set to "DVD" for timer recording, the unit will automatically evaluate if the program will fit onto the disc before beginning recording. If the program will not fit then the recording drive will be altered to "HDD" automatically.

- If the time remaining on the HDD is insufficient, as much of the program as possible will be recorded onto the HDD.
- If there is no disc in the tray or the disc cannot be recorded on, the recording drive will be altered to HDD.
- The recording mode will not be altered.
- The Direct Navigator shows which programs were relief-recorded (→page 26).

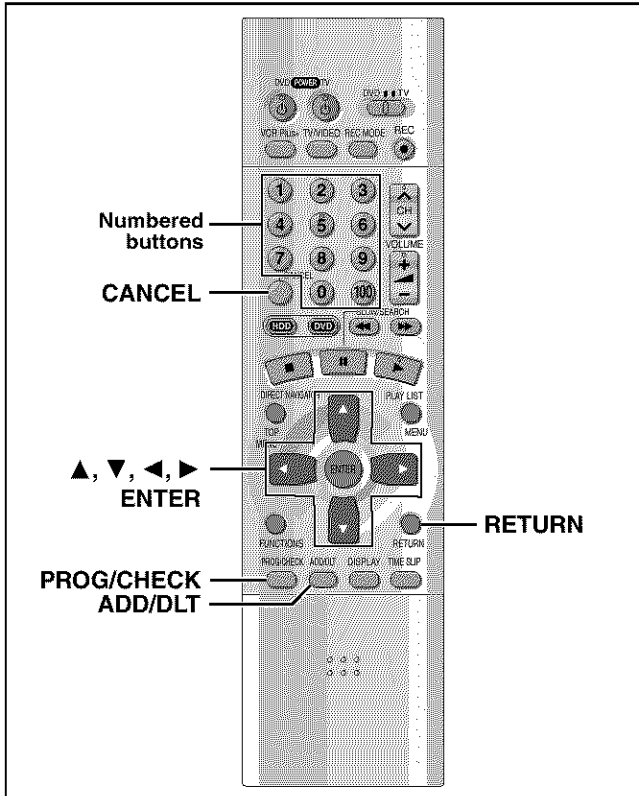

Auto Renewal Recording

If you record a program onto HDD repeatedly everyday or every week using timer recording, the unit will record the new program over the old one.

This function can be used only when weekly recording or daily recording is selected for "DATE".

1 While the timer recording list (→page 35, step 4) is displayed Press [**▲**, **▼**] to select the program and then [**ENTER**].

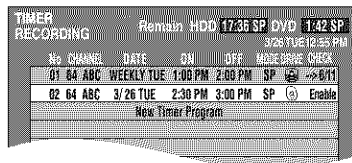

2 Press [**◀**, **▶**] to select "RENEW".



3 Press [**▲**, **▼**] to select "ON" and then [**ENTER**].
The timer recording list reappears.

Note

- If a program set for Auto Renewal Recording is protected, the program will not be overwritten. Instead the program set for recording will be saved as a separate program, and this program will be the one to be overwritten when the next Auto Renewal Recording takes place.
- When play back is taking place from the HDD, auto renewal recording will not be carried out. The program supposed to be auto renewal recorded will be recorded as a separate program.
- Play list scenes made from programs that were set for Auto Renewal Recording are erased along with auto renewal.
- When there is not enough space on the HDD, the program may not be recorded completely (even if repeating a renewal recording).

Check programs

1 Press [**PROG/CHECK**].

The timer recording list appears.

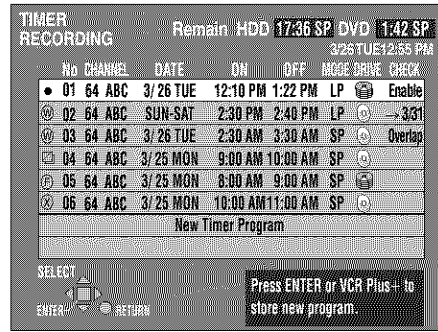

Icon explanations

- Ⓜ The times overlap those in another program.
- This program is currently recording.
- Ⓢ The disc was full or the maximum number of programs or scenes was reached so the program failed to record.
- Ⓜ The material was copy-prohibited so it was not recorded.
- ⓧ The program failed to record for some other reason.
- Programs that failed to record are displayed gray. They are automatically deleted from the timer recording list after 4:00 AM on the second day after recording was scheduled.

Auto Renewal Recording indicator **HDD**

The program will be automatically recorded over in succession.

Relief Recording indicator

Programs that have been rerouted to the HDD because of insufficient space.

Recording drive indicator

HDD DVD

Message displayed in the CHECK line

Some of the information shown in the CHECK line may not be correct while you are recording.

Enable: Displayed if the recording can fit in the remaining space on the disc.

→ **(Date):** For recordings made daily or weekly, the display will show until when recordings can be made (up to a maximum of one month from the present time) based on the time remaining on the disc.

!: It may not be possible to record because there is no more space left on both HDD and DVD-RAM/R.

2 Press [**PROG/CHECK**] or [**RETURN**].

Change or delete the program

- 1 Press [PROG/CHECK].** 
The timer recording list appears.
- 2 Press [▲, ▼] to select the program.**
 - You may also select programs by inputting a 2-digit number using the numbered buttons.
 - Press [◀, ▶] to move to the page preceding or following the one on display.
- 3 Press [CANCEL] or [ADD/HLT] to delete, or press [ENTER] to change.**
You cannot delete programs that are currently recording.
The timer recording setting screen appears.
- 4 If you pressed [ENTER] in step 3, Move through the items with [◀, ▶] and change the settings with [▲, ▼] and press [ENTER].**
- 5 Press [PROG/CHECK] or [RETURN].**

Note

- A Timer recording that is taking place in a recording mode other than "FR" may have its end time altered.
- Even if the power is off you can still view timer recording information by pressing [PROG/CHECK].

HDD, Disc setting

Operation

Preparation

Press [HDD] or [DVD] to select the drive.

While stopped
Press [FUNCTIONS].

Press [▲, ▼, ◀, ▶] to
select "DISC SETTING"
and press [ENTER].



e.g., DVD-RAM

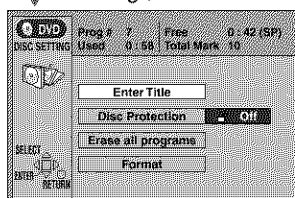

Press [▲, ▼] to select
the item and press
[ENTER].

Editing

To stop set up process
Press [RETURN].

- You can also use [▲, ▼, ◀, ▶] to select "Cancel" or "No" and press [ENTER].

Enter Title

RAM DVD-R

You can enter up to 64 characters (DVD-RAM) or 40 characters (DVD-R).

Entering text → page 45

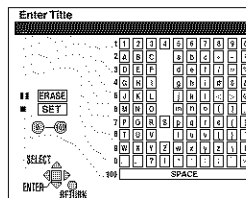

Disc Protection

RAM



If set, this will protect the disc from accidental erasure.

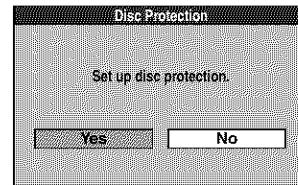

Erase all programs

HDD RAM

All programs and play lists created from them will be erased irretrievably when you use this procedure. Check carefully before proceeding.

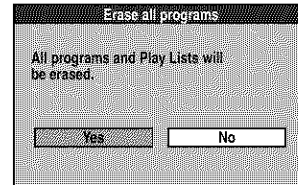

Note

Cancel Disc Protection (→ above) or Cartridge Protection (→ page 8) if they are currently set. **RAM**

Format



HDD

Erase the entire contents on the HDD.

RAM

Some DVD-RAM are unformatted. Format them before using them in this unit. Formatting also allows you to erase the entire contents of a disc.

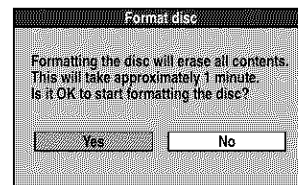

e.g., DVD-RAM

Note

If the disc is dirty, clean it with the recommended cleaner (→ page 10) before formatting. **RAM**

DVD-R Menu Screen

DVD-R

Prior to finalizing, you can select the background (9 kinds) that will be displayed as the DVD Video top menu after finalizing.

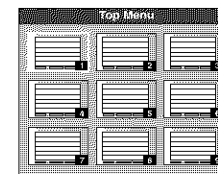

Finalize

DVD-R

You can play DVD-R on compatible DVD players by finalizing them on this unit, effectively making them into DVD-Video.

For your reference

- You can only finalize DVD-R recorded on this unit.
- You cannot record or perform editing such as giving titles and erasing programs on DVD-R that have been finalized.
- The markers you entered (→ page 28) will be lost.

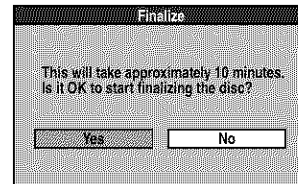

Note

- Cancel Disc Protection (→ page 38) or Cartridge Protection (→ page 8) if they are currently set. **RAM**
- If you enter a long title, only part of it is shown in the menu screen after finalization. **DVD-R**

Press [◀] to set (or cancel) disc protection and press [ENTER].

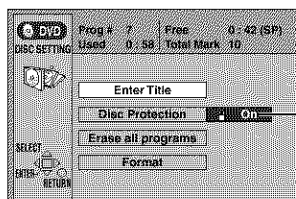

The lock symbol appears closed when the disc is write-protected.

Press [◀] to select "Yes" and press [ENTER].

Press [◀] to select "Start" and press [ENTER].

All programs and play lists are erased.

Note

- Computer data or still pictures (JPEG) cannot be erased.
- The contents on the disc are erased even if you have set program protection.

Press [◀] to select "Yes" and press [ENTER].

Press [◀] to select "Start" and press [ENTER].

Formatting erases all contents on the disc, including computer data or still pictures. Check carefully before proceeding.

Formatting starts.

Do not turn the unit off or disconnect the AC power supply cord while the message "Formatting the disc" is on the television. This can render the disc unusable. A message appears when formatting is finished. Press [ENTER] to complete the procedure.

Note

- Formatting takes up to a maximum of 70 minutes (DVD-RAM) or 1 minute (HDD).
- The contents on the disc are erased when you format it even if you have set program or disc protection. **RAM**
- The disc cannot be formatted if Cartridge Protection is activated (→ page 8). **RAM**
- It may not be possible to use a disc on this unit if you cannot format it. **RAM**
- Formatting cannot be performed on DVD-R or CD-R/RW.

To stop formatting **RAM**

Press [RETURN].

You can cancel formatting if it takes more than 2 minutes. The disc must be reformatted if you do this.

Press [▲, ▼, ◀, ▶] to select the background and press [ENTER].

The DISC SETTING menu screen reappears.

Press [◀] to select "Yes" and press [ENTER].

Press [◀] to select "Start" and press [ENTER].

Finalizing starts.

Do not turn the unit off or disconnect the AC power supply cord while the message "Finalizing the disc" is on the television. This will render the disc unusable. Finalizing takes up to 15 minutes. A message appears when finalizing is finished. Press [ENTER] to complete the procedure.

After finalizing...

The video and audio is recorded according to the DVD-Video specifications, and your very own DVD-Video is created.

- Programs longer than 5 minutes are divided into about five-minute chapters.
- These DVD-R can be played on other Panasonic DVD players, but this is not guaranteed. Play may not be possible due to the player you are using, the DVD-R, or the condition of the recording. Play the disc using this unit if you experience problems with other equipment. Visit Panasonic's homepage for more information about DVDs. <http://www.panasonic.com/playDVD-R>

Editing programs

Operation

Preparation

Press [HDD] or [DVD] to select the drive.

Press
[DIRECT NAVIGATOR].

e.g., DVD-RAM

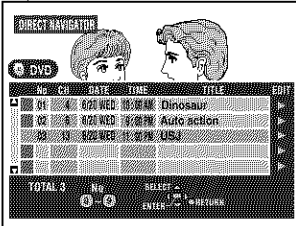

Press [▲, ▼] to select the program.

- You can also select programs by entering a 2-digit number with the numbered buttons. e.g.: "5": [0] → [5]

Press [▶] so the submenu appears.

Press [▲, ▼] to select the item and press [ENTER].

Numbered buttons

HDD, DVD

DIRECT NAVIGATOR

▲, ▼, ◀, ▶

ENTER

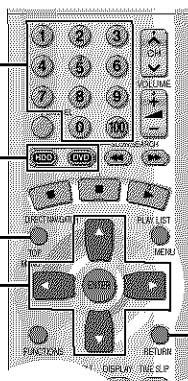

RETURN

To clear the program list
Press [RETURN].

To stop set up process
Press [RETURN].

- You can also use [▲, ▼, ◀, ▶] to select "Cancel" or "No" and press [ENTER].

For your reference

You can only access "Properties" if Disc Protection (→ page 38) or Cartridge Protection (→ page 8) is activated. Deactivate the protection to access other items.

RAM

Erase Program

HDD RAM DVD-R



All programs and play lists created from them will be erased irretrievably when you use this procedure. Check carefully before proceeding.

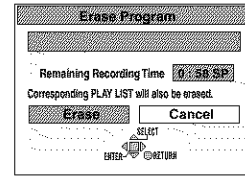

Enter Title

HDD RAM DVD-R

You can enter up to 64 characters (HDD, DVD-RAM) or 44 characters (DVD-R).

Entering text → page 45

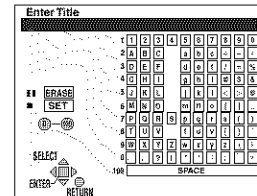

Properties

HDD RAM DVD-R

Program information (e.g., time and date) is shown.

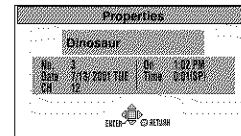

Protection

HDD RAM

If set, this will protect the program from accidental erasure.

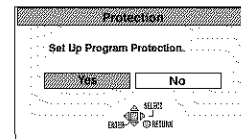

Shorten Segment

HDD RAM

The program segment, and play list scenes created from it, are erased irretrievably when you use this procedure. Check carefully before proceeding.

e.g., DVD-RAM



Divide Program

HDD RAM

Select a point at which to divide the program into two.

You must be sure you wish to divide a program because once a program has been divided, it cannot be returned to its original form.

e.g., DVD-RAM

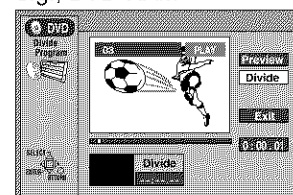

Press [◀] to select "Erase" and press [ENTER].

The program is erased.

Note

- The disc's available recording time may not increase after erasing short programs.
- Computer data cannot be erased.
- The available recording time on DVD-R does not increase when you erase programs.

Note

- Cancel Disc Protection (→ page 38) or Cartridge Protection (→ page 8) if they are currently set. **RAM**
- The full title is shown in the Properties screen, but if you enter a long title, only part of it is shown in the program list.
- If you enter a long title, only part of it is shown in the menu screen after finalization. **DVD-R**

Press [◀] to set (or cancel) protection and press [ENTER].

The lock symbol appears when the program is write-protected.

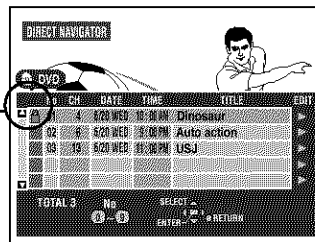

Press [ENTER] at the start point of the section you want to erase.

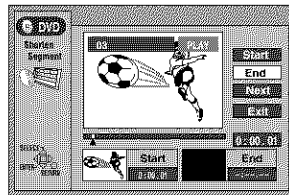

Press [ENTER] at the end point of the section you want to erase.

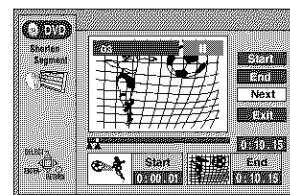

Press [▲, ▼] to select "Exit" and press [ENTER].

Press [▲, ▼] to select "Next" and press [ENTER], then press [◀] to select "Erase" and press [ENTER].

Repeat to enter other sections.

- Use search and slow-motion to find the start and end points.
- Play pauses if the end of the program is reached during this procedure.
- You may not be able to specify points within 3 seconds of each other.
- You cannot specify an end point before a start point, or a start point after an end point.
- You cannot specify points on still pictures in the program.
- The disc's available recording time may not increase after erasing short segments.

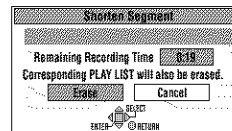

Press [◀] to select "Erase" and press [ENTER].

Press [ENTER] at the point you want to divide the program.
To change the division point → below

Press [▲, ▼] to select "Exit" and press [ENTER].

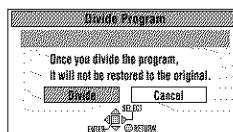

The program is divided.

Press [◀] to select "Divide" and press [ENTER].

To confirm the division point

Press [▲, ▼] to select "Preview" and press [ENTER]. (Play will begin from a point 10 seconds prior to and after the division point.)

To change the division point

Press [▲, ▼] to select "Divide" and press [ENTER] at the point you want to change.

Note

- The divided programs retain the title of the original program. They also retain the CPRM property (→ page 8) of the original.
- A minute portion of the recording directly preceding the division point may be lost.
- It is not possible to carry out Divide Program in the following cases:
 - when the program is extremely short.
 - when the total number of programs is more than 250 (HDD) or 99 (DVD-RAM).

Operation

Preparation

Press [HDD] or [DVD] to select the drive.

While stopped
Press [PLAY LIST].

e.g., DVD-RAM

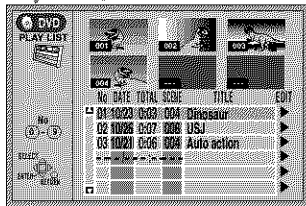

Press [▲, ▼] to select the list.

- To create a new list, select "—" and press [ENTER] (→ page 44).

Press [▶] so the submenu appears.

Press [▲, ▼] to select the item and press [ENTER].

Numbered buttons

HDD, DVD

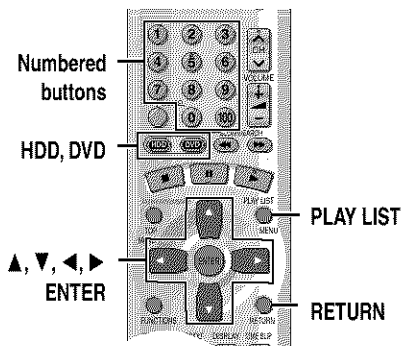

To clear the play list or scene list screen

Press [RETURN].

To stop set up process

Press [RETURN].

- You can also use [▲, ▼, ◀, ▶] to select "Cancel" or "No" and press [ENTER].

For your reference

You can only access "Play Scenes" and "Properties" if Disc Protection (→ page 38) or Cartridge Protection (→ page 8) is activated. Deactivate the protection to access other items. **RAM**

Play Scenes

→ page 27, Playing play list scenes

HDD RAM

Edit Scenes

HDD RAM

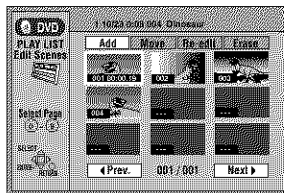

Press [◀, ▶] to select the item (Add, Move, Re-edit or Erase) and press [ENTER].

- Press [▲, ▼, ◀, ▶] to select "Next" and press [ENTER] to show scene 10 and later.
- You can also select a page of scenes by entering a 3-digit number with the numbered buttons.
e.g.: "5": [0] → [0] → [5]
"15": [0] → [1] → [5]
- HDD or one disc can have a maximum of 99 play list and 999 scenes. These limits may be reduced under some conditions.

PL Copy

HDD RAM

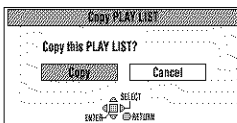

Press [◀] to select "Copy" and press [ENTER].

The copied play list appears at the bottom of the list.

PL Erase

HDD RAM

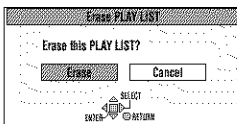

Press [◀] to select "Erase" and press [ENTER].

The play list is erased.

Once a play list has been erased, it is irretrievable. Check carefully before proceeding.

Enter Title

HDD RAM

You can enter up to 64 characters. The full title is shown in the Properties screen, but if you enter a long title, only part of it is shown in the play list screen.

Entering text → page 45

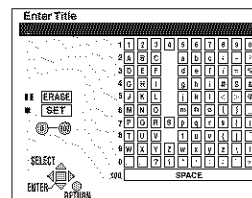

Properties

HDD RAM

Play list information (e.g., time and date) is shown.

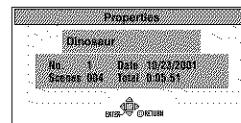

■ Add (maximum 999 scenes)

Press [▲, ▼, ◀, ▶] to select the place where you want to add the scene and press [ENTER].

Press [ENTER] at the start point of the scene.

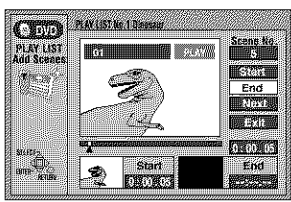

Press [ENTER] at the end point of the scene.

Press [▲, ▼] to select "Exit" and press [ENTER]. The new scene is inserted before the highlighted scene.

Press [▲, ▼] to select "Next" and press [ENTER]. (Repeat to add other scenes.)

■ Move

Press [▲, ▼, ◀, ▶] to select the scene and press [ENTER].

Press [▲, ▼, ◀, ▶] to list the position to which you want to move the scene and press [ENTER]. The scene is moved and inserted before the highlighted scene.

Repeat to move other scenes.

The scene is moved.

■ Re-edit

Press [▲, ▼, ◀, ▶] to select the scene and press [ENTER].

Press [ENTER] at the start point of the scene.

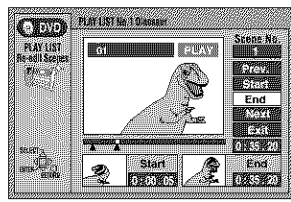

Press [ENTER] at the end point of the scene.

Press [▲, ▼] to select "Exit" and press [ENTER]. The re-edited scene replaces the old one.

Press [▲, ▼] to select "Prev." or "Next" and press [ENTER]. (Repeat to re-edit other scenes.)

■ Erase

Once a scene has been erased, it is irretrievable. Check carefully before proceeding.

Press [▲, ▼, ◀, ▶] to select the scene and press [ENTER].

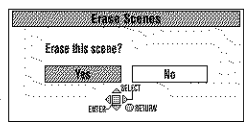

Press [◀] to select "Yes" and press [ENTER].

Repeat to erase other scenes.

- The selected scene is erased from the play list.
- The play list itself is erased if you erase all the scenes in it.

Note

- Use search and slow-motion to find the start and end points.
- You cannot specify an end point before a start point, or a start point after an end point.
- You may not be able to specify points within 3 seconds of each other.
- Play pauses if the end of the last program is reached during this procedure.
- You cannot edit still picture images.
- Depending on the state of recording, the actual number of play lists or scenes that can be recorded may be less than that specified in this manual.
- The picture illustration on the right may be shown in the HDD play list scene display. This picture illustration indicates pictures that are permitted to be recorded only once.



Creating play lists

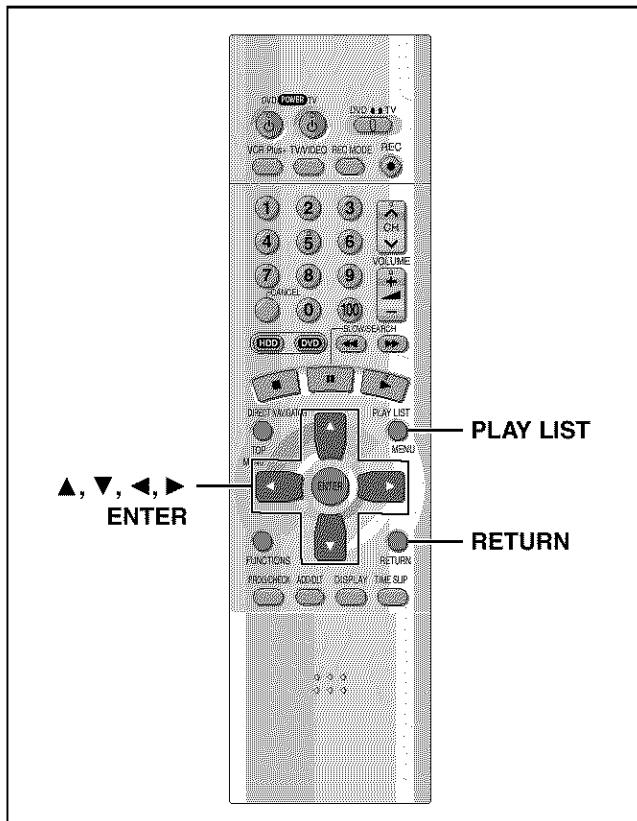

HDD RAM

Specify start and end points to create scenes, then specify the order in which they are to be played. These scenes are not recorded separately so this doesn't use much capacity.

You can create a maximum of 99 play lists and 999 scenes on a DVD-RAM and HDD.

- 1 While stopped
Press [PLAY LIST].
- 2 Press [▲, ▼] to select “---/---” and press [ENTER].

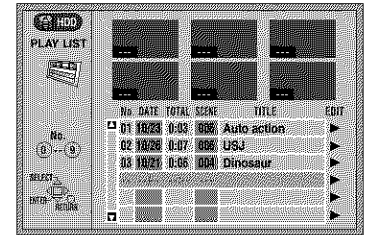

- 3 Press [ENTER] at the start point.

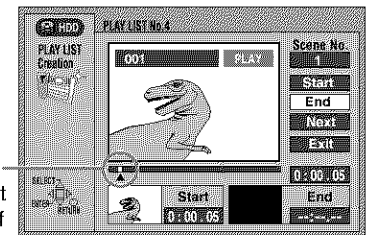

HDD: The location of the whole program's start point
DVD-RAM: The location of the whole disc's start point

- 4 Press [ENTER] at the end point.

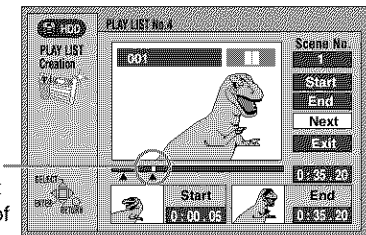

HDD: The location of the whole program's end point
DVD-RAM: The location of the whole disc's end point

To specify another scene

Select "Next" and press [ENTER], then repeat steps 3 and 4.

- 5 Press [▲, ▼] to select “Exit” and press [ENTER].

The play list screen appears.

To clear the play list screen

Press [RETURN].

To stop partway through

Press [RETURN].

For your reference

- You cannot create or edit play lists if the disc is protected. **RAM**
- You cannot specify an end point before a start point, or a start point after an end point.
- You may not be able to specify points within 3 seconds of each other.
- Use search and slow-motion to find the start and end points.
- Play pauses if the end of the last program on the disc is reached during this procedure.
- Depending on the state of recording, the actual number of play lists that can be recorded may be less than that specified in this manual.
- Pressing [◀◀], [▶▶] in step 3 and 4 allows you to select programs in the same drive.

Entering text

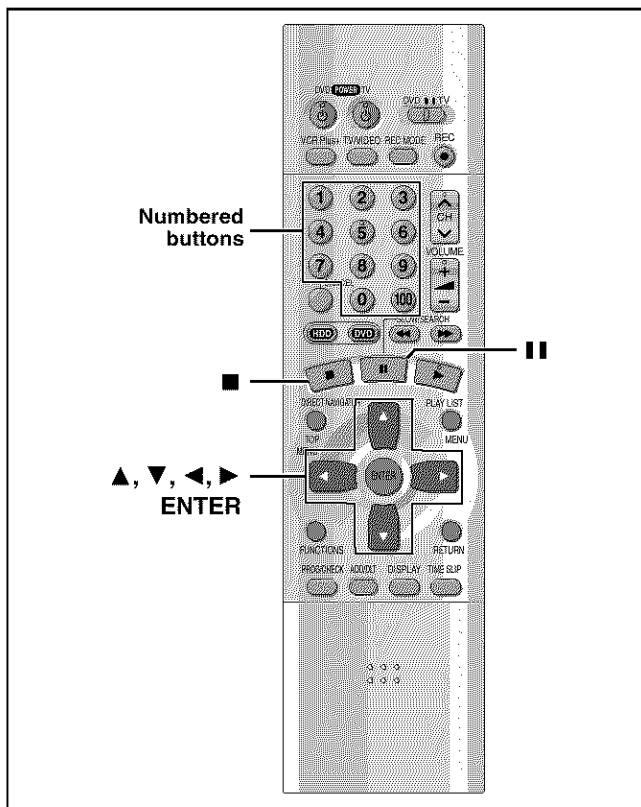

HDD RAM DVD-R CARD

This page shows how to enter text for:

- Disc titles (→page 38)
- Program titles for timer recording (→pages 34 and 35)
- Program titles (→page 40)
- Play list titles (→page 42)
- Folder titles of still pictures (→page 25)

If you give a title to a program when setting timer recording, it will become easier to find the program when using Direct Navigator.

- 1 After the titling screen appears
Press [▲, ▼, ◀, ▶] to select the character and press [ENTER].

Title field: shows the text you have entered

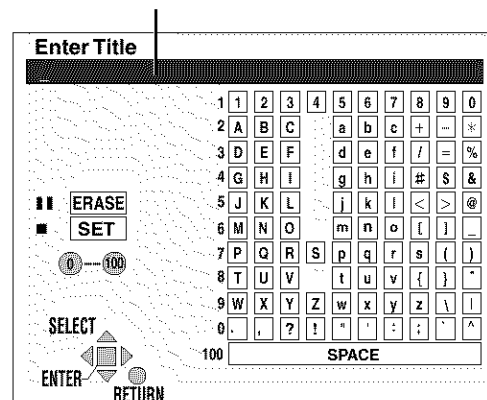

Repeat step 1 to enter other characters.

- 2 Press [■].

The title is entered and the screen disappears.

- You can also finish entering the title by selecting "SET" and pressing [ENTER].

Using the numbered buttons to enter characters

e.g., entering the letter "R"

- 1 Press [7] to move to the 7th row.
- 2 Press [7] twice to highlight "R".
- 3 Press [ENTER].

- You can enter a space by pressing [100] and then [ENTER].

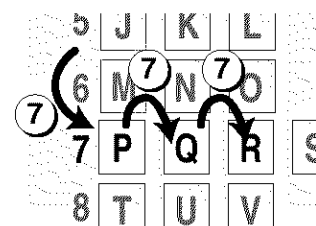

To erase a character

- 1 Press [▲, ▼, ◀, ▶] to select the character you want to erase in the title field.
- 2 Press [■].
You can also erase characters by selecting "ERASE" and pressing [ENTER].

Note

If Disc Protection (→page 38) or Cartridge Protection (→page 8) is activated, you cannot enter the title. Deactivate the protection before entering the title. **RAM**

Operation

While stopped
Press [FUNCTIONS].

Press [▲, ▼, ◀, ▶] to
select "JPEG" and press
[ENTER].

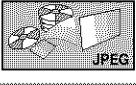

e.g., PC card: First page

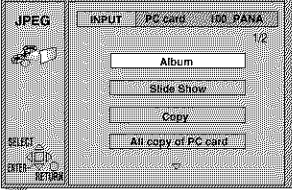

Press [▲, ▼] to select
the item and press
[ENTER].
To select a folder other than the
one currently being displayed,
first highlight "INPUT" and press
[ENTER].

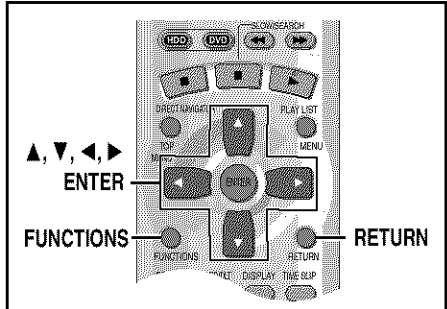

To insert/remove the PC card
(→ page 25)
When the card indicator in the unit display is flashing, the card is being read from or written to. Do not turn off the power or remove the card. Such action may result in malfunction or loss of the card's contents.

To stop set up process
Press [RETURN].

- You can also use [▲, ▼, ◀, ▶] to select "Cancel" or "No" and press [ENTER].

Note
You can only access "INPUT", "Album" and "Slide Show" if the PC card is set to Write Protect (**CARD** → page 9) or if Disc Protection (**RAM** → page 38) or Cartridge Protection is activated (**RAM** → page 8). Deactivate the protection to access other items.

INPUT
CARD HDD RAM

You can select the folder for editing.

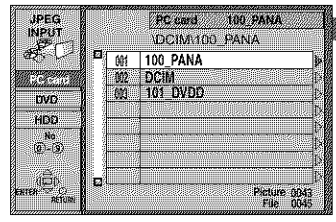

Album
Displaying still pictures (Album Display) → page 25

Slide Show
To display still pictures one by one with constant interval (Slide Show) → page 25

Copy
CARD HDD RAM

You can copy the whole folder or selected still pictures to PC card, HDD or DVD-RAM.
(maximum of 300 folders, 3000 files)

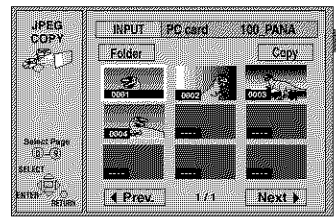

- Note**
- When there is no folder in the copying drive, a new folder will be created.
 - When there is a folder in the copying drive, copying will continue from the last of the existing still pictures.
 - When copying a folder, any files in the folder besides the still pictures are also copied.
 - Folders lower than the folder to be copied will not be copied.
 - If the space on the copying drive runs out or the number of files/folders to be copied exceeds the maximum, copying will stop partway through.
 - If no title has been entered for the folder at the copying drive, the title from the copying source will be entered. It is recommended that the title is entered at the copying source.
 - After copying, it may take some time to download the copying source information.
 - Print (DPOF) number setting (→ page 48) is not transferred.

All copy of PC card
CARD

You can copy the whole contents of the PC card to HDD or DVD-RAM.
(maximum of 300 folders, 3000 files)

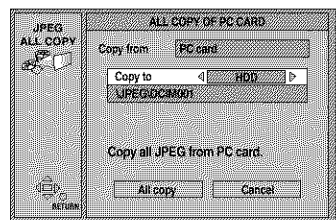

- Note**
- A new folder will be created in the copying drive.
 - Any files in the folder besides the still pictures are also copied.
 - Folders lower than the folder to be copied will not be copied.
 - If the space on the copying drive runs out or the number of files/folders to be copied exceeds the maximum, copying will stop partway through.
 - After copying, it may take some time to download the copying source information.
 - Print (DPOF) number setting (→ page 48) is not transferred.

Erase, Protect, Print (DPOF) → page 48
Settings → page 25, "To change the display timing"
→ page 48, "PC card Format"

Press [◀] and [▲, ▼] to select the drive and press [▶].

Press [▲, ▼] to select still picture's folder and press [ENTER].

To enter the folder's title

Press [▶] to select "Folder Title" and press [ENTER]. (→ Entering text, page 45)

- You can enter up to 36 characters.
- Folder titles entered using this unit will only be displayed using this unit. Folders entered using this unit are written to the TITLE.DVD file.
- If there is not enough space for the entry or if the limit for the number of files has been exceeded (→ Still pictures, page 9), the title cannot be entered.

Note

- "Picture" and "Files" refer to numbers inside the folder selected. Lower files are not included.
- If there is more than one upper folder, pressing [◀◀], [▶▶] will switch between them (→ page 9, "Folders that can be displayed/saved" (underlined section)).

Press [▲, ▼, ◀, ▶] to select a folder or still picture and press [ENTER]. (See below)

A check mark appears on the still picture.



- Repeat this if you select more than one still picture.

Press [▲, ▼, ◀, ▶] to select "Copy" and press [ENTER].

A confirmation screen appears.

Select the copying drive. (→ below)

Press [▲, ▼, ◀, ▶] to select "Copy" and press [ENTER].

Copying still pictures begins.

To select still pictures one by one

Press [▲, ▼, ◀, ▶] to select a still picture and press [ENTER]. (A check mark appears on the still picture.)

To select all the still pictures in the folder

Press [▲, ▼, ◀, ▶] to select "Folder" and press [ENTER]. (A check mark appears on the folder's name; check marks inputted separately will be erased.)

To erase check marks

Press [▲, ▼, ◀, ▶] to select the folder or still picture with the check mark and press [ENTER].

To select the copying drive

While the confirmation screen is displayed

1. Press [▲, ▼] to select "Destination" and press [ENTER].
 2. Press [◀] and [▲, ▼] to select the drive.
 3. Press [▶] and [▲, ▼] to select the folder and press [ENTER].
- Some folders cannot be copied to (→ page 9, "Folders that can be displayed/saved" (indicated by *)).

Press [◀, ▶] to select "HDD" or "DVD".

Press [▲, ▼, ◀, ▶] to select "All copy" and press [ENTER].

All still pictures are copied, and ALL COPY screen reappears.

Note

Still pictures are copied but non-compatible files and folders will not copied. (→ page 9, "Folders that can be displayed/saved").

Operation

While stopped
Press [FUNCTIONS].

Press [▲, ▼, ◀, ▶] to
select "JPEG" and press
[ENTER].

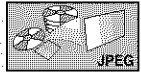

e.g., PC card: Second page

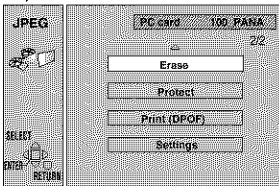

Press [▲, ▼] to select
the item and press
[ENTER].

To select a folder other than the
one currently being displayed,
first highlight "INPUT" and press
[ENTER] (→ page 46).

- "INPUT", "Copy" and "All copy of PC card" → page 46
- "Album" → page 25, Displaying still pictures (Album Display)
- "Slide Show" → page 25, To display still pictures one by one with constant interval (Slide Show)

Erase

CARD HDD RAM

You can erase whole folders or
selected still pictures.

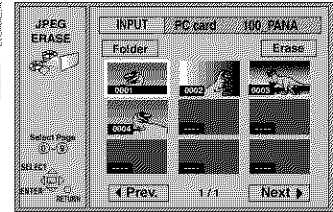

Note

- When you erase folders, files other than still pictures in the folder are also erased.
- Folders lower than the folder to be erased will not be erased.
- To erase files other than still pictures, select the folder containing the file and erase.

Protect

CARD HDD RAM

You can set protection for whole
folders or for individual still pictures.

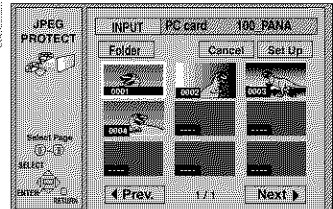

Print (DPOF)

CARD

You can select a whole folder or
individual pictures for printing and
specify the number of prints to be
made (maximum 999 files).

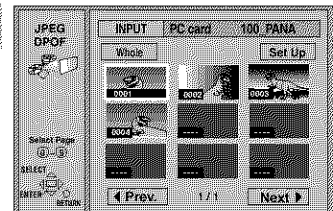

Note

- Settings cannot be made for folders and files not in accordance with DCF standards.
- Print settings (DPOF) made using this unit may not be viewable on other equipment.
- Settings cannot be made if there is no remaining space on the PC Card.
- All settings made on other equipment, except the number of prints, will be canceled.

Slide Show

CARD HDD RAM

To display still pictures one by one
with constant interval (Slide Show)
→ page 25

PC card Format

CARD

You can erase all still
pictures in the PC card.

▲, ▼, ◀, ▶

ENTER

FUNCTIONS

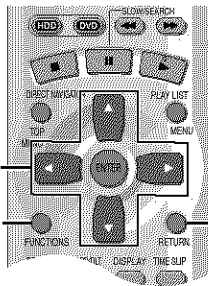

RETURN

To insert/remove the PC card

(→ page 25)

When the CARD indicator in the unit
display is flashing, the card is being read
from or written to. Do not turn off the power
or remove the card. Such action may result
in malfunction or loss of the card's
contents.

To stop set up process

Press [RETURN].

- You can also use [▲, ▼, ◀, ▶] to select "Cancel" or "No" and press [ENTER].

Note

You can only access "Slide Show" in
"Settings" if the PC card is set to Write
Protect (**CARD** → page 9) or if Disc
Protection (**RAM** → page 38) or Cartridge
Protection is activated (**RAM** → page 8).
Deactivate the protection to access other
items.

Once activated, material cannot be returned to its original form, including protected still pictures. Check carefully before proceeding.

Press [▲, ▼, ◀, ▶] to select a still picture and press [ENTER].
 A check mark appears on the still picture.



• Repeat this if you erase more than one still picture.

Press [▲, ▼, ◀, ▶] to select "Erase" and press [ENTER].
 A confirmation screen appears.

Press [◀] to select "Erase" and press [ENTER].
 Selected still pictures are erased, and the still picture select screen reappears.

To select all the still pictures in the folder
 Press [▲, ▼, ◀, ▶] to select "Folder" and press [ENTER].
 (A check mark appears on the folder's name; check marks inputted separately will be erased.)

To erase check marks
 Press [▲, ▼, ◀, ▶] to select the folder or still picture with the check mark and press [ENTER].

Press [▲, ▼, ◀, ▶] to select a still picture and press [ENTER].
 A check mark appears on the still picture.



• Repeat this if you set protection of more than one still picture.

Press [▲, ▼, ◀, ▶] to select "Set Up" or "Cancel" and press [ENTER].

Press [◀] to select "Yes" and press [ENTER].
 The lock symbol appears on the still picture when the still picture is protected.

To select all the still pictures in the folder
 Press [▲, ▼, ◀, ▶] to select "Folder" and press [ENTER].
 (A check mark appears on the folder's name; check marks inputted separately will be erased.)

To erase check marks
 Press [▲, ▼, ◀, ▶] to select the folder or still picture with the check mark and press [ENTER].

Press [▲, ▼, ◀, ▶] to select a still picture and press [ENTER].
 A check mark appears on the still picture.



• Repeat this if you print more than one still picture.

Press [▲, ▼, ◀, ▶] to select "Set Up" and press [ENTER].

Press [◀, ▶] to set number of print (0 to 9).

Press [▲, ▼, ◀, ▶] to select "Set" and press [ENTER].
 The DPOF mark appears if you set one or more pictures to print.



To select all the still pictures in the folder
 Press [▲, ▼, ◀, ▶] to select "Whole" and press [ENTER].
 (A check mark appears on the folder's name; check marks inputted separately will be erased.)

To change print (DPOF) settings

1. Press [▲, ▼, ◀, ▶] to select "Whole" or a still picture with the DPOF mark and press [ENTER].
2. Press [▲, ▼, ◀, ▶] to select "Set Up" and press [ENTER].
3. Press [◀, ▶] to change the print setting
 - The print setting will be canceled if you set the number of print to "0".
4. Press [▲, ▼, ◀, ▶] to select "Set" and press [ENTER].

Once activated, recorded contents (including protected still pictures and computer data) will be completely erased. Check carefully before proceeding.

Press [◀] to select "Yes" and press [ENTER].

Press [◀] to select "Start" and press [ENTER].
 Format begins.

Note
 The cards formatted on this unit may not be usable on other equipment.

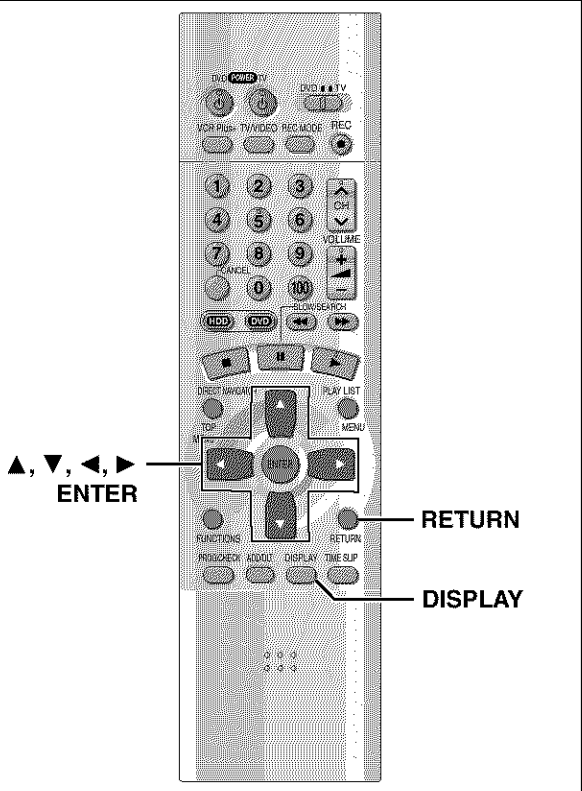

Disc menu

Not available when playing CDs.

e.g., DVD-RAM

Disc	Sound track	1	Digital 2/0 ch
Play	Subtitle	OFF	
Video	Audio channel	L R	

Item	Content
Sound track	Soundtrack language DVD-V See A below.
	Audio attribute HDD RAM DVD-R DVD-V See B below.
	Karaoke vocals, on and off (Karaoke DVD-V only) Solo: ON ↔ OFF Duet: OFF ↔ V1+V2 ↔ V1 ↔ V2
Subtitle	Subtitle language DVD-V See A below.
	Subtitle on/off HDD RAM DVD-R DVD-V
Angle	Angle number DVD-V
Audio channel	HDD RAM VCD (→page 30)
PBC	Playback control on/off VCD Indicates whether menu play (playback control) is on or off.

Common procedures

1 Press [DISPLAY].
e.g. DVD-RAM

Disc	Sound track	1	Digital 2/0 ch
Play	Subtitle	OFF	
Video	Audio channel	L R	

Menu Item Setting

- Press [▲, ▼] to select the menu and press [▶].
- Press [▲, ▼] to select the item and press [▶].
- Press [▲, ▼] to select the setting.

To return to the previous screen
Press [RETURN].

When you are finished
Press [DISPLAY].

For your reference

- The screens depend on the disc contents.
- Depending on the condition of the unit (playing, stopped, etc.) and disc contents, there are some items that you cannot select or change.

A Soundtrack/Subtitle language

ENG: English	SVE: Swedish	CHI: Chinese
FRA: French	NOR: Norwegian	KOR: Korean
DEU: German	DAN: Danish	MAL: Malay
ITA: Italian	POR: Portuguese	VIE: Vietnamese
ESP: Spanish	RUS: Russian	THA: Thai
NLD: Dutch	JPN: Japanese	*: Others

B Audio attributes

LPCM/Digital/DTS/MPEG: Signal type
k (kHz): Sampling frequency
b (bit): Number of bits
ch (channel): Number of channels

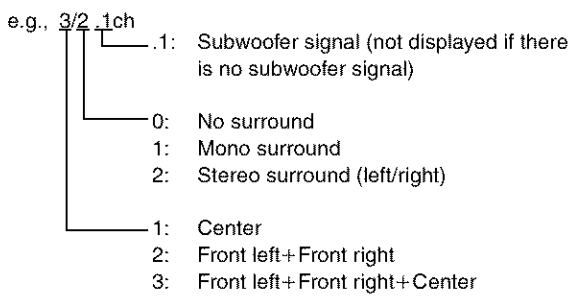

For your reference

- When playing back recordings of SAP broadcasts, "1+1 ch" will be displayed.
- You can only select subtitles, soundtracks, and angles if they are recorded on the disc.
- Some discs allow changes to soundtracks, subtitles, and angles only by using the disc's menus.
- If the subtitles overlap closed captions recorded on discs, turn the subtitles off.

Advanced operation

Play menu

e.g., DVD-RAM

Disc	A-B repeat	***
Play	Repeat play	OFF
Video	Marker	1-10 *****
Audio		

Item	Content	Remarks
A-B repeat	<p>HDD RAM DVD-R DVD-V</p> <p>You can repeat a section between points A and B within a program or title. [ENTER] (start point) → [ENTER] (finish point) To cancel: [ENTER]</p>	<ul style="list-style-type: none"> • A-B repeat does not work if the disc's elapsed play time is not shown on the unit's display. • The unit automatically determines the end of a program/title as point B when the end of the program/title is reached. • Some subtitles recorded around point A or B may fail to appear. • This does not work while playing a play list. • [DUBBING] or [ERASE] does not work while in repeat play mode.
Repeat play	<p>Each time you press [▲, ▼]:</p> <p>HDD RAM DVD-R DVD-V</p> <p>PRG: Program Chapter ALL Title PL: Play list OFF (HDD RAM) CD VCD OFF Track ALL OFF</p> <p>To cancel: Select "OFF".</p>	<ul style="list-style-type: none"> • You cannot use repeat play to repeat an entire DVD-Video. • Repeat play does not work if the disc's elapsed play time is not shown on the unit's display. • [DUBBING] or [ERASE] does not work while in repeat play mode. <p>If the Video CD has playback control</p> <ol style="list-style-type: none"> ① While stopped (the screen saver is on the television), press the numbered buttons to select a track (→page 24). ② Select the repeat mode. 
Marker	<p>HDD RAM DVD-R DVD-V CD VCD</p> <p>(→page 28)</p>	---
Play mode	<p>CD VCD</p> <p>-----: Normal play Program Play (→page 29) Random Play (→page 29)</p>	---

Audio menu

Not available when playing CDs and Video CDs.

e.g., DVD-Video

Disc	V. S. S.	OFF
Play	Dialog Enhancer	OFF
Video		
Audio		

Item	Content	Remarks
V.S.S.	<p>HDD RAM DVD-R DVD-V</p> <p>(Only with Dolby Digital with 2 or more channels) Enjoy a surround-like effect if you are using two front speakers only. The effect is broadened and sound seems to come from virtual speakers on either side if the disc has surround signals recorded on it. Natural ↔ Emphasis ↔ OFF ↑ _____ ↑</p>	<ul style="list-style-type: none"> • Turn off the surround effects on the other equipment. • V.S.S. will not work, or will have less effect, with some discs. • Turn V.S.S. off if it causes distortion. 
Dialog Enhancer	<p>DVD-V</p> <p>(Dolby Digital, 3-channel or over only, including a center channel) The volume of the center channel is raised to make dialog easier to hear. ON ↔ OFF</p>	---

Video menu

Not available when playing CDs.

HDD RAM DVD-R DVD-V VCD



Item	Content
Picture	<p>Normal</p> <p>Soft: Soft picture with fewer video artifacts</p> <p>Fine: Details are sharper</p> <p>Cinema: Mellows movies, enhances detail in dark scenes.</p> <p>User: You can make further adjustments. See below.</p>
MPEG-DNR	<p>(When any item other than "User" is selected)</p> <p>You can turn the recommended settings for 3D NR, block NR, and mosquito NR on and off. </p> <p>ON ← OFF</p>

■ When "User" is selected

Select "Detail picture adjustment".
("User" → [◀] → [▼] → [ENTER])



Page 1/2 of "Detail picture adjustment"

Contrast	Increases the contrast between light and dark parts of the picture (-7 to +7).
Brightness	Brightens the picture (0 to +15).
Sharpness	Adjust the sharpness of the edges of the vertical lines (-6 to +6).
Color	Adjusts the shade of the picture's color (-7 to +7).

Press [ENTER] to enter the setting.

Press [▲] or [▼] until page 2/2 appears.

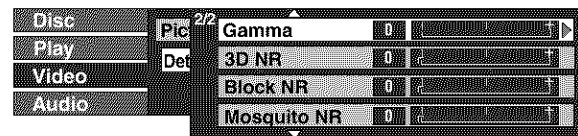

Page 2/2 of "Detail picture adjustment" 

Gamma	Increases the brightness of the center ranges to improve detail and contrast in dark scenes (0 to +5).
3D NR	Reduces overall noise (0 to +4).
Block NR	Smooths block noise (0 to +3).
Mosquito NR	Reduces the smudging that appears around contrasting sections of the picture (0 to +3).

Press [ENTER] to enter the setting.

■ When you have set "TV Type" to "480P" in SETUP (→page 16)



Item	Content
Progressive	<p>ON: Enables progressive output</p> <p>OFF: Disables progressive output</p>
Transfer*	<p>Select the method of conversion for progressive output to suit the type of material being played (→page 66, Film and video).</p> <p>Auto1 (normal): For film material</p> <p>Auto2: For film material (the same as Auto1, but able to convert 30-frame-per-second progressive video.)</p> <p>Video: For video material</p>

* Only applicable in cases where the "Progressive" function is ON.

Using the FUNCTIONS window

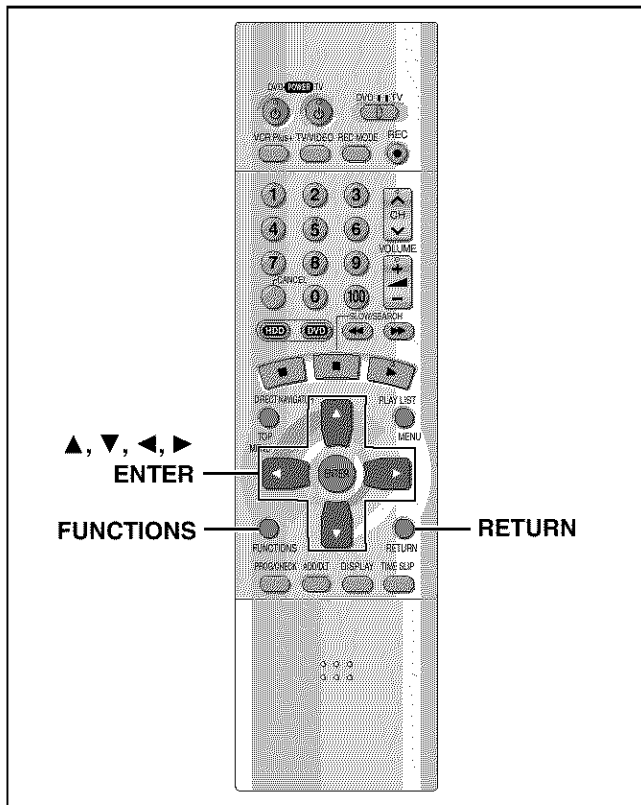

HDD RAM DVD-R DVD-V CD VCD

By using the function window you may access the main functions quickly and easily.

- 1 While stopped
Press **[FUNCTIONS]**.
e.g., DVD-RAM

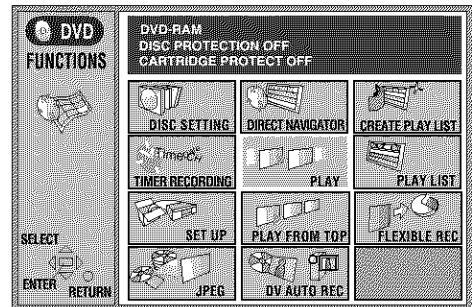

- 2 Press **[▲, ▼, ◀, ▶]** to select an item.
Refer to the relevant pages for details.

Icon	Refer to
DISC SETTING	→page 38, HDD, Disc setting
TIMER RECORDING	→page 34, Timer recording
SET UP	→page 62, Changing the unit's settings
JPEG	→page 25, Playing still pictures (JPEG) →page 46, Editing still pictures (JPEG)
DIRECT NAVIGATOR	→page 26, Using the Direct Navigator →page 40, Editing programs
RESUME PLAY PLAY	→page 22, Playing discs
PLAY FROM TOP	HDD RAM DVD-R Play will begin with the oldest program on the disc (Program 1). DVD-V Play will avoid playing the introductory parts and begin playing the contents immediately. (The performance of this function varies from disc to disc.)
DV AUTO REC	→page 31, DV Automatic Recording
CREATE PLAY LIST	→page 44, Creating play lists
PLAY LIST	→page 27, Playing play lists →page 42, Editing play lists
FLEXIBLE REC	→page 20, Flexible Recording— recording the best quality pictures in a set time
TOP MENU MENU	→page 23, When a menu screen appears on the television
PROGRAM PLAY	→page 29, Program play
RANDOM PLAY	→page 29, Random play
DUBBING	→page 32, Dubbing programs or play list

Functions displayed depend on the type of disc.

- Some items will be grayed out and cannot be selected if:
 - the disc is write protected
 - the disc is not formatted
 - there is nothing recorded on the disc.

- 3 Press **[ENTER]**.

Your selection is entered and the FUNCTIONS window disappears. If the operation requires further selections, another screen appears.

To clear the FUNCTIONS window
Press **[RETURN]**.

On-screen displays

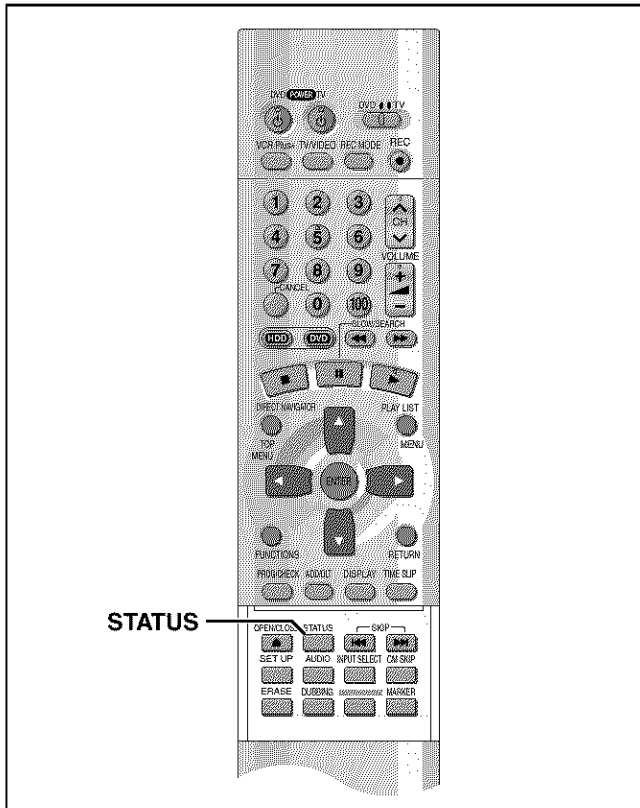

Changing the information displayed

Displays appear on the television when you operate the unit to let you know what operation was performed and what condition the unit is in.

- You can change the setting in the SETUP menu so these displays do not appear automatically (→page 61, Display—Status Messages).

Press [STATUS].

The display changes each time you press the button. e.g., HDD

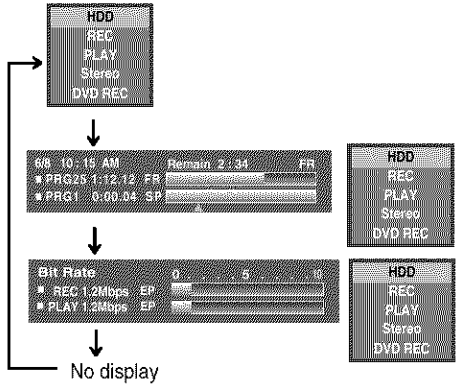

Display examples (HDD)

Advanced operation

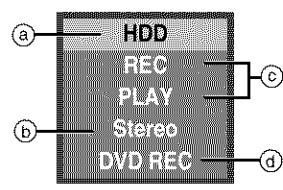

- a **HDD/Disc indication**
- b **Audio type** (→page 30)
Shows the selected audio type.
 - During reception
 - Stereo:** Stereo is selected
 - Mono:** Monaural is selected
 - SAP:** Secondary audio program is selected ("(" appears when the type you have selected is actually being received.)
 - During play
 - LR, R, L:** a stereo program is recorded
 - MAIN, SAP:** an SAP program is recorded

- c **Current recording or play status/input channel and caption (if entered)**
 - REC:** Recording
 - DV AUTO REC:** Recording DV AUTO REC
 - PAUSE:** Recording paused
 - PLAY:** Playing **||**: Playing paused
 - ◀◀:** Rewinding **▶▶:** Fast forwarding
 - ◀:** Reverse slow-motion **▶:** Slow-motion
- d **HDD recording/DVD recording:**
the recording drive is indicated
Tray open/closed: indicates the status of the disc tray when the HDD drive is selected

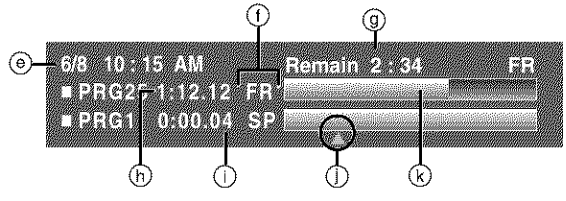

- e **The current date and time**
- f **Recording mode**
- g **Available recording time and recording mode**
- h **Elapsed recording time**
- i **Elapsed play time of a program playing**
- j **Play position**
- k **Approximate volume of recording**

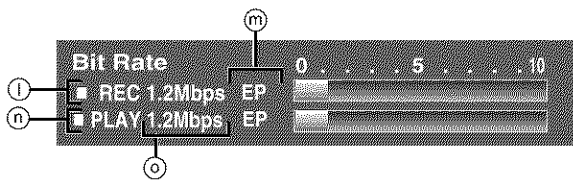

- l **Video bit-rate when recording**
- m **Recording mode**
or I/P/B display when paused (→page 66)
- n **Video bit-rate when playing**
- o **Bit-rate display***
Show as Mbps (Mega-bytes per seconds) during play and recording, or kbit (kilobytes) while paused.

* The method of calculating bit-rate for recording and playing is different so there may be differences in the figures displayed. (Values are approximate.)

Home Theater

Refer to the relevant pages for details.

Enjoying CATV/Satellite broadcasts

What you want to do	How to do it	Reference pages	Settings	Reference pages
Enjoying CATV/Satellite broadcasts	Connect a cable TV box or satellite receiver.	56	Tune to channels correctly.	15
			Change the necessary settings on the equipment you have connected.	—

Enjoying more powerful sound

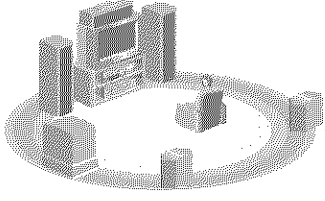
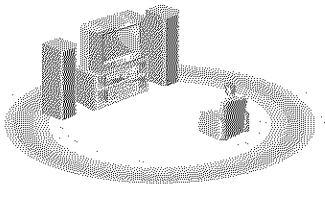
Enjoying 5.1-channel surround sound with Dolby Digital and DTS 	Digital connection Connect to an amplifier with built-in decoders.	57 A	SETUP—Audio—Digital Audio Output • Set PCM Down Conversion to suit the equipment. • Set Dolby Digital and DTS to suit the equipment.	62
			Change speaker settings on the amplifier.	—
Enjoying stereo or Dolby Pro Logic 	Analog connection Connect to an analog amplifier or system component.	57 B	SETUP—Audio—Digital Audio Output • Set PCM Down Conversion to Off.	62
			Digital connection Connect to a digital amplifier or system component.	57 A

Other uses

Record to digital recording equipment or cassette deck (→page 57)

Record from a video cassette recorder (→page 58)

U.S. patent Nos. 4,631,603, 4,577,216, 4,819,098, and 4,907,093.

This product incorporates copyright protection technology that is protected by U.S. patents and other intellectual property rights. Use of this copyright protection technology must be authorized by Macrovision, and is intended for home and other limited consumer uses only unless otherwise authorized by Macrovision. Reverse engineering or disassembly is prohibited.

Manufactured under license from Dolby Laboratories. "Dolby", "Pro Logic" and the double-D symbol are trademarks of Dolby Laboratories.

"DTS", "DTS Digital Surround" and "DTS Digital Out" are registered trademarks of Digital Theater Systems, Inc.

- The equipment connections described are examples.
- Peripheral equipment and optional cables sold separately unless otherwise indicated.
- Before connection, turn off all equipment and read the appropriate operating instructions.
- The signal from the cable TV box or satellite receiver passes through this unit to the television even when this unit is turned off.

Connecting a cable TV box/satellite receiver

You need to subscribe to a cable TV or satellite TV service, to enjoy viewing their programming.

- Consult your service provider regarding appropriate cable box or satellite receiver.
- Select the applicable input on your television to view the output from your cable box or satellite receiver, Channel 3 or 4 if connected via antenna (RF), or the applicable video input on the television is connected using the audio and video connections.



One cable TV box/satellite receiver

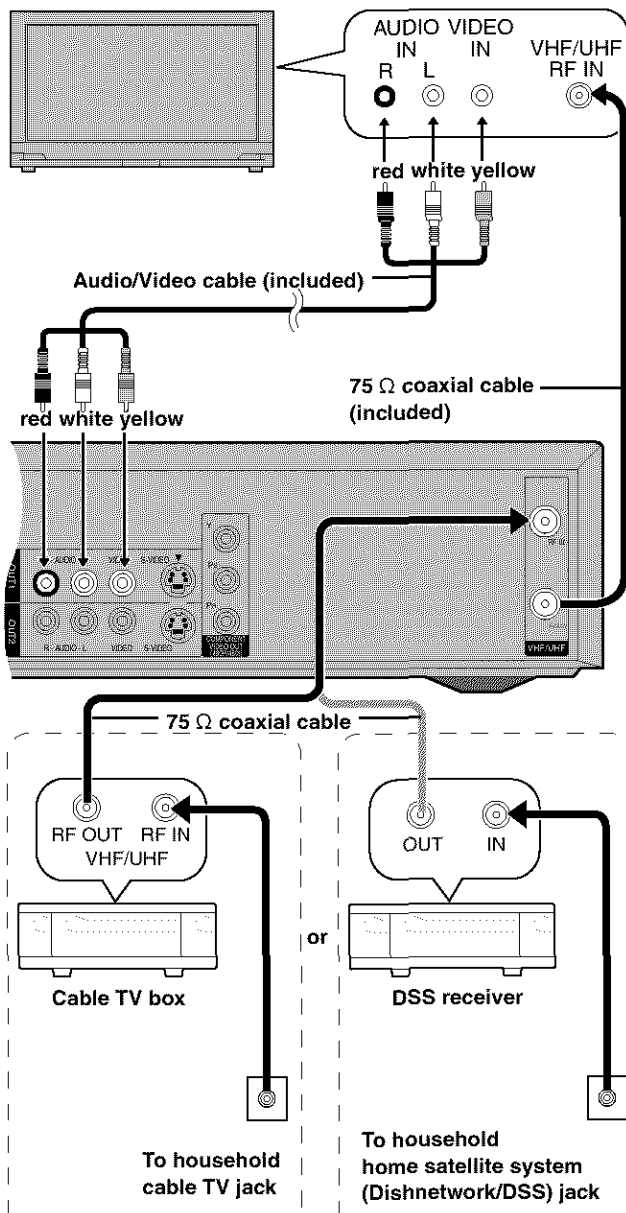

Note

When a home satellite system (Dishnetwork/DSS) is connected, auto tuning and auto clock setting may not operate properly. Set the clock manually (→page 64).

You cannot

- view channels other than the one selected when recording.
- do a timer recording unless the channel is first selected on the cable TV box or DSS receiver.

Two cable TV boxes

You can record and view both scrambled and unscrambled channels if connections are made as shown in the diagram below.

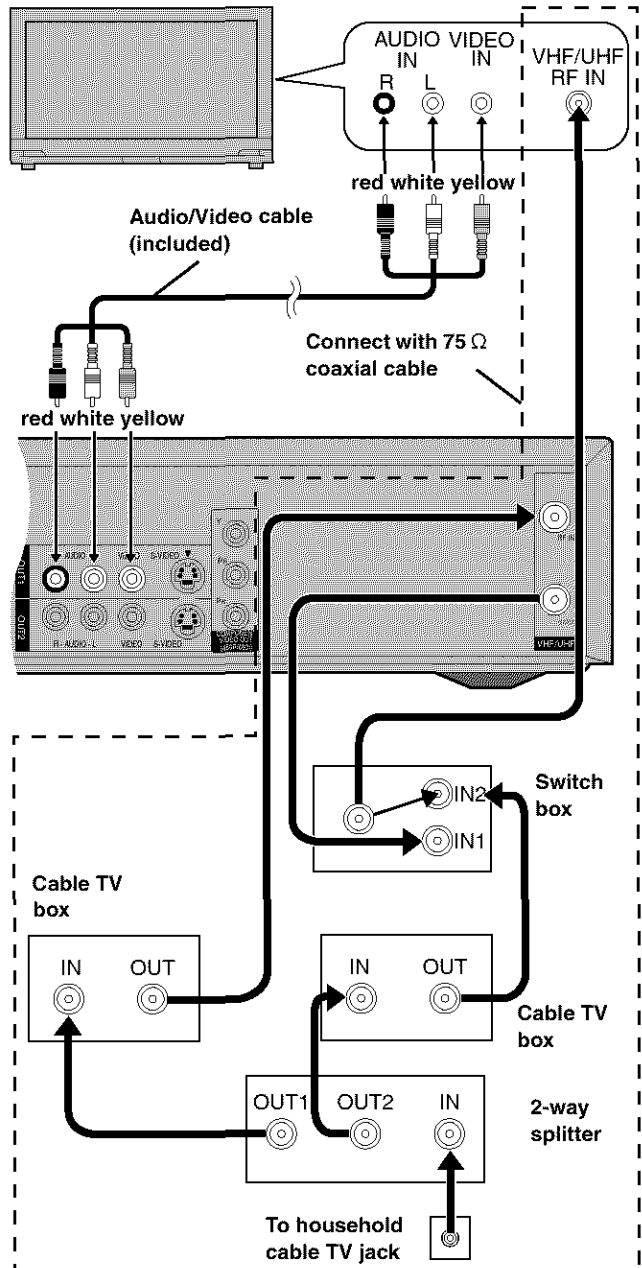

You cannot

- view channels other than the one selected when recording.
- do a timer recording unless the channel is first selected on the cable TV box.

Connecting an amplifier or system component

This model can play Dolby Digital, but only in two channels. This model does not have a DTS decoder. You must connect a unit with a Dolby Digital or DTS decoder to enjoy surround sound.



A Digital connection

To enjoy multi-channel surround sound

Connect an amplifier with a built-in decoder or a decoder-amplifier combination.

- Change the settings in "Digital Audio Output" (→page 62).

Note

You cannot use DTS Digital Surround decoders not suited to DVD.

To enjoy stereo or Dolby Pro Logic

Connect a digital amplifier or system component.

- Change the settings in "Digital Audio Output" (→page 62).

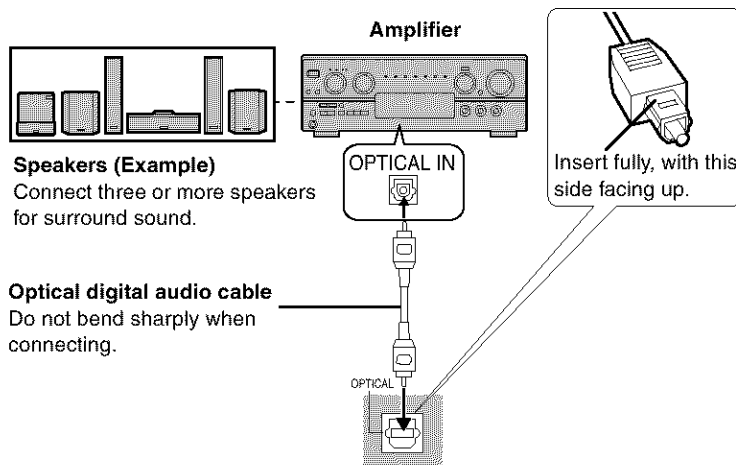

B Analog connection

To enjoy stereo or Dolby Pro Logic

Connect an analog amplifier or system component.

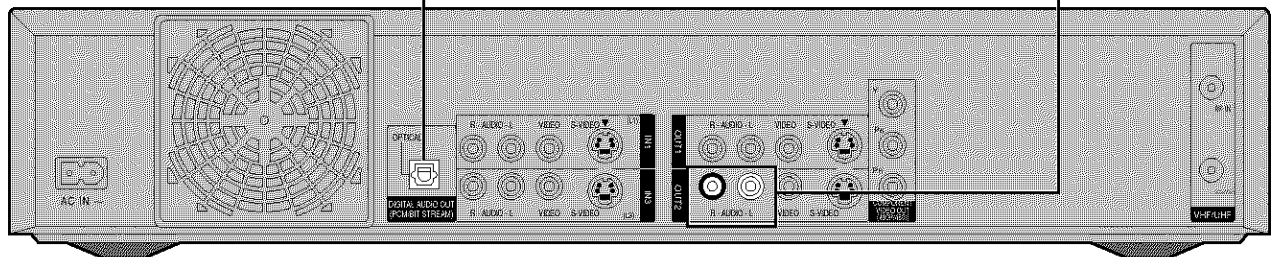
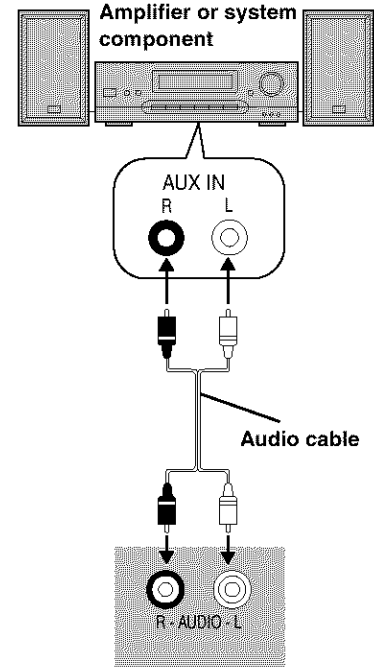

Recording to digital recording equipment or cassette tapes

Digital recording

You can record the digital signal directly to digital recording equipment (→ Connection **A** above).

Note

- With DVD, the following conditions must be met: ① the disc doesn't have protection preventing digital recording, and ② the recording equipment can handle signals with a sampling frequency of 48 kHz.
- You cannot record DTS signals.

When recording DVDs, make the following settings.

V.S.S.: OFF (→page 51)

PCM Down Conversion: On (→page 62)

Dolby Digital: PCM (→page 62)

DTS: Off (→page 62)

Analog recording

You can record to a cassette deck or other recording equipment (→ Connection **B** above).

There are no limitations on recording analog signals as there are with digital signals.

Connecting other video equipment



Connecting to the L2 input terminals on the front of the unit **A**

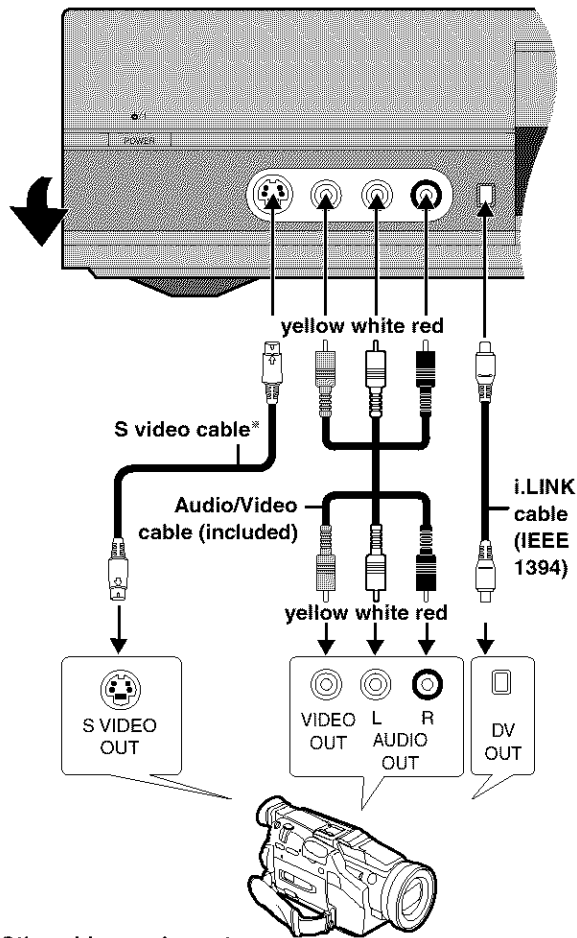

Other video equipment
Connect to the video and audio output terminals.

* By using the S video cable instead of the yellow video cable you may make recordings of higher picture quality.

Note

- If the audio output of the other equipment is monaural, connect to L/MONO. (Both left and right channels are recorded when connected through L/MONO.)
- The DV input on this unit is for use with DV equipment only.
- When DV equipment is connected, it is not possible to operate the unit from the other equipment.
- Only one piece of DV equipment (e.g., Digital Video Camera) can be connected to the unit via the DV Input terminal.
- The picture compression system of the DV equipment you have connected may differ from that used in this unit. In such cases, dubbing from these equipments will not be possible.

Connecting to the input terminals on the rear of the unit, L1 and L3 **B**

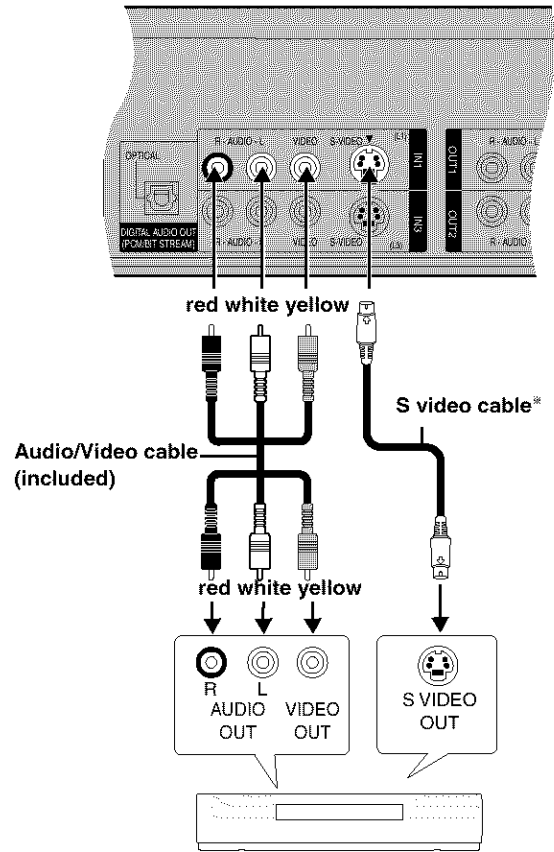

Other video equipment
Connect to the video and audio output terminals.

* By using the S video cable instead of the yellow video cable you may make recordings of higher picture quality.

Note

If audio output on the other equipment is monaural, use a stereo-monaural conversion cable (not included).

Advanced operation

Other antenna connections

Other antenna connection to the unit

Use one of the following connections to suit the antenna lead.

■ A single twin lead

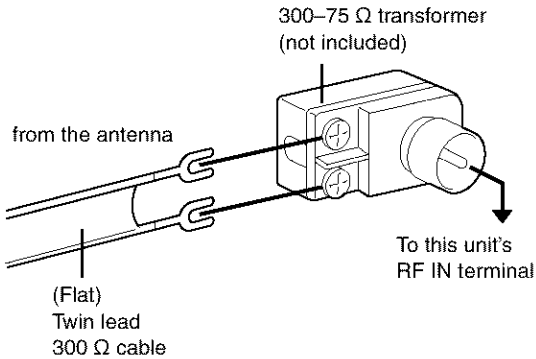

■ A twin lead and a coaxial cable

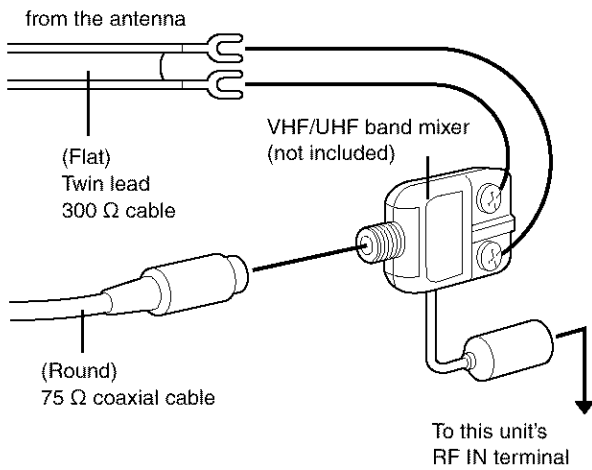

■ Two twin leads

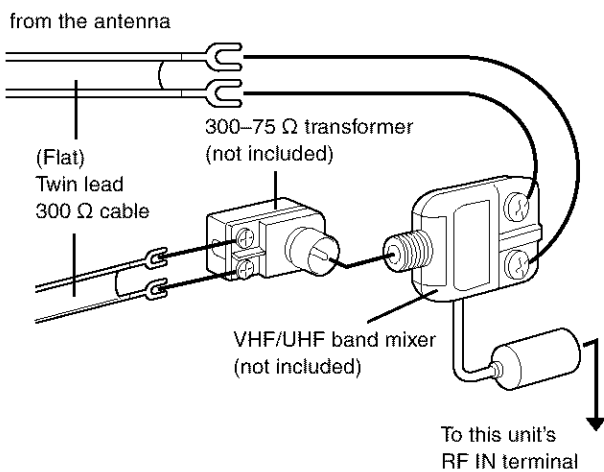

• If your television has both lead and coaxial VHF terminals, use the lead connection to minimize signal loss.

Other antenna connection from the unit to the television

Use one of the following connections to suit the antenna terminals on your television. Refer to the television's operating instructions.

■ A twin lead and coaxial plug terminal

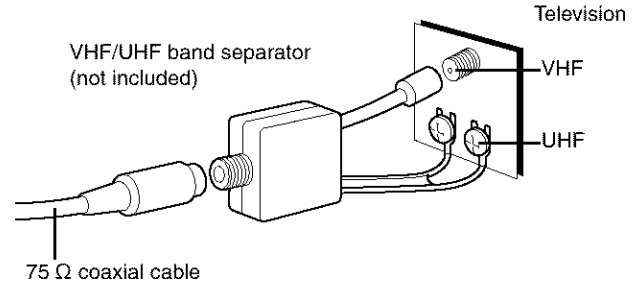

■ A twin lead terminal

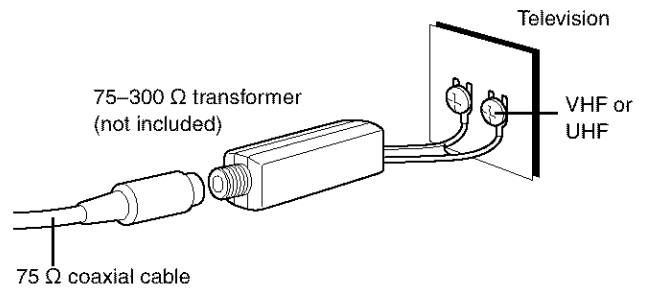

■ Two twin lead terminals

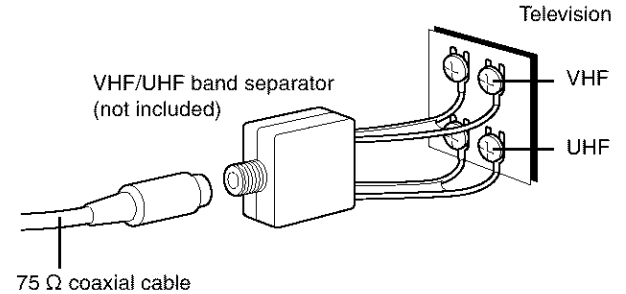

■ Multiple antenna terminals

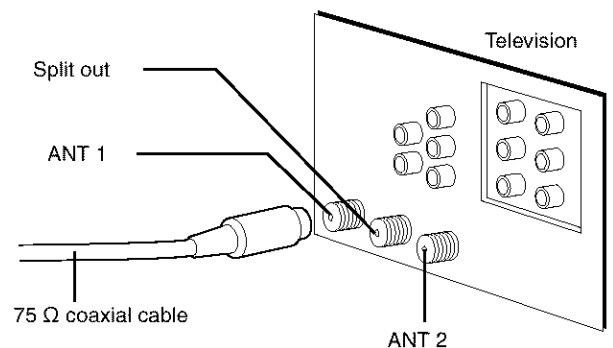

• Connect to one of the terminals, then change the television's setting as necessary.

Changing the unit's settings

Summary of settings

This chart shows the initial settings for this unit. See page 62 for details on menu operation.

• Underlined items are the factory presets.

Tabs	Menus	Options
Channel	Antenna System (→page 13) Select to suit the type of antenna you are using. Channels are set corresponding to the antenna system you select.	•TV • <u>CATV</u>
	Auto Channel Setting (→page 15) The unit sets the channels automatically.	
	Preset Channel Caption (→page 15) You can give preset captions to the channels.	
	Manual Channel Caption (→page 15) You can set channel captions manually.	
	VCR Plus+ CH Setting (→page 14) Set the guide channels for use with VCR Plus+ timer recording.	
Set Up	Off Timer Select how long the unit remains on when it is not being used.	•2 hr • <u>6 hr</u> •Off
	Remote Control Code (→page 65) To avoid operating equipment other than the one intended (when more than one remote controlled item is in the same area), change the remote control code.	• <u>Set Code 1</u> •Set Code 2 •Set Code 3
	Auto Clock Setting (→page 64) The unit adjusts the clock automatically.	
	Manual Clock Setting (→page 64) You can adjust the clock.	
	Time Zone Adjust (→page 64) Adjust the time zone if it was not set correctly after auto clock setting. This appears only after auto clock setting is complete.	•-1 • <u>0</u> •+1
	Re-initialize Setting This returns all values in the SETUP menus, except for the clock, channel settings, ratings level, and display language, to the default settings.	•Yes • <u>No</u>
	Audio Choose the audio language.	Some discs start in a certain language despite any changes you make here.
Subtitle Choose the subtitle language.	• <u>Automatic</u> : If the language selected for "Audio" is not available, subtitles of that language will automatically appear if available on that disc. •English •French •Spanish •Other ****	
Menus Choose the language for disc menus.	• <u>English</u> •French •Spanish •Other ****	
Ratings (→page 62) Set a ratings level to limit DVD-Video play. The password screen is shown when you select levels 0 to 7.		Setting ratings (When level 8 is selected) 8 No Limit: All DVD-Video can be played. 1 to 7: Prohibits play of DVD-Video with corresponding ratings recorded on them. 0 Lock All: Prohibits play of all DVD-Video. Changing ratings (When level 0-7 is selected) •Unlock Recorder •Change Password •Change Level •Temporary Unlock
Video	3-D Y/C Separation Turn 3-D Y/C separation on or off.	• <u>On</u> : Reduces noise for recording by separating the luminance (Y) and color (C) signals received from the television station. •Off: Reduces the ghosting that occurs when recording fast moving images.
	Hybrid VBR Resolution Switch between automatic and fixed hybrid VBR resolution when recording.	• <u>Automatic</u> : The unit automatically switches resolution rates during recording. The unit reduces block noise, which occurs during MPEG compression, by selecting the optimum rate. •Fixed: The resolution rate is fixed to ensure the resolution rate is not reduced.
	Still Mode Select the type of picture shown when you pause play.	• <u>Automatic</u> •Field: Less blurred field stills are shown. Select if jittering occurs when "Automatic" is selected. •Frame: Sharper frame stills are shown. Select if small text or fine patterns cannot be seen clearly when "Automatic" is selected.

Tabs	Menus	Options
Video	Seamless Play Turn seamless play on or off on discs with play lists. • Seamless Play does not effect programs that have been recorded with LPCM sound.	• <u>On</u> : The scenes in play lists are played seamlessly. This may cause shifting of the points where scenes change. Some play lists cannot be played seamlessly. • <u>Off</u> : The points where scenes in play lists change are played accurately, but the picture may freeze for a moment.
	Dubbing Aspect You may set the aspect ratio for a picture to be viewed on a 4:3 television. Setting information is shown on the recording drive (Setting cannot be made in High Speed mode).	• <u>Squeeze</u> : Full screen display The picture will appear stretched in the vertical plane. • <u>Letterbox</u> : A black bands will appear across the top and bottom of the screen display.
Audio	Audio during Search HDD RAM DVD-R DVD-V VCD Choose whether to have sound during the first level of fast-forward.	• <u>On</u> • <u>Off</u>
	D. Range Compression DVD-V (Dolby Digital only) Change the dynamic range for late night viewing.	• <u>On</u> • <u>Off</u>
	Select MTS for DVD-R or LPCM (→page 30) Select whether to record the main or secondary audio type (SAP) when recording to DVD-R or when recording using LPCM sound ("Audio Mode for XP Recording" → below).	• <u>Main</u> • <u>SAP</u>
	Select Dubbing Audio to DVD-RAM You can select the kind of sound when dubbing to DVD-RAM.	• <u>Main + SAP</u> • <u>Main</u> • <u>SAP</u> (Available in all modes apart from High Speed mode when dubbing programs.)
	Select Audio CH for DV input (→page 63) You can select the kind of sound when recording from the unit's DV terminal.	• <u>Stereo 1</u> • <u>Stereo 2</u> • <u>Mix</u>
	Audio Mode for XP Recording Choose the audio type when recording with XP mode. • Sound recordings made using LPCM require more information than usual. Consequently the picture quality of LPCM recordings may be less than that of normal XP mode recordings.	• <u>Dolby Digital</u> (→page 66) • <u>LPCM</u> (→page 66)
	Digital Audio Output (→page 62)	
	PCM Down Conversion	• <u>On</u> • <u>Off</u>
	Dolby Digital	• <u>Bitstream</u> • <u>PCM</u>
	DTS	• <u>Bitstream</u> • <u>Off</u>
Display	Status Messages Choose whether to show on-screen messages automatically.	• <u>Automatic</u> • <u>Off</u>
	Language of Display Message Choose the language for these menus and the on-screen messages.	• <u>English</u> • <u>Français</u>
	Blue Background Select "Off" if you do not want to have the unit show the blue background when reception is weak.	• <u>On</u> • <u>Off</u>
	FL Display Changes the brightness of the unit's display.	• <u>Bright</u> • <u>Dim</u> • <u>Dim during Play</u> : The display dims during play and when the unit is turned off. • <u>Automatic</u> : The display dims during play and goes off completely when the unit is turned off (the power consumed will be 0.6 W). If you press a button the display will brighten briefly.
TV Screen	TV Aspect (→page 16) Choose the setting to suit your television.	• <u>4:3</u> • <u>16:9</u>
	TV Type (→page 16) Choose "480P" to enable progressive output.	• <u>480i</u> • <u>480P</u>
	4:3 TV Settings for DVD-Video Select how DVD-Video widescreen picture is shown on a 4:3 standard aspect television.	• <u>Pan & Scan</u> (→page 66): Video recorded for a widescreen is played as Pan & Scan (unless prohibited by the producer of the disc). • <u>Letterbox</u> (→page 66): Video recorded for a widescreen is played in the letterbox style.
	4:3 TV Settings for DVD-RAM Select how DVD-RAM widescreen picture is shown on a 4:3 standard aspect television.	• <u>4:3</u> : Programs played as recorded. • <u>Pan & Scan</u> : Video recorded for a widescreen is played as Pan & Scan. • <u>Letterbox</u> : Video recorded for a widescreen is played in the letterbox style.

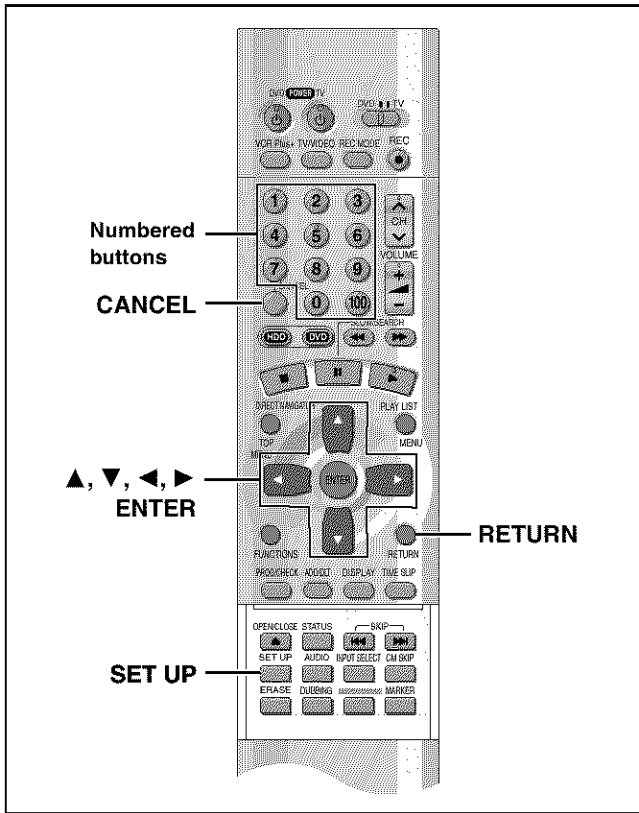

Entering a password (Ratings)



DVD-V

The password screen is shown when you select levels 0 to 7.

1. Input a 4-digit password with the numbered buttons.
 - If you enter a wrong number, press [CANCEL] to erase it.
2. Press [ENTER].
 - The lock symbol appears closed to show the rating is locked.
 - Do not forget your password.
3. Press [ENTER] to confirm the 4 digits.

If you insert a DVD-Video that exceeds the ratings limit you set, a message appears on the television. Follow the on-screen instructions.

Digital Audio Output

DVD-V

Change the settings when you have connected equipment through this unit's DIGITAL AUDIO OUT terminal (→page 57,).

Select the "Audio" tab and then "Digital Audio Output" by following "Common procedures" (→ left) to set up "PCM Down Conversion", "Dolby Digital" and "DTS".

PCM Down Conversion

Select how to output audio with a sampling frequency of 96 kHz. Select "On" if the equipment you connect cannot process signals with a sampling frequency of 96 kHz.

- Select "Off" if you use analog connect irrespective of the type of equipment.

Off (Factory preset):

Output as 96 kHz. There is no output if the disc has copy protection. Select "On" in this case.

On:

Converted to 48 kHz for output.

Dolby Digital and DTS



Bitstream (Factory preset for Dolby Digital):

Select if the equipment you connected can decode the signal.

PCM:

Select if the equipment you connected cannot decode Dolby Digital signal.

Off (Factory preset for DTS):

Select if the equipment you connected cannot decode DTS signal.

IMPORTANT

If the equipment you connected cannot decode the signal, the setting must be changed to PCM or Off. If not, signals the equipment cannot process will be output by this unit, causing high levels of noise which can damage your hearing and the speakers.

Common procedures

See page 60 for menu and option details.

- 1 While stopped
Press [SET UP] to show the menus.

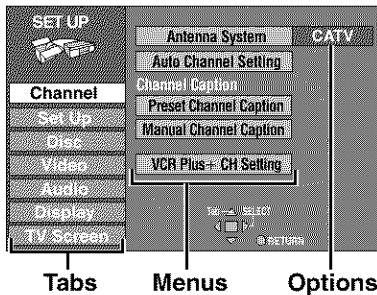

- 2 Press [,] to select the menu's tab and press [].
- 3 Press [,] to select the menu and press [ENTER].
- 4 Press [,] to select the option and press [ENTER].

The screen now shows the menu again.

- Some items require different operations. Read the following explanations.

To return to the previous screen

Press [RETURN].

When you are finished

Press [SET UP].

Audio channel for DV input

- Stereo 1 :Records sound (L1, R1) when DV recording is taking place.
- Stereo 2 :Records added sound such as narration (L2, R2) subsequent to original recording.
- MIX :Records both Stereo 1 and Stereo 2.
- L1+L2 are recorded in L and R1+R2 are recorded in R, except for SAP. In the case of SAP, Stereo 1 is recorded when recording to DVD-R or if recording in LPCM. Details of recording are given in "Select MTS for DVD-R or LPCM" on page 61.

Language code list Input the code with numbered buttons.

Abkhazian: 6566	Chinese: 9072	Hausa: 7265	Lithuanian: 7684	Romanian: 8279	Telugu: 8469
Afar: 6565	Corsican: 6779	Hebrew: 7387	Macedonian: 7775	Russian: 8285	Thai: 8472
Afrikaans: 6570	Croatian: 7282	Hindi: 7273	Malagasy: 7771	Samoan: 8377	Tibetan: 6679
Albanian: 8381	Czech: 6783	Hungarian: 7285	Malay: 7783	Sanskrit: 8365	Tigrinya: 8473
Ameharic: 6577	Danish: 6865	Icelandic: 7383	Malayalam: 7776	Scots Gaelic: 7168	Tonga: 8479
Arabic: 6582	Dutch: 7876	Indonesian: 7378	Maltese: 7784	Serbian: 8382	Turkish: 8482
Armenian: 7289	English: 6978	Interlingua: 7365	Maori: 7773	Serbo-Croatian:8372	Turkmen: 8475
Assamese: 6583	Esperanto: 6979	Irish: 7165	Marathi: 7782	Shona: 8378	Twi: 8487
Aymara: 6588	Estonian: 6984	Italian: 7384	Moldavian: 7779	Sindhi: 8368	Ukrainian: 8575
Azerbaijani: 6590	Faroese: 7079	Japanese: 7465	Mongolian: 7778	Singhalese: 8373	Urdu: 8582
Bashkir: 6665	Fiji: 7074	Javanese: 7487	Nauru: 7865	Slovak: 8375	Uzbek: 8590
Basque: 6985	Finnish: 7073	Kannada: 7578	Nepali: 7869	Slovenian: 8376	Vietnamese: 8673
Bengali, Bangla:6678	French: 7082	Kashmiri: 7583	Norwegian: 7879	Somali: 8379	Volapük: 8679
Bhutani: 6890	Frisian: 7089	Kazakh: 7575	Oriya: 7982	Spanish: 6983	Welsh: 6789
Bihari: 6672	Galician: 7176	Kirghiz: 7589	Pashto, Pushto:8083	Sundanese: 8385	Wolof: 8779
Breton: 6682	Georgian: 7565	Korean: 7579	Persian: 7065	Swahili: 8387	Xhosa: 8872
Bulgarian: 6671	German: 6869	Kurdish: 7585	Polish: 8076	Swedish: 8386	Yiddish: 7473
Burmese: 7789	Greek: 6976	Laotian: 7679	Portuguese: 8084	Tagalog: 8476	Yoruba: 8979
Byelorussian: 6669	Greenlandic: 7576	Latin: 7665	Punjabi: 8065	Tajik: 8471	Zulu: 9085
Cambodian: 7577	Guarani: 7178	Latvian, Lettish:7686	Quechua: 8185	Tamil: 8465	
Catalan: 6765	Gujarati: 7185	Lingala: 7678	Rhaeto-Romance:8277	Tatar: 8484	

Changing the unit's settings

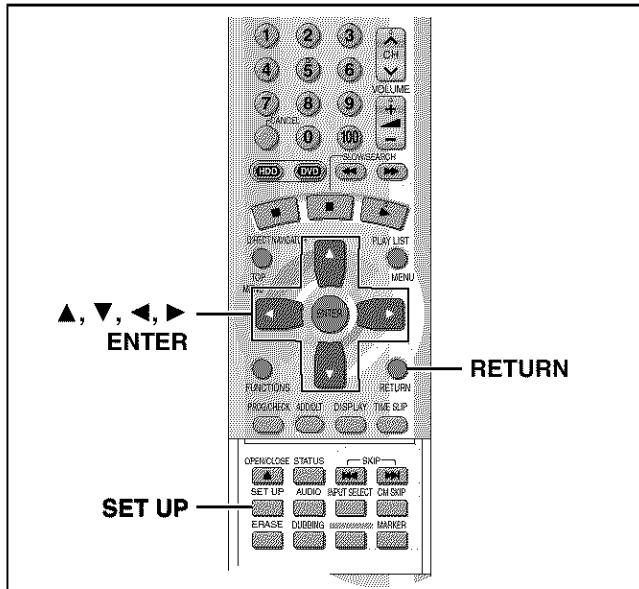

Clock settings

- 1 Press [SET UP] to show the menus.
- 2 Press [▲, ▼] to select "Set Up" and press [▶].

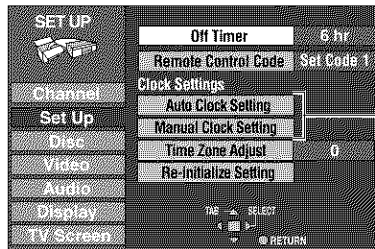

Proceed with the steps described below.

Auto Clock Setting

- 3 Press [▲, ▼] to select "Auto Clock Setting" and press [ENTER].

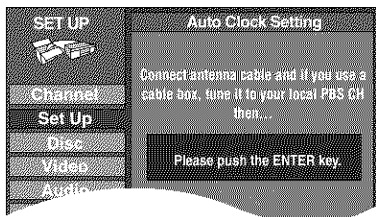

If you have not yet set channels, the "Auto Channel/Clock Setting" screen appears.

- 4 Press [ENTER].

Auto setting starts. This can take some time, up to a few hours in some cases. (To stop auto clock setting, press [RETURN].) The following screen appears when setting is complete. Press [ENTER].

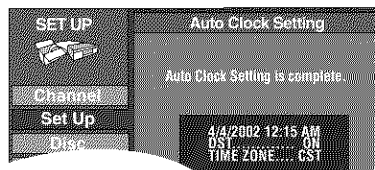

- If the time was not set correctly, use manual clock setting or time zone adjust.
- If you connect the unit through a cable TV box or DSS receiver (→page 56), tune to your local PBS station before starting auto clock setting. Use manual clock setting if this does not work or if there is no local PBS channel in your area.

- DST, Daylight Saving Time, shows the summertime setting.
- TIME ZONE shows the time difference from Greenwich meantime (GMT).
EST=GMT -5, CST=GMT -6, MST=GMT -7, PST=GMT -8, AST=GMT -9, HST=GMT -10, For other areas: xx hr

Manual Clock Setting

- 3 Press [▲, ▼] to select "Manual Clock Setting" and press [ENTER].

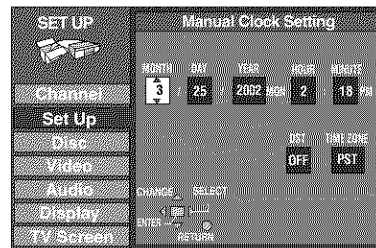

- 4 Press [◀, ▶] to select the item you want to change and press [▲, ▼] to change the setting.

MONTH ↔ DAY ↔ YEAR ↔ HOUR (12-hour display)
↑ TIME ZONE ↔ DST ↔ MINUTE ↔

DST (Daylight Saving Time): ON or OFF

If you select "ON", the clock is advanced one hour starting at 2 a.m. on the first Sunday in April and ending at 2 a.m. on the last Sunday in October.

TIME ZONE:

EST ↔ CST ↔ MST ↔ PST ↔ AST ↔ HST
(-5) (-6) (-7) (-8) (-9) (-10)

- 5 Press [ENTER].

The "Set Up" screen (→step 2) reappears and the clock starts.

Note

When you change the time zone, the recording times for programs recorded before the time zone was changed also change to correspond to the new time zone.

Time Zone Adjust

Adjust the time zone (-1 or +1) if it was not set correctly with auto clock setting. You cannot change this setting if you set the clock manually.

- 3 Press [▲, ▼] to select "Time Zone Adjust" and press [ENTER].

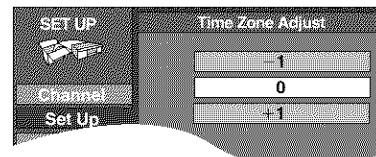

- 4 Press [▲, ▼] to select "-1", "0", or "+1" and press [ENTER].

The "Set Up" screen (→step 2) reappears.

Changing the remote control code

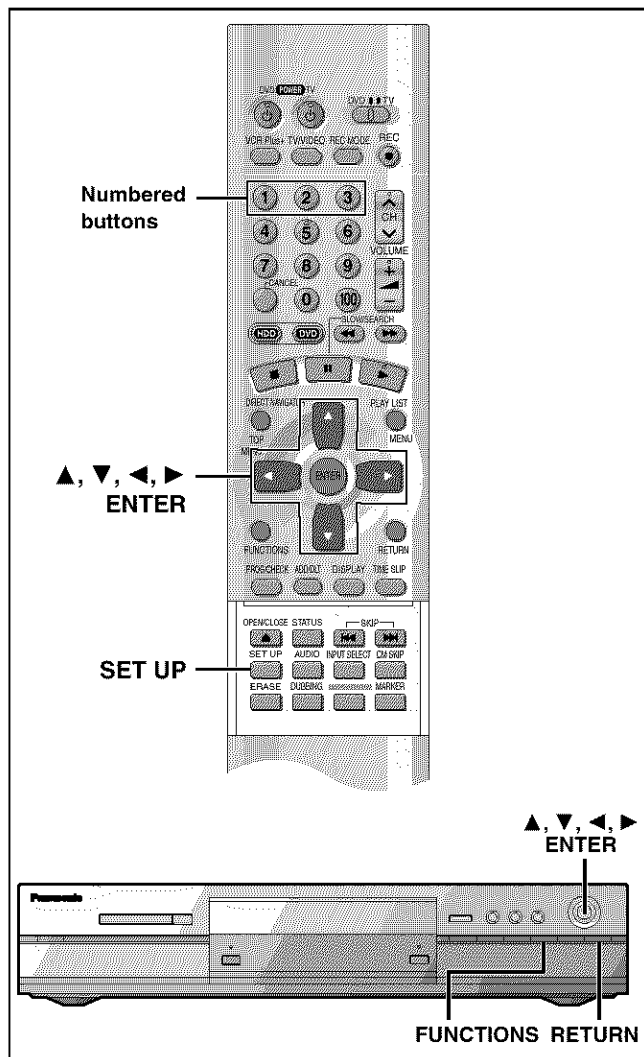

Most of the DVD recorders and players manufactured by Panasonic use the same remote control system. If you have more than one piece of equipment placed in proximity to each other, they may all respond to the signal. If this occurs, you will have to alter the code on the unit as well as on the remote control (the two must match) using the following procedure.

- Use "1", the factory set code, under normal circumstances.

1 Press [SET UP] to show the menus.

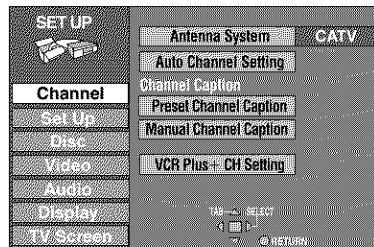

2 Press [▲, ▼] to select "Set Up" and press [▶].

3 Press [▲, ▼] to select "Remote Control Code" and press [ENTER].

4 Press [▲, ▼] to select the code (1, 2, or 3) and press [ENTER].

The remote control code on the unit has been set.

5 While pressing [ENTER] on the remote control, press the numbered button ([1], [2] or [3]) corresponding to the code you selected in step 4.

The remote control code on the remote control has been set.

6 Press [SET UP]

If the unit doesn't respond, you have entered the wrong code. Repeat step 5 to enter the correct code.

Note

The following display appears on the unit's display if its code and the remote control's code are different. Change the remote control's code to suit the unit. The display disappears after about 5 seconds.



The unit's remote control code

- You can also set the unit's code without using the remote control.
 - ① Press [FUNCTIONS] on the unit.
 - ② Press [▲, ▼, ◀, ▶] to select "SET UP" and press [ENTER].
 - ③ Carry out procedure 2-4 above.
 - ④ Press [RETURN].

Bitstream

This is the digital form of multi-channel audio data (e.g., 5.1 channel) before it is decoded into its various channels.

CPRM (Content Protection for Recordable Media)

CPRM is the copyright protection technology that is used to protect broadcasts that are allowed to be recorded only once (e.g. some CATV broadcasts).

Decoder

A decoder restores the coded audio signals on DVDs to normal. This is called decoding.

Dolby Digital

This is a method of coding digital signals developed by Dolby Laboratories. Apart from stereo (2-channel) audio, these signals can also be multi-channel audio. A large amount of audio information can be recorded on one disc using this method.

This unit is set to record using Dolby Digital in all recording modes except for XP mode, where you may choose Dolby Digital or LPCM.

Dolby Pro Logic

A surround system where a 4-channel audio track is recorded as 2 channels and then is restored to 4 channels for play. The surround channel is monaural and can reproduce up to 7 kHz.

DPOF (Digital Print Order Format)

DPOF is the standard printing format for still picture data. It is used at a photo studio to print out the still picture data taken with a digital camera etc. or when you print out using a domestic printer.

Drive

In the instance of this unit, this refers to the hard disk (HDD) and DVD. These perform the reading and writing of data. Select them by pressing the drive select buttons ([HDD] or [DVD]).

DTS (Digital Theater Systems)

This surround system is used in many movie theaters around the world. There is good separation between the channels, so realistic sound effects are possible.

Dynamic range

Dynamic range is the difference between the lowest level of sound that can be heard above the noise of the equipment and the highest level of sound before distortion occurs.

Film and video

DVD-Videos are recorded using either film or video. Usually, film is recorded at 24 frames per second, the rate movies are filmed at, while video is recorded at 30 frames per second.

FAT (File Allocation Table)

The FAT12 (12-bit file allocation table) and FAT16 (16-bit file allocation table) systems this unit is compatible with are file systems used widely in computers around the world.

Frame still and field still

Frames are the still pictures that go together to make a moving picture. There are about 30 frames shown each second.

One frame is made up of two fields. A regular television shows these fields one after the other to create frames.

A still is shown when you pause a moving picture. A frame still is made up of two alternating fields, so the picture may appear blurred, but overall quality is high.

A field still is not blurred, but it has only half the information of a frame still so picture quality is lower.

Hard disk drive (HDD)

This is a mass data storage device used in computers etc. A disk with a surface that has been treated with magnetic fluid is spun and a magnetic head is brought in close proximity to facilitate the reading and writing of large amounts of data at high speed.

Interlace and progressive output

NTSC, the video signal standard, has 480 interlaced (i) scan lines, whereas progressive scanning uses twice the number of scan lines. This is called 480p. The video signals output from this unit's COMPONENT VIDEO OUT terminals (Y, P_B, P_R) allow you to enjoy higher quality pictures than if the signals were output from the VIDEO OUT terminal or S-VIDEO OUT terminal.

I/P/B

MPEG 2, the video compression standard adopted for use with DVD-Video, codes frames using these 3 picture types.

I: Intra coded picture

This picture has the best quality and is the best to use when adjusting the picture.

P: Predictive coded picture

This picture is calculated based on past I- or P-pictures.

B: Bidirectionally-predictive coded picture

This picture is calculated by comparing past and future I- and P-pictures so it has the lowest volume of information.

JPEG (Joint Photographic Experts Group)

This is a system used for compressing/decoding color still pictures. If you select JPEG as the storage system on digital cameras etc., the data will be compressed to 1/10–1/100 of its original size. The special quality of this standard is that there is little deterioration in picture quality in comparison to the degree of compression.

Linear PCM (pulse code modulation)

These are uncompressed digital signals. This unit outputs linear PCM sound in 2 channels from the DIGITAL AUDIO OUT terminal. LPCM sound is available when recording in XP mode.

Playback control (PBC)

If a Video CD has playback control, you can select scenes and information with menus.

Pan&Scan/Letterbox

In general, DVD-Video are produced with the intention that they be viewed on a widescreen television with an aspect ratio of 16:9. This means you can view most material with the intended aspect ratio on a widescreen television.

Material with this ratio will not fit onto a standard television with an aspect ratio of 4:3. Two styles of picture, "Pan&Scan" and "Letterbox", deal with this problem.



Pan&Scan: The sides are cut off so the picture fills the screen.







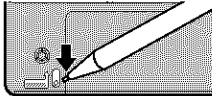

Letterbox: Black bands appear at the top and bottom of the picture so the picture itself appears in an aspect ratio of 16:9.

Error messages

On the television

		Page
No disc.	• You haven't inserted a disc. Correctly insert a disc that this unit can use.	8
	• The disc is upside down. If it is a single-sided disc, insert it so the label is facing up.	18
This is non-recordable disc.	<ul style="list-style-type: none"> • The unit cannot record on the disc you inserted. The unit cannot record onto finalized DVD-R, DVD-Video, CDs, or video CDs. Insert a DVD-RAM or unfinalized DVD-R. • You inserted an unformatted DVD-RAM. Format the disc with this unit. 	8
This disc is not formatted properly. Please format the disc in 'DISC SETTING' to record.		38
This disc cannot be read.	• You inserted an incompatible disc. Insert a compatible disc.	8
Please check write protect tab on the disc.	<ul style="list-style-type: none"> • The write-protect tab on the cartridge is set to PROTECT. Use a ballpoint pen or similar to release the write protection. 	—
Contents of this disc are protected.	• The program is write-protected. Cancel the protection with the Direct Navigator.	40
	• The disc is write-protected. Cancel Disc Protection with DISC SETTING.	38
Cannot finish recording completely.	• The program was copy-guarded.	—
	• No space left on HDD, DVD-RAM or DVD-R.	—
	• The connection from the external device (DV equipment etc.) was lost during recording.	—
	• Recording was not completed for some other reason.	—
Cannot record.	• The disc is scratched. Use another disc.	—
	• The disc is dirty.	10
	• You inserted an incompatible disc. Insert a compatible disc.	8
HDD is full. Disc is full.	• No space left on HDD, DVD-RAM or DVD-R.	38, 40
	→ Create space by erasing any unwanted programs. HDD RAM	—
	→ Use a new disc. RAM DVD-R	—
	→ Erase any unwanted files (still pictures).	48
• You may record up to 300 folders and 3000 files (still pictures) using this unit.	—	
Cannot dub from this disc.	• Dubbing prohibited disc in tray. → Dubbing to the HDD is not possible.	—
Please set clock.	• The clock is not set. Set the clock.	64
This disc may not be played in your region.	• You tried to play a disc with a region number different from this unit's region number. This unit can only play discs with the region numbers compatible with this unit (1, All, or including the number 1).	Cover page
Your selection exceeds the recorder's rating limit.	• A ratings level has been set for DVD-Video with this unit. Unlock the unit with "Ratings" in "Disc" in the SETUP menu.	62
Cannot play back on this unit.	• You tried to playback incompatible pictures (TIFF images and MOTION JPEG cannot be played back).	9
No PC CARD No valid PC card	• The PC card is not inserted. If this message is displayed with a compatible PC card already inserted, turn off the power, remove and then re-insert the card.	25
	• The PC card format does not match.	9
	• The PC card inserted is not compatible.	9
No DVD-RAM disc	• DVD-RAM is not loaded.	—
	• DVD-RAM is not formatted. (Even if this message is displayed, it may sometimes be possible to playback moving picture parts.)	38
Please check write protect tab.	<ul style="list-style-type: none"> • Release the protection on the PC card. • Release the protection on the DVD-RAM. 	9 8, 38
No folder	• There is no compatible folder in this unit.	9
Cannot write.	• The PC card is currently protected → Release the write protection.	9
	• There is no space remaining. → Erase any unwanted files (still pictures).	48
Finalizing is necessary for compatible playback.	• To enable playback of your DVD-R on compatible equipment, it is necessary to finalize it.	38

On the unit's display

U11 NO DISC		• The disc is dirty or badly scratched.	10
		<ul style="list-style-type: none"> – Clean the disc if it is dirty. – The disc cannot be played if it is scratched and this display doesn't disappear. 	
U14		• You have inserted a disc the unit cannot play or record on.	8
		– Insert a disc the unit can play or record on.	
		• Cleaning has been carried out using DVD-RAM/PD lens cleaner.	
		→ Cleaning is finished. Press [▲ OPEN/CLOSE] and remove the disc cleaner from the disc tray.	—
U99		• The unit is hot.	—
		– The unit switches to standby automatically for safety reasons and you cannot operate it. Wait for about 30 minutes for the service number to disappear.	—
		– Select a position with good ventilation when installing the unit.	—
U99		– Do not block the cooling fan on the rear of the unit.	—
		• The unit fails to operate properly.	—
CHK REMOTE		– Press [⏻, DVD POWER] to switch the unit to standby. Now press [⏻, DVD POWER] again to turn the unit on.	—
		• The remote control and main unit are using different codes.	65
RECOVER		– Change the code on the remote control or main unit.	
		• If there is a power failure or the AC plug was disconnected while the power was on.	—
		→ The unit is carrying out its recovery process. Wait until the message disappears.	

Before requesting service, make the below checks. If you are in doubt about some of the check points, or if the remedies indicated in the chart do not solve the problem:

In the U.S.A., contact the Panasonic Customer Call Center at 1-800-211-7262, or e-mail consumerproducts@panasonic.com, or web site (<http://www.panasonic.com>).

In Canada, contact Panasonic Canada Inc. Customer Care Centre at 1-800-561-5505, web site (www.panasonic.ca), or an authorized Servicentre closest to you.

Power

Page

No power.	Insert the AC power supply cord securely into a known active AC outlet.	11
The unit switches to the standby mode.	<ul style="list-style-type: none"> This is a power saving feature. You can turn it off if you would prefer (Set Up—Off Timer—Off). Press [⏻, DVD POWER] to turn the unit on. One of the unit's safety devices may have activated. Press [⏻, DVD POWER] to turn the unit on. 	60 —

Operation

The unit is on but cannot be operated.	<ul style="list-style-type: none"> Some operations may be prohibited by the disc. Recording drive or playback drive have not been selected properly. The unit is hot ("U14" appears on the display). Wait for "U14" to disappear. One of the unit's safety devices may have activated. <p>Reset the unit as follows:</p> <ol style="list-style-type: none"> Press [⏻, DVD POWER] to switch the unit to standby. If the unit doesn't switch to standby, press and hold [⏻, DVD POWER] for about 10 seconds. The unit is forcibly switched to standby. Alternatively, disconnect the AC power supply cord, wait one minute, then reconnect it. Press [⏻, DVD POWER] to turn the unit on. 	— 19, 23 67 —
---	--	------------------------

Picture

• When progressive output is on, refer also to the section listed under "**Progressive video**" below.

The images from this unit do not appear on the television.	<ul style="list-style-type: none"> Make sure that the television is connected to the AUDIO/VIDEO terminal, S-VIDEO OUT terminal or COMPONENT VIDEO OUT terminal on this unit. Make sure that the television's input setting (e.g., VIDEO 1) is correct When using this unit for the first time, the HDD has nothing recorded on it. You must record a program etc. to the HDD before you can enjoy playback. You have set "TV Type" to "480P" in the SETUP menus, but the television isn't compatible with progressive signals. Press and hold [■] and [■] on the unit at the same time for about 5 seconds. The setting will change to interlace. 	11 — 19 —
Television reception worsens after connecting the unit.	<ul style="list-style-type: none"> This can occur because the signals are being divided between the unit and the television. It can be solved by using a signal booster, available from audio-visual suppliers. Consult your dealer if reception does not improve. Due to inherent characteristics of the HDD, the picture may occasionally be disturbed. This is normal. 	— —
Screen size is wrong.	<ul style="list-style-type: none"> Check the settings on your television. Check the settings for "TV Aspect", "4:3 TV Settings for DVD-Video" or "4:3 TV Settings for DVD-RAM" in the TV Screen SETUP menus. 	— 16, 61
On-screen messages do not appear.	<ul style="list-style-type: none"> Go to Display in the SETUP menus and select "Automatic" for "Status Messages". Press [STATUS] to show the on-screen messages constantly. 	61 54
The blue background does not appear.	<ul style="list-style-type: none"> Go to Display in the SETUP menus and select "On" for "Blue Background". 	61
There is ghosting.	<ul style="list-style-type: none"> Change the settings for "3D NR", "Block NR", and "Mosquito NR" to "0" or turn "MPEG-DNR" off with the on-screen menus. 	52

Progressive video

There is ghosting when progressive output is on.	<ul style="list-style-type: none"> Select "Video" in the on-screen menu and set "Progressive" to "OFF". This problem is caused by the editing method or material used on DVD, but should be corrected if you use interlace output. 	52
There is no apparent change in picture quality when adjusted with the Video menu in the on-screen menus.	<ul style="list-style-type: none"> The effect is less perceivable with some types of video. 	—

Sound

No sound. Low volume. Distorted sound.	<ul style="list-style-type: none"> • Check the connections. Check the input mode on the amplifier if you have connected one. • Turn V.S.S. off if it causes distortion. 	11, 56-58 51
Cannot hear the desired audio type.	<ul style="list-style-type: none"> • Press [AUDIO] to select the desired audio type. • Go to Audio in the SETUP menus and choose the correct setting with "Select MTS for DVD-R or LPCM". • If you are recording a television program and change the drive, you cannot change the audio on that drive. The audio will be the type selected for recording. 	30 61 30
Cannot switch audio during stereo or SAP broadcasts.	<ul style="list-style-type: none"> • You have used digital connection. Set "Dolby Digital" to "PCM" or connect to other equipment using audio cables (analog connection). • You cannot change the audio type when using DVD-R or with LPCM recordings. 	57, 62 —

Play

Play fails to start even when [▶] (PLAY) is pressed. Play starts but then stops immediately.	<ul style="list-style-type: none"> • Insert the disc correctly with the label facing up. • This unit cannot play discs other than DVD-RAM, DVD-R, DVD-Video, Video CD, and CD. • The disc is dirty. Clean it. • The disc may be badly scratched. • You inserted a blank DVD-RAM or DVD-R. 	18 8 10 — —
A title or chapter doesn't play when it is selected.	<ul style="list-style-type: none"> • Some titles and chapters on DVD-Video are not played when you have changed the ratings level. 	62
Picture distorted during search.	<ul style="list-style-type: none"> • Some distortion is normal. 	—
Alternative soundtrack and subtitles cannot be selected.	<ul style="list-style-type: none"> • The languages are not recorded on the disc. • You may have to use the disc's menus to select languages. 	— 23
No subtitles.	<ul style="list-style-type: none"> • Subtitles are not recorded on the disc. • Turn the subtitles on. 	— 50
Angle cannot be changed.	<ul style="list-style-type: none"> • This function depends on software availability. Angles can only be changed during scenes where different angles are recorded. 	—
You have forgotten your ratings password.	<ul style="list-style-type: none"> • Return the ratings setting to "8". Press [DVD] and then [▲ OPEN/CLOSE]. While the disc tray is open, press and hold [◀◀/▶▶] and [▶▶/▶▶] on the main unit at the same time for 5 or more seconds. 	—

Displays

The display is dim.	<ul style="list-style-type: none"> • Go to Display in the SETUP menus and change the display's brightness with "FL Display". 	61
"12:00" is flashing on the unit's display.	<ul style="list-style-type: none"> • The clock is not set. Go to Set Up in the SETUP menus and set the clock with "Clock settings". 	64
The displayed recording time and actual recording time differ.	<ul style="list-style-type: none"> • Displayed recording time is calculated based on the number of frames recorded per second. This number is subject to minute variation. When the recording time is long the cumulative effect of these small differences may result in the slight variation you may sometimes find between displayed recording time and actual recording time. This is normal. 	—

Remote control

The remote control doesn't work.	<ul style="list-style-type: none"> • [DVD, TV] is not switched to "DVD". Switch to "DVD" when operating this unit. • The remote control and main unit are using different codes. Change the code on the remote control or main unit. • The batteries are depleted. Replace them with new ones. • Point the remote control at the remote control sensor on the main unit. • Remove obstacles from between the remote control and main unit. 	6 65 10 10 —
Cannot operate the television.	<ul style="list-style-type: none"> • Change manufacturer code. Some televisions cannot be operated even if you change the code. • [DVD, TV] is not switched to "TV". Switch to "TV" when selecting the receiving channel for the television. 	17 6

Recording and timer recording

Page

Cannot record.	• You haven't inserted a disc or the disc you inserted cannot be recorded on. Insert a disc the unit can record onto.	8
	• The disc is unformatted. Format the disc so this unit can record on it.	38
	• The disc is protected with the write-protect tab. Use a ballpoint pen or similar to release the write protection.	8
	• Some programs have limitations on the number of times they can be recorded.	—
	• The disc is protected with DISC SETTING. Cancel Disc Protection.	38
	• The HDD or the disc is full or nearly full. Erase unneeded programs or use another disc.	40
	• You cannot record on finalized DVD-R discs.	—
VCR Plus+ programming does not work properly.	• The guide channels are incorrect. Go to Channel in the SETUP menus and correct them with "VCR Plus+ CH Setting".	14
	• The clock is wrong. Go to Set Up in the SETUP menus and correct it with "Clock settings".	64
Timer recording does not work properly.	• The timer program is incorrect. Correct the program.	37
	• Different timer program times overlap.	—
	• The clock is wrong. Go to Set Up in the SETUP menus and correct it with "Clock settings".	64
	• Timer recording will not be activated during operations that cannot be interrupted such as formatting, dubbing, some types of editing of still pictures etc.	—
The timer program remains even after recording finishes.	• The program remains if you select a daily or weekly setting.	35
Timer recording does not stop even when [■] is pressed.	• Press [■] and then [ENTER] within 5 seconds. Recording stops.	—
The available recording time doesn't increase even after erasing recordings on the disc.	• As this unit is unable to erase data written to DVD-RAM with a computer, the available recording time does not increase. The data will be erased if you reformat the disc.	38
	• If the disc is dirty, wipe with the DVD-RAM/PD disc cleaner (optional) before formatting.	10
A part or whole of a recorded program has been lost.	• If there is a power failure or the plug is disconnected from the household AC outlet while recording or editing, the program may be lost or the HDD/disc may become unusable. → We cannot offer any guarantee regarding lost programs or discs. You will have to format (for HDD, DVD-RAM) or use a new disc.	38

Still pictures (JPEG)

The contents of the PC card cannot be read.	• The PC card format is not compatible with the unit. → Format using FAT 12 or FAT 16 with other equipment or format the PC card with this unit.	48
	• The unit tried to display still picture files that were in a folder level that is not compatible.	9
	• The still picture file is not JPEG. → This unit displays still pictures (JPEG) that are in accordance with DCF standard.	9
	• Turn off and then turn on the unit again.	—
	• When there are a lot of folders and files, it may sometimes take a few hours. • When repeating copying or erasing, it may sometimes take a long time. Format the disc or PC card.	38, 48
Copying, erasing and setting protection takes a long time.		
The tray won't open/close.	• The tray cannot be opened or closed while the still pictures are played back and editing screen is being displayed. Press [RETURN] a few times to clear the screen.	—
The PC card cannot be removed.	• Make sure the PC card is slotted home firmly before attempting to remove.	25
Timer recording began in the middle of editing a still picture.	• If it comes to the time scheduled for timer recording, the recording may start even though you are editing.	—

Discs make sounds as they rotate. This does not indicate a malfunction.

Maintenance

The precision parts in this unit are readily affected by the environment, especially temperature, humidity, and dust. Cigarette smoke also can cause malfunction or breakdown.

If the front panel half mirror is dirty, wipe with the included cleaning cloth. If any other parts apart from the front panel are dirty, wipe with a soft, dry cloth.

- Never use alcohol, paint thinner or benzine to clean this unit
- Before using chemically treated cloth, read the instructions that came with the cloth carefully.

Observe the following points to ensure continued listening and viewing pleasure.

Dust and dirt may adhere to the unit's lens over time, making it impossible to record or play discs.

Use **DVD-RAM/PD lens cleaner (LF-K123LCA1)** every 1 to 4 months, depending on frequency of use and the operating environment.

Read the lens cleaner's instructions carefully before use.

Specifications

Recording system: DVD video recording standards (DVD-RAM), DVD video standards (DVD-R)

Hard disk drive capacity: 40 GB

Optical pick-up: System with 1 lens, 2 integration units (662 nm wavelength for DVDs, 790 nm wavelength for CDs)

Recordable discs: 12 cm 4.7 GB DVD-RAM discs
12 cm 9.4 GB DVD-RAM discs
8 cm 2.8 GB DVD-RAM discs
12 cm 4.7 GB DVD-R discs (for General Ver. 2.0)

Recording time (1): Max. 6 hours (using 4.7 GB disc)
XP: 1 hour SP: 2 hours
LP: 4 hours EP: 6 hours

Recording time (2): Max. 52 hours (using Hard disk drive)
XP: 8.5 hours SP: 17 hours
LP: 34 hours EP: 52 hours

Discs played: 12 cm 4.7 GB DVD-RAM discs
12 cm 9.4 GB DVD-RAM discs
8 cm 2.8 GB DVD-RAM discs
12 cm 4.7 GB DVD-R discs (for General Ver. 2.0)
DVD-VIDEO discs
CD-Audio discs (CD-DA)
Video CD discs
CD-R/CD-RW discs (CD-DA, Video CD formatted discs)

Video system

TV system: NTSC system, 525 lines, 60 fields

Recording system: MPEG2 (Hybrid VBR)

Input: LINE (pin jack), 1.0 Vp-p; 75 Ω
S connector Y: 1.0 Vp-p; 75 Ω
C: 0.286 Vp-p; 75 Ω

Output: LINE (pin jack), 1.0 Vp-p; 75 Ω
S connector Y: 1.0 Vp-p; 75 Ω
C: 0.286 Vp-p; 75 Ω

Component video output (480P/480i):

Y: 1.0 Vp-p; 75 Ω
Pb: 0.7 Vp-p; 75 Ω
Pr: 0.7 Vp-p; 75 Ω

Antenna reception input:

TV Channel: 2ch–69ch, 75 Ω
CATV Channel: 1ch–125ch, 75 Ω

Audio system

Recording system: Dolby Digital (XP/SP/LP/EP)
LINEAR PCM (XP mode only)

Input: LINE (pin jack)
Reference input: 309 mVrms
FS: 2 Vrms (1 kHz, 0 dB)
Input impedance: 47 kΩ

Output: LINE (pin jack)
Reference output: 309 mVrms
FS: 2 Vrms (1 kHz, 0 dB)
Output impedance: 1 kΩ
(Load impedance: 10 kΩ)

Number of channels: Recording: 2 channels
Playback: 2 channels

Other input/output connectors:

Digital audio optical output connector (PCM, Dolby Digital, DTS)

Operating temperature range:

5 °C–40 °C (41 °F–104 °F)

Operating humidity range:

10 %–80 % RH (no condensation)

Clock unit:

Quartz-controlled 12-hour digital display

LASER Specification

Class / LASER Product

Wave length: 775–815 nm 655–666 nm

Laser power: No hazardous radiation is emitted with the safety protection

DV input: IEEE 1394 Standard, 4 pin

PC card slot: PC Card Type II

Compatible media: A PC Card adaptor conforming to PC Card Standards

PC Card adaptor (SD Memory Card, Multi Media Card, Compact Flash, Smart Media, Memory Stick)

Format: FAT12 or FAT16

Image format: JPEG conforming to DCF (Design rule for Camera File system)
DPOF Compatible

Number of pixels: 320 × 240 to 6144 × 4096 (sub sampling; 4:2:2 or 4:2:0)

Thawing time: Approx. 7 sec. (2 M pixels)

Power supply: AC 120 V, 60 Hz

Power consumption: 36 W

Dimensions: Approx. 430 (W) × 79 (H) × 306 (D) mm
[Approx. 16¹⁵/₁₆" (W) × 3¹/₈" (H) × 12¹/₁₆" (D)]
(excluding protrusions)

Mass: Approx. 4.5 kg (9.9 lbs)

Power consumption in standby mode: approx. 3.3 W

Note

Specifications are subject to change without notice.
Mass and dimensions are approximate.

Product Service

- Damage requiring service**—The unit should be serviced by qualified service personnel if:
 - The AC power supply cord or AC adaptor has been damaged; or
 - Objects or liquids have gotten into the unit; or
 - The unit has been exposed to rain; or
 - The unit does not operate normally or exhibits a marked change in performance; or
 - The unit has been dropped or the cabinet damaged.
- Servicing**—Do not attempt to service the unit beyond that described in these operating instructions. Refer all other servicing to authorized servicing personnel.

- Replacement parts**—When parts need replacing ensure the servicer uses parts specified by the manufacturer or parts that have the same characteristics as the original parts. Unauthorized substitutes may result in fire, electric shock, or other hazards.
- Safety check**—After repairs or service, ask the servicer to perform safety checks to confirm that the unit is in proper working condition.

Product information

For product information or assistance with product operation:

In the U.S.A., contact the Panasonic Customer Call Center at 1-800-211-7262, or e-mail consumerproducts@panasonic.com, or web site (<http://www.panasonic.com>).

In Canada, contact Panasonic Canada Inc. Customer Care Centre at 1-800-561-5505, web site (www.panasonic.ca), or an authorized Servicentre closest to you.

Limited Warranty (ONLY FOR U.S.A.)

Panasonic Consumer Electronics Company,
Division of Matsushita Electric Corporation of America
One Panasonic Way Secaucus, New Jersey 07094

Panasonic Sales Company, Division of Matsushita Electric
of Puerto Rico, Inc.
Ave. 65 de Infantería, Km. 9.5
San Gabriel Industrial Park, Carolina, Puerto Rico 00985

Panasonic DVD Player/Recorder Limited Warranty

Limited Warranty Coverage

If your product does not work properly because of a defect in materials or workmanship, Panasonic Consumer Electronics Company or Panasonic Sales Company (collectively referred to as "the warrantor") will, for the length of the period indicated on the chart below, which starts with the date of original purchase ("warranty period"), at its option either (a) repair your product with new or refurbished parts, or (b) replace it with a new or a refurbished product. The decision to repair or replace will be made by the warrantor.

Product or Part Name	Parts	Labor
DVD Player	One (1) Year	Ninety (90) Days
DVD Recorder	One (1) Year	One (1) Year
Rechargeable Batteries, DVD-RAM Disc (in exchange for defective item)	Ten (10) Days	Not Applicable

During the "Labor" warranty period there will be no charge for labor. During the "Parts" warranty period, there will be no charge for parts. You must carry-in or mail-in your product during the warranty period. If non-rechargeable batteries are included, they are not warranted. This warranty only applies to products purchased and serviced in the United States or Puerto Rico. This warranty is extended only to the original purchaser of a new product which was not sold "as is". A purchase receipt or other proof of the original purchase date is required for warranty service.

Carry-In or Mail-In Service

For Carry-In or Mail-In Service in the United States call 1-800-211-PANA(7262) or visit Panasonic Web Site: <http://www.panasonic.com>
For assistance in Puerto Rico call Panasonic Sales Company (787)-750-4300 or fax (787)-768-2910.

Limited Warranty Limits And Exclusions

This warranty ONLY COVERS failures due to defects in materials or workmanship, and DOES NOT COVER normal wear and tear or cosmetic damage. The warranty ALSO DOES NOT COVER damages which occurred in shipment, or failures which are caused by products not supplied by the warrantor, or failures which result from accidents, misuse, abuse, neglect, mishandling, misapplication, alteration, faulty installation, set-up adjustments, misadjustment of consumer controls, improper maintenance, power line surge, lightning damage, modification, or commercial use (such as in a hotel, office, restaurant, or other business), rental use of the product, service by anyone other than a Factory Servicenter or other Authorized Servicer, or damage that is attributable to acts of God.

THERE ARE NO EXPRESS WARRANTIES EXCEPT AS LISTED UNDER "LIMITED WARRANTY COVERAGE". THE WARRANTOR IS NOT LIABLE FOR INCIDENTAL OR CONSEQUENTIAL DAMAGES RESULTING FROM THE USE OF THIS PRODUCT, OR ARISING OUT OF ANY BREACH OF THIS WARRANTY. (As examples, this excludes damages for lost time, travel to and from the servicer, loss of media or images, data or other recorded content. The items listed are not exclusive, but are for illustration only.) **ALL EXPRESS AND IMPLIED WARRANTIES, INCLUDING THE WARRANTY OF MERCHANTABILITY, ARE LIMITED TO THE PERIOD OF THE LIMITED WARRANTY.**

Some states do not allow the exclusion or limitation of incidental or consequential damages, or limitations on how long an implied warranty lasts, so the exclusions may not apply to you.

This warranty gives you specific legal rights and you may also have other rights which vary from state to state. If a problem with this product develops during or after the warranty period, you may contact your dealer or Servicenter. If the problem is not handled to your satisfaction, then write to the warrantor's Consumer Affairs Department at the addresses listed for the warrantor.

PARTS AND SERVICE WHICH ARE NOT COVERED BY THIS LIMITED WARRANTY ARE YOUR RESPONSIBILITY.

Customer Services Directory

**For Product Information, Operating Assistance, Literature Request, Dealer Locations, and all Customer Service inquiries please contact:
1-800-211-PANA (7262), Monday-Friday 9 am-9 pm; Saturday-Sunday 9 am-7 pm, EST.**

**Web Site: <http://www.panasonic.com>
You can purchase parts, accessories or locate your nearest servicenter by visiting our Web Site.**

Accessory Purchases:

1-800-332-5368 (Customer Orders Only)
Panasonic Services Company 20421 84th Avenue South, Kent, WA 98032
(6 am to 5 pm Monday-Friday; 6 am to 10:30 am Saturday; PST)
(Visa, MasterCard, Discover Card, American Express, Check)

**Service in Puerto Rico
Matsushita Electric of Puerto Rico, Inc. Panasonic Sales Company/Factory Servicenter:
Ave. 65 de Infantería, Km. 9.5, San Gabriel Industrial Park, Carolina, Puerto Rico 00985
Phone (787) 750-4300 Fax (787) 768-2910**

Limited Warranty (ONLY FOR CANADA)

Panasonic Canada Inc.
5770 Ambler Drive, Mississauga, Ontario L4W 2T3

PANASONIC/TECHNICS PRODUCT—LIMITED WARRANTY

Panasonic Canada Inc. warrants this product to be free from defects in material and workmanship and agrees to remedy any such defect for a period as stated below from the date of original purchase.

Panasonic DVD Recorder One (1) year, parts and labour

LIMITATIONS AND EXCLUSIONS

This warranty does not apply to products purchased outside Canada or to any product which has been improperly installed, subjected to usage for which the product was not designed, misused or abused, damaged during shipping, or which has been altered or repaired in any way that affects the reliability or detracts from the performance, nor does it cover any product which is used commercially. Dry cell batteries are also excluded from coverage under this warranty.

This warranty is extended to the original end user purchaser only. A purchase receipt or other proof of date of original purchase is required before warranty service is performed.

THIS EXPRESS, LIMITED WARRANTY IS IN LIEU OF ALL OTHER WARRANTIES, EXPRESS OR IMPLIED, EXCLUDING ANY IMPLIED WARRANTIES OF MERCHANTABILITY OR FITNESS FOR A PARTICULAR PURPOSE.

IN NO EVENT WILL PANASONIC CANADA INC. BE LIABLE FOR ANY SPECIAL, INDIRECT OR CONSEQUENTIAL DAMAGES.

In certain instances, some jurisdictions do not allow the exclusion or limitation of incidental or consequential damages, or the exclusion of implied warranties, so the above limitations and exclusions may not be applicable.

WARRANTY SERVICE

For product operation and information assistance, please contact your Dealer or our Customer Care Centre at: Telephone #: (905) 624-5505
Fax #: (905) 238-2360 Web: www.panasonic.ca

For product repairs, please contact one of the following:

- Your Dealer who will inform you of an authorized Servicentre nearest you.
- Our Customer Care Centre at (905) 624-5505 or www.panasonic.ca
- A Panasonic Factory Servicentre listed below:

Richmond, British Columbia

Panasonic Canada Inc.
12111 Riverside Way
Richmond, BC
V6W 1K8
Tel: (604) 278-4211
Fax: (604) 278-5627

Calgary, Alberta

Panasonic Canada Inc.
6835-8th St. N. E.
Calgary, AB
T2E 7H7
Tel: (403) 295-3955
Fax: (403) 274-5493

Mississauga, Ontario

Panasonic Canada Inc.
5770 Ambler Dr.
Mississauga, ON
L4W 2T3
Tel: (905) 624-8447
Fax: (905) 238-2418

Lachine, Québec

Panasonic Canada Inc.
3075, rue Louis A. Amos
Lachine, QC
H8T 1C4
Tel: (514) 633-8684
Fax: (514) 633-8020

CUSTOMER'S RECORD:

Customer Name: _____

Model Number: _____ Serial Number: _____

Date of Purchase: _____

Dealer's Name: _____

Address: _____ Phone Number: _____

IF YOU SHIP THE PRODUCT TO A SERVICENTRE

Carefully pack and send prepaid, adequately insured and preferably in the original carton.
Include details of the defect claimed, and proof of date of original purchase.

Guía de referencia rápida en español

Conexiones de antena y televisor

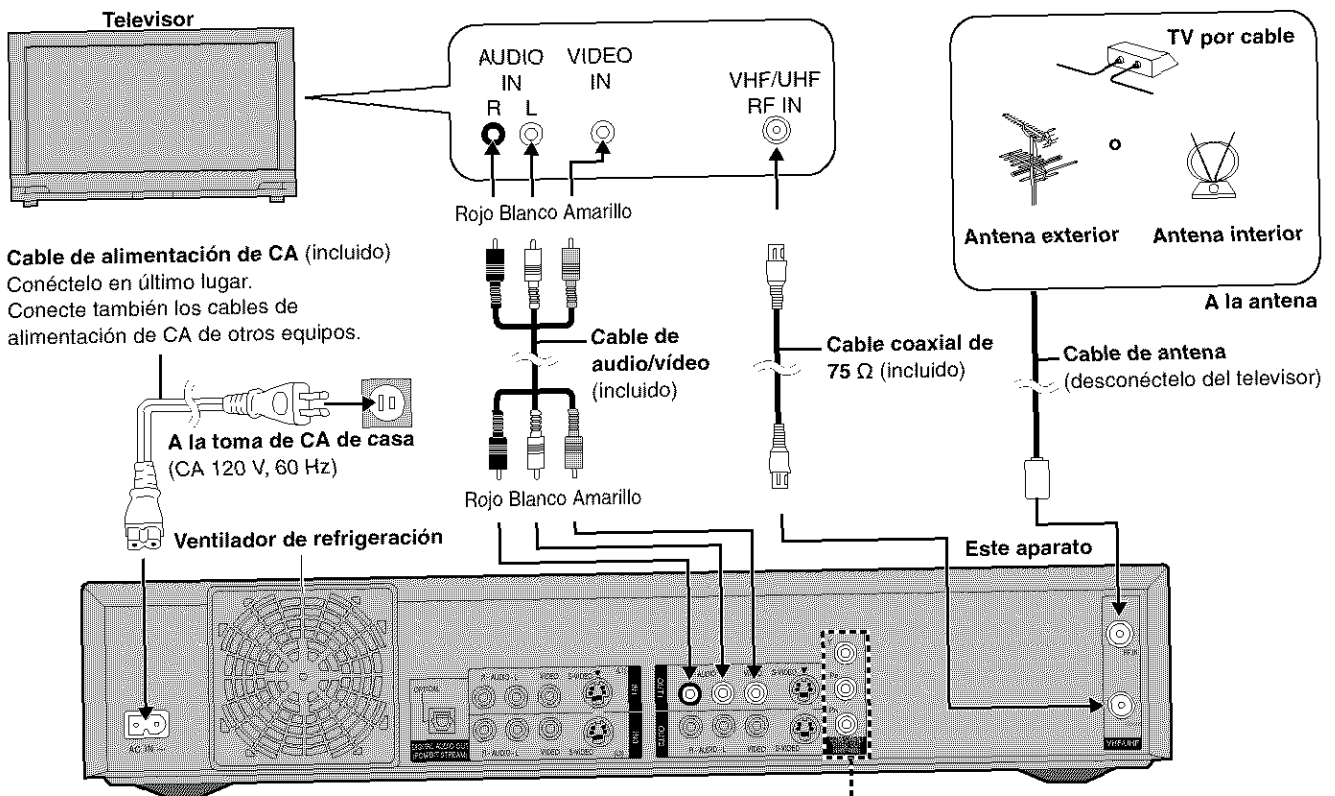

Para disfrutar del vídeo progresivo

- Haga la conexión a los terminales de entrada de vídeo componente (480p) de un televisor que sea compatible con el sistema de protección contra el copiado de este aparato. (La imagen no se visualizará correctamente si se hace la conexión a un televisor incompatible.)
- Ponga "TV Type" en "480P" (→ abajo).
- Para seleccionar el método de conversión para la salida progresiva Durante la reproducción
 1. Pulse [DISPLAY].
 2. Pulse [▲, ▼] para seleccionar "Video" y pulse [▶].
 3. Pulse [▲, ▼] para seleccionar "Progressive" y pulse dos veces [▶].
 4. Pulse [▲, ▼] para establecer "Transfer" según el tipo de material que esté siendo reproducido.

Disc	Picture	Normal
Play	MPEG-DNR	ON
Video	Progressive	ON
Audio	Transfer	Auto 1

Auto1 (normal): Para material de películas

Auto2: Para material de películas (Lo mismo que para Auto1, pero capaz de convertir vídeo progresivo de 30 cuadros por segundo.)

Video: Para material de vídeo

Después de enchufar el aparato en la toma de corriente de su casa y pulsar [⏻, DVD POWER] para encender el aparato por primera vez, éste sintonizará automáticamente todos los canales que pueda recibir y pondrá en hora el reloj. Utilice [ENTER] y siga las instrucciones de la pantalla.

Selección del tipo de pantalla del televisor

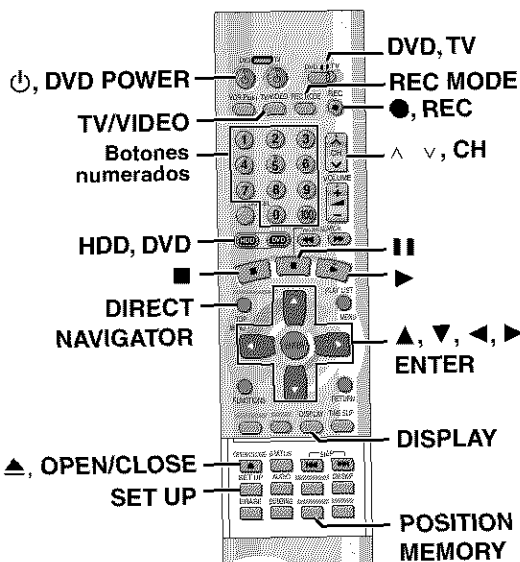

Cambie los ajustes si:

- Conecta el aparato a un televisor de pantalla panorámica con una relación de aspecto de 16:9. → Ponga "TV Aspect" en "16:9".
- Conecta el aparato a través de los terminales de COMPONENT VIDEO OUT a un televisor compatible con señales de vídeo progresivo (480P). → Ponga "TV Type" en "480P".
 1. Pulse [SET UP] para mostrar los menús.
 2. Pulse [▲, ▼] para seleccionar la ficha "TV Screen" y pulse [▶].
 3. Pulse [▲, ▼] para seleccionar "TV Aspect" y pulse [ENTER].
 4. Pulse [▲, ▼] para seleccionar "16:9" y pulse [ENTER].
 5. Pulse [▲, ▼] para seleccionar "TV Type" y pulse [ENTER].
 6. Pulse [▲, ▼] para seleccionar "480P" y pulse [ENTER].
 7. Pulse [SET UP].

Grabación de programas de televisión

HDD RAM DVD-R

1 Pulse [⏻, DVD POWER] para encender el aparato.

2 Pulse [HDD] o [DVD] para seleccionar la unidad de grabación.

El botón HDD o DVD se enciende en el aparato.

- No es posible grabar simultáneamente en la HDD (unidad de disco duro) y en la unidad DVD.

3 Si usted seleccionó la unidad DVD Pulse [▲, OPEN/CLOSE] para abrir la bandeja e inserte un disco.

- Pulse de nuevo el botón para cerrar la bandeja.
- No se puede grabar continuamente los dos lados de un disco de dos lados. Tendrá que expulsar el disco y darlo la vuelta.

Inserte el disco con la etiqueta hacia arriba y la flecha indicando hacia adentro.

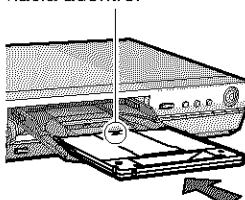

Inserte con la etiqueta hacia arriba.

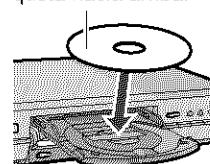

4 Asegúrese de que [DVD, TV] esté en "DVD" y pulse [^ v, CH] para seleccionar el canal.

5 Pulse [REC MODE] para seleccionar el modo de grabación.

- Seleccione "XP", "SP", "LP" o "EP".

6 Pulse [●, REC] para iniciar la grabación.

La luz de grabación de HDD o DVD en el aparato principal se enciende.

- Para detener la grabación

Pulse [■].

- Para hacer una pausa en la grabación

Pulse [■]. (Púlselo de nuevo para reiniciar la grabación.)

- Para ver la televisión mientras se graba

HDD RAM DVD-R

Las imágenes que estén siendo grabadas no serán afectadas.

① Ponga [DVD, TV] en "TV".

② Pulse [TV/VIDEO] para cambiar el modo de entrada de televisión a "TV".

③ Pulse [^ v, CH] para cambiar los canales.

- Reproducción desde el principio del programa que está grabando—Reproducción en persecución

HDD RAM

Durante la grabación

Pulse [▶] (PLAY).

La reproducción empieza desde el comienzo del programa que está siendo grabado.

- Grabación y reproducción simultáneas **HDD RAM**

1. Durante la grabación

Pulse [DIRECT NAVIGATOR].

2. Pulse [▲, ▼] para seleccionar un programa y pulse [ENTER].

Para detener la reproducción y la grabación

① Pulse [■]. (La reproducción se para.)

Espere 2 segundos.

② Pulse [■]. (La grabación se para.)

Reproducción de discos

HDD RAM DVD-R DVD-V CD VCD

Acerca de la HDD (unidad de disco duro)

Cuando utilice este aparato por primera vez, la HDD no tendrá nada grabado en ella. Tendrá que grabar un programa, etc. en la HDD antes de poder disfrutar de la reproducción.

1 Pulse [⏻, DVD POWER] para encender el aparato.

2 Pulse [HDD] o [DVD] para seleccionar la unidad de reproducción.

El botón HDD o DVD se enciende en el aparato.

- No es posible reproducir simultáneamente en la HDD (unidad de disco duro) y en la unidad DVD.

3 Si usted seleccionó la unidad DVD Pulse [▲, OPEN/CLOSE] para abrir la bandeja e inserte un disco (→ izquierda).

- Pulse de nuevo el botón para cerrar la bandeja.
- No se pueden reproducir continuamente los dos lados de un disco de dos lados. Tendrá que expulsar el disco y darlo la vuelta.

4 Pulse [▶] (PLAY).

- Para detener la reproducción

Pulse [■].

- Para hacer una pausa en la reproducción

Pulse [■]. (Púlselo de nuevo para reiniciar la reproducción.)

- Cuando aparece una pantalla de menú en el televisor

VCD

Ponga [DVD, TV] en "DVD" y

Pulse los botones numerados (0, 1–9) para seleccionar un elemento.

ej. "5": [0] → [5] "15": [1] → [5]

DVD-V

Pulse [▲, ▼, ◀, ▶] para seleccionar el elemento y pulse [ENTER].

- Para seleccionar un elemento también podrá utilizar los botones numerados (0, 1–9).

- Inicio de la reproducción desde donde usted la detuvo—Función de reanudación

1. Durante la reproducción

Pulse [■].

El aparato memoriza la posición.

2. Mientras parpadea "PLAY" en el visualizador

Pulse [▶] (PLAY).

La reproducción empieza desde donde usted la detuvo.

Para cancelar la función de reanudación

Pulse [■] hasta que se apague "PLAY".

Para iniciar la reproducción desde una posición memorizada después de apagar el aparato

Pulse [POSITION MEMORY] durante la reproducción.

(El mensaje "Position Memorized" aparece en el televisor.)

Ahora, cuando pulse [▶] (PLAY) después de poner el aparato en el modo de espera y luego volver a encenderlo, la reproducción empezará desde la posición memorizada y la posición se cancelará.

Index

A-B repeat	51	FUNCTIONS window	53
All copy of PC card	46	Gamma	52
Angle	50	Language code list	63
Antenna system	13	LPCM	61, 66
Audio attribute	50	Marker	28
Auto Renewal Recording	36	Mosquito NR	52
Block NR	52	MPEG-DNR	52
Brightness	52	One Touch Recording	20
Channel Caption	15	On-screen display	54
Channel Setting	15	On-screen menu	50
Chasing play	21	PC card	9, 25
Cleaning		PCM Down Conversion	62
disc	10	PLAY FROM TOP	53
lens	70	Play list	27, 42, 44
main unit	70	Position memory function	23
Clock setting	64	Program play	29
CM Skip	24	Progressive	11, 16, 52
Color	52	Properties	
Connection		play list	42
amplifier, system component	57	program	40
antenna	59	Protection	
antenna, television	11	cartridge	8
cable TV box, satellite receiver	56	disc	38
video equipment	58	program	40
Contrast	52	Random play	29
Copy	46	Ratings password	62, 69
CPRM system	66	Recording mode	19
Dialog Enhancer	51	Re-initialize Setting	60
Direct Navigator	26, 40	Relief Recording	35
Divide Program	40	Repeat play	51
DPOF	48	Resume function	23
Dubbing	32	Seamless Play	61
DV Automatic Recording (DV AUTO REC)	31	SETUP menu	60
DVD-R Menu Screen	38	Sharpness	52
Edit Scenes	42	Shorten Segment	40
Enter Title		Simultaneous rec and play	21
disc	38	Sound track	50
folder	47	Still pictures (JPEG)	9, 25, 46, 48
play list	42	Subtitle	50
program	34, 40	Time Slip	21, 24
Erase		Timer recording	34-37
all programs	38	Transfer	52
play list	27, 42	TV Aspect	16
play list scene	27, 42	TV Type	16
program	26, 40	VCR Plus+	
Finalize	38	guide channel	14
Flexible Recording (FR)	19, 20	timer recording	34
Format		V.S.S.	51
Hard Disk	38	3D NR	52
DVD-RAM	38		
PC card	48		

User memo

DATE OF PURCHASE _____
 DEALER NAME _____
 DEALER ADDRESS _____

 TELEPHONE NUMBER _____

All other names, company names, product names, etc. in these instructions are the trademarks or registered trademarks of their respective corporations.

The model number and serial number of this product can be found on either the back or the bottom of the unit. Please note them in the space provided below and keep for future reference.

MODEL NUMBER _____ DMR-HS2 _____
 SERIAL NUMBER _____

Panasonic Consumer Electronics Company, Division of Matsushita Electric Corporation of America
 One Panasonic Way Secaucus, New Jersey 07094
<http://www.panasonic.com>

Panasonic Sales Company, Division of Matsushita Electric of Puerto Rico, Inc. ("PSC")
 Ave. 65 de Infantería, Km. 9.5 San Gabriel Industrial Park, Carolina, Puerto Rico 00985

Panasonic Canada Inc. (En) (Sp)
 5770 Ambler Drive
 Mississauga, Ontario
 L4W 2T3
www.panasonic.ca