



WEGA

FD Trinitron

TM

Operating Instructions

KV-32FV16 KV-36FV

KV-32FV26

WARNING

To reduce the risk of fire or shock hazard, do not expose the TV to rain or moisture.



This symbol is intended to alert the user to the presence of uninsulated "dangerous voltage" within the product's enclosure that may be of sufficient magnitude to constitute a risk of electric shock to persons.



This symbol is intended to alert the user to the presence of important operating and maintenance (servicing) instructions in the literature accompanying the appliance.

CAUTION

TO PREVENT ELECTRIC SHOCK, MATCH WIDE BLADE OF PLUG TO WIDE SLOT, FULLY INSERT.

CAUTION

When using TV games, computers, and similar products with your TV, keep the brightness and contrast functions at low settings. If a fixed (non-moving) pattern is left on the screen for long periods of time at a high brightness or contrast setting, the image can be permanently imprinted onto the screen. Continuously watching the same program can cause the imprint of station logos onto the TV screen. These types of imprints are not covered by your warranty because they are the result of misuse.

Note on Caption Vision

This television receiver provides display of television closed captioning in accordance with §15.119 of the FCC rules.

Note on Cleaning the TV

Clean the TV with a soft dry cloth. Never use strong solvents such as thinner or benzene, which might damage the finish of the cabinet.

Note to CATV System Installer

This reminder is provided to call the CATV system installer's attention to Article 820-40 of the NEC that provides guidelines for proper grounding and, in particular, specifies that the cable ground shall be connected to the grounding system of the building, as close to the point of cable entry as practical.

Use of this television receiver for other than private viewing of programs broadcast on UHF or VHF or transmitted by cable companies for the use of the general public may require authorization from the broadcaster/cable company and/or program owner.

NOTIFICATION

This equipment has been tested and found to comply with the limits for a Class B digital device pursuant to Part 15 of the FCC Rules. These limits are designed to provide reasonable protection against harmful interference in a residential installation. This equipment generates, uses, and can radiate radio frequency energy and, if not installed and used in accordance with the instructions, may cause harmful interference with radio communications. However, there is no guarantee that interference will not occur in a particular installation. If this equipment does cause harmful interference to radio or television reception, which can be determined by turning the equipment off and on, the user is encouraged to try to correct the interference by one or more of the following measures:

- Reorient or relocate the receiving antennas.
 - Increase the separation between the equipment and receiver.
 - Connect the equipment into an outlet on a circuit different from that to which the receiver is connected.
 - Consult the dealer or an experienced radio/TV technician for help.
- You are cautioned that any changes or modifications not expressly approved in this manual could void your authority to operate this equipment.

Safety

- Operate the TV only on 120 V AC.
- The plug is designed, for safety purposes, to fit into the wall outlet only one way. If you are unable to insert the plug fully into the outlet, contact your dealer.
- If any liquid or solid object should fall inside the cabinet, unplug the TV immediately and have it checked by qualified service personnel before operating it further.

Installing

- To prevent internal heat buildup, do not block the ventilation openings.
- Do not install the TV in a hot or humid place, or in a place subject to excessive dust or mechanical vibration.
- The AC power cord is attached to the rear of the TV with hooks. Do not attempt to remove the cord from these hooks. Doing so could cause damage to the TV.



As an ENERGY STAR® Partner, Sony has determined that this product or product models meets the ENERGY STAR® guidelines for energy efficiency.

ENERGY STAR® is a U.S. registered mark.

●[®] SRS Sound Retrieval System

The ●[®] SRS (SOUND RETRIEVAL SYSTEM) is manufactured by Sony Corporation under license from SRS Labs, Inc. It is covered by U.S. Patent No. 4,748,669. Other U.S. and foreign patents pending. The word "SRS" and the SRS symbol (●) are registered trademarks of SRS Labs, Inc.

Licensed by BBE Sound, Inc. under USP 4638258.4482866. BBE and BBE symbol are trademarks of BBE Sound, Inc.

FD Trinitron and the Wega logo are trademarks of Sony Corporation.

Owner's Record

The model and serial numbers are provided on the front of this instruction manual and at the rear of the TV. Refer to them whenever you call upon your Sony dealer regarding this product.

About this Manual

This manual is for models KV-32FV16, KV-32FV26, KV-36FS12, KV-36FS16, KV-36FV16, and KV-36FV26. The menu and illustrations shown are for model KV-36FV26 to show the maximum features available. Differences in operation will be indicated in the text, for example, "For KV-36FV26 only."

Important Safeguards

For your protection, please read these instructions completely, and keep this manual for future reference.

Carefully observe and comply with all warnings, cautions and instructions placed on the set or described in the operating instructions or service manual.

WARNING

To guard against injury, the following basic safety precautions should be observed in the installation, use and servicing of the set.

Use

Power Sources

This set should be operated only from the type of power source indicated on the serial/model plate. If you are not sure of the type of electrical power supplied to your home, consult your dealer or local power company. For those sets designed to operate from battery power, refer to the operating instructions.

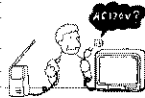

Grounding or Polarization

This set is equipped with a polarized AC power cord plug (a plug having one blade wider than the other), or with a three-wire grounding type plug (a plug having a third pin for grounding). Follow the instructions below:

For the set with a polarized AC power cord plug

This plug will fit into the power outlet only one way. This is a safety feature. If you are unable to insert the plug fully into the outlet, try reversing the plug. If the plug still fails to fit, contact your electrician to have a suitable outlet installed. Do not defeat the safety purpose of the polarized plug by forcing it in.



Alternate Warning

For the set with a three-wire grounding type AC plug

This plug will only fit into a grounding-type power outlet. This is a safety feature. If you are unable to insert the plug into the outlet, contact your electrician to have a suitable outlet installed. Do not defeat the safety purpose of the grounding plug.



Overloading

Do not overload wall outlets, extension cords or convenience receptacles beyond their capacity, since this can result in fire or electric shock.



Always turn the set off when it is not being used. When the set is left unattended and unused for long periods of time, unplug it from the wall outlet as a precaution against the possibility of an internal malfunction that could create a fire hazard.



If a snapping or popping sound from a TV set is continuous or frequent while the TV is operating, unplug the TV and consult your dealer or service technician. It is normal for some TV sets to make occasional snapping or popping sounds, particularly when being turned on or off.



Object and Liquid Entry

Never push objects of any kind into the set through the cabinet slots as they may touch dangerous voltage points or short out parts that could result in a fire or electric shock. Never spill liquid of any kind on the set.



Cleaning

Unplug the set from the wall outlet before cleaning or polishing it. Do not use liquid cleaners or aerosol cleaners. Use a cloth lightly dampened with water for cleaning the exterior of the set.



Installation

Attachments

Do not use attachments not recommended by the manufacturer, as they may cause hazards.

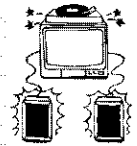

Water and Moisture

Do not use power-line operated sets near water — for example, near a bathtub, washbowl, kitchen sink, or laundry tub, in a wet basement, or near a swimming pool, etc.



Accessories

Do not place the set on an unstable cart, stand, table or shelf. The set may fall, causing serious injury to a child or an adult and serious damage to the set. Use only a cart or stand recommended by the manufacturer for the specific model of TV. An appliance and cart combination should be moved with care. Quick stops, excessive force, and uneven surfaces may cause the appliance and cart combination to overturn.



Ventilation

The slots and openings in the cabinet and in the back or bottom are provided for necessary ventilation. To ensure reliable operation of the set, and to protect it from overheating, these slots and openings must never be blocked or covered.

- ❑ Never cover the slots and openings with a cloth or other materials.
- ❑ Never block the slots and openings by placing the set on a bed, sofa, rug or other similar surface.
- ❑ Never place the set in a confined space, such as a bookcase or built-in cabinet, unless proper ventilation is provided.
- ❑ Do not place the set near or over a radiator or heat register, or where it is exposed to direct sunlight.

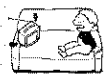

Power-Cord Protection

Do not allow anything to rest on or roll over the power cord, and do not place the set where the power cord is subject to wear or abuse.

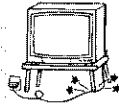

Antennas

Outdoor Antenna Grounding

If an outdoor antenna is installed, follow the precautions below. An outdoor antenna system should not be located in the vicinity of overhead power lines or other electric light or power circuits, or where it can come in contact with such power lines or circuits.

WHEN INSTALLING AN OUTDOOR ANTENNA SYSTEM, EXTREME CARE SHOULD BE TAKEN TO KEEP FROM CONTACTING SUCH POWER LINES OR CIRCUITS AS CONTACT WITH THEM IS ALMOST INVARIABLY FATAL.

Be sure the antenna system is grounded so as to provide some protection against voltage surges and built-up static charges. Section 810 of the National Electrical Code (NEC) in USA and Section 54 of the Canadian Electrical Code in Canada provides information with respect to proper grounding of the mast and supporting structure, grounding of the lead-in wire to an antenna discharge unit, size of grounding conductors, location of antenna discharge unit, connection to grounding electrodes, and requirements for the grounding electrode.

Antenna Grounding According to the NEC

Refer to section 54-300 of Canadian Electrical Code for Antenna Grounding.

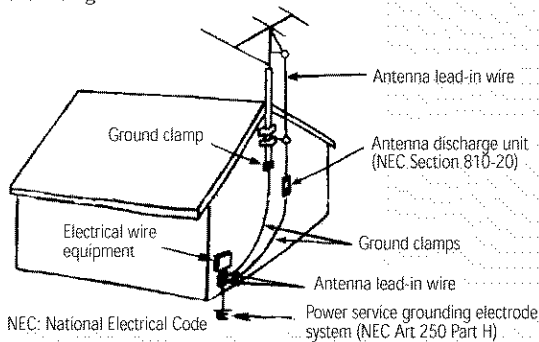

Lightning

For added protection for this television receiver during a lightning storm, or when it is left unattended and unused for long periods of time, unplug it from the wall outlet and disconnect the antenna. This will prevent damage to the receiver due to lightning and power-line surges.

Service

Damage Requiring Service

Unplug the set from the wall outlet and refer servicing to qualified service personnel under the following conditions:

- When the power cord or plug is damaged or frayed.
- If liquid has been spilled into the set.
- If the set has been exposed to rain or water.
- If the set has been subject to excessive shock by being dropped, or the cabinet has been damaged.
- If the set does not operate normally when following the operating instructions. Adjust only those controls that are specified in the operating instructions. Improper adjustment of other controls may result in damage and will often require extensive work by a qualified technician to restore the set to normal operation.
- When the set exhibits a distinct change in performance, it indicates a need for service.

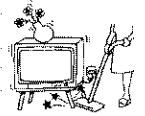
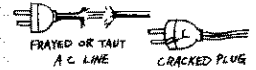

Servicing

Do not attempt to service the set yourself since opening the cabinet may expose you to dangerous voltage or other hazards. Refer all servicing to qualified service personnel.



Replacement Parts

When replacement parts are required, be sure the service technician certifies in writing that he has used replacement parts specified by the manufacturer that have the same characteristics as the original parts.

Unauthorized substitutions may result in fire, electric shock or other hazards.

Safety Check

Upon completion of any service or repairs to the set, ask the service technician to perform routine safety checks (as specified by the manufacturer) to determine that the set is in safe operating condition, and to so certify. When the set reaches the end of its useful life, improper disposal could result in a picture tube implosion. Ask a qualified service technician to dispose of the set.



Contents

Introducing the FD Trinitron Wega

Overview	1
Presenting the FD Trinitron Wega.....	2
Using the Remote Control	3

Installing the TV

Overview	7
TV Controls and Connectors.....	8
Connecting a Cable or Antenna.....	10
Connecting a VCR and Cable.....	14
Connecting a VCR and Cable Box	15
Connecting Two VCRs for Tape Editing	17
Connecting a Satellite Receiver	18
Connecting a Satellite Receiver with a VCR ..	19
Connecting an Audio Receiver	21
Connecting a DVD Player with Component Video Connectors.....	22
Connecting a DVD Player with A/V Connectors.....	23
Connecting a Camcorder	24
Using the CONTROL S Feature	25
Setting Up the TV Automatically	26

Using the Features

Overview	27
Using Favorite Channels.....	28
Using Picture in Picture (PIP)	29
Using Wireless Headphones	32

Using the Menus

Overview	35
Using the Video Menu	36
Using the Audio Menu	38
Using the Channel Menu	40
Using the Parent Menu	42
Using the Timer Menu	45
Using the Setup Menu.....	47
Using the Basic Menu.....	49

Other Information

Overview.....	51
Troubleshooting.....	57
Specifications.....	59
Index	61

Introducing the FD Trinitron Wega

Overview

This chapter defines the contents of your Wega TV and provides an overview of how to set up and use basic features.

<i>Topic</i>	<i>Page</i>
Presenting the FD Trinitron Wega	2
Contents	3
Using the Remote Control	3

Presenting the FD Trinitron Wega

The FD Trinitron Wega (pronounced VAY-GAH) is characterized by outstanding contrast, uncompromising accuracy, and corner-to-corner detail.

You'll recognize the superiority of Wega technology almost immediately. The first thing you'll notice is minimal glare from the flat picture tube. This flat-screen technology improves picture detail without distortion, unlike conventional curved screens. The FD Trinitron delivers outstanding image detail not only at the screen center, but also at the corners — so you can enjoy a bright, clear picture from any location in a room.

Features

Some of the features that you will enjoy with your new TV include:

- ❑ **16:9 Enhancement:** Vertical Compression technology that maximizes picture resolution on “anamorphic” or “enhanced for widescreen” sources, including selected DVDs.
- ❑ **Velocity Modulation:** Vertical line enhancement that sharpens picture definition.
- ❑ **Steady Sound:** Equalizes volume levels so there is consistent output between programs and commercials.
- ❑ **Parental Control:** V-Chip technology allows parents to block unsuitable programming for younger viewers.
- ❑ **Component Video Inputs:** Offers the best video quality for DVD player connections.
- ❑ **S-VIDEO Inputs:** Provides a high-quality image for connected equipment.
- ❑ **Dual Tuner Picture in Picture (PIP):** Allows you to watch two programs at once (except model KV-36FS12).
- ❑ **Favorite Channel Preview:** Preview up to eight favorite channels without leaving the current channel (except model KV-36FS12).
- ❑ **Wireless Infrared Headphones:** Enjoy listening to programs without disturbing anyone else (models KV-32FV26, 36FV26 only).

Contents

Your box contains your new Trinitron TV, a remote control and two AA batteries. No peripheral cables are included with this TV. Please check the hookup instructions for your desired setup before you begin. You may need to purchase cables and/or splitters to complete the hookup properly.

Models KV-32FV26 and 36FV26 also contain wireless headphones and one additional AA battery.

Using the Remote Control

Inserting Batteries

Insert two size AA (R6) batteries (supplied) by matching the + and - on the batteries to the diagram inside the battery compartment.

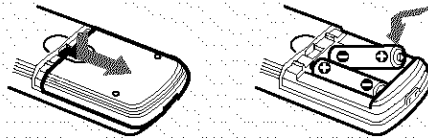

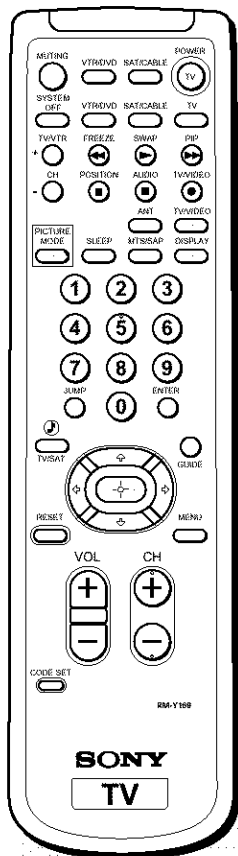

⚠ Remove the batteries to avoid damage from possible battery leakage whenever you anticipate that the remote control will not be used for an extended period. Handle the remote control with care. Avoid dropping it, getting it wet, or placing it in direct sunlight, near a heater, or where the humidity is high.

Button Descriptions





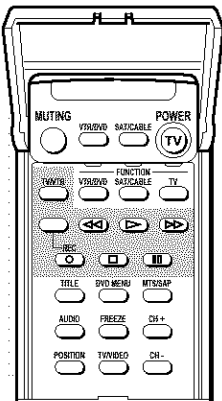
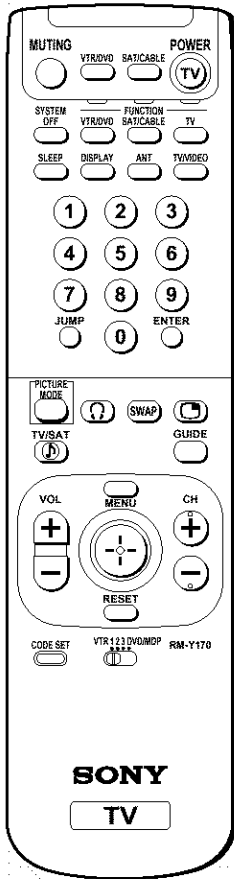

Model	Remote
KV-36FS16	RM-Y169
KV-32FV16 and 36FV16	RM-Y171
KV-36FS12	RM-Y168
KV-32FV26 and 36FV26	RM-Y170

 Yellow Picture-in-Picture buttons (highlighted above right) are not available on the RM-Y168 remote (model KV-36FS12). Buttons with asterisks (*) in the list are located on the inside panel of the RM-Y170 remote (models KV-32FV26 and 36FV26).

Button	Description
MUTING	Mutes the sound. Press again or press VOL + to restore the sound.
POWER buttons (GREEN)	Turn on and off the TV and other audio/video equipment.
SYSTEM OFF	Powers off all Sony equipment at once. (This feature may not work with older Sony equipment.)
FUNCTION buttons (WHITE or BLACK)	Select the equipment (TV, VCR/DVD, SAT/CABLE) that you want to operate. The indicator lights up momentarily when pressed to show which device the remote control is operating.
* TV/VTR	Changes the VHF/UHF output of the VCR.
* FREEZE	Freezes the window picture. Press again to restore the picture.
SWAP	Switches the position of the main picture with the window picture.
PIP or 	Turns on/off PIP. For details, see "Using Picture in Picture (PIP)" on page 29.
* CH+/-	Changes the channel in the window picture.
* POSITION	Moves the location of the window picture.
* AUDIO	Alternates sound between the main picture and the window picture.
* PIP TV/VIDEO	In the window picture, cycles through the video equipment connected to your TV's video inputs: TV, VIDEO 1, VIDEO 2, VIDEO 3, VIDEO 4.
* TV/VIDEO	Cycles through the video equipment connected to your TV's video inputs.
* DVD MENU	Displays the DVD menu.
* TITLE	Displays the DVD's Title menu.
ANT	Changes the VHF/UHF input to the AUX input.
PICTURE MODE	Cycles through the available video picture modes: Vivid, Standard, Movie, Sports. Also available in the Video menu. For details, see "Selecting Video Options" on page 36.
SLEEP	Press repeatedly until the TV displays the time in minutes (15, 30, 45, 60, or 90) that you want the TV to remain on before shutting off automatically. Cancel by pressing until SLEEP OFF appears.

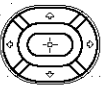

Button	Description
* MTS/SAP	Cycles through the Multi-channel TV Sound (MTS) options: Stereo, Auto-SAP (Second Audio Program), and Mono. For details, see "Using the Audio Menu" on page 38.
DISPLAY	Press once to display the current time and channel label (if set) and channel number. Press again to turn Display off. For details on setting the time, see "To set the Current Time" on page 45.
JUMP	Press to jump back and forth between two channels. The TV alternates between the current channel and the last channel that was selected.
TV/SAT	Switches between the TV and SAT (satellite) inputs when in SAT FUNCTION mode.
GUIDE	Displays the program guide of your satellite antenna.
	(Models KV-32FV26, 36FV26 only.) Turns on/off the headphones. For details, see "Using Wireless Headphones" on page 32.
	Provides quick access to for changing available audio settings. For details, see "Selecting Audio Options" on page 38.
RESET	Press when in a menu to reset the settings to the factory defaults.
MENU	Press to display the TV menu. Press again to exit from the menus.
	Joystick (models KV-32FV26, 36FV26 only). Allows for movement of the on-screen cursor. Pressing down on the center of the joystick selects the item.
	Arrows and Select (all models except KV-32FV26 and 36FV26). Pressing down on the center button selects the item.
CODE SET	Used for programming the remote control to operate non-Sony video equipment. For details, see "Programming the Remote Control" on page 52.
VTR 123 DVD/MDP 	(Models KV-32FV26, 36FV26 only). Use to switch control for connected video equipment. You can program one video source for each switch position. For details, see "Programming the Remote Control" on page 52).

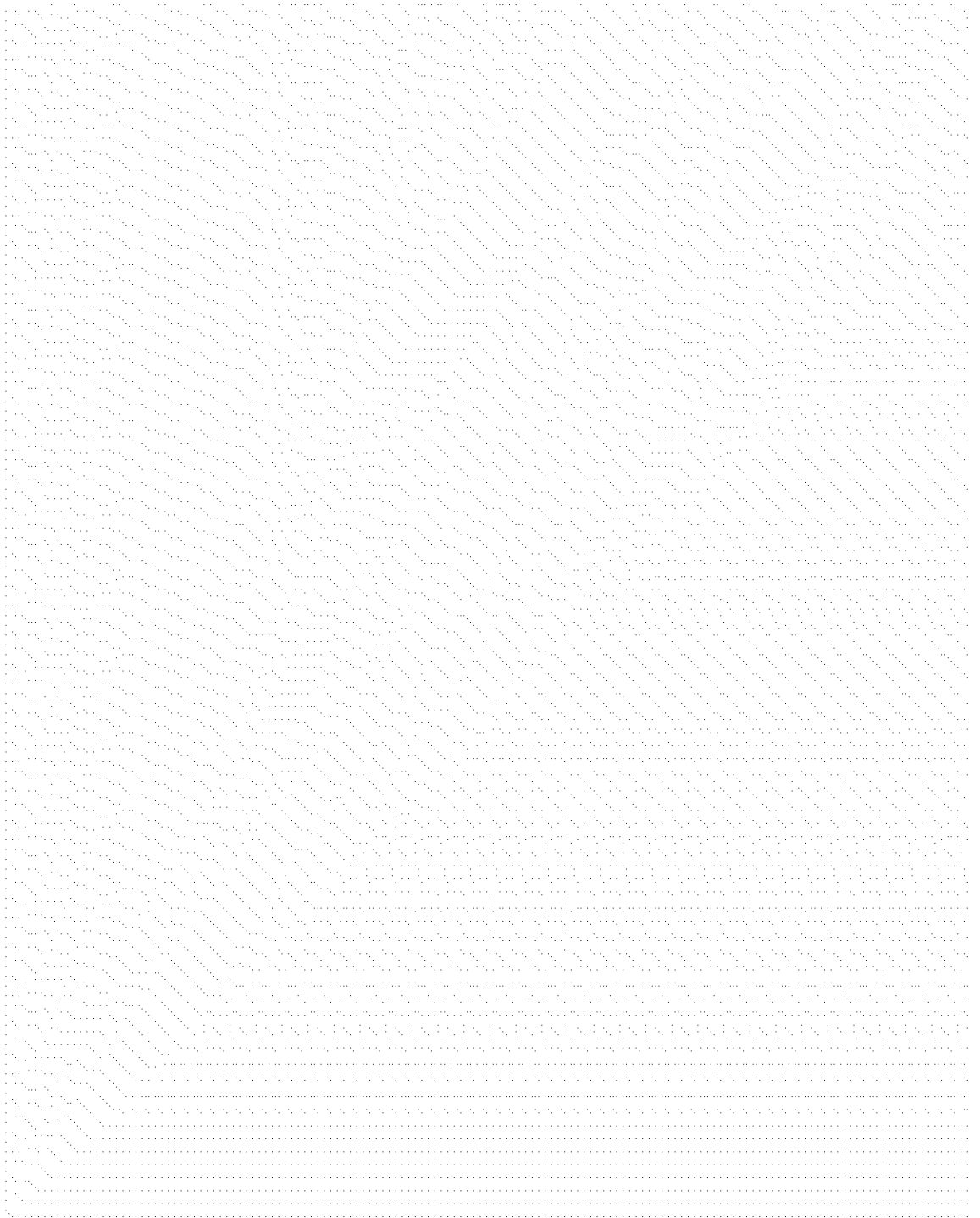

Installing the TV

Overview

This chapter includes illustrated instructions for setting up your TV.

<i>Topic</i>	<i>Page</i>
TV Controls and Connectors	8
Basic Connection (cable TV, antenna or cable box)	10
Connecting a VCR and Cable	14
Connecting a VCR and Cable Box	15
Connecting Two VCRs for Tape Editing	17
Connecting a Satellite Receiver	18
Connecting a Satellite Receiver with a VCR	19
Connecting an Audio Receiver	21
Connecting a DVD Player with Component Video Connectors	22
Connecting a DVD Player with A/V Connectors	23
Connecting a Camcorder	24
Using the CONTROL S Feature	25
Setting Up the TV Automatically	26

Note About the AC Power Cord

The AC power cord is attached to the rear of the TV with hooks. Use caution when removing the AC plug from its holder. Gently slide the cord in the upward direction without removing the cord from the two lower hooks.

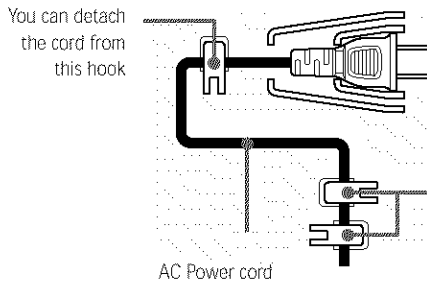

Do not remove the cord from the hook(s). (The KV-36FS12, 36FS16, 36FV16 and 36FV26 models have only one, larger hook.)

TV Controls and Connectors

Front Panel Menu Controls

The front panel menu controls allow access to the on-screen menus without the use of a remote control. Pressing the MENU button brings up the on-screen menus. The arrow buttons (▲▼) move the on-screen cursor in the menus and the (↵) button selects the menu item.

TV Rear Panel

Model KV-36FS12

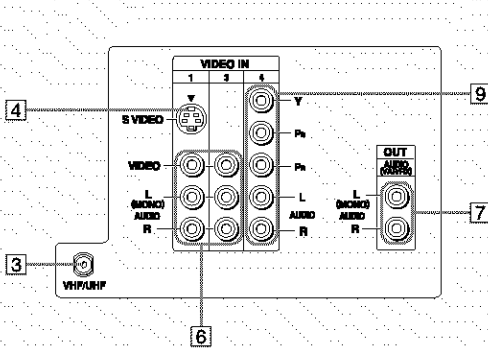

Model KV-36FS16

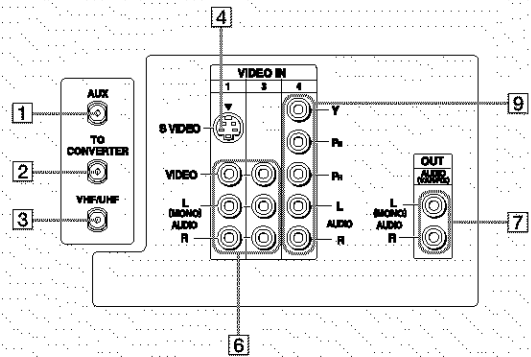

Models KV-32FV16, 32FV26, 36FV16 and 36FV26

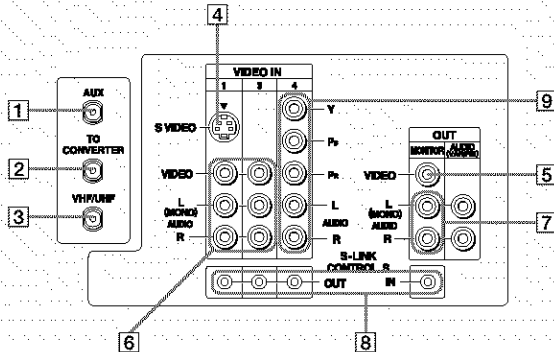

Back Panel Descriptions

<i>Connection</i>	<i>Description</i>
1 AUX (except KV-36FS12)	Allows you to view local and cable channels if your cable provider does not feature local channels. You can switch between local and cable channels easily by pressing ANT on the remote control. Devices connected to the AUX input cannot be viewed in PIP.
2 TO CONVERTER (except KV-36FS12)	This is a VHF/UHF out jack that lets you set up your TV to switch between scrambled channels (through a cable box) and normal cable channels (CATV). Use this jack instead of a splitter to get better picture quality when needing to switch between scrambled and unscrambled cable channels.
3 VHF/UHF	Connects to your VHF/UHF antenna or cable.
4 S VIDEO	Connects to the S VIDEO OUT jack of your VCR or other S VIDEO-equipped video component. Provides better picture quality than the VHF/UHF jacks or the Video IN jack.
5 MONITOR OUT (except models KV-36FS12 and 36FS16)	Lets you record the program you are watching to a VCR. When two VCRs are connected (see page 17), you can use your TV as a monitor for tape-to-tape editing.
6 AUDIO (L/R)/ VIDEO	Connects to the audio and video OUT jacks on your VCR or other video component. A third video input (VIDEO 2) is located on the front panel of the TV. The Audio and Video IN jacks provide better picture quality than the VHF/UHF jack.
7 AUDIO OUT (VAR/FIX) L (MONO)/R	Connects to the left and right audio inputs of your audio or video component. You can use these outputs to listen to your TV's audio through your stereo system.
8 S-LINK CONTROL S IN/OUT (except models KV-36FS12 and 36FS16)	Allows the TV to receive (IN) and send (OUT) remote control signals to other Sony infrared-controlled audio or video components.
9 Y, PB, PR, L, R	Connects to your DVD player's or Digital Set-top box's component video (Y, PB, PR) and audio (L/R) jacks.

Connecting a Cable or Antenna

Connecting Directly to Cable or an Antenna

The connection you choose depends on the cable found in your home. Newer homes are equipped with standard coaxial cable (see **A**); older homes probably have 300-ohm, twin-lead cable (see **B**); other homes may contain both (see **C**).

A VHF Only or VHF/UHF or Cable

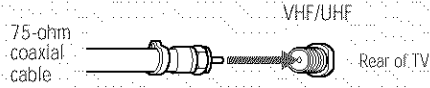

B VHF Only or UHF Only or VHF/UHF

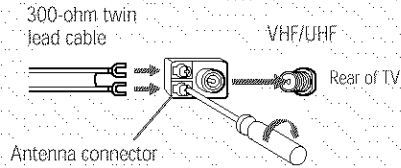

C VHF and UHF

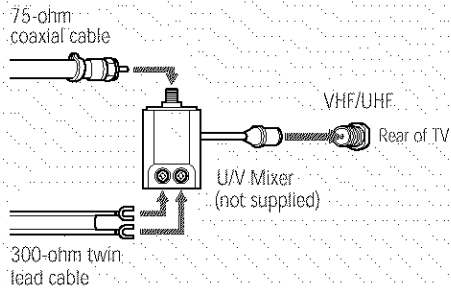

Cable and Antenna

If your cable provider does not feature local channels, you may find this set up convenient.

 This connection applies to all models except KV-36FS12.

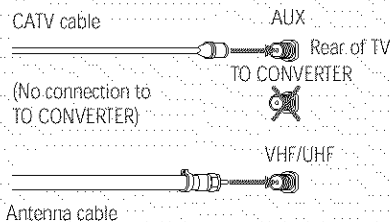

Select **CABLE** or **antenna (ANT)** mode by pressing **ANT** on the remote control.

 To receive channels with an antenna, you need to turn your Cable to OFF (see page 40) and perform the Auto Program function (see page 41).

Basic Cable Box Connections

Cable Box and Cable

This is the preferred basic cable TV hookup to use if:

- Your cable TV company scrambles some channels, but not all of them (pay channels vs. regular cable channels), and you need to use a cable box, and
- You want to enjoy the PIP feature.

 This connection applies to all models except KV-36FS12.



With this setup you can:

- Use the TV remote control to change channels using your cable box when the signal is scrambled.
- Use the TV remote control to change channels using your TV when the signal is not scrambled. (Your TV's tuner provides a better signal than the cable box.)
- Use the PIP feature. (When all channels are routed through your cable box, only one signal is sent to the TV, so you cannot use the PIP feature.)

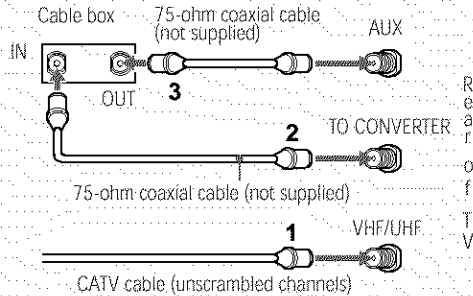
- 1 Connect the Cable TV cable to the TV's VHF/UHF jack.
- 2 Using a coaxial cable, connect the TV's TO CONVERTER jack to the cable box's IN jack. The TV's internal converter allows you to switch between unscrambled signals coming straight into the TV and scrambled signals coming in through the cable box, eliminating the need for an external splitter.
- 3 Using a coaxial cable, connect the cable box's OUT jack to the TV's AUX jack.



 Pressing ANT on the remote control switches between the channels coming in through the cable box (scrambled) and those coming directly to the TV (unscrambled).

-  Your Sony remote control can be programmed to operate your cable box (see "Programming the Remote Control" on page 52)
-  To change channels using the cable box, set your TV to channel 3 or 4. Setting the Channel Fix feature in the Channel menu (see "Using the Channel Menu" on page 40) ensures that you do not accidentally switch the channels using your TV.

Cable Box only

Use this hookup if:

- You subscribe to a cable TV system that scrambles or encodes all signals, requiring a cable box to view all channels, and
- You do not intend to hook up any other audio or video equipment to your TV.

When all channels are routed through your cable box, only one unscrambled signal is sent to the TV, so you cannot use the PIP feature. If some of your channels are scrambled, but others are not, consider using the hookup "Cable Box and Cable" on page 11 instead.

- 1** Connect the coaxial connector from your cable service to the cable box's IN jack.
- 2** Using a coaxial cable, connect the cable box's OUT jack to the TV's VHF/UHF jack.

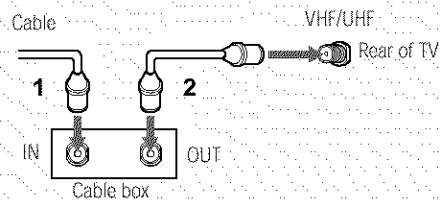

Connecting a VCR and Cable

Use this hookup if:

- You subscribe to a cable TV system that does not require a cable box.

 - 1 Connect the cable TV cable to the VCR's IN jack.
 - 2 Using a coaxial cable, connect the VCR's OUT jack to the TV's VHF/UHF jack.
 - 3 Using an A/V cable, connect the VCR's Audio and Video OUT jacks to the TV's Audio and Video IN jacks.

⚡ If your VCR has an S VIDEO jack: For best picture quality, use an S VIDEO connection instead of the yellow video cable on your combined A/V cable. Using an S VIDEO cable, connect the VCR's S VIDEO OUT jack to the TV's S VIDEO IN jack. S VIDEO does not provide audio, so audio cables must still be connected to provide sound.

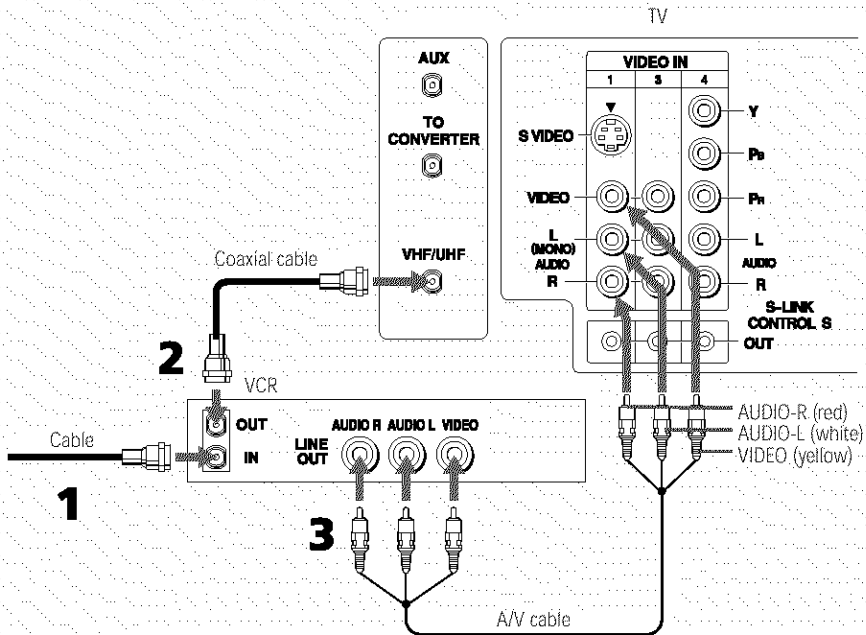

Connecting a VCR and Cable Box

Use this hookup if:

- Your cable TV company scrambles some channels, but not all of them (pay channels vs. regular cable channels) and you therefore need to use a cable box, and
- You want to enjoy the PIP feature.

 This connection applies to all models except KV-36FS12.

With this setup you can:



- Use the TV remote control to change cable box channels when the signal is scrambled.
- Use the TV remote control to change TV channels when the signal is not scrambled. (Your TV's tuner provides a better signal than the cable box.)
- Use the PIP feature. (When all channels are routed through the cable box, only one signal is sent to the TV, so you cannot use the PIP feature.)

- 1** Connect the Cable TV cable to the TV's VHF/UHF jack.
- 2** Using a coaxial cable, connect the TV's TO CONVERTER jack to the cable box's IN jack. The TV's internal converter allows you to switch between unscrambled signals coming straight into the TV and scrambled signals coming in through the cable box. This eliminates the need for an external splitter.
- 3** Using a coaxial cable, connect the cable box's OUT jack to the VCR's IN jack.
- 4** Using an A/V cable, connect the VCR's Audio and Video OUT jacks to the TV's Audio and Video IN jacks.
- 5** Using a coaxial cable, connect the VCR's OUT jack to the TV's AUX jack.

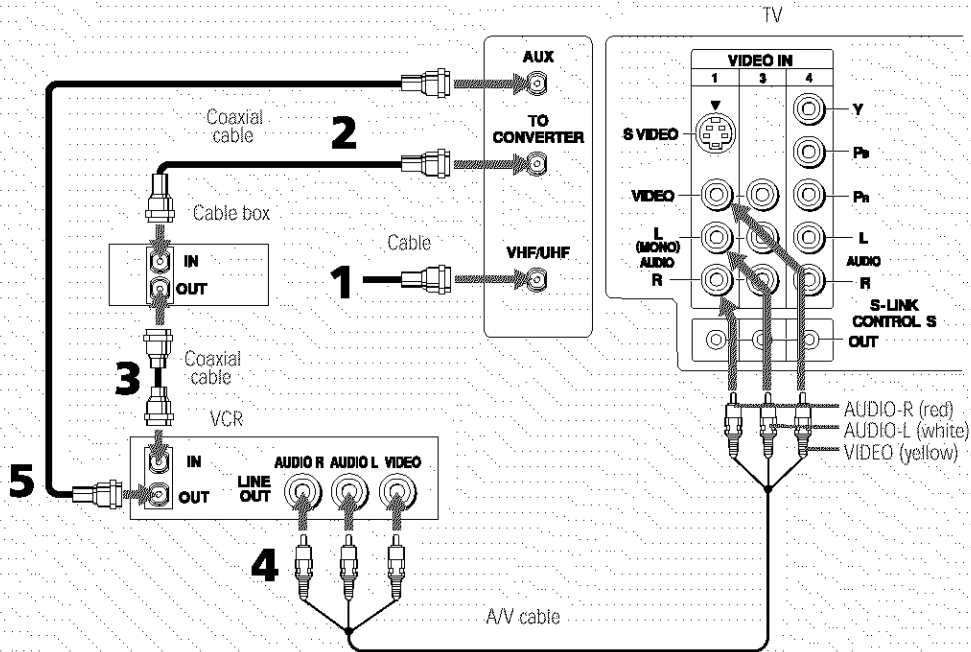
 To view scrambled channels, set your TV to AUX 3 or 4 (depending on your cable box output). Change channels using your cable box.



 Pressing the ANT button on the remote control switches between the channels coming in through the cable box (scrambled) and those coming directly to the TV (unscrambled).

-  If your VCR has an S VIDEO jack: For best picture quality, use an S VIDEO connection instead of the yellow video cable on your combined A/V cable. Using an S VIDEO cable, connect the VCR's S VIDEO OUT jack to the TV's S VIDEO IN jack. S VIDEO does not provide audio, so audio cables must still be connected to provide sound.
-  To change channels using the VCR or cable box, set your TV to channel 3 or 4. Setting the Channel Fix feature in the Channel menu (see "Using the Channel Menu" on page 40) ensures you do not accidentally switch the channels using your TV.

Connecting Two VCRs for Tape Editing

Connecting two VCRs together, then into the TV, allows you to switch between two while recording to ensure that what you are playing on one is recording on the other. Your TV acts as a monitor to view the program being recorded.

- 1 Using an A/V cable, connect the playback VCR's Audio and Video OUT jacks to the recording VCR's Audio and Video IN jacks.
- 2 Using an A/V cable, connect the recording VCR's Audio and Video OUT jacks to the TV's Audio and Video IN jacks.

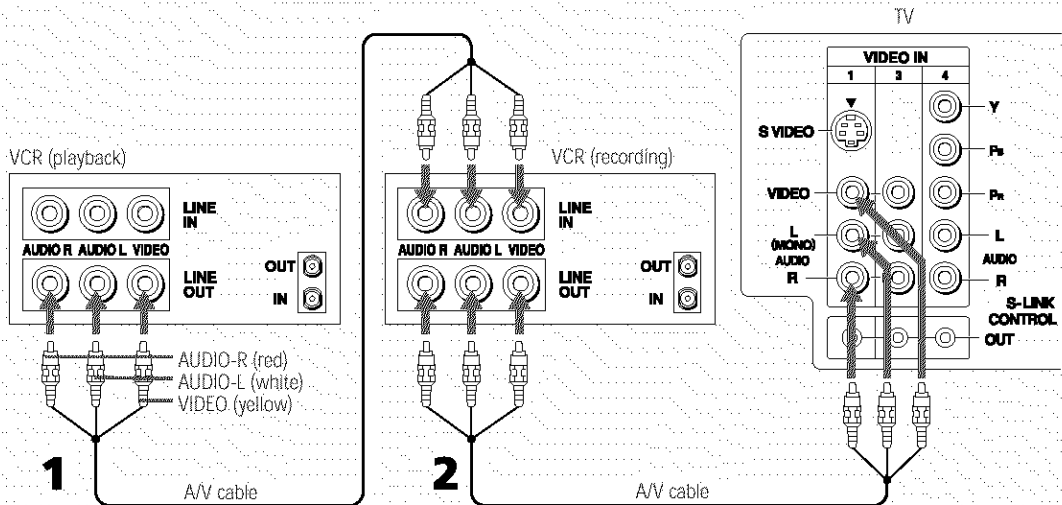

- To perform tape editing, set the TV to the video input intended for playback by pressing the TV/VIDEO button on the remote control.
- You may need to change the video input on your VCR. Consult your VCR's operating manual for instructions.
- If your VCRs has an S VIDEO jack: For best picture quality, use an S VIDEO connection instead of the yellow video cable on your combined A/V cable. Using an S VIDEO cable, connect the recording VCR's S VIDEO OUT jack to the TV's S VIDEO IN jack. S VIDEO does not provide audio, so audio cables must still be connected to provide sound.

Connecting a Satellite Receiver

- 1 Connect the satellite antenna cable to the satellite receiver's SATELLITE IN jack.
- 2 Using an A/V cable, connect the satellite receiver's Audio and Video OUT jacks to the TV's Audio and Video IN jacks.
- 3 Connect a coaxial cable from your cable or antenna to the TV's VHF/UHF jack.

⚠ If your satellite receiver has an S VIDEO jack: For best picture quality, use an S VIDEO connection instead of the yellow video cable on your combined A/V cable. Using an S VIDEO cable, connect the satellite receiver's S VIDEO OUT jack to the TV's S VIDEO IN jack. S VIDEO does not provide audio, so audio cables must still be connected to provide sound.

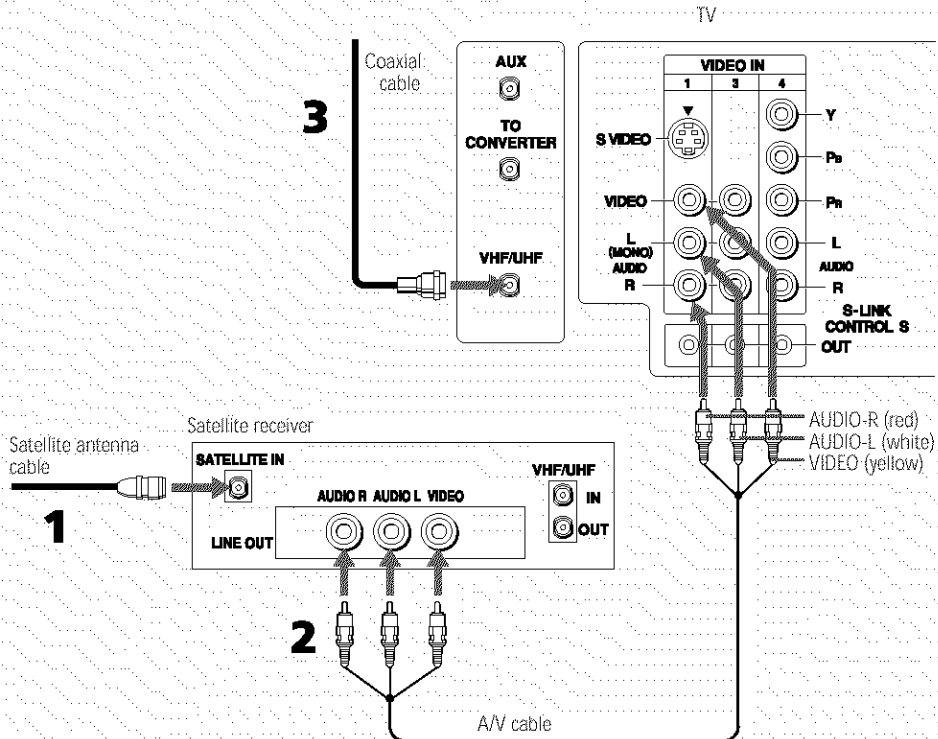

Connecting a Satellite Receiver with a VCR

- 1 Connect the satellite antenna cable to the satellite receiver's SATELLITE IN jack.
- 2 Connect the CATV cable to the VCR's VHF/UHF IN jack.
- 3 Using a coaxial cable, connect the VCR's OUT jack to the TV's VHF/UHF jack.
- 4 Using an A/V cable, connect the satellite receiver's Audio and Video OUT jacks to the VCR's Audio and Video IN jacks.
- 5 Using an A/V cable, connect the VCR's Audio and Video OUT jacks to the TV's Audio and Video IN jacks.

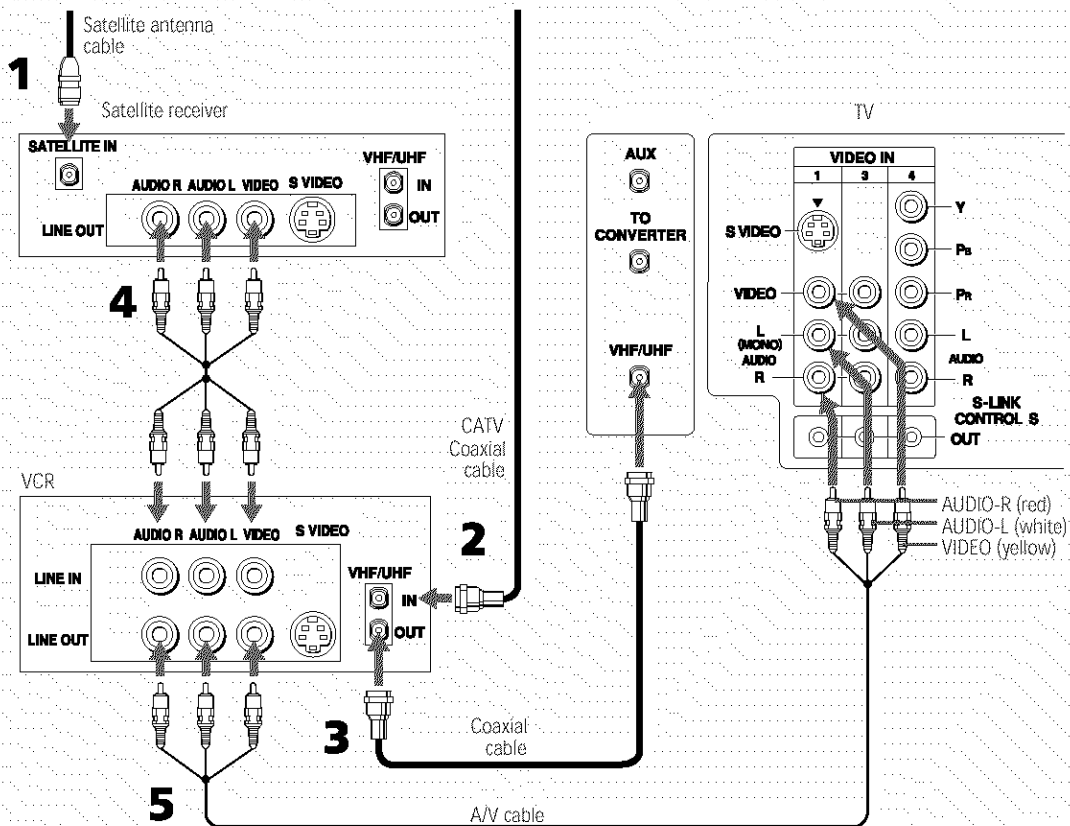

- ⚡ Be sure your VCR's video input is set correctly. Consult your VCR's operating manual for instructions.
- ⚡ Use the TV/VIDEO button to select
 - VIDEO 1 to watch satellite TV or the VCR (your VCR must be on).
 - VHF/UHF to watch cable TV.
- ⚡ If your VCR has an S VIDEO jack: For best picture quality, use an S VIDEO connection instead of the yellow video cable on your combined A/V cable. Using an S VIDEO cable, connect the VCR's S VIDEO OUT jack to the TV's S VIDEO IN jack. S VIDEO does not provide audio, so audio cables must still be connected to provide sound.

Connecting an Audio Receiver

- Using audio cables, connect the TV's Audio OUT jacks to the audio receiver's Audio LINE IN jacks.

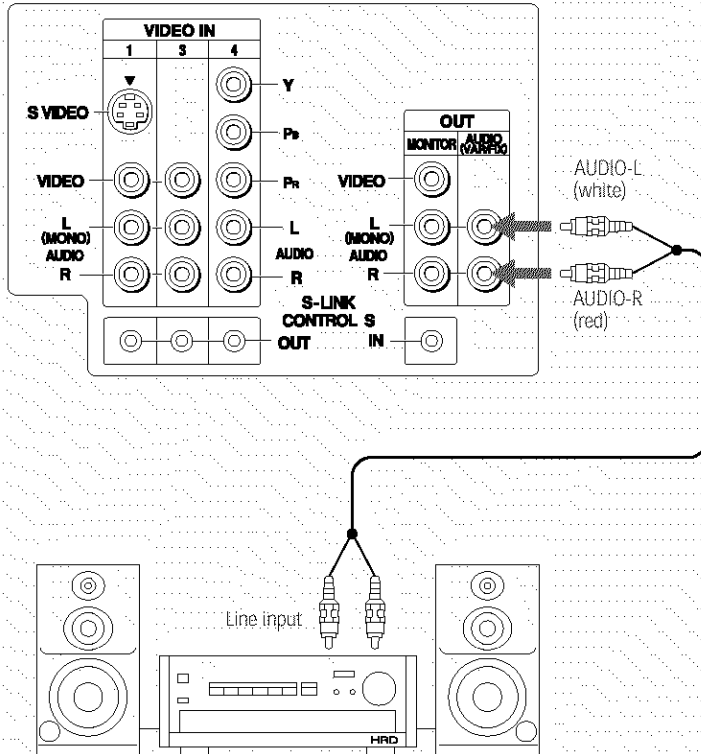

Connecting a DVD Player with Component Video Connectors

This is the preferred hookup to use if:

- Your DVD player has component video (Y, P_B, P_R) jacks.

1 Using three separate component video cables, connect the DVD player's Y, P_B and P_R jacks to the Y, P_B and P_R jacks on the TV. Use the VIDEO 4 connections.

⚠ The Y, P_B and P_R jacks on your DVD player are sometimes labeled Y, C_B and C_R, or Y, B-Y and R-Y. If so, connect the cables to like colors.

2 Using an audio cable, connect the DVD player's Audio OUT jacks to the TV's Audio IN jacks. Be sure to use the same row of inputs that you used for the video connection (VIDEO 4).

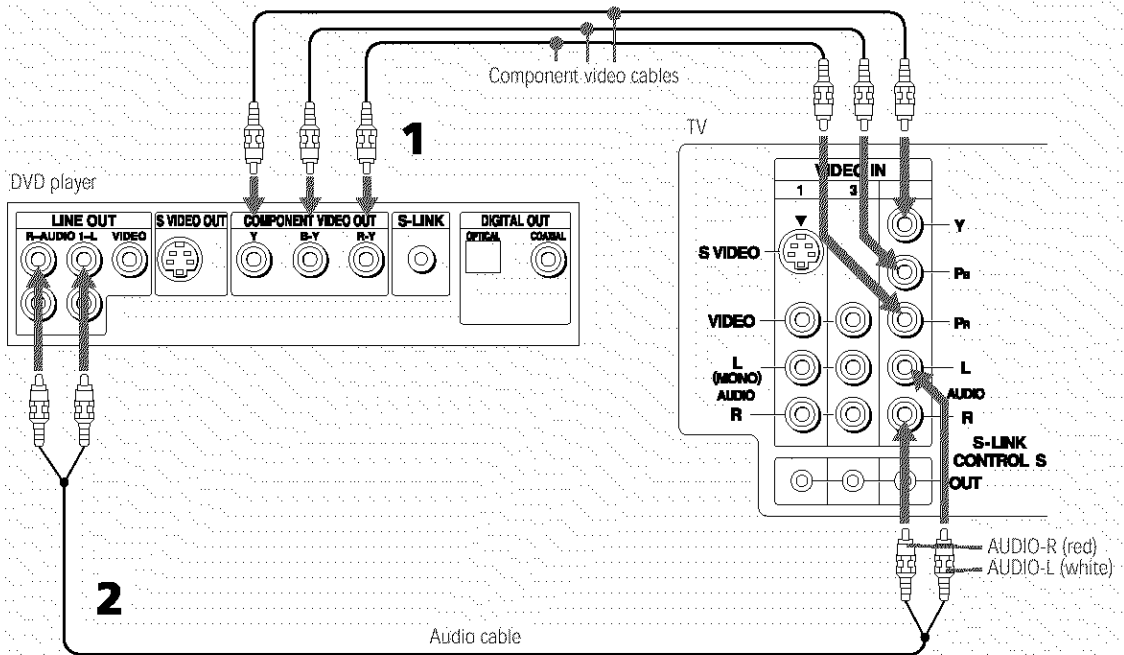

⚠ You cannot record the signal from any equipment connected into the Y, P_B, P_R connections.

Connecting a DVD Player with A/V Connectors

Use this hookup if:

- Your DVD player does not have component video (Y, Pb, Pr) jacks.

 If your DVD player has video component output connectors: for best picture quality use the connection described on page 22.

- 1 Using audio cables, connect the DVD player's Audio OUT jacks to the TV's Audio IN jacks.
- 2 Using an S VIDEO cable, connect the DVD player's S VIDEO jack to the TV's S VIDEO jack.

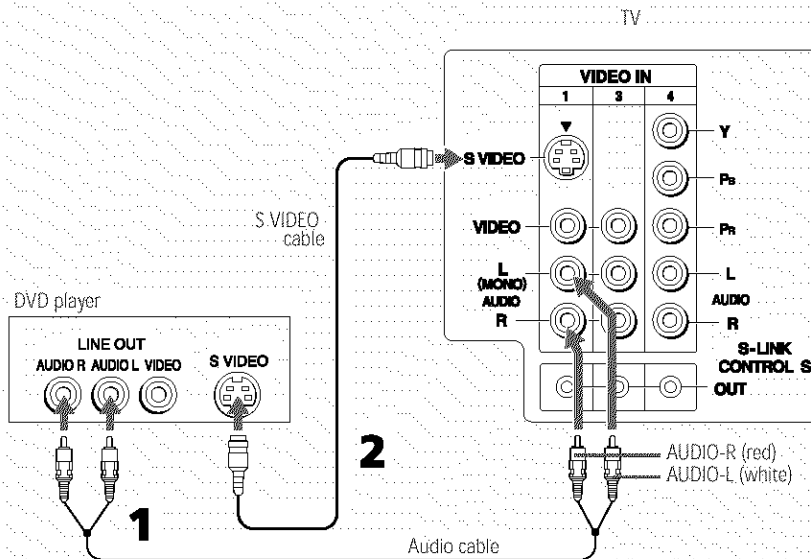

 Use the TV/VIDEO button on the remote control to switch between the VCR, DVD player and cable TV inputs.

Connecting a Camcorder

For easy connection of the camcorder, the TV has front Audio and Video inputs (shown below). However, if you prefer, you can also connect the camcorder to the TV's rear Audio and Video IN jacks.

- 1 Using A/V cables, connect the camcorder's Audio and Video OUT jacks to the TV's Audio and Video IN jacks.

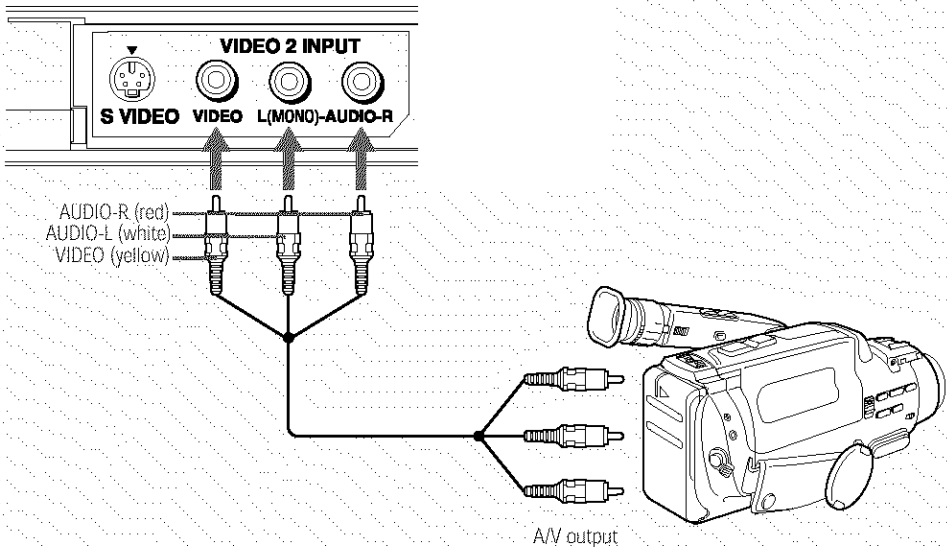

If you have a mono camcorder, connect its left audio output to the TV's AUDIO L jack.

If your camcorder has an S VIDEO jack: For best picture quality, use an S VIDEO connection instead of the yellow video cable on your combined A/V cable. Using an S VIDEO cable, connect the camcorder's S VIDEO OUT jack to the TV's S VIDEO IN jack. S VIDEO does not provide audio, so audio cables must still be connected to provide sound.

Using the CONTROL S Feature

 The CONTROL S feature applies to all models except KV-36FS12 and 36FS16.

The CONTROL S feature allows you to control other equipment through your TV. Pointing the remote control at your TV, rather than at the equipment, allows you to keep other equipment hidden or out of direct line of sight.

To control your other Sony equipment with your TV's remote control, use a CONTROL S cable (not supplied) to connect the equipment's CONTROL S IN jack to the TV's CONTROL S OUT jack.

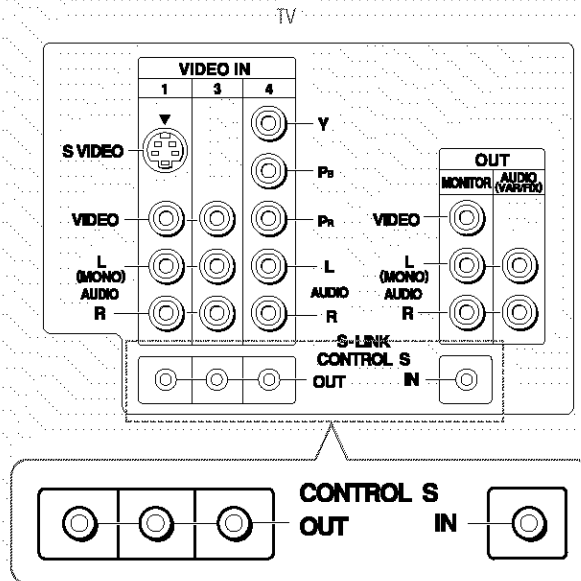

Setting Up the TV Automatically

After you finish connecting your TV, you need to run Auto Setup to set up your channels. The Auto Setup screen appears when you turn your TV on for the first time after installing it. If you do not want to set up the channels at this time, you can do it later by using the Auto Program feature in the Channel menu (see pages 40 and 41).

 The Auto Setup feature does not apply for installations that use a cable box for all channel selection.

Using Auto Setup

- 1 Press POWER to turn on the TV.
 - 2 Press the TV function button on the remote control.
 - 3 Press CH+ on the front of your TV to run the Auto Setup or press CH- to exit. If you use the channel buttons on your remote control, be sure to use the main set of buttons.
-  To reset your TV to factory settings, turn the TV on. Then, while pressing the RESET button on the remote control, press the POWER button on the TV. The TV will turn itself off, then back on.

Using the Features

Overview

This chapter describes how to use new features of your TV.

<i>Topic</i>	<i>Page</i>	<i>Applies to Models</i>
Using Favorite Channels	28	All models
Using Picture in Picture (PIP)	29	All models except KV- 36FS12
Using Wireless Headphones	32	KV-32FV26, 36FV26 only

Using Favorite Channels

The Favorite Channel feature lets you select programs from a list of favorite channels that you specify.

⚠ The Favorite Channel feature with preview is not included in model KV-36FS12.

To display a list of your favorite channels:

⚠ You must specify your favorite channels before you can display them. See the Favorite Channel description under "Selecting Channel Options" on page 40.

1 Press **+**.

⚠ You must exit all menus (by pressing the MENU button) before you can display the Favorite Channel screen.

The Favorite Channel options appear.

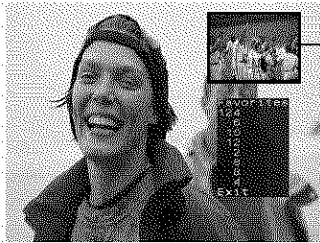

Preview window on all models
except KV-36FS12

2 Press **▲** or **▼** to highlight the channel you want to watch. The program on that channel appears in the preview window. Press **+** to select.

Using Picture in Picture (PIP)

Picture in Picture (PIP) allows you to watch two channels simultaneously — one in the large main window and another in a small window picture.

 The Picture in Picture feature is not included in model KV-36FS12.

Displaying Picture in Picture

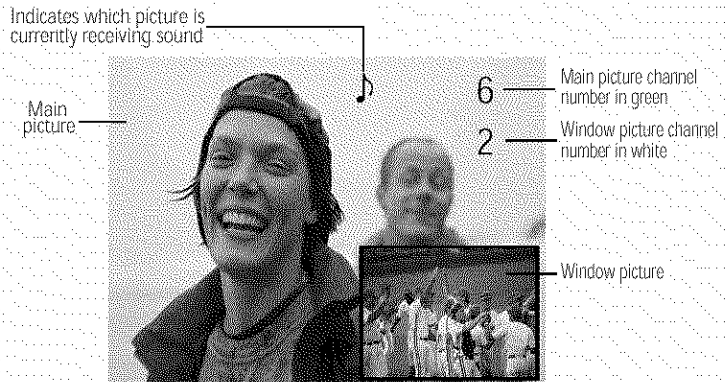

To use PIP:

- 1 Make sure your TV is tuned to a channel that you know is airing programming.
- 2 Press the  button (or the button labeled PIP). The window picture appears.
- 3 Use the yellow-labeled buttons on your remote control (see diagram) to control the PIP features (which are listed on the next page).

To check your PIP:

- 1 Tune your TV to a channel that you know is airing programming.
- 2 Press SWAP and select that same channel again. You should now have the same program playing in both your main window and your picture window.
- 3 Use the yellow CH+/- buttons to change the channel in the picture window.
- 4 Now use the main CH+/- buttons of your remote control to change the channel in the main window. If this does not work, check “Troubleshooting” on page 57 for potential solutions.

 You must press TV (FUNCTION) before you can control PIP with the yellow-labeled buttons.

The AUX input cannot be viewed in the window picture.

PIP Functions

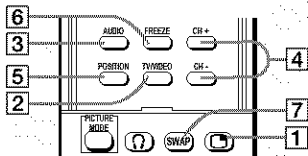

RM-Y170 remote control

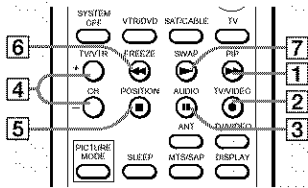

RM-Y169 and RM-Y171 remote controls

Yellow Labeled PIP Button	Description
1  or PIP	Turns the PIP feature on and off. Press repeatedly to change the window size (1/9, 1/16, OFF).
2 * TV/VIDEO	Cycles through available video equipment you have connected to the TV.
3 * AUDIO	Alternates sound between the main picture and the window picture. The sound symbol (🔊) appears for 3 seconds, indicating whether you are hearing sound from the main picture or the window picture.
4 * CH +/-	Changes the channel in the window picture. To change the channel in the main window, use the main CH +/- buttons at the bottom of the remote control.
5 * POSITION	Moves the location of the window picture among the four corners of the screen.
6 * FREEZE	Freezes the window picture. Press again to restore the picture. The main window continues to play as usual.
7 SWAP	Switches the main picture with the window picture. Press again to change them back.

To change channels/programs in the window picture:

- Use the yellow PIP CH+/- button to scroll through the TV channels.
- Use the yellow TV/VIDEO button to cycle through your other video equipment connected to the TV, such as your VCR, DVD player or Satellite Receiver.

Setups that affect your ability to use PIP:

- Any video equipment you have connected to the AUX input cannot be viewed in the PIP window.
- If you are viewing all channels through a cable box, the PIP feature will not work. The cable box only unscrambles one signal at a time, so the window picture will be the same as the main picture.
- You can watch a cable channel and another video source, to do so, connect your DVD player, VCR or Satellite receiver into the VIDEO IN 1-4 on the back of the TV, not to the AUX input.

 Be sure to label your video sources to make finding them in the Display easier. See "Video Label" on page 48 for labeling instructions.

Using Wireless Headphones

🔗 Wireless headphones are included and can only be used with models KV-32FV26 and 36FV26.

Installing the Batteries

Install the supplied size AA (R6) battery into the headphones.

- 1 Open the battery compartment lid by pressing and sliding the lid as illustrated.

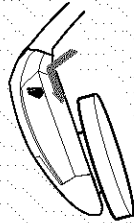

- 2 Insert the battery into the compartment with the positive side up and then close the lid.

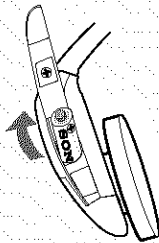

When used continuously, the battery lasts:

up to 40 hours with an alkaline battery

up to 20 hours with a manganese battery

Replace the battery with a new one when the sound becomes weak.

Using the Headphones

- 1 Press .

The  icon and channel number are displayed.



- 2 Turn on the power by placing the headphones securely on your head.

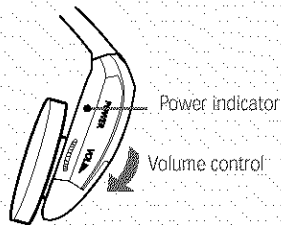

If you want to listen to the sound from only the wireless headphones, turn down the TV speaker volume, or press **MUTING** on the remote control.

- 3 To turn off the headphones, remove them from your head and press .

-  For optimal sound reception, do not cover the infrared transmitter on the TV or the infrared sensors on the headphones.

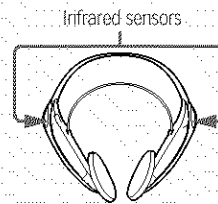
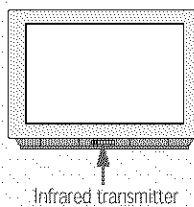

-  To help prevent possible hearing damage due to sudden or prolonged excessive volume, do not set the headphone volume too high while using them.

To prevent possible damage to the infrared transmitter in the television, press  to turn off the headphone feature when the headphones are not in use.

Listening to Sound from Main and Window Pictures

If you want to listen to the sound from the main or window picture through your headphones, select the audio source.

- 1 Press  to display a window picture.



- 2 Press .

The  icon and channel number appear for about three seconds.



Main picture audio

Press  again to switch the audio to the window picture.



Window picture audio

- 3 Press  to turn off the headphones.



Headphones off

 Exiting from PIP returns the sound to the main picture.

The audio to the headphones automatically turns off when the TV is powered off.

SAP (Second Audio Programs) are not available in the window picture.

Using the Menus

Overview

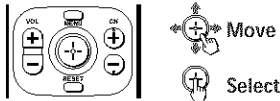

Joystick: (models KV-32FV26, 36FV26 only)

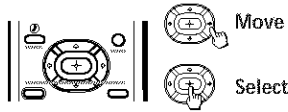

Arrow buttons:
(all other models)







To end a menu session:
Press MENU again

To end one menu session
and move to another:
Press \uparrow to return to the
menu icons.
Move the joystick to
choose the next menu icon
and press \oplus to select it.

Opening and choosing a menu:

- 1 Press MENU to display the Menu screen.
- 2 Use the joystick/arrow buttons to move to the desired menu icon. Press \oplus to select it.
- 3 Use the joystick/arrow buttons to scroll up and down through the features.
- 4 See the specific menu page for instructions on moving through the menu.

The Menu gives you access to the following features:

<i>Menu Icon</i>	<i>Description</i>	<i>Page</i>
	Allows you to make adjustments to your picture settings. It also allows you to customize the Picture Mode based on the type of program you are viewing.	36
	Offers enhanced audio options such as listening to second audio programming (SAP) or customizing the Effect of the sound on your TV.	38
	Allows you to set up a Favorite Channel list, run the Auto Program function, and more.	40
	Lets you control the viewing of programs based on their ratings.	42
	Lets you set the clock on your TV and allows you to program your TV for scheduled viewing using the Timers.	45
	Provides several options for setting up your channels, labeling your video inputs, and selecting the language of the on-screen menus.	47
	Provides quick access to frequently used settings.	49



Using the Video Menu

To select the Video Menu

- 1 Press MENU.
- 2 Use the joystick/arrow buttons to move to the Video icon and press **+**.
- 3 Use the joystick/arrow buttons to scroll up and down through the options.
- 4 Press **+** to select a feature. That feature's adjustment appears.
- 5 Use the joystick/arrow buttons to make the desired adjustments.
- 6 Press **+** to select/set.
- 7 Press MENU to exit the menu screen.



To restore the factory default settings for Picture, Brightness, Color, Hue, Sharpness, Color Temp and VM.

- Press RESET on the remote control when in the Video menu.

Selecting Video Options

To quickly and easily change from one Video Mode to another, use the PICTURE MODE button on the remote control.

The Video Menu includes the following options.

Option	Description
Mode	Vivid Select for enhanced picture contrast and sharpness.
Customized picture viewing	Standard Select for standard picture settings.
	Movie Select to display a softer picture.
	Sports Select to display a vivid, bright picture.
	Note: You can alter the Video Menu settings (Picture, Brightness, Color, etc.) for each Mode.
Picture	Adjust to increase picture contrast and deepen the color or decrease picture contrast and soften the color.
Brightness	Adjust to brighten or darken the picture.
Color	Adjust to increase or decrease color intensity.
Hue	Adjust to increase or decrease the green tones.
Sharpness	Adjust to sharpen or soften the picture.

<i>Option</i>	<i>Description</i>
Color Temp	Choose from three color temperatures:
White	Cool Select to give the white colors a blue tint.
intensity	Neutral Select to give the white colors a neutral tint.
adjustment	Warm Select to give the white colors a red tint (NTSC-Standard).
VM	Sharpens picture definition to give every object a sharp, clean
Velocity	edge. Select from High, Low, OFF.
Modulation	



Using the Audio Menu

To select the Audio Menu

- 1 Press MENU.
- 2 Use the joystick/arrow buttons to move to the Audio icon  and press \odot .
- 3 Use the joystick/arrow buttons to scroll up and down through the options.
- 4 Press \odot to select an option. That option's settings appear.
- 5 Use the joystick/arrow buttons to scroll through the settings.
- 6 Press \odot to select the desired setting.
- 7 Press MENU to exit the menu screen.





To restore the factory default settings for Treble, Bass, and Balance

- Press RESET on the remote control when in the Audio menu.

Selecting Audio Options

The Audio Menu includes the following options:

<i>Option</i>	<i>Description</i>
Treble	Adjust to decrease or increase higher-pitched sounds.
Bass	Adjust to decrease or increase lower-pitched sounds.
Balance	Adjust to emphasize left or right speaker balance.
Steady Sound	ON Select to stabilize the volume.
	OFF Select to turn off Steady Sound.

 As a shortcut to using the menus, use the  button on the remote control to cycle through available audio settings.

<i>Option</i>	<i>Description</i>	
Effect	SRS	Produces a dynamic three-dimensional sound for stereo signals (models KV-32FV16, 32FV26, 36FV16, and 36FV26 only).
	Simulated	Adds a surround-like effect to mono programs (models KV-32FV16, 32FV26, 36FV16, and 36FV26 only).
	Surround	Select for Surround sound (models KV-36FS12 and 36FS16 only).
	OFF	Normal stereo or mono reception.
MTS <i>Enjoy stereo, bilingual and mono programs</i>	Stereo	Select for stereo reception when viewing a program broadcast in stereo.
	Auto-SAP	Select to automatically switch the TV to second audio programs when a signal is received. (If no SAP signal is present, the TV remains in Stereo mode.)
	Mono	Select for mono reception. (Use to reduce noise during weak stereo broadcasts.)
Speaker	ON	Select to turn on the TV speakers.
	OFF	Select to turn off the TV speakers and listen to the TV's sound only through your external audio system speakers.
Audio Out <i>Easy control of volume adjustments</i>	This option can be set only when the Speaker option is set to OFF.	
	Variable	The TV's speakers are turned off, but the volume output from your audio system can still be controlled by the TV's remote control.
	Fixed	The TV's speakers are turned off and the volume output of the TV is fixed. Use your audio receiver's remote control to adjust the volume through your audio system.



Using the Channel Menu

To select the Channel Menu



- 1 Press MENU.
- 2 Use the joystick/arrow buttons to move to the Channel icon  and press \odot .
- 3 Use the joystick/arrow buttons to scroll up and down through the options.
- 4 Press \odot to select a feature. That feature's options appear.
- 5 Use the joystick/arrow buttons to scroll through the options.
- 6 Press \odot to select the desired option.
- 7 Press MENU to exit the menu screen.



Selecting Channel Options

The Channel Menu includes the following options:

Option	Description
Favorite Channel	1 Press \leftarrow to select a favorite channel number.
	2 Use the joystick/arrow buttons to scroll through the channels until you find the channel you want to add to your favorites.
	3 Press \leftarrow to select it.
Cable	ON Select if you are receiving cable channels with a CATV cable.
	OFF Select if you are using an antenna.
 You should run Auto Program after changing the Cable setting.	

<i>Option</i>	<i>Description</i>
Channel Fix <i>Useful when you have a cable box or satellite receiver connected</i>	2-6 "Fix" your TV's channel setting to 3 or 4 and use the cable box or Satellite receiver to change channels. Select one of these settings if you have connected the device to the VHF/UHF jack. AUX 2-6 Same as 2-6, except you select one of these settings if you have connected the device to the AUX jack (see page 9). VIDEO 1 Use this setting if you have connected the device to the Audio and Video IN jacks.
Auto Program	Automatically programs the TV for all receivable channels.
Channel Skip/Add	Removes and adds viewable channels. 1 Use the joystick/arrow buttons to scroll through the channels until you find the channel you want to skip/add. 2 Press  to select it. 3 Press the joystick/arrow buttons to toggle between "Add" or "Skip." 4 Press  to select.
Channel Label	Label up to 40 channels with their station call letters.



 Channels that you set to be skipped can be accessed only with the 0-9 buttons.



Using the Parent Menu

The Parent menu allows you to set up the TV to block programs according to their content and rating levels.

To select the Parent Menu

- 1 Press MENU.
- 2 Use the joystick/arrow buttons to move to the Parent icon  and press .
- 3 Use the 0-9 buttons on the remote control to enter your four-digit password.
- 4 Confirm your password by entering it again. The Parent menu options appear.
- 5 Use the joystick/arrow buttons to scroll through the settings.
- 6 Press  to select the desired setting.
- 7 Press MENU to exit the menu screen.



 You need this password for any future access into the Parent menu. If you lose your password, see "Lost password" on page 58.

Using the Parent Menu

 If you are not familiar with the Parental Guideline rating system, you should select Child, Youth, or Young Adult to help simplify the rating selection. To set more restrictive ratings, select Custom.

 For descriptions of Child, Youth, and Young Adult ratings, see page 43.

The Parent menu includes the following options.

Option	Description	
Parental Lock	OFF	Parental lock is off. No programs are blocked from viewing.
Turn ratings on/off and select a rating system	Child	Maximum ratings permitted are: <input type="checkbox"/> US: TV-Y, TV-G, G <input type="checkbox"/> Canada: C, G
	Youth	Maximum ratings permitted are: <input type="checkbox"/> US: TV-PG, PG <input type="checkbox"/> Canada: 8 ans+
	Young Adult	Maximum ratings permitted are: <input type="checkbox"/> US: TV-14, PG-13 <input type="checkbox"/> Canada: 14+, 13 ans+
	Custom	Select to set ratings manually. <input type="checkbox"/> US: See page 43 for details. <input type="checkbox"/> Canada: See page 44 for details.
Change Password	For changing your password.	

US Models: Selecting Custom Rating Options

 The content ratings will increase depending on the level of the age-based rating. For example, a program with a TV-PG V (Violence) rating may contain moderate violence, while a TV-14 V (Violence) rating may contain more intense violence.

 To ensure maximum blocking capability, the age-based ratings should be blocked.

 If you choose to block unrated TV programs, please be aware that the following programs may be blocked: emergency broadcasts, political programs, sports, news, public service announcements, religious programs and weather.

For US models, the Custom Rating Menu includes the following options. For Canadian models, see page 44.

<i>Option</i>	<i>Description</i>
Movie Rating	G All children and General Audience.
	PG Parental Guidance suggested.
	PG-13 Parental Guidance for children under 13.
	R Restricted viewing, parental guidance is suggested for children under 17.
	NC-17 and X No one 17 or under allowed.
TV Rating	Age-Based Options
<i>Block programs by their rating, content or both</i>	TV-Y All children.
	TV-Y7 Directed to older children.
	TV-G General Audience.
	TV-PG Parental Guidance suggested.
	TV-14 Parents Strongly cautioned.
TV-MA Mature Audience only.	
	Content-Based Options
	FV Fantasy Violence.
	D Suggestive Dialogue.
	L Strong Language.
	S Sexual situations.
	V Violence.
Unrated <i>Block programs or movies that are broadcast without a rating</i>	Block Blocks all programs and movies that are broadcast without a rating.
	Allow Allows programs and movies that are broadcast without a rating.

**Canadian Models:
Selecting Custom
Rating Options**

For Canadian models, the Custom Rating Menu includes the following options. For US models, see page 43.

<i>Option</i>	<i>Description</i>	
English Rating	C	All children.
	C8	Children 8 years and older.
	G	General programming.
	PG	Parental Guidance.
	14+	Viewers 14 and older.
	18+	Adult programming.
French Rating	G	General programming.
	8 ans+	Not recommended for young children.
	13 ans+	Not recommended for ages under 13.
	16 ans+	Not recommended for ages under 16.
	18 ans+	Programming restricted to adults.
USA Rating	See "TV Rating" on page 43 for details.	

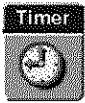

**Viewing Blocked
Programs**

You can view a blocked program by entering the password. Press the ENTER button when tuned to a blocked program, then enter the password. This temporarily switches off the Parental Lock. To reactivate the Parental Lock settings, turn off the TV. When the TV is turned on again, your Parental Controls settings are reactivated.





Using the Timer Menu

To select the Timer Menu

- 1 Press MENU.
- 2 Use the joystick/arrow buttons to move to the Timer icon  and press .





To set the Current Time

- 1 Use the joystick/arrow buttons to select “Current Time”, then press .
- 2 If it is currently Daylight Savings Time, be sure to set the mode to “ON” first. (Daylight Savings Time occurs in the Spring.)
- 3 Use the joystick/arrow buttons to enter the correct time, then press .
- 4 Press MENU to exit the menu screen.

To set the Timer

Before setting the timer, be sure to set your TV's clock to the current time and Daylight Savings Mode.

- 1 Use the joystick/arrow buttons to move to “Timer 1” or “Timer 2”, then press .
- 2 Use the joystick/arrow buttons to enter your date, time and channel preferences, then press  to select each one.
- 3 Press MENU to exit the menu screen.

To reset the Clock or Timers

- Press RESET on the remote control, when in the menu, to reset to the factory defaults.

Selecting Timer Options

The Timer Menu includes the following options:

<i>Option</i>	<i>Description</i>
Timer 1	Program
Timer 2	OFF
Current Time	Set the current time.
Daylight Savings	ON
	OFF



Using the Setup Menu

To select the Setup Menu



- 1 Press MENU.
- 2 Use the joystick/arrow buttons to move to the Setup icon  and press \ominus .
- 3 Use the joystick/arrow buttons to scroll through the features.
- 4 Press \ominus to select a feature. That feature's options appear.
- 5 Use the joystick/arrow buttons to scroll through the options.
- 6 Press \ominus to select the desired option.
- 7 Press MENU to exit the menu screen.



Selecting Setup Options

The Setup Menu includes the following options:

<i>Option</i>	<i>Description</i>
Caption Vision	Allows you to select from three closed caption modes (for programs that are broadcast with closed caption).
CC1, CC2, CC3, CC4	Displays a printed version of the dialog or sound effects of a program. (Should be set to CC1 for most programs.)
TEXT1, TEXT2, TEXT3, TEXT4	Displays network/station information presented using either half or the whole screen (if available). For closed captioning, set to CC1.
XDS (Extended Data Service)	Displays a network name, program name, program length, and time of the show if the broadcaster offers this service.
OFF	Turns off Caption Vision.





Option	Description
Video Label	Allows you to label the audio/video components you connected to the TV so you can identify them when using the TV/VIDEO button. When in the Setup menu's Video Label feature, use the joystick/arrow buttons to highlight an input to label, then press  to select it. Use the joystick/arrow buttons to scroll through the labels. Press  to select the component you connected to each of the input jacks on the back of your TV. Select "Skip" if you do not have a component connected to a particular set of input jacks.
VIDEO 1/2/3	Choose VHS, 8mm, Beta, LD, Game, SAT, DVD, Web, Receiver, DTV, Skip
VIDEO 4	Choose DVD, DTV, Skip
	If you select "Skip", your TV skips this connection when you press the TV/VIDEO button.
Tilt Correction	Allows you to correct any tilt of the picture.
Language	Select to display all on-screen menus in your language of choice.
16:9 Enhanced	Provides enhanced picture resolution for widescreen sources, such as selected DVD titles (only available when the TV is in VIDEO mode). Press TV/VIDEO and select from one of the following options:
AUTO	To activate automatically when a 16:9 signal is received (models KV-32FV26 and 36FV26 only).
ON	To activate manually.
OFF	To turn off 16:9 (except models KV-32FV26 and KV-36FV26).
Demo	Runs a demonstration of on-screen menus.

 To use this feature with widescreen DVDs, set your DVD player to 16:9 aspect ratio.





Using the Basic Menu

To select the Basic Menu

- 1 Press MENU.
- 2 Use the joystick/arrow buttons to move to the Basic icon  and press .
- 3 Use the joystick/arrow buttons to scroll through the features.
- 4 Press  to select a feature. That feature's options appear.
- 5 Use the joystick/arrow buttons to scroll through the options.
- 6 Press  to select the desired option.
- 7 Press MENU to exit the menu screen.



Selecting Basic Options

 As a shortcut to using the menus, use the  button on the remote control to cycle through available audio settings.

The Basic Menu includes the following options:

<i>Option</i>	<i>Description</i>	
Picture	Adjust the picture contrast.	
Caption Vision	Displays your current advanced menu setting: (CC1-4, TEXT 1-4, or XDS) and OFF.	
Effect	SRS	Produces a dynamic three-dimensional sound for stereo signals (models KV-32FV16, 32FV26, 36FV16, and 36FV26 only).
	Simulated	Adds a surround-like effect to mono programs (models KV-32FV16, 32FV26, 36FV16, and 36FV26 only).
	Surround	Select for Surround sound (models KV-36FS12 and 36FS16 only).
	OFF	Normal stereo or mono reception.
Advanced Menu	Select to return to the advanced menus.	

Other Information

Overview

This chapter includes the following topics:

<i>Topic</i>	<i>Page</i>
Programming the Remote Control	52
Operating Other Components with Your TV Remote Control	54
Troubleshooting	57
Specifications	59
Index	61

Programming the Remote Control

The remote control is preset to operate Sony brand video equipment.

<i>Sony Equipment</i>	<i>Switch Position on Remote Control</i>	<i>Programmable Code Number</i>
Beta, ED Beta VCRs	VTR1	303
8 mm VCR	VTR2	302
VHS VCR	VTR3	301
DVD Player	DVD/MDP	751

If you have video equipment other than Sony brand that you want to control with the TV's remote control, use the following procedures to program the remote control.

 The equipment must have infrared (IR) remote capability in order to be used with the remote control.

Turn to "Manufacturer's Codes" on page 53, and find the three-digit code number for the manufacturer of your component. If more than one code number is listed, use the number listed first to complete the following procedure.

 You must perform step 3 within 10 seconds of step 2, or you must start again from step 2.



- If more than one code number is listed, try entering them one by one until you come to the correct code for your component.
- If you enter a new code number, the code number you previously entered at that setting is erased.
- In some rare cases, you may not be able to operate your component with the supplied remote control. In this case, use the component's own remote control unit.
- Whenever you remove the batteries to replace them, the code numbers may revert to the factory setting and must be reset.

- 1** Move the slide switch to the desired component type (KV-32FV26 and KV-36FV26 models only). (Skip this step if you are programming a cable box or satellite receiver.)
- 2** Press CODE SET.
- 3** Press the function button for the type of component you want to control with the TV's remote control (VTR/DVD or SAT/CABLE).
- 4** Enter the three-digit manufacturer's code number.
- 5** Press ENTER.
- 6** To check if the code number works, aim the TV's remote control at the component and press the green POWER button that corresponds with that component. If it responds, you are done. If not, try using the other codes listed for that manufacturer.

Manufacturer's Codes

VCRs

<i>Manufacturer</i>	<i>Code</i>
Sony	301
Admiral (M. Ward)	327
Aiwa	338, 344
Audio Dynamic	314, 337
Broksonic	319, 317
Canon	309, 308
Citizen	332
Craig	302, 332
Criterion	315
Curtis Mathes	304, 338, 309
Daewoo	341, 312, 309
DBX	314, 336, 337
Dimensia	304
Emerson	319, 320, 316, 317, 318, 341
Fisher	330, 335
Funai	338
General Electric	329, 304, 309
Go Video	322, 339, 340
Goldstar	332
Hitachi	306, 304, 305, 338
Instant Replay	309, 308
JC Penney	309, 305, 304, 330, 314, 336, 337
JVC	314, 336, 337, 345, 346, 347
Kenwood	314, 336, 332, 337
LXI (Sears)	332, 305, 330, 335, 338
Magnavox	308, 309, 310
Marantz	314, 336, 337
Marta	332

<i>Manufacturer</i>	<i>Code</i>
Memorex	309, 335
Minolta	305, 304
Mitsubishi/ MGA	323, 324, 325, 326
Multitech	325, 338, 321
NEC	314, 336, 337
Olympic	309, 308
Optimus	327
Panasonic	308, 309, 306, 307
Pentax	305, 304
Philco	308, 309
Philips	308, 309, 310
Pioneer	308
Quasar	308, 309, 306
RCA/ PROSCAN	304, 305, 308, 309, 311, 312, 313, 310, 329
Realistic	309, 330, 328, 335, 324, 338
Sansui	314
Samsung	322, 313, 321
Sanyo	330, 335
Scott	312, 313, 321, 335, 323, 324, 325, 326
Sharp	327, 328
Shintom	315
Signature 2000 (M. Ward)	338, 327
SV2000	338
Sylvania	308, 309, 338, 310
Symphonic	338
Tashiro	332
Tatung	314, 336, 337
Teac	314, 336, 338, 337
Technics	309, 308
Toshiba	312, 311

<i>Manufacturer</i>	<i>Code</i>
Wards	327, 328, 335, 331, 332
Yamaha	314, 330, 336, 337
Zenith	331

Laserdisc Players

<i>Manufacturer</i>	<i>Code</i>
Panasonic	704, 710
Pioneer	702

DVD Players

<i>Manufacturer</i>	<i>Code</i>
Sony	751
Panasonic	753
Pioneer	752
RCA	755
Toshiba	754

Cable Boxes

<i>Manufacturer</i>	<i>Code</i>
Hamlin/Regal	222, 223, 224, 225, 226
Jerrold/G. I.	201, 202, 203, 204, 205, 206, 207, 208, 218
Oak	227, 228, 229
Panasonic	219, 220, 221
Pioneer	214, 215
Scientific Atlanta	209, 210, 211
Tocom	216, 217
Zenith	212, 213

Satellite Receivers

<i>Manufacturer</i>	<i>Code</i>
Sony	801
General Electric	802
Hitachi	805
Hughes	804
Panasonic	803
RCA/ PROSCAN	802, 808
Toshiba	806, 807

Operating Other Components with Your TV Remote Control

Operating a VCR

Move the slide switch to the AV input you coded for this device.

To Do This ...	Press
Turn on/off	VTR/DVD (green POWER button)
Select VCR	VTR/DVD (FUNCTION button)
Change channels	CH +/-
Record	Except models KV-32FV26 and 36FV26: ▶ and ● simultaneously. Models KV-32FV26 and 36FV26: ● and ◯ (upper left) simultaneously.
Play	▶
Stop	■
Fast forward	▶▶
Rewind the tape	◀◀
Pause	(press again to resume normal playback)
Search the picture forward or backward	▶▶ or ◀◀ during playback (release to resume normal playback)
Change input mode	TV/VTR

Operating a DVD Player

Move the slide switch to the AV input you coded for this device.

To Do This ...	Press
Turn on/off	VTR/DVD (green POWER button)
Select DVD	VTR/DVD (FUNCTION button)
Play	▶
Stop	■
Pause	(press again to resume normal playback)
Step through different tracks of an audio disc	▶▶ to step forward or ◀◀ to step backward
Step through different chapters of a video disc	CH+ to step forward or CH- to step backward
Display the Title menu	TITLE (models KV-32FV26, 36FV26 only)
Display the DVD menu	DVD MENU (models KV-32FV26, 36FV26 only)
Select tracks directly	0-9 buttons
Display the menu (Setup)	MENU

Operating a Cable Box

<i>To Do This ...</i>	<i>Press</i>
Turn on/off	SAT/CABLE (green POWER button)
Select Cable Box	SAT/CABLE (FUNCTION button)
Select a channel	0-9 buttons, ENTER
Change channels	CH +/-
Back to previous channel	JUMP

Operating a Satellite Receiver

<i>To Do This ...</i>	<i>Press</i>
Turn on/off	SAT/CABLE (green POWER button)
Select Satellite Receiver	SAT/CABLE (FUNCTION button)
Select a channel	0-9 buttons, ENTER
Change channels	CH +/-
Back to previous channel	JUMP
Change input mode	TV/SAT
Display channel number	DISPLAY
Display DBS guide	GUIDE
Display DBS menu	MENU
Move highlight (cursor)	Joystick or arrows
Select item	⬇ button

**Operating an MDP
(Laserdisc Player)**

Move the slide switch to the AV input you coded for this device.

<i>To Do This ...</i>	<i>Press</i>
Turn on/off	VTR/DVD (green POWER button)
Select MDP	VTR/DVD (FUNCTION button)
Play	▶
Stop	■
Pause	⏸ (press again to resume normal playback)
Search the picture forward or backward	▶▶ or ◀◀ during playback (release to resume normal playback)
Search a chapter forward or backward	CH +/-

Troubleshooting

<i>Problem</i>	<i>Possible Remedies</i>
No picture (screen not lit), no sound	<ul style="list-style-type: none"> <input type="checkbox"/> If your TV does not turn on, and a red light keeps flashing, your TV may need service. Call your local Sony Service Center. <input type="checkbox"/> Make sure the power cord is plugged in. <input type="checkbox"/> Push the power button on the front of the TV. <input type="checkbox"/> Check to see if the TV/VIDEO setting is correct: when watching TV, set to TV, and when watching connected equipment, set to VIDEO 1, 2, 3, or 4. <input type="checkbox"/> Try another channel. It could be station trouble.
Remote control does not operate	<ul style="list-style-type: none"> <input type="checkbox"/> Batteries could be weak. Replace the batteries. <input type="checkbox"/> Press TV (FUNCTION) when operating your TV. <input type="checkbox"/> Make sure the TV's power cord is connected securely to the wall outlet. <input type="checkbox"/> Locate the TV at least 3-4 feet away from fluorescent lights. <input type="checkbox"/> Check the orientation of the batteries.
Dark, poor or no picture (screen lit), good sound	<ul style="list-style-type: none"> <input type="checkbox"/> Adjust the Picture setting in the Video menu (see page 36). <input type="checkbox"/> Adjust the Brightness setting in the Video menu (see page 36). <input type="checkbox"/> Check antenna/cable connections.
Good picture, no sound	<ul style="list-style-type: none"> <input type="checkbox"/> Press MUTING so that "MUTING" disappears from the screen (see page 4). <input type="checkbox"/> Make sure Speaker is set to ON in the Audio menu (see page 38).
Cannot receive upper channels (UHF) when using an antenna	<ul style="list-style-type: none"> <input type="checkbox"/> Change Cable to OFF (see page 40). <input type="checkbox"/> Use Auto Program in the Channel menu to add receivable channels that are not presently in TV memory (see page 40).
No color	<ul style="list-style-type: none"> <input type="checkbox"/> Adjust the Color settings in the Video menu (see page 36).
Only snow and noise appear on the screen	<ul style="list-style-type: none"> <input type="checkbox"/> Check the antenna/cable connections. <input type="checkbox"/> Make sure the channel is broadcasting programs. <input type="checkbox"/> Press ANT to change the input mode (see page 4).
Dotted lines or stripes	<ul style="list-style-type: none"> <input type="checkbox"/> Adjust the antenna. <input type="checkbox"/> Move the TV away from noise sources such as cars, neon signs, or hair-dryers.
TV is fixed to one channel	<ul style="list-style-type: none"> <input type="checkbox"/> Use Auto Program in the Channel menu to add receivable channels that are not presently in TV memory (see page 41). <input type="checkbox"/> Check your Channel Fix settings (see page 41).
Double images or ghosts	<ul style="list-style-type: none"> <input type="checkbox"/> Use a highly directional outdoor antenna or a cable (when the problem is caused by reflections from nearby mountains or tall buildings).
Cannot operate menu	<ul style="list-style-type: none"> <input type="checkbox"/> If the item you want to choose appears in gray, you cannot select it.
Cannot receive any channels when using cable TV	<ul style="list-style-type: none"> <input type="checkbox"/> Use Auto Program in the Channel menu to add receivable channels that are not presently in TV memory (see page 41). <input type="checkbox"/> Check your cable settings. <input type="checkbox"/> Make sure Cable is set to ON in the Channel menu (see page 40).
Cannot gain enough volume when using a cable box	<ul style="list-style-type: none"> <input type="checkbox"/> Increase the volume of the cable box using the cable box's remote control. Then press TV (FUNCTION) and adjust the TV's volume.

Problem	Possible Remedies
Cannot receive channels	<input type="checkbox"/> Use Auto Program in the Channel menu to add receivable TV channels that are not presently in TV memory (see page 41).
Unable to select a channel	<input type="checkbox"/> Use Auto Program in the Channel menu to add receivable TV channels that are not presently in TV memory (see page 41).
Lost password	<input type="checkbox"/> In the password screen (see page 42), enter the following master password: 4357. The master password clears your previous password; it cannot be used to temporarily unblock channels.
Cannot change channels with the remote control	<input type="checkbox"/> If you are using the TV to change channels, be sure the TV FUNCTION button is selected. <input type="checkbox"/> If you are using another device to change channels, be sure you have not inadvertently switched your TV from the channel 3 or 4 setting. Use the Channel Fix feature to "fix" the channel based on the hookup you used (see page 41). <input type="checkbox"/> If you are using another device to change channels, be sure to press the green "FUNCTION" button for that device. For example, if you are using your VCR to change channels, be sure to press the VTR/DVD FUNCTION button.
Cannot cycle through the other video equipment connected to the TV	<input type="checkbox"/> Be sure the Video Label feature has not been set to "Skip" (see page 48).
There is a black box on the screen	<input type="checkbox"/> You have selected a text option in the Setup menu and no text is available. (See page 47 to reset Setup selections.) To turn off this feature, select OFF in the Caption Vision option. If you were trying to select closed captioning, select CC1 instead of TEXT 1-4.
The remote control will not work in PIP mode	<input type="checkbox"/> Press the TV FUNCTION button. You may have inadvertently pressed the VTR/DVD FUNCTION button, which changes the PIP buttons to VCR mode.
There is no window picture or it is just static	<input type="checkbox"/> Be sure your window picture is set to a video source/channel that has a program airing. <input type="checkbox"/> You may be tuned to a video input with nothing connected to it. Try cycling through your video inputs using the PIP TV/VIDEO button. <input type="checkbox"/> PIP is not set to receive a signal from the AUX input. If you connected a VCR, DVD player or Satellite Receiver to the AUX input on the TV, it will not show in the small window picture.
I get the same program in the window picture as in the main picture	<input type="checkbox"/> Both may be set to the same channel. Try changing channels in either the main picture or the window picture. <input type="checkbox"/> You may be running all your channels through a cable box. The cable box will only unscramble one signal at a time, so you cannot use the PIP feature. If possible, run a direct cable to your TV's VHF/UHF input. (This will only work if your cable system provides an unscrambled signal.)
I cannot get anything but TV in my window picture	<input type="checkbox"/> Be sure the video label has not been set to skip your video inputs. (See the Setup menu on page 48.)

If, after reading these operating instructions, you have additional questions related to the use of your Sony television, please call our Direct Response Center at 1-800-222-SONY (7669) (U.S. residents only) or (416) 499-SONY (7669) (Canadian residents only).

Specifications

All Models (General)

Picture Tube	FD Trinitron® tube	
Antenna	75 ohm external terminal for VHF/UHF	
Television System	NTSC, American TV Standard	
Channel Coverage		
VHF	2-13	
UHF	14-69	
CATV	1-125	
Power Requirements	120V, 60 Hz	
Number of Inputs/Outputs		
Video (IN)	3	1 Vp-p, 75 ohms unbalanced, sync negative
S Video (IN)	1 (KV-36FS12, 36FS16 only) 2 (except KV-36FS12, 36FS16)	Y: 1 Vp-p, 75 ohms unbalanced, sync negative C: 0.286 Vp-p (Burst signal), 75 ohms
Audio (IN)	4	500 mVrms (100% modulation) Impedance: 47 kilohm
Variable/Fixed Audio (OUT)	1	More than 408 mVrms at the maximum volume setting (Variable) More than 408 mVrms (Fixed) Impedance (output): 2 kilohms
Monitor Out	1 (except KV-36FS12, 36FS16)	1 Vp-p, 75 ohms unbalanced, sync negative
CONTROL-S (IN/OUT)	1 (except KV-36FS12, 36FS16)	
S Link (OUT)	3 (except KV-36FS12, 36FS16)	
Component Video Input	1 (Y, P _B , P _R)	Y: 1.0 Vp-p, 75 ohms unbalanced, sync negative; P _B : 0.7 Vp-p, 75 ohms P _R : 0.7 Vp-p, 75 ohms

KV-32FV16, 32FV26

Supplied Accessories

Remote Control		
KV-32FV16	RM-Y171	
KV-32FV26	RM-Y170	
AA (R6) Batteries		
KV-32FV16	2 supplied for remote control	
KV-32FV26	2 supplied for remote control, 1 supplied for wireless headphones	
Wireless Stereo Headphones	MDR-IF0230 (KV-32FV26 only)	

Optional Accessories

AV Cable	VMC-810/820/830 HG	
Audio Cable	RKC-515HG	
S-LINK Cable	RK-G69HG	
Component Video Cable	VMC-10/30 HG	
TV Stand	SU-32FD3	

Visible Screen Size	32 in (812.8 mm) picture measured diagonally	
Actual CRT Size	34 in (863.6 mm) picture measured diagonally	
Speaker Output	15 W x 2	
Dimensions (W x H x D)	882 x 687 x 592 mm (34 3/4 x 27 x 23 1/4 in)	
Mass	80 kg (176 lbs)	
Power Consumption		
In Use	200 W	
In Standby	2 W	

Other Information

KV-36FS12, 36FS16

Supplied Accessories

Remote Control	
KV-36FS12	RM-Y168
KV-36FS16	RM-Y169
AA (R6) Batteries	2 supplied for remote control
Optional Accessories	
AV Cable	VMC-810/820/830 HG
Audio Cable	RKC-515HG
Component Video Cable	VMC-10/30 HG
TV Stand	SU-36FD3
Visible Screen Size	36 in (914.4 mm) picture measured diagonally
Actual CRT Size	38 in (965.2 mm) picture measured diagonally
Speaker Output	5 W x 2
Dimensions (W x H x D)	910 x 791 x 650 mm (35 7/8 x 31 1/8 x 25 5/8 in)
Mass	100 kg (220 lbs)
Power Consumption	
In Use	190 W
In Standby	2 W

KV-36FV16, 36FV26

Supplied Accessories

Remote Control	
KV-36FV16	RM-Y171
KV-36FV26	RM-Y170
AA (R6) Batteries	
KV-36FV16	2 supplied for remote control
KV-36FV26	2 supplied for remote control, 1 supplied for wireless headphones
Wireless Stereo Headphones	MDR-IF0230 (KV-36FV26 only)
Optional Accessories	
AV Cable	VMC-810/820/830 HG
Audio Cable	RKC-515HG
S-LINK Cable	RK-G69HG
Component Video Cable	VMC-10/30 HG
TV Stand	SU-36FD3
Visible Screen Size	36 in (914.4 mm) picture measured diagonally
Actual CRT Size	38 in (965.2 mm) picture measured diagonally
Speaker Output	15 W x 2
Dimensions (W x H x D)	975 x 757 x 633 mm (38 3/8 x 29 3/4 x 24 7/8 in)
Mass	107 kg (236 lbs)
Power Consumption	
In Use	200 W
In Standby	2 W

Index

16:9 (widescreen) 2, 48

3-D sound, adjusting 39, 49

A

Activating a PIP screen 29

Adding channels to the channel list 40

Adjusting the picture definition 37

Adjusting the audio

Steady sound 38

ANT button 29

antenna, connecting

Aspect ratio, 16:9 48

Audio menu 35, 38

audio receiver, connecting 21

Auto Program (channel setup) 26, 41

Auto-SAP 35, 49

Auto setup 38

B

balance, adjusting 38

Basic menu 35, 49

bass, adjusting 38

batteries

inserting in remote 3

inserting in wireless headphones 32

bilingual audio 39

blocking programs. See ratings.

brightness, adjusting 36

C

cable

box, connecting with VCR 15

connecting 10-13

setting ON/OFF 41

with VCR, connecting 14

cable box, using with TV remote control 55

camcorder, connecting 24

Caption Vision 47, 49

CATV. see cable

Channel List

Adding channels to 3

Removing channels from 32

Channel menu 35

Channel Setup menu 40

Channel Skip/Add 38

channels

creating labels 41

setting up 26

closed caption modes 47

Code Set Button 39

color temperature, adjusting 37

color, adjusting 36

Connecting:

Audio Receiver 21

Cable or antenna 10-13

Cable box 11-13

Camcorder 24

DVD player 22, 23

Satellite receiver 18

VCR 14-17

VCR with satellite receiver 19

Contents of box 3

CONTROL S 25

Controls and connections 8

Converter 12

D

Demo, menus 48

Display button 5

Display, turning off 5

DVD player

using with TV remote control 54

with A/V connectors, connecting 23

with component video connectors, connecting
22

E

Enhanced picture resolution 48

Extended Data Service 47

F

- Favorite Channel
 - setting up 40
 - using 28
- Favorites button 28
- features 2
- Front Panel controls 8

G

- Guide button 5

H

- headphones, see wireless headphones
- Hookups 10-25
- hue, adjusting 36

I

- inputs, labeling 48
- Installation 48

J

- Jump button 5

L

- label
 - channels 41
 - video inputs 48
- Languages, setting for closed captioning 48
- Locking programs 42

M

- Manufacturer's Codes 53
- MDP, using with TV remote control 56
- Menu button 5
- menus
 - Audio 35, 38
 - Basic 35, 49
 - Channel 35
 - Channel Setup 40
 - Parent 35
 - Parental Control 42
 - Setup 35, 47
 - Timer 35, 45
 - Video 35, 36
- MTS 5, 39
- Muting 4

P

- Parent menu 35, 42
- parental control, described 2
- password
 - changing 42
- picture contrast, adjusting 36
- picture definition, adjusting 37
- Picture in Picture (PIP), using 29
- picture, adjusting 49
- Picture Mode 4
- Picture size, adjusting in PIP 30
- power cord, removing from holder 7
- presetting channels 41
- problems, troubleshooting 57-58

R

- ratings, setting 42-44
- ratings, viewing blocked programs 44
- Rear panel controls and connections 8-9
- remote control
 - described 4-5
 - inserting batteries 3
 - programming 52-53
- Remote control, buttons inside flap 5
- Remote control, operating other components with
 - VCR 54
 - MDP 56
 - Satellite receiver 55
 - DVD 54
 - Cable box 55
- Removing channels from the channel list 48
- Reset button 5
- resetting
 - Audio options 38
 - Timer options 45
 - Video options 36

S

- Safety ii, iii, iv
- SAT/CABLE power button 4
- SAT/CABLE function button 4
- satellite receiver, using with TV remote control 55
- Setting favorite channels 36
- setting up channels 26
- Setup menu 35, 47

sharpness, adjusting 36
Sleep timer/button 4
sound effect (3-D), adjusting 39, 49
speakers

- turning on/off 39
- using external speakers 39

specifications 59-60
Steady Sound, adjusting 38
Steady Sound, described 38
surround sound 39, 49

T

tape-to-tape editing 17
tilt, correcting 48
Time,

- set current 17
- set daylight savings 54

Timer menu 35, 45
Timer setting 46
treble, adjusting 38
troubleshooting 57-58
TV function button 4
TV power button 4
TV/VIDEO button 4

V

VCR

connecting two, for tape editing 17
using with TV remote control 54
with cable box, connecting 15
with cable, connecting 14
with satellite receiver, connecting 19
VCR/DVD power button 4
VCR/DVD function button 4
Velocity Modulation 2, 37
video inputs, labeling 48
Video menu 35, 36
Video Modes, selecting 36

