



SAMSUNG

**LTM1575W
LTM1775W**

COLOR TELEVISION



**Owner's
Instructions**

Warning! Important Safety Instructions



CAUTION: TO REDUCE THE RISK OF ELECTRIC SHOCK, DO NOT REMOVE COVER (OR BACK). NO USER SERVICEABLE PARTS INSIDE. REFER SERVICING TO QUALIFIED SERVICE PERSONNEL.

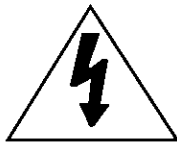

This symbol indicates high voltage is present inside. It is dangerous to make any kind of contact with any inside part of this product.



This symbol alerts you that important literature concerning operation and maintenance has been included with this product.

Note to CATV system installer: This reminder is provided to call CATV system installer's attention to Article 820-40 of the National Electrical Code (Section 54 of Canadian Electrical Code, Part I), that provides guidelines for proper grounding and, in particular, specifies that the cable ground shall be connected to the grounding system of the building as close to the point of cable entry as practical.

Caution: FCC/CSA regulations state that any unauthorized changes or modifications to this equipment may void the user's authority to operate it.

Caution: To prevent electric shock, match the wide blade of plug to the wide slot, and fully insert the plug.

Attention: pour éviter les chocs électriques, introduire la lame le plus large de la fiche dans la borne correspondante de la prise et pousser jusqu'au fond.

Important: One Federal Court has held that unauthorized recording of copyrighted TV programs is an infringement of U.S. copyright laws. Certain Canadian programs may also be copyrighted and any unauthorized recording in whole or in part may be in violation of these rights.

To prevent damage which may result in fire or electric shock hazard, do not expose this appliance to rain or moisture.

Thank You for Choosing Samsung

Thank you for choosing Samsung! Your new Samsung TV represents the latest in television technology. We designed it with easy-to-use on-screen menus and closed captioning capabilities, making it one of the best products in its class. We are proud to offer you a product that will provide convenient, dependable service and enjoyment for years to come.

Important Safety Information

 Always be careful when using your TV receiver. To reduce the risk of fire, electrical shock, and other injuries, keep these safety precautions in mind when installing, using, and maintaining your machine.

- Read all safety and operating instructions before operating your TV.
- Keep the safety and operating instructions for future reference.
- Heed all warnings on the TV receiver and in the operating instructions.
- Follow all operating and use instructions.
- Unplug the TV receiver from the wall outlet before cleaning. Use a damp cloth; do not use liquid or aerosol cleaners.
- Never add any attachments and/or equipment without approval of the manufacturer. Such additions can increase the risk of fire, electric shock, or other personal injury.
- Do not use the TV receiver where contact with or immersion in water is a possibility, such as near bath tubs, sinks, washing machines, swimming pools, etc.
- Do not place the TV on an unstable cart, stand, tripod, bracket, or table where it can fall. A falling TV can cause serious injury to a child or adult, and serious damage to the appliance. Use only with a cart, stand, tripod, bracket, or table recommended by the manufacturer or sold with the TV. Follow the manufacturer's instructions when mounting the unit, and use a mounting accessory recommended by the manufacturer. Move the TV and cart with care. Quick stops, excessive force, and uneven surfaces can make the unit and cart unsteady and likely to overturn.
- Provide ventilation for the TV receiver. The unit is designed with slots in the cabinet for ventilation to protect it from overheating. Do not block these openings with any object, and do not place the TV receiver on a bed, sofa, rug, or other similar surface. Do not place it near a radiator or heat register. If you place the TV receiver on a rack or bookcase, ensure that there is adequate ventilation and that you've followed the manufacturer's instructions for mounting.
- Operate your TV receiver only from the type of power source indicated on the marking label. If you are not sure of the type of power supplied to your home, consult your appliance dealer or local power company.
- Use only a grounded or polarized outlet. For your safety, this TV is equipped with a polarized alternating current line plug having one blade wider than the other. This plug will fit into the power outlet only one way. If you are unable to insert the plug fully into the outlet, try reversing the plug. If the plug still does not fit, contact your electrician to replace your outlet.



- Protect the power cord. Power supply cords should be routed so that they won't be walked on or pinched by objects placed on or against them. Pay particular attention to cords at plugs, convenience receptacles, and the point where they exit from the unit.
- Unplug the TV from the wall outlet and disconnect the antenna or cable system during a lightning storm or when left unattended and unused for long periods of time. This will prevent damage to the unit due to lightning and power-line surges.
- Avoid overhead power lines. An outside antenna system should not be placed in the vicinity of overhead power lines or other electric light or power circuits or where it can fall into such power lines or circuits. When installing an outside antenna system, be extremely careful to keep from touching the power lines or circuits. Contact with such lines can be fatal.
- Do not overload the wall outlet or extension cords. Overloading can result in fire or electric shock.
- Do not insert anything through the openings in the unit, where they can touch dangerous voltage points or damage parts. Never spill liquid of any kind on the TV.

- Ground outdoor antennas. If an outside antenna or cable system is connected to the TV, be sure the antenna or cable system is grounded so as to provide some protection against voltage surges and built-up static charges. Section 810 of the National Electrical Code, ANSI/NFPA No.70-1984, provides information about proper grounding of the mast and supporting structure, grounding of the lead-in wire to an antenna discharge unit, size of grounding conductors, location of antenna discharge unit, connection to grounding electrodes, and requirements for the grounding electrode.

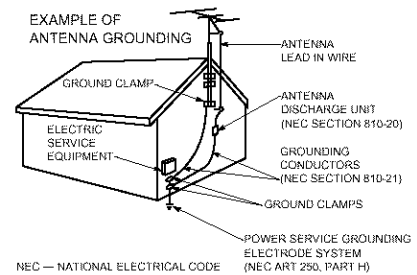

- Do not attempt to service the TV yourself. Refer all servicing to qualified service personnel. Unplug the unit from the wall outlet and refer servicing to qualified service personnel under the following conditions:
 - when the power-supply cord or plug is damaged
 - if liquid has been spilled on the unit or if objects have fallen into the unit
 - if the TV has been exposed to rain or water
 - if the TV does not operate normally by following the operating instructions
 - if the TV has been dropped or the cabinet has been damaged
 - when the TV exhibits a distinct change in performance
- If you make adjustments yourself, adjust only those controls that are covered by the operating instructions. Adjusting other controls may result in damage and will often require extensive work by a qualified technician to restore the TV to normal.
- When replacement parts are required, be sure the service technician uses replacement parts specified by the manufacturer or those that have the same characteristics as the original part. Unauthorized substitutions may result in additional damage to the unit.
- Upon completion of any service or repairs to this TV, ask the service technician to perform safety checks to determine that the TV is in a safe operating condition.

This device complies with part 15 of the FCC Rules. Operation is subject to the following two conditions:

- (1) This device may not cause harmful interference, and**
- (2) This device must accept any interference that may cause undesired operation.**

This television receiver provides display of television closed captioning in accordance with § 15.119 of the FCC rules.

- 1) Read these instructions.
- 2) Keep these instructions.
- 3) Heed all warnings.
- 4) Follow all instructions.
- 5) Do not use this apparatus near water.
- 6) Clean only with dry cloth.
- 7) Do not block any ventilation openings, Install in accordance with the manufacturer's instructions.
- 8) Do not install near any heat sources such as radiators, heat registers, or other apparatus (including amplifiers) that produce heat.
- 9) Do not defeat the safety purpose of the polarized or grounding-type plug. A polarized plug has two blades with one wider than the other. A grounding type plug has two blades and a third grounding prong. The wide blade or the third prong are provided for your safety. If the provided plug does not fit into your outlet, consult an electrician for replacement of the obsolete outlet.
- 10) Protect the power cord from being from being walked on or pinched particularly at plugs, convenience receptacles, and the point where they exit from the apparatus.
- 11) Only use attachments/accessories specified by the manufacturer.
- 12) Use only with cart, stand, tripod, bracket, or table specified by the manufacturer, or sold with the apparatus. When a used, caution when moving the cart/apparatus combination to avoid injury from tip-over.
- 13) Unplug this apparatus. When a cart is used, use caution when moving the cart/apparatus combination to avoid injury from tip-over.
- 14) Refer all servicing to qualified service personnel. Servicing is required when the apparatus has been damaged in any way, such as power-supply cord or plug is damaged, liquid has been spilled or objects have fallen into the apparatus, the apparatus has been exposed to rain or moisture, does not operate normally, or has been dropped.



DOUBLE INSULATED - When servicing use only identical replacement parts.

Chapter 1: Your New TV	1.1
List of Features	1.1
List of Parts	1.1
Familiarizing Yourself with Your New TV	1.2
Front Panel Buttons	1.2
Side Panel Jacks	1.3
Rear Panel Jacks	1.4
Remote Control	1.5
 Chapter 2: Installation	 2.1
Connecting VHF and UHF Antennas	2.1
Antennas with 300-ohm Flat Twin Leads	2.1
Antennas with 75-ohm Round Leads	2.2
Separate VHF and UHF Antennas	2.2
Connecting Cable TV	2.2
Cable without a Cable Box	2.2
Connecting to a Cable Box that Descrambles All Channels	2.3
Connecting to a Cable Box that Descrambles Some Channels	2.3
Connecting a VCR	2.5
Connecting an S-VHS VCR	2.6
Connecting a DVD Player	2.7
Connecting a Digital TV Set-Top Box	2.7
Connecting a Camcorder	2.8
Installing Batteries in the Remote Control	2.9
 Chapter 3: Operation	 3.1
Turning the TV On and Off	3.1
Plug & Play Feature	3.1
Viewing the Menus and On-Screen Displays	3.3
Viewing the Menus	3.3
Viewing the Display	3.3
Selecting a Menu Language	3.4
Memorizing the Channels	3.5
Selecting the Video Signal-source	3.5
Storing Channels in Memory (Automatic Method)	3.6
Adding and Erasing Channels (Manual Method)	3.7
Changing Channels	3.7
Using the Channel Buttons	3.7
Directly Accessing Channels	3.7
Using the Pre-CH Button to select the Previous Channel	3.7
Adjusting the Volume	3.8
Using Mute	3.8
Setting the Clock	3.9
Customizing the Picture	3.10
Using Automatic Picture Settings	3.11
Customizing the Sound	3.12
Using Automatic Sound Settings	3.13
Viewing a VCR or Camcorder Tape	3.14

Chapter 4: Special Features	4.1
Fine Tuning Channels	4.1
LNA (Low Noise Amplifier)	4.2
Setting the Blue Screen Mode	4.3
Changing the Screen Size	4.4
Freezing the Picture	4.4
Special Sound Options	4.5
Choosing a Multi-Channel Sound (MTS) Soundtrack	4.5
Auto Volume	4.6
Virtual Dolby	4.7
Adjusting the Headphone Sound	4.8
Selecting the Headphone Sound	4.9
Setting the On/Off Timer	4.10
Setting the Sleep Timer	4.11
Viewing Closed Captions	4.12
Viewing Picture-in-Picture	4.13
Activating Picture-in-Picture	4.13
Selecting a Signal Source (External A/V) for PIP	4.14
Swapping the Contents of the PIP image and Main image	4.15
Changing the PIP Channel	4.15
Changing the Location of the PIP Window	4.15
Changing the Size of the PIP Window	4.15
Using the V-Chip	4.16
Setting Up Your Personal ID Number (PIN)	4.16
How to Enable/Disable the V-Chip	4.17
How to Set up Restrictions Using the "TV guidelines"	4.17
How to Set up Restrictions using the MPAA Ratings:	
G, PG, PG-13, R, NC-17, X	4.18
How to Reset the TV after the V-Chip	
Blocks a Channel ("Emergency Escape")	4.19
Chapter 5: PC Display	5.1
Using Your TV as a Computer (PC) Display	5.1
How to Connect Your PC to the TV	5.1
How to Set up Your PC Software (Windows only)	5.2
Adjusting the Screen Quality	5.3
Changing the Screen Position	5.4
Changing the Screen Color Standard	5.5
Adjusting the Screen Color Settings	5.6
Chapter 6: Troubleshooting	6.1
Identifying Problems	6.1
Appendix	A.1
Display Modes	A.1
Installing VESA compliant mounting devices	A.2
Attaching a Wall or Arm mounting device	A.3
Retractable Stand	A.4
Using the Anti-Theft Kensington Lock	A.4
Pin Assignments	A.5
Cleaning and Maintaining Your TV	A.5
Using Your TV in Another Country	A.5
Specifications	A.6

Chapter One

YOUR NEW TV

List of Features

Your TV was designed with the latest technology. This TV is a high-performance unit that includes the following special features:

- Easy-to-use remote control
- Easy-to-use on-screen menu system
- Automatic timer to turn the TV on and off
- Adjustable picture and sound settings that can be stored in the TV's memory
- Automatic channel tuning for up to 181 channels
- A special filter to reduce or eliminate reception problems
- Fine tuning control for the sharpest picture possible
- A built-in multi-channel sound decoder for stereo and bilingual listening
- Built-in, dual channel speakers
- A special sleep timer
- Double screen
- Headphone jack for private listening
- 16:9 letter box format available depending upon source

List of Parts

Please make sure the following items are included with your LCD TV. If any items are missing, contact your dealer.

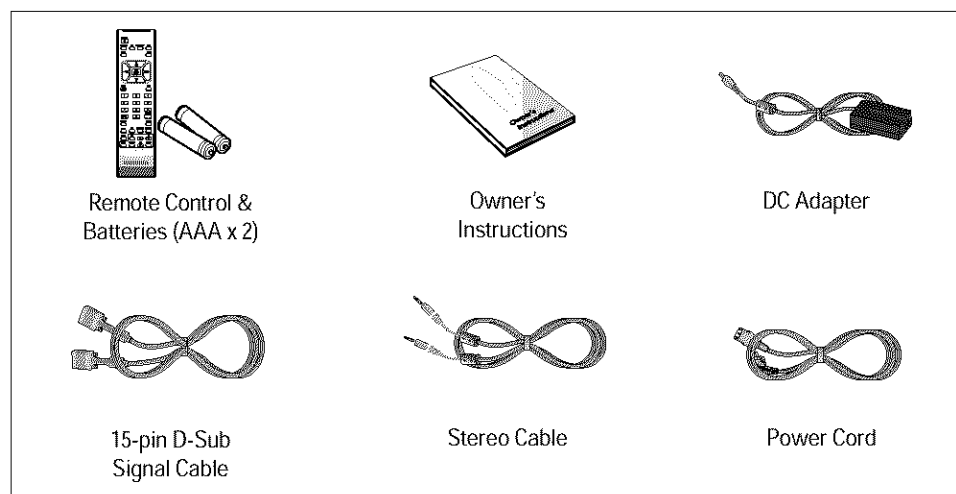

Familiarizing Yourself with The TV

Front Panel Buttons

The buttons on the front panel control your TV's basic features, including the on-screen menu. To use the more advanced features, you must use the remote control.

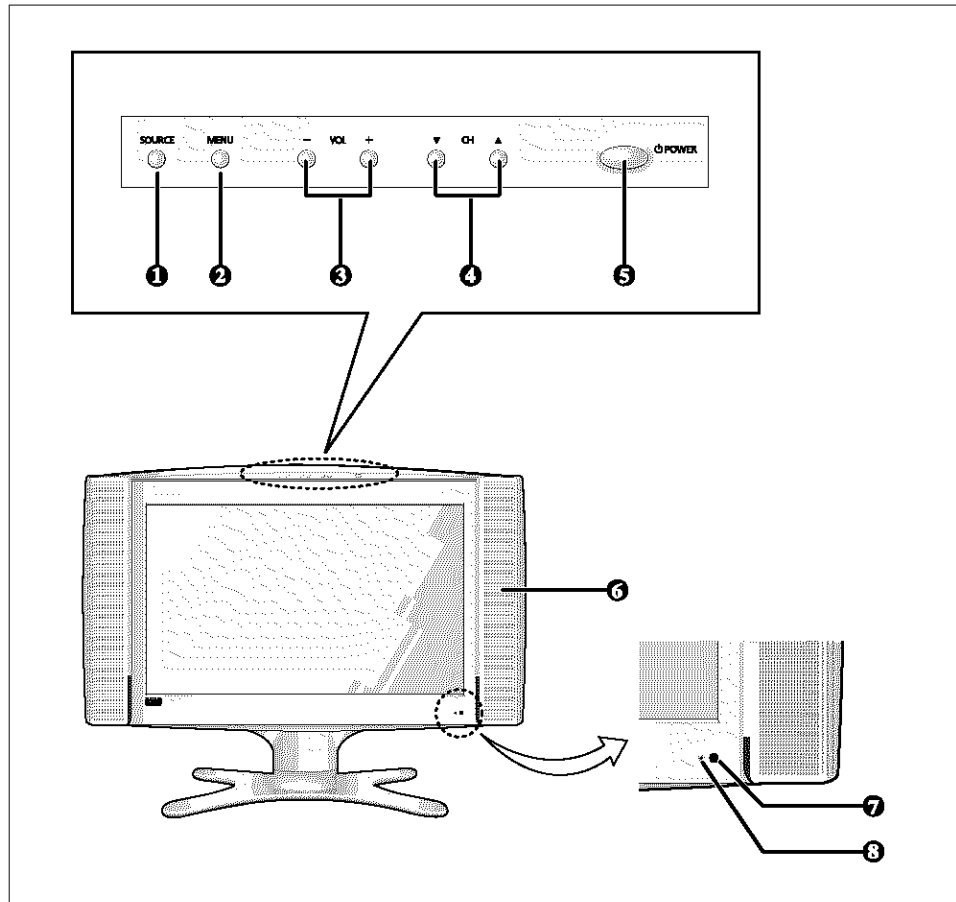

1 SOURCE

Press this button to display a menu of all the available signal sources. When the menu appears.

2 MENU

Press to see an on-screen menu of your TV's features.

3 VOL(VOLUME) - , +

Press to increase or decrease the volume. Also used to select items on the on-screen menu.

4 CH ▼ and CH ▲

Press to change channels. Also press to highlight various items on the on-screen menu.

5 POWER

Press to turn the TV on and off.

6 SPEAKER

7 Remote Control Sensor

Aim the remote control towards this spot on the TV.

8 POWER & TIMER indicator

Lights up when you turn the power off.

YOUR NEW TV

Side Panel Jacks

You can use the side panel jacks to connect an A/V component that is used only occasionally, such as a camcorder or video game. (For information on connecting equipment, see pages 2.1 - 2.9.)

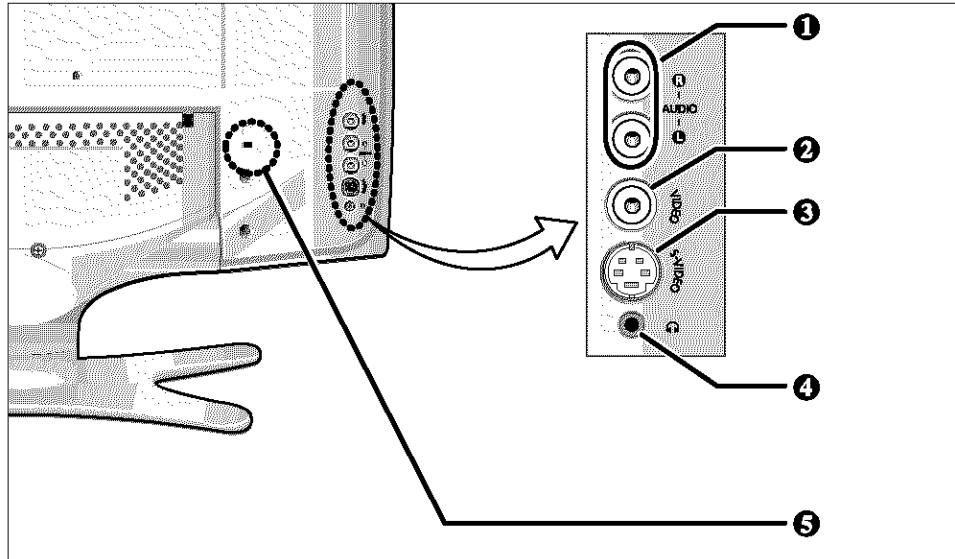

1 AUDIO IN jacks

Used to connect the audio signals from a camcorder or video game.

2 VIDEO IN jack

Used to connect a video signal from a camcorder or a video game.

3 SUPER VIDEO IN jack

Used to connect a S-Video signal from a camcorder or a video game.

4 HEADPHONE JACK

Connect a set of external headphones to this jack for private listening.

**5 Kensington lock
(See page A.4)**

YOUR NEW TV

Rear Panel Jacks

Use the rear panel jacks to connect an A/V component that will be connected continuously, such as a VCR or a DVD player.

For more information on connecting equipment, see pages 2.1 - 2.9.

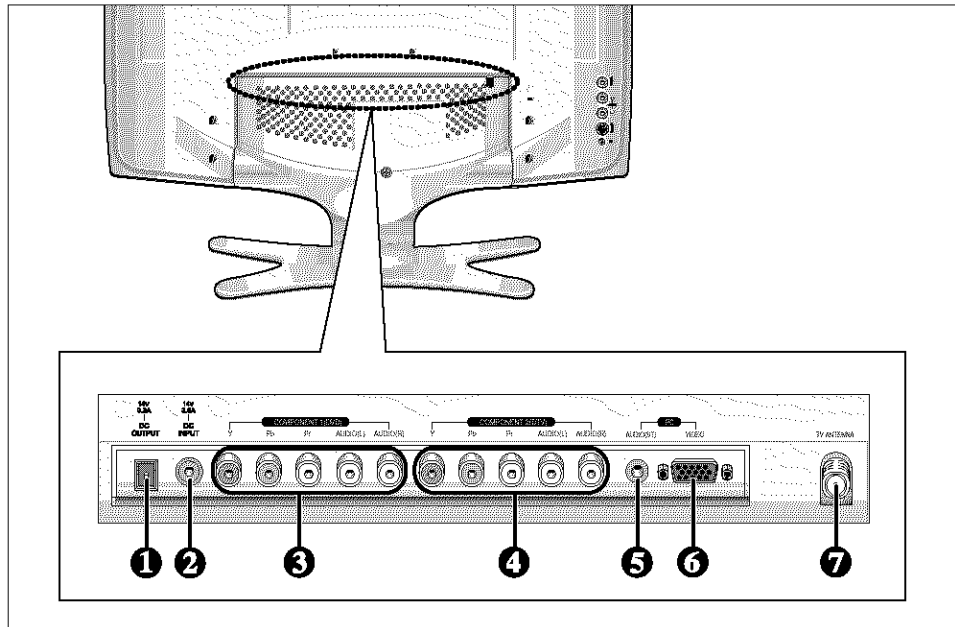

1 POWER OUTPUT CONNECTOR

2 POWER INPUT CONNECTOR

3 COMPONENT 1(DVD)
Connects component video/audio from a DVD player.

4 COMPONENT 2(DTV)
Connects component video/audio from a Set-Top Box.

5 PC AUDIO INPUT

Connect these to the audio-output jacks on your PC.

6 PC VIDEO INPUT

Connect to the video output port on your PC.

7 TV ANTENNA

Connect to an antenna or to a cable TV system.

YOUR NEW TV

Remote Control

You can use the remote control up to about 23 feet from the TV. When using the remote, always point it directly at the TV.

You can also use your remote control to operate your VCR and cable box. See page 4.1 for details.

1 POWER

Turns the TV on and off.

2 TV/VIDEO

Press to display all of the available video sources.

3 P.STD

Adjust the TV picture by selecting one of the preset factory settings (or select your personal, customized picture settings).

4 PC

Press to switch to the PC mode.

5 MENU

Displays the main on-screen menu.

VOL -, VOL +

Press to increase or decrease the volume. (Also used to make selections on the on-screen menus.)

CH▲ and CH▼ (Channel Up/Down)

Press CH▲ or CH▼ to change channels. (Also used to highlight selections on the on-screen menus.)

6 MUTE

Press to temporarily cut off the sound.

7 Number buttons

Press to select channels directly on the TV.

8 +100

Press to select channels over 100. For example, to select channel 121, press "+100," then press "2" and "1."

9 CAPTION

Controls the caption decoder.

10 MTS (Multichannel Television Stereo)

Press to choose stereo, mono or Separate Audio Program (SAP broadcast).

11 P.SIZE

Press to change the screen size.

12 SLEEP

Press to select a preset time interval for automatic shutoff.

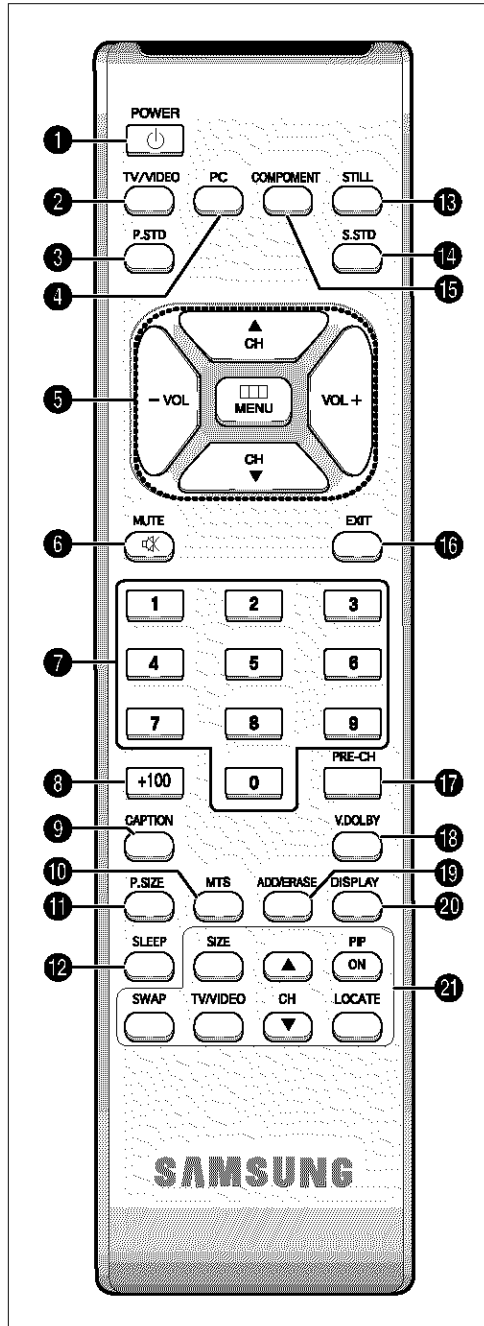

13 STILL

Press to stop the action during a particular scene. Press again to resume normal video.

14 S.STD

Adjust the TV sound by selecting one of the preset factory settings (or select your personal, customized sound settings).

15 COMPONENT

Press to switch to the COMPONENT mode.

16 EXIT

Press the menu to exit.

17 PRE-CH

Tunes to the previous channel.

18 V.DOLBY

This feature allows the TV L/R speakers to provide a home Theater-like Dolby effect.

19 ADD/ERASE

Press to add or erase channels in the TV's memory.

20 DISPLAY

Press to display the current channel and the audio-video settings.

21 PIP controls

SIZE
Press to make the PIP window double, large or small.

SWAP

Exchanges the video signal that is currently displayed on the main screen with the signal in the PIP window.

TV/VIDEO

Press to select one of the available signal sources for the PIP window.

CH

Displays the available channels in sequence. (These buttons change channels in the PIP window only).

LOCATE

Press to move the PIP window to any of the four corners of the TV screen.

Chapter Two

INSTALLATION

Connecting VHF and UHF Antennas

If your antenna has a set of leads that look like this, see “Antennas with 300-ohm Flat Twin Leads,” below.

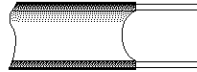

If your antenna has one lead that looks like this, see “Antennas with 75-ohm Round Leads,” on page 2.2.



If you have two antennas, see “Separate VHF and UHF Antennas,” on page 2.2.

Antennas with 300-ohm Flat Twin Leads

If you are using an off-air antenna (such as a roof antenna or “rabbit ears”) that has 300-ohm twin flat leads, follow the directions below.

1

Place the wires from the twin leads under the screws on a 300-75 ohm adaptor (not supplied). Use a screwdriver to tighten the screws.

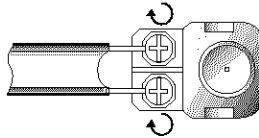

2

Plug the adaptor into the TV ANTENNA terminal on the bottom of the back panel.

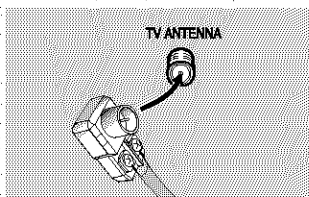

INSTALLATION

Antennas with 75-ohm Round Leads

- 1 Plug the antenna lead into the TV ANTENNA terminal on the bottom of the back panel.

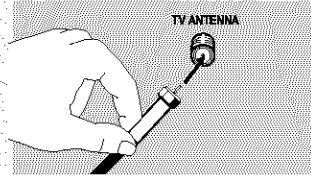

Separate VHF and UHF Antennas

If you have two separate antennas for your TV (one VHF and one UHF), you must combine the two antenna signals before connecting the antennas to the TV. This procedure requires a an optional combiner-adaptor (available at most electronics shops).

- 1 Connect both antenna leads to the combiner.

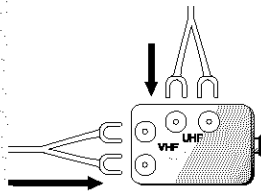

- 2 Plug the combiner into the TV ANTENNA terminal on the bottom of the rear panel.

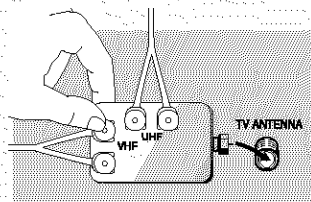

Connecting Cable TV

To connect to a cable TV system, follow the instructions below.

Cable without a Cable Box

- 1 Plug the incoming cable into the TV ANTENNA antenna terminal on back of the TV.



◀ Because this TV is cable-ready, you do not need a cable box to view unscrambled cable channels.

INSTALLATION

Connecting to a Cable Box that Descrambles **All** Channels

1

Find the cable that is connected to the ANTENNA OUT terminal on your cable box.

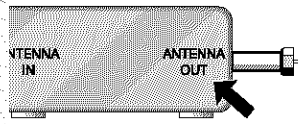

◀ This terminal might be labeled "ANT OUT," "VHF OUT," or simply, "OUT."

2

Connect the other end of this cable to the TV ANTENNA terminal on the back of the TV.

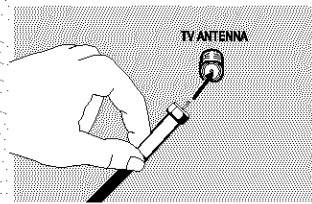

Connecting to a Cable Box that Descrambles **Some** Channels

If your cable box descrambles only some channels (such as premium channels), follow the instructions below. You will need a two-way splitter, an RF (A/B) switch, and four lengths of coaxial cable. (These items are available at most electronics stores.)

1

Find and disconnect the cable that is connected to the ANTENNA IN terminal on your cable box.

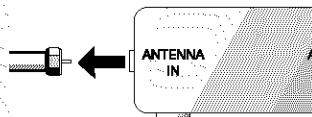

◀ This terminal might be labeled "ANT IN," "VHF IN," or simply, "IN."

2

Connect this cable to a two-way splitter.

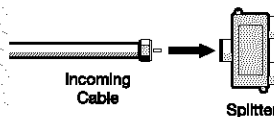

3

Connect a coaxial cable between an OUTPUT terminal on the splitter and the IN terminal on the cable box.

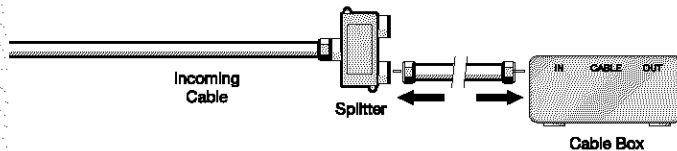

INSTALLATION

4

Connect a coaxial cable between the ANTENNA OUT terminal on the cable box and the B- IN terminal on the A/B switch.

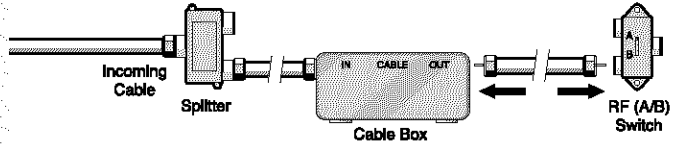

5

Connect another cable between the other OUT terminal on the splitter and the A- IN terminal on the RF (A/B) switch.

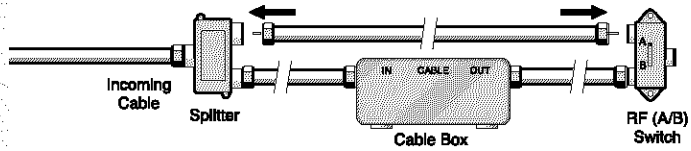

6

Connect the last coaxial cable between the OUT terminal on the RF (A/B) switch and the VHF/UHF terminal on the rear of the TV.

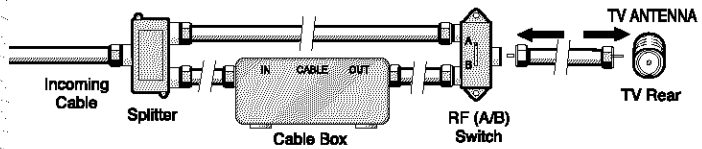

After you've made this connection, set the A/B switch to the "A" position for normal viewing. Set the A/B switch to the "B" position to view scrambled channels. (When you set the A/B switch to "B," you will need to tune your TV to the cable box's output channel, which is usually channel 3 or 4.)

INSTALLATION

Connecting a VCR

These instructions assume that you have already connected your TV to an antenna or a cable TV system (according to the instructions on pages 2.1-2.3). Skip step **1** if you have not yet connected to an antenna or a cable system.

1

Unplug the cable or antenna from the back of the TV.

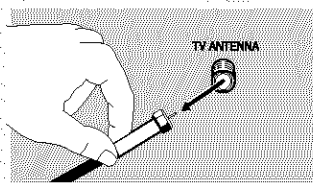

2

Connect the cable or antenna to the ANTENNA IN terminal on the back of the VCR.

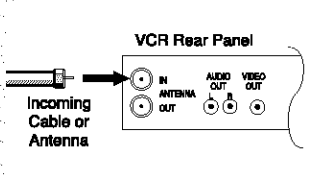

3

Connect a coaxial cable between the ANTENNA OUT terminal on the VCR and the antenna terminal on the TV.

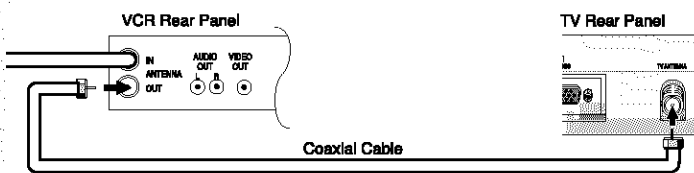

A coaxial cable is usually included with a VCR. (If not, check your local electronics store).

4

Connect a set of audio cables between the AUDIO OUT jacks on the VCR and the AUDIO jacks on the TV.

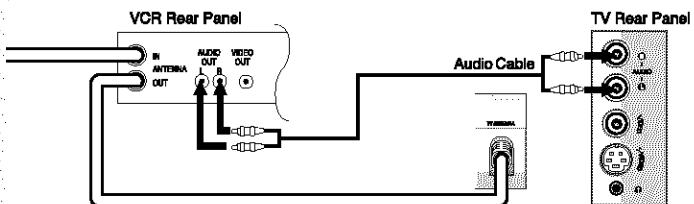

If you have a "mono" (non-stereo) VCR, use the Y-connector (not supplied) to hook up to the left and right audio input jacks of the TV. If your VCR is stereo, you must connect two cables.

5

Connect a video cable between the VIDEO OUT jack on the VCR and the VIDEO jack on the TV.

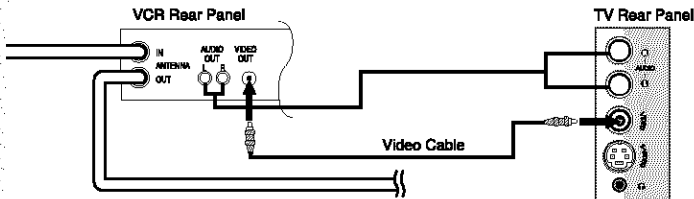

Follow the instructions in "Viewing a VCR or Camcorder Tape" to view your VCR tape.

INSTALLATION

Connecting an S-VHS VCR

Your Samsung TV can be connected to an S-Video signal from an S-VHS VCR. (This connection delivers a better picture as compared to a standard VHS VCR.)

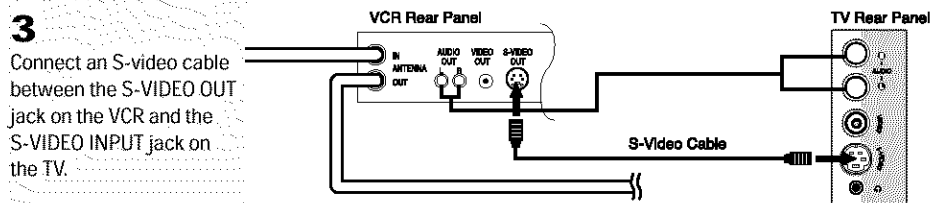
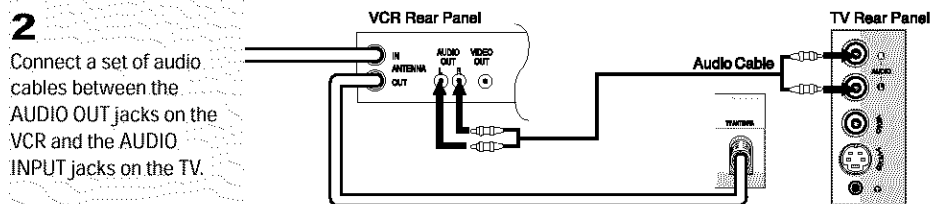
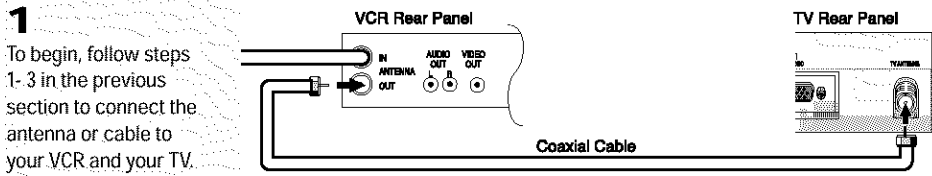

An S-video cable is usually included with an S-VHS VCR. (If not, check your local electronics store.)

INSTALLATION

Connecting a DVD Player

The rear panel jacks on your TV make it easy to connect a DVD player to your TV.

1

Connect a set of audio cables between the L, R AUDIO INPUT jacks on the TV and the AUDIO OUT jacks on the DVD player.

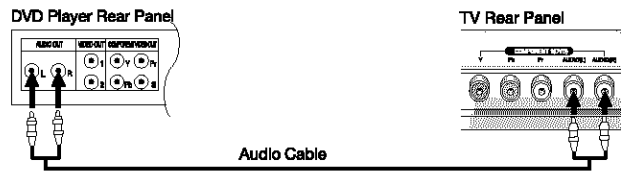

2

Connect a video cable between the COMPONENT1 (Y, Pb, Pr) jacks on the TV and the Y, Pb, Pr jacks on the DVD player.

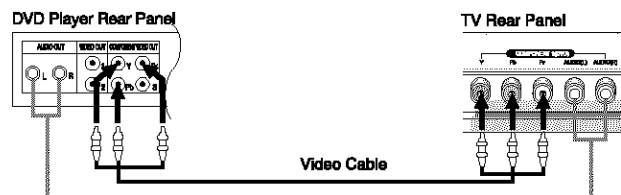

Note: For an explanation of Component video, see your DVD player owner's manual.

Connecting a Digital TV Set-Top Box

The connections for a typical set-top box are shown below.

1

Connect a set of audio cables between the L, R COMPONENT2 AUDIO INPUT jacks on the TV and the AUDIO OUT jacks on the Set-Top Box.



2

Connect a video cable between the COMPONENT2 (Y, Pb, Pr) jacks on the TV and the Y, Pb, Pr jacks on the Set-Top Box.

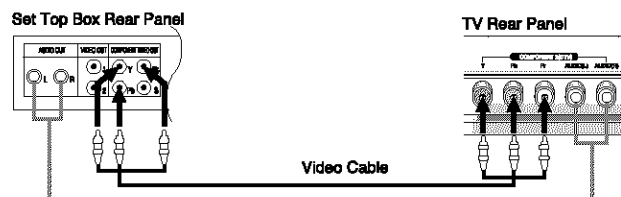

Note: For an explanation of Component video, see your Set-Top Box owner's manual.

INSTALLATION

Connecting a Camcorder

The side panel jacks on your TV make it easy to connect a camcorder to your TV. They allow you to view the camcorder tapes without using a VCR. (Also see “Viewing a VCR or Camcorder Tape” on page 3.17)

- 1** Locate the A/V output jacks on the camcorder. They are usually found on the side or back of the camcorder.

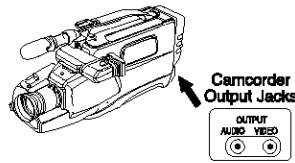

- 2** Connect an audio cable between the AUDIO OUTPUT jack on the camcorder and the AUDIO terminals on the side of the TV.

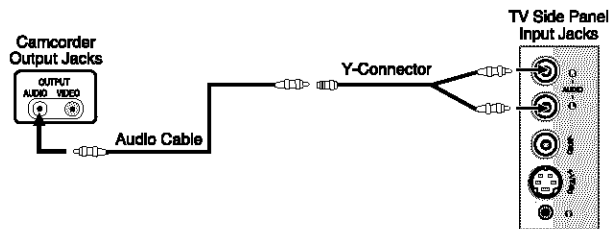

- 3** Connect a video cable between the VIDEO OUTPUT jack on the camcorder and the VIDEO terminal on the side of the TV.

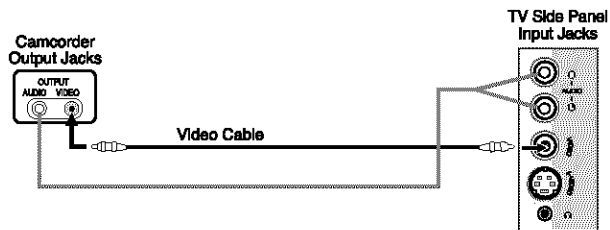

The audio-video cables shown here are usually included with a Camcorder. (If not, check your local electronics store.) If your camcorder is stereo, you need to connect a set of two cables.

Installing Batteries in the Remote Control

1

Slide the cover out completely.

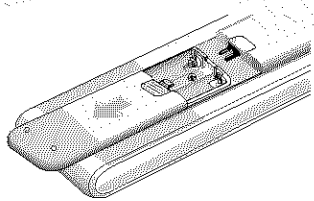

2

Install two AAA size batteries.

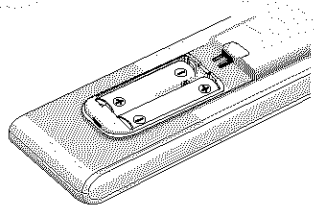

◀ Make sure to match the “+” and “-” ends of the batteries with the diagram inside the compartment.

3

Replace the cover.

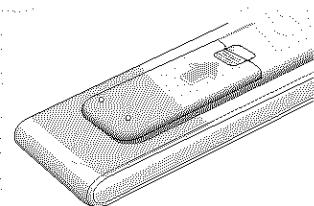

◀ Remove the batteries and store them in a cool, dry place if you won't be using the remote control for a long time.

The remote control can be used up to about 23 feet from the TV.

(Assuming typical TV usage, the batteries last for about one year.)

Chapter Three

OPERATION

Turning the TV On and Off

Press the **POWER** button.

You can also use the Power button on the front panel.

Plug & Play Feature

When the TV is initially powered On, two basic customer settings proceed automatically and subsequently: Setting Auto program, Clock.

1

Press the **POWER** button on the remote control.

The message "Plug & Play" is displayed. It flickers for a little while, then the "Language" menu is automatically displayed.

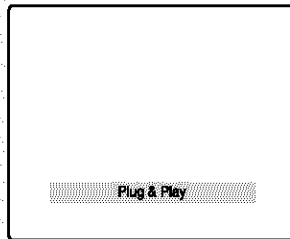

2

Press the **VOL+** or **VOL-** button to select the desired language. Press the **MENU** button to enter the language, and then the "Time" menu is automatically displayed.

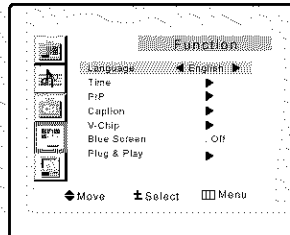

3

Press the **VOL+** or **VOL-** buttons to move to the hour or minute. Set the hour or minute by pressing the **CH▲** or **CH▼** buttons. (refer to "Setting the clock" on page 3.10.)

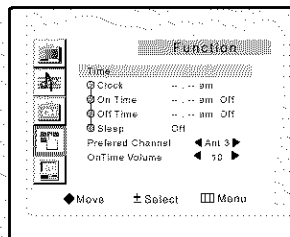

OPERATION

4

Press the **VOL+** or **VOL-** button to select the desired video signal source.

Press the **MENU** button to enter the video signal source, and then the "Ant Input check" is automatically displayed.

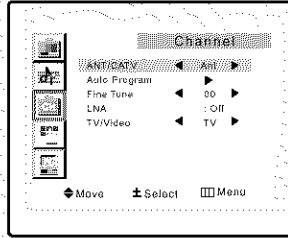

5

Make sure that the antenna is connected to the TV. Press the **VOL+** or **VOL-** button to activate "Auto Program" or press the **MENU** button to skip. (refer to "Auto program" on page 3.6.)

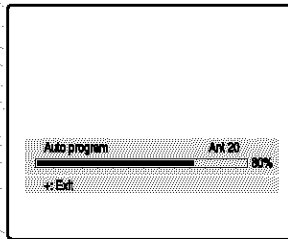

6

The message "Enjoy your watching." is displayed.

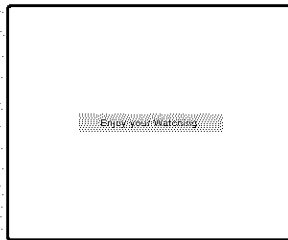

7

If you want to reset this feature

- (1) Press the **MENU** button.
- (2) Press the **CH▼** button to highlight the Function menu and press the **VOL+** button.
- (3) Press the **CH▼** button to select Plug & Play and press the **VOL+** button. The message "Plug & Play" is displayed.

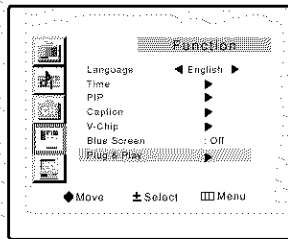

Viewing the Menus and On-Screen Displays

Viewing the Menus

1

With the power on, press the **MENU** button.

The main menu appears on the screen. Its left side has five icons: Picture, Sound, Channel, Function and PC.

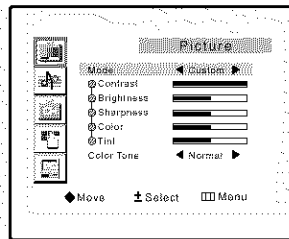

◀ The on-screen menus disappear from the screen after about thirty seconds.

2

Use the **CH▲** and **CH▼** buttons to select one of the 5 icons. Then press **VOL+** to access the icon's sub-menu.

3

Press the **MENU** button to exit.

◀ You can also use the **MENU**, **CHANNEL**, and **VOLUME** buttons on the control panel of the TV to make selections.

Viewing the Display

The display identifies the current channel and the status of certain audio-video settings.

1

Press the **Display** button on the remote control.

The TV will display the channel, the type of sound, and the status of certain picture and sound settings.

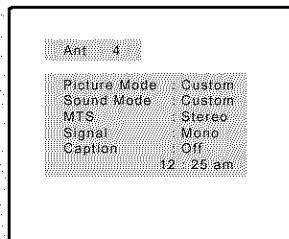

◀ The on-screen displays disappear after about ten seconds.

Selecting a Menu Language

1

Press the **MENU** button to display the menu.

Press the **CH ▼** button to select "Function", then press the **VOL +** button.

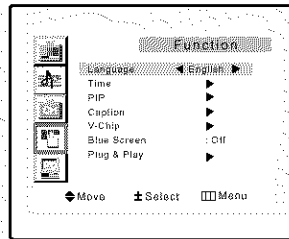

2

Press the **CH ▼** button to select Language.

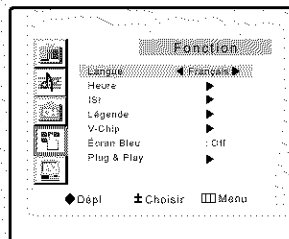

3

Press the **VOL +** button to select the appropriate language: English, Spanish, or French.

4

Press the **MENU** button to exit.

Memorizing the Channels

Your TV can memorize and store all of the available channels for both “off-air” (antenna) and cable channels. After the available channels are memorized, use the CH ▲ and CH ▼ buttons to scan through the channels. This eliminates the need to change channels by entering the channel digits. There are three steps for memorizing channels: selecting a broadcast source, memorizing the channels (automatic) and adding and deleting channels (manual).

Selecting the Video Signal-source

Before your television can begin memorizing the available channels, you must specify the type of signal source that is connected to the TV (i.e., an antenna or a cable system).

1
Press the **MENU** button to display the menu.

Press the **CH ▼** button to select “Channel”, then press the **VOL +** button.

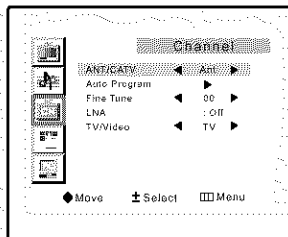

2
Repeatedly press the **VOL +** button to cycle through these choices: ANT (antenna), STD, HRC or IRC (all cable TV).

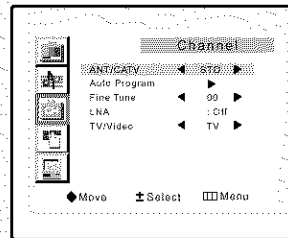

Note: STD, HRC and IRC identify various types of cable TV systems. Contact your local cable company to identify the type of cable system that exists in your particular area.

At this point the signal source has been selected. Proceed to “Storing Channels in Memory” (next page).

OPERATION

Storing Channels in Memory (Automatic Method)

1

First, select the correct signal source (ANT, STD, HRC, IRC). See steps 1-4 on previous page.

Press the **MENU** button.

Press the **CH ▼** button to select "Channel", then press the **VOL +** button.

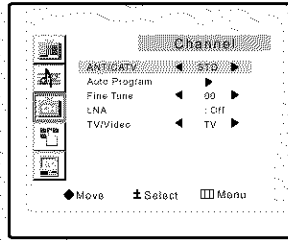

2

Press the **CH ▼** button to select the "Auto program".

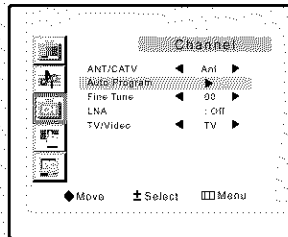

3

Press the **VOL +** button. The TV will begin memorizing all of the available channels.

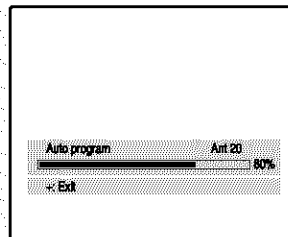

4

After all the available channels are stored, the Auto program menu reappears. Press the **MENU** button to exit.

◀ The TV automatically cycles through all of the available channels and stores them in memory. This takes about one to two minutes. Press VOL+ at any time to interrupt the memorization process and return to the CHANNEL menu.

Adding and Erasing Channels (Manual Method)

1

Use the number buttons to directly select the channel that will be added or erased.

2

Press the **ADD/ERASE** button.

Repeatedly pressing this button will alternate between "Added" and "Erased."

You can view any channel (including an erased channel) by using the number buttons on the remote control.

Changing Channels

Using the Channel Buttons

1

Press the **CH ▲** or **CH ▼** buttons to change channels.

When you press the **CH ▲** or **CH ▼** buttons, the TV changes channels in sequence. You will see all the channels that the TV has memorized. (The TV must have memorized at least three channels.) You will not see channels that were either erased or not memorized.

Directly Accessing Channels

Use the number buttons to quickly tune to any channel.

1

Press the number buttons to go directly to a channel.

For example, to select channel 27, press "2," then "7." The TV will change channels when you press the second number.

When you use the number buttons, you can directly select channels that were either erased or not memorized.

To select a channel over 100, press the +100 button. (For channel 122, press "+100," then "2," then "2.")

To change to single-digit channels (0-9) faster, press "0" before the single digit. (For channel "4," press "0," then "4.")

Using the Pre-CH Button to select the Previous Channel

1

Press the **PRE-CH** button.

The TV will switch to the last channel viewed.

To quickly switch between two channels that are far apart, tune to one channel, then use the number button to select the second channel. Then, use the **PRE-CH** button to quickly alternate between them.

Adjusting the Volume

1

Press the **VOL +** or **VOL -** buttons to increase or decrease the volume.

Using Mute

At any time, you can temporarily cut off the sound using the Mute button.

1

Press **MUTE** and the sound cuts off.

The word "Mute" will appear in the lower-left corner of the screen.

2

To turn mute off, press the **MUTE** button again, or simply press either the **VOL +** or **VOL -** button.

Setting the Clock

Setting the clock is necessary in order to use the various timer features of the TV. Also, you can check the time while watching the TV. (Just press DISPLAY.)

1

Press the **MENU** button to display the on-screen menu.

Press the **CH ▼** button three times to select "Function", then press the **VOL +** button.

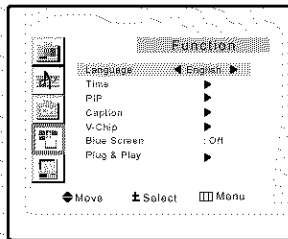

2

Press the **CH ▼** button to select "Time", then press the **VOL +** button.

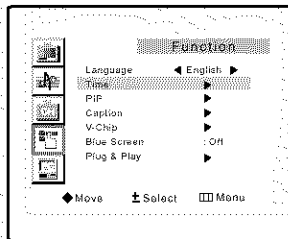

3

Press the **VOL +** button. Press the **CH ▲** or **CH ▼** buttons repeatedly until the correct hour appears.

After the hour is entered, press the **VOL +** button.

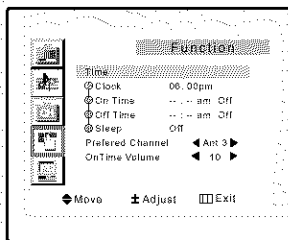

4

Press the **VOL +** button again. Press the **CH ▲** or **CH ▼** buttons repeatedly until the correct minutes appear.

After the minutes are entered, press the **VOL +** button.

Press the **MENU** button to exit.

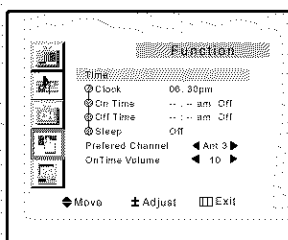

◀ When selecting the hours, be sure to select the proper time of day (AM or PM).

You can change the hours by pressing the **CH ▲** or **CH ▼** buttons repeatedly (or by holding down either of these buttons).

The time will appear every time you press the Display button.

Customizing the Picture

You can use the on-screen menus to change the contrast, brightness, sharpness, color and tint according to personal preference. (Alternatively, you can use one of the "automatic" settings. See next page.)

1

Press the **MENU** button to display the menu.

Press the **VOL +** button to display the Picture menu.

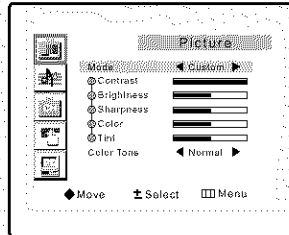

2

Press the **CH ▼** or **CH ▲** buttons to select a particular item.

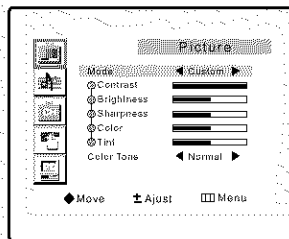

◀ The customer can select "Normal", "Warm", or "Cool" according to personal preference.

3

Press the **VOL +** or **VOL -** buttons to increase or decrease the value of a particular item. For example, if you select "Contrast," pressing **VOL +** increases it.

Press the **MENU** button to exit.

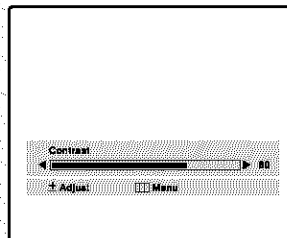

Using Automatic Picture Settings

Your TV has two automatic picture settings (“Standard”, “Mild” and “Dynamic”) that are preset at the factory. You can activate either Standard, Mild or Dynamic by pressing P.STD (or by making a selection from the menu). Or, you can select “Custom” which automatically recalls your personalized picture settings.

1

Press the **MENU** button to display the menu.

Press the **VOL +** button to display the Picture menu.

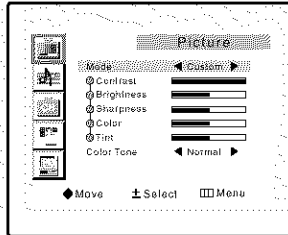

2

Press the **VOL +** or **VOL -** buttons to select the "Standard," "Mild," "Dynamic" or "Custom" picture setting.

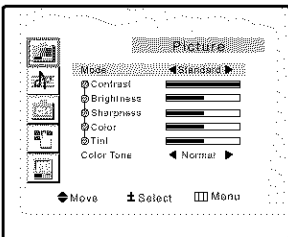

Alternate method:

Simply press the **P.STD** button on the remote control to select one of the standard picture settings.

- Choose *Standard* for the standard factory settings.
- Choose *Mild* ("Mild Contrast") when viewing the TV in low light, or when playing video games.
- Choose *Dynamic* to increase the clarity and sharpness of the picture.
- Choose *Custom* if you want to adjust the settings according to personal preference (see "Customizing the Picture, page 3.10).

Customizing the Sound

The sound settings can be adjusted to suit your personal preference. (Alternatively, you can use one of the “automatic” settings. See next page.)

1

Press the **MENU** button to display the menu.

Press the **CH ▼** button to select “Sound”, then press the **VOL+** button.

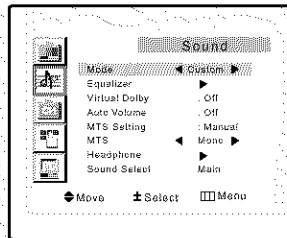

2

Press the **CH ▼** button to select “Equalizer”, then press the **VOL+** button.

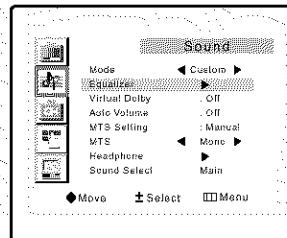

3

Press the **VOL -** or **VOL +** buttons to select a particular item to be changed.

Press the **CH ▼** or **CH ▲** buttons to increase or decrease the value of a particular item.

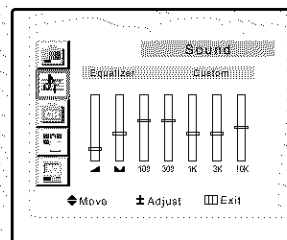

Press the **MENU** button to exit.

Using Automatic Sound Settings

Your TV has four automatic sound settings ("Standard," "Music," "Movie" and "Speech") that are preset at the factory. You can activate any of them by pressing the S.STD button (or by making a selection from the on-screen menu). Or, you can select "Equalizer," which automatically recalls your personalized sound settings.

1

Press the **MENU** button to display the menu.

Press the **CH ▼** button to select "Sound", then press the **VOL+** button.

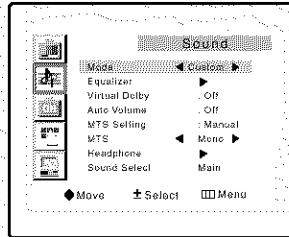

2

Press the **VOL +** or **VOL -** buttons repeatedly to select the "Standard," "Music," "Movie," "Speech" or "Custom" sound settings.

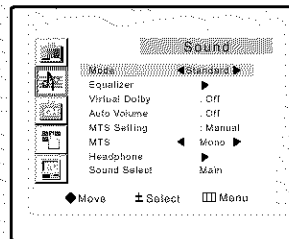

Alternate method:

Simply press the the **S.STD** button on the remote control to select one of the standard sound settings.

- Choose *Standard* for the standard factory settings.
- Choose *Music* when watching music videos or concerts.
- Choose *Movie* when watching movies.
- Choose *Speech* when watching a show that is mostly dialogue (i.e., news).
- Choose *Custom* to recall your personalized settings.

Viewing a VCR or Camcorder Tape

You must select the appropriate mode in order to view the VCR or Camcorder signal on the TV.

1
Press the **MENU** button to display the menu.

Press the **CH ▼** button to select "Channel", then press the **VOL+** button.

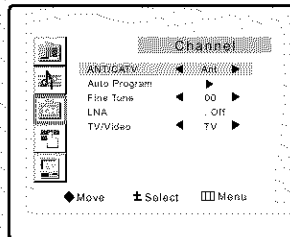

◀ Quick way to access the external signal: Simply press the TV/VIDEO button on the remote control.

2
Press the **CH ▼** button to select "TV/Video".

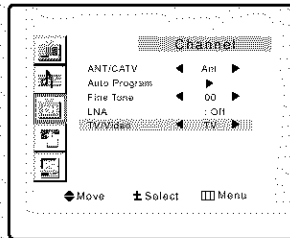

3
Press the **VOL+** or **VOL-** button.
You will switch between viewing the signals coming from equipment connected to the TV's A/V jacks, and the TV signal.

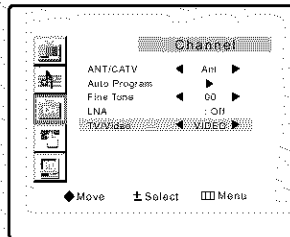

Chapter Four

SPECIAL FEATURES

Fine Tuning Channels

Use fine tuning to manually adjust a particular channel for optimal reception.

1

Select the appropriate channel.

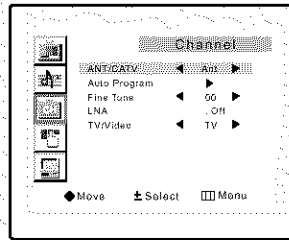

2

Press the **MENU** button to display the menu.

Press the **CH ▼** button twice to select "Channel", then press the **VOL +** button.

3

Press the **CH ▼** button to select "Fine Tune."

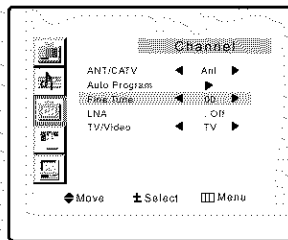

4

Press the **VOL +** and **VOL -** buttons to adjust the fine tuning.

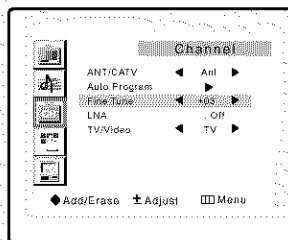

5

To store the fine tuning setting in the TV's memory, press the **CH ▲** button. (A heart icon will appear.)

To reset the fine tuning to "00," press the **CH ▼** button.

Press the **MENU** button to exit.

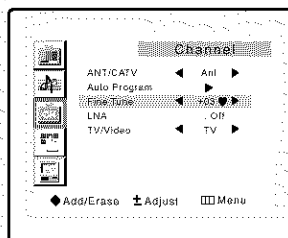

◀ After you adjust the fine tuning, the "heart icon" will appear when you press Display while watching this channel.

LNA (Low Noise Amplifier)

If the TV is operating in a weak-signal area, sometimes the LNA function can improve the reception (a low-noise preamplifier boosts the incoming signal).

1

Press the **MENU** button to display the menu.

Press the **CH ▼** button to select "Channel", then press the **VOL +** button.

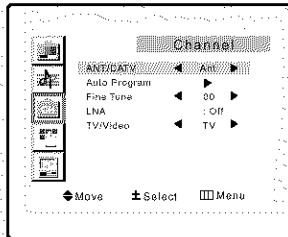

2

Press the **CH ▼** button to select "LNA."

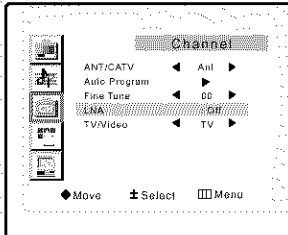

3

Press the **VOL +** or **VOL -** button to set LNA "On."

Press the **MENU** button to exit.

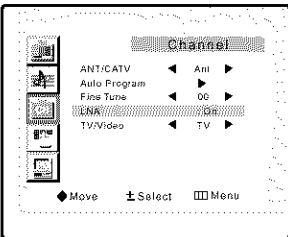

◀ Pressing **VOL -** or **VOL +** will alternate between "On" and "Off."

Setting the Blue Screen Mode

If no signal is being received or the signal is very weak, a blue screen automatically replaces the noisy picture background.

If you wish to continue viewing the poor picture, you must set the "Blue screen" mode to "Off".

1

Press the **MENU** button to display the menu.

Press the **CH ▾** button to select "Function", then press the **VOL +** button.

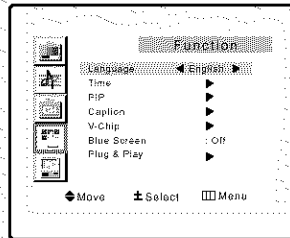

2

Press the **CH ▾** button to select "Blue Screen."

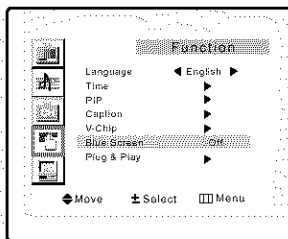

3

Press the **VOL +** or **VOL -** buttons to set Blue Screen "On".

Press the **MENU** button to exit.

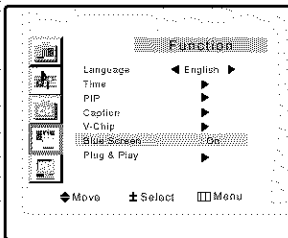

◀ Pressing the VOL- or VOL+ buttons will alternate between "On" and "Off".

Changing the Screen Size

1

Press the **P.SIZE** button to change the screen size.

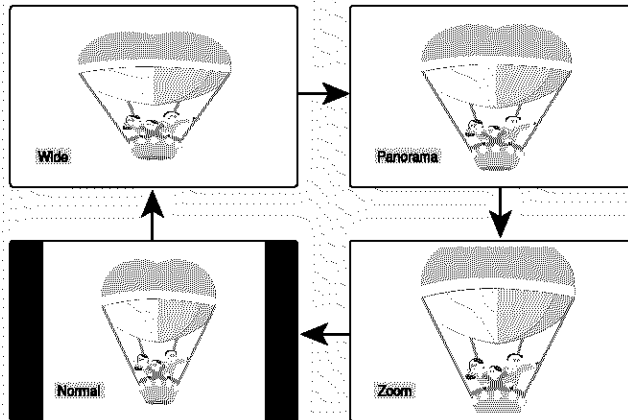

- Wide: Sets the picture to 16:9 wide mode.
- Panorama : Use this mode for the wide aspect ratio of a panoramic picture.
- Zoom: Magnifies the size of the picture on screen.
- Normal: Sets the picture to 4:3 normal mode.
This is a standard TV screen size.

Freezing the Picture

1

Press the **STILL** button to freeze a moving picture.
(Normal sound will still be heard.)

Press again to cancel.

Special Sound Options

Choosing a Multi-Channel Sound (MTS) Soundtrack

Depending on the particular program being broadcast, you can listen to stereo, mono, or a Separate Audio Program. (SAP audio is usually a foreign-language translation. Sometimes SAP has unrelated information like news or weather.)

1
Press the **MENU** button to display the menu.

Press the **CH▼** button to select "Sound", then press the **VOL +** button

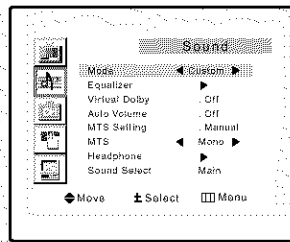

2
Press the **CH▼** button three times to select "MTS".

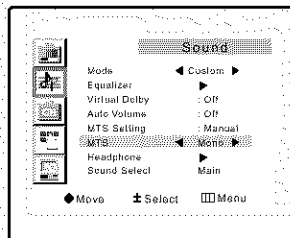

3
Press the **VOL +** button repeatedly to select "Mono," "SAP," or "Stereo."

Press the **MENU** button to exit

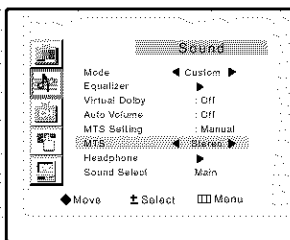

◀ The text at the bottom of the menu tells you if the incoming audio is stereo, SAP, or mono.

- Choose *Stereo* for channels that are broadcasting in stereo.
- Choose *Mono* for channels that are broadcasting in mono, or if you are having difficulty receiving a stereo signal.
- Choose *SAP* to listen to the Separate Audio Program, which is usually a foreign-language translation.

You can also change the MTS setting by pressing the "MTS" button on the remote control. (When you change channels, MTS is set to "Stereo" automatically. To listen in 'SAP' or 'Mono,' change the MTS setting.)

SPECIAL FEATURES

Auto Volume

Each broadcasting station has its own signal conditions, and it is inconvenient to adjust the volume every time the channel is changed. "Auto volume" automatically adjusts the volume of the desired channel by lowering the sound output when the modulation signal is high or by raising the sound output when the modulation signal is low.

1

Press the **MENU** button to display the menu.

Press the **CH▼** button to select "Sound", then press the **VOL +** button

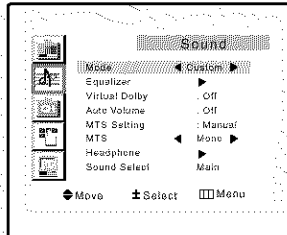

2

Press the **CH▼** button to select "Auto volume".

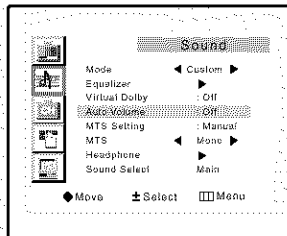

3

Press the **VOL +** button to select "On".

Press the **MENU** button to exit.

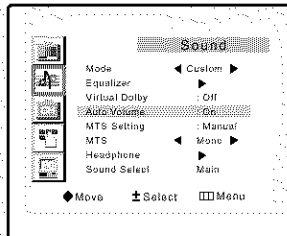

◀ Pressing **VOL -** or **VOL +** will alternate between "On" and "Off."

SPECIAL FEATURES

Virtual Dolby

This feature allows the TV's L/R speakers to provide a home Theater-like Dolby effect. The center and surround sounds are mixed into the L/R speakers.

1

Press the **MENU** button to display the menu.

Press the **CH▼** button to select "Sound", then press the **VOL +** button

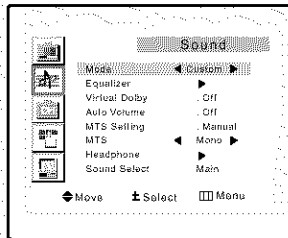

◀ Quick way to access the Virtual Dolby menu: Simply press the **V.DOLBY** button on the remote control.

2

Press the **CH▼** button to select "Virtual Dolby".

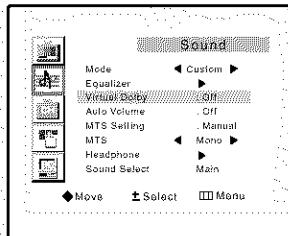

3

Press the **VOL +** button to select "On".

Press the **MENU** button to exit.

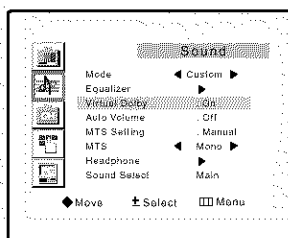

◀ Pressing **VOL -** or **VOL +** will alternate between "On" and "Off."

Adjusting the Headphone Sound

The headphone option is especially useful when simultaneously watching the main screen and the PIP window.

1

Press the **MENU** button to display the menu.

Press the **CH▼** button to select "Sound", then press the **VOL +** button

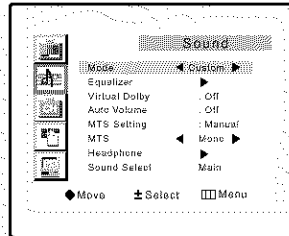

◀ Note: Headphones must be purchased separately.

2

Press the **CH▼** button to select "Headphone" and press the **VOL+** button.

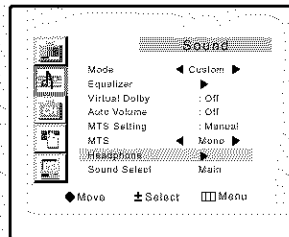

3

Press the **CH▲** or **CH▼** button to select the particular item to be changed.

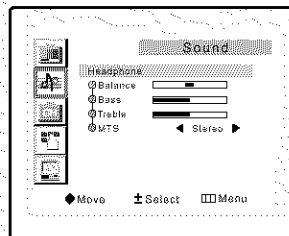

◀ Note: When you want to listen to TV with headphones only, press the MUTE or VOL- button on the remote control to set the TV speaker volume to zero(0).

4

Press the **VOL+** or **VOL-** buttons to increase or decrease the value of a particular item.

Press the **MENU** button to exit.

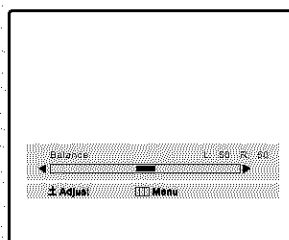

SPECIAL FEATURES

Selecting the Headphone Sound

You can select either Main or Sub when PIP is On.

1

Press the **MENU** button to display the menu.

Press the **CH▼** button to select "Sound", then press the **VOL +** button

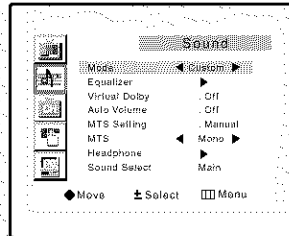

2

Press the **CH▼** button to select "Sound Select".

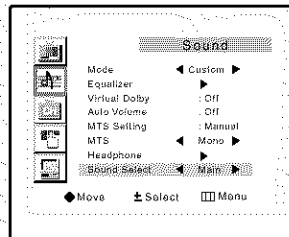

3

Press the **VOL +** button to select "Main" or "Sub".

Select "Main" to hear the main TV sound and select "Sub" to hear the PIP window sound.

Press the **MENU** button to exit.

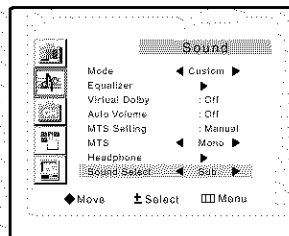

◀ Note: Sound Select can also be used to select the Main or Sub sound over the speakers.

Setting the On/Off Timer

1

Press the **MENU** button to display the on-screen menu.

Press the **CH ▼** button three times to select "Function", then press the **VOL +** button.

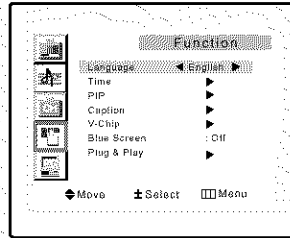

◀ Before using the timer, you must set the TV's clock. (See "Setting the Clock" on page 3.9)

2

Press the **CH ▼** button to select the "Time", then press the **VOL +** button.

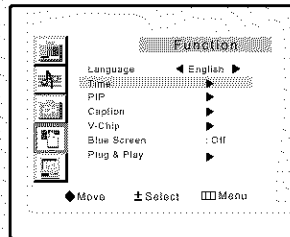

3

Press the **CH ▼** button to select "On time", then press the **VOL +** button.

Press the **CH ▲** or **CH ▼** buttons repeatedly to select the appropriate hours (i.e., the hour when the TV will turn on.)

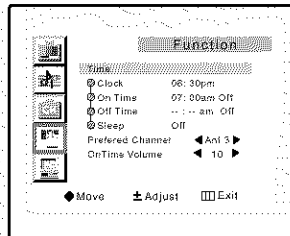

◀ When you set the hours, make sure the correct time of day (AM or PM) appears to the left of the hour.

4

Press the **VOL +** button to select the "On time" minutes.

Press the **CH ▲** or **CH ▼** buttons repeatedly to select the appropriate minutes.

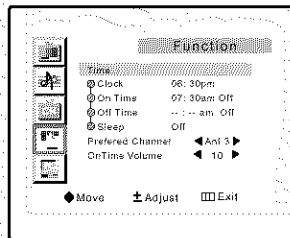

continued...

SPECIAL FEATURES

5

Press the **VOL +** button to select "On/Off."

Press the **CH ▲** or **CH ▼** buttons to turn the on-timer "On." (Repeatedly pressing the **CH ▲** or **CH ▼** buttons will alternate between on and off.)

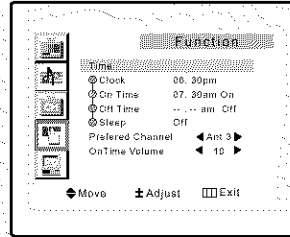

When finished, press the **VOL +** button.

◀ To deactivate the "On time," select "Off" during this step.

6

To set the Off time, press the **CH ▼** button to select "Off time."

Press the **VOL +** button and set the hours and minutes. (Follow the same procedure as in steps 1-5 above.)

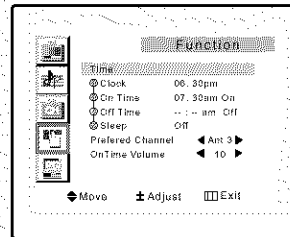

7

When finished setting the timer, press the **MENU** button to exit.

Setting the Sleep Timer

The sleep timer automatically shuts off the TV after a preset time (from 10 to 180 minutes).

1

Press the **SLEEP** button on the remote control.

2

Press **SLEEP** repeatedly until the appropriate time interval appears (any of the preset values from "Off" to "360").

◀ After about 5 seconds, the sleep display will disappear from the screen, and the time interval will be set.

Viewing Closed Captions

Your TV decodes and displays the closed captions that are broadcast with certain TV shows. These captions are usually subtitles for the hearing impaired or foreign-language translations. All VCRs record the closed caption signal from television programs, so home-recorded video tapes also provide closed captions. Most pre-recorded commercial video tapes provide closed captions as well. Check for the closed caption symbol in your television schedule and on the tape's packaging: **CC**.

Note: The Caption feature does not work with DVD or DTV signals.

1
Press the **MENU** button to display the menu.

Press the **CH ▾** button to select "Function", then press the **VOL+** button.

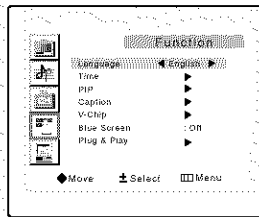

◀ Quick way to access the Caption menu: Simply press the **CAPTION** button on the remote control.

2
Press the **CH ▾** button to select "Caption", then press the **VOL+** button.

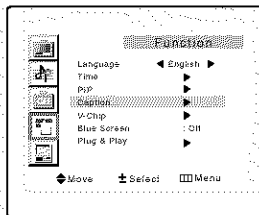

3
Press the **VOL+** or **VOL-** buttons to turn closed captioning on/off.

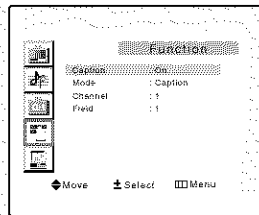

4
Press the **CH ▾** button to select "Mode."

Press the **VOL +** or **VOL -** buttons to select "Caption" or "Text."

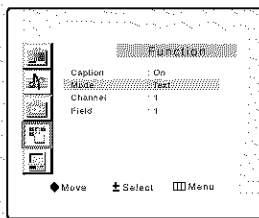

5
Depending on the particular broadcast, it might be necessary to make changes to "Channels" and "Field":
Use the **CH ▲**, **CH ▾**, **VOL +** and **VOL -** buttons to make the changes. (Follow the same procedure as in steps 3-4 above.)
Press the **MENU** button to exit.

◀ Different channels and fields display different information: Field 2 carries additional information that supplements the information in Field 1. (For example, Channel 1 may have subtitles in English, while Channel 2 has subtitles in Spanish.)

Viewing Picture-in-Picture

You can use the PIP feature to simultaneously watch two video sources.

Activating Picture-in-Picture

1

Press the **MENU** button to display the menu.

Press the **CH▼** to select the "PIP", then press the **VOL +** button.

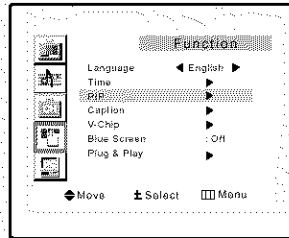

◀ Quick way to access the PIP menu: Simply press the PIP button on the remote control.

2

Press the **VOL +** button to select PIP "On."

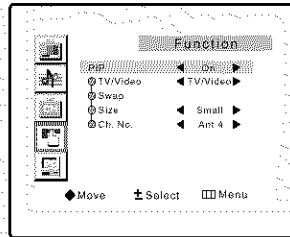

◀ If you turn TV off while watching and turn it on again, the PIP window will disappear.

3

Press the **MENU** button to exit.

Note: Picture-in-Picture does not function when the V-chip is active.

Selecting a Signal Source (External A/V) for PIP

Press the **TV/VIDEO(PIP)** button repeatedly to cycle through all of the available signal sources: "TV," "Video," "S-Video," "DVD" and "DTV".

◀ For more information about external A/V components and signals, see "Viewing a VCR or Camcorder Tape" on page 3.17.

If you select "TV", the PIP image is the same as the main image.

Swapping the Contents of the PIP image and Main image

When you press the **SWAP** button, the image in the PIP window will appear on the main screen, and vice versa.

Changing the PIP Channel

Press the PIP **CH▲** or **CH▼** button to change the channel that appears in the PIP window.

Changing the Location of the PIP Window

When you press the **LOCATE** button repeatedly, the PIP window moves from corner to corner on the TV screen.

Changing the Size of the PIP Window

Press the **SIZE** button to alternate between a smaller and larger PIP window.

Using the V-Chip

The V-Chip feature automatically locks out programming that is deemed inappropriate for children. The user must first enter a PIN (personal ID number) before any of the V-Chip restrictions can be set up or changed.

Setting Up Your Personal ID Number (PIN)

1

Press the **MENU** button to display the menu.

Press the **CH ▾** button to select "Function", then press the **VOL +** button.

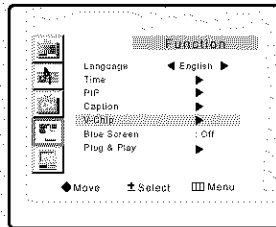

◀ Quick way to access the V.CHIP menu: Simply press the V.CHIP button on the remote control.

2

Press the **CH ▾** button to select "V-chip", then press the **VOL+** button.

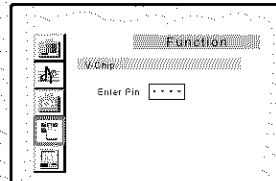

The "Enter Pin" screen will appear. Enter your 4-digit PIN number. Note: The default PIN number for a new TV set is "0-0-0-0."

3

After entering a valid PIN number, the "V-chip" screen will appear. Press the **CH ▾** button to select "Change Pin."

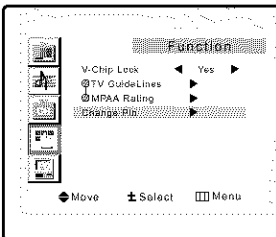

4

Press the **VOL+** button. The Change pin screen will appear. Choose any 4-digits for your PIN and enter them.

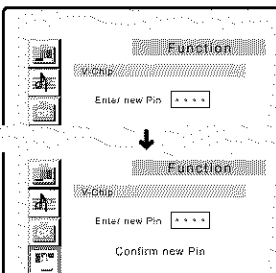

As soon as the 4 digits are entered, the "Confirm new Pin" screen appears. Re-enter the same 4 digits. When the Confirm screen disappears, your PIN has been memorized. Press the **MENU** button to exit.

◀ Note: If you forget the PIN, press the remote-control buttons in the following sequence, which resets the pin to 0-0-0-0:
POWER OFF → MUTE → 8 → 2 → 4 → POWER ON.

SPECIAL FEATURES

How to Enable/Disable the V-Chip

1

Press the **MENU** button to display the menu.

Press the **CH ▾** button to select "Function", then press the **VOL +** button.

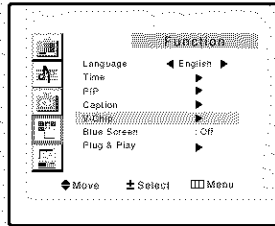

2

Press the **CH ▾** button to select "V-chip", then press the **VOL+** button.

The "Enter pin" screen will appear. Enter your 4-digit PIN number.

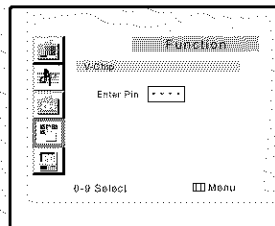

3

The "V-Chip" screen will appear, and "V-Chip lock" will be select.

To enable the V-Chip feature, press the **VOL+** button so that the "V-Chip Lock" is set to Yes.

(Pressing the **VOL+** button will alternate between Yes and No.)

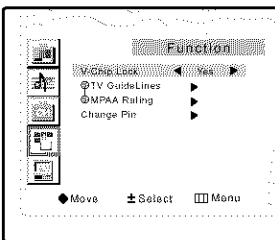

How to Set up Restrictions Using the "TV guidelines"

First, set up a personal identification number (PIN), and enable the V-Chip. (See previous section.) Parental restrictions can be set up using either of two methods: The TV guidelines or the MPAA rating.

1

Press the **MENU** button to display the menu.

Press the **CH ▾** button to select "Function", then press the **VOL +** button.

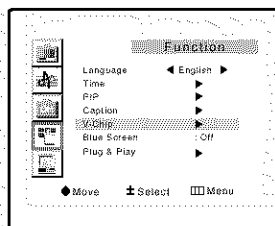

SPECIAL FEATURES

2

Press the **CH ▼** button to select "V-chip", then press the **VOL+** button.

The "Enter pin" screen will appear. Enter your 4-digit PIN number.

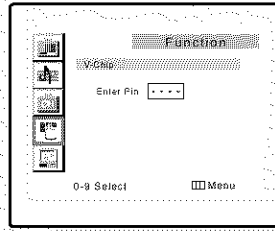

3

Press the **CH ▼** button, to select "TV Guidelines", then press the **VOL+** button.

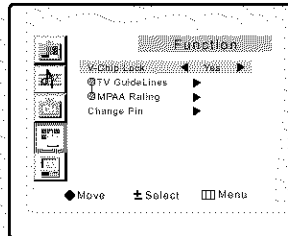

4

The "TV guidelines" screen will appear. Press the **CH ▲**, **CH ▼** buttons to select one of the six age-based categories:

TV-Y Young children
TV-Y7 Children 7 and over

TV-G General audience
TV-PG Parental guidance
TV-14 Viewers 14 and over
TV-MA Mature audience

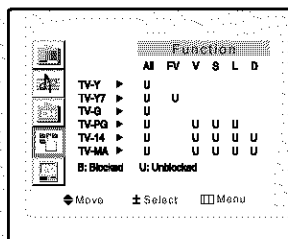

◀ Note: These categories consist of two separate groups: TV-Y and TV-Y7 (young children through age 7), and TV-G through TV-MA (everybody else).

The restrictions for these two groups work independently: If a household includes very young children as well as young adults, the TV guidelines must be set up separately for each age group. (See next step.)

5

At this point, one of the TV-Ratings is selected.

Press the **VOL +** button: Depending on your existing setup, a letter "U" or "B" will start blinking. (U= Unblocked, B= Blocked)

While the "U" or "B" is blinking, press the **CH ▲** or **CH ▼** buttons to block or unblock the category.

Press the **MENU** button once to save the TV guidelines. A TV-Rating will be highlighted, and no letters will blink. To exit this screen, press the **MENU** again. To select a different TV-Rating, press the **CH ▲** or **CH ▼** buttons and then repeat the process.

Note 1: The TV-Y7, TV-PG, TV-14 and TV-MA have additional options. See the next step to change any of the following sub-ratings:

FV: Fantasy violence
D: Sexual suggestive dialog
L: Adult language
S: Sexual situation
V: Violence

Note 2: The V-Chip will automatically block certain categories that are "more restrictive." For example, if you block "TV-Y" category, then TV-Y7 will automatically be blocked. Similarly, if you block the TV-G category, then all the categories in the "young adult" group will be blocked (TV-G, TV-PG, TV-14 and TV-MA). The sub-ratings (D, L, S, V) work together similarly. (See next section.)

SPECIAL FEATURES

6

How to set the FV, D, L, S and V sub-ratings.

First, highlight one of these TV-Ratings: TV-Y7, TV-PG, TV-14 or TV-MA (See Step 4, on previous page). Next, while the TV-Rating is selected, repeatedly press the **VOL+** button. This will cycle through the available sub-ratings (FV, L, S, D or V).

A blinking letter ("U" or "B") will be displayed for each sub-rating. While the "U" or "B" is blinking, press the **CH ▲** or **CH ▼** buttons to change the sub-rating.

Press **MENU** once to save the TV guidelines. A TV-Rating will be selected, and no letters will blink. To exit this screen, press the **MENU** button again. To select a different TV-Rating, press the **CH ▲** or **CH ▼** buttons and then repeat the process.

Note: The V-chip will automatically block certain categories that are "More restrictive". For example, if you block "L" sub-rating in TV-PG, then the "L" sub-ratings in TV-14 and TV-MA will automatically be blocked.

7

Press the **MENU** button three times to clear all the screens. (Or proceed to the next section, and set up additional restrictions based on the MPAA codes).

How to Set up Restrictions using the MPAA Ratings: G, PG-13, R, NC-17, X

The MPAA rating system uses the Motion Picture Association of America (MPAA) system, and its main application is for movies. (Eventually, movie videocassettes will be encoded with MPAA ratings.) When the V-Chip lock is on, the TV will automatically block any programs that are coded with objectionable ratings (either MPAA or TV-Ratings).

1

Press the **MENU** button to display the menu.

Press the **CH ▼** button to select "Function", then press the **VOL +** button.

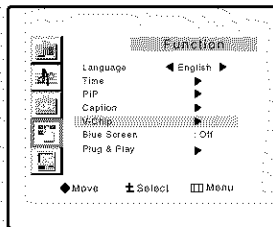

2

Press the **CH ▼** button to select "V-chip", then press the **VOL+** button.

The "Enter pin" screen will appear. Enter your 4-digit PIN number.

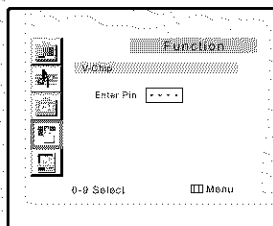

SPECIAL FEATURES

3

Press the **CH ▼** button to select "MPAA rating", then press the **VOL +** button.

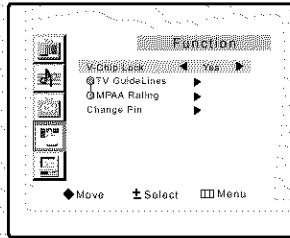

4

Repeatedly press the **CH ▼** button to select a particular MPAA category. (When a category is selected, its color changes to blue.) Pressing the **CH ▼** button will cycle through the MPAA categories:

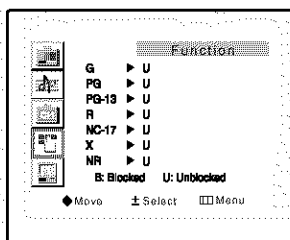

G General audience (no restrictions).

PG Parental guidance suggested.

PG-13 PG-13 (Parents strongly cautioned).

R R (Restricted. Children under 17 should be accompanied by an adult).

NC-17 No children under age 17.

X X (Adults only).

NR Not rated.

While a particular category is highlighted, press the **VOL+** button to activate it. A blinking letter ("U" or "B") will be displayed. Press the **CH ▲** or **CH ▼** buttons to select "U" or "B".

Press the **MENU** button three times to save the settings and to clear all screens.

Note: The V-Chip will automatically block any category that is "more restrictive."

For example, if you block the "PG-13" category, then "R," "NC-17," and "X" will automatically be blocked also.

How to Reset the TV after the V-Chip Blocks a Channel ("Emergency Escape")

If the TV is tuned to a restricted channel, the V-Chip will block it. The screen will go blank and the following message will appear: "Excessive rating."

To resume normal viewing, tune to a different channel using the number buttons. Under certain conditions (depending on the rating of the local TV programs) the V-Chip might lock out all the channels. In this case, use the V.Chip button for an "emergency escape":

Press the V.chip button on the remote control. Enter your PIN number, and press the **VOL +** button to temporarily disable the V-Chip Lock.

Chapter Five

PC DISPLAY

Using Your TV as a Computer (PC) Display

How to Connect Your PC to the TV

Note: This figure shows the Standard Connector-jack panel. The actual configuration on your TV may be different, depending on the model.

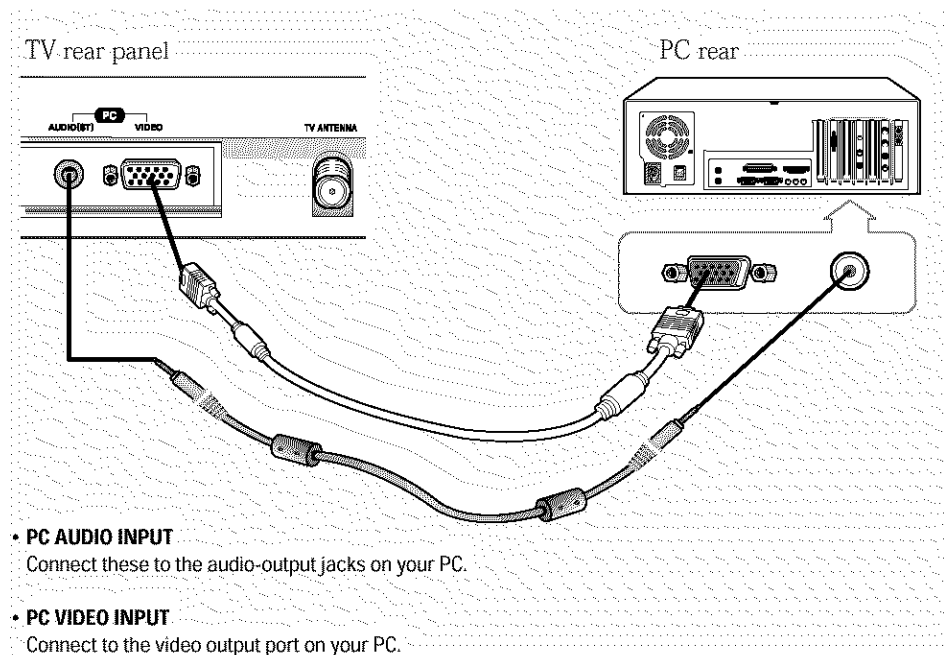

Adjusting the Screen Quality

The purpose of picture quality adjustment is to remove or reduce picture noise. If the noise is not removed by fine tuning alone, then do the frequency adjustments to the utmost and fine tune again. After the noise has been reduced, re-adjust the picture so that it is aligned on the center of screen

Press the PC button on the remote control to select the PC mode

1

Press the **MENU** button to display the menu.

Press the **CH ▾** button to select "PC", then press the **VOL +** button.

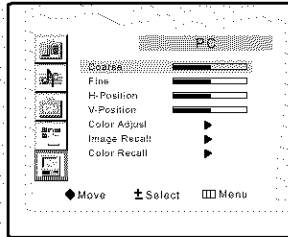

2

Press the **CH ▾** button to select "Coarse" or "Fine".

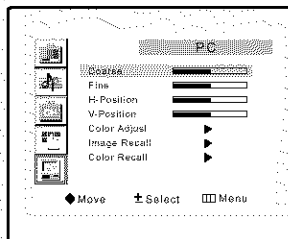

3

Press the **VOL +** or **VOL -** button to adjust the screen quality, vertical stripes appear or the picture may be blurry.

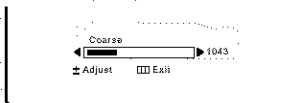

<Adjusting the Coarse>

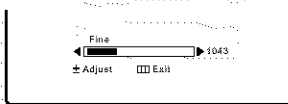

<Adjusting the Fine>

4

When you are satisfied with the settings, press the **MENU** button repeatedly to return to normal viewing.

PC DISPLAY

Changing the Screen Position

Press the PC button on the remote control to select the PC mode

1
Press the **MENU** button to display the menu.

Press the **CH ▾** button to select "PC", then press the **VOL +** button.

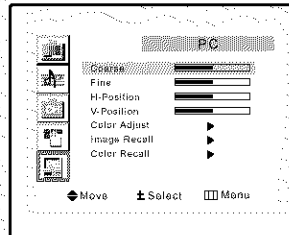

2
Press the **CH ▾** button to select "H-Position" or "V-Position".

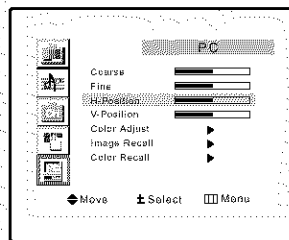

3
Press the **VOL +** or **VOL -** button to adjust the required position.

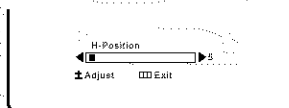

<Adjusting the H-Position>

Press the **MENU** button to exit.

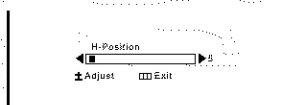

<Adjusting the V-Position>

To Return the Screen Position settings to the default position

Press the **CH ▾** button to select "Image Recall", then press the **VOL +** button to return H and V positions to their default settings.

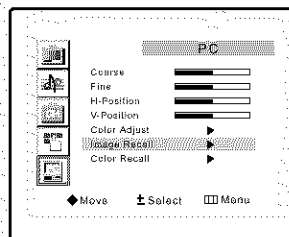

PC DISPLAY

Changing the Screen Color Standard

Press the PC button on the remote control to select the PC mode

- 1** Press the **MENU** button to display the menu.
- Press the **CH ▼** button to select "PC", then press the **VOL +** button.

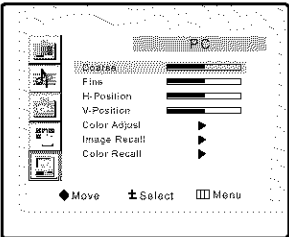

- 2** Press the **CH ▼** button to select "Color Adjust".

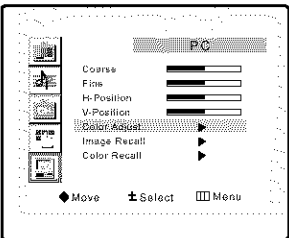

- 3** Press the **VOL +** or **VOL -** buttons to select "Custom", "Color1", "Color2" or "Color3".
- Press the **MENU** button to exit.

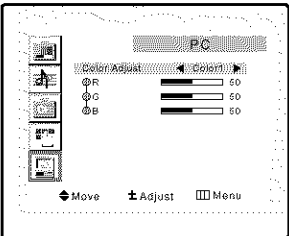

PC DISPLAY

Adjusting the Screen Color Settings

Press the PC button on the remote control to select the PC mode.

1
Press the **MENU** button to display the menu.

Press the **CH ▼** button to select "PC", then press the **VOL +** button.

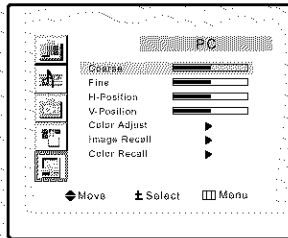

2
Press the **CH ▼** button to select "Color Adjust", then press the **VOL +** button.

Repeatedly press **VOL +** to choose between Color 1, 2, and 3 auto settings and Custom.

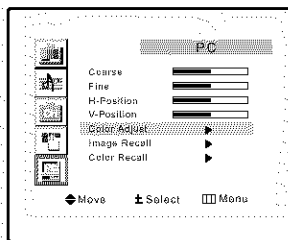

3
If Custom is selected, press the **CH ▼** or **CH ▲** button to select the item you want to adjust, then press the **VOL +** or **VOL -** button to adjust the color (R, G, B).

Press the **MENU** button to exit.

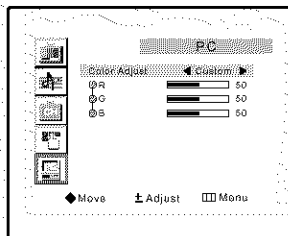

To Return the Custom settings back to the default position

Press the **CH ▼** button to select "Color Recall", then press the **VOL +** button to return R,G,B to their default settings.

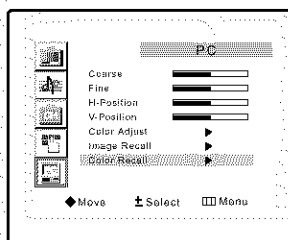

Chapter Six

TROUBLESHOOTING

If the TV seems to have a problem, first try this list of possible problems and solutions. If none of these troubleshooting tips apply, call your nearest service center.

Identifying Problems

Problem	Possible Solution
Poor picture	Try another channel. Adjust the antenna. Check all wire connections.
Poor sound quality.	Try another channel. Adjust the antenna.
No picture or sound.	Try another channel. Press the TV/VIDEO button. Make sure the TV is plugged in. Check the antenna connections.
No color, wrong colors or tints.	Make sure the program is broadcast in color. Adjust the picture settings. If the set is moved or turned in a different direction, the power should be OFF for at least 30 minutes. Adjust the antenna.
Picture rolls vertically.	Check all wire connections.
The TV operates erratically.	Unplug the TV for 30 seconds, then try operating it again.
The TV won't turn on.	Make sure the wall outlet is working.
Blurred or snowy picture, distorted sound	Check the direction, location and connections of your aerial. This interference is often due to the use of an indoor aerial.
Remote control malfunctions	Replace the remote control batteries. Clean the upper edge of the remote control (transmission window). Check the battery terminals.
"Check Signal Cable" message.	Ensure that the signal cable is firmly connected to the PC or video sources. Ensure that the PC or video sources are turned on.

TROUBLESHOOTING

Problem	Possible Solution
"Not Supported Mode!" message.	<p>Check the maximum resolution and the frequency of the video Adapter.</p> <p>Compare these values with the data in the Display Modes Timing Chart.</p>
The image is too light or too dark.	<p>Adjust the Brightness and Contrast.</p> <p>Adjust the Fine function.</p>
Horizontal bars appear to flicker, jitter or shimmer on the image.	Adjust the Coarse function and then adjust the Fine function.
Vertical bars appear to flicker, jitter or shimmer on the image.	<p>The TV is using its power management system.</p> <p>Move the computer's mouse or press a key on the keyboard.</p>
Screen is black and power indicator light blinks steadily.	Check that the display resolution and frequency from your PC or video board is an available mode for your TV. On your computer check: Control Panel, Display, Settings.
Image is not stable and may appear to vibrate.	<p>If the setting is not correct, use your computer utility program to change the display settings.</p> <p>NOTE: Your TV supports multiscan display functions within the following frequency domain:</p> <ul style="list-style-type: none"> • Horizontal frequency: 30 kHz ~ 61 kHz • Vertical frequency: 56 Hz ~ 75 Hz • Maximum refresh rate: 1280 x 768 @ 60 Hz
Image is not centered on the screen.	Adjust the horizontal and vertical position.
You need the Monitor driver software.	Download the driver from WWW pages: http://www.samsungusa.com/monitor

Display Modes

If the signal from the system equals the standard signal mode, the screen is adjusted automatically. If the signal from the system doesn't equal the standard signal mode, adjust the mode by referring to your Videocard user guide; otherwise there may be no video. For the display modes listed below, the screen image has been optimized during manufacture.

Mode	Resolution	Horizontal Frequency (kHz)	Vertical Frequency (Hz)	Pixel Clock Frequency (MHz)	Sync Polarity (H/V)
MAC	640×480	31.469	59.940	25.175	- / -
	640×480	35.000	66.667	30.240	- / -
	800×600	49.726	74.551	57.284	- / -
IBM	720×400	31.469	70.087	28.322	- / +
VESA	640×480	37.861	72.809	31.500	- / -
	640×480	37.500	75.000	31.500	- / -
	800×600	37.879	60.317	40.000	+ / +
	800×600	48.077	72.188	50.000	+ / +
	800×600	46.875	75.000	49.500	+ / +
	1024×768	48.363	60.004	65.000	- / -
	1024×768	56.476	70.069	75.000	- / -
GTF	1024×768	60.023	75.029	78.750	+ / +
	1280×768	47.700	60.000	80.136	- / -

Installing VESA compliant mounting devices

Refer to page A.3 to remove the base.

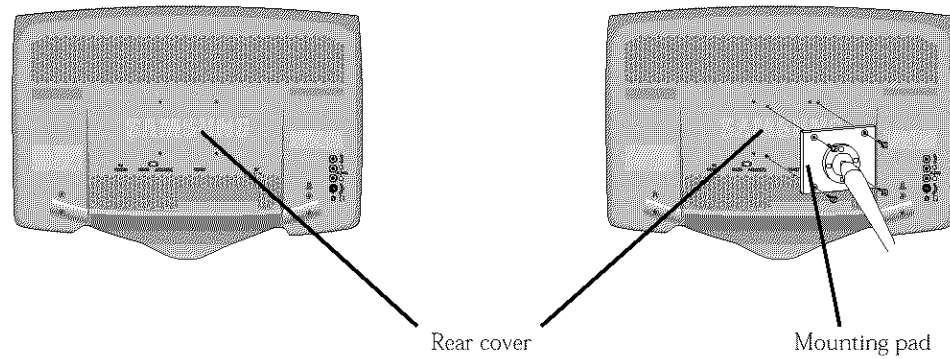

Align the mounting interface pad with the holes in the rear cover mounting pad and secure it with the four screws that come with the arm-type base, wall mount hanger or other bases.

Wall Mount Instructions

The following instructions apply to a hollow sheet-rock wall only. Tools/Hardware needed - Philips screwdriver, four toggle bolts, 5/8in dia. Drill bit and drill. Contact Ergotron at (800) 888-8458 to purchase the triple pivot direct mount adapter and wall mount bracket kit.

- LTM1575 (15") : No. 47 - 007 - 099 (Pivot direct mount adapter)
No. 97 - 101 - 003 (Wall mount bracket kit)
- LTM1775 (17") : No. 47 - 007 - 099 - 02 (Pivot direct mount adapter)
No. 97 - 101 - 003 - 00 (Wall mount bracket kit)

Align the wall mount bracket on the wall at the desired height, making sure that the bracket will be mounted between the wall studs. Mark the four corner openings and drill four 5/8-dia. holes.

Assemble the wall mount kit according to the instructions provided with it. Securely attach Ergotron's flat panel, triple pivot direct mount adapter to the back of the TV using the four 4mm, .7 pitch x 10mm screws provided with the arm. Secure the assembly to the wall using four 3/16 by 3-inch long toggle bolts.

Attaching a Wall or Arm mounting device

The TV supports VESA mounting standard for use with various VESA mounting devices. To install any VESA mounting device, please follow the instructions given.

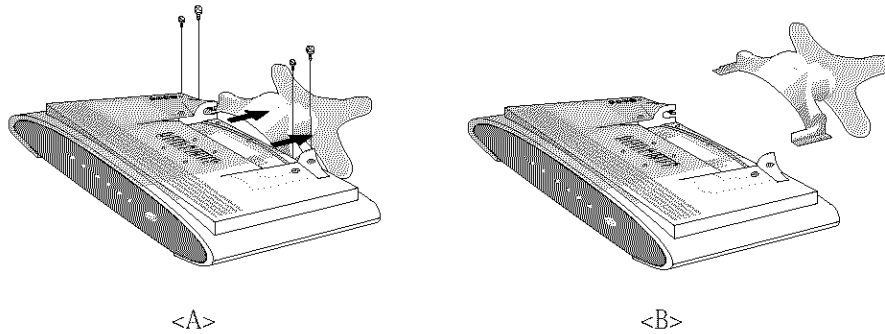

1
Lay the LCD TV face-down on a flat surface with a cushion or other soft materials to protect the screen.

2
Remove all cables connected on the TV.

3
Remove the four screws and then remove the Stand from the LCD TV. (refer to pictures A&B).

4
Re-connect all cables you removed in step 2.

5
Now you are ready to install Wall/Arm mounting device .

Maintenance of Your LCD TV/Monitor

WARNING: To avoid risk of electric shock, do not disassemble the TV cabinet (except for gaining access to the cable connectors as described on page 5). Users cannot service the TV.

User maintenance is restricted to cleaning as explained below:

Unplug the monitor from the power outlet before cleaning.

- To clean your flat panel display screen, lightly dampen a soft, clean cloth with water or mild detergent. If possible, use a special screen cleaning tissue or solution suitable for the antistatic coating.
- To clean the monitor cabinet, use a cloth lightly dampened with a mild detergent.
- Never use flammable cleaning material to clean your LCD TV or any other electrical apparatus.

Retractable Stand

Note: The maximum tilt angle is 15 degrees in the backward direction. Please do not tilt the TV outside the specified range. Using excessive force to tilt the TV/Monitor may cause permanent damage to the mechanical part of the stand.

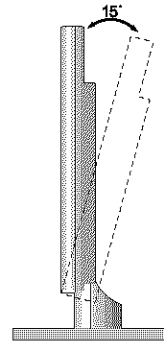
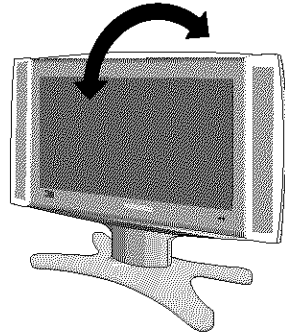

Using the Anti-Theft Kensington Lock

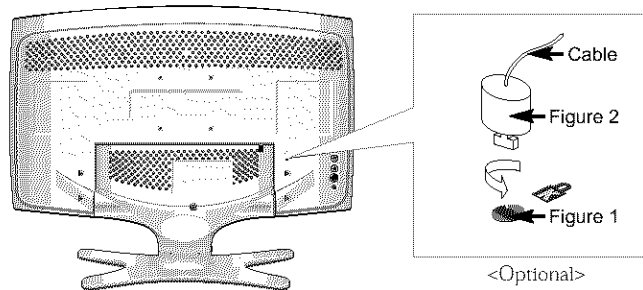

The Kensington lock is a device used to physically fix the system when using it in a public place. The locking device has to be purchased separately. The appearance and locking method may differ from the illustration depending on the manufacturer. Please refer to the manual provided with the Kensington lock for proper use.

- 1**
Insert the locking device into the Kensington slot on the LCD TV (figure 1), and turn it in the locking direction (figure 2).
- 2**
Connect the Kensington lock cable.
- 3**
Fix the Kensington lock to a desk or a heavy stationary object.

APPENDIX

Pin Assignments

Pin D-Sub Connection

Pin	1	2	3	4	5	6	7	8	9	10	11	12	13	14	15
Separate H/V	Red	Green	Blue	GND	GND (DDC Return)	GND -Red	GND -Green	GND- Blue	No Connection	GND-Sync/ Self Test	GND	DDC _SDA	H_Sync	V_Sync	DDC _SCL

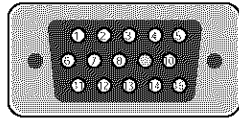

Cleaning and Maintaining Your TV

With proper care, your TV unit will give you many years of service. Please follow these guidelines to get the maximum performance from your TV.

Placement

- Do not place the TV near extremely hot, cold, humid or dusty places.
- Do not place the TV near appliances with electric motors that create magnetic fields, such as vacuum cleaners.
- Keep the ventilation openings clear; do not place the TV on a soft surface, such as cloth or paper.
- Place the TV in a vertical position only.

Liquids

- Do not handle liquids near or on the TV.
Liquids that spill into it can cause serious damage.

Cabinet

- Never open the cabinet or touch the parts inside.
- Wipe your TV with a clean, dry cloth. Never use water, cleaning fluids, wax, or chemicals.
- Do not put heavy objects on top of the cabinet.

Temperature

- If your TV is suddenly moved from a cold to a warm place, unplug the power cord, and allow at least two hours for moisture that may have formed inside the unit to dry completely.

Using Your TV in Another Country

If you plan to take your TV with you to a foreign country, please be aware of the different television systems that are in use around the world. A TV designed for one system may not work properly with another system due to differences in the TV channel frequencies.

APPENDIX

Specifications

		LTM1575W	LTM1775W
Panel	Size Display Size Type Pixel Pitch Viewing Angle	15.0≤ Diagonal 334.08(H) X 200.448(V)mm a-si TFT active matrix 0.261(H) X 0.261(V)mm 75/75/60/60 (L/R/U/D)	17.0≤ Diagonal 370.56(H) X 222.336(V)mm a-si TFT active matrix 0.2895(H) X 0.2895(V)mm 75/75/60/60 (L/R/U/D)
*Frequency	Horizontal Vertical Display Colour	30~61 kHz 56~75 Hz 16,777,216 colours	
Display Resolution	Optimum Mode Maximum Mode	1024 X 768 @ 60 Hz 1280 X 768 @ 60 Hz	
Input Signal	Sync. Video signal	H/V Separate, TTL, P. or N. 0.7 Vp-p @ 75 ohm	
Video	Color system Video system	NTSC CVBS, S-VHS, RGB	
Component	Video In Audio In	1.0 Vp-p @ 75 ohm 500mVrms	
Power Supply	Input Output	AC 90~264 V, 1.3~0.6A (50/60Hz) DC 14V/3.5A	
Power Consumption	Maximum Power Saving	50 W < 1.5 W	53 W < 1.5 W
Dimensions/ Weight	Unit (WxDxH) : TV body	19.61 x 2.13 x 11.61 inch/8.70 lbs (498 x 54 x 295mm/3.95 kg)	21.10 x 21.26 x 12.68 inch/10.58 lbs (536 x 54 x 322 mm/4.8kg)
	With stand	19.61 x 8.03 x 14.72 inch/8.70 lbs (498 x 204 x 374mm/3.95 kg)	19.61 x 8.03 x 15.83 inch/10.58 lbs (536 x 204 x 402 mm/4.8 kg)
Environmental Considerations	Operating Temperature Operating Humidity Storage Temperature Storage Humidity	50 °F to 104 °F (10 °C to 40 °C) 10% to 80% -13 °F to 113 °F (-25 °C to 45 °C) 5% to 95%	
Audio Characteristics	Audio Input 1 Audio Input 2 Headphone out Frequency Response	RCA Jack Red(R) White(L), 0.5Vrms (-9dB) 3.5ø Stereo Jack, 0.5Vrms (-9dB) Max. 10mW Output (3.5ø Stereo Jack 32) RF: 80Hz ~ 15kHz (at- 3dB) A/V: 80Hz ~ 20kHz (at - 3dB)	

* Referring to Preset timing modes, page A.1.



ELECTRONICS

Samsung Electronics America Inc.
105 Challenger Road, Ridgefield Park, N.J. 07660

SERVICE DIVISION
TEL: 1-800-SAMSUNG (1-800-726-7864)
www.samsungsupport.com

BN68-00248E-00(ENG)