

**DVD PLAYER**  
**DVD-L100**

# Notices and Safety Instructions

## Safety Instructions

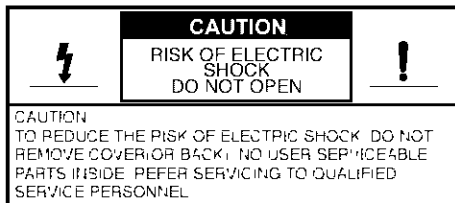

To prevent electric shock, match wide blade of plug to wide slot and fully insert.

### 1 READ INSTRUCTIONS

All the safety and operating instructions should be read before the DVD is operated.

### 2 RETAIN INSTRUCTIONS

The safety and operating instructions should be retained for future reference.

### 3 HEED WARNINGS

All warnings on the DVD and in the operating instructions should be adhered to.

### 4 FOLLOW INSTRUCTIONS

All operating and maintenance instructions should be followed.

### 5 CLEANING

Unplug this DVD from the wall outlet before cleaning.  
Do not use liquid or aerosol cleaners.  
Use a dry cloth used for dusting cabinets.

### 6 ATTACHMENTS

Do not use attachments not recommended by the DVD product manufacturer as they may be hazardous.



This symbol is intended to alert the user to the presence of uninsulated dangerous voltage within the product's enclosure that may be of sufficient magnitude to constitute a risk of fire or electric shock.



This symbol is intended to alert the user to the presence of important operating and maintenance instructions in the literature accompanying this product.

### 7 WATER AND MOISTURE

Do not use this DVD near water for example near a bathtub, wash bowl, kitchen sink, laundry tub, in a wet basement, near a swimming pool or lake.

### 8 ACCESSORIES

Do not place this DVD on an unstable cart, stand, tripod, bracket, or table. The DVD may fall causing serious injury to a child or adult and serious damage to the unit. Use only with a cart, stand, tripod, bracket, or table recommended by the manufacturer or sold with the DVD. Any mounting of the unit should follow the manufacturer's instructions and should use a mounting accessory recommended by the manufacturer.

A. An appliance and cart combination should be moved with care. Quick stops, excessive force, and uneven surfaces may cause the appliance and cart combination to overturn.  
**PORTABLE CART WARNING**  
(Symbol provided by RETAC)



# Notices and Safety Instructions

---

## 9. VENTILATION:

Slots and openings in the cabinet are provided for ventilation to ensure reliable operation of the DVD and to protect it from overheating. These openings must not be blocked or covered.

Never place your DVD on a bed, sofa, rug, or other similar surface: on or near a radiator or heat register.

This DVD should not be placed in a built-in installation such as a bookcase or rack unless proper ventilation is provided or the manufacturer's instructions have been adhered to.

## 10. POWER SOURCES:

The DVD should be operated only from the type of power source indicated on the label.

If you are not sure of the type of power supply at your home, consult your appliance dealer or local power company.

A DVD is intended to be operated from battery power, or other sources, refer to the operating instructions.

## 11. GROUNDING OR POLARIZATION:

This DVD may be equipped with either a polarized 2-wire AC line plug (a plug having one blade wider than the other) or a 3-wire grounding type plug, a plug having a third (grounding) pin.

If you are unable to insert the plug fully into the outlet, try reversing the plug. If the plug still fails to fit, contact your electrician to replace your outlet. Do not defeat the safety purpose of the polarized plug.

## 12. POWER-CORD PROTECTION:

Power-supply cords should be routed so that they are not likely to be walked on or pinched by items placed upon or against them, paying particular attention to cords or plugs, convenient receptacles, and the point where they exit from the unit.

## 13. OUTDOOR ANTENNA GROUNDING:

If an outside antenna or cable system is connected to the DVD, be sure the antenna or cable system is grounded to provide some protection against voltage surges and built-up static charges, Section 810 of the National Electrical Code, ANSI/NFPA No. 70-1984, provides information with respect to proper grounding of the mast and supporting structure, grounding of the lead-in wire and supporting structure, grounding of the mast and supporting structure, grounding of the lead-in wire to an antenna discharge unit, size of grounding to conductors, location of antenna-discharge unit, connection to grounding electrodes and requirements for the grounding electrode.

See figure below.

## 14. LIGHTNING:

For added protection of this DVD during a lightning storm or when it is left unattended and unused for long periods of time, unplug it from the wall outlet and disconnect the antenna or cable system.

This will prevent damage to the DVD due to lightning and power-line surges.

## 15. POWER LINES:

An outside antenna system should not be located in the vicinity of overhead power lines or other electric light or power circuits where it can fall into such power lines or circuits. When installing an outside antenna system, extreme care should be taken to keep from touching such power lines or circuits as contact with them might be fatal.

## 16. OVERLOADING:

Do not overload wall outlets and extension cords as this can result in a risk of fire or electric shock.

# Notices and Safety Instructions

---

## 17 OBJECTS AND LIQUIDS

Never push objects of any kind into this DVD through openings as they may touch dangerous voltage points or short out a part that could result in a fire or electric shock.

Never spill liquids of any kind onto the DVD. Should spillage occur, unplug unit and have it checked by a technician before use.

## 18 SERVICING

Do not attempt to service this DVD yourself. Opening or removing covers may expose you to dangerous voltage or other hazards.

Refer all servicing to qualified service personnel.

## 19 DAMAGE REQUIRING SERVICE

Unplug this DVD from the wall outlet and refer servicing to qualified service personnel under the following conditions:

- a. When the power-supply cord or plug is damaged
- b. If any liquid has been spilled onto or objects have fallen into the DVD
- c. If the DVD has been exposed to rain or water
- d. If the DVD does not operate normally by following the operating instructions, adjust only those controls that are covered by the operating instructions. Improper adjustment of other controls may result in damage and will often require extensive work by a qualified technician to restore the DVD to its normal operation.
- e. If the DVD has been dropped or the cabinet has been damaged
- f. When the DVD exhibits a distinct change in performance, this indicates a need for service.

## 20 REPLACEMENT PARTS

When replacement parts are required, be sure the service technician has used replacement parts specified by the manufacturer and having the same characteristics as the original part.

Unauthorized substitutions may result in fire, electric shock, or other hazards.

## 21 SAFETY CHECK

Upon completion of any service or repairs to this DVD, ask the service technician to perform safety checks to determine that the DVD is in safe operating order.

## Copy Protection

- Many DVD discs are encoded with copy protection. Because of this, you should only connect your DVD player directly to your TV, not to a VCR. Connecting to a VCR results in a distorted picture from copy-protected DVD discs.
- This product incorporates copyright protection technology that is protected by methods, claims of certain U.S. patents and other intellectual property rights owned by Macrovision Corporation and other rights owners. Use of this copyright protection technology must be authorized by Macrovision Corporation, and is intended for home and other limited viewing uses only unless otherwise authorized by Macrovision Corporation. Reverse engineering or disassembly is prohibited.

# Safety Information

---

## Assuring the Finest Performance

This product is designed with the latest technology to provide trouble-free operation. If the pick-up lens or disk drive gets dirty, the video quality will decrease.

## Moisture Condensation

Condensation may form inside this player under following conditions:

- If warm air comes in contact with any cold parts inside the player
- If the player is located in a room with high humidity, and
- If the player is exposed to sudden temperature changes from cold to hot

When condensation forms inside the player, the player may not operate correctly.

If this occurs, leave the player at room temperature until the inside of the player becomes dry and operational.

## Laser Safety

### Caution

This product utilizes a laser. Use of controls or adjustments or performance of procedures other than those specified herein may result in hazardous radiation exposure. Do not open covers and do not look inside the product if interlock mechanism is damaged.

### Warning

Be careful not to damage the interlock mechanism.



# Table of Contents

---

Features .....	8
Accessories .....	9
Disc Type and Characteristics .....	10
Description-Front Panel .....	12
Tour of the Remote Control .....	15
Connecting Headphones to the DVD .....	16
Connecting to an External Component (Input Select) .....	17
Connecting to a TV .....	18
Connecting to a Stereo Component .....	19
Using the AC adapter .....	22
Using the battery pack .....	24
Battery level display .....	25
Loading a DVD Disc .....	26
Using the Remote Control Unit .....	27
Viewing a Video from an External Component .....	28
Using the Search & Skip Functions .....	29
Using the Display Function .....	30
Repeat Play .....	31
Selecting the Audio Language .....	32
Selecting the Subtitle Language .....	33
Changing the Camera Angle .....	34
Using the Bookmark Function .....	35
Using the Zoom & 3D Sound Functions .....	36
MP3 Play .....	37

# Table of Contents

---

Memory Stick .....	39
DAM (Digital Audio Manager) Playback .....	43
Memory Stick Removal .....	44
DPM (Digital Photo Manager) Playback .....	45
Slide Show .....	46
Slide Show Order .....	47
Photo View .....	48
Edit Photo .....	49
Using the Setup Menu .....	50
Setting Up the Language Features .....	51
Setting Up the Parental Control .....	53
Setting Up the Audio Options .....	54
Setting Up the Display Options .....	55
Cautionary Notes .....	56
Troubleshooting .....	61
Specifications .....	64
Warranty .....	65

# Features

---

## Plays DVD discs and audio CDs

- CD-R/RW discs containing MP3 files can be played.

## 10 in. LCD display and built-in stereo speakers

- With the built-in 10 in. LCD display and stereo speakers, you can enjoy a DVD movie without requiring a separate TV.

## Convenient 2-Way power supply

- You can use your DVD player virtually anywhere by using the supplied AC adapter indoors and the battery pack outdoors.

## Compact size/light-weight design

- Compact and lightweight design makes the player easy to carry.

## High-resolution image and high quality sound

- High-resolution LCD screen with 384,000 pixels provides a clear picture.
- \* Phantom Virtual Surround Sound provides a fuller sound via two built-in speakers.

## AV input/output, optical digital output jack

- \*<sup>2</sup>Dolby Digital 5.1-CH audio and \*<sup>3</sup>DTS digital audio can be output through the optical digital output jack. You can enjoy unsurpassed surround sound when a Dolby Digital/DTS digital surround processor or amplifier is connect to this jack.

- You can connect a VCR or camcorder to your DVD player using the AV input/output jacks. or, you can connect to a TV for a larger screen.

\*<sup>1</sup> Is a registered trademark of LSI Logic, Inc.

\*<sup>2</sup> Manufactured under license from Dolby Laboratories. "Dolby", "Pro Logic", and the double-D symbol (ⓁⓁ) are trademarks of Dolby Laboratories. Confidential unpublished works © 1992-1997. Dolby Laboratories, Inc. All rights reserved.

\*<sup>3</sup> "DTS" and "DTS Digital Out" are trademarks of Digital Theater Systems, Inc.

## Memory Stick

"Memory Stick" is a new compact, portable and versatile IC (Integrated Circuit) recording medium with a data capacity that exceeds a floppy disk.





**AV-IN :** For viewing a video from an external component such as a VCR, camcorder etc...

## NOTE:

- Please be advised to watch an external video at normal play back speed, otherwise you may experience screen noise.

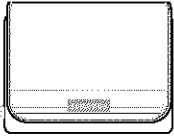

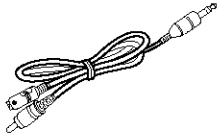
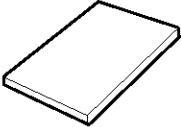
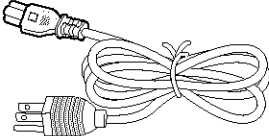
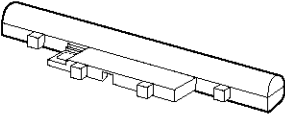
# Accessories



<p>Remocon (AH59-01053A)</p>  <p>Lithium battery AC43-12002G</p>	<p>Carry Case (AK69-00011A)</p> 	<p>AC power Adapter (AK44-00001A)</p> 	<p>Video cable (AK39-00007A)</p> 
 <p>User's Manual (AK68-00052A)</p>	<p>AC Cord (AK39-00010A)</p> 	<p>Battery pack (AH97-01017A)</p> 	<p>Audio cable (AK39-00008A)</p> 

## If disc features differ from the explanation in the manual

- Some functions or operations are disc-dependent and may not work in all cases. Follow the instructions shown on the screen. This manual only covers basic disc operations.
-  may appear during some operations. This mark indicates that the disc in use does not currently support operations explained in this manual.

# Disc Type and Characteristics

This DVD player is capable of playing the following types of discs with the corresponding logos

	Audio + Video	5"	Single-sided 240 min Double-sided 480 min	<ul style="list-style-type: none"> <li>DVD contains excellent sound and video due to Dolby Digital and MPEG-2 system</li> <li>Various screen and audio functions can be easily selected through the on-screen menu</li> </ul>
		3 1/2"	Single-sided 80 min Double-sided 160 min	
	Audio + Video	5"	74 min	<ul style="list-style-type: none"> <li>Video with CD sound, VHS quality &amp; MPEG-1 compression technology</li> </ul>
		3 1/2"	20 min	
	Audio	5"	74 min	<ul style="list-style-type: none"> <li>CD is recorded as a Digital Signal with better audio quality, less distortion and less deterioration of audio quality over time</li> </ul>
		3 1/2"	20 min	

## Play Region Number

Both the DVD player and the discs are coded by region. These regional codes must match in order for the disc to play. If the codes do not match, the disc will not play. **The Region Number for this player is described on the housing bottom of the player.**

### \* Caution 1



• Play Region Number



• NTSC (used in system in U.S., Canada, Korea, Japan, etc)



• Dolby Digital disc



• Memory Stick



• Stereo disc



• Digital Audio disc



• DTS disc



• MP3 disc

### NOTE:

- Discs which cannot be played with this player
  - DVD-ROM
  - DVD-RAM
  - CD-ROM
  - CDV
  - CDI
  - SVCD CVD
  - HD layer of super Audio CD
  - CDGs play audio only not graphics
- Ability to play back may depend on recording conditions
  - DVD-R
  - CD - RW
  - DVD+RW -RW
  - Picture CD

# Disc Type and Characteristics

---

## \* Caution 2

- Some playback functions of a DVD or VIDEO CD vary by manufacturer.  
This DVD player reproduces the disc data according to guidelines provided by the disc manufacturer. If  appears during disc operations, the disc manufacturer has placed a limit on that function.

## \* Caution 3

- The LCD display does not support Closed Captions. However, you can view captions by connecting this unit to a TV with the caption function.

## Discs that cannot be played

1. Illegally manufactured discs
2. Disc with scratches; and
3. Disc with fingerprints, dirt, and debris.
  - If the disc surface has dirt or scratches, **NO DISC** will be displayed and the disc will not be played correctly. (Refer to page 5 and clean the surface of the disc.)  
If the player encounters dirt or scratches while playing, video playback may be interrupted.  
(Some block-like patterns appear. When this occurs, your player will restore the image in 2~3 seconds.)

## About Copyrights

- Any kind of unauthorized and commercial duplication, public performance, broadcasting, renting, copying and making transmittable of the content of discs is strictly prohibited by law.
- This product is equipped with anti-copy protection device and connecting to a VCR for recording purpose results in a distorted picture.
- This product incorporates copyright protection technology that is protected by method claims of certain U.S. patents and other intellectual property rights owned by Macrovision Corporation and other rights owners. Use of this copyright protection technology must be authorized by Macrovision Corporation, and is intended for home and other limited viewing uses only unless otherwise authorized by Macrovision Corporation. Reverse engineering or disassembly is prohibited.
- Manufactured under license from Dolby Laboratories.  
“Dolby”, “Dolby Digital”, “Dolby Pro Logic”, and the double-D symbol () are trademarks of Dolby Laboratories.
- “DTS” is a trademark of Digital Theater System, Inc.
- Phantom Surround Sound is a trademark of LSI Logic, Inc.

# Description-Front Panel

## Front View

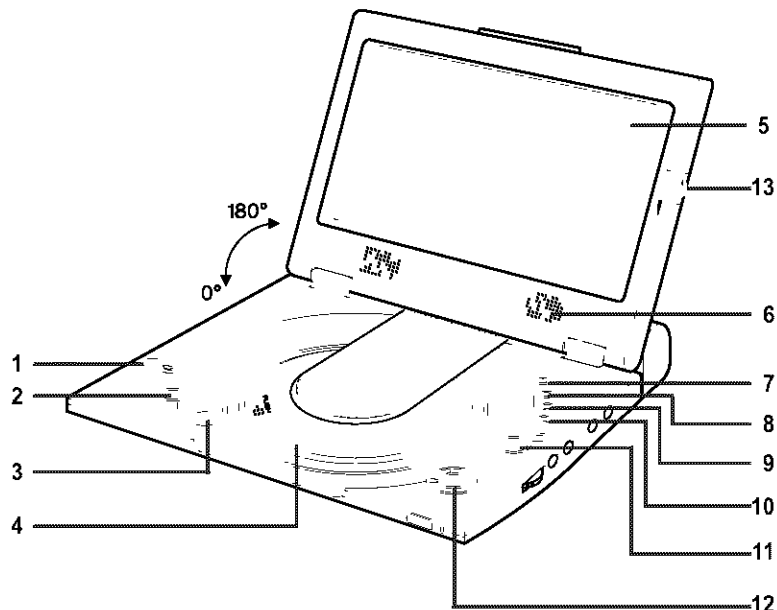

1 MEMORY STICK

2 POWER

- Press the POWER button for 1 second to power off

3 OPEN

4 DISC COVER

5 LCD

6 SPEAKER

7 REVERSE DISPLAY

8 DVD/M STICK/AV-IN

9 MENU

10 DISPLAY

11 CURSOR (UP/DOWN/LEFT/RIGHT), ENTER (↵)

12 PLAY etc

- PLAY (▶), PAUSE (⏸)/STEP, STOP (■), REV-SKIP (⏮), FWD-SKIP (⏭)

13 BRIGHT

# Description-Front Panel

## Right View

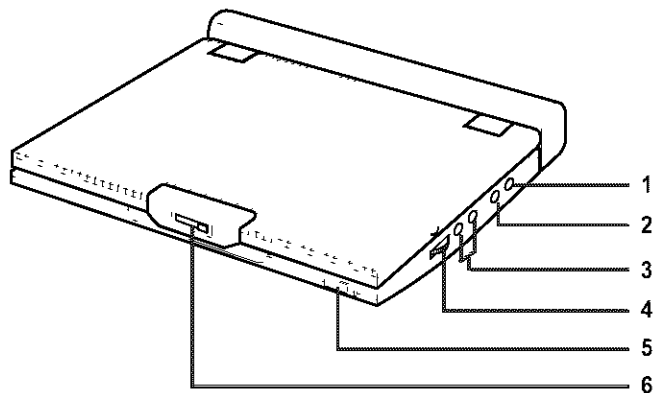

- 1 VIDEO IN/OUT / S-VIDEO OUT
- 2 AUDIO IN/OUT / DIGITAL OPTICAL OUT
- 3 HEAD PHONES 1, 2
- 4 VOLUME
- 5 REMOTE SENSOR
- 6 OPEN

## Left View

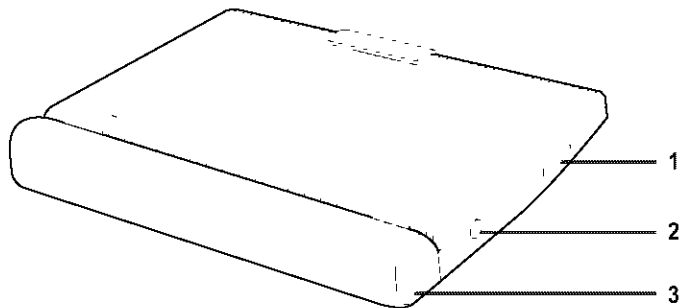

- 1 MEMORY STICK SLOT
- 2 DC IN 8 4V
- 3 BATTERY PACK

# Description-Front Panel

---

## Bottom View

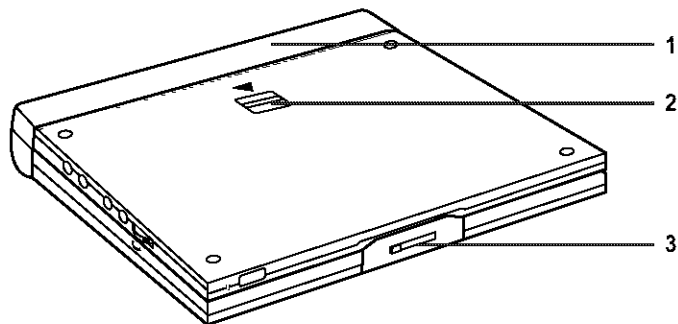

1 BATTERY PACK

2 RELEASE

3 OPEN

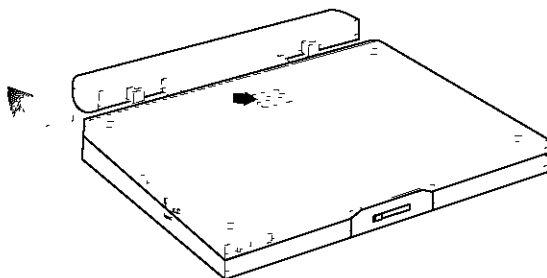

# Tour of the Remote Control

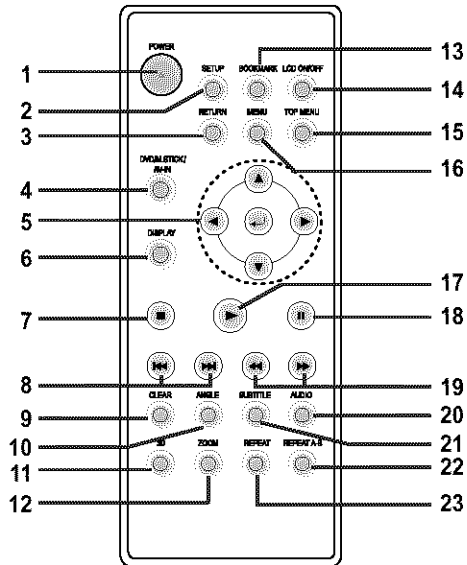

## 1. DVD POWER Button

## 2. SETUP Button

- Brings up the DVD player's Setup menu.

## 3. RETURN Button

- Returns to the previous menu.

## 4. DVD/M.STICK/AV-IN Button

## 5. ENTER/DIRECTION Buttons

- (UP/DOWN or LEFT/RIGHT buttons)

- This button functions as a toggle switch.

## 6. DISPLAY Button

- Displays the current disc mode.

## 7. STOP Button

- STOP disc play

## 8. SKIP Buttons

- Use to skip the title, chapter, or track.

## 9. CLEAR Button

- Use to remove menus or status displays from the screen.

## 10. ANGLE Button

- Use to access various camera angles on a DVD.

## 11. 3D Button

## 12. ZOOM Button

## 13. BOOKMARK Button

## 14. LCD ON/OFF Button

## 15. TOP MENU Button

- Takes you to the menu of the DVD disc.
- When pressing the TOP MENU button with a CD; the unit enters the INTRO mode. INTRO lets you listen to the beginning of each track for about 10 seconds.

## 16. MENU Button

- Brings up the Disc menu.

## 17. PLAY Button

- Starts disc play.

## 18. PAUSE/STEP Button

- Pauses disc play.

## 19. SEARCH Buttons

- Allows you to search forward/backward through a disc.

## 20. AUDIO Button

- Use this button to access various audio functions on a disc.

## 21. SUBTITLE Button

## 22. REPEAT A-B Button

- Use to mark a segment to repeat between A and B.

## 23. REPEAT Button

- Allows you to repeat play a title, chapter, track, or disc.

## Connecting Headphones to the DVD

---

You can attach headphones with a stereo mini-jack plug (not supplied) to the PHONES jack for private listening. There are two jacks available.

### How to use headphones

1. Insert headphones into the PHONES jack.
  - This jack is a stereo mini-jack.

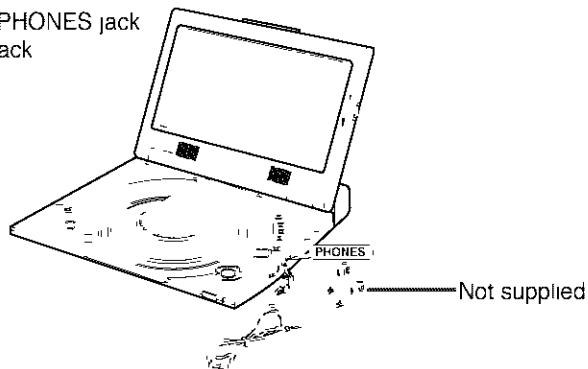

### Important!

- Turn the headphone volume down to the minimum setting before connecting.

### Caution

- Once you connect headphones to the DVD, your DVD Player's speakers will be disconnected.

2. Adjust the volume level by using the VOLUME control dial.



## Connecting to an External Component (Input Select)

You can enjoy video from your VCR or camcorder on your DVD player

When connecting to an external component

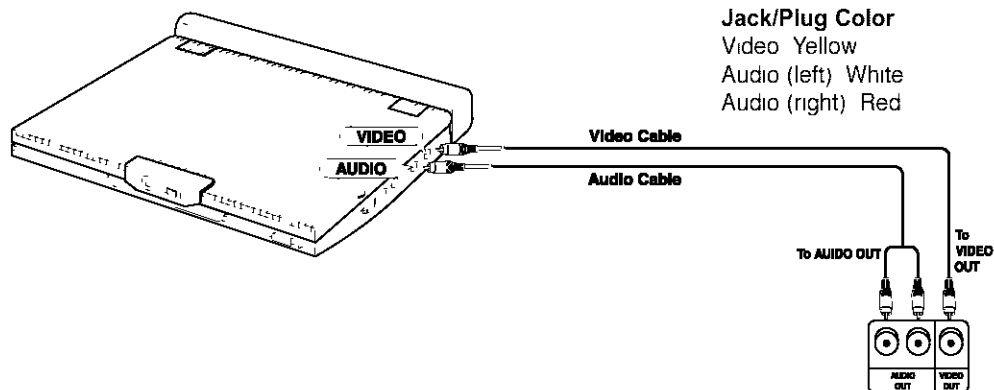

VCR or other component equipped with external output connectors

### Important!

- Always turn off the DVD Player and other components before you connect any cables
- Refer to owner's manual of the components you are connecting for more information on those particular components

## Connecting to a TV

You can enjoy high-resolution video using an S-VIDEO cable when connecting your DVD player to a TV equipped with an S-VIDEO input jack.

- Always turn off the DVD Player and TV before you connect any cables.

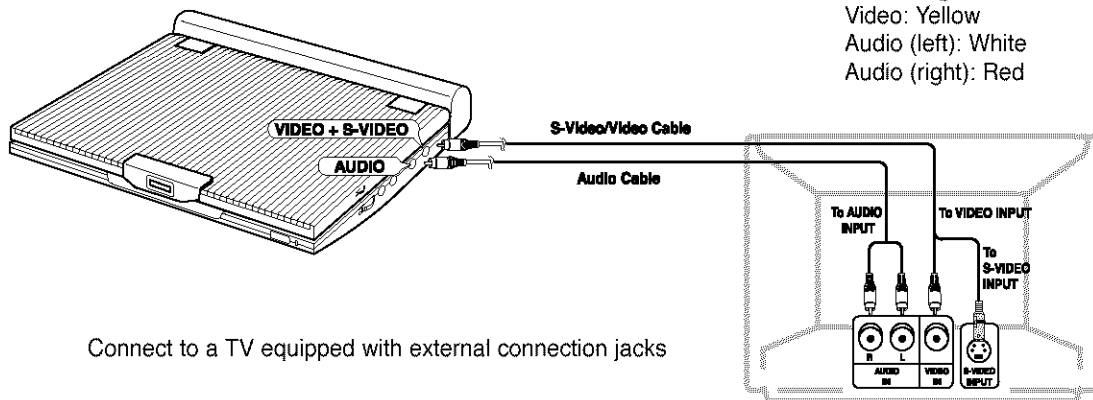

Connect to a TV equipped with external connection jacks

### Jack/Plug Color

Video: Yellow

Audio (left): White

Audio (right): Red

### Caution

- If you wish to view video on your TV only, close the display panel of your DVD player. Playback will continue and audio to the speakers will be cut off.
- With the display panel shut, use the remote to control the DVD player.
- For power saving, press the LCD ON/OFF button to power off the LCD display.

### To view video with a TV

1. Turn on the TV.
2. Adjust the TV input to the one that your DVD player is connected to ("AV", "VIDEO").
3. Turn on the DVD player, and start playback.

# Connecting to a Stereo Component

When you connect the DVD player to an audio system, you can listen to higher quality sound

## 2-CH Audio Playback

### ■ Analog Connection

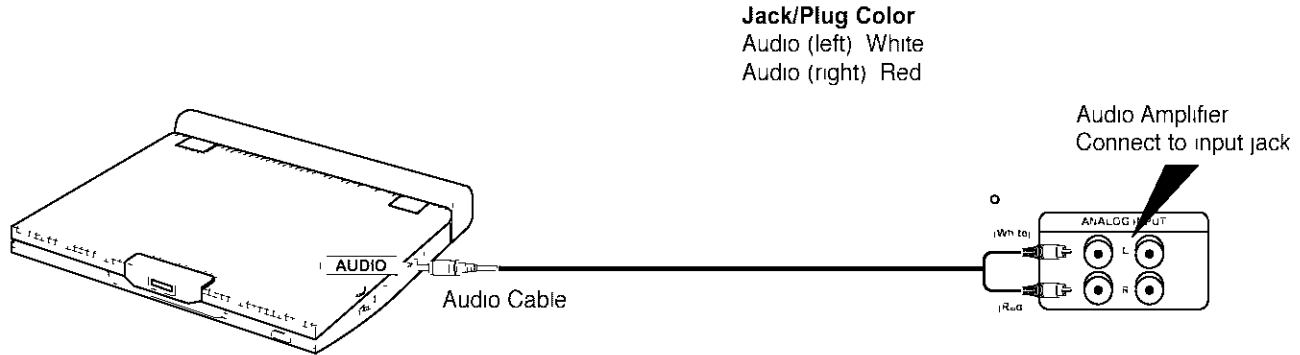

### **NOTE:**

- When connecting to an audio component, set the Dynamic Comp to Off (see page 54)

## Connecting to a Stereo Component

- Digital Connection  
Digital Output (optical)

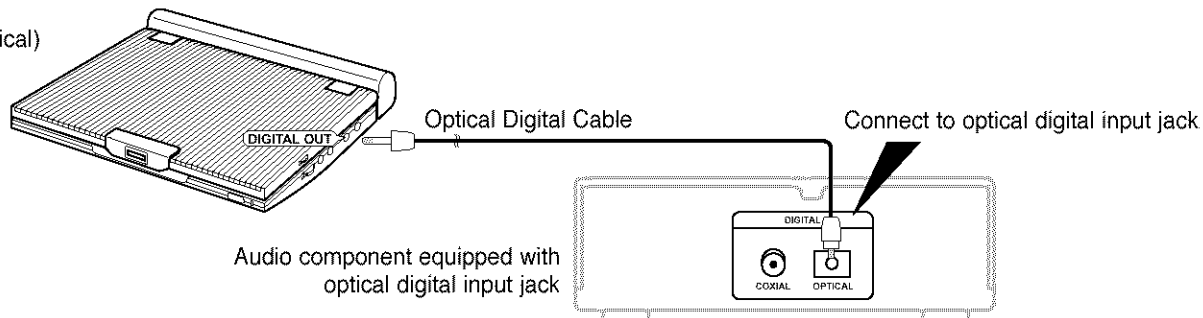

### After the completion of above connections;

1. Set the "Digital Output" to "PCM" (see page 54) in "AUDIO SETUP".

- Digital connection to audio component or MD player without Dolby Digital decoder
  - Audio CD or Video CD  
Play the disc, with the audio mode set to "Left" or "Right". When connecting digitally, DTS-encoded audio tracks will produce distorted sound.
  - DVD Disc  
When playing a Linear PCM Audio encoded disc, you must use the digital connection method shown above.

### CD recording using digital connection to a MD

When digitally connecting to an MD to record the content of a CD, track numbers on the MD and the CD may not match.

### NOTE:

Only use an optical Digital Cable which has been designed for use with portable DVD.

# Connecting to a Stereo Component

## Playing Dolby Digital (5.1-CH) and DTS Audio

- You can enjoy full and dynamic surround sound by connecting a Dolby Digital/DTS digital surround processor or amplifier equipped with a Dolby Digital/DTS surround decoder to the optical digital jack on the DVD player
- When using DTS digital surround, select the DTS audio by using the disc menu screen or function adjustment screen

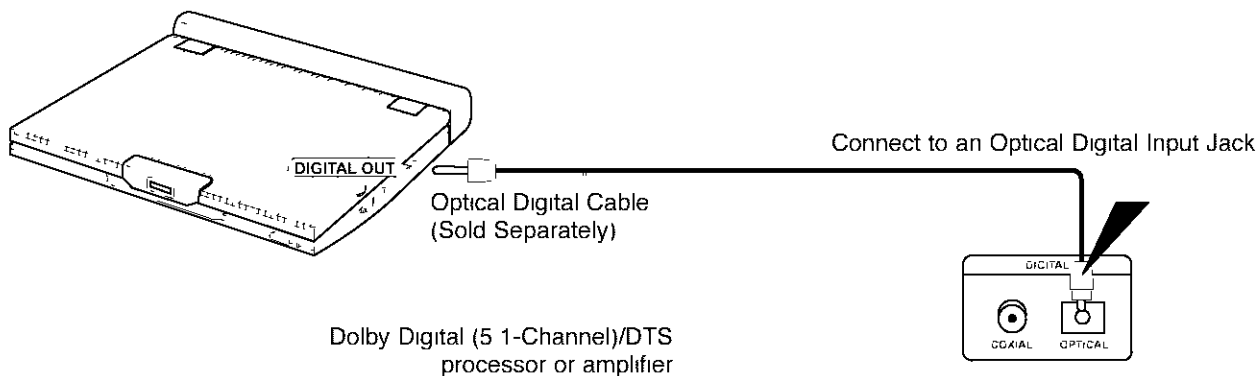

### After making the connections shown above;

- 1 Set the "Digital Output" to "Bitstream" (see page 54) in "AUDIO SETUP"

### Caution

- To play a DTS disc, you need a DTS processor or amplifier
- If the DTS processor or amplifier you want to use does not have an optical digital input jack, digital connection is not possible
- Refer to owner's manual of the processor or amplifier for details on connections

## Using the AC adapter

---

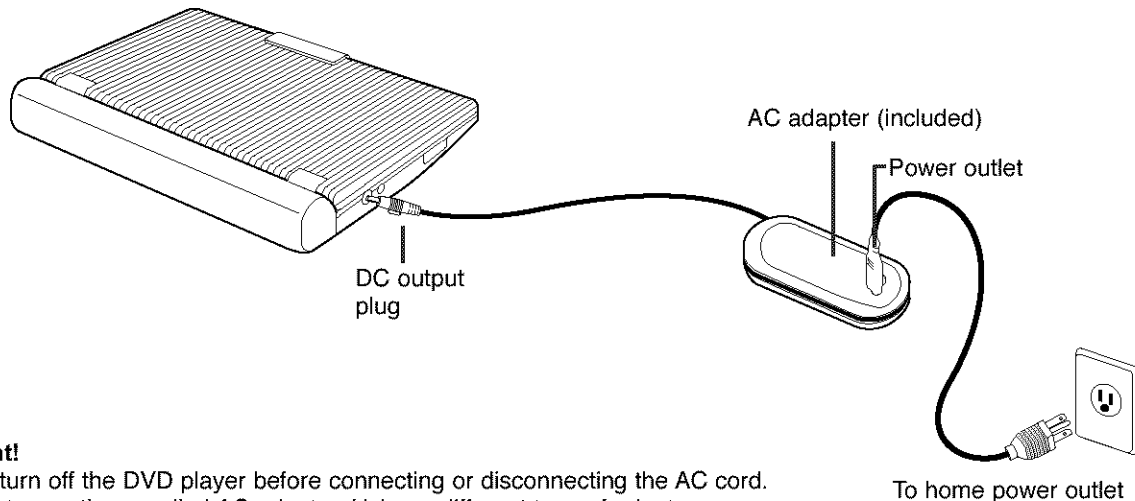

### Important!

- Always turn off the DVD player before connecting or disconnecting the AC cord.
- Be sure to use the supplied AC adapter. Using a different type of adapter may cause malfunction or damage to the product.
- When the AC adapter is used for prolonged periods of time, the adapter may heat up. This is normal and is not a cause for concern.
- When not using the adapter, unplug it from the wall outlet.
- Keep the AC adapter free from moisture, cold, and dust. Otherwise, this can result in a risk of fire or electric shock.

### Warning

- Only use the AC adapter supplied with this player.

## Using the AC adapter

---

### **Important!**

- Always turn off the DVD player when inserting or removing the AC adapter.
- While the DVD player is turned on, the battery pack in the DVD player will not be recharged. Turn off the DVD player when recharging.
- Before storing the battery pack, make sure it is completely drained. Recharge the stored battery pack in about every six months before using.

### **Caution**

- When charging or using the battery pack, it heats up. This is normal and is not a cause for concern.
- If power charge lamp flashes quickly or does not light red, it is not a cause for concern.

### **NOTE:**

Connecting the battery pack to the AC Adapter;

- You can recharge the battery pack in the DVD player by turning off the player and connecting the AC adapter to the player.

### **Charge Time: Approx. 3.5 hours**

- Charge time may be longer when using the battery pack in a cold environment.

### **DVD Continuous Playing Time with a Fully charged Battery pack (with speaker): Approx. 2.5 hours**

- DVD continuous playing time is a reference indicating the maximum playing time at average screen brightness.
- The playback time may be shortened depending on the disc, surrounding temperature, battery pack conditions, and speaker volume.

# Using the battery pack

## Important!

- When inserting the battery pack, make sure that it is inserted correctly  
Otherwise your DVD player may malfunction

## Charging the battery pack

Use the AC adapter (included) to charge the battery pack

- Before charging, make sure that the battery pack is correctly seated

- 1 Connect the AC cord to the jack on the AC adapter ( 1 )
- 2 Plug the other end of the AC cord into an AC outlet ( 2 )
- 3 Connect the DC cord to the DC IN jack on the left side of the DVD player ( 3 )

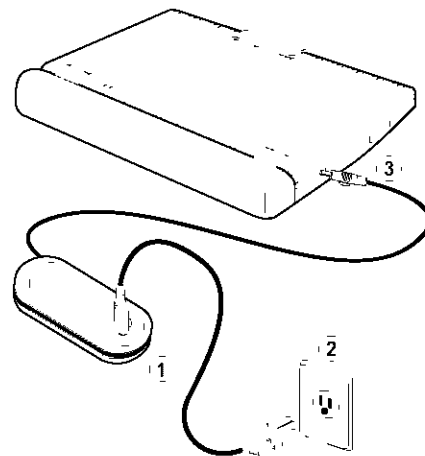

Blinking time	Charging rate
Once per second	Less than 50%
Twice per second	50%~75%
Three times per second	75%~90%
Blinking stops and stays on	90%~100%
On for a second and off for a second	Error-Reset the battery pack and the DC cable

## Power Charge Lamp

-Green light will flash while charging

-When the battery pack is charged, the light will stop blinking and remains green



## Battery level display

• The battery level display indicates the amount of power remaining in the battery pack.

- a. Fully charged
- b. 20~40% used
- c. 40~80% used
- d. Completely used (flickers)  
(The DVD will turn off soon, change the battery as soon as possible)

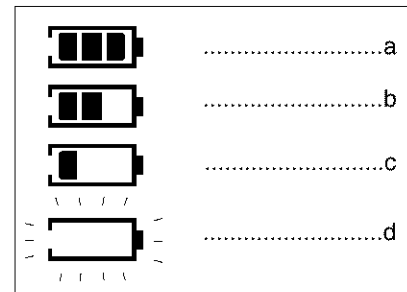

\*The playing times is affected by environmental temperature and conditions.

The playing times becomes very short in a cold environment. The continuous playing times in the operating instructions are measured using a fully charged battery pack at 77°F(25°C). As the environmental temperature and conditions may differ when you actually use the DVD, the remaining battery time may not be the same as the approximate continuous playing times given in these instructions.

## Loading a DVD Disc

1. After plugging in the player, the first time you press the POWER button, this screen comes up:  
Press the UP/DOWN buttons to select the language, and then press the ENTER button.  
(This screen will only appear the very first time you plug in the player.)
  2. Press the OPEN button to open the disc lid.
    - The disc lid opens up to around a 60-degree angle.
    - Do not attempt to open the lid to an angle beyond this range. The lid may become damaged.
  3. Place a disc gently into the tray.
    - You should hear and feel the disc snap firmly into place.
- Caution
- Place a disc into the tray with the disc's label facing up.
4. Close the disc lid and then press the part marked "PUSH" until it clicks shut.

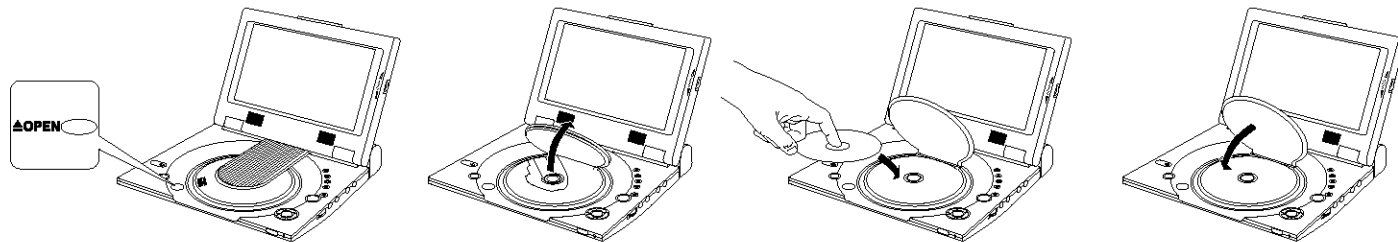
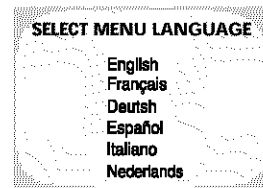

### Important!

- Make sure that the disc is correctly placed. Otherwise, the disc and/or the DVD player may be damaged.
- If the disc is placed upside down in the disc tray or the region number of the DVD is not supported, NO DISC will appear on the screen.

### NOTE:

- You don't take out a disc until the disc entirely stopped.
- Press the POWER button for 1 second to power off.

# Using the Remote Control Unit

## Installing the Battery in the Remote

- 1 Remove the battery compartment in the direction of the arrow
- 2 Place the lithium battery in the battery compartment and put the battery compartment cover back on the remote
  - Match the polarities (+ and -) on the battery with the marks in the battery compartment. If the battery is inserted in the wrong direction, your remote control may not work correctly

(Back of the remote control)

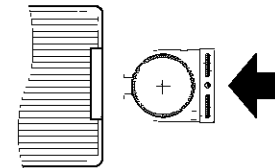
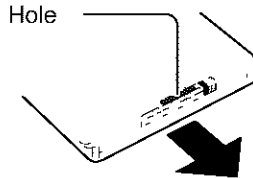

## Operating Range of Remote Control Unit

### Important!

Do not subject the remote control unit to strong vibration or shock  
Keep the remote control unit free from moisture and water

### Caution

- After battery replacement, your remote control unit may not work. If this occurs, remove the battery and re-insert in about 5 minutes
- It may be difficult to operate the remote control unit if the remote control sensor on the DVD player is exposed to direct sunlight or strong artificial light. Try operating the remote away from such light sources
- Remove the battery when not planning to use the remote control unit for a long period of time

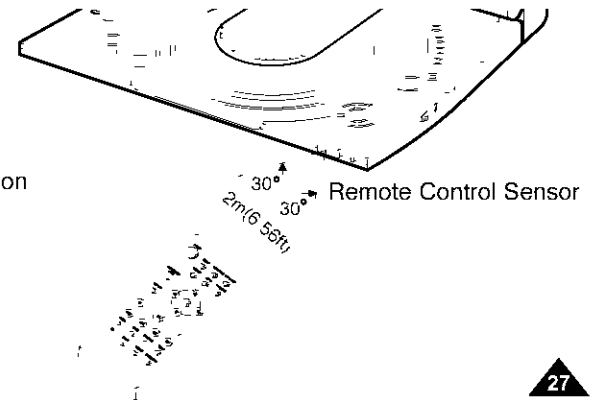

## Viewing a Video from an External Component

Use the procedure below to view a video from a VCR or camcorder on your DVD player

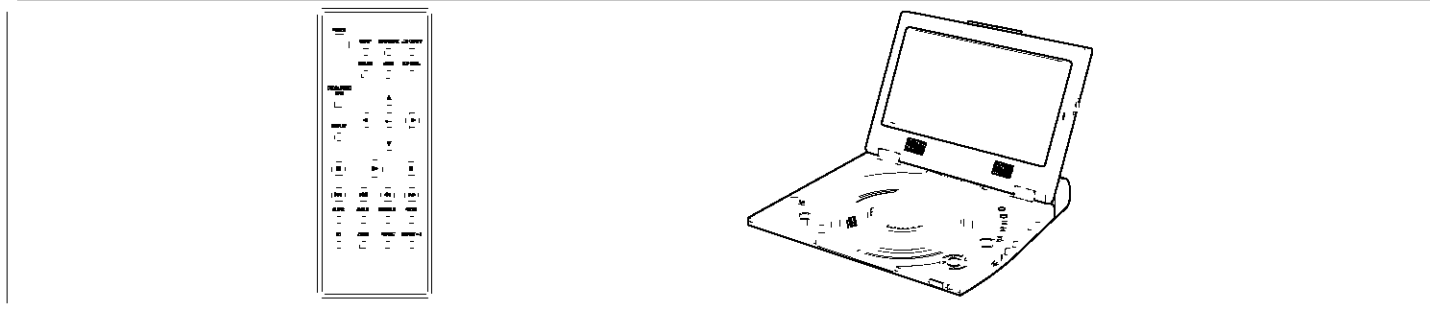

### To view a video from an external component

- 1 Connect the external component according to the procedure outlined on page 17
- 2 Turn on the external component
- 3 Turn on the DVD player
- 4 Press the DVD/M STICK/AV-IN button to set the AV-IN mode
- 5 Press the PLAY button on the external component

#### Caution

- Power is not supplied from this device to the connected DVD player
- When not using your DVD player, always remove all connecting cables from the video or audio input/output jacks
- If no signal is input for more than 5 minutes while in the input mode, this unit enters the standby mode

#### If the player is left in pause mode

- If the PAUSE mode continues for more than 5 minutes, the unit will be automatically switch to 'STOP'
- If the STOP mode continues for more than 1 minute, it will automatically switch to 'FADE IN FADE OUT'
- If the FADE IN FADE OUT mode continues for more than 4 minutes, the power will be shut off automatically

AV-IN

## Using the Search & Skip Functions

During play, you can search quickly through a chapter or track or use the skip function to jump to the next selection

### Searching through a Chapter or Track

- 1 During play, press the FWD SEARCH (▶▶) or REV SEARCH (◀◀) button on the remote
  - Press the REVERSE or FORWARD SEARCH button on the remote and press again to search at a faster speed on a DVD, VCD, CD

DVD	2X 4X 8X 16X 32X 128X
VCD/CD	2X 4X

### Skipping Tracks

- 1 During play, press the NEXT SKIP (▶▶) or BACK SKIP (◀◀) button
  - When playing a DVD, if you press the NEXT SKIP button, it moves to the next chapter  
If you press the BACK SKIP button, it moves to the beginning of the chapter  
One more press makes it move to the beginning of the previous chapter
  - When playing a VCD 2.0, a VCD 1.1 or a CD, if you press the NEXT SKIP button it moves to the next track. If you press the BACK SKIP button, it moves to the beginning of the track  
One more press makes it move to the beginning of the previous track
  - If a track exceeds 15 minutes when playing a VCD and you press the NEXT SKIP button, it moves forward 5 minutes. If you press the BACK SKIP button, it moves backward 5 minutes

# Using the Display Function

## When Playing a DVD

- During play press the DISPLAY button on the remote
  - Current title, chapter number, elapsed time, audio, Subtitle, Angle and Repeat will be displayed
    - Use the UP/DOWN buttons to select desired item then press ENTER button
    - Use the UP/DOWN buttons to enter a chapter number then press the ENTER button
    - To enter the time from which you want to start, use the UP/DOWN/LEFT/RIGHT buttons to select then press the ENTER button
    - Use the UP/DOWN buttons to change the values of the current audio, Subtitle, Angle and Repeat
    - To make the screen disappear, press the DISPLAY button again

Display	
Title	01/04
	08/17
Time	00 27 13
Audio	ENG Dolby Digital 2CH
Subtitle	Off
Angle	01 of 01
Repeat	Off
Instruction	

## When Playing a VCD/CD

- During play press the DISPLAY button on the remote
  - Current title, track number, elapsed time, audio and Repeat will be displayed
    - Use the UP/DOWN buttons to select desired items then press ENTER button
    - To enter the time from which you want to start, use the UP/DOWN/LEFT/RIGHT buttons to select then press the ENTER button
    - Use the UP/DOWN buttons to change the values of the current audio, Repeat
  - To make the screen disappear, press the DISPLAY button again

Display	
	08/17
Time	00 27 13
Audio	Stereo
Repeat	Off
Instruction	

### NOTE:

#### What is a Chapter?

Each Title on a DVD is usually divided into chapters (similar to tracks on an audio CD)

#### What is a Title?

A DVD may contain several different titles. For example, if a disc contains four different movies, each might be considered a title.

# Repeat Play

Repeat the current track, chapter title, a chosen section (A-B), or all of the disc

## When playing a DVD

- 1 Press the REPEAT button on the remote Repeat screen appears
- 2 Select Title or Chapter using the LEFT/RIGHT buttons
- 3 Press ENTER
- 4 To return to normal play, press REPEAT again, then press the LEFT/RIGHT buttons to select Off and press ENTER
  - REPEAT A-B button
    - Press the REPEAT (A-B) button to select the point where the function starts (A)
    - Press the REPEAT (A-B) button to select the point where the function ends (B)
    - To terminate the function press the 'CLEAR' button or the 'REPEAT (A-B)' button again  
Then press play to resume normal playback
    - A-B REPEAT does not allow you to set point (B) until at least 5 seconds has elapsed after point (A) has been set

### DVD

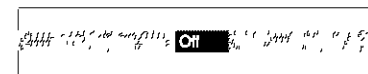

### VCD/CD

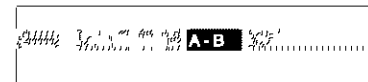
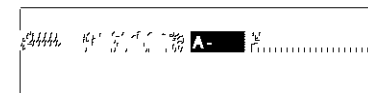
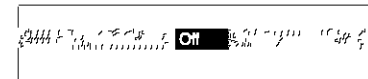

### NOTE:

- DVD repeats play by chapter or title CD and VCD repeat play by disc or track  
See page 37 to MP3 disc repeat play
- Depending on the disc, the Repeat function may not work
- If the title or track is completed before marking the end (B), the end of title or track becomes B automatically

## Selecting the Audio Language

---

You can select a desired language quickly and easily with the AUDIO button

### Using the Audio button

- 1 Press the AUDIO button
- 2 Use the LEFT/RIGHT buttons to select the desired language on a DVD
  - The audio languages are represented by abbreviations
- 3 Use the LEFT/RIGHT buttons to select Stereo, Right or Left (On VCD/CD)

#### DVD

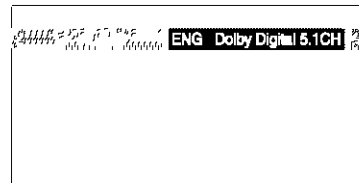

#### VCD/CD

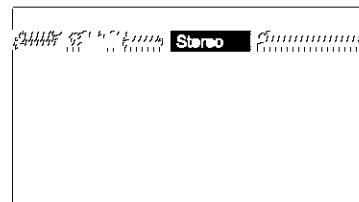

### NOTE:

- This function depends on what languages are encoded on the disc and may not work with all DVDs
- A DVD disc can contain up to 8 audio languages
- **How to have the same audio language come up whenever you play a DVD;**  
Refer to 'Setting Up the Language Features" on page 52



# Selecting the Subtitle Language

---

You can select a desired subtitle quickly and easily with the SUBTITLE button

## Using the SUBTITLE button

- 1 Press the SUBTITLE button
- 2 Use the LEFT/RIGHT buttons to select the desired subtitle language
- 3 Use the UP/DOWN buttons to determine whether or not the subtitle will be displayed
  - Initially, the subtitling will not appear on screen
  - The subtitle languages are represented by abbreviations

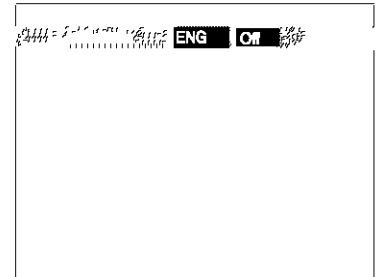

## **NOTE:**

- This function depends on what languages are encoded on the disc and may not work with all DVDs
- A DVD disc can contain up to 32 subtitle languages
- **How to have the same subtitle language come up whenever you play a DVD,**  
Refer to "Setting Up the Language Features" on page 52

## Changing the Camera Angle

---

When a DVD contains multiple angles of a particular scene, you can select the Angle function

### Using the ANGLE button

Press the ANGLE button to see if an ANGLE (  ) mark is present at the upper left hand corner of the screen

- 1 When an ANGLE mark is shown, press the ANGLE button, then an ANGLE selection will appear at the upper left hand corner of the screen
- 2 Use the LEFT/RIGHT buttons to select the desired screen angle
- 3 To turn off the display, press the ANGLE button again

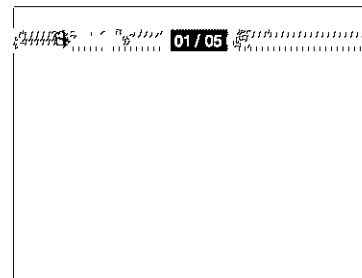

# Using the Bookmark Function

The Bookmark function lets you select parts of a DVD or VCD so that you can quickly find the section at a later time

## Using the Bookmark Function (DVD/VCD)

- 1 During play press the BOOKMARK button on the remote  
The Bookmark icons will be displayed
- 2 Use the LEFT/RIGHT buttons to move to the desired bookmark icon
- 3 When you reach the scene you want to mark, press the ENTER button  
The icon will change to a number (1, 2 or 3)
- 4 Press the BOOKMARK button to turn off the display

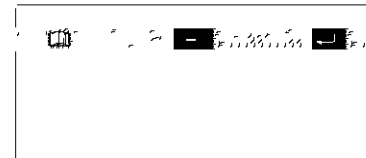

## Recalling a Marked Scene

- 1 During play press the BOOKMARK button on the remote
- 2 Use the LEFT/RIGHT buttons to select a marked scene
- 3 Press the PLAY button to skip to the marked scene

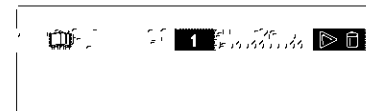

## Clearing a Bookmark

- 1 During play press the BOOKMARK button on the remote
- 2 Use the LEFT/RIGHT buttons to select the bookmark number you want to delete
- 3 Press the CLEAR button to delete a bookmark number  
Press the BOOKMARK button to turn off display

### NOTE:

- Up to three scenes may be marked at a time
- Depending on the disc, the Bookmark function may not work

# Using the Zoom & 3D Sound Functions

## Using the Zoom Function (DVD/VCD)

- 1 During play or pause mode, press the ZOOM button on the remote. A square will be displayed on screen.
- 2 Use the UP/DOWN or LEFT/RIGHT button to select the part of the screen you want to zoom in on.
- 3 Press the ENTER button.
  - Press ENTER to zoom in 2X/4X/2X/Normal in order (DVD)
  - Press ENTER to zoom in 2X/Normal in order (VCD)

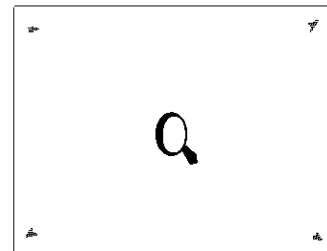

## Using the 3D Sound Function

The simulated surround effect depends on the disc contents. If you connect the unit to your stereo system, you can enhance sound quality and produce a greater surround effect. This feature is useful when you are using the DVD player with a two channel stereo through the analog outputs.

(Discs which are recorded with LPCM or DTS will not work. When the DIGITAL OUTPUT or MPEG-2 is set to BITSTREAM in the SETUP MENU, the 3D Sound function will not work.)

- 1 During play, press the 3D button. The 3D SOUND mark will be displayed on screen. (Be sure the DIGITAL OUTPUT is set to PCM.)
- 2 Press the UP/DOWN buttons to turn the 3D Sound feature on or off.

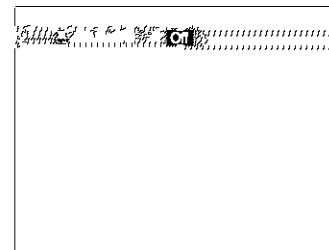

### **NOTE:**

- 3D Sound is possible only on discs recorded using DOLBY SURROUND or DOLBY DIGITAL. However, some of these discs do not contain rear channel sound signals.
- Depending on the disc, the Zoom and 3D Sound function may not work.

# MP3 Play

When an MP3 Disc is inserted into the DVD PLAYER, the first song file of the first folder plays

## MP3 Play Function

- 1 Press STOP to stop playback of the first song file, then press LEFT to display the music folder menu on the right side of the screen. Up to 7 music folders can be displayed at a time. If you have more than 7 folders on a disc, press the UP/DOWN buttons to bring them up on the screen.
- 2 Use the UP/DOWN buttons to select the desired music folder, then press ENTER. Use the UP/DOWN buttons again to select a song file. Press ENTER to begin playback of the song file.

### NOTE:

- Press the REPEAT button to hear a song file repeatedly.
- Press the REPEAT button one more time to hear all song files repeatedly.
- Press Repeat again to release the Repeat mode.

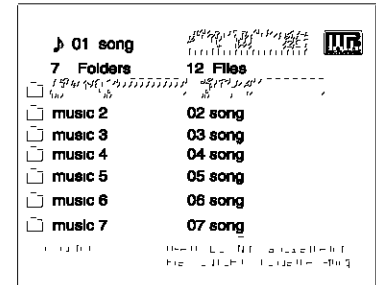

# MP3 Play

---

## CD-R/MEMORY STICK/MP3 requirements

When playing CD-R MP3 discs please follow the recommendations below

- **Your MP3 files should be ISO 9660 or JOLIET format**

ISO 9660 format and Joliet MP3 files are compatible with Microsoft's DOS and Windows, and with Apple's Mac. These two formats are the most widely used.

- **When naming your MP3 files do not exceed 8 characters, and place " mp3" as the file extension**

General name format of Title.mp3. When composing your title, make sure that you use 8 characters or less, have no spaces in the name, and avoid the use of special characters including ( , / \ , = , + )

- **Use a decompression transfer rate of at least 128 Kbps when recording MP3 files**

Sound quality with MP3 files basically depends on the rate of compression/decompression you choose. Getting audio CD quality sound requires an analog/digital sampling rate (conversion to MP3 format) of at least 128 Kbps and up to 160 Kbps. However, choosing higher rates, like 192 Kbps or more, only rarely give better sound quality.

Conversely, files with sampling rates below 128 Kbps will not be played properly.

- **Do not try recording copyright protected MP3 files**

Certain "securized" files are encrypted and code protected to prevent illegal copying. These files are of the following types: Windows Media™ (registered trade mark of Microsoft Inc) and SDMI™ (registered trade mark of The SDMI Foundation). You cannot copy such files.

- **Your DVD player only accepts one level of file directory**

Consequently you must choose

-either to save all your MP3 recording files at the root of the disc,

-and/or create folders in the directory for each artist or music type (e.g. classical, rock, jazz, etc)

- **Important** The above recommendations cannot be taken as a guarantee that the DVD player will play MP3 recordings, or as an assurance of sound quality.

You should note that certain technologies and methods for MP3 file recording on CD-Rs prevent optimal playback of these files on your DVD player (degraded sound quality and in some cases, inability of the player to read the files)

# Memory Stick

---

## What is a Memory Stick?

"Memory Stick" is a new compact portable and versatile IC (Integrated Circuit) recording medium with a data capacity that exceeds a floppy disk

"Memory Stick" is specially designed for digital data exchange among "Memory Stick" compatible devices

Because it is removable the "Memory Stick" can also be used for external data storage

There are two types of "Memory Sticks"

One is the regular "Memory Stick" and the other is the "MagicGate Memory Stick" equipped with "MagicGate" copyright protection technology

"MagicGate" is a copyright protection technology that uses encryption

### 1. MagicGate Memory Stick

Can be used for both copyright-protected and regular data

### 2. Memory Stick

Can be used for regular data only

## **NOTE:**

MagicGate Memory Sticks with copyright-protected data cannot be used in this unit

# Memory Stick

---

## Precautions on handling the "Memory Stick"

- 1 Data can become corrupted in the following instances
  - When the "Memory Stick" is taken out or the power is turned off while using the DPM (Digital Photo Manager) or DAM (Digital Audio Manager) function
  - When using the "Memory Stick" in a location subject to static electricity or electric noise
- 2 Memory sticks can only be read in this unit not written
- 3 Do not attach any other material than the supplied label on the label space
- 4 Attach the label so that it does not stick out from the proper attachment location
- 5 When moving or storing the "Memory Stick" use the storage case
- 6 Do not touch the "Memory Stick" connector with your finger or metallic objects
- 7 Do not bend drop or apply strong shock to the "Memory Stick "
- 8 Do not disassemble or modify the "Memory Stick "
- 9 Do not allow the "Memory Stick" to get wet



# Memory Stick

---

## Precautions on attaching/removing the "Memory Stick"

- 1 If it is not fully inserted, until you hear an audible "click", the "Memory Stick" will not work
- 2 If you inadvertently remove the "Memory Stick" or turn off the power while using the DPM (Digital Photo Manager) or DAM (Digital Audio Manager) function, the recorded data may become corrupted
- 3 To remove the "Memory Stick" during operation, see page 44

## To format the "Memory Stick"

- 1 Do not format the "Memory Stick" using your computer. If you format the "Memory Stick" using the computer, you cannot use it with "Memory Stick" compatible devices.
- 2 If you need to format the "Memory Stick," use a "Memory Stick" compatible device. (If formatted, all data previously recorded on the "Memory Stick" will be erased.)
- 3 If you use a "Memory Stick" that has been initialized using a computer or initialize a "Memory Stick" attached to a camera using USB connection, further operation is not guaranteed.
- 4 Be careful not to optimize the "Memory Stick" from a computer running a Windows operating system. The life of the "Memory Stick" will be shortened.
- 5 Do not compress the data recorded on the "Memory Stick." A compressed file cannot be played back on this unit.

## Software Compatibility

- 1 Depending on the type of application software used, the file size of a still image may become larger when it is opened.
- 2 Depending on the type of application software used, only the first frame (thumbnail) of the clip motion file may be displayed.
- 3 An image file that has been modified using an image processing software may not open if it is converted into a different file format to play back with this product.

# Memory Stick

## Memory Stick functions applicable to DPM and DAM

Item	DPM (Digital Photo Manager)	DAM (Digital Audio Manager)
File Format	JPEG Image (*.jpg)	MP3 Music File (*.mp3)
File Size	<ol style="list-style-type: none"> <li>All files in JPEG format that have less than 1600 x 1200 resolution can be played back with DPM (JPEG files smaller than 1.5MB can be viewed with Photo View)</li> <li>For JPEG data without thumbnail information "Thumbnail not available" will be displayed in the Thumbnail View however they can still be played back in Photo View</li> </ol>	- No limit to file size
Compatibility	<ol style="list-style-type: none"> <li>Still image files with ".jpg" extension that have been recorded with a digital camcorder or digital still camera equipped with Memory Stick functions</li> <li>JPEG image files stored in Memory Stick using a Memory Stick adaptor for PC</li> <li>JPEG image files stored in CD-R/RW using CD Writer on PC have to be stored using one of directory formats as follows (Capitalize all letters of directory name)               <ol style="list-style-type: none"> <li>1) \DCIM\<dir>\.jpg</dir></li> <li>2) \PREVIEWS\<dir>\.jpg</dir></li> <li>3) \IMAGES\<dir>\.jpg</dir></li> <li>4) \.jpg</li> </ol> <p>- The size of each &lt;dir&gt; cannot be over 50MB [ case 1) 2) 3) ]                - In case of storing files in root directory [ case 4) ] the size of root directory also cannot be over 50MB</p> </li> </ol>	All files in MP3 format that have been downloaded from a PC or PDA to Memory Stick (*.mp3)
Main Functions	Directories Supported •Memory Stick DPM-DCIM\ <dir>\.jpg            •Picture CD DPM (Compatible with Picture CD of Kodak Fuji Qss (Noritac) and Konica)         </dir>	MP3 music files recorded on Memory Stick can be played back However although non-MP3 files are also displayed on DAM they cannot be played back



# DAM (Digital Audio Manager) Playback

## MP3 Playback

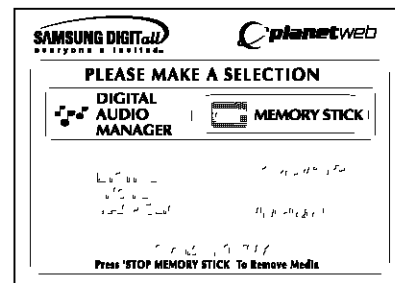
- 1 Press Stop if in play mode
- 2 Press the M STICK button on the remote and the screen to the right will appear
- 3 Insert the Memory Stick encoded with MP3 files into the Memory Stick Slot
- 4 Press the UP/DOWN buttons on the remote control to select Digital Audio Manager and then press the ENTER button
  - Your selection is highlighted with yellow borders
- 5 Use the UP/DOWN buttons to select the desired song
- 6 Press the ENTER button to start play
  - Press the MENU button to return to the Start menu
  - If the PLAY button is pressed during the playback of an MP3 file the song will start from the beginning again
  - If the SKIP button is pressed during the playback of an MP3 file, the next song will be played



## Screen Configuration

- 1 **FOLDER UP** Use to move 'up' a folder when you have multiple folders
  - 2 **PLAYLIST** Shows the playlist
  - 3 **INFO** Shows information about the Selected song being played
  - 4 **EXIT** Takes you to the Start menu
  - 5 Shows brief information about the selected song
  - 6 The title of the song currently playing
  - 7 Shows a list of MP3 files and folders found in the memory stick
  - 8 Shows the title and playback time of the currently playing song in the scroll box
- If the **REPEAT** button is pressed the following displays will appear
  -  If the REPEAT button is pressed, all MP3 files in a given folder will be played back repeatedly in the order they are listed under that folder
  -  If the REPEAT button is pressed once again the Shuffle function is activated (All MP3 songs in a list are played once in random order)
  -  If the REPEAT button is pressed yet once again the Continuous Shuffle function is activated (All MP3 songs in a list are played in random order)
  - If the REPEAT button is pressed still yet once again the Repeat function is deactivated

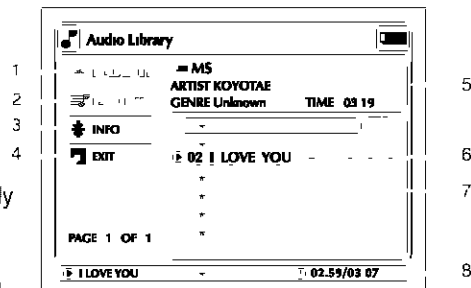

# Memory Stick Removal

1. If using DPM (Digital Photo Manager) or DAM (Digital Audio Manager), move to Exit, and then press the ENTER button to exit to Start Menu.
2. Move to the "STOP MEMORY STICK" function at the bottom of the menu and then press the ENTER button.
3. When the "PLEASE REMOVE MEMORY STICK" message appears on the top of the menu, remove the Memory Stick.
4. If the above sequence is not followed and the Memory Stick is inadvertently removed or the power is turned off, the data recorded on the Memory Stick may be corrupted.

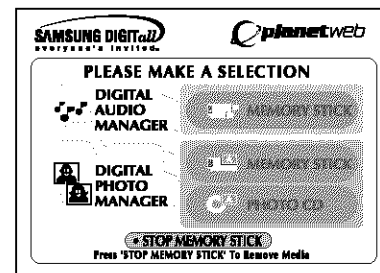
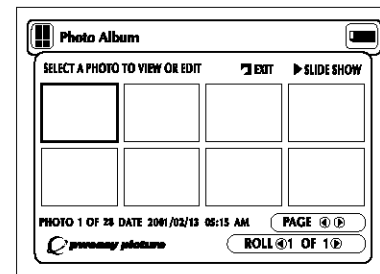

# DPM (Digital Photo Manager) Playback

## View Photo Album (Memory Stick/Photo CD)

- 1 Press Stop if in play mode
- 2 Press the M STICK button on the remote and the screen to the right will appear
- 3 Insert the Memory Stick/Photo CD containing JPEG files into the Memory Stick Slot
- 4 Press the UP/DOWN buttons on the remote control to select DIGITAL PHOTO MANAGER and then press the ENTER button
  - Your selection is highlighted with yellow borders
- 5 JPEG files in the Memory Stick/Photo CD will be displayed on the screen in the order of their recording
- 6 Use the UP/DOWN/LEFT/RIGHT buttons to select the image you want, and then press the ENTER button to display it in full view on the TV screen, or use the UP/DOWN/LEFT/RIGHT buttons to select SLIDE SHOW and then press the ENTER button to begin the slide show. Slides will be displayed in order for a few seconds at a time

### NOTE:

The Auto Power Off function does not work while any DPM function is active

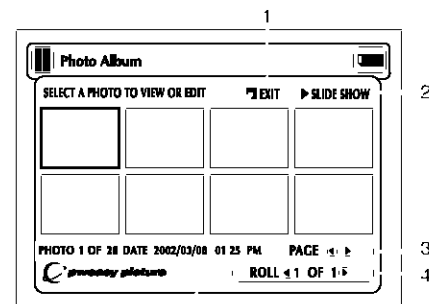
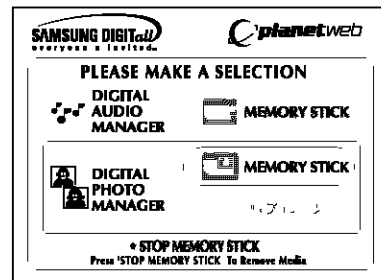

### Screen Configuration

- 1 **EXIT** Takes you to the Start menu
- 2 **SLIDE SHOW** Begins the slide show
- 3 **PAGE** Highlight the PAGE menu item and use LEFT/RIGHT buttons to move to the next page of thumbnails
- 4 **ROLL** Allows navigation when there are multiple directories below /DCIM of Memory Stick (See page 42)
- 5 **Photo Information**

## Slide Show

---

- 1 Use the UP/DOWN/LEFT/RIGHT buttons on the remote control to select Slide Show
  - Your selection is highlighted with yellow borders
- 2 Press the ENTER button and the Slide Show will begin
  - To execute any function or option be sure to press the ENTER button after selecting the menu item you want
  - If there is no input for 5 seconds, the Slide Show menu will disappear, and the slide show will begin
  - To view the Slide Show menu, press the UP/DOWN/LEFT/RIGHT button on the remote control. The slide show will stop and the menu will be displayed
  - Select the PLAY menu item to resume

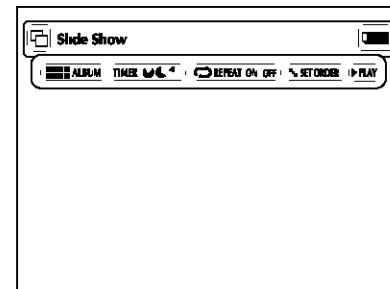

### Menu Description

- **ALBUM** Takes you back to the Photo Album
- **TIMER** Indicates the delay between images in a slide show
- **REPEAT** If ON is selected the slide show will repeat indefinitely
- **SET ORDER** Use to change the order of images in a slide show
- **PLAY** Begins the slide show

## Slide Show Order

- 1 Use the LEFT/RIGHT buttons to select Slide Show and press ENTER
- 2 Use the LEFT/RIGHT buttons to select Set Order and press ENTER
- 3 Use the UP/DOWN/LEFT/RIGHT buttons on the remote control to select the image you want to move, and then press the ENTER button
  - Your selection is highlighted with yellow borders
- 4 Use the UP/DOWN/LEFT/RIGHT buttons on the remote control to select the location you want to move the image to and then press the ENTER button
  - Source location is indicated with yellow borders. Destination location is indicated with green borders
- 5 After moving the images to another location, you can begin the slide show by choosing START SHOW
  - For those images you don't want to include in the slide show select the image from the Slide Show Order screen, and then press the CLEAR button

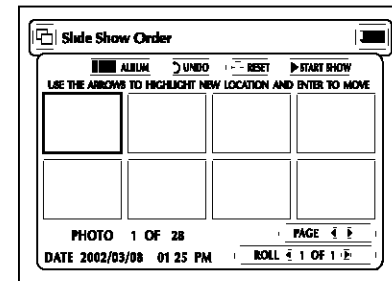

**NOTE:** • Slide Show order will reset when you turn player off

### Menu Description

- **ALBUM** Takes you to Photo Album
- **UNDO** Restores the image you moved most recently to its original location
- **RESET** Restores all the images to their original locations
- **START SHOW** Begins the slide show

## Photo View

- 1 Use the UP/DOWN/LEFT/RIGHT buttons on the remote control to select the desired image from the Photo Album screen, and then press the ENTER button
  - The selected image will appear on the TV screen
- 2 Use the UP/DOWN/LEFT/RIGHT buttons on the remote control to move to the menu item you want, and then press the ENTER button
  - If there is no input for 5 seconds, the Photo View menu will disappear. To view the menu again, press the UP/DOWN/LEFT/RIGHT button

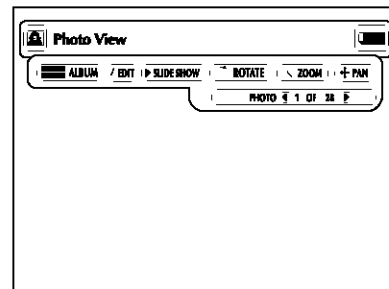

### Menu Description

- **ALBUM** Takes you to Photo Album
- **EDIT** You can apply various effects to the selected image. This is only for viewing; the edited image cannot be saved.
- **SLIDE SHOW** Begins the slide show
- **ROTATE** Each time the ENTER button is pressed, the image will rotate clockwise 90 degrees.
- **ZOOM** Each time the ENTER button is pressed, the image will enlarge up to 6X Normal --> 2X --> 4X --> 6X --> Normal
- **PAN** Press the ENTER button followed by the UP/ DOWN/ LEFT or RIGHT button to move the image in the direction of the arrow.
- **PHOTO** ◀ 1 OF 11 ▶ When the Photo menu item is highlighted, the LEFT/RIGHT button moves to the next/previous images.



## Edit Photo

- 1 From the Photo View screen, use the UP/DOWN/LEFT/RIGHT buttons to select EDIT, and then press the ENTER button
  - The Edit Photo menu appears
- 2 Use the UP/DOWN/LEFT/RIGHT buttons on the remote control to move to the menu item you want, and then press the ENTER button
  - If there is no input for 5 seconds, the Edit Photo menu will disappear To view the menu again press the UP/DOWN/LEFT/RIGHT button

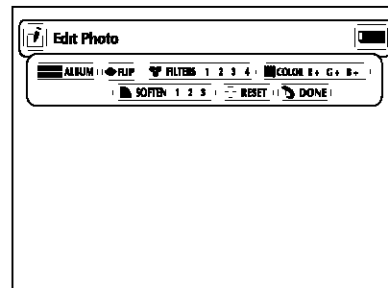

### Menu Description

- **ALBUM** Takes you back to the Photo Album
- **FLIP** Shows the mirror image
- **FILTERS 1234** You can apply various effects to the selected image
  - 1 Black and white filter
  - 2 Sepia (brown) filter
  - 3 Image negative filter
  - 4 Color negative filter
- To restore the image to its original state select RESET from the menu and then press the ENTER button
- **COLOR R + - G + - B + -**  
Adjust Red Green and Blue color balances each time ENTER is pressed
- **SOFTEN 123** Highlight 1 of 3 desired effects 1) softens edges, 2) blurs the image and 3) creates an impressionist painting effect
- **RESET** Restores the image to its original state before the change was made
- **DONE** Returns you to the Photo View screen

## Using the Setup Menu

The Setup menu lets you customize your DVD player by allowing you to select various language preferences, set up a parental level, even adjust the player to the type of television screen you have

1 With the unit in Stop mode, press the SETUP button on the remote

### 1 Language

- **Player Menu** Setup of the Display Language

Use the Player preference menu to select the language for the player's on-screen displays

- **Disc Menu** Setup of the Menu Language

Use the Menu preference menu to select the language you want a DVD's disc menu to be displayed in

- **Audio** Setup of the Audio Language

Use the Audio preference menu to select the soundtrack language

- **Subtitle** Setup of the Subtitle Language

Use the Subtitle preference menu to select the language the disc's subtitles are to be displayed in

### 2 Parental Setup of the Parental Level

Allows users to set the level necessary to prevent children from viewing unsuitable movies such as those with violence, adult subject matter, etc

### 3 Audio Setup of the Audio Options

### 4 Display Setup of the Display Options

Use to select which type of screen you want to watch and several display options

2 Use the UP/DOWN buttons on the remote to access the different features

3 Press the ENTER button to access the sub features

To make the setup screen disappear after setting up, press the SETUP button again

### NOTE:

Depending on the disc, some Setup Menu selections may not work

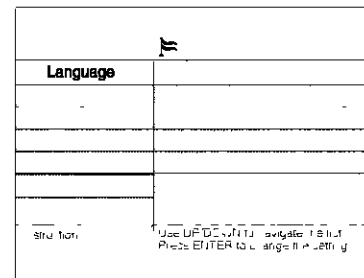

# Setting Up the Language Features

If you set the player menu, disc menu, audio and subtitle language in advance, they will come up automatically every time you watch a movie.

## Using the Player Menu Language

- 1 With the unit in Stop mode, press the SETUP button. Then press the ENTER button.
- 2 Use the UP/DOWN buttons to select the **Player Menu**.
- 3 Press the ENTER button.
- 4 Use the UP/DOWN/LEFT/RIGHT buttons to select **English**.
- 5 Press the ENTER button.
  - English is selected and the screen returns to SETUP MENU.
  - To make the SETUP MENU disappear, press the RETURN button.

**NOTE:** • English is used as an example on the following pages.

## Using the Disc Menu Language

This function changes the text language only on the disc menu screens.

- 1 With the unit in Stop mode, press the SETUP button. Then press the ENTER button.
- 2 Use the UP/DOWN buttons to select **Disc Menu**.
- 3 Press the ENTER button.
- 4 Use the UP/DOWN/LEFT/RIGHT buttons to select **English**.
  - Select **Others** if the language you want is not listed.
- 5 Press the ENTER button.
  - English is selected and the screen returns to SETUP MENU.

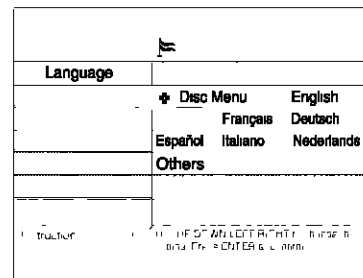
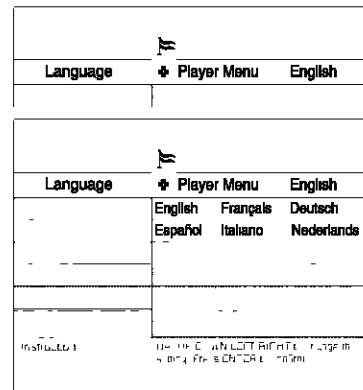

# Setting Up the Language Features

## Using the Audio Language

- 1 With the unit in Stop mode, press the SETUP button. Then press the ENTER button.
- 2 Press the UP/DOWN buttons to move to **Audio**.
- 3 Press the ENTER button.
- 4 Press the UP/DOWN/LEFT/RIGHT buttons to select **English**
  - Select **Original** if you want the default soundtrack language to be the original language the disc is recorded in.
  - Select **Others** if the language you want is not listed.
- 5 Press the ENTER button
  - English is selected and the screen returns to SETUP MENU.

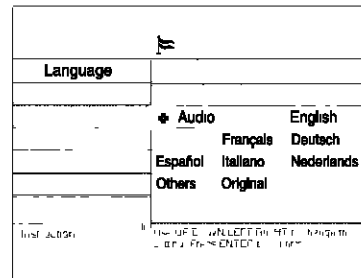

## Using the Subtitle Language

- 1 With the unit in Stop mode, press the SETUP button. Then press the ENTER button.
- 2 Use the UP/DOWN buttons to select **Subtitle**.
- 3 Press the ENTER button.
- 4 Use the UP/DOWN/LEFT/RIGHT buttons to select 'English'
  - Select **Automatic** if you want the subtitle language to be the same as the language selected as the audio preference.
  - Select **Others** if the language you want is not listed. Some discs may not contain the language you select as your initial language, in that case the disc will use its original language setting.
- 5 Press the ENTER button
  - English is selected and the screen returns to SETUP MENU.

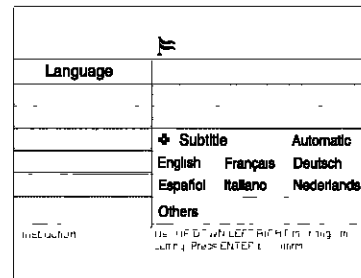

### NOTE:

- If the selected language is not recorded on the disc, the original pre-recorded language is selected.
- **How to make the SETUP MENU disappear or return to menu screen during set up;** Press RETURN button.

# Setting Up the Parental Control

The Parental Control function works in conjunction with DVDs that have been assigned a rating - which helps you control the types of DVDs that your family watches. There are up to 8 rating levels on a disc.

1. With the unit in Stop mode, press **SETUP** button. The Setup Menu screen appears.
2. Use **UP/DOWN** to select Parental. Press **ENTER**. The **Parental Control** screen appears.
3. Use **LEFT/RIGHT** to select On if you want to use a password. The Enter Password screen appears.
4. Enter your password with the **UP/DOWN/LEFT/RIGHT** buttons. The Re-enter Password screen appears to confirm the password. Enter your password again. The Parental Control screen appears.

## 5. About the Rating Level ;

- The Rating Level will work only when Use Password is set to On. To unlock the player, use **LEFT/RIGHT** to select Off. Use **UP/DOWN** to select Rating level. Press **ENTER**.
- Use **UP/DOWN** to select the level(e.g. Level 6) and press **ENTER**. Discs that contain Level 7 will now not play.
  - To cancel the rating level, use **LEFT/RIGHT** to select Off in use Password.

## 6. About the Change Password ;

- Use **UP/DOWN** to select Change Password. The Change Password screen appears.
- Enter your new password. Re-enter the new password again.

## NOTE:

- **How to make the SETUP MENU disappear or return to menu screen during set up;**  
Press **RETURN** button.
- If you have forgotten your password, see Forgot Password in the Troubleshooting Guide.

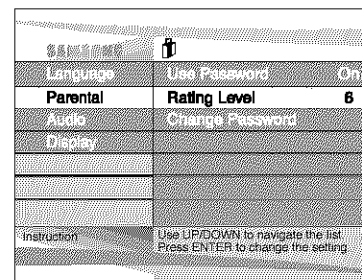
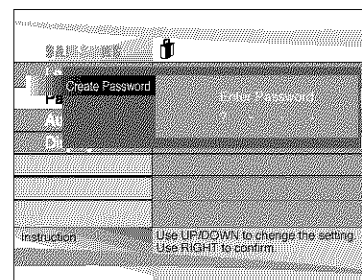
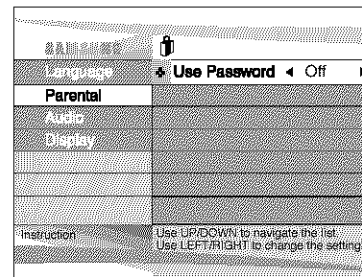

## Setting Up the Audio Options

1. With the unit in Stop mode, press the SETUP button.
2. Use the UP/DOWN buttons to select **Audio**. Then press the ENTER button.
3. Use the UP/DOWN buttons to select the desired item. Then press the LEFT/RIGHT buttons.

### ① Digital Output

1. PCM : Converts to PCM(2CH) audio. Select PCM when using the Analog Audio Outputs.
2. Bitstream : Converts to Dolby Digital Bitstream (5.1CH). Select Bitstream when using the Digital Audio Output.

**NOTE:** Be sure to select the correct Digital Output or no audio will be heard.

### ② DTS

1. Off : Digital signal is not output.
2. On : Outputs DTS Bitstream via digital output only.  
Select DTS when connecting to a DTS Decoder.

### ③ Dynamic Comp.(Compression)

1. On : To select dynamic compression.
2. Off : To select the standard range.

### ④ 2x Scan Audio

1. Off : Turns 2X audio off. Though 2X Scan Audio is ON in the SETUP MENU, no sound will be heard on discs which are recorded with LPCM, DTS or MPEG-2 Audio.
2. On : Turns 2X audio on.

### **NOTE:**

- **How to make the SETUP MENU disappear or return to menu screen during set up;**  
Press RETURN button.
- Manufactured under license from Dolby Laboratories.  
“Dolby” and the double-D symbol are trademarks of Dolby Laboratories.
- “DTS” and “DTS Digital Out” are trademarks of Digital Theater Systems, Inc.

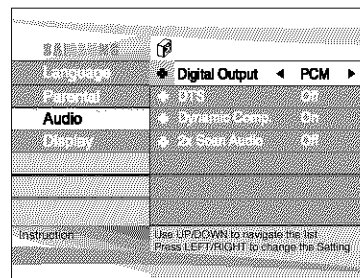

# Setting Up the Display Options

1. With the unit in Stop mode, press the SETUP button.
2. Use the UP/DOWN buttons to select **Display**.  
Then press the ENTER button.
3. Use the UP/DOWN buttons to select the desired item.  
Then press the LEFT/RIGHT buttons.

## ① TV Aspect

Depending on the type of television you have, you may want to adjust the screen setting (aspect ratio).

### - Letter Box :

Select when you want to see the total 16:9 ratio screen DVD supplies, even though you have a TV with a 4:3 ratio screen.

Black bars will appear at the top and bottom of the screen.

### - Pan-Scan :

Select this for conventional size TVs when you want to see the central portion of the 16:9 screen. (Extreme left and right side of movie picture will be cut off.)

### - Wide :

You can view the full 16:9 picture on your widescreen TV.

## ② Still Mode

These options will help prevent picture shake in still mode and display small text clearer.

- Auto : When selecting Auto, Field/Frame mode will be automatically converted.

- Field : Select this feature when the screen shakes in the Auto mode.

- Frame : Select this feature when you want to see small letters more clearly in the Auto mode.

## ③ Screen Messages

Use to turn on screen messages On or Off.

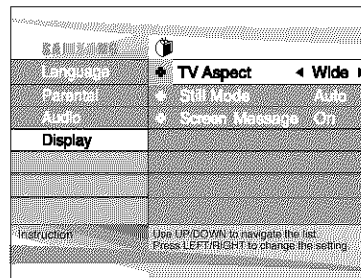

## Cautionary Notes

---

### Cautions on Using the Player

• **Avoid magnetic environments.**

Using the player under strong fluorescent lighting, in a car, near a TV or magnetic object may deteriorate recorded images

• **Be sure to remove the disc, turn off the player, and remove the battery pack after use**

• **If used near a broadcast station or power transmission tower, the video may become distorted due to interference.**

• **Do not drop the player or subject it to strong vibration or shock.**

• **Do not place the player near a lamp**

Heat from the incandescent light bulbs may cause deformation or malfunction

• **Always observe the rules regulating the use of electrical devices on airplanes**

• **Do not expose this product to high temperature and humidity.**

This product can be operated within temperature range of 50°F~86°F and humidity range of 30%~80%.

Do not expose this product to direct sunlight or in a car with its windows closed. Doing so may result in deformation of casing and circuitry as well as cause fire or bodily injury

• **Do not let water, sand, dust, or other foreign objects in the player. Avoid using or storing the player in a place where there is smoke, steam, or moisture.**

Doing so may cause malfunction or mold on the pick-up lens. Keep the player in a well-ventilated area

• **When using the player in cold environments, the color LCD screen may not be visible immediately after the power is turned on.**

This is not a malfunction. Do not operate the player in temperatures below 50°F

• **Be especially careful not to scratch the pick-up lens during loading/unloading of the disc, or cleaning.**

Doing so may result in malfunction



# Cautionary Notes

---

## When Moving the Player

- **Be sure to remove the disc from the player before packing for moving.**

It is recommended that you also remove the disc from the player and turn off the power when not using the player

## Saving Power

- **It is recommended that you turn off the power to the DVD player when not use If you are not going to use it for prolonged period of time, unplug the power cord from the wall outlet**

## Maintenance of LCD Screen

- **To keep the screen clean, turn off the power and then wipe with a soft cloth.**

## About LCD Screen

- This LCD panel is designed with the latest technology ensuring 99.99% of active pixels  
That is less than 0.01% of total pixels will have any defect (e.g., always off or always on)

# Cautionary Notes

---

## Cautions on Using Battery pack

### Danger!

Always follow the safety information below when using the battery pack. Otherwise, a short circuit, overheating, smoke, fire, or damage to the product may result.

- 1 Never disassemble or modify the battery pack in any way. Do not touch the terminal of the battery pack with a metal object.
- 2 Do not let any metal object inside the battery pack.
- 3 Do not place the battery pack in direct sunlight, dashboard of a vehicle, or high temperature.
- 4 Do not expose the battery pack to water, fire, or heat.
- 5 Always use the included AC adapter when charging the battery pack.
- 6 This battery pack is designed exclusively for your portable DVD player. Do not use it with other devices.

### Warning!

- 1 Do not drop or subject to strong vibration.
- 2 Keep out of reach of children.
- 3 The battery pack may leak fluid that is harmful to your eyes. If this fluid gets in your eyes, wash eyes immediately with large amounts of running water and get medical attention immediately. If the fluid gets on your skin or clothing, wash immediately with water.

### Caution!

- 1 When not using the battery pack, remove it and store in a cool place.
- 2 Do not use the AC adapter or battery pack for a prolonged period of time during recharging. You might get a low temperature burn.
- 3 Keep the battery pack free from smoke, steam, moisture, and dust.
  - Do not place the battery pack near a kitchen, heater, or any other place where there is smoke or steam. Doing so may result in fire or electric shock.
  - Avoid direct sunlight, heater, or high temperature place, etc. inside of a car. It can cause explosion or fire. Doing so may cause a short circuit, overheating, smoke, fire, or damage to the product.
- 4 Using the battery pack under 32°F or over 86°F can cause reduced battery life.

## Cautionary Notes

---

### After a Recharge, Store the Battery pack Separately.

- This battery pack is a lithium ion battery. Even when not in use, power will drain slowly. So use a fully charged battery pack.
- Recharge until the charge lamp stays on green. A partial charging of the battery pack decreases the overall lifetime of the battery.

### Cautions on Charging Battery pack

- Charge within the surrounding temperature range of 50°F~86°F. Charging at a low surrounding temperature slows down the charging time and decreases the battery pack. You cannot fully charge the battery pack at high temperature.
- If the DVD player is overheated and the battery pack's internal temperature goes up to a certain level, you will not be able to charge the battery pack. (The lamp flashes quickly and the light does not come on.)  
In this case, remove the battery pack. After the internal temperature reaches a safe level, charging will begin automatically.
- The battery pack becomes warm during recharge or use. This is normal and is not a cause for concern.  
A hot battery pack may take longer to charge or may not be charged at all. Wait until the battery pack cools down before charging.

### Battery pack Life and Use (Low Temperature)

- The lifetime of the battery pack is limited.  
Power is slowly drained even when not using. Though it varies for differing storage conditions, the battery pack stored unused for a year has a much shorter lifetime.  
If the battery pack does not last long even after a full charge, you might have to replace it with a new one.
- Total operating time of the battery pack becomes much shorter when used at temperature below 50°F.  
Electrical energy is discharged due to internal chemical action of the battery pack. A very low temperature may impede this chemical action and shortens the total operating time.

### Caution

- Be sure to use only the battery pack exclusively designed for your DVD player.

### NOTE:

- When not using the DVD player, always turn off the power to conserve the battery pack. If the AC adapter is connected to the player, charge the battery pack with the power to the player turned off.

## Cautionary Notes

---

### Cautions on Storing Battery pack

- Even when not in use, power is consumed continuously. To reduce the power consumption, follow the procedure below.
  1. Remove the battery pack from the DVD player after every use.
  2. When not using the DVD player, turn off the power. If the player is left in the standby mode, power will be slowly drained from the battery pack and the charging capacity will decrease.
  3. Before storing the battery pack, completely drain the power by operating the player and store in a cool, dry place. If stored in a hot place, the capacity of the battery pack will decrease.
  4. The battery pack must be recharged and then used on the DVD player at least once every 6 months. This helps to prevent the loss of capacity.

### AC Adapter

The supplied AC adapter is compatible with 50/60Hz electrical system (110V~240V range). Use of the AC adapter depends on the specific voltage requirements and electrical outlet design.

- Using the AC adapter near a radio may cause poor reception.
- Do not let any type of flammables, liquid, or metal objects in the adapter.
- The adapter is covered with an outer plastic sheath. Do not peel open the sheath.
- Do not drop, jar, or shake the adapter.
- Do not place in direct sunlight.
- Do not use in high temperature or cold and humid environments.

### Cleaning and Maintenance

- Many plastic parts are used in this DVD player casing. Do not use volatile chemicals such as benzene or thinner. This might damage the finish.
- Wipe the casing with a soft, dry cloth. For excessive dirt, use a cloth dampened in a diluted neutral detergent. and wipe again with a soft, dry cloth.
- Wipe off fingerprints or dirt on the LCD screen using a soft, dry cloth.

# Troubleshooting

If your DVD player does not seem to be functioning properly, check the items below before you contact a Samsung authorized service center.

Symptom	Check
Power does not turn on or suddenly turns off.	<ul style="list-style-type: none"> <li>• Make sure the AC power cord is securely plugged into an AC outlet.</li> <li>• Turn the power off and then back on.</li> </ul>
Battery pack is in place but the power does not turn on or suddenly turns off	<ul style="list-style-type: none"> <li>• Check that the battery pack is charged. If not, recharge it.</li> </ul>
Remote control won't work	<ul style="list-style-type: none"> <li>• Check that the battery is inserted in the "+" and "-" directions properly.</li> <li>• The batteries may be dead. Replace them with new batteries.</li> <li>• Check that the signal transmission is directed at the remote control sensor on the DVD player.</li> <li>• Remove the obstacle between the remote control unit and remote control sensor.</li> </ul>
No picture or sound	<ul style="list-style-type: none"> <li>• Check that the video and audio cables are securely connected.</li> <li>• Check that the disc is a DVD (region number 1 or all), DVD-RW, VIDEO CD, or AUDIO CD.</li> <li>• Do not use a disc that has scratches or dirt.</li> <li>• Check that the label-side of the disc is facing up.</li> <li>• The pick-up lens of the DVD player may be dirty. Contact the service center for lens cleaning.</li> <li>• Check that the TV channel is set to VIDEO or AV if viewing with a TV.</li> </ul>
Forgot password	<ul style="list-style-type: none"> <li>• Press power on from a cold start with no disc in the unit. Press the STOP and PLAY buttons simultaneously on the unit for three seconds. The Select Menu Language display will appear. Select the desired language button. Press the SETUP button on the remote control to select the Parental Mode. The Parental Mode is now unlocked as indicated on the display. Press the DOWN button to select Parental. Press ENTER and the Create Password display will appear. You can now set your rating level and change your password to a new number.</li> </ul>

**The built-in micro controller can be influenced by external electrical noise. If you believe this may be the cause of the problem, turn off the DVD player and then back on.**

# Troubleshooting

---

Symptom	Check
No picture	<ul style="list-style-type: none"> <li>• Check that the LCD display is turned on.</li> </ul>
No sound	<ul style="list-style-type: none"> <li>• Check that the display panel is open. If it is closed, audio will not be output to the speakers.</li> <li>• Check the volume setting. If set to zero, turn up volume level.</li> <li>• Check that the headphones are plugged into the PHONES and Audio jack. Speakers cannot be used with the headphones.</li> </ul>
No picture and sound	<ul style="list-style-type: none"> <li>• Check that the DVD player is in the DVD mode and not in the INPUT mode.</li> </ul>
Distorted video or sound	<ul style="list-style-type: none"> <li>• Use a disc without scratches or dents.</li> <li>• Check that external speakers do not jam the built-in speakers.</li> </ul>
While in the input mode, no picture is output from the external component to the DVD player	<ul style="list-style-type: none"> <li>• Check that the video or audio cable is securely connected.</li> <li>• Make sure the S-Video cable is used for output only.</li> <li>• Check that the DVD player is in the INPUT mode and not in the DVD mode.</li> </ul>

# Troubleshooting

Symptom		Check
DVD	Video does not appear on with a external component connected to the DVD player	<ul style="list-style-type: none"> <li>• Check that the TV is set to VIDEO or AV.</li> <li>• Check that the video or audio cable is securely connected.</li> </ul>
	Dolby Digital audio volume is too low	<ul style="list-style-type: none"> <li>• Change the "Dynamic Comp." setting to "On". This will turn up the comparatively low volume level of Dolby Digital, which provides the most wide, dynamic sound range.</li> </ul>
Battery pack operation	Battery pack won't charge	<ul style="list-style-type: none"> <li>• Check that the DVD player is turned off. You cannot charge the battery pack with the player turned on.</li> <li>• A hot battery pack may take longer to charge. Wait until the battery pack is sufficiently cooled down.</li> </ul>
	Power does not turn on	<ul style="list-style-type: none"> <li>• Replace with a fully charged battery pack or use the AC adapter.</li> </ul>
	Power charge lamp does not light (Battery pack won't charge)	<ul style="list-style-type: none"> <li>• Replace with a fully charged battery pack or use the AC adapter. If the DVD player is overheated and the battery pack's internal temperature goes up to a certain level, you will not be able to charge the battery pack. In this occurs, remove the battery pack. After the battery pack has sufficiently cooled down, charging will begin automatically.</li> <li>• Check that the temperature is within the range of 50°F~86°F.</li> <li>• Check that the DC cord of the AC adapter is Plugged in correctly.</li> </ul>
Battery pack operation	Power charge lamp quickly flashes Green	<ul style="list-style-type: none"> <li>• Remove the DC cord from the battery pack and then re-plug. If the battery pack is installed, remove the DC cord from the battery pack before performing above procedure.</li> <li>• Recharge a different power pack. If the same symptom occurs, your AC adapter may be defective. If the second battery pack charges without any problem, your first battery pack may be defective or needs battery replacement.</li> </ul>

# Specifications

General	Power Requirements	AC 120V, 60 Hz
	Power Consumption	16 W
General	Weight	2.5 lbs (without battery pack)
	Dimensions	W 10.5 in x D 7.1 in x H 1.1 in
General	Operating Temperature Range	+50°F to +86°F
	Operating Humidity Range	30% to 80%
Disc	DVD (DIGITAL VERSATILE DISC)	Reading Speed 11.45 ft/sec Approx. Play Time (Single Sided, Single Layer Disc) 135 min
	CD 5 (COMPACT DISC)	Reading Speed 3.9 to 4.6 ft/sec Maximum Play Time 74 min
	CD 3+2' (COMPACT DISC)	Reading Speed 3.9 to 4.6 ft/sec Maximum Play Time 20 min
	VCD 5"	Reading Speed 3.9 to 4.6 ft/sec Maximum Play Time 74 min (Video + Audio)
Video Output	Composite Video	1 channel 1.0 Vp-p (75 Ω load)
	Component Video	Y 1.0 Vp-p (75 Ω load) Pr 0.70 Vp-p (75 Ω load) Pb 0.70 Vp-p (75 Ω load)
Video Output	S-VIDEO	Luminance Signal 1.0 Vp-p (75 Ω load) Chrominance Signal 0.286 Vp-p (75 Ω load)
Audio Output	2 Channel	L1/L; R1/R;
	*Frequency Response	48 kHz Sampling 4 Hz to 22 kHz 96 kHz Sampling 4 Hz to 44 kHz
	*S/N Ratio	110 dB
	*Dynamic Range	100 dB
	*Total Harmonic Distortion	0.004 %

\* Nominal specification

- Samsung Electronics Co., Ltd. reserves the right to change the specifications without notice.
- Weight and dimensions are approximate.



# Warranty

---

## LIMITED WARRANTY TO ORIGINAL PURCHASER

This SAMSUNG brand product, as supplied and distributed by SAMSUNG ELECTRONICS AMERICA, INC. (SAMSUNG) and delivered new in the original carton to the original consumer purchaser, is warranted by SAMSUNG against manufacturing defects in materials and workmanship for the following limited warranty period:

### One (1) Year Parts and Labor

This limited warranty begins on the original date of purchase and is valid only on products purchased and used in the United States and does not include transportation, installation, removal or reinstallation. Warranty repairs must be performed by SAMSUNG's authorized service center. To receive warranty service, the original dated bill of sale must be presented upon request as proof of purchase to SAMSUNG or SAMSUNG's authorized service center. Transportation to and from the service center is the responsibility of the purchaser.

SAMSUNG will repair or replace this product, at our option and at no charge with new or reconditioned parts, if found to be defective during the limited warranty period specified above. The product must be returned during the warranty period with transportation charges prepaid to SAMSUNG's designated service center. Prior to returning any product for warranty service, the purchaser must contact SAMSUNG for problem determination and service procedures. SAMSUNG does not warrant uninterrupted or error-free operation of the product. All replaced parts and products become the property of SAMSUNG and must be returned to SAMSUNG. Replacement parts and products assume the remaining original warranty, or ninety (90) days, whichever is longer.

This limited warranty covers manufacturing defects in materials and workmanship encountered in normal noncommercial use of this product and shall not apply to the following, including, but not limited to: damage which occurs in shipment, applications and uses for which this product was not intended; failures or problems which are caused by products or equipment not supplied by SAMSUNG; accidents, misuse, abuse, neglect, misapplication, fire, water, lightning or other acts of nature; incorrect electrical line voltage, fluctuations or surges; damage caused by improper or faulty installation, improper connection with any peripheral; product alteration or modification; improper or unauthorized repair; cosmetic damage or exterior finish; product with altered serial numbers; failure to follow operating instructions; customer adjustments; maintenance and environmental instructions that are covered and prescribed in the instruction book; use of non-SAMSUNG or unauthorized parts, supplies, accessories or equipment which damage this product or result in service problems; failures or problems due to incompatibility with other equipment.



**ELECTRONICS**

SERVICE DIVISION  
400 Valley Road, Suite 201  
Mt. Arlington, NJ 07856  
[www.samsungusa.com](http://www.samsungusa.com)

FOR YOUR NEAREST SAMSUNG  
SERVICE CENTER™  
DIAL 1-800-SAMSUNG  
AK68-00052A

**US**