

DVD 50 5-Disc DVD Changer

OWNER'S MANUAL

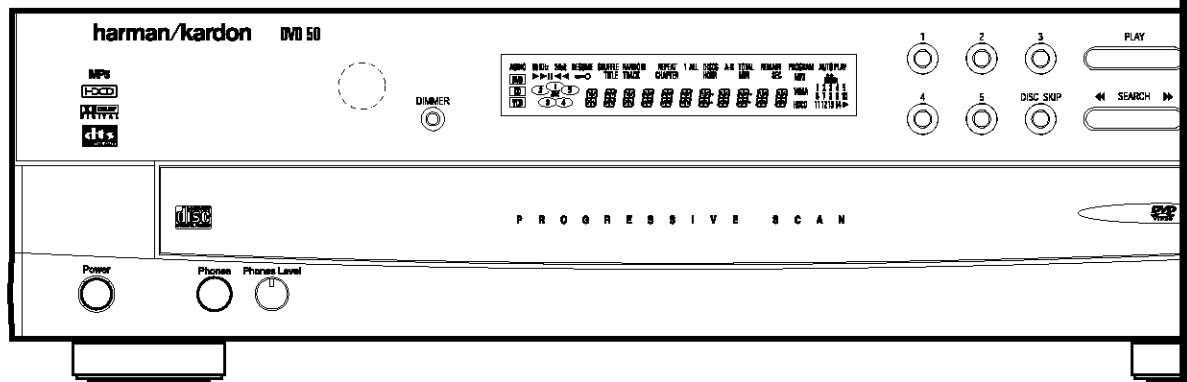

harman/kardon®

Power for the Digital Revolution.™

DVD 50 5-Disc DVD Changer

3	Introduction
4	Safety Information
5	DVD Compatibility & Terminology
6	Front Panel Controls
7	Front Panel Information Display
9	Rear Panel Connections
10	Remote Control Functions
13	Installation and Connections
18	Setup Menu
18	Remote Control Operation
19	Audio Language Selection
19	Subtitle Language Selection
20	Menu Language Selection
20	Ratings Selection and Password Control
21	Aspect Ratio
22	Video Output
23	DVD Auto Play
24	Dynamic Range Setting
24	Digital Audio Out
26	Playback Basics for All Formats
26	Loading Discs
29	DVD Playback
29	Using a DVD's Menu
30	Using the On-Screen Menu Bar for DVD Playback
30	Selecting Titles and Chapters
30	Changing the Audio Track
31	Changing Subtitle Languages
31	Changing Camera Angles
32	CD Playback
33	MP3 Playback
34	VCD Playback
35	Programmed Play
35	Random Play
36	Programmed Play
37	Bookmarks
38	DVD Language Codes
39	Troubleshooting Guide
40	Technical Specifications

Typographical Conventions

In order to help you use this manual with the remote control, front panel controls and rear panel connections, certain conventions have been used.

EXAMPLE – (bold type) indicates a specific remote control or front panel button, or rear panel connection jack

EXAMPLE – (OCR type) indicates a message that is visible on the front panel information display

1 – (number in a square) indicates a specific front panel control

1 – (number in an oval) indicates a button or indicator on the remote

1 – (number in a circle) indicates a rear panel connection

A – (letter in a square) indicates an indicator in the front panel display

A – (letter in a triangle) indicates a connection option in the installation process

Introduction

Thank you for choosing the Harman Kardon DVD 50. The DVD 50 is a multipurpose five-disc player that delivers the highest level of playback quality from a wide range of optical media formats. Along with conventional DVD and CD audio discs, the DVD 50 is also compatible with CD-R and CD-RW discs, discs with HDCD[®] encoding, VCD discs and discs recorded with audio files in the MP3 format. However, the DVD 50 does more than simply play discs in this extensive list of formats, it plays them flawlessly, and provides output signals that match the capabilities of the latest audio and video display technologies.

On the video side, the DVD 50 is one of the first 5-disc changers to offer progressive scan video outputs for use with digital "HDTV-Ready" display monitors. Using a high-speed, single-chip digital processor, the DVD 50 is capable of reconstructing the 3/2 pull-down effect introduced when film-based programs are transferred to video. In conjunction with precision video output DACs, the end result is a full 60-frame-per-second output that is the closest thing to film this side of your local cinema. Of course, traditional Y/Pr/Pb component video, S-Video and composite video outputs are also available for use with conventional televisions and video projectors.

In keeping with our tradition as a leader in audio technology, Harman Kardon has packed the DVD 50 with the latest features, including audiophile-grade Wolfson audio output DACs and full compatibility with 96kHz audio programming. Both coaxial and optical digital outputs are available for direct connection to A/V receivers or surround processors so that you may take advantage of Dolby Digital* and DTS[®] soundtracks. CD playback is enhanced through the use of HDCD technology, which provides optimal playback resolution from HDCD-encoded discs and enhanced playback of all CDs. Finally, built-in MP3 decoding allows music discs created and finalized on a computer to be played back through your home-theater system for increased listening pleasure.

A wide range of programming features makes it easy to program an evening's worth of entertainment, selecting from tracks on multiple discs. When playing DVDs, easy-to-understand on-screen menus and icons make it simple to change languages, soundtracks, subtitles or aspect ratio, while a parental-lock function enables you to control which discs may be viewed by younger members of the household.

DVD players are among the fastest growing consumer electronics products ever brought to market, but this may, nevertheless, be the first DVD player you've owned. Although many of the features of the DVD 50 resemble those of standard CD changers or players, there are a number of functions that you may be unfamiliar with. To ensure that you are able to take advantage of all the power and flexibility the DVD 50 has to offer, we encourage you to review this manual. That small investment of your time will pay major dividends in the enjoyment you will get from proper use of the DVD 50.

If you have additional questions about this product, or its installation or operation, that are not answered in this manual, please contact your dealer, as he is your best source of local information. You may also contact Harman Kardon via e-mail through our Web site at www.harmankardon.com.

Special Features

- Plays a wide range of video and audio formats, including DVD-Movie discs, VCD, standard CD audio discs, CD-R/RW audio discs, MP3 discs and HDCD-encoded discs
- High-quality video playback 10-bit DACs, progressive scan and component video outputs
- Dolby Digital and DTS data signal output through both optical and coaxial digital audio connections
- Audiophile-grade Wolfson output DACs for the finest audio reproduction
- Easy-to-use on-screen navigation system
- Playback of MP3 audio discs with text display
- HDCD decoding for optimal playback of HDCD-encoded discs and superior reproduction of all CDs
- Extensive programming capability for audio and video discs
- Parental lock controls prevent unauthorized viewing of restricted movies
- Multiple options for language, soundtrack and subtitle selection
- Multiple-angle capabilities with specially encoded DVD discs
- Bookmark function for easy return to favorite scenes
- Backlit, ergonomically designed remote control
- Five-disc-capacity changer with play-exchange feature

NOTE: This player is designed and manufactured for compatibility with Region Management Information that is encoded on most DVD discs. This player is designed only for playback of discs with Region Code 1, or for discs that do not contain Region Code information. If there is any other Region Code on a disc, that disc will not play on the DVD 50.

CAUTION
RISK OF ELECTRIC SHOCK
DO NOT OPEN

CAUTION: To prevent electric shock, do not use this (polarized) plug with an extension cord, receptacle or other outlet unless the blades can be fully inserted to prevent blade exposure.

 The lightning flash with arrowhead symbol, within an equilateral triangle, is intended to alert the user to the presence of uninsulated "dangerous voltage" within the product's enclosure that may be of sufficient magnitude to constitute a risk of electric shock to persons.

 The exclamation point within an equilateral triangle is intended to alert the user to the presence of important operating and maintenance (servicing) instructions in the literature accompanying the appliance.

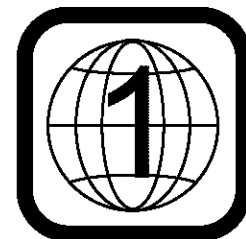

Safety Information

Verify Line Voltage Before Use

Your DVD 50 has been designed for use with 120 – 230-volt AC current, but the plug is specifically designed for 120-volt applications. Connection to a line voltage other than that for which it is intended can create a safety and fire hazard and may damage the unit.

If you have any questions about the voltage requirements for your specific model, or about the line voltage in your area, contact your selling dealer before plugging the unit into a wall outlet.

Do Not Use Extension Cords

We do not recommend that extension cords be used with this product. As with all electrical devices, do not run power cords under rugs or carpets or place heavy objects on them. Damaged power cords should be replaced immediately by an authorized service depot with cords meeting factory specifications.

Handle the AC Power Cord Gently

When disconnecting the power cord from an AC outlet, always pull the plug, never pull the cord. If you do not intend to use the unit for any considerable length of time, disconnect the plug from the AC outlet.

Do Not Open the Cabinet

There are no user-serviceable components inside this product. Opening the cabinet may present a shock hazard, and any modification to the product will void your guarantee. If water or any metal object such as a paper clip, wire or a staple accidentally falls inside the unit, disconnect it from the AC power source immediately, and consult an authorized service station.

Installation Location

- To ensure proper operation, and to avoid the potential for safety hazards, place the unit on a firm and level surface. When placing the unit on a shelf, be certain that the shelf and any mounting hardware can support the weight of the product.
- Make certain that proper space is provided both above and below the unit for ventilation. If this product will be installed in a cabinet or other enclosed area, make certain that there is sufficient air movement within the cabinet.
- Do not place the unit directly on a carpeted surface.
- Avoid moist or humid locations.

- Avoid installation in extremely hot or cold locations, or an area that is exposed to direct sunlight or heating equipment.

- Do not obstruct the ventilation slots on the top of the unit, or place objects directly over them.

Cleaning

When the unit gets dirty, wipe it with a clean, soft, dry cloth. If necessary, wipe it with a soft cloth dampened with mild soapy water, then a fresh cloth with clean water. Wipe immediately with a dry cloth. NEVER use benzene, aerosol cleaners, thinner, alcohol or any volatile cleaning agent. Do not use abrasive cleaners, as they may damage the finish of metal parts. Avoid spraying insecticide near the unit.

Unpacking

The carton and shipping materials used to protect your new receiver during shipment were specially designed to cushion it from shock and vibration. We suggest that you save the carton and packing materials for use in shipping if you move, or should the unit ever need repair.

To minimize the size of the carton in storage, you may wish to flatten it. This is done by carefully slitting the tape seams on the bottom, and collapsing the carton down to a more two-dimensional appearance. Other cardboard inserts may be stored in the same manner. Packing materials that cannot be collapsed should be saved along with the carton in a plastic bag.

If you do not wish to save the packaging materials, please note that the carton and other sections of the shipping protection are recyclable. Please respect the environment and discard those materials at a local recycling center.

Moving the Unit

Before moving the unit, be certain to disconnect any interconnection cords with other components, and make certain that you disconnect the unit from the AC outlet.

IMPORTANT NOTE: To avoid damage to the DVD 50 that may not be covered by the warranty, be certain that all discs are removed from the unit before it is moved. Once the DVD 50 is installed, discs may be left in the unit when it is turned off, but the unit should NEVER be moved with discs left in any of the positions of the disc tray.

Important Information for the User

This equipment has been tested and found to comply with the limits for a Class B digital device, pursuant to Part 15 of the FCC Rules. The limits are designed to provide reasonable protection against harmful interference in a residential installation. This equipment generates, uses and can radiate radio-frequency energy and, if not installed and used in accordance with the instructions, may cause harmful interference to radio communication. However, there is no guarantee that harmful interference will not occur in a particular installation. If this equipment does cause harmful interference to radio or television reception, which can be determined by turning the equipment off and on, the user is encouraged to try to correct the interference by one or more of the following measures:

- Reorient or relocate the receiving antenna.
- Increase the separation between the equipment and receiver.
- Connect the equipment into an outlet on a circuit different from that to which the receiver is connected.
- Consult the dealer or an experienced radio/TV technician for help.

This device complies with Part 15 of the FCC Rules. Operation is subject to the following two conditions: (1) this device may not cause harmful interference, and (2) this device must accept interference received, including interference that may cause undesired operation.

NOTE: Changes or modifications may cause this unit to fail to comply with Part 15 of the FCC Rules and may void the user's authority to operate the equipment.

CAUTION: The DVD 50 uses a laser system. To prevent direct exposure to the laser beam, do not open the cabinet enclosure or defeat any of the safety mechanisms provided for your protection. **DO NOT STARE INTO THE LASER BEAM.** To ensure proper use of this product, please read this Owner's Manual carefully and retain it for future use. Should the unit require maintenance or repair, please contact your local Harman Kardon service station. Refer servicing to qualified personnel only.

DVD Compatibility & Terminology

The DVD 50 is more than a DVD player; it will play the following disc formats:

- Both 5-inch (12cm) and 3-inch (8cm) discs
- DVD movie discs
- CD, CD-R and CD-RW audio discs
- DTS audio discs
- CD audio discs with HDCD encoding
- MP3 discs
- VCD (video CD) discs

However, it will NOT play the following:

- DVD discs with a Region Code other than the one the player is set for.
- DVD discs with PAL format video
- DVD-ROM data discs
- DVD-RAM discs
- CD-I discs
- CD-G discs
- SVCD discs
- Photo CD discs

NOTE: Due to differences in the formats of certain discs, it is possible that some discs may include a mix of features that are not compatible with the DVD 50. Similarly, although the DVD 50 is capable of a wide range of features, not all discs include every capability of the DVD system. For example, although the DVD 50 is compatible with multi-angle discs, that feature is only possible when the disc is specially encoded for multiple-angle play. In addition, the DVD 50 is compatible with both Dolby Digital and DTS soundtracks, but the number and types of tracks available will vary from disc to disc. To make certain that a specific feature or soundtrack option is available, please check the options noted on the disc jacket.

- Playback of DTS audio discs requires connection to a processor or receiver with a DTS decoder.
- Playback capability for CD-RW discs may vary due to variations in the quality of the CD-RW disc and the recorder used to create the disc.

Since they share some of the characteristics and technology of CD players, many of the terms and operational concepts used in a DVD player are similar to what you may be familiar with from CD players and changers, or older video disc formats such as Laser Disc. However, if this is your first DVD product, some of the terms used to describe the features of a DVD player may be unfamiliar. The following explanations should solve some of the mysteries of DVD, and help you to enjoy all the power and flexibility of the DVD format and the DVD 50.

Aspect Ratio: This is a description of the width of a video image in relation to its height. A conventional video screen is four units wide for every three units of height, making it almost square. Newer wide-aspect-ratio video displays are 16 units wide for every nine units of height, making them more like the screen in a movie theater. The program material on a DVD may be recorded in either format and, in addition, you may configure the DVD 50 to play back in either format, depending on the features recorded on a disc.

Chapter: DVD programs are divided into chapters and titles. Chapters are the subsections programmed into a single title on a disc. Chapters may be compared to the individual tracks on an audio CD. Press the Menu button to see a listing of the chapters on a disc.

Component Video: This is a new form of video signal that eliminates many of the artifacts of traditional composite video signals by splitting the signal into a separate luminance channel and two color-difference signals. With a component video connection, you will see greater picture resolution and eliminate many picture imperfections such as the moiré patterns often seen on checked patterned cloths. However, in order to benefit from component video you must have a video display with Y/Pr/Pb component video inputs. Do not connect the component video outputs of the DVD 50 to the standard composite or S-Video inputs of a TV or recorder.

Title: For a DVD, a title is defined as an entire movie or program. There may be as many chapters within a title as the producers decide to include. Most discs include only one title, but some may have more than one, to give you a "Double Feature" presentation. Press the Title button to see a listing of the titles on a disc. When a disc has only one title, pressing the title button may show a list of the chapters.

Multiple Angle: DVDs have the capability to show up to four different views of the same scene in a program. When a disc is encoded with multiple-angle information, pressing the Angle button will enable you to switch between these different views. Note that, at present, few discs take advantage of this capability and, when they do, the multiple-angle technology may only be present for short periods of time within the disc. Producers will usually insert some sort of icon or graphic in the picture to alert you to the availability of multiple-angle scenes.

Reading: This is a message that you will see when you first press the Play button. It refers to the fact that the player must first examine the contents of the disc to see whether it is a CD or DVD, and then extract the information about the type of material on the disc, such as languages, aspect ratios, subtitles, number of titles and more. The slight delay while the contents of the disc are read is normal.

Resume: The operation of the Stop button on the DVD 50 works differently from what you are used to on CD players. On a traditional CD player, when you press the Stop button, the unit does just that: it stops playback. On a CD player, when you press the Start button again, the disc starts from the beginning. With the DVD 50, however, you have two options when playing DVD discs. Pressing Stop once will stop the playback, but it actually puts the unit in the Resume mode. This means that you can turn the machine off and, when you press Play the next time, the disc will resume or continue from the point on the disc where the Stop button was pressed. This is helpful if you are watching a movie and must interrupt your viewing session but wish to pick up where you left off. Pressing the Stop button twice will stop the machine in a traditional manner and, when the disc is played again, it will start from the beginning.

Front Panel Controls

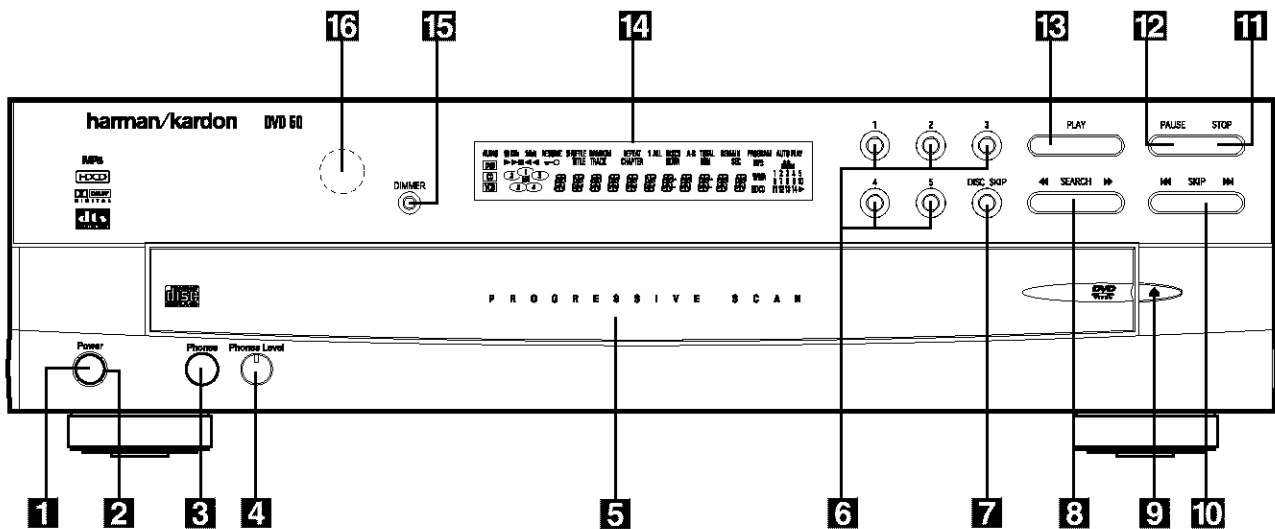

- 1** Power Switch
- 2** Status Indicator
- 3** Headphone Jack
- 4** Headphone Level Control

- 5** Disc Tray
- 6** Direct Access Buttons
- 7** Disc Skip
- 8** Search Forward/Reverse

- 9** Open/Close Button
- 10** Skip Forward/Reverse
- 11** Stop
- 12** Pause

- 13** Play
- 14** Information Display
- 15** Display Dim
- 16** Remote Sensor

1 Power Switch: Press the button once to turn the DVD 50 on; press it again to put the unit in the Standby mode.

2 Status Indicator: When the DVD 50 is in the On mode, this indicator will glow green. When the unit has been placed in the Standby mode by pressing the **Power-Off Button** 29 on the remote, the indicator will glow amber, indicating that the unit is still connected to the AC main supply and is ready to be turned on from the remote control.

3 Headphone Jack: Connect standard headphones to this jack for private listening.

4 Headphone Level Control: Turn this control to adjust the volume level to the headphones. Note that the use of this control will not change the analog output levels at the rear panel audio outputs.

5 Disc Tray: This tray holds as many as five compatible discs that can be played one at a time in the DVD 50.

6 Direct Access Buttons: Press one of these buttons to play any of up to five discs loaded in the Disc Tray.

7 Disc Skip: Press this button to change the disc being played. Each press of the button will move the tray forward to the next occupied

position in the tray. Note that the unit will skip over the empty disc positions.

8 Search Forward/Reverse: Press this button to move forward or backward through a CD or DVD at one of four speeds. Each press and release will increase the search speed, as indicated in the on-screen display. Once you have selected the desired speed, release the button and the disc will continue to search at fast speed. To resume normal playback speed, press the **Play Button** 13.

9 Open/Close Button: Press this button to open or close the **Disc Tray** 5.

10 Skip Forward/Reverse: Press this button to move forward or backward through the music tracks on a CD disc or the chapters on a DVD disc.

11 Stop: Press this button once to place the disc in the Resume mode, which means that playback will stop, but as long as the tray is not opened or the disc changed, DVD playback will continue from the same point on the disc when the Play button is pressed again. Resume will also work if the unit was turned off. To stop a disc and have play start from the beginning, press the button twice.

12 Pause: Press this button to momentarily pause playback. To resume playback, press the **Play Button** 13. If a DVD is playing, action will freeze and a still picture will be displayed when this button is pressed.

13 Play: Press the button to playback, or to resume playback after the **Pause Button** 12 has been pressed.

14 Information Display: This display contains a variety of indicators that provide information about the status of the DVD 50 and the disc currently playing.

15 Display Dim: Press this button to adjust the brightness of the Information Display by 50% or to turn the display off completely in the following order: FULL BRIGHTNESS → HALF BRIGHTNESS → OFF → FULL BRIGHTNESS.

16 Remote Sensor: The sensor that receives the infrared commands from the remote control is behind this area. Do not cover or obscure this part of the front panel, in order to avoid a malfunction with the remote.

Front Panel Information Display

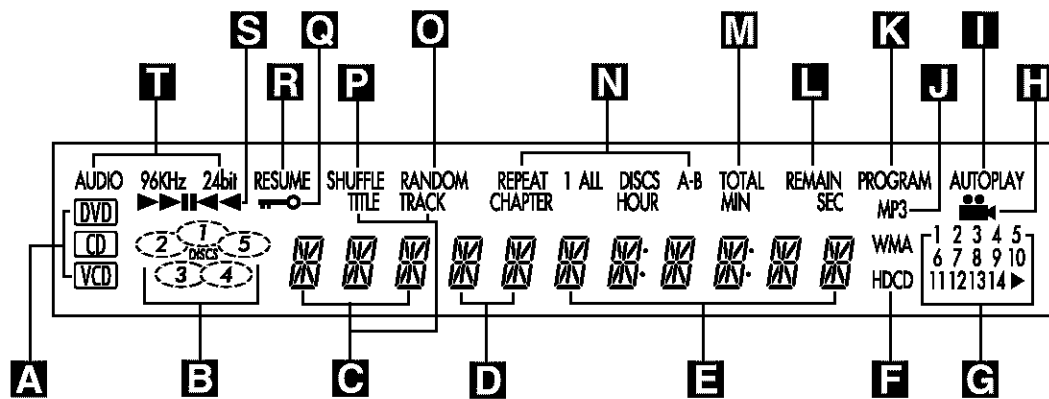

- A** Disc Type Indicators
- B** Disc Number Indicators
- C** Title/Track Indicators
- D** Chapter Number Indicators
- E** Program Time Indicators
- F** HDCD Indicator
- G** Track Number Calendar

- H** Angle Indicator
- I** Auto Play Indicator
- J** MP3 Indicator
- K** Program Indicator
- L** Remaining Time Indicator
- M** Total Time Indicator
- N** Repeat/Random Indicators

- O** Random Indicator
- P** Shuffle Indicator
- Q** Parental Lock Indicator
- R** Resume Indicator
- S** Playback Mode Indicators
- T** 96kHz/24-Bit Indicator

A Disc Type Indicators: A DVD, CD or VCD indicator will light to show the type of disc currently being played.

B Disc Number Indicators: When the DVD 50 has sensed that a disc is loaded in one or more of the tray positions, the number inside the corresponding disc icon will light. The disc position that is currently playing will flash. Note that if a disc is added to, or removed from, the tray while a disc is playing, the indicator will not show the change until all discs are cycled.

C Title/Track Indicators: The numbers shown in these positions display the current title number when a DVD is playing, or the current track number when a CD or MP3 disc is playing, as indicated by the appearance of either the **TRACK** or **TITLE** indicator being illuminated.

D Chapter Number Indicators: The numbers shown in these positions display the current Chapter number when a DVD is playing, as indicated by the **CHAPTER** indicator being illuminated.

E Program Time Indicators: These positions in the indicator will show the running time of a DVD in play. When a CD is playing, these indicators will show the current track time, time remaining in the current track, or the total remaining time on the disc.

F HDCD Indicator: This indicator lights when a CD with HDCD encoding is playing. The HDCD decoder will automatically be activated to provide high-resolution audio playback.

G Track Number Calendar: This area provides a graphical display of the track numbers remaining on a CD. When a disc has more than 14 tracks the ► indicator at the end of the calendar display will light.

H Angle Indicator: This indicator lights when the DVD being played has multiple-angle content. However, the actual multi-angle scenes are only present when the indicator flashes. When it flashes, press the **Angle Button**  on the remote to change the scene being viewed. See page 31 for more information.

I Auto Play Indicator: When this indicator is lit, the DVD 50 is in the Auto Play mode, which means that the unit will automatically play a DVD disc when it is inserted in the disc tray and the drawer is closed. Note that CD discs will always go into the Play mode when the disc drawer is closed, even when the indicator is not lit. See page 23 for more information.

J MP3 Indicator: This indicator lights when a disc with MP3 content is played.

K Program Indicator: This indicator lights when the programming functions are in use.

L Remaining Time Indicator: This indicator lights when a CD is playing and the time display has been switched to show the time remaining in the track being played. When both this indicator and the **Total Time Indicator M** are lit, the total remaining time in the disc is shown.

M Total Time Indicator: This indicator lights when a CD is playing and the time display has been switched to show the total elapsed time that the current disc has played. When both this indicator and the **Remaining Indicator L** are lit, the total remaining time in the disc is shown.

N Repeat/Random Indicators: These indicators light when any of the Repeat/Random functions are in use.

O Random Indicator: This indicator lights when the unit is in the Random Play mode.

P Shuffle Indicator: This indicator lights when the DVD 50 is in the Shuffle Random Play mode. See page 35 for more information.

Front Panel Information Display

Q Parental Lock Indicator: This indicator lights when the parental lock system is engaged in order to prevent anyone from changing the rating level without a code.

R Resume Indicator: This indicator lights when the Stop button has been pressed once to put the unit in the Resume mode.

S Playback Mode Indicators: These indicators light to show the current playback mode:

► Lights when a disc is playing in the Normal mode

►► Lights when the disc is in the Fast Search Forward mode. For DVDs, When both triangles glow steadily, the disc plays at 2x normal speed. When the right triangle is flashing, the disc plays at 4x normal speed. When the left triangle is flashing, the disc plays at 16x normal speed. When both triangles are flashing, the disc plays at 100x normal speed. For CDs, only the first three Fast Search modes are available.

►|| Lights when the disc is paused

◄◄ Lights when the disc is in the Fast Search Reverse mode. For DVDs, When both triangles glow steadily, the disc plays at 2x normal speed. When the left triangle is flashing, the disc plays at 4x normal speed. When the right triangle is playing, the disc plays at 16x normal speed. When both triangles are flashing, the disc plays at 100x normal speed. For CDs, only the first three Fast Search modes are available.

T 96kHz/24-Bit Indicator: This indicator lights when a disc recorded with 96kHz/24-bit content is playing. See page 24 for more information on settings for 96/24 audio.

Rear Panel Connections

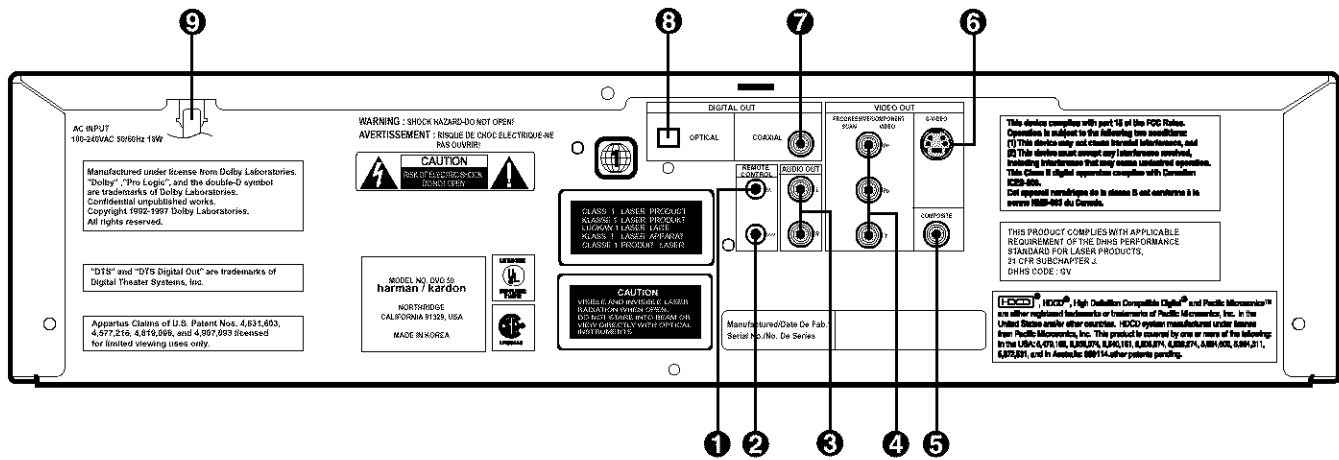

- ❶ Remote Control Input
- ❷ Remote Control Output
- ❸ Analog Audio Outputs

- ❹ Component Video Outputs
- ❺ Composite Video Output
- ❻ S-Video Output

- ❼ Coaxial Digital Output
- ❽ Optical Digital Output
- ❾ AC Power Cord

❶ Remote Control Input: Connect the output of a remote infrared sensor, or the remote control output of another compatible Harman Kardon product, to this jack. This will enable the remote control to operate even when the front panel **Remote Sensor 16** is blocked. This jack may also be used with compatible IR remote control-based automation systems.

❷ Remote Control Output: Connect this jack to the infrared (IR) input jack of another compatible Harman Kardon remote-controlled product to have the built-in **Remote Sensor 16** on the DVD 50 provide IR signals to other compatible products.

❸ Analog Audio Outputs: Connect these jacks to an audio input on an A/V receiver or surround processor for analog audio playback.

❹ Component Video Outputs: These outputs carry the component video signals for connection to analog or digital display monitors with component video inputs. For standard analog TVs or projectors with inputs marked Y/Pri/Pb or Y/Cr/Cb, connect these outputs to the matching inputs. If you have a digital television that is compatible with high scan rate video, connect these jacks to the "HD

Component" inputs. Note that a change must be made to the setup menus in order to take advantage of the progressive scan circuitry. See page 22 for more information on progressive scan video. Note that these jacks should NOT be connected to standard composite video inputs.

❺ Composite Video Output: Connect this jack to the video input on a television or video projector, or to a video input on an A/V receiver or processor if you are using that type of device for video input switching.

❻ S-Video Output: Connect this jack to the S-Video input on a television or video projector, or to an S-Video input on an A/V receiver or processor if you are using that type of device for S-Video input switching.

❼ Coaxial Digital Output: Connect this jack to the coaxial digital input of an A/V receiver or surround processor for Dolby Digital, DTS or PCM audio playback.

NOTE: The coaxial digital output should only be connected to a digital input. Even though it is the same RCA-type connector as standard analog audio connections, DO NOT connect it to a conventional analog input jack.

❽ Optical Digital Output: Connect this jack to the optical digital input of an A/V receiver or surround processor for Dolby Digital, DTS or PCM audio playback.

❾ AC Power Cord: Connect this plug to an AC outlet. If the outlet is controlled by a switch, make certain that it is in the ON position.

Remote Control Functions

- 1 Title Button
- 2 Power-On Button
- 3 Status Button
- 4 Return Button
- 5 Navigation Buttons
- 6 Previous Button
- 7 Play Button
- 8 Reverse Search Button
- 9 Open/Close Button
- 10 Stop Button
- 11 Slow Play Buttons
- 12 Random Button
- 13 Disc Skip Button
- 14 Numeric Buttons
- 15 Repeat Button
- 16 Repeat A-B Button
- 17 Light Button
- 18 Check Button
- 19 Program Button
- 20 Clear Button
- 21 Zoom Button
- 22 Mark Button
- 23 Step Buttons
- 24 Pause Button
- 25 Forward Search Button
- 26 Next Button
- 27 Enter Button
- 28 Menu Button
- 29 Power-Off Button
- 30 Angle Button
- 31 Subtitle On/Off Button

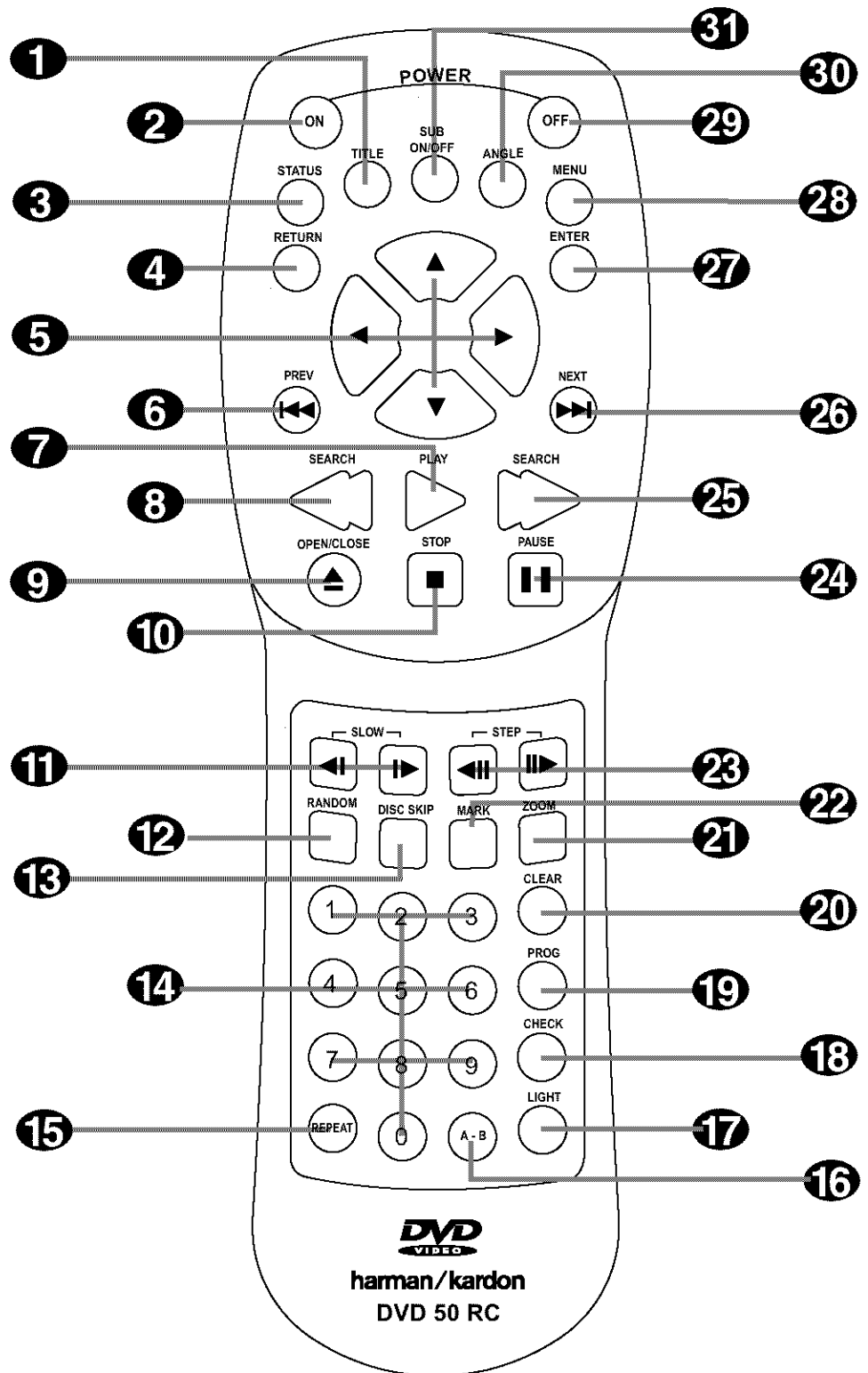

Remote Control Functions

1 Title Button: When a DVD is playing, press this button to display the disc's Title Select Menu. If the disc does not offer this function, a symbol (Ⓢ) will appear on the screen to indicate that there is only one title on the disc or that the disc does not allow this feature. This button is also used to activate the CD-Text display when a CD with CD-Text data is playing. (See p. 32 for more information.)

2 Power-On Button: Press this button to turn the DVD 50 on.

3 Status Button: When a disc is playing, pressing the button will display the Status Banner which contains information about the disc and enables you to change the functions.

4 Return Button: When viewing the menu display from a DVD disc, press this button to return to the previous menu screen.

5 Navigation Buttons: Press these buttons to change or select an item from the DVD 50's Status Banner or in the on-screen menu displayed by a DVD disc.

6 Previous Button: Press this button to move backward through the music tracks on a CD disc or the chapters on a DVD disc.

7 Play Button: Press this button to begin playback. If the disc tray drawer is open, it will automatically close when the button is pushed. Pressing the Play button when the unit is in the Standby mode will turn the unit on and begin playback of the last disc in use.

8 Reverse Search Button: Press this button to move backward through a CD or DVD at one of four speeds. Each press and release will increase the search speed, in the following order: R. Search x 2 → R. Search x 4 → R. Search x 16 → R. Search x 100. Once you have selected the desired speed, release the button, and the disc will continue to search at fast speed. To resume normal playback, press the **Play Button 7/13**.

9 Open/Close Button: Press this button to open or close the disc tray drawer. If the drawer is opened while a disc is still playing, playback will continue and discs not in use may be changed. If the drawer is opened while the unit is stopped, the disc that was playing will be presented at the front-center position of the tray.

10 Stop Button: Press this button once to place the disc in the Resume mode, which means that playback will stop; as long as the tray is not opened or the disc changed, DVD playback will continue from the same point on the disc when the **Play Button 7** is pressed again. Resume will also work if the unit is turned off. To totally stop a disc, press the button twice.

11 Slow Play Buttons: When a DVD disc is playing, press these buttons to move forward or backward through the disc in slow speed. Each press of these buttons changes the slow-play speed in the following order: 1/16 Normal Speed → 1/8 Normal Speed → 1/4 Normal Speed → 1/2 Normal Speed.

To resume normal play, press the **Play Button 7/13**. These buttons do not function when a CD is playing.

12 Random Button: Press this button to begin the playback of all tracks on a disc in random order.

13 Disc Skip Button: Press this button to move to the next available disc in the tray.

14 Numeric Buttons: Press these keys to enter data for sequential programming, to enter or change the access password for parental control, to enter a language code, or to respond to menu options presented by a disc.

15 Repeat Button: Press this button to select a Repeat-Play mode. Each press of the button shows the choice selected in either the on-screen Status Banner display or in the **Repeat Indicators N**.

16 Repeat A-B Button: Press this button once to begin the selection of a portion of a disc to be repeated. Press it again to choose the end point of the repeat-play selection.

17 Light Button: Press this button to activate the remote's backlighting so that the keys are visible in low-light conditions.

18 Check Button: This button is used to verify the contents of a programmed play list via the front panel Information Display. (See page 36 for more information about programming the DVD 50.)

19 Program Button: When the unit is stopped, press this button to display the program menu and enter a programmed play sequence. When a disc is playing, press this button to switch between normal play and programmed playback.

20 Clear Button: Press this button to remove the Status Banner or other displays from your video screen. This button is also used to clear items from Programmed Play lists. (See page 36.)

21 Zoom Button: When a DVD or VCD disc is playing, press this button to zoom the picture so that it is enlarged. There are six steps to the zoom function, each progressively larger. Press the button through each of the zoom stages to return to a normal picture.

22 Mark Button: Press this button to activate the Bookmark system. Once the button is pressed, you may save or recall a favorite spot in a program by pressing the **Navigation 5** and **Enter 27** buttons. See page 37 for complete information on the Bookmark feature.

23 Step Buttons Button: When a DVD disc is playing, press these buttons to move forward or backward one frame at a time. Press the **Play Button 7/13** to resume normal play. These buttons do not function when a CD is playing.

24 Pause Button: Press this button to stop the disc in use. To resume playback, either press the Pause button again or press the **Play Button 7/13**.

25 Forward Search Button: Press this button to move forward through a CD or DVD at one of four speeds. Each press and release will increase the search speed, in the following order: F. Search x 2 → F. Search x 4 → F. Search x 16 → F. Search x 100. Once you have selected the desired speed, release the button and the disc will continue to search at fast speed. To resume normal playback speed, press the **Play Button 7/13**.

26 Next Button: Press this button to move forward through the music tracks on a CD disc or the chapters on a DVD disc.

27 Enter Button: Press this button to select the item that is highlighted in the DVD 50's Status Banner or in the on-screen menu displayed by a DVD disc.

Remote Control Functions

28 Menu Button: This button has two functions. When a DVD disc is playing, press this button to stop the disc playback and display the DVD's main menu screen for the current title. When the unit is stopped, press this button to display the Setup Menu.

29 Power-Off Button: Press this button to place the unit in the Standby mode.

30 Angle Button: When a DVD encoded with multiple-angle information is playing, press this button to change the angle in use. Note that this function is only available on discs that are specially prepared to take advantage of the multiple-angle function, and only for those parts of the disc that are recorded with multiple-angle content. The DVD 50 will display a camera icon on the screen to indicate when this feature is available.

31 Subtitle On/Off Button: When a DVD is playing, press this button to turn the subtitle display on or off. The first press of button displays the current subtitle status, with subtitles off indicated by a blank box to the right of the language name. Press the button again to turn the subtitle on.

Installation and Connections

Installation

Connections will vary, depending on the type of audio and video components used with your DVD 50. However, regardless of the complexity of your system, the installation guidelines on pages 14–17 should always be followed to ensure a safe installation and reliable operation of the product.

Important Note: To prevent possible damage to your speakers or other components in your home entertainment system, we strongly recommend that ALL system components, including the DVD 50, be turned off and unplugged from their AC power source when any connections are made or a new component is installed.

Placement of the DVD 50

Since the laser transport mechanism and carousel tray in the DVD 50 are precision components designed and manufactured to exact tolerances, they are subject to interference from vibration. To minimize the possibility of skipping during playback, it is recommended that the unit be placed on a level, solid, vibration-free surface.

When installing the DVD 50 in a cabinet or tight space, always make certain that there is enough room in front of the unit for the disc tray to open fully, and that there is enough space above the unit so that discs may easily be inserted into the spaces in the tray.

As the disc drawer extends out about six inches from the front of the unit when it is open, you should also make certain that there is sufficient clearance in front of the unit to accommodate the disc drawer without it bumping into other objects or getting in the way of anyone walking in front of the unit.

In addition to the safety considerations outlined on page 4, it is also recommended that the DVD 50 not be placed in a location that is subject to direct sunlight or extreme heat or cold, as these conditions may damage the discs used in the player, or the player itself. Note that audio amplifiers or high-power receivers, as well as certain other electronic products, can generate significant heat. For that reason, do not place the DVD 50 directly on top of an amplifier, receiver, or other heat source. Always allow at least one inch of free space on all sides of the DVD 50 as well as around other electronic products to allow for proper ventilation.

Installation Options

The diagrams on pages 14–17 describe the three basic ways to connect the DVD 50 to your system components.

- Option #1: Use this setup if all audio and video connections from the DVD 50 will go directly to a television set or video projector without the use of an A/V receiver or surround processor.
- Option #2: Use this setup if the video connections will go directly to a television set or video projector, but the audio connections will be made to an A/V receiver or surround processor.
- Option #3: Use this setup if all audio and video connections will be made through an A/V receiver or a surround processor.

Important Notes on Installing the DVD 50

The following important notes apply to all three installation options:

- If your television has both standard composite video and S-Video inputs, you only need to use one of the two connections. Where possible, we recommend an S-Video connection, due to the higher picture quality.
- Do not connect any of the video outputs of the DVD 50 through a VCR. The use of Macrovision encoding on most DVD discs means that most discs will have a distorted picture when connections are made through a VCR.
- Note that the volume level for DVD playback may differ from the level for other input sources to your receiver. This is normal and does not indicate a problem with the DVD 50 or your receiver. Simply use the volume control on the receiver to set the desired level.
- Depending on the product and brand, a number of different descriptions are used to label component video connections. You may see them as Y/Pr/Pb, Y/Cr/Cb or Y/R-Y/B-Y. For the purposes of connecting a DVD player, all of these labels are normally identical. The best guide is to connect the component video connections using the green/red/blue color coding of the inner rings of the connection jacks.

■ If your television is high-definition or “digital ready” television, you may take advantage of the DVD 50’s progressive scan output for the highest video resolution possible. Make the component video connections shown or you may connect the component video jacks directly to the component video or HD component inputs on your TV or video display. Once the connection is made, the progressive scan circuitry must be activated by changing the setup menus as shown on page 23. Note that progressive scan capability is not operational with standard analog component video connections.

■ Note that all cables shown for use in the connection diagrams are optional. Consult your dealer or installer for information on the best cables for your specific system application.

■ When the progressive scan output is activated, there is no output from either the **S-Video 6** or **Composite Video 5** jack.

■ When the **Component Video Output 4** is used for a standard video signal (that is with the progressive scan output turned off), there is no output from the **S-Video 6** jack, but the **Composite Video Output 5** will function normally. See page 23 for more information on video output settings.

Installation and Connections

OPTION 1:

Direct Connections to a Television or Video Projector

This is the simplest installation, as it does not require anything other than a television set. However, note that in this type of system you will not be able to enjoy the benefits of Dolby Digital or DTS discrete playback, as that requires the digital audio processing found in A/V receivers or surround processors. Follow as many of these steps as needed, based on the capabilities of your television:

Step 1: Connect the **AC Power Cord 9** to an AC outlet as shown in **Connection A**, but do NOT turn the DVD 50 on at this point.

Step 2: Connect the left and right **Analog Audio Outputs 3** to the left and right audio inputs on your television as shown in **Connection B**.

Step 3: Depending on the video input capabilities of your video display, make one of the following connections. For the highest video quality, use component video connections, if available. An S-Video connection is the next best quality, followed by a standard composite video connection.

If the video display has component video inputs, connect the **Y/Pr/Pb Component Outputs 4** on the DVD 50 to the matching input jacks on the back of your television as shown in **Connection C**. This connection is the same regardless of if the component connection is to a digital television for progressive scan use or to a standard analog video display.

If the video display has an S-Video input and component video is not available, connect the **S-Video Output 6** on the DVD 50 to the S-Video input on your video display as shown in **Connection E**.

If the only video input available on your television is a standard video jack, connect the **Composite Video Output 5** on the DVD 50 to a matching composite video input on your video display, as shown in **Connection D**. Note that in most cases the video input jack is recognizable by the yellow ring surrounding the input.

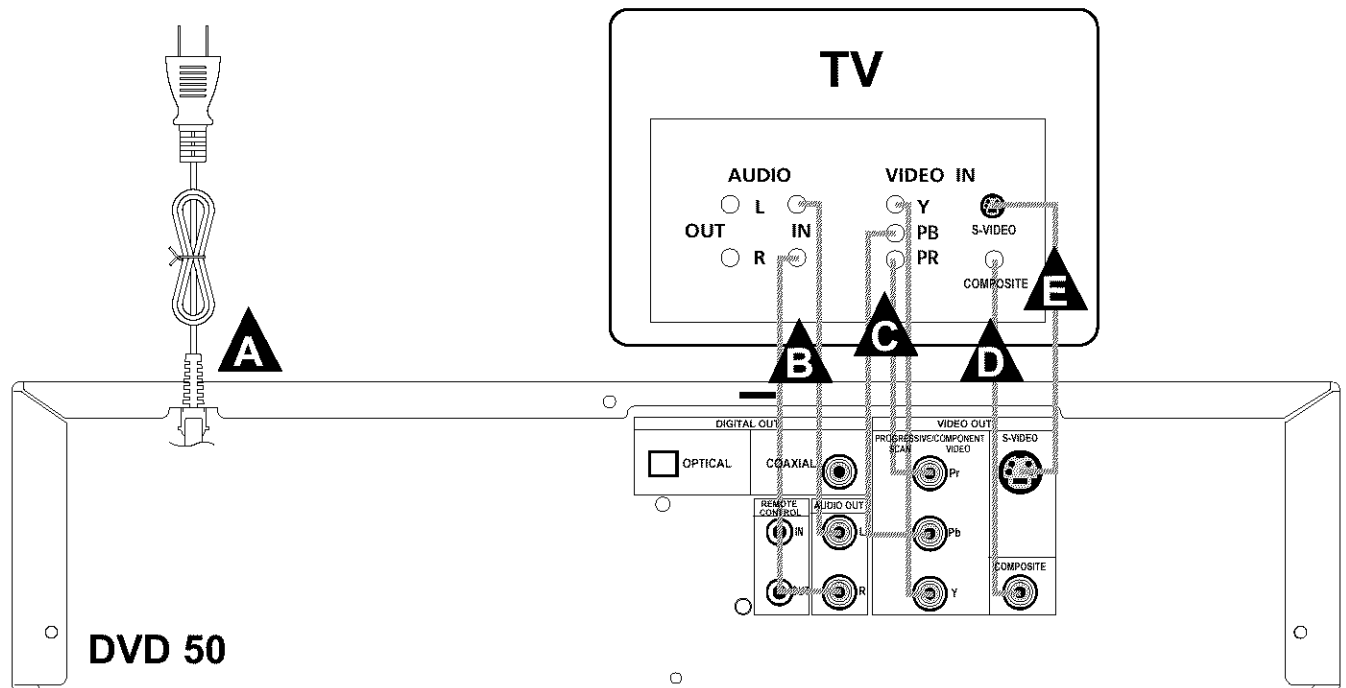

Installation and Connections

OPTION 2:

Direct Connections to a Television or Video Projector with Audio Connections to an A/V Receiver or Surround Processor

To hear the benefits of discrete, multichannel digital audio, you will need to use an external Dolby Digital/DTS-capable A/V receiver or surround processor. In this installation, you maintain a direct video connection to your television, but use the audio processing from another device.

Step 1: Connect the **AC Power Cord 9** to an AC outlet as shown in **Connection A**, but do NOT turn the DVD 50 on at this point.

Step 2: Depending on the type of A/V receiver or surround processor you have make one of the following audio connections:

If your A/V receiver or surround processor has digital decoding capability for Dolby Digital and DTS, you may make the connection by connecting either an optical or coaxial cable. For optical connections, run the cable from the **Optical Digital Output 8** on the DVD 50 to an optical input on the A/V receiver, as shown in **Connection A**. For coaxial connections, run the cable from the **Coaxial Digital Output 7** on the DVD 50 to a coaxial input on the A/V receiver, as shown in **Connection A**. Either type of connection may be used and only

one is required. Remember to change the settings in your receiver or processor so that the digital input you have selected is configured for use with the DVD video input.

If your A/V receiver or surround processor does not have digital decoding capability, you may still take advantage of the benefits of its analog surround processing such as Dolby Pro Logic*. Connect the left and right **Analog Audio Outputs 6** to the left and right audio inputs on your receiver or processor, as shown in **Connection A**.

Step 3: Depending on the video input capabilities of your video display, make one of the following connections. For the highest video quality use component video connections, if available. An S-Video connection is the next best quality, followed by a standard composite video connection.

If the video display has component video inputs, connect the **Y/Pr/Pb Component Outputs 4** on the DVD 50 to the matching input jacks on the back of your television as shown in **Connection A**. This connection is the same regardless of whether the component connection is to a digital television for progressive scan use or to a standard analog video display.

If the video display has an S-Video input and component video is not available, connect the **S-Video Output 5** on the DVD 50 to the S-Video input on your video display as shown in **Connection A**.

If the only video input available on your television is a standard video jack, connect the **Composite Video Output 5** on the DVD 50 to a matching composite video input on your video display as shown in **Connection A**. Note that in most cases the video input jack is recognizable by the yellow ring surrounding the input.

Installation Note

- Only one type of audio connection is required, either digital or analog. If possible, a digital connection is preferred as that will enable you to listen to DVD soundtracks with the clarity, definition and channel separation made possible by Dolby Digital and DTS. However, if you do not yet have a receiver capable of digital audio processing, you will still benefit from an analog connection so that the receiver may create a multi-channel soundfield using Dolby Pro Logic or other matrix decoding.

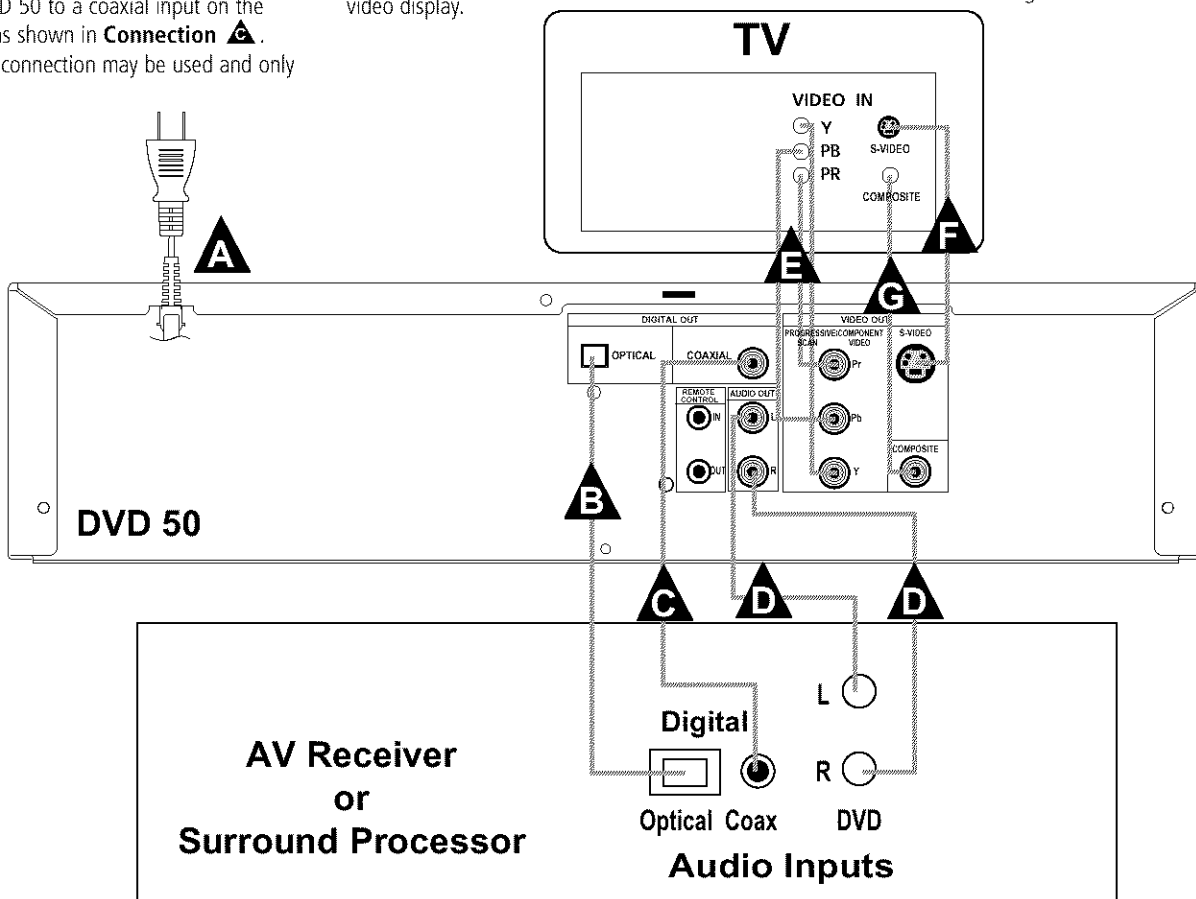

Installation and Connections

OPTION 3:

Audio and Video Connections through an A/V Receiver or Surround Processor only

If your home entertainment system has other audio/video input sources in addition to the DVD 50, such as a VCR, cable set-top box or satellite receiver, LD player, personal video recorder or HDTV tuner, the most efficient way to manage the various components is to make all audio/video connections through an A/V receiver or surround processor. This simplifies the selection of an input source, and allows many different components to be connected to the same video display and speakers.

Step 1: Connect the **AC Power Cord 9** to an AC outlet as shown in **Connection A**, but do NOT turn the DVD 50 on at this point.

Step 2: Depending on the type of A/V receiver or surround processor you have, make one of the following audio connections:

If your A/V receiver or surround processor has digital decoding capability for Dolby Digital and DTS, you may make the connection by connecting either an optical or coaxial cable. For optical connections, run the cable from the **Optical Digital Output 8** on the DVD 50 to an optical input on the A/V receiver as shown in **Connection B**. For coaxial connections, run the cable from the **Coaxial Digital Output 7**

on the DVD 50 to a coaxial input on the A/V receiver as shown in **Connection C**. Either type of connection may be used and only one is required. Remember to change the settings in your receiver or processor so that the digital input you have selected is configured for use with the DVD video input.

If your A/V receiver or surround processor does not have digital decoding capability you may still take advantage of the benefits of its analog surround processing such as Dolby Pro Logic. Connect the left and right **Analog Audio Outputs 3** to the left and right audio inputs on your television as shown in **Connection D**.

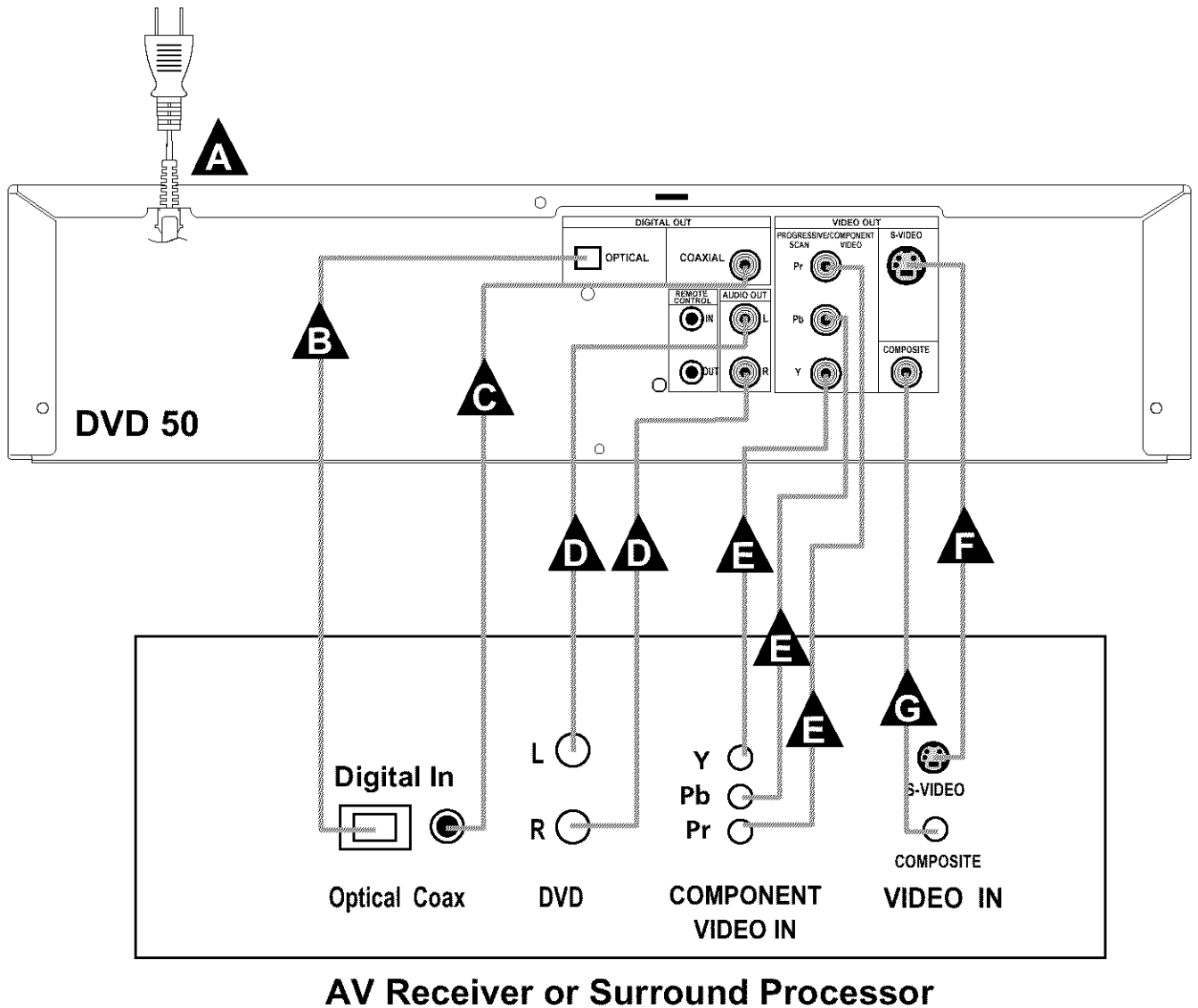

Installation and Connections

Step 3: Depending on the video input capabilities of your video display and the connections available on your A/V receiver or surround processor, make one of the following connections. For the highest video quality use component video connections, if available. An S-Video connection is the next best quality, followed by a standard composite video connection.

If both your A/V receiver and video display have component video inputs, connect the **Y/Pr/Pb Component Outputs 4** on the DVD 50 to the matching input jacks on the back of your A/V receiver, as shown in **Connection A**. This connection is the same, regardless of whether the component connection is to a digital television for progressive scan use or to a standard analog video display. If your A/V receiver does not have component video switching, but if your television or video display does has component inputs, make the connections from the **Y/Pr/Pb Component Outputs 4** on the DVD 50 directly to the matching inputs on your video display.

If the video display has an S-Video input and component video is not available, connect the **S-Video Output 6** on the DVD 50 to the S-Video input on your video display, as shown in **Connection A**.

If the only video input available on your television is a standard video jack, connect the **Composite Video Output 5** on the DVD 50 to a matching composite video input on your video display, as shown in **Connection A**. Note that in most cases the video input jack is recognizable by the yellow ring surrounding the input.

Installation Notes

- For this installation, make the connections from the receiver or processor to your video display and speakers as described in the owner's manuals for those products.
- Only one type of audio connection is required, either digital or analog. If possible, a digital connection is preferred as that will enable you to listen to DVD soundtracks with the clarity, definition and channel separation made possible by Dolby Digital and DTS. However, if you do not yet have a receiver capable of digital audio processing, you will still benefit from an analog connection so that the receiver may create a multichannel soundfield using Dolby Pro Logic or other matrix decoding.

Setup Menu

Remote Control Operation

The DVD 50's remote control contains all of the codes needed to operate the product. In addition, it offers a built-in backlight that may be used to identify the remote buttons when the remote is used in low-level lighting conditions. A guide to the operation of the remote's functions is found in this manual on page 11.

Batteries

Before using the remote, install the AA batteries provided with the product by turning the remote over and moving the small latch on the bottom in the direction of the arrow. After the latch is loosened, flip the cover up and then remove it. Install the two batteries as shown here, being careful to observe the "+" and "-" polarity indications for proper placement of the batteries in their compartment. Replace the battery cover by first sliding the two teeth on the cover into their matching slots towards the top of the remote. Then, gently press down on the cover until the latch firmly snaps into place. The remote is now ready for operation.

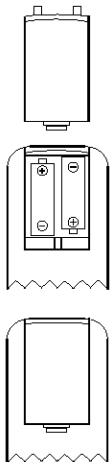

NOTE: When replacing batteries, it always a good idea to replace both at the same time. When the remote will not be used for an extended period of time, it is also a good idea to remove the batteries to avoid the possibility of damage due to corrosion. Batteries contain chemical substances and we recommend that you dispose of them properly and in compliance with any local regulations.

Notes on Remote Control

Operational Range

■ The DVD 50's remote will operate up to a range of about 23 feet (7m) from the **Remote Sensor 16** in a range of about 30 degrees to each side of the unit, as shown in the diagram.

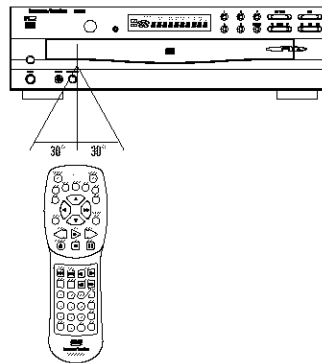

■ The operating distance may vary according to the brightness of the room.

■ Do not point any bright lights in the direction of the unit's **Remote Sensor 16**, as this will decrease operating range.

Notes on Batteries for the DVD 50 Remote

■ The batteries normally last for about one year although this depends on how often, and for what operations, the remote control is used.

■ If the backlight does not light, or if the remote control unit fails to work even when it is operated near the player, replace the batteries. When replacing the batteries, do not mix old and new batteries; always change both cells at the same time.

■ Always dispose of used batteries in an environmentally safe manner and in compliance with any local regulations.

■ Do not use rechargeable (Ni-Cd) batteries and do not attempt to recharge, short-circuit or disassemble the batteries.

■ If the remote control unit is not going to be used for an extended period of time, remove the batteries. Otherwise, electrolyte may leak which may lead to malfunctions as well as damage to the remote, which is not covered by the warranty.

■ Should any electrolyte leak from the batteries inside the remote control unit, wipe it away but avoid any contact. If any electrolyte should come into contact with your skin, wash it off thoroughly with water.

System Defaults

The final step of the installation is to establish the system's defaults. The factory settings for the unit will accommodate most requirements, so it is not essential that they be changed.

If you wish to immediately play a disc, proceed to page 26. However, it is helpful to take a few minutes to familiarize yourself with these settings, as they may require change from time to time.

Before using the DVD 50 for the first time, make certain that the unit is properly connected to any audio/video components it will be used with, as described on the previous pages. When the installation is done, make certain that the batteries are properly installed in the remote and that the unit is plugged into an AC power source.

The first step in checking or changing the system defaults is to access the Setup Menu. First, make certain that the DVD 50 is properly connected to a video display, and that power is connected. For this process, however, you do not need to load any discs into the unit.

In order to proceed with the DVD 50's setup, first turn on your television or video display, along with any AV receiver or surround processor that is used in conjunction with the DVD 50. Make certain that those devices are set to the correct audio and video inputs for use with the DVD 50. If you have not already done so, plug the **AC Power Cord 9** into a wall output or surge protector/power strip.

When the power is first connected to the DVD 50, the front panel **Information Display 14** will welcome you with a **HELLO DVD 50** message and the DVD 50 screen will appear in your video display. The DVD 50 will then attempt to see whether there are any discs in the machine, even though this is the first time it is being used. Since there are no discs in the player, a **NO DISC** message will appear in both the on screen display and in the Information Display, and the disc numbers inside the **Disc Number Indicators 5** will go out as each position in the loading tray is examined and found to be empty. It is not necessary to load any discs in the machine at this time to start the setup process.

To access the Setup Menu, press the **Menu Button 28** on the remote. The Setup Menu will appear on the video display screen as shown in Figure 1. The left side of the screen will show the various options, and the box on the right side of the screen will show the current defaults.

Setup Menu

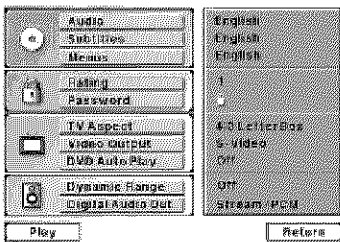

Figure 1

To navigate through the settings on the screen, use the **▲/▼ Navigation Buttons 5** to scroll up or down through the list of settings or the list of options. Press the **◀/▶ Navigation Buttons 5** to move back and forth between the list of settings of the left side of the screen and the list of options for those settings on the right side of the screen. To choose a specific option, use the **▲/▼ Navigation Buttons 5** until it is highlighted. Press the **Enter Button 27** to select the choice. When a selection is made, you may confirm the choice by checking to see that an orange dot fills the circle next to the choice.

Audio Language Selection

The Audio Language option sets the default choice for the language that will be played from a DVD disc.

To select the language default, you must be viewing the Setup Menu (Figure 1), which is available by pressing the **Menu Button 28** while the unit is in the Stop mode. Audio Language Selection is the first option, so it will automatically be highlighted in dark blue when the Setup Menu is displayed.

To change the default Language, press the **▶ Navigation Button 5** and note that the list of system defaults will be replaced with a list of the available options, for the audio language setting as shown in Figure 2. The current language choice will be indicated by a filled-in orange circle on the list on the right side of the screen.

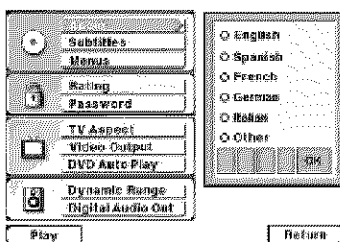

Figure 2

To change the default setting, press the **▲/▼ Navigation Buttons 5** until the desired choice is highlighted, and then press the **Enter Button 27**. Note that the circle for your choice will fill in, and the menu will return to the default listings.

If you wish to change the default to a language other than those shown in the menu, press the **▼ Navigation Button 5** until the "Other" line on the bottom is highlighted. Consult the Language Codes list on page 38 for the desired language. Press the **Enter Button 27**. Next, enter the number for the desired language code using the **▲/▼ Navigation Buttons 5**. Press the buttons until the desired number appears in the first position, and then press the **▶ Navigation Button 5** to move to the next position. Continue to enter the number using the **▲/▼ Navigation Buttons 5** at each spot and then move to the next one. When all four digits have been entered and the OK box is highlighted, press the **Enter Button 27** to store the selection in the DVD 50's memory. Although the word "OTHER" will appear in the settings list, your desired choice will be entered.

Note that when a default language is selected, it will be used whenever that language is present on the DVD disc being played. However, when that language is not present, the language used will be the one preprogrammed into the disc itself. (Typically, that default will be English for discs sold in Region 1, but the selection may vary at the discretion of the disc's producer.)

Although the default determines the language that will be used when a disc is first put into play, the language may easily be changed at any time through the use of the Menu Bar. See page 30 for more information.

If you have no other changes to make after setting this default, press the **Menu Button 28** to remove the Setup Menu from the screen, or press the **Play Button 7/13** to begin or resume playback.

Subtitle Language Selection

The Subtitle Language option sets the default choice for the language that will be displayed when subtitles are turned on during DVD playback.

To select the Subtitle Language default, you must be viewing the Setup Menu (Figure 1),

which is available by pressing the **Menu Button 28** while the unit is in the Stop Mode. At the Setup Menu, press the **▼ Navigation Button 5** until the Subtitle Language option is highlighted.

To change the default Subtitle Language, press the **▶ Navigation Button 5** and note that the list of system defaults will be replaced with a list of the available options, as shown in Figure 3. The current subtitle language choice will be indicated by a filled-in circle on the list on the right side of the screen.

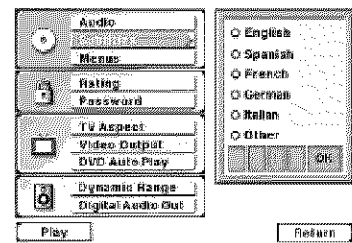

Figure 3

To change the default setting, press the **▲/▼ Navigation Buttons 5** until the desired choice is highlighted, and then press the **Enter Button 27**. Note that the circle for your choice will fill in, and the menu will return to the default listings.

If you wish to change the subtitle default to a language other than those shown, press the **▼ Navigation Button 5** until the "Other" line on the bottom is highlighted. Consult the Language Codes list on page 38 for the desired language. Press the **Enter Button 27**. Next, enter the number for the desired language code using the **▲/▼ Navigation Buttons 5**. Press the buttons until the desired number appears in the first position, and then press the **▶ Navigation Button 5** to move to the next position. Continue to enter the number using the **▲/▼ Navigation Buttons 5** at each spot and then move to the next one. When all four digits have been entered and the OK box is highlighted, press the **Enter Button 27** to store the selection in the DVD 50's memory. Although the word "OTHER" will appear in the settings list, your desired choice will be entered.

Note that when a default subtitle language is selected, it will be used whenever that language is present on the DVD disc being played. However, when that language is not present, the language used will be the one prepro-

Setup Menu

grammed into the disc itself. (Typically, that default will be English for discs sold in Region 1, but the selection may vary at the discretion of each disc's producer.)

Although the default will set the language that will be used when the disc is first put into play, the language may easily be changed at any time by using the **Subtitle Button** 31. See page 31 for more information.

If you have no other changes to make after setting this default, press the **Menu Button** 28 to remove the Setup Menu from the screen, or press the **Play Button** 7/13 to begin or resume playback.

Menu Language Selection

The Menu Language option sets the default choice for the language that will be used for the DVD 50's own on-screen menu displays. This default setting DOES NOT impact the playback of DVD discs.

To select the Menu Language default, you must be viewing the Setup Menu (Figure 1), which is available by pressing the **Menu Button** 28 while the unit is in the Stop mode. At the Setup Menu, press the **Navigation Button** 5 until the Menu option is highlighted.

To change the default Menu Language, press the **Navigation Button** 5 and note that the list of system defaults will be replaced with a list of the available options, as shown in Figure 4. The current language choice will be indicated by a filled-in circle on the list on the right side of the screen.

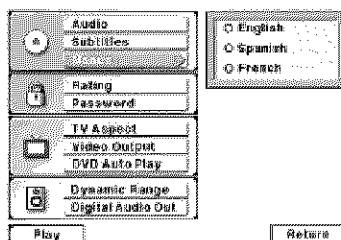

Figure 4

To change the default setting, press the **Navigation Buttons** 5 until the desired choice is highlighted, and then press the **Enter Button** 27. Note that the circle for your choice will turn orange, and the menu will return to the default listings.

If you have no other changes to make after setting this default, press the **Menu Button** 28 to remove the Setup Menu from the screen, or press the **Play Button** 7/13 to begin or resume playback.

Ratings Selection and Password Control

The DVD 50 enables you to control the discs that are viewed by setting a ratings level. When a disc has a rating level greater than the default, it will not play. To further protect against unauthorized viewing of restricted discs, the ratings-level option may be locked so that only authorized persons (such as a parent) may change the rating level after a password is entered.

The ratings system is dependent on information encoded into the DVD disc being played and, although most movies have an MPAA or other rating symbol, the disc may or may not contain that rating in its software. In addition to the five MPAA ratings of G, PG, PG-13, R and NC-17, the DVD 50 will accommodate a total of eight ratings steps, as set by the creators of the DVD format. These additional steps allow for more critical control of program playback for all audiences.

To select the permitted ratings values, you must be viewing the Setup Menu (Figure 1), which is available by pressing the **Menu Button** 28 while the unit is in the Stop mode. At the Setup Menu, press the **Navigation Button** 5 until the Rating option is highlighted.

To change the default Rating setting, press the **Navigation Button** 5 and note that the list of system defaults will be replaced with a list of the program ratings as shown in Figure 5. Some ratings will be highlighted in orange, while others will be highlighted in blue. Discs with a rating in the orange color band will play without any further action by the viewer. Discs with ratings in the blue band will only play after a password is entered.

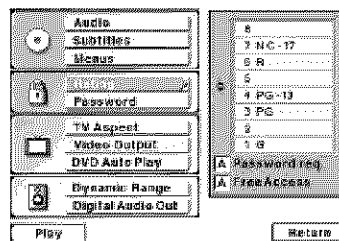

Figure 5

To change the range of ratings that may be viewed without a password, press the **Navigation Buttons** 5 until the desired range is set, and then press the **Enter Button** 27. The listing in the default settings will now show the highest rated program that may be viewed without entering a password.

If you have no other changes to make after setting this default, press the **Menu Button** 28 to remove the Setup Menu from the screen, or press the **Play Button** 7/13 to begin or resume playback.

Password Selection and Control Lock

The DVD 50's Password System is used to control viewing of restricted programs and one's capability to change the password itself. The DVD 50 is shipped without a password and with the settings for the password system unlocked. The following instructions will show how to add a password and to lock the settings.

To set a password or lock the password system, you must be viewing the Setup Menu (Figure 1), which is available by pressing the **Menu Button** 28 while the unit is in the Stop mode. At the Setup Menu, press the **Navigation Button** 5 until the Password option is highlighted.

To enter a password, press the **Navigation Button** 5 and note that the list of system defaults will be replaced with a new Menu Screen (Figure 6). To enter a password, check to make certain that the word "Set" appears to the right of an orange circle and then press the **Enter Button** 27. The Enter Password screen will then appear on your video display (Figure 7).

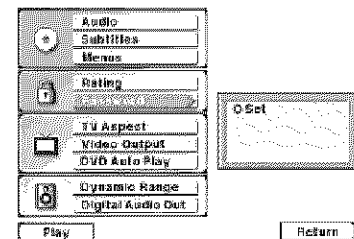

Figure 6

Setup Menu

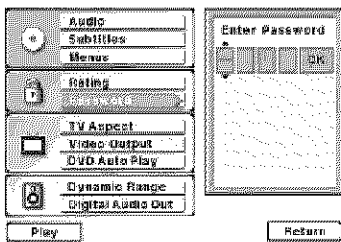

Figure 7

To enter a password you may either enter the four-digit number directly, using the **Numeric Buttons 14**, or you may use the **▲/▼ Navigation Buttons 5** to select the number for a position, and then press the **► Navigation Button 5** to move to the next position. Note that as each number is entered, it will turn to a solid circle when you move to the next position to protect the password's privacy. When all four numbers of the password have been entered, press the **Enter Button 27**.

After the password has been entered once, a second set of data entry boxes will appear, asking you to confirm the entry (Figure 8). Using the same method described earlier, enter the password again. When all four numbers have been repeated, press the **Enter Button 27** to set the password in the DVD 50's memory. If the two passwords do not agree, an "Incorrect Password" (Figure 9) message will appear to ask you to try entering the number again.



Figure 9

Once this password is entered, you will need to use this four-digit number to view a disc when the rating of the disc exceeds the settings entered in the Ratings Menu. If a password has been entered, it is also required when you change the settings range in the Ratings Menu. Finally, the password is required if you wish to unlock the system again to permit access to the Ratings Menu.

If you have no other changes to make after setting this default, press the **Menu Button 28** to remove the Setup Menu from the screen, or press the **Play Button 7/13** to begin or resume playback.

Clearing Passwords

Once a password has been entered, the system remains locked until the password is cleared. To clear a password so that the ratings may be changed or to permit any movie to be viewed regardless of ratings, you must be viewing the Setup Menu (Figure 1), which is available by pressing the **Menu Button 28** while the unit is in the Stop mode. At the Setup Menu, press the **▼ Navigation Button 5** until the Password option is highlighted. As the system is locked, you will first be asked to enter the password previously set (Figure 7). Enter that password using the **Numeric Buttons 14** and then press the **Enter Button 27**.

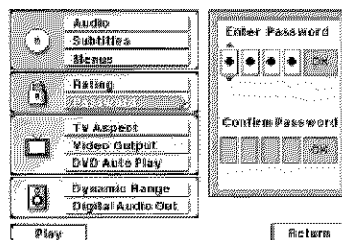

Figure 8

To clear the password lock once you have entered the correct password, press the **▼ Navigation Button 5** once so that the circle next to the word "Clear" is filled in orange and press the **Enter Button 27**. Note that the selection options will revert to Set only, as the password system is now deactivated. The **Parental Lock Indicator Q** will also go out to show that the unit has returned to normal, password-free, operation. If you have no other changes to make after setting this default, press the **Menu Button 28** to remove the Setup Menu from the screen, or press the **Play Button 7/13** to begin or resume playback.

Changing the Password

If you feel that the password has become known to an unauthorized person, you may change the password without unlocking the system. To change a password, you must be viewing the Setup Menu (Figure 1), which is available by pressing the **Menu Button 28** while the unit is in the Stop mode. At the Setup Menu, press the **▼ Navigation Button 5** until the Password option is highlighted. As the system is locked, you will first be asked to enter the password previously set. Enter that password using the **Numeric Buttons 14** and then press the **Enter Button 27**.

To change the password, press the **▼ Navigation Button 5** so that the circle next to the word "Change" is orange. Next, press the **Enter Button 27**. On the next screen that appears (Figure 7), enter the new four-digit password directly by using the **Numeric Buttons 14**, or you may use the **▲/▼ Navigation Buttons 5** to select the number for a position, and then press the **► Navigation Button 5** to move to the next position. Note that as each number is entered, it will turn to a solid circle when you move to the next position to protect the password's privacy. When all four numbers of the password have been entered, press the **Enter Button 27**.

After the password has been entered once, a second set of data entry boxes will appear, asking you to confirm the entry (Figure 8). Using the same method described above, enter the password again. When all four numbers have been repeated, press the **Enter Button 27** to set the password in the DVD 50's memory. If the two passwords do not agree, an "Incorrect Password" message (Figure 9) will appear to ask you to try entering the number again.

Once the new password has been entered, the system remains locked with the new password in effect. If you have no other changes to make after setting this default, press the **Menu Button 28** to remove the Setup Menu from the screen, or press the **Play Button 7/13** to begin or resume playback.

Aspect Ratio

The aspect ratio of a television picture is the relationship between its width and height, and it defines the shape of the picture. Television sets have traditionally had an aspect ratio of 4 x 3, which is to say that they are almost square, with slightly more width than height. Almost all television programming is presented in the 4 x 3 aspect ratio so that the pictures fit within the confines of the TV screen.

Movies, on the other hand, have a variety of what are known as "wide aspect ratio" formats that are significantly wider in relation to their height than traditional television pictures. Indeed, the development of wide-screen movies was something that was popularized in the 1950's in response to the success of television; movie producers wanted to provide a wider vista than afforded by TVs.

Setup Menu

However, since many movies are produced for a wider screen than the TV set they are played on, there is a problem that is like fitting a square peg in a round hole. In many instances this is taken care of by the disc's producers, who reformat the image to fit within a standard 4 x 3 TV screen. Discs such as this require no special setting. The only downside to this is that when wide-screen movies are converted to 4 x 3, some of the information at the sides of a scene may be cut off due to the difference in picture shape. This is also called a "pan and scan" presentation, as a 4 x 3 viewing area is moved across the wider cinema image.

Other discs are produced in what is called a "letterbox wide-screen" format. In this case the entire wide image is fit inside the 4 x 3 screen shape from side to side. This means that you see the entire picture as the movie's director intended, but the height of the picture is reduced to accommodate the added width. The blank areas that appear at the top and bottom of the screen make the image in the center appear as if you are looking into a mail slot, giving this sort of presentation the nickname of "letterbox."

The DVD format accommodates both of these formats, though it is up to the producer of the disc to select which way to convert the movie to video. Sometimes you will have a choice of only one of the two formats, while some discs offer a full screen, with the pan and scan version on one side of a disc and the widescreen, but letterbox version, on the other side.

The DVD 50 will play either type of disc, and you may select a default that tells which way to present the image when there is a choice.

To select an aspect ratio default, you must be viewing the Setup Menu (Figure 1), which is available by pressing the **Menu Button** **23** while the unit is in the Stop mode. At the Setup Menu, press the **Navigation Button** **5** until the TV Aspect option is highlighted. Next, press the **Enter Button** **27**. Select one of the three choices in the options box (Figure 10) using the **Navigation Buttons** **5**.

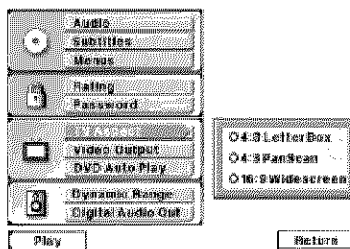

Figure 10

Depending on the type of television set you have, choose one of these three options:

- **4 x 3 Letterbox:** Choose this setting if you have a standard 4 x 3 television set and prefer to see movies in their original aspect ratio. You will see the entire movie but, when it is presented in a letterbox fashion, there will be black bars at the top and bottom of the screen. Movies or other programs recorded in a 4 x 3 format will appear normal.
- **4 x 3 Pan Scan:** Choose this setting if you have a standard 4 x 3 television set and always want the image to fill the entire screen. When a wide-screen movie is shown, you may not see parts of the picture at one side of the screen or the other. Note, however, that even when you select this option, playing a wide-screen-only movie will result in black letterbox bars at the top and bottom of the screen. This is due to the way the disc was produced, and it cannot be changed.
- **16 x 9 Wide-Screen:** Choose this setting only if you have a wide-screen television set (16 x 9 aspect ratio). With this setting, the DVD 50 will adjust the output for wide-screen movies so that they fill the entire screen in the proper aspect ratio. Note, however, that in this setting a disc recorded in the 4 x 3 aspect ratio will appear in the wide screen as a boxed image in the center, with black columns on the left and right side of the screen.

NOTE: If the wide-screen option is chosen and a wide-screen movie is played on a conventional 4 x 3 aspect ratio set, the image will be distorted due to vertical compression.

Make the selection for your desired aspect ratio by pressing the **Navigation Buttons** **5** so that the circle next to your choice is filled in orange. Press the **Enter Button** **27** to finalize the selection.

If you have no other changes to make after setting this default, press the **Menu Button** **23** to remove the Setup Menu from the screen, or press the **Play Button** **7/13** to begin or resume playback.

Video Output

The DVD 50 is among the first 5-disc DVD changers available that offers the option of high-quality, progressive scan output in addition to standard composite video and S-Video outputs. When used with a compatible "digital ready" television, the progressive scan output delivers twice the information of a standard picture for a seamless, cinema-like image.

IMPORTANT NOTES ON PROGRESSIVE SCAN OPERATION:

The progressive scan outputs may only be used with video displays (direct-view monitors, rear or front projectors) that have progressive scan compatibility. In general, this includes sets designed for use with high-definition television (HDTV), as well as other high-scan-rate monitors and displays. If the specifications for your display show a "horizontal scan rate" figure of 31.5 kHz or higher, then the set is most likely compatible with the progressive scan signal. If you have any doubt as to the compatibility of your display with the high-scan-rate signal, consult the set's owner's manual, ask your dealer or installer, or contact the set manufacturer. If the progressive scan rate output is enabled, but the display device is not compatible, you will not be able to see any image.

If your video display is compatible with progressive scan, make certain that you connect the DVD 50 to the display using the **Component Video Outputs** **4**. Depending on the specifics of your display, the correct input may be labeled "Component Video", "HD Component Input" or some other similar term. If there is a question as to which input jacks should be used on your video display, consult the set's owner's manual, ask your dealer or installer, or contact the set manufacturer.

Setup Menu

To select the Video Output you must first be viewing the Setup Menu (Figure 1), which is available by pressing the **Menu Button 28** while the unit is in the Stop mode. At the Setup Menu, press the **Navigation Button 5** until the Video Output option is highlighted. Press the **Enter Button 27** to view the options for this selection (Figure 11).

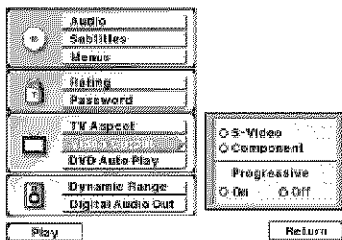

Figure 11

If you are using the S-Video output only, no change is required, but it is a good idea to check this option to make certain that the circle next to the S-Video option is orange.

If you are using the Component Video jacks, but are connecting the DVD 50 to a standard (analog) television, press the **Navigation Buttons 5** so that the circle next to the word "Component" is orange. Press the **Enter Button 27** to store the setting in the DVD 50's memory, but DO NOT change the setting in the bottom half of the menu box. The orange circle in the Progressive section of the menu should be next to "Off".

If you are using the Component Video jacks for connection to a video display that is compatible with a progressive scan signal, first press the **Navigation button** so that the circle next to the word "Component" is orange. Next, press the **Enter Button 27**, then press the **Navigation Buttons 5** so that the orange circle in the lower portion of the menu box under the word "Progressive" is next to the word "On". Press the **Enter Button 27** to enter the setting to the DVD 50's memory.

WARNING: Once the setting for progressive scan output is entered, an image will only be visible on a progressive scan-compatible video display. If you change the setting to "Progressive" Scan in error, you must reset the unit by first pressing the **Stop Button 10/11** to stop any disc that is playing. Next, press the **Stop Button 10/11** again and hold it for five seconds before releasing it. Turn the unit off and pause for a few seconds. When you turn

the DVD 50 on again, the video output will be restored to the standard setting, and a picture will once again be visible on a conventional analog display.

If you have no further changes to make after setting this default, press the **Menu Button 28** to remove the Setup Menu from the screen, or press the **Play Button 7/13** to resume playback.

To enable the Auto Play function you must first be viewing the Setup Menu (Figure 1), which is available by pressing the **Menu Button 28** while the unit is in the Stop mode. At the Setup Menu, press the **Navigation Button 5** until the Auto Play option is highlighted. Press the **Enter Button 27** to view the options for this selection (Figure 12).

DVD Auto Play

The DVD 50's Auto Play function makes it easier and more enjoyable to view DVDs. When this feature is activated, the unit will automatically start playback when the Main Menu of a DVD appears if no other button is pressed within three seconds of the time the Main Menu appears. In normal use, most discs stop at the Main Menu to wait for your input, requiring some user intervention. With Auto Play, DVD viewing is seamless, as the start of the movie is automatically selected unless another function is specifically requested. Of course, even with Auto Play in effect, you may always customize the disc's playback by pressing any button to make your selection within three seconds.

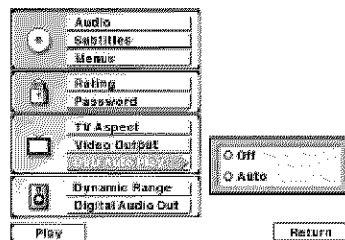

Figure 12

To enable the Auto Play function, press the **Navigation Button 5** so that the circle next to the word "Auto" is orange. Next, press the **Enter Button 27** to activate the feature and store the setting in the DVD 50's memory. Note that the **AUTOPLAY Indicator 11** will light to remind you that DVD discs will go directly into the Play mode, rather than stop at their Main Menu.

To disable the Auto Play function, press the **Navigation Button 5** so that the circle next to the word "Off" is orange. Next, press the **Enter Button 27** to store the setting in the DVD 50's memory. If the setting was previously active, the **AUTOPLAY Indicator 11** will go out.

If you have no further changes to make after setting this default, press the **Menu Button 28** to remove the Setup Menu from the screen, or press the **Play Button 7/13** to resume playback.

Setup Menu

Dynamic Range Setting

With the DVD format you have the opportunity to hear a program's soundtrack in the most accurate and realistic presentation possible, thanks to the use of digital audio technology. However, in certain instances you may wish to slightly compress the dynamic range of the audio output (the difference between the loudest sounds and the quietest ones) so that you may listen to a movie at a lower volume without losing dialog intelligibility.

In most cases it is desirable to leave the Dynamic Range setting at "OFF" so that no compression is applied to the audio, but if you wish to change to a compressed setting, follow these steps.

First, you must be viewing the Setup Menu (Figure 1), which is available by pressing the **Menu Button** **28** while the unit is in the Stop mode. At the Setup Menu, press the **Navigation Button** **5** until the Dynamic Range option is highlighted. Next, press the **Enter Button** **27** and select one of the two choices in the options box using the **Navigation Buttons** **5** (Figure 13). The choices are as follows:

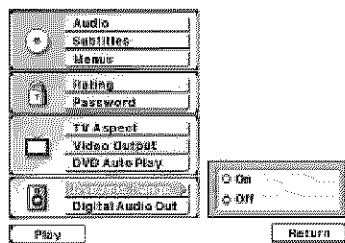

Figure 13

- **Off:** Select this option to turn off the Dynamic Range compression and have the soundtrack presented exactly as it was authored.
- **On:** Select this option to turn on the Dynamic Range compression circuitry so that the dialog will remain clear even at low volume levels.

When you have made your selection using the **Navigation Buttons** **5** to highlight the desired option, press the **Enter Button** **27** and note that the circle next to your choice will fill in. The menu system will then automatically return to the status listing.

If you have no other changes to make after setting this default, press the **Menu Button** **28** to remove the Setup Menu from the screen, or press the **Play Button** **7/13** to begin or resume playback.

Note that the performance of the Dynamic Range function is dependent on the audio format of the disc being played, and whether or not the disc's soundtrack is capable of this feature.

Digital Audio Out

DVD players accommodate a variety of audio formats, including Dolby Digital, DTS and the PCM audio format used by conventional CD discs and some DVD playback. Depending on the type of equipment your DVD 50 is connected to, you need to set a default for the type of audio outputs accommodated. Although the DVD 50 will play all of these disc types, this setting creates a default that tells which way to present the soundtracks when there is a choice.

In addition to compatibility with both Dolby Digital and DTS multichannel soundtracks, the DVD 50 also accommodates the latest 96kHz DVD recordings. This menu section allows you to select how 96kHz audio programs are handled so that they are compatible with your A/V receiver or surround processor.

To select a Digital Audio Output default, you must be viewing the Setup Menu (Figure 1), which is available by pressing the **Menu Button** **28** while the unit is in the Stop mode. At the Setup Menu, press the **Navigation Button** **5** until the Digital Audio Out option is highlighted. Next, press the **Enter Button** **27**. Select one of the three choices in the options box (Figure 14) using the **Navigation Buttons** **5**. The choices are as follows:

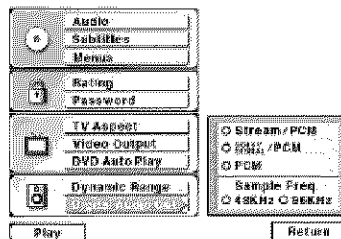

Figure 14

■ **Stream/PCM:** Choose this option if your A/V receiver or surround processor is capable of decoding both Dolby Digital and DTS audio. With this selection, either Dolby Digital or DTS will be output according to the choice made in the Audio Menu options provided by the DVD disc.

■ **Dolby Digital/PCM:** Choose this option if your A/V receiver or surround processor has a digital input, but is only capable of decoding Dolby Digital. With this selection, when both a Dolby Digital and DTS program are present, the DVD 50 will automatically output the Dolby Digital data stream.

■ **PCM:** Choose this setting if you are using only the left/right **Analog Audio Outputs** **3**, or if the **Digital Audio Outputs** **7/8** are connected to a processor that is capable of decoding only conventional PCM audio for CDs.

Remember, regardless of the option chosen, you may still have to adjust the settings on your audio equipment or in a specific disc's menus to match the output of the DVD 50. In addition, the choice of which audio formats are available is limited by the type of material recorded on the disc when it was authored.

Use the **Navigation Buttons** **5** to make your selection, as noted by the circle to the right of your desired choice turning orange.

Once a selection has been made for the type of digital audio data streams that the DVD 50 outputs, you may also need to adjust the way it handles the various sampling frequencies used in the production of digital audio for DVD. The DVD 50 is compatible with both 48kHz and 96kHz sampling, but some early A/V receivers and surround processors are not. If your audio system is NOT capable of handling 96kHz audio signals in their native form, do not make any changes to the bottom part of the Digital Audio Out menu, and press the **Enter Button** **27** twice to return to the Main Menu Settings option. However, if your audio system can handle these signals, change the setting to achieve the greatest audio fidelity possible.

Setup Menu

To change the Sample Frequency setting, first select the desired digital audio output type as indicated above. Then, press the **Enter Button**

27. Press the **▲/▼ Navigation Buttons**

5 so that that circle next to your desired choice is orange.

If your A/V receiver or surround processor is NOT capable of handling 96kHz signals, select the 48kHz option. When this choice is made, the DVD 50 will automatically convert any 96kHz signals to a 48kHz output so that your system is capable of decoding them.

If your A/V receiver or surround processor IS capable of handling 96kHz signals, select the 96kHz option. When this choice is made, the DVD 50 will pass each type of signal through without any further processing. When a 96kHz signal is present, it will be noted by the **96kHz/24-Bit Audio Indicator** **I**.

Once the selection is made, press the **Enter Button** **27** to return to the Main Settings Menu.

At this point you will have completed all of the steps needed to configure the DVD 50 for the specifics of your system. Before playing a disc you may use the **▲/▼ Navigation Buttons** **5** to return to any of the items for additional changes, or you may press the **Play Button** **7/13** to begin or resume playback of a program.

Playback Basics for All Formats

Loading Discs

To load discs in the DVD 50, first make certain that the unit is turned on by pressing the **Power Switch** **2/1** so that the **Status Indicator** **2** turns green.

Next, press the **Open/Close Button** **9/9** until the **Disc Tray** **5** opens.

Holding the discs by the edge, gently place each one into one of the compartment slots in the drawer. Note that there is a number embossed onto the drawer tray at the right of the disc slot. This is the number for that specific disc position; it will be used to indicate the disc in both the Information Display and the on-screen displays.

When loading discs, please note the following:

- The DVD 50 will play discs with the following logos only. DO NOT attempt to play another type of disc, as shown in the list on page 5.



- The DVD 50 will only play discs in the NTSC video format. It will not play discs for other standards such as PAL or SECAM.
- Playback capability for CD-RW discs will vary according to the quality of the CD-RW disc. On some occasions it is possible that CD-RW discs may not play on the DVD 50. This does not indicate any problem with the DVD 50.
- The DVD 50 will only play discs that are coded for Region 1 or discs that are open to being played in all regions. Discs that contain a Region Code of 2, 3, 4, 5 or 6 (as noted by a number inside a world map logo on the disc's cover jacket or case) will not play.
- Both 5-inch (12cm) and 3-inch (8cm) discs may be used.
- When loading CD audio discs, load the discs with the label side up.

- When loading DVD discs with printed labels, load them label side up.
- Some DVD discs are double-sided. The title information for these will be printed on the inner ring of the disc, very close to the center hole. The title for the side you wish to play should be facing up.

To move the discs in the tray so that you may insert discs in slots that are partially hidden inside the disc tray drawer, press the **Disc Skip Button** **7/13**. Each press of the button will move the carousel tray one position to the left (counterclockwise).

- To access all disc positions, the unit must be in the full-stop position. If the unit is in the Play mode, press the **Stop Button** **11/10** twice.
- If the disc tray drawer is opened while a disc is playing, the Play Exchange feature allows you to change the remaining four discs. Simply press the **Disc Skip Button** **7/13** to move the discs in the tray in one direction or the other.

IMPORTANT NOTES ON DISC LOADING

- Remove all discs from the tray before moving the player.
- Make certain that all discs are properly seated before closing the disc tray drawer.
- Do not push the disc tray drawer with the power off.
- Do not attempt to change discs or touch the disc tray carousel while it is moving.
- Do not attempt to rotate the disc tray by hand. If the tray drawer or carousel tray appears to be stuck, contact your local Harman Kardon authorized service center.
- When loading discs, always place the discs one at a time in the center position in the tray, even if there are empty positions to the left and right of center. After placing a disc in the center position, press the **Disc Skip Button** **7/13** to bring the next empty position to the center. Loading discs in this manner will ensure that the unit recognizes that there is a disc in that place in the tray.

- Do not load more than one disc in each slot in the tray and do not attempt to place a standard 5-inch (12cm) disc over a smaller 3-inch (8cm) disc.
- When using the Play Exchange feature you may see an empty disc position rotate past the center of the player in a way that prevents you from placing a disc there. This is normal, as the empty slot is actually the one that belongs to the disc being played. DO NOT ATTEMPT TO PLACE A DISC IN THE SLOT if it passes by the front of the machine and disappears under the left side of the drawer. Should a disc inadvertently be placed in this slot, the machine will sense the error if the drawer is closed with a disc in the current-play disc's slot and bring the disc back to the center position for removal. To prevent damage to the unit's mechanism, the disc drawer will not close until the extra disc is removed.

Once the discs are loaded, press the **Open/Close Button** **9/9** to close the disc tray. When the tray drawer closes, the disc that was last in the center position facing outward in the tray will be readied for playback. After the drawer closes, you will see a brief indication of **Reading** in both the Information Display and in the on-screen display to alert you to the fact that the unit is determining the type of disc (DVD or CD) and is reading the data for track, chapter, title and other information about the disc. At the same time, the **Disc Number Indicator** **8** for the disc in use will begin to flash, indicating which disc is being played.

Once the disc's data has been read, the type of disc (DVD or VCD) will be displayed by the **Disc Type Indicator** **A** and the disc will automatically begin playing. The disc's track timing information and other relevant data will appear in the **Information Display** **12**. For CD discs only, a Status Menu Bar will appear in the on-screen display. To view this display for DVD discs, press the **Status Button** **3**.

The **Disc Number Indicator** **8** will show a lighted number for the disc slot positions that are occupied, and the number for disc in use will flash. Note, however, that all occupied positions may not be shown until the disc tray has been rotated past an empty or occupied slot by pressing the **Disc Skip Buttons** **7/13**, or by manually selecting a specific disc with the **Direct Access Buttons** **6**.

Playback Basics for All Formats

Auto Power Shut-Off

As an optional feature, you may set the DVD 50 so that it automatically turns off after ten minutes when the unit is idle and no disc is playing. The normal factory default for this feature is "OFF", meaning that the unit will remain on until turned off using the **Power Switch 11** on the front panel or the **Power-Off Button 29** on the remote. However, should you wish to activate this feature, follow these steps:

- While the unit is stopped and no disc is playing, press and hold both the **Reverse Search Button 8** and the **Next Button 26** simultaneously for five seconds.
- Release the buttons when you see that the **Information Display 14** reads **AUTO OFF N.**
- Press the **Next Button 26** to toggle the display so that it reads **AUTO OFF Y.**
- Press any other button on the remote to store the setting and to return the unit and the display to normal operation.

Should you wish to reverse the setting back to the "OFF" mode, so that the unit stays on until manually turned off, repeat the procedure outlined above but toggle the display so that it reads **AUTO OFF N.**

Playback Basics for All Formats

Basic playback with the DVD 50 involves functions similar to those you may be familiar with for conventional CD players or changers:

- Turn the unit on by pressing in the **Power Switch 1/2**.
- If there are discs already loaded in the unit, the last disc to be played will automatically begin playing. If the disc was stopped using the Resume function, playback will begin from the point where it was stopped. If the disc was stopped by pressing the **Stop Button 11/10** twice, the disc will begin playing from its beginning.
- Load any new discs as indicated in the previous section.
- After loading discs, press the **Open/Close Button 9/9** to begin play.

Playback Features for DVD and CD Discs:

- To move to the next disc in the unit, press the **Disc Skip Button 7/13**.
- To select a specific disc in the player, press the **Direct Access Button 6** corresponding to the slot where that disc is loaded.
- To momentarily pause playback and freeze the current picture frame on a DVD, press the **Pause Button 12/24**. To resume playback after pressing the Pause button, press the **Play Button 13/7**.
- To move forward or backward through the tracks on a CD or the chapters on a DVD, press the **Skip Forward/Reverse Button 10** on the front panel or the **Previous/Next Buttons 6/26** on the remote.
- To move forward or backward through the DVD or CD disc being played at fast speed, press the **Search Forward/Reverse Buttons 8/8/25**. Once one of these buttons is pressed, the fast search will continue until the **Play Button 13/7** is pressed. Note that the fast-play speeds vary for CD discs and DVDs.

For DVD playback, there are four fast-play speeds. Each press of the **Search Forward/Reverse Buttons 8/8/25** will cycle to the next speed in the following order:

- In Fast Search x2, both segments of the **◀◀ or ▶▶ Playback Mode Indicator S** will light steadily.
- In Fast Search x4, the outside segment of the **◀◀ or ▶▶ Playback Mode Indicator S** will flash and the inside segment will remain steadily lit.
- In Fast Search x16, the inside segment of the **◀◀ or ▶▶ Playback Mode Indicator S** will flash and the outside segment will remain steadily lit.
- In Fast Search x100, both segments of the **◀◀ or ▶▶ Playback Mode Indicator S** will flash.

Note that there will be no audio playback during fast-forward or reverse-play of DVD discs. This is normal for DVD, as A/V receivers and surround processors cannot process the digital audio streams during fast-play modes; audio will be heard during fast-play of conventional CDs.

For CD playback, there are three fast-play speeds. Each press of the of the **Search Forward/Reverse Buttons 8/8/25** will cycle to the next speed in the following order:

- In Fast Search x2, both segments of the **◀◀ or ▶▶ Playback Mode Indicator S** will light steadily.
- In Fast Search x4, the outside segment of the **◀◀ or ▶▶ Playback Mode Indicator S** will flash and the inside segment will remain steadily lit.
- In Fast Search x8, the inside segment of the **◀◀ or ▶▶ Playback Mode Indicator S** will flash and the outside segment will remain steadily lit.

NOTE: Fast Search Plus is not available when MP3 discs are playing.

When playing a DVD disc, you may move forward or backward through the program being played in one of four speeds by pressing the **Slow Play Buttons 11** on the remote. Each press of the buttons will move to the next speed in the following order:

- In the 1/16th Speed Slow mode, both segments of the **◀◀ or ▶▶ Playback Mode Indicator S** will flash.

- In the 1/8th Speed Slow mode, the inside segment of the **◀◀ or ▶▶ Playback Mode Indicator S** will flash and the outside segment will remain steadily lit.
- In the 1/4 Speed Slow mode, the outside segment of the **◀◀ or ▶▶ Playback Mode Indicator S** will flash and the inside segment will remain steadily lit.
- In the 1/2 Speed Slow mode, both segments of the **◀◀ or ▶▶ Playback Mode Indicator S** will remain steadily lit.

Note that there is no audio playback during slow-forward or -reverse play of DVD discs. This is normal for DVD, as A/V receivers and surround processors cannot process the digital audio streams during slow modes. Slow play is not available for CD discs.

- When a camera icon appears on the screen, and the **Angle Indicator 4** flashes, this is your indication that there is multiple-angle information on the disc being played. To change the angle, press the **Angle Button 30** until the desired angle view appears. An on-screen banner message will appear to indicate the angle view in use.

To illuminate the buttons on the remote control so that they may be seen in low-light conditions, press the **Light Button 17**.

DVD Playback

Using a DVD's Menu

One of the unique features of the DVD system is that it offers a producer the opportunity to include a wide range of features on a disc, including multiple-language tracks; subtitles in a variety of languages; special information such as movie trailers and cast information; as well as other custom-tailored information. In addition, producers may divide a movie or program into chapters that allow for quick access to specific parts of the program. These chapters may be accompanied by thumbnail pictures of a scene from the specific chapter to help you select the desired spot on the disc.

When a disc is playing, press the **Menu Button 23** to pause the playback and display the disc's menu. As there are no hard rules about style and contents of DVD menus, the way they appear on the screen and the information they contain will vary from one disc to another. However, the following general rules apply to most menus:

- The first menu that appears is the Main Menu, and you may move through the options with the **▲/▼/◀/▶ Navigation Buttons 5**, as the disc's programming allows. The option selected will typically be highlighted in a certain color or inside an outline box.
- To select a highlighted option, which may either play a portion of the disc or move to a sub-menu, press the **Enter Button 27** or **Play Button 7/13**.
- On some discs, when you select the DVD menu during the playback of a movie, the disc will return to the point in the program where the menu was selected by offering a "Play Movie" option. Press the **Enter Button 27** or **Play Button 7/13** to resume play. However, not all discs offer this feature, and selecting the menu while playing a movie may mean that you will either have to go back to the beginning of the program or the start of a chapter. This feature is out of the control of the DVD 50, as it is set by the disc's internal programming.

IMPORTANT NOTES ON DVD PLAYBACK

The DVD 50 is capable of all the features and options covered by the DVD standards. However, it is up to the producer of a DVD disc to decide which of those features and functions are available on any given disc. For that reason, not all discs will function identically, and some discs will not have many of the features of the DVD system. For example, most current DVD discs do not take advantage of the multiple-angle feature. When you press a button and the player displays the "Feature Prohibited" icon "⊙", this is an indication that the disc has not been programmed for that feature.

In addition, it is common for the producers of DVD discs to block the use of certain functions during only some parts of a disc. For example, many discs prohibit the use of fast-play buttons or prohibit access to the Chapter Menu display during the playback of copyright notices, studio logos, movie credits or trailers. The appearance of the "Feature Prohibited" icon "⊙", or the inability of certain features to operate when the disc itself has prohibited them, does not indicate a problem with the DVD 50, as these features are outside of the unit's control.

Zoom Feature

The DVD 50's advanced digital video processing circuits include a Zoom feature that allows you to enlarge the image for closer examination of a particular part of the picture. Six steps of enlargement are available, and you may move the picture around the screen while it is enlarged to locate a specific area.

- To use the Zoom feature, press the **Zoom Button 21** while a disc is playing or paused. Each press of the button will increase the zoom-in effect. When you have zoomed through all six steps, the picture will return to normal size.
- While an image is enlarged, you may use the **▲/▼/◀/▶ Navigation Buttons 5** to shift the image on the screen so that areas of the picture that have zoomed off the screen may be viewed.

- To return to normal image size at any time while the Zoom feature is in use, press the **Clear Button 20**.

- Note that some discs are created in a way that prevents the Zoom feature from operating. In addition, the Zoom feature will not operate on disc menus and may not operate on subtitles.

Playback Resume Feature

The DVD 50 offers a "Resume" feature that is different from the conventional "STOP" function you may be used to on CD players. When the **Stop Button 11/10** is pressed once, the disc will stop, an on-screen RESUME indication will appear on the video screen and the **Resume Indicator R** will light. While the Resume feature is active, the disc's position is entered into the unit's memory so that when the **Play Button 13/7** is pressed to resume playback, the program will continue at the point where it was when the Stop button was pressed.

To completely stop playback, press the **Stop Button 11/10** twice.

DVD Playback

Using the On-Screen Menu Bar for DVD Playback

The DVD 50 is equipped with a powerful on-screen display system that serves the dual purpose of showing you the current status of the DVD 50 while enabling quick and easy changes to settings and functions. Depending on whether a DVD or CD is in use, the menu will vary to display information that is specific to the type of disc in play.

DVD Menus and Controls

When a DVD is playing, press the **Status Button 3** to view the status of the current disc and to change the setting for key playback functions (Figure 15).

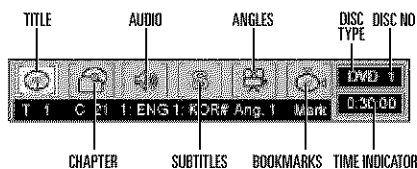

Figure 15

Title: The number shown indicates the number of the title that is currently playing.

Chapter: The number shown indicates the number of the chapter that is currently playing.

Audio: The number and abbreviation show the audio language soundtrack that is currently playing. Consult the DVD jacket for the key to available audio tracks on the disc.

Subtitles: The number and abbreviation show the subtitle language that is currently playing. Consult the DVD jacket for the key to available subtitle languages on the disc.

Angles: The number shown indicates the multiple-angle view that is currently playing.

Bookmarks: Highlight this area and press the **Enter Button 27** to mark or go to previously bookmarked locations on a disc.

Disc Type: The type of disc playing (DVD, VCD or CD) is shown.

Disc Number: The slot number of the disc being played is shown.

Time Indicator: The elapsed time of the current title is shown.

Once the Menu Bar appears, press the **Navigation Buttons 5** to move across the display to select the desired option. When the option to be changed is highlighted in white with yellow brackets on both sides, press the **Enter Button 27** to change the setting for that option.

Selecting a Title

Some discs contain more than one title. Remember that a disc may contain one title, two separate program titles, or the disc may use the Title function to separate out the special feature sections on the disc. The use of titles is optional with the producer of each DVD disc, as is the way in which he/she may choose to implement the feature.

To change the title on those discs using the Menu Status Bar, follow these steps:

1. During disc playback, press the **Status Button 3**.
2. If needed, press the **Navigation Buttons 5** until the disc icon for the current title, with the letter "T" underneath it, is highlighted in white between yellow brackets.
3. Press the **Enter Button 27**.
4. Note that the number to the right of the "T" will be replaced with two dashes (—).
5. Use the **Numeric Buttons 14** to enter the number of the title to be accessed.
6. The desired title will automatically be started.

Titles may also be selected during the playback of a DVD by pressing the **Title Button 1**. However, the action of the disc when pressing this button will vary from disc to disc. On occasion, pressing this button will take you to the disc's main menu while, in other cases, pressing this button will result in no action at all.

Selecting a Chapter

The movies or programs on most discs are divided into individual chapters, as selected by the disc's producer. Using the on-screen Menu Bar, you may view the number of the current chapter and move to any chapter on the disc.

To change the chapter using the Menu Status Bar, follow these steps:

1. During disc playback, press the **Status Button 3**.
2. Press the **Navigation Buttons 5** until the icon showing a disc and a file folder (second from the left), with the letter "C" underneath it, highlighted in white between yellow brackets.
3. Press the **Enter Button 27**.
4. Note that the number to the right of the "C" will be replaced with two dashes (—).
5. Using the **Numeric Buttons 14**, enter the number of the title to be accessed.
6. The desired title will automatically be started.

Changing the Audio Track

DVD discs may contain a variety of audio tracks, including foreign languages, special commentaries, descriptive video for the sight-impaired, and various digital formats. In normal play, the unit will always look for the default setting for the audio track, but you may change the audio track at any time using the Menu Status Bar and following these steps:

1. During disc playback, press the **Status Button 3**.
2. Press the **Navigation Buttons 5** until the speaker icon (third from the left) is highlighted in white between yellow brackets.
3. Press the **Enter Button 27**.
4. Note that the main Menu Bar will be replaced with a single display of the current language type (Figure 16).



Figure 16

5. Press the **Enter Button 27** until the desired audio track is displayed. Note that the audio tracks available on a disc will vary and that they are always listed on the disc's jacket or cover.
6. Within a few seconds, the disc will continue play with the newly selected audio track.

DVD Playback

Changing the Subtitle Language

DVD discs may contain a variety of subtitles. In normal play, the unit will always look for the default setting for the subtitle language, but you may change that language at any time using the Menu Status Bar and by following these steps:

1. During disc playback, press the **Status Button** **3**.
2. Press the **Navigation Buttons** **5** until the letter "S" icon (fourth from the left) is highlighted in white between yellow brackets.
3. Press the **Enter Button** **27**.
4. Note that the main Menu Bar will be replaced with a single display of the subtitle language (Figure 17).



Figure 17

5. Press the **Enter Button** **27** or **Navigation Buttons** **5** until the desired subtitle language is displayed. Note that the subtitles available on a disc will vary, and they are always listed on the disc's jacket or cover. Some discs may not offer alternative subtitles, or any subtitles at all.
6. Within a few seconds, the disc will continue to play with the newly selected subtitle language.

Note that the subtitle language selected in this fashion is temporary, and will remain in effect until the player is turned off. When the unit is turned on for subsequent play, the default subtitle language will always be used.

Note that the subtitle feature may also be turned on or off, and the subtitle language may be changed directly from the remote control during playback. To change the subtitle status, press the **Subtitle On/Off Button** **31** and note that a display of the currently selected subtitle language will appear on screen.

To turn the subtitles on or off, press the **Subtitle On/Off Button** **31** again. When there is a check mark in the box to the right of the language indication, the subtitles are on; when there is no check the subtitles are off. Each press of the button will turn the subtitles on or off. No further action is needed once the selections have been made; the on-screen message will go off within five seconds.

To change the subtitle language during playback, press the **Subtitle On/Off Button** **31**. Next, press the **Navigation Buttons** **5** until the desired language name appears. If needed, press the **Subtitle On/Off Button** **31** to turn the subtitle display on after the language selection has been made. No further action is needed once the selections have been made; the on-screen message will go off within five seconds.

IMPORTANT NOTE: The steps indicated on the page allow you to change the subtitle language, but they do not determine if the subtitles are actually displayed on the screen. To have the subtitles appear at any time, press the **Subtitle On/Off Button** **31** to toggle the subtitles on or off with each press of the button. When the subtitles are active, a Checkmark icon "✓" will appear in the box to the right of the subtitle description as shown earlier.

Also note that some DVD discs do not contain subtitles. When the **Subtitle On/Off Button** **31** is pressed on a disc with no subtitles, the Prohibit icon "⊘" will appear on screen.

Changing Camera Angles

A special feature of the DVD format is its capability of showing more than one view, or camera angle, of the same scene. This feature enables you to become the director, selecting the view of a scene that you wish. Note, however, that this feature does not appear on many discs and, when it does appear, it will typically be for only certain scenes and not for the entire disc's program. If you attempt to use the multiple-angle feature on a disc that is not programmed for it, you may see the Prohibited Feature icon "⊘" on the screen. This is not a fault of the player, but it simply indicates that the feature is not available on the disc being played.

To see whether a disc contains multiple angles, check the disc's cover or jacket. When a disc does contain scenes with multiple angles, the producers will usually include some sort of special on-screen icon to alert you to the availability of different angles of view.

When a disc that contains multiple-angle information is playing, the **Angle Indicator** **14** will light steadily throughout the disc. This tells you that there are some places on the disc with multiple camera angle choices. However, in almost all cases, the actual use of multiple angles will be restricted to specific places on the disc rather than appearing throughout the

program. When the **Angle Indicator** **14** flashes and a camera icon indicator appears on the video screen, that is your signal that multiple angles are present and that they may be changed.

When multiple camera angles are available, the easiest way to change the angle is to press the **Angle Button** **30**. Each press of the button will change the angle, as shown by the on-screen display (Figure 18). Once you have selected the desired angle, no further action is needed and the on-screen messages will disappear within a few seconds.



Figure 18

Note that the number of multiple angles available and their placement on the disc is set by the producer of each individual DVD, and is not set by the DVD 50. The number of angles available will vary from one disc to another.

CD Playback

Using the On-Screen Menu Bar for CD Playback

The DVD 50 allows you to take advantage of the on-screen Menu Bar even when playing CDs. The use of this graphical display makes it easy to select CD functions.

CD Menus and Controls

When a CD is playing, the Menu Bar will automatically appear in your video display, even though there is no video on the CD itself. To remove the Menu Bar at any time, press the **Clear Button** 20. If the Menu Bar is not present, press the **Status Button** 3 to have it appear on the screen (Figure 19).

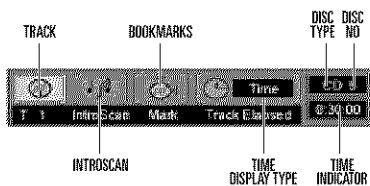

Figure 19

Track: The number shown indicates the number of the track that is currently playing.

IntroScan: When the IntroScan feature is active, the musical notes in this icon will change.

Bookmarks: Highlight this area and press enter to enter or go to bookmarked locations on a disc.

Time Display Type: This shows the type of time indication being shown: Time Remaining for the Current Track, Total Elapsed for the Disc, or Total Remaining for the Disc.

Disc Type: Shows the type of disc being played.

Disc Number: The slot number of the disc being played is shown.

Time Indicator: The time indication selected is shown.

Once the Menu Bar appears, press the **Navigation Buttons** 5 to move across the display to select the desired option. When the option to be changed is highlighted in white with yellow brackets on both sides, press the **Enter Button** 27 to change the setting for that option.

Selecting a Track

To select any track on a CD, follow these steps:

1. During disc playback, press the **Status**

Button 3 if the Menu Bar is not already on the screen.

2. If needed, press the **Navigation Buttons** 5 until the disc icon with the letter "T" underneath it is highlighted in white between yellow brackets.

3. Press the **Enter Button** 27.

4. Note that the number to the right of the "T" will be replaced with two dashes (—).

5. Using the **Numeric Keys** 14, enter the number of the track to be accessed.

6. The desired title will automatically be started.

Using IntroScan

The IntroScan feature allows you to sample the tracks on a CD by playing the first ten seconds of each track and then moving to the next track. To use IntroScan, follow these steps:

1. During disc playback, press the **Status Button** 3 if the Menu Bar is not already on the screen.

2. If needed, press the **Navigation Buttons** 5 until the musical score icon with the words "IntroScan" underneath it (second from the left) is highlighted in white between yellow brackets.

3. Press the **Enter Button** 27.

4. Note that the disc will immediately begin to play the first track on the disc and the musical notes in the icon will change and flash.

5. The unit will play the first ten seconds of each track on the disc, moving from one track to the next.

6. To play a track during IntroScan, press the **Play Button** 7/13.

7. If no track is selected, the disc will stop playing when it has played the first ten seconds of each track in order.

Time Display Selection

When playing CDs, the DVD 50's displays are capable of the time displays that you are familiar with from traditional CD-only players. The choice of a time display is made through the use of the on-screen Menu Bar, but any changes to the display will also change the Time Display mode for the Information Display.

To change the time display during CD playback, follow these steps:

1. During disc playback, press the **Status Button** 3 if the Menu Bar is not already on the screen.

2. If needed, press the **Navigation Buttons** 5 until the clock icon with the word "Time" next to it is highlighted in white between yellow brackets.

3. Press the **Enter Button** 27 to select one of these four choices. Each press of the button will select the next option:

- **Track Elapsed:** This shows the time that has elapsed for the current track. At the start of each track this display will reset to zero and begin to count up again.

- **Track Remain:** This shows the time remaining for the current track. At the start of each track the time will begin to count down again, starting with the total time of the track.

- **Disc Elapsed:** This shows the total time that the current disc has played for all tracks.

- **Disc Remain:** This shows the total time remaining for all tracks on the disc that have not yet been played.

CD-Text

CD-Text is a special data code inserted in some CD releases that enables the DVD 50 to display the title of each track, the artist's name and other data. When a disc with CD-Text information is playing, press the **Title Button** 1 to view the Text information in the **Information Display** 14. The information will scroll across the display once, and then the display will return to normal operation.

HDCD Playback

HDCD is a process that increases the fidelity of both specially encoded HDCD discs and standard CD audio discs. When an HDCD-encoded disc is playing, the special decoder is automatically activated and the **HDCD Indicator** F lights. No user intervention is required.

To enjoy the benefits of HDCD, your DVD 50 must be connected to your A/V receiver via the **Analog Audio Outputs** 3. However, if your A/V receiver or surround processor is equipped with built-in HDCD decoding, you may also use a **Coaxial** 7 or **Optical** 8 digital audio connection so that the HDCD processing is done there.

MP3 Disc Playback

The DVD 50 is rare among DVD players in that it is able to playback discs recorded with MP3 files. This means that you may enjoy the latest music using discs created in your computer through the high quality audio components in your home theater system. As the way that MP3 files are recorded on discs differs from the way conventional CD audio discs are structured, MP3 playback is somewhat different from standard CDs.

MP3 Disc Playback

When the DVD 50 reads a disc and recognizes it as an MP3 disc, the **MP3 Indicator** **I** will light and a listing of all the directories and tracks on the disc will appear on the video screen. (Figure 20). Note that the right side of the screen will initially be blank, as that is used for programming playlists for MP3 playback.

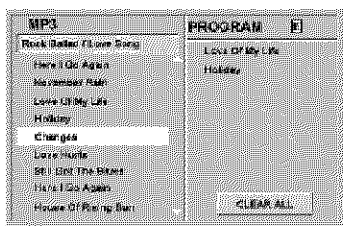

Figure 20

To play a track, press the **▲/▼ Navigation Buttons** **5** until the desired track name is highlighted in yellow. If the list of tracks is longer than will fit on the screen, a **▲** or **▼** indicator will appear at the top or bottom of the track list to remind you that you may scroll through the list to see additional titles.

To begin playback press the **Play Button** **13/7** and note that a check mark will also appear to the left of the track being played.

During MP3 playback most of the standard CD/DVD playback controls operate in their normal fashion:

- You may skip forward to the next track on the disc by pressing the **Next Button** **26**
- You may skip back to the previous track on the disc by pressing the **Previous Button** **6**
- Press the **Pause Button** **24** to momentarily stop playback. Press it again to resume play.

NOTES ON MP3 PLAYBACK

- The Fast Forward and Reverse Search modes are not available during MP3 playback.
- During MP3 playback the **Program Time Indicators** **E** will show the elapsed time of

the track being played. Other time display options are not available with MP3 playback.

- The DVD 50 is only compatible with standard MP3-encoded discs. Other compressed audio formats used for Internet audio downloads will not play on the DVD 50.
- Due to the differences in various versions of the MP3 format, and the many differences between the CD-R machines used to record MP3 discs on a computer, it is possible that some MP3 discs may not play on the DVD 50 even though they will work on a computer. This is normal and does not indicate a fault with the unit.
- When a multisession disc with both standard CD audio and MP3 content is in use, the DVD 50 will play only the CD audio sections of the disc.
- When an MP3 disc with multiple directories is playing, the DVD 50 will search out all MP3 files on the disc and list them in the on-screen display in the order in which the directories are structured on the disc. Note that if the same title is used for tracks in different directories, this may result in the same title appearing more than once in the track listings.

Programmed Playback with MP3 Discs

The DVD 50 is capable of creating playlists up to 60 tracks long with the MP3 files on a properly recorded disc. To create a playback list for MP3 titles, follow these steps:

Step 1: Load a compatible MP3 disc, but do not put it into play.

Step 2: Press the **Program Button** **19** to open a playlist, as indicated by the appearance of an E to the right of the word Program on the right side of the video screen. The **Program Indicator** **K** will also light in the **Information Display** **14**.

Step 3: Use the **Navigation Buttons** **5** to highlight the first track to be placed in the list and press the **Enter Button** **27**. Note that the track name will now appear on the right side of the screen.

Step 4: Repeat the step above until all desired tracks are added to the playlist.

Step 5: To remove a track from the playlist, first press the **Navigation Buttons** **5** so that the yellow highlight moves to the right side of the screen under the PROGRAM listing. Use the **Navigation Buttons** **5** to highlight the track to be deleted and press the **Clear Button** **20**.

Step 6: To clear all the tracks in the playlist and start over, press the **Navigation Buttons** **5** until the Clear All box at the bottom of the right side of the screen is highlighted and press the **Enter Button** **27**.

Step 7: To play the tracks on the list, press the **Play Button** **7/13**. The "E" indication will go out and a check mark will appear next to the track being played.

Once a playlist is created, it will remain available as long as the disc is not changed or the power turned off. You may play any track on the disc without erasing the playlist by pressing the **Navigation Buttons** **5** to return the highlight bar to the left side of the screen.

Repeat Playback with MP3 Discs

Repeat playback operation for MP3 discs differs somewhat from the steps used for repeat playback of standard DVD discs. The following repeat play options are available:

- To continually repeat the track currently being played, press the **Repeat Button** **15** once. Note that the **REPEAT 1 Indicator** **N** will light and an orange semicircle icon will appear to the right of the track name to indicate the track is programmed for repeat play. To cancel the repeat press the **Stop Button** **10/11** or change tracks using the **Next** **26** or **Previous** **6** buttons.
- To continually repeat an entire disc directory, press the **Repeat Button** **15** twice while any track on the disc is playing. Note that the **REPEAT ALL Indicator** **N** will light and an orange semicircle icon will appear to the right of the track name to indicate the all tracks one the disc or directory are programmed for repeat play. To cancel repeat play for an entire disc, press the **Stop Button** **10/11**, or press the **Repeat Button** **15** again.
- To continually repeat one track in a programmed playlist, press the **Repeat Button** **15** once while that track is playing. Note that the **REPEAT 1 Indicator** **N** will light and an orange semicircle icon will appear to the right of the track name under the Program List to indicate the track is programmed for Repeat Play. To cancel the Repeat, press the **Stop Button** **10/11** or change tracks using the **Next** **26** or **Previous** **6** buttons.

MP3 and VCD Playback

■ To continually repeat an entire programmed playlist, press the **Repeat Button** **15** twice while any track in the program list is playing. Note that an orange semicircle icon will appear to the right of the Program title in the on-screen display and the **REPEAT ALL Indicator** **N** will light to remind you that the programmed playlist is set for Repeat Play. To cancel Repeat Play for an entire disc, press the **Stop Button** **10/11**, or press the **Repeat Button** **15** again.

■ The Random Play and Repeat A-B functions are not available for MP3 discs.

VCD Playback

VCD is a format that predates DVD which is based on a different compression format than DVD and a recording method that is similar to CDs. Although the DVD has, for the most part, replaced VCD as a format, the DVD 50 offers VCD playback so that you may play your existing library of VCD discs.

There are two versions of the VCD format: an early version which is simply called "VCD" and a later version with Playback Control which is called "Version 2.0" or "PBC". The DVD 50 is compatible with both forms of VCD, although playback will vary according to which version is used and the specific way in which the disc was created.

Even though VCD discs provide video since the format is based on CD technology, the playback functions for a VCD disc operate very closely to those for CD. To play a VCD disc, place it in the DVD 50 as you would any other CD or DVD disc. After the unit takes a few seconds to read the disc's contents the VCD segment of the **Disc Type Indicators** **A** will light and the disc will begin playing. If the disc has been created under VCD Version 2.0, or if it otherwise allows Playback Control functionality, the letters PBC will appear in the **Title/Track Indicators** **C**. However, keep in mind that the exact level of functionality for any VCD will vary widely and it is ultimately determined by the way the disc was created, not by the DVD 50.

When playing VCD discs, most standard DVD/CD playback controls function as normal, including Play, Stop, Pause, Forward or Reverse Slow Play, and Fast Forward or Reverse Search (x2, 4x and 8x speeds). The indications for fast

play in either direction work as described for CD playback on page 32.

Using the On-Screen Status Bar for VCD Playback

When playing many VCD discs it is possible to access the disc's features using the on screen menu bar in the same manner as shown for CD playback on page 32. Note, however, that while the IntroScan icons will appear in the menu bar, the IntroScan feature is not available for VCD discs.

Use of other functions will vary according to the disc type. With some VCD discs you may select a track using the Track function on the menu bar. If the menu bar is not visible on the screen press the **Status Button** **3** to recall it to the screen. Note that when PBC appears under the disc icon in the far left position of the menu bar it is not possible to change track numbers directly.

Depending on the disc's functionality, some VCD discs allow the time display to be changed in the same manner as described for CD discs on page 32.

Playback Control

VCD discs made under the Revision 2.0 specification will usually offer PBC, or playback control. With PBC many discs include chapter selection menus that are similar to those found on DVDs. However, on VCD discs the menus are recalled and controlled differently than on DVD discs.

- To view the menu options on a PBC disc, press the **Next** **26** or **Previous** **6** buttons on the remote or the **Skip Forward/Reverse Buttons** **10** on the front panel.
- Once the menu options appear on the screen, make your selection by pressing the **Numeric Button** **14** that corresponds to your desired choice. The desired selection will begin playing automatically.

Note that the Menu Button used during DVD playback is not used for VCD playback.

Programmed Play

The DVD 50 is equipped with a wide range of programmed play functions that enable you to have the unit select or repeat tracks for you, or you may program a specific order for discs and tracks to play.

Random Play

The DVD 50's Random Play modes let you relax while the unit plays the tracks on one disc, or all the tracks on all discs in random order for hours of listening or viewing enjoyment. The three modes of Random Play are as follows:

- **Random 1 Disc:** Plays all the tracks on a single disc in random order and then stops.
- **Random All Discs:** Plays all the tracks on one disc in random order and then plays all the tracks on each succeeding disc in random order and then stops.
- **Shuffle All Discs:** Plays 2 tracks randomly from a disc and then plays 2 tracks randomly from a different disc until all tracks on all discs have been played.

To initiate Random Play, press the **Random Button** **12**. If the unit is stopped, the machine will begin playing; otherwise the Random Playback sequence will take place immediately. The first press of the Random button will initiate a "Random 1" playback, as indicated by the appearance of an on-screen banner message (Figure 21) and **Random** **Q** and **1 Indicators** **N**. To use one of the other Random Play modes, press the **Random Button** **12** again to step through each of the modes in the following order:

Random 1 → Random All Discs → Shuffle All Discs → Standard Play

To cancel a Random Play sequence, press the **Random Button** **12** until you see the Standard Play Banner (Figure 22) in the on-screen display and the **Random** **Q** or **Repeat/Random Indicators** **N** go out.



Figure 21



Figure 22

Repeat Play

The DVD 50 offers five repeat functions that allow you to take advantage of the five-disc capacity of the unit for unattended playback:

- **Repeat All Discs:** Plays all discs in the unit in order from beginning to end until playback is manually stopped.
- **Repeat 1 Disc:** Plays a specific disc from start to finish until playback is manually stopped.
- **Repeat Title:** For DVD discs only, this mode repeats the title currently being played until playback is manually stopped.
- **Repeat Track/Chapter:** Repeats the CD track or DVD chapter currently being played until playback is manually stopped.
- **Repeat A-B:** Repeats any selected portion of a disc until playback is manually stopped.

To select Repeat All, Repeat 1 Disc, Repeat Title or Repeat Track/Chapter, simply press the **Repeat Button** **15** until the banner display with the desired playback method appears on the screen. The selection process will follow this order:

- **For DVD Discs:** Repeat Chapter → Repeat Title → Repeat 1 Disc → Repeat All Discs → Repeat Off
- **For CD Discs:** Repeat Track → Repeat 1 Disc → Repeat All Discs → Repeat Off

In addition, when the video display is not available, the **Repeat Indicators** **N** will light in the **Information Display** **14** to show the options in use.

To stop any Repeat Play function, press the **Repeat Button** **15** until the Repeat Off Banner appears in the on-screen display or the **Repeat Indicators** **N** in the **Information Display** **14** go out.

Repeat Play may also be stopped by pressing the **Stop Button** **10/11** twice.

Repeat A-B

The Repeat A-B function allows you to select any portion of a DVD or CD and have it repeat continually until the unit is manually stopped.

To initiate a Repeat A-B playback sequence,

follow these steps while a disc is playing:

1. Press the **Repeat A-B Button** **16** at the start of the sequence to be repeated. Note that a Repeat A Banner (Figure 23) will appear on the video screen and the **Repeat A Indicator** **N** will light in the Information Display.



Figure 23

2. Press the **Repeat A-B Button** **16** again at the end of the sequence to be repeated. Note that the on-screen banner message will change to Repeat A-B (Figure 24), as will the **Repeat A-B Indicator** **N** in the Information Display.



Figure 24

3. The selected sequence will now play continually until the **Stop Button** **10/11** is pressed.

Programmed Play

Programmed Play

Programmed play allows you to select any track, title or chapter from any disc in the DVD 50 for playback in a specific order. This type of programming is particularly useful for parties or other situations where you want continual playback of specific selections for a long period of time. To program the discs in the DVD 50 for playback, follow these steps:

1. Press the **Program Button** 19 on the remote. Note that the Program Edit Screen (Figure 25) will appear on the video display.

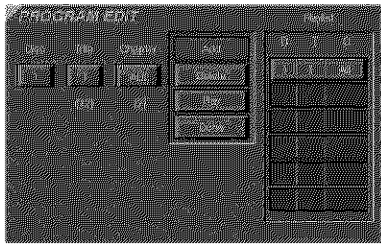

Figure 25

2. Select the disc position for the first playback selection by pressing the **▲/▼ Navigation Buttons** 5. When the desired disc number appears in the disc's box in white over a blue background, press the **Enter Button** 27 or **▶ Navigation Button** 5 to move to the next selection.

3. The second box will now be highlighted in blue to indicate that a selection for track or title is to be made. As the DVD 50 already knows the disc type for the position selected, the heading over the box will indicate "Track" for VCD or CD discs and "Title" for DVD Discs. The number in parentheses under the box shows the maximum number of tracks or titles on the disc. If "99" appears, it indicates that the disc selected has not yet been played and the unit does not yet know the type of disc and how many titles or tracks are available.

4. Press the **▲/▼ Navigation Buttons** 5 to scroll through the list of available tracks or titles. Press the **Enter Button** 27 or **▶ Navigation Button** 5 to move to the next selection.

Note that most DVD movie discs use "Title 1" for movies, while "Title 2" is used for the opening logo and piracy warnings. Before selecting a DVD title number, you may wish to preview the disc while the on-screen Menu Bar is active to see which title numbers refer to each portion of

the disc. This is particularly important in discs with large amounts of special feature material.

5. The third box will now be highlighted in blue to indicate that a selection for chapter should be made. This choice is available only for DVD discs, as CD discs do not have chapter capability. The number in parentheses under the box shows the maximum number of chapters on the disc. If "999" appears, it indicates that the disc selected has not yet been played and the unit does not yet know the type of disc and how many titles or tracks are available. If "0" appears, this is your indication that the disc is a VCD or CD.

6. Press the **▲/▼ Navigation Buttons** 5 to scroll through the list of available chapters. Press the **Enter Button** 27 or **▶ Navigation Button** 5 to move to the next selection area.

7. The blue highlighted box will now appear in a column where the options are "Add," "Delete," "Play" and "Done." Since this is the first selection to be entered, press the **Enter Button** 27 and note that the selected disc, track, title and chapter will be added to the Play List column over a beige highlighted area. The blue highlight will return to the disc box to allow you to enter additional selections by repeating Steps 2 through 7.

8. Repeat the steps as needed, noting that the selections will be added to the Play List up to a maximum of 22 steps.

■ To delete an entry from the Play List, press the **▶** and **▲/▼ Navigation Buttons** 5 until the selection to be deleted is highlighted in dark brown with white numbers on the Play List. Press the **Enter Button** 27 and then press the **▼ Navigation Button** 5 once, so that the word Delete is highlighted. Press the **Enter Button** 27 and the selection will be deleted. A selection may also be deleted by following this step to highlight it and then pressing the **Clear Button** 20.

■ To insert an entry into a Play List that has already been created, press the **▶** and **▲/▼ Navigation Buttons** 5 until the place on the Play List where you wish to insert a selection is highlighted in dark brown with white numbers. Press the **Enter Button** 27 and then press the **▼ Navigation Button** 5 once, so that the word

Insert is highlighted in blue, and then follow Steps 2 through 7. When you have entered the data for the selection, highlight the word "Insert" in blue and press Enter.

9. When you have completed the Play List, you may play the programmed selections by pressing the **▶** and **▲/▼ Navigation Buttons** 5 until the word **Play** is highlighted in blue. Press the **Enter Button** 27 to begin playback of the entire Play List. During Program Play the **Program Indicator** 14 will light.

10. To exit from the programming screen, press the **Return Button** 4.

Notes on Programmed Play

■ To stop the playback of a Programmed Play List, press the **Stop Button** 10 twice.

■ To cancel programmed Play Lists, press the **Clear Button** 20.

■ To edit the contents of a Play List using the **Information Display** 14 only, and not the on-screen display, follow these steps:

- Press the **Check Button** 18.

- Press the **Check Button** 18 again to step through each of the programmed items. The Program Sequence Number will appear on the far right side of the **Information Display** 14, next to the **PR** indication.

- Use the **◀/▶ Navigation Buttons** 5 to select the disc, track or chapter to be edited.

- Use the **▲/▼ Navigation Buttons** 5 to change the selection.

- Press the **Clear Button** 20 to remove a program step.

- When all steps have been programmed, press the **Play Button** 7 to begin programmed play, or the **Return Button** 4 to exit the programming function and return to normal operation.

Programmed Play

Bookmarks

Bookmarks are a feature of the DVD 50 that allows you to mark up to nine different points on a disc and to quickly return to those points later. The Bookmarks feature works on DVD, VCD and CD discs.

To Enter a Bookmark, Follow These Steps:

1. During disc playback, press the **Status Button** **3** if the Menu Bar is not already on the screen. You may also press the **Mark Button** **22** to call up the Bookmark Banner screen. In this case, proceed to Step 4.

2. Press the **Navigation Buttons** **5** until the disc icon with the word "Mark" below it is highlighted in white between yellow brackets.

3. Press the **Enter Button** **27** to view the Bookmark Banner (Figure 26).



Figure 26

4. At any point during playback where you wish to mark a spot so that you may return to it later, press the **Enter Button** **27**. Note that a check mark "✓" will appear in the box on both the "Go To" and "Mark" lines.

5. To enter additional Bookmark points, press the **Navigation Buttons** **5** until another empty box on the Mark line is highlighted in black. Press the **Enter Button** **27**.

6. Repeat Steps 4 and 5 for up to nine Bookmark points on a disc.

7. To exit the Bookmark Banner, press the **Navigation Buttons** **5** until the box at the right side of the banner is highlighted with a yellow outline and the arrow and "open door" icons change color. Press the **Enter Button** **27** to return to normal play. Press the **Clear Button** **20** to remove the Bookmark Menu Bar from the on-screen display.

The marked spots will remain in the DVD 50's memory as long as the disc is not changed. The Bookmark memory will remain active if the disc is stopped or the unit turned off, but it will be lost if the disc is removed from the player, or if the disc tray drawer is opened when the unit is the Stop mode.

To Recall a Bookmarked Scene or Passage, Follow These Steps:

Note that a check mark "✓" will appear in the box on both the "Go To" and "Mark" lines.

1. During disc playback, press the **Status Button** **3** if the Menu Bar is not already on the screen.

2. Press the **Navigation Buttons** **5** until the disc icon with the word "Mark" below it is highlighted in white between yellow brackets.

3. Press the **Enter Button** **27** to view the Bookmark Banner.

4. Press the **Navigation Buttons** **5** so that a box on the top "Go To" line of the banner is highlighted in black with a yellow outline.

5. Press the **Navigation Buttons** **5** so that the box below the number of the desired Bookmarked spot is highlighted.

6. Press the **Enter Button** **27** to go directly to the selected point on the disc.

7. To exit the Bookmark Banner, press the **Navigation Buttons** **5** until the box at the right side of the banner is highlighted with a yellow outline and the arrow and "open door" icons change color. Press the **Enter Button** **27** to return to normal play. Press the **Clear Button** **20** to remove the Bookmark Menu Bar from the on-screen display.

DVD Language Codes

The availability of specific languages for the main audio track or subtitles is dependent on the choices made by a disc's producer. You should always consult the disc's jacket for information on languages for any disc. In the case of some languages, you may be required to enter a code from the list below to access that language. See pages 19–20 for more information on entering language codes.

Language	Code	Language	Code	Language	Code
Abkhazian	6566	Hungarian	7285	Russian	8285
Afar	6565	Icelandic	7383	Samoan	8377
Afrikaans	6570	Indonesian	7378	Sangho	8371
Albanian	8381	Interlingua	7365	Sanskrit	8365
Ameharic	6577	Interlingue	7369	Scots Gaelic	7168
Arabic	6582	Iunpiak	7375	Serbian	8382
Armenian	7289	Irish	7165	Servo-Groatian	8372
Assamese	6583	Italian	7384	Sesotho	8384
Aymara	6588	Japanese	7465	Setswana	8478
Azerbaijani	6590	Javanese	7487	Shona	8378
Bashkir	6665	Kannada	7578	Sindhi	8368
Basque	6985	Kashmiri	7583	Singhalese	8373
Bengali; Bangla	6678	Kazakh	7575	Siswati	8383
Bhutani	6890	Kinyarwanda	8287	Slovak	8375
Bihari	6672	Kirghiz	7589	Slovenian	8376
Bislama	6673	Kirundi	8278	Somali	8379
Breton	6682	Korean	7579	Spanish	6983
Bulgarian	6671	Kurdish	7585	Sundanese	8385
Burmese	7789	Laothian	7679	Swahili	8387
Byelorussian	6669	Latin	7665	Swedish	8386
Cambodian	7577	Latvian, Lettish	7686	Tagalog	8476
Catalan	6765	Lingala	7678	Tajik	8471
Chinese	9072	Lithuanian	7684	Tamil	8465
Corsican	6779	Macedonian	7775	Tatar	8484
Croatian	7282	Malagsy	7771	Telugu	8469
Czech	6783	Malay	7783	Thai	8472
Danish	6865	Malayalam	7776	Tibetan	6679
Dutch	7876	Maltese	7784	Tigrinya	8473
English	6978	Maori	7773	Tonga	8479
Esperanto	6979	Marathi	7782	Tsonga	8483
Estonian	6984	Moldavian	7779	Turkish	8482
Faroese	7079	Mongolian	7778	Turkmen	8475
Fiji	7074	Naru	7865	Twi	8487
Finnish	7073	Nepali	7869	Ukrainian	8575
French	7082	Norwegian	7879	Urdu	8582
Frisian	7089	Occitan	7967	Uzbek	8590
Galician	7176	Oriya	7982	Vietnamese	8673
Georgian	7565	Oromo (Afan)	7977	Volapuk	8679
German	6869	Panjabi	8065	Welsh	6789
Greek	6976	Pashto, Pushto	8083	Wolof	8779
Greenlandic	7576	Persian	7065	Xhosa	8872
Guarani	7178	Polish	8076	Yiddish	7473
Gujarati	7185	Portuguese	8084	Yoruba	8979
Hausa	7265	Quechua	8185	Zulu	9085
Hebrew	7387	Rhaero-Romance	8277		
Hindi	7273	Romanian	8279		

Troubleshooting Guide

TROUBLESHOOTING GUIDE

SYMPTOM	POSSIBLE CAUSE	SOLUTION
Unit does not turn on	<ul style="list-style-type: none">• Main Power Switch turned Off• No AC power	<ul style="list-style-type: none">• Press in Main Power Switch• Check AC power plug and make certain any switched outlet is turned on
Disc does not play	<ul style="list-style-type: none">• Disc loaded improperly• Incorrect disc type• Invalid Region Code• Rating is above parental preset	<ul style="list-style-type: none">• Load disc label-side up• Check to see that disc is CD, CD-RW or DVD-Movie; other types will not play• Use Region 1 disc only• Enter password to override or change rating settings
No picture	<ul style="list-style-type: none">• Intermittent connections• Wrong input	<ul style="list-style-type: none">• Check all video connections• Check input selection of TV or receiver
No sound	<ul style="list-style-type: none">• Intermittent connections• Incorrect digital audio selection• DVD disc is in Fast or Slow mode	<ul style="list-style-type: none">• Check all audio connections• Check digital audio settings• There is no audio playback on DVD discs during Fast or Slow mode
Picture is distorted or jumps during Fast Forward or Reverse Play	<ul style="list-style-type: none">• MPEG-2 decoding	<ul style="list-style-type: none">• It is a normal artifact of DVD playback for pictures to jump or show some distortion during Rapid Play
Some remote buttons do not operate during DVD play	<ul style="list-style-type: none">• Function not available for this disc	<ul style="list-style-type: none">• Some discs do not include all DVD features
The menu is in a foreign language	<ul style="list-style-type: none">• Incorrect menu language	<ul style="list-style-type: none">• Change menu language selection
"⊗" Symbol appears	<ul style="list-style-type: none">• Requested function not available at this time	<ul style="list-style-type: none">• Certain functions may be disabled during passages of a disc
Picture is displayed in the wrong Aspect Ratio	<ul style="list-style-type: none">• Incorrect match of Aspect Ratio settings to disc	<ul style="list-style-type: none">• Change Aspect Ratio settings
Remote control inoperative	<ul style="list-style-type: none">• Weak batteries• Sensor is blocked	<ul style="list-style-type: none">• Change both batteries• Clear path to sensor or use remote sensor
Disc will not copy to VCR	<ul style="list-style-type: none">• Macrovision protection	<ul style="list-style-type: none">• Most DVDs are encoded with Macrovision to prevent copying to VCR

Technical Specifications

Applicable Discs:	5-inch (12cm) or 3-inch (8cm) DVD-Movie, CD, Video CD, MP3-CD, HDCD, CD-R or CD-RW discs Region 1 DVD-Movie discs DVD: Single/Single Layer, Single Side/Dual Layer, Dual Side/Dual Layer Linear PCM, Dolby Digital or DTS Audio
Video Signal System:	NTSC
Composite Video Output:	1Vp-p/75 Ohms, sync, negative polarity
S-Video:	Y/Luminance: 1Vp-p/75 Ohms, sync, negative polarity C/Chrominance: 0.286Vp-p
Component Video Output:	Y: 1Vp-p/75 Ohms, sync, negative polarity Pr: 0.7Vp-p/75 Ohms Pb: 0.7Vp-p/75 Ohms
Progressive Scan Output:	Y: 1Vp-p/75 Ohms, sync, negative polarity Pr: 0.7Vp-p/75 Ohms Pb: 0.7Vp-p/75 Ohms
Analog Audio Output:	HDCD: 2.0V RMS +/- 0.2V Others: 1.0Vp-p RMS +/- 0.2V
Coaxial Digital Audio Output:	0.5Vp-p/75 Ohms
Frequency Response:	4Hz – 22kHz +/- 0.5dB (48kHz sampling)
Dynamic Range:	DVD: 97dB (20-bit) CD: 97dB
Channel Separation:	106dB
THD:	DVD: 0.0035% CD: 0.0035%
Signal-to-Noise Ratio:	106dB
WOW & Flutter:	Below measurable limits
Headphone Output:	500mV RMS, 32 Ohms
AC Power:	100 – 240VAC 50/60Hz (Refer to back of the set.)
Power Consumption:	18 Watts
Dimensions (H x W x D):	5" x 17-1/2" x 16" (127mm x 440mm x 409mm)
Weight:	12.8 lbs/5.8kg

Depth measurement includes knobs and buttons.
Height measurement includes feet and chassis.
All specifications subject to change without notice.

Harman Kardon is a registered trademark, and Power for the Digital Revolution is a trademark, of Harman Kardon, Inc.

*Manufactured under license from Dolby Laboratories. "Dolby," "Pro Logic," "AC-3" and the Double-D symbol are trademarks of Dolby Laboratories. Confidential Unpublished Works. © 1992–2000 Dolby Laboratories, Inc. All rights reserved.

DTS and DTS Surround are trademarks of Digital Theater Systems, Inc.

This product incorporates copyright protection technology that is protected by method claims of certain U.S. patents and other intellectual property rights owned by Macrovision Corporation and other rights owners. Use of this copyright protection technology must be authorized by Macrovision Corporation and is intended for home and other limited viewing uses only, unless otherwise authorized by Macrovision Corporation. Reverse engineering or disassembly is prohibited.

HDCD, HDCD®, High Definition Compatible Digital® and Pacific Microsonics™ are either registered trademarks or trademarks of Pacific Microsonics, Inc., in the United States and/or other countries. HDCD system manufactured under license from Pacific Microsonics, Inc. This product is covered by one or more of the following: In the USA: 5,479,168; 5,638,074; 5,640,161; 5,808,574; 5,838,274; 5,854,600; 5,864,311; 5,872,531; and in Australia: 669114. Other patents pending.

harman/kardon®

H A Harman International Company

250 Crossways Park Drive, Woodbury, New York 11797

www.harmankardon.com

© 2001 Harman Kardon, Incorporated

Part #3835RS0016K