

# DVD-C920

DVD AUDIO/VIDEO CHANGER

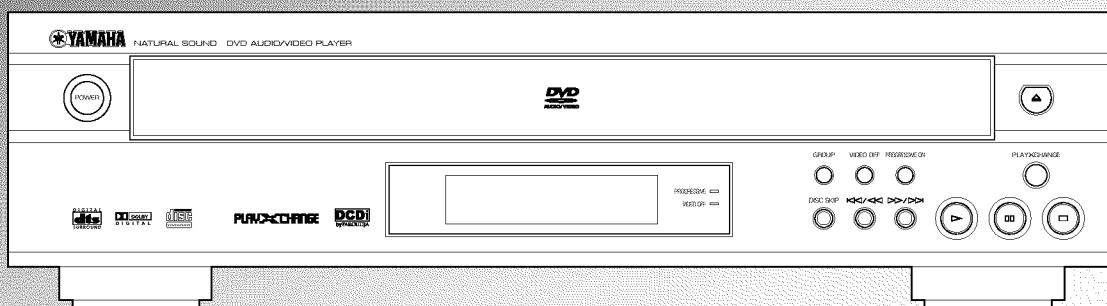

OWNER'S MANUAL

# IMPORTANT SAFETY INSTRUCTIONS

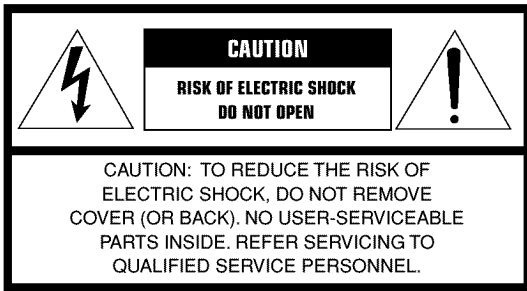

## • Explanation of Graphical Symbols



The lightning flash with arrowhead symbol, within an equilateral triangle, is intended to alert you to the presence of uninsulated “dangerous voltage” within the product’s enclosure that may be of sufficient magnitude to constitute a risk of electric shock to persons.



The exclamation point within an equilateral triangle is intended to alert you to the presence of important operating and maintenance (servicing) instructions in the literature accompanying the appliance.

### **WARNING**

TO REDUCE THE RISK OF FIRE OR ELECTRIC SHOCK, DO NOT EXPOSE THIS UNIT TO RAIN OR MOISTURE.

### **IMPORTANT**

Please record the serial number of this unit in the space below.

#### **MODEL:**

Serial No.:

The serial number is located on the rear of the unit. Retain this Owner’s Manual in a safe place for future reference.

### **WARNING**

TO REDUCE THE RISK OF FIRE OR ELECTRIC SHOCK, DO NOT EXPOSE THIS UNIT TO RAIN OR MOISTURE.

- 1 Read these instructions.
- 2 Keep these instructions.
- 3 Heed all warnings.
- 4 Follow all instructions.
- 5 Do not use this apparatus near water.
- 6 Clean only with dry cloth.
- 7 Do not block any ventilation openings. Install in accordance with the manufacturer’s instructions.
- 8 Do not install near any heat sources such as radiators, heat registers, stoves, or other apparatus (including amplifiers) that produce heat.
- 9 Do not defeat the safety purpose of the polarized or grounding-type plug. A polarized plug has two blades with one wider than the other. A grounding type plug has two blades and a third grounding prong. The wide blade or the third prong are provided for your safety. If the provided plug does not fit into your outlet, consult an electrician for replacement of the obsolete outlet.
- 10 Protect the power cord from being walked on or pinched particularly at plugs, convenience receptacles, and the point where they exit from the apparatus.
- 11 Only use attachments/accessories specified by the manufacturer.
- 12 Use only with the cart, stand, tripod, bracket, or table specified by the manufacturer, or sold with the apparatus. When a cart is used, use caution when moving the cart/apparatus combination to avoid injury from tip-over. 
- 13 Unplug this apparatus during lightning storms or when unused for long periods of time.
- 14 Refer all servicing to qualified service personnel. Servicing is required when the apparatus has been damaged in any way, such as power-supply cord or plug is damaged, liquid has been spilled or objects have fallen into the apparatus, the apparatus has been exposed to rain or moisture, does not operate normally, or has been dropped.

## FCC INFORMATION (for US customers only)

- IMPORTANT NOTICE : DO NOT MODIFY THIS UNIT!**  
This product, when installed as indicated in the instructions contained in this manual, meets FCC requirements. Modifications not expressly approved by Yamaha may void your authority, granted by the FCC, to use the product.
- IMPORTANT :** When connecting this product to accessories and/or another product use only high quality shielded cables. Cable/s supplied with this product **MUST** be used. Follow all installation instructions. Failure to follow instructions could void your FCC authorization to use this product in the USA.
- NOTE :** This product has been tested and found to comply with the requirements listed in FCC Regulations, Part 15 for Class "B" digital devices. Compliance with these requirements provides a reasonable level of assurance that your use of this product in a residential environment will not result in harmful interference with other electronic devices.

This equipment generates/uses radio frequencies and, if not installed and used according to the instructions found in the users manual, may cause interference harmful to the operation of other electronic devices.

Compliance with FCC regulations does not guarantee that interference will not occur in all installations. If this product is found to be the source of interference, which can be determined by turning the unit "OFF" and "ON", please try to eliminate the problem by using one of the following measures:

Relocate either this product or the device that is being affected by the interference.

Utilize power outlets that are on different branch (circuit breaker or fuse) circuits or install AC line filter/s.

In the case of radio or TV interference, relocate/reorient the antenna. If the antenna lead-in is 300 ohm ribbon lead, change the lead-in to coaxial type cable.

If these corrective measures do not produce satisfactory results, please contact the local retailer authorized to distribute this type of product. If you can not locate the appropriate retailer, please contact Yamaha Electronics Corp., U.S.A. 6660 Orangethorpe Ave, Buena Park, CA 90620.

The above statements apply **ONLY** to those products distributed by Yamaha Corporation of America or its subsidiaries.

## We Want You Listening For A Lifetime

YAMAHA and the Electronic Industries Association's Consumer Electronics Group want you to get the most out of your equipment by playing it at a safe level. One that lets the sound come through loud and clear without annoying blaring or distortion – and, most importantly, without affecting your sensitive hearing.

Since hearing damage from loud sounds is often undetectable until it is too late, YAMAHA and the Electronic Industries Association's Consumer Electronics Group recommend you to avoid prolonged exposure from excessive volume levels.

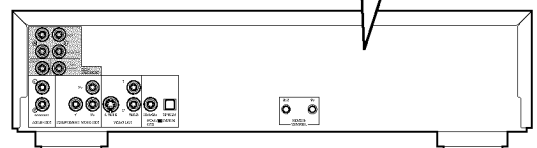
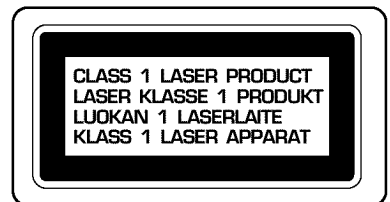
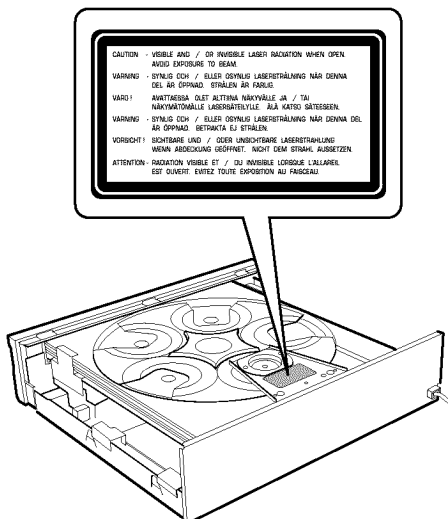

(Australia model)

# CAUTION: READ THIS BEFORE OPERATING YOUR UNIT.

- 1 To assure the finest performance, please read this manual carefully. Keep it in a safe place for future reference.
- 2 Install this unit in a well ventilated, cool, dry, and clean place with at least 5 cm above, behind and on the both sides of this unit - away from direct sunlight, heat sources, vibration, dust, moisture, and/or cold.
- 3 Position this unit away from other electrical appliances, motors and transformers to avoid humming sounds, do not place this unit where it may get exposed to rain or any kind of liquid to prevent fire or electrical shock.
- 4 Avoid extreme temperature swings or excessive use of humidifier in the room where this unit is installed to prevent condensation inside this unit, which may cause an electrical shock, fire damage to this unit, and/or personal injury.
- 5 Do not cover this unit with a newspaper, a tablecloth, a curtain, etc. in order not to obstruct heat radiation. If the temperature inside this unit rises, it may cause fire, damage to this unit and/or personal injury.
- 6 Avoid installing this unit in a place where foreign objects and liquid might fall. It might cause a fire, damage to this unit and/or personal injury. Do not place the following objects on this unit:
  - Other components, as they may cause damage and/or discoloration on the surface of this unit.
  - Burning objects (i.e., candles), as they may cause fire, damage to this unit and/or personal injury.
  - Containers with liquid in them, as they may cause an electrical shock to the user and/or damage to this unit.
- 7 Do not operate this unit upside-down. It may overheat, possibly causing damage.
- 8 Do not use force on switches, controls or connection cables. Never pull the cables when disconnecting them.
- 9 Only voltage specified on this unit must be used. Using this unit with a higher voltage than specified is dangerous and may result in fire or other accidents. YAMAHA will not be held responsible for any damage resulting from the use of this unit with a voltage other than that specified.
- 10 Do not attempt to clean this unit with chemical solvents; this might damage the finish. Use a clean, dry cloth.
- 11 Disconnect the power cord from the wall outlet when not planning to use this unit for a long period of time, or during an electrical storm, as they may cause damage by lightning.
- 12 Do not attempt to modify or fix this unit. Contact the qualified YAMAHA service personnel when any service is needed. Cabinet should never be opened for any reasons.
- 13 Be sure to read 'TROUBLESHOOTING' section regarding common operating errors before concluding that this unit is faulty.

## CAUTION

Use of controls or adjustments or performance of procedures other than those specified herein may result in hazardous radiation exposure.

## DANGER

Visible laser radiation when open. Avoid direct exposure to beam.

When this unit is plugged to the wall outlet, do not place your eyes close to the opening of the disc tray and other openings to look into inside.

Laser component in this product is capable of emitting radiation exceeding the limit for Class 1.

---

This unit is designed for home use only. Do not use this unit for business purposes.

**Be sure to place this unit on a level surface.** If not so, this unit will fail to work normally at the PLAYXCHANGE operation and cause damage to the disc(s) and this unit itself.

### Caution for moving this unit

- When moving this unit, first remove all discs from the disc table and close the table by pressing the **OPEN/CLOSE** button, and then switch off the power after you confirm that the front panel display indicates as follows.

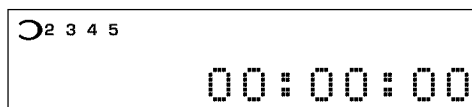

Never switch off the power if the front panel display is not pictured as above, otherwise the unit will break down during moving because the internal mechanism is not locked.

- When moving this unit, be sure to first disconnect the power cord from the AC outlet and disconnect all cords connecting this unit to other equipment.

---

### FOR CANADIAN CUSTOMERS

To prevent electric shock, match wide blade of plug to wide slot and fully insert.  
This Class B digital apparatus complies with Canadian ICES-003.

# FEATURES

- 5-Disc Auto-changer for playing DVD-Audio, DVD-Video, audio CD and Video CD
- CD-R and CD-RW play compatibility
- MP3 format supported
- PLAYXCHANGE; Disc changing capability while playing another
- 1 OPTICAL and 1 COAXIAL digital outputs for Dolby Digital, DTS, MPEG and PCM
- 96 kHz, 24 bit audio DAC for high sound quality
- Dolby Digital and DTS decoders
- Compatible with almost all features of DVD discs (Multi-angle, Multi-language, Parental control, etc.)
- Easy operation through on-screen menu
- Multi-speed playback capability
- Progressive video output capability (U.S.A. and Canada models)
- Component Video and S-Video outputs for high picture quality

# CONTENTS

## INTRODUCTION

<b>FEATURES .....</b>	<b>1</b>
<b>GETTING STARTED .....</b>	<b>2</b>
Checking the package contents .....	2
Disc information .....	2
<b>CONTROL REFERENCE GUIDE .....</b>	<b>4</b>
Front panel/remote control .....	4
Display .....	6

## PREPARATION

<b>REMOTE CONTROL .....</b>	<b>7</b>
Installing batteries in the remote control .....	7
Using the remote control .....	7
<b>CONNECTIONS .....</b>	<b>8</b>
Audio connections .....	8
Video connections .....	9
Remote control in/out terminals .....	10
Power supply cord .....	10

## PLAYBACK

<b>BASIC OPERATION .....</b>	<b>11</b>
Before starting play .....	11
Playing a disc .....	11
Multi-speed play .....	13
Using a disc's menu .....	14
Enhancing video quality .....	14
DVD-Audio features .....	15
Enhancing audio quality .....	15
Switching audio tracks, subtitles and angles .....	16
<b>SPECIFYING THE PLAY SEQUENCE ...</b>	<b>17</b>
Repeat play .....	17
Repeat A-B .....	18
Random play .....	18
Programmed play .....	19
Bookmarks .....	20

<b>ON-SCREEN MENU .....</b>	<b>21</b>
Operating menu bar .....	21
Icons for disc menu .....	22
Shuttle screen .....	22
Icons for player menu .....	23

## SETUP MENU

<b>SETUP MENU .....</b>	<b>25</b>
Operating the setup menu .....	25
Summary of settings .....	26
Language selection and language code list .....	27
Ratings .....	28
PCM down conversion .....	28
Speaker settings .....	28

## APPENDIX

<b>TROUBLESHOOTING .....</b>	<b>30</b>
<b>SPECIFICATIONS .....</b>	<b>Back cover</b>

### Note

- The illustrations of the player and the remote control used in this manual show U.S.A. and Canada model. Australia model is not equipped with the 'progressive' feature, and the related controls and printings on the illustrations are not applicable.

# GETTING STARTED

## Checking the package contents

Check that the following items are included in your package.

### Remote control

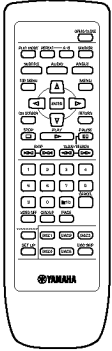

(U.S.A. and Canada models)

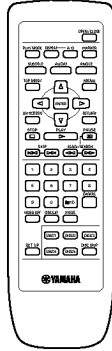

(Australia model)

Batteries (AA, R06, UM-3)

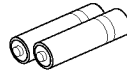

RCA pin cable (audio/video)

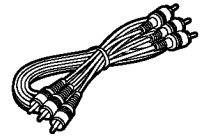

## Disc information

This DVD changer is designed for use with following types of disc only. Never attempt to load any other type of disc into this unit because it may damage this unit.



In this manual, the type of discs are indicated as below.

DVD-Video	DVD-Audio	Video CD	Audio CD
<b>DVD-V</b>	<b>DVD-A</b>	<b>VCD</b>	<b>CD</b>

### Notes

- This unit is not compatible with Photo-CD, CD-ROM, DVD-ROM, DVD-RAM, SVCD, CDV, etc. (some DVD-R, DVD-RW and DVD+RW can be played).
- Be sure to use only CD-R and CD-RW discs made by reliable manufacturers. Some discs cannot be played depending on the disc characteristics or recording conditions.
- Do not use any non standard shaped discs (heart, etc.).
- Do not use disc with tape, seals, or paste on it, damage to the unit may result.
- Some DVD and VCD features described in this manual may not be available or may operate in a different way because they are subject to software producer's design. Check each disc's instruction.

### Example:

⏮ appears when you press the skip buttons to move to the next section.



Manufactured under license from Dolby Laboratories. "Dolby" and the double-D symbol are trademarks of Dolby Laboratories.



Manufactured under license from Digital Theater Systems, Inc. US Pat. No.5,451,942, 5,956,674, 5,974,380, 5,978,762 and other world-wide patents issued and pending. "DTS" and "DTS Digital Surround" are registered trademarks of Digital Theater Systems, Inc. Copyright 1996,2000 Digital Theater Systems, Inc. All Rights Reserved.









"DCDi" is a trademark of Faroudia, a division of Sage Inc.

This product incorporates copyright protection technology that is protected by method claims of certain U.S. patents and other intellectual property rights owned by Macrovision Corporation and other rights owners. Use of this copyright protection technology must be authorized by Macrovision Corporation, and is intended for home and other limited viewing uses only unless otherwise authorized by Macrovision Corporation. Reverse engineering or disassembly is prohibited.

## ■ Region management information **DVD-V**

This DVD player is designed to meet DVD standard that supports region management system. Check the regional code number marked on the disc packages. If the number does not match this unit's region number (see the below table or the back of this unit), this unit refuses to play that disc.

Model	Region number of this unit	Discs can be played
U.S.A. and Canada models		 ,  or a mark which includes the region number '1'.
Australia model		 ,  or a mark which includes the region number '4'.

## ■ Notes about handling discs

- Hold discs by touching only the edges or center hole.

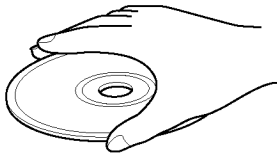

- When a disc is not currently being loaded on the disc tray, store it in an appropriate case.
- Playback of discs is generally not affected by small particles of dust or fingerprints on their playing surface. Even so, they should be kept clean. Wipe by using a clean, dry cloth. Do not wipe with a circular motion; wipe straight outward from the center.

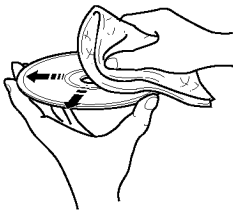

- Do not try to clean the disc's surface by using any type of disc cleaner, record spray, anti-static spray or liquid, or any other chemical-based liquid, because such substances might irreparably damage the disc's surface.
- Do not expose discs to direct sunlight, high temperature or high humidity for a long period of time, because these might warp or otherwise damage the disc.

# No!

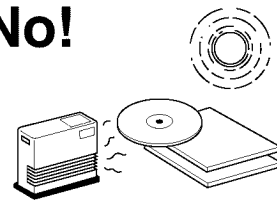

## ■ MP3 playback

This unit can play MP3 format audio recorded for personal use with a computer etc. onto CD-R or CD-RW. Play may not be possible in some cases due to the condition of the recording.

Discs recorded using MP3 differ to CDs in the following ways.

- Structure of the disc (example)

Since the MP3 format can store several albums on a disc, an album is assigned to a 'Title', and a track is assigned to a 'Chapter'.

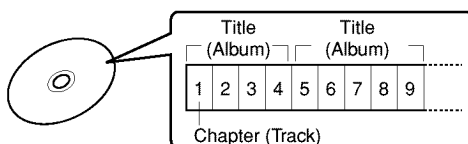

- Repeat play  
You can use chapter repeat or title repeat.
- Programmed play, random play  
You cannot use programmed play and random play.
- On-screen icons for disc information during play

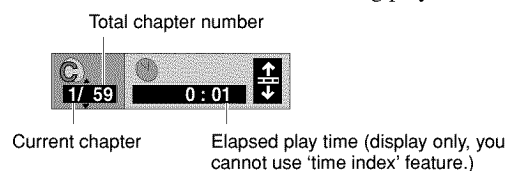

- Starting play from a selected chapter  
Select a chapter using the numeric buttons (see 'To select a specific track' in p.13) and press ENTER.

# CONTROL REFERENCE GUIDE

## Front panel/remote control

### Front Panel

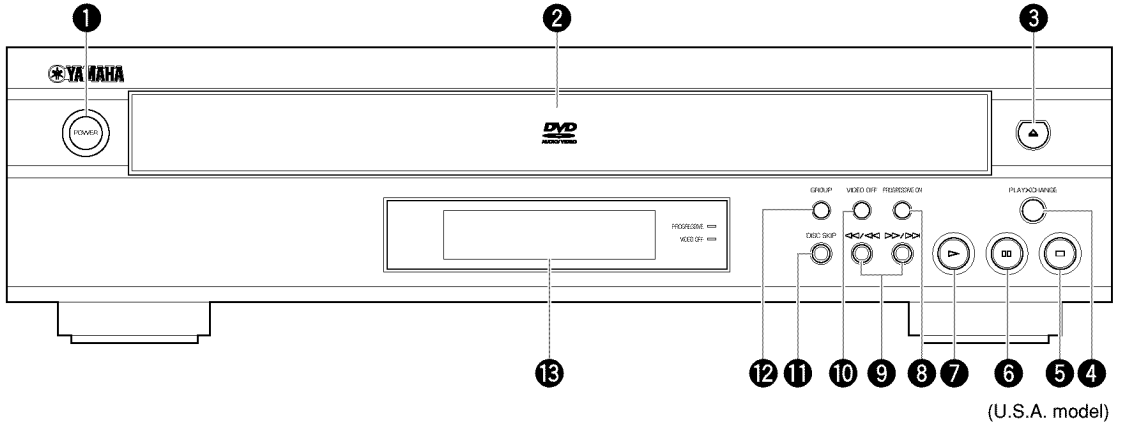

(U.S.A. model)

### Remote Control

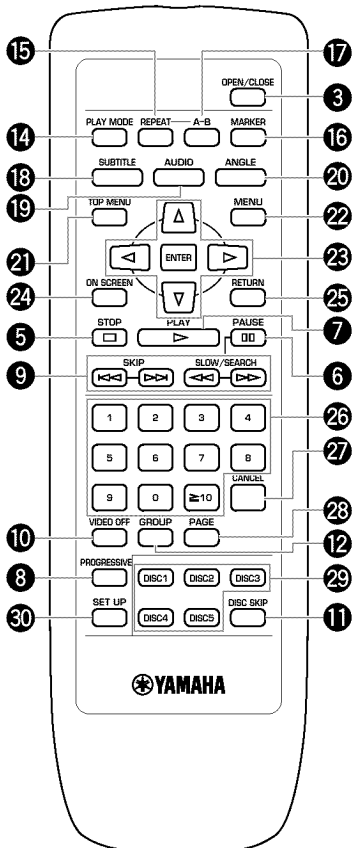

(U.S.A. model)

#### 1 POWER

Press to turn the power on and off.

#### 2 Disc tray

Up to 5 discs can be loaded on this tray.

#### 3 △ (OPEN/CLOSE)

Press to open and close the disc tray.

#### 4 PLAYXCHANGE (p.12)

#### 5 □ (STOP)

Press to stop playback.

#### 6 ■■ (PAUSE)

Press to pause.

#### 7 ▷ (PLAY)

Press to start playback.

#### 8 PROGRESSIVE ON: front panel

PROGRESSIVE: remote control

[U.S.A. and Canada models only] ...**(p.14)**

#### 9 <<</>>>, >>>/<<<

**(SKIP, SLOW/SEARCH):** front panel

<<<, >>> **(SKIP),**

<<<, >>> **(SLOW/SEARCH):** remote control

...**(p.13)**

#### 10 VIDEO OFF (p.15)

#### 11 DISC SKIP

Press to select another disc.



**12 GROUP (p.15)****13 Display panel****14 PLAY MODE**

Press to switch among random play, program play, and normal play.

**15 REPEAT (p.17)****16 MARKER (p.20)****17 A-B (p.18)****18 SUBTITLE (p.16)****19 AUDIO (p.16)****20 ANGLE (p.16)****21 TOP MENU**

Press to go to the initial screen when operating in the menu screen.

**22 MENU (p.14)**

Press to call up menu screen contained in the disc.

**23 Cursor buttons, ENTER**

Use to select and determine an item on menu screen, etc.

**24 ON SCREEN (p.21)**

Press to turn the on-screen icons on and off on the video monitor.

**25 RETURN (p.14, 21, 25)**

Press to go back to the previous screen when operating in the menu screen.

**26 Numeric buttons**

Use to select a title, chapter, track, etc.

**27 CANCEL**

Press to cancel a specific mode or a setting.

**28 PAGE (p.15)****29 DISC 1, 2, 3, 4, 5**

Press to play the disc loaded on the guide of the corresponding number.

**30 SET UP (p.25)**

Press to call up the setup menu screen.

## Display

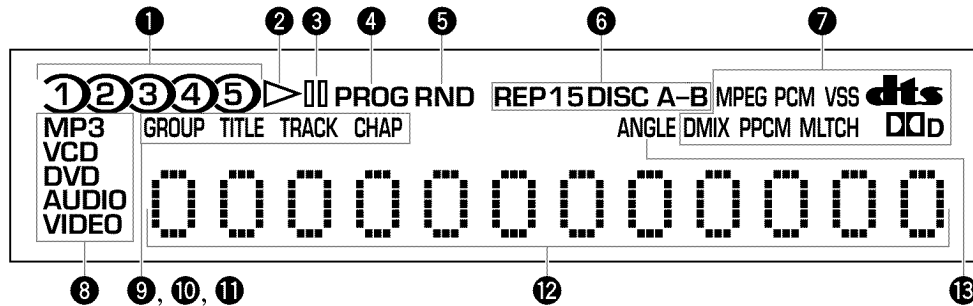

### 1 1 2 3 4 5

One of these numbers lights up to show the currently selected disc, which is loaded on the guide of the corresponding number.

### 2 ▷

Lights up during playback.

### 3 □□

Lights up while playback is paused.

### 4 PROG

Lights up during program play.

### 5 RND

Lights up during random-sequence play.

### 6 Repeat mode indicators

- REP and A-B light up when repeating between the two points you have specified.
- REP and 1 DISC light up when repeating the currently selected disc.
- REP and 5 DISC light up when repeating all the discs loaded on the disc tray.

### 7 Audio type indicators

dts, DD D (=dolby digital), MPEG, PCM (=linear PCM), PPCM (=packed PCM):

Indicates the audio format of a disc. When a disc contains several different formats, the currently selected format lights up.

MLTCH: Lights up when a multi-channel audio track is playing.

DMIX: Lights up to show that the currently playing multi-channel audio track can be mixed down into 2 channels – does not mean that the track is actually down-mixed. With some DVD-Audio discs, 2 channels down-mix is prohibited and the indicator does not light up while playing the disc.

VSS: Lights up when the virtual surround feature is turned on.

### 8 Disc type indicators

Indicates the type of disc. For example, DVD and AUDIO lights up when playing a DVD-Audio disc.

### 9 GROUP DVD-A

The current (or programmed) group number appears below the indicator.

### 10 TITLE, CHAP DVD-V

The current (or programmed) title number and chapter number appears below each indicator. TITLE (or CHAP) also lights up with REP indicator when repeating a title (or a chapter).

### 11 TRACK DVD-A VCD CD

The current (or programmed) track number appears below the indicator. It also lights up with REP indicator when repeating a track.

### 12 Multi-information display

Shows various information such as title, chapter or track number, elapsed playing time etc.

### 13 ANGLE

Lights up when the scene currently played contains different angle(s).

# REMOTE CONTROL

## Installing batteries in the remote control

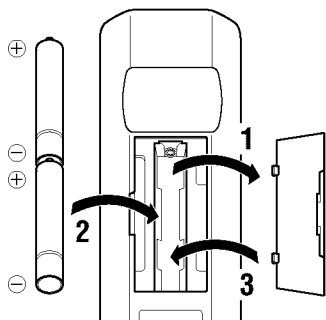

- 1** Turn the remote control over and slide the battery compartment cover in the direction of the arrow.
- 2** Insert the batteries (AA, R06, UM-3 type) according to the polarity markings on the inside of the battery compartment.
- 3** Close the battery compartment cover.

If the remote control operates only when it is close to the unit, the batteries are weak. Replace all the batteries with new ones.

### Notes

- Use only AA, R06 or UM-3 batteries for replacement.
- Be sure the battery polarity is correct. (See the illustration inside the battery compartment.)
- Remove the batteries if the remote control will not be used for an extended period of time.
- If the batteries have leaked, dispose of them immediately. Avoid touching the leaked material or letting it come into contact with clothing, etc. Clean the battery compartment thoroughly before installing new batteries.

## Using the remote control

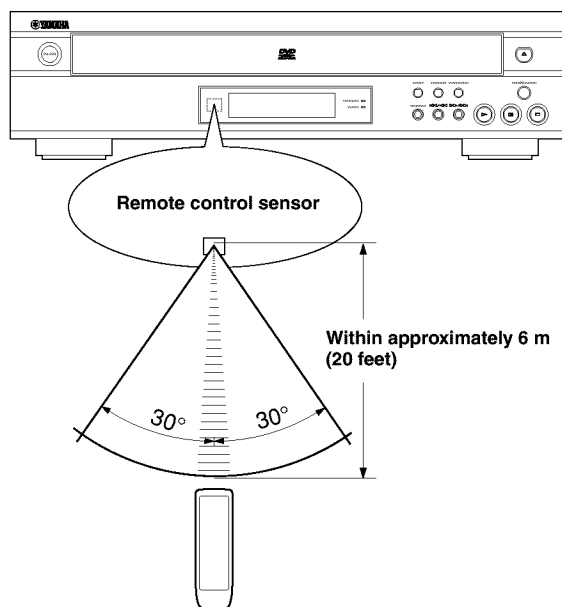

The remote control transmits a directional infrared beam. Be sure to aim the remote control directly at the infrared sensor during operation. When the sensor is covered or there is a large object between the remote control and the sensor, the sensor cannot receive signals. The sensor may not be able to receive signals properly when it is exposed to direct sunlight or a strong artificial light (such as a fluorescent or strobe light). In this case, change the direction of the light or reposition the unit to avoid direct lighting.

### Notes

- Handle the remote control with care.
- Do not spill water, tea or other liquids on the remote control.
- Do not drop the remote control.
- Do not leave or store the remote control in the following conditions:
  - high humidity or temperature such as near a heater, stove or bath;
  - dusty places; or
  - extremely low temperature.

# CONNECTIONS

## CAUTION

- Never connect this unit and other equipment to power supply until all connections have been completed.

Be sure all connections are made correctly, observing the color-coding of terminals of both this unit and the equipment to be connected. Also refer to the instructions of the equipment to be connected.

## Audio connections

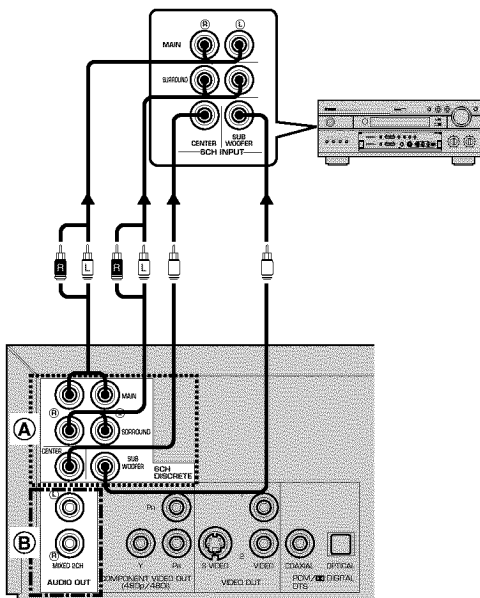
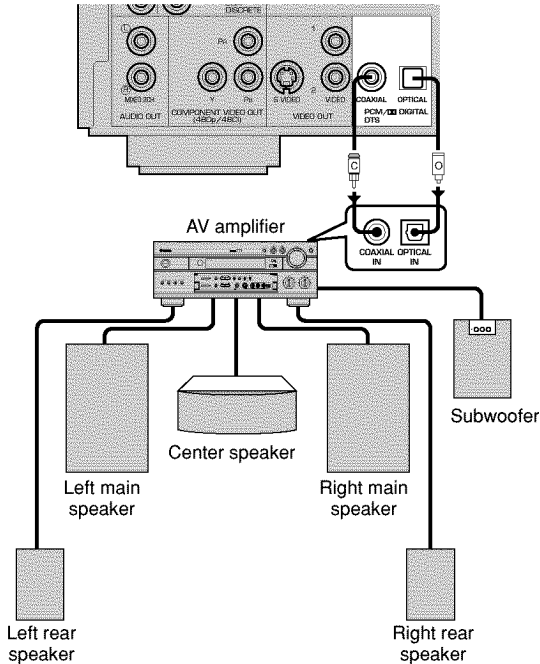

### Digital outputs

This unit has COAXIAL and OPTICAL digital output terminals. Connect one of them to your AV amplifier equipped with Dolby digital, DTS, or MPEG decoder using each specific cable (separate purchase).

#### Required Audio settings (See p.25, 26 and 27):

- Digital Audio Output → On
- PCM Down Conversion, Dolby Digital, DTS Digital Surround, MPEG → Verify your AV amplifier's capability.

#### Notes on digital recording

You can record the source from this unit through your AV center (AV amplifier, etc.) or connecting these terminals directly to your CD recorder, etc.

- With CD, wait for the total play time to appear before turning on your recording unit's synchro recording feature. The beginning may be cut off if you turn it while 'READING' is displayed.
- With DVDs, recording may be interrupted when a new chapter begins. If it persists, use analog recording by making analog connections. These phenomena occur because DVD player must first determine the audio format and sampling frequency before switching digital output.

### Analog outputs

#### Ⓐ 6CH DISCRETE terminals

This unit incorporates multi-channel decoder and can be connected to your AV amplifier as an external decoder. With this connection, you can enjoy a 96 kHz or more sampling frequency multi-channel audio track on a DVD-Audio disc, etc. even if the disc is copyright-protected. However, your AV amplifier's digital sound processing features have no effect on the audio signals output from these terminals.

#### Required Audio settings (See p.25, 26 and 29):

- Speaker settings → Multi-channel\*
- Digital Audio Output → Off
- \* Also make output mode, delay time and speaker balance adjustments.

#### Ⓑ AUDIO OUT (MIXED 2CH) terminals

You can connect this unit to any component that has analog 2 channel input terminals using the RCA audio cable supplied with this unit.

# Video connections

(U.S.A. model)

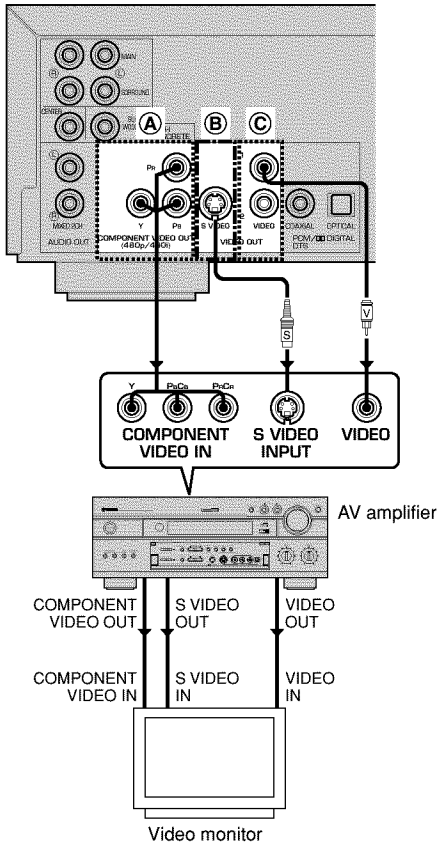

If your AV amplifier has video terminals, connect your amplifier (and then to your video monitor) so that you can use one video monitor for several different video sources (LD, VCR etc.) by simply switching the input source selector of your amplifier.

This unit has three types of video output terminals. Use one of them in accordance with the input terminals of the equipment to be connected.

**Note**

- Do not connect this unit to a video monitor through a video cassette recorder. If you do so, the picture may not be played back properly due to the copyright protection technology incorporated in this unit.

**A Component Video terminal**

Component video connection achieves high fidelity in reproducing colors (better performance than S-video connection), separating video signal into luminance (Y, terminal color-coded as green), and color difference (Pb, blue/Pr, red). Use commercially available coaxial cables. Amplifier (and Video monitor) with component input is required. Observe the color of each terminal when connecting. If your amplifier does not have component output terminals, connecting this unit's component output directly to your video monitor's component input can reproduce better video image.

**Note**

- Do not connect this unit's COMPONENT VIDEO OUT terminals to component video input terminals special for HD (High-Definition) TV.

**B S-Video terminal**

S (separate) video connection achieves a clearer picture than composite video connection by separating color and luminance when transmitting signals. Use commercially available S-video cable. Amplifier (and Video monitor) with S-video input is required.

**C Composite Video terminal (1, 2)**

**Use RCA video cable supplied with this unit when connecting this unit to a video monitor.**

VIDEO 1, 2 terminals of VIDEO OUT output the same signal. You can connect one to your amplifier's input using supplied RCA cable, and the other to another amplifier or a video monitor.

PREPARATION

English





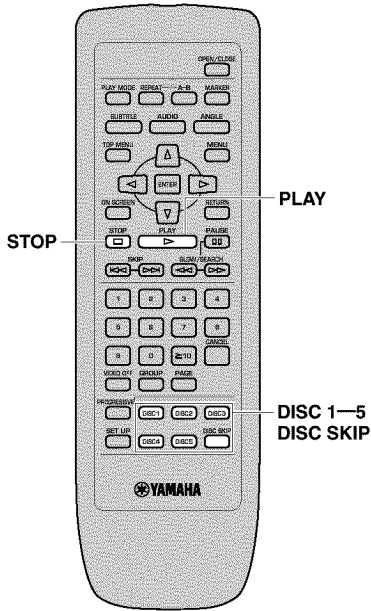
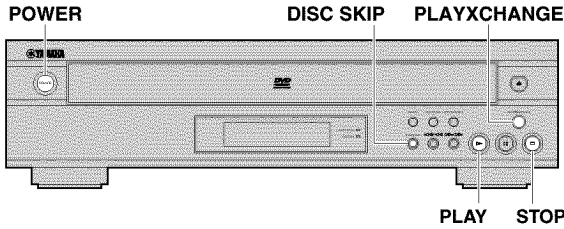

## ■ To stop playback

Press □ (STOP).

### Resume function

This unit memorizes where □ (STOP) was pressed as long as this unit is turned on (▶ indicator flashes on the display). When you press ▷ (PLAY) in this status, playback resumes from where it was stopped.

To clear the memory, press □ (STOP) once more so that the ▶ indicator goes off.

### Notes

- Selecting another disc cancels the resume function.
- This function may not work with some discs or on some part of a disc.

### Chapter review function [DVD-V]

This function plays the first few seconds of each chapter from the beginning of the title up to the memorized point so that you can review previous chapters.

Press ▷ (PLAY) while the message for chapter review is displayed on the screen.

### Notes

- This function may not work with some DVDs.
- Canceling resume function will also clear the chapter review function.

## ■ To select a specific disc

Press DISC 1, 2, 3, 4 or 5.



- You can select another disc by pressing DISC SKIP.

### Playxchange

By pressing PLAYXCHANGE, you can open the disc tray and load or replace discs without interrupting play.

**However, never load a disc on the guide half hidden inside the unit because the disc currently being played is to be placed there.**

## ■ After operation

When this unit is not in use, remove discs and press POWER.



## Multi-speed play

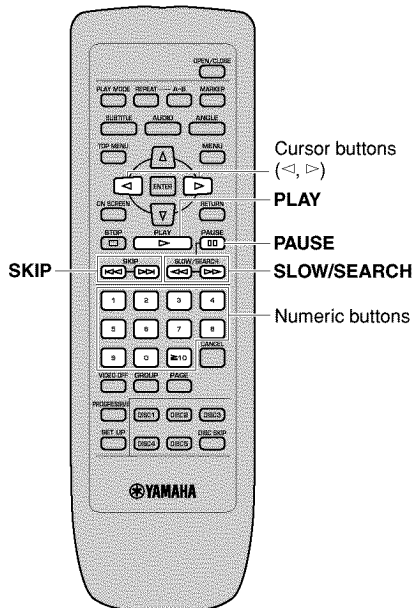
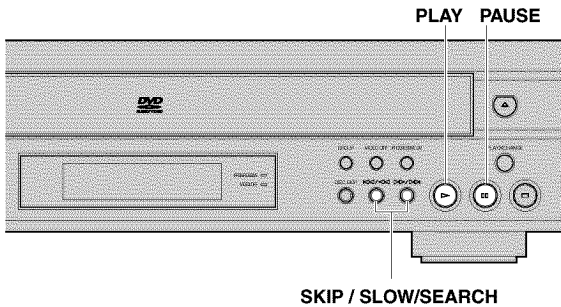

### ■ Skip

Press SKIP  $\gg$  (or  $\ll$ ) on the remote control to skip forward (or backward).

or

Press  $\gg/\gg$  (or  $\ll/\ll$ ) on the front panel to skip forward (or backward).

Press once for each chapter (track) to be skipped.

#### Note

- When playing a VCD with playback control, skip operation may not function as described above.

### ■ To select a specific track **VCD** **CD**

Enter a desired track number using numeric buttons.

To select a two-digit number, press  $\geq 10$  and then enter the upper figure and the last figure successively.

Example (to select track 17):

- 1 Press  $\geq 10$ .
- 2 Press 1.
- 3 Press 7.

### ■ Search

Press SLOW/SEARCH  $\gg$  (or  $\ll$ ) on the remote control to search forward (or backward).

or

Press and hold  $\gg/\gg$  (or  $\ll/\ll$ ) on the front panel to search forward (or backward).



- To increase the speed, press SLOW/SEARCH on the remote control repeatedly or keep pressing  $\gg/\gg$ ,  $\ll/\ll$  on the front panel.

### ■ Pause

Press  $\square$  (PAUSE).

- To resume play, press  $\triangleright$  (PLAY).

### ■ Frame advance/reverse

**DVD-A** **DVD-V** **VCD**

- 1 Press  $\square$  (PAUSE) during playback.
- 2 Press the cursor buttons (<, >).

Each press advances (or reverses) still picture by one frame.

- To return to normal play, press  $\triangleright$  (PLAY).

#### Note

- With Video CD, you cannot move backward.

### ■ Slow **DVD-A** **DVD-V** **VCD**

- 1 Press  $\square$  (PAUSE) during playback.
- 2 Press SLOW/SEARCH  $\gg$  (or  $\ll$ ) on the remote control.

or

Press and hold  $\gg/\gg$  (or  $\ll/\ll$ ) on the front panel.

- To return to normal play, press  $\triangleright$  (PLAY).



- To increase the speed, press SLOW/SEARCH on the remote control repeatedly or keep pressing  $\gg/\gg$ ,  $\ll/\ll$  on the front panel.

#### Note

- With Video CD, you cannot move backward.

## Using a disc's menu

Discs may contain multiple audio tracks, subtitles, index and bonus materials such as movie trailers and cast information, etc. And many of them have menu screens that enable you to control these features. This section gives you general instruction about how to operate these screens. However, the operation methods may differ depending on the disc.

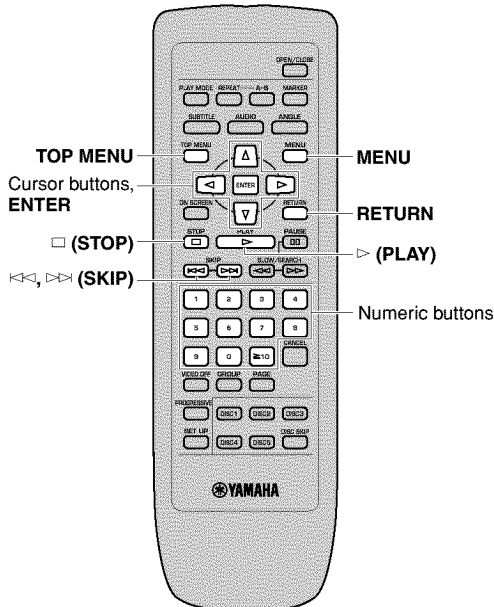

- 1 Press TOP MENU or MENU during playback to show menu screen.**
  - With some discs, menu screen appears automatically when you start playback.
- 2 Press the cursor buttons (Δ, ∇, ◀, ▶) to select the desired item.**
- 3 Press ENTER to go to the screen of the selected item or to start playing the selected item.**
  - You may also use the numeric buttons to operate steps 2 and 3.

### Video CD's playback control

If 'PBC' appears on the display while playing a Video CD, this unit is in playback control mode and a menu screen appears on the video monitor. You can operate menu screens using the following buttons.

**Numeric buttons:** Press to select the desired item.

**RETURN:** Press to go back to the previous screen

▷ **(PLAY):** Press to play the selected item

▷▷: Press to show the next screen

◁◁: Press to show the previous screen

□ **(STOP):** Press while a menu screen appears on the video monitor to cancel the playback control.

#### Note

- Playback control is automatically canceled during program play or random-sequence play.

## Enhancing video quality [U.S.A. and Canada models only]

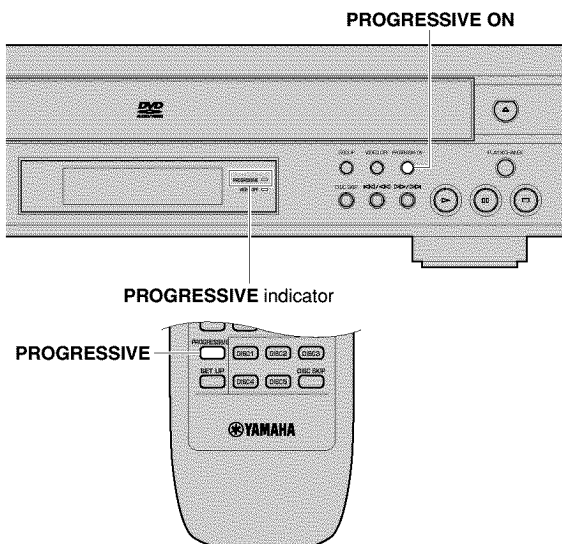

This unit's component video outputs are capable of output progressive signals. You can enjoy even higher quality picture if you have connected this unit to a monitor that can receive progressive signals.

Press PROGRESSIVE (or PROGRESSIVE ON on the front panel).

The PROGRESSIVE indicator lights up.

- To cancel this feature, press PROGRESSIVE again.

#### Note

- If the screen shifts off center when using progressive output, see 'Adjusting the screen position' on p.24.
- When playing 4:3 aspect software with a 16:9 aspect wide-screen monitor using progressive output, the picture may appear horizontally stretched to fill the screen. In that case, change the aspect to the correct one at your monitor. If the monitor cannot change the aspect, it is recommended to turn the progressive feature off.

## DVD-Audio features

This section explains about some features particular to DVD-Audio. Though most of the content selection can be controlled using a disc's menu like DVD-Video, there exists in a DVD-Audio the unit called 'group' that is something equivalent to DVD-Video's 'title'.

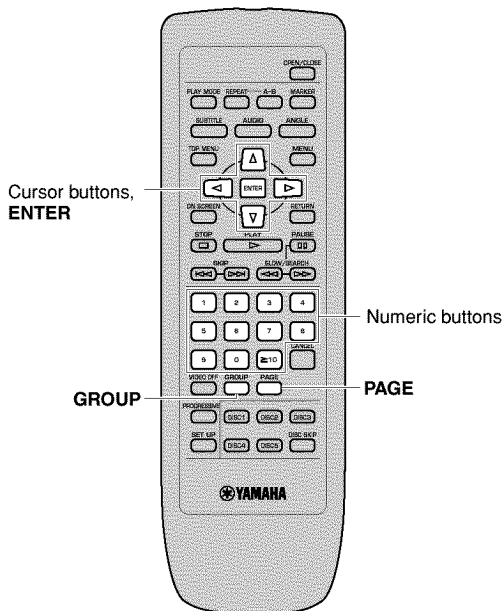

### ■ To play a track on a specific group

#### 1 Press GROUP.

The group and track icons appears on the video monitor.

#### 2 Press the cursor buttons ( $\Delta$ , $\nabla$ ) to select a group number and press ENTER.

#### 3 Press the cursor buttons ( $\Delta$ , $\nabla$ ) to select a track number and press ENTER.

The selected track starts to play.

- You can also use the numeric buttons to select a group and a track.

### ■ To play a bonus group

Some discs contain bonus groups. If it requires 4 digit password, consult the disc jacket, etc. and enter the password using the numeric buttons and then press ENTER.

### ■ To change pages

DVD-Audio may contain some information screens called 'pages' that show photo galleries, artist biographies and lyrics, etc. When it appears, you can move to another page by pressing PAGE (page number appears on the display when you change pages.).

- Some discs may navigate you to press the cursor buttons ( $\triangleleft$ ,  $\triangleright$ ) to turn pages.

## Enhancing audio quality

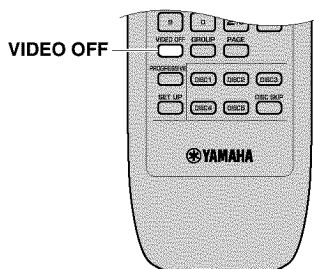
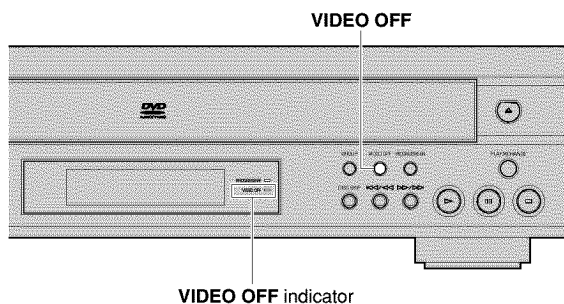

You can enjoy even higher quality sound by turning off the video signal output.

Press VIDEO OFF.

Picture is turned off and the VIDEO OFF indicator lights up.

- To cancel this feature, press VIDEO OFF again.
- While you pause or search play, this unit outputs the video signal and the picture is shown on the video monitor.

## Switching audio tracks, subtitles and angles

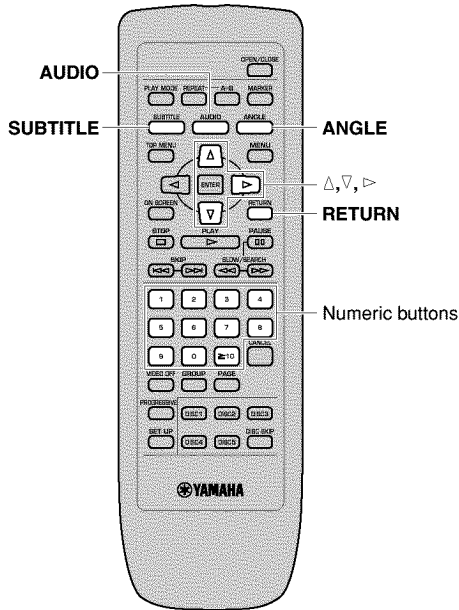

Some discs are encoded with several audio tracks, multilingual subtitles or multiple camera angles. Refer to disc jacket etc. to see which feature is supported.

### Audio tracks

Different audio track languages and/or formats can be selected if available on the disc.

Press **AUDIO** during play.

The Audio track icon appears on the video monitor.

- Pressing the button repeatedly toggles through all audio tracks recorded on the disc. You can also use the cursor buttons ( $\Delta$ ,  $\nabla$ ) or the numeric buttons to change tracks.
- You can also use the button to turn the vocals on and off on karaoke discs. See the instruction of each disc.

#### Notes

- Play restarts from the beginning of the current track if you change audio track while playing DVD-Audio, other than video section.
- With DVD-Audio, track number 2 may appear even if the disc does not support multiple audio tracks.

### Subtitles

Press **SUBTITLE** during play.

The subtitle icon appears on the video monitor.

- Pressing the button repeatedly toggles through all subtitles recorded on the disc. You can also use the cursor buttons ( $\Delta$ ,  $\nabla$ ) or the numeric buttons to change subtitles.

**To turn on/off the subtitles:**

- Press **SUBTITLE**.
- Press the cursor button ( $\triangleright$ ).
- Press the cursor buttons ( $\Delta$ ,  $\nabla$ ) to select **ON** and **OFF**.

#### Notes

- '-' appears if the disc does not have a subtitle.
- Subtitles may not change immediately after you press the button.

### Angles

Some DVDs have scenes encoded with multiple camera angles so that different viewpoint can be selected during playback. **ANGLE** lights up on the front panel display while a scene encoded with multiple angles is being played.

Press **ANGLE** while **ANGLE** on the front panel display lights up.

The angle icon appears on the video monitor.

- Pressing the button repeatedly toggles through all angles recorded on the disc. You can also use the cursor buttons ( $\Delta$ ,  $\nabla$ ) or the numeric buttons to change angles.

### To turn the icon off

Press **RETURN**.

#### Note

- With some discs, you cannot change audio tracks, subtitles or angles in the way described above. In that case, go to the disc menu and change them.

### AUDIO

#### DVD-Audio



#### DVD-Video



Selected audio track number – can be switched to 2 even if the audio track does not recorded on the disc.

Currently playing audio track number

### SUBTITLE



Subtitle language number being played

### ANGLE

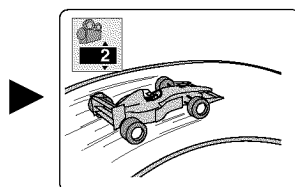
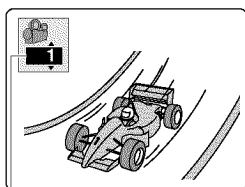

Angle number being played

# SPECIFYING THE PLAY SEQUENCE

## Repeat play

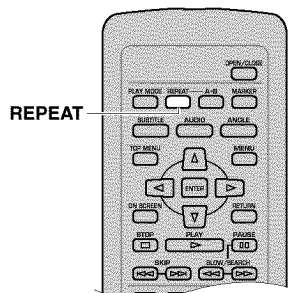

This function allows you to play your desired chapter, track or disc repeatedly.

### ■ Press REPEAT during playback.

Each time this button is pressed, repeat mode changes as follows. The name of the selected repeat mode scrolls once on the multi-information display and the corresponding indicators light up.

#### DVD-V

- Ⓐ **CHAPTER REPEAT:** The current chapter is played repeatedly.
- Ⓑ **TITLE REPEAT:** The current title is played repeatedly.
- Ⓒ **ALL REPEAT:** All the discs loaded on the tray are played repeatedly.
- Ⓓ **REPEAT OFF:** Repeat play mode is canceled.

#### DVD-A VCD CD

- Ⓔ **TRACK REPEAT:** The current track is played repeatedly.
- Ⓕ **DISC REPEAT (Video CD, CD):** The current disc is played repeatedly.
- or
- Ⓖ **GROUP REPEAT (DVD Audio):** The current group is played repeatedly.
- Ⓖ **ALL REPEAT:** All the discs loaded on the tray are played repeatedly.
- Ⓗ **REPEAT OFF:** Repeat play mode is canceled.

Pressing REPEAT while playback is stopped switches 'ALL REPEAT' to 'REPEAT OFF' or vice versa.

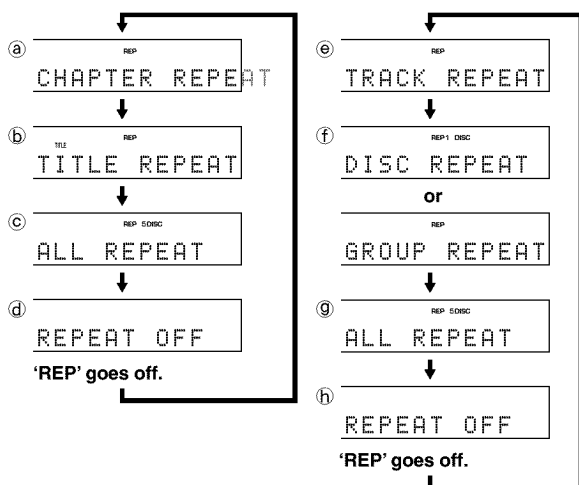

#### Program repeat

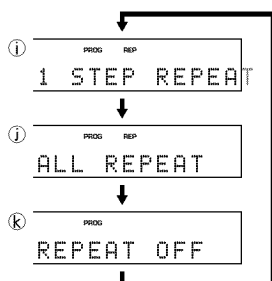

#### Random-sequence repeat

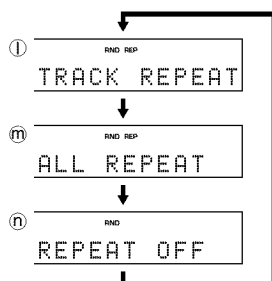

### ■ Program repeat DVD-A VCD CD

If REPEAT is pressed during programmed play (p.19), repeat mode changes as follows.

- Ⓘ **1 STEP REPEAT:** Repeating the track being played
- Ⓙ **ALL REPEAT:** Repeating all the programmed tracks
- Ⓚ **REPEAT OFF:** Canceling repeat mode (go back to normal program play)

### ■ Random-sequence repeat

#### DVD-A VCD CD

If REPEAT is pressed during random play (p.18), repeat mode changes as follows.

- Ⓛ **TRACK REPEAT:** Repeating the track being played
- Ⓜ **ALL REPEAT:** Playing all the tracks repeatedly, each time in different random-sequence.
- Ⓝ **REPEAT OFF:** Canceling repeat mode (go back to normal random play)

#### Notes

- Repeat play may not work properly with some DVD-Video.
- Repeat play does not work with an interactive DVD-Video or during menu play of a VCD with playback control.

## Repeat A-B

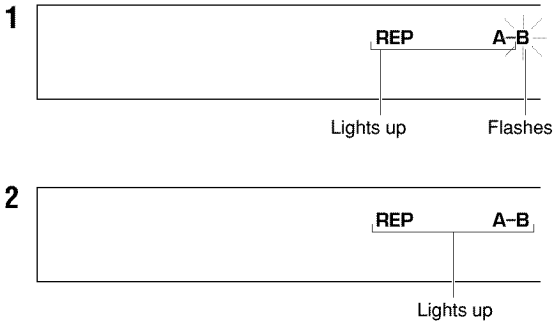
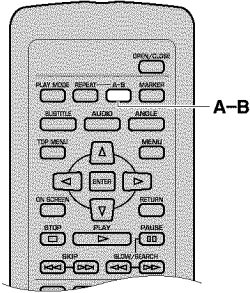

This function allows you to specify two points and play between them repeatedly.

- 1 Press A-B during play at the point where you want to start A-B repeat.**  
'REP' and 'A-' light up and 'B' flashes on the display.
- 2 Press A-B at the point where you want to end A-B repeat.**  
'REP' and 'A-B' appear on the display and repeat play of the section between point A and B starts.

### ■ To cancel A-B repeat

Press A-B repeatedly until A-B indicator on the display goes off.

#### Notes

- This function may not available with some DVD-Video.
- This function works only within a title (DVD-Video) or a track (VCD, CD).

## Random play [DVD-A] [VCD] [CD]

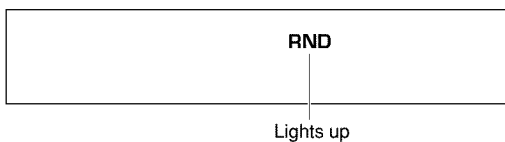
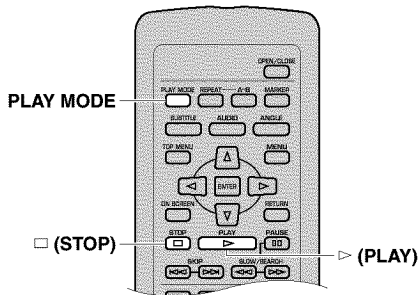

When you select this mode, this unit plays all tracks on all discs loaded on the disc tray in random sequence.

- 1 Press □ (STOP) to stop play.**
- 2 Press PLAY MODE repeatedly until 'RND' lights up on the display.**
- 3 Press ▷ (PLAY) to start random play.**

### ■ To cancel random mode

- 1 Press □ (STOP) twice during play.**  
Random play is suspended.
- 2 Press PLAY MODE once.**  
RND indicator goes off.

If you press ▷ (PLAY) successively, normal playback starts from the beginning of the disc having been played before canceling random mode.

Opening the disc tray also cancels this mode.

#### Note

When this unit is in random mode while a Video CD (ver.2.0) is loaded, playback control is canceled during random play.

## Programmed play [DVD-A] [VCD] [CD]

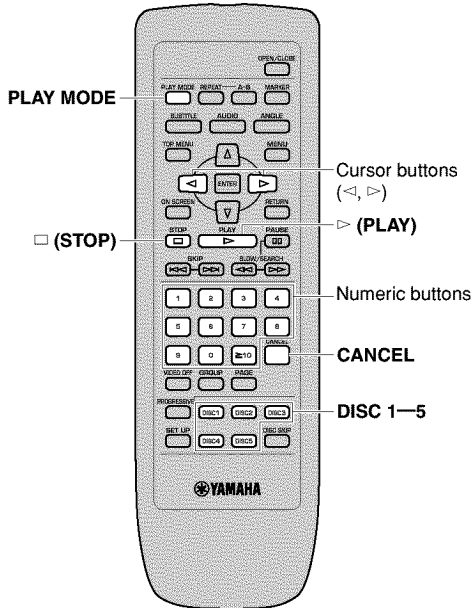

You can enjoy listening to your favorite tracks selected from one or more discs in any desired order by programming tracks.

**1** Press **(STOP)** to stop play.

**2** Press **PLAY MODE** repeatedly until **PROG** lights up on the display.

The display shows the step information.

**3** Press **DISC 1—5** to select the disc.

- When programming DVD-Audio, press **GROUP** to specify the group.

**4** Press **numeric buttons** to select the track.

- Repeat steps 3 and 4 to program other tracks in your desired order.
- See p.13 about how to enter the track with numeric buttons.
- To program a whole disc (or all tracks of the selected group of DVD-Audio), press **ENTER** ('ALL' appears on the display).
- Pressing **(STOP)** cancels all tracks programmed so far.

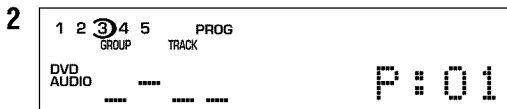

Selected disc

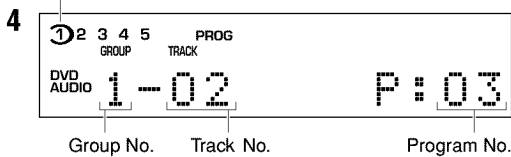

You can program up to 32 tracks to be played in desired order. 'FULL' appears on the display when the number of tracks exceeds 32.

**5** Press **(PLAY)** to start play.

### ■ To cancel the programmed tracks

- 1 Press the cursor buttons (<, >) to select the track you want to cancel.
- 2 Press **CANCEL**.

#### Note

When you program a track of a Video CD (ver.2.0), playback control is canceled during programmed play.

### ■ To exit programming mode

Press **PLAY MODE** twice or open the disc tray.

## Bookmarks

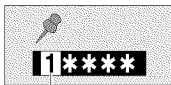
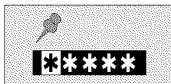
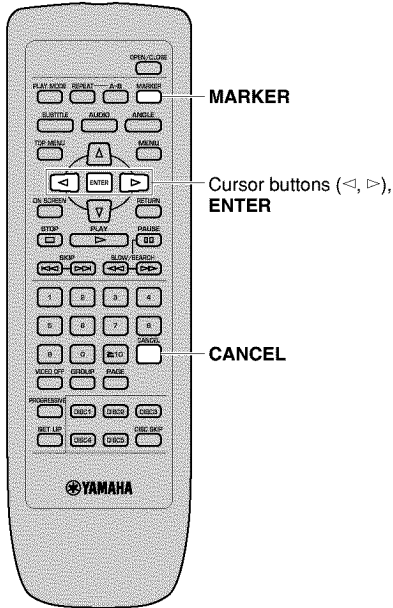

Bookmark number

This feature allows you to mark up to 5 points so that you can quickly return to those points later.

### 1 Press MARKER.

The marker icon appears on the screen.

### 2 Press the cursor buttons (<, >) to select one of five asterisks.

The selected asterisk is highlighted.

### 3 Press ENTER.

The selected asterisk turns to be the bookmark number.

### ■ To recall a bookmarked scene

Press the cursor buttons (<, >) to select a bookmark number and press ENTER.

### ■ To clear a bookmark

Press the cursor buttons (<, >) to select a bookmark number and press CANCEL.

#### Note

When you open the tray or turn this unit off, all bookmarks are cleared.



# ON-SCREEN MENU

You can control various items using on-screen menu bar.

## Operating menu bar

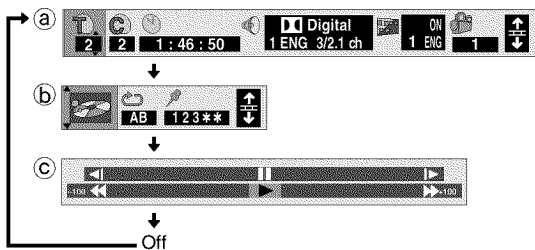

### • Icons for player menu

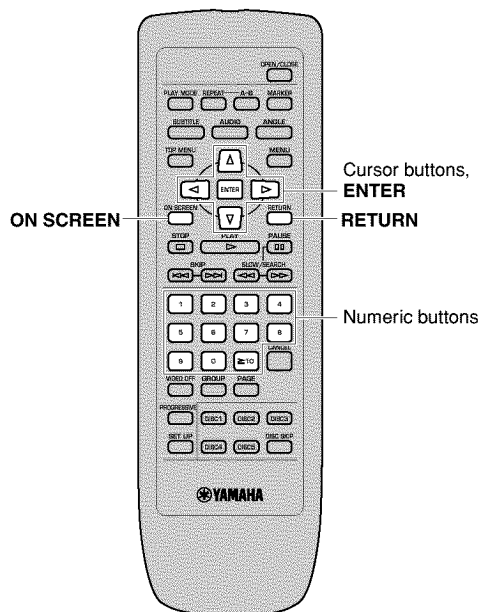
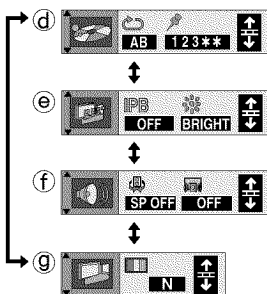

### 1 Press ON SCREEN.

Each time ON SCREEN is pressed, the menu bar changes as below.

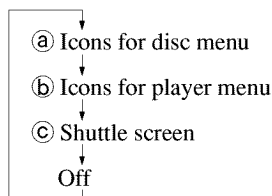

### 2 Press the cursor buttons (◀, ▶) to select the item you wish to adjust.

The selected item is highlighted.

- Icons for player menu has 4 different menu bars as below. To switch the menu bar, select the leftmost icon and then press the cursor buttons (Δ, ▽).

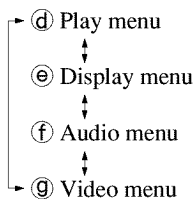

### 3 Press the cursor buttons (Δ, ▽) to change setting.

- With some items, you need to press ENTER or ▶ (PLAY) to determine the setting.
- You can also use the numeric buttons when entering numbers to select a chapter, etc.
- You can also use RETURN to turn the screen off.
- Δ and ▽ around the icon means that the item can be changed using the cursor buttons (Δ, ▽).



### Note

- Some items cannot be accessed when the play is stopped.

### ■ To change the menu bar position

When the menu bar does not appear properly, you can adjust its position.

#### 1 Select the rightmost icon (⊞).

#### 2 Press the cursor buttons (Δ, ▽) to move the menu bar.

## Icons for disc menu

example: DVD-Video



	<b>DVD-V</b> Title number <b>DVD-A</b> <b>VCD</b> <b>CD</b> Track number
	<b>DVD-V</b> Chapter number
	<b>DVD-A</b> Group number
	<b>DVD-A</b> <b>DVD-V</b> Time index (hour:minute:second) You can start play from the desired point by specifying the elapsed time. <b>DVD-A</b> <b>VCD</b> <b>CD</b> Changing the time display <ul style="list-style-type: none"> <li>→ Track elapsed time</li> <li>↕</li> <li>Track remaining time</li> <li>↕</li> <li>Disc remaining time</li> </ul>
	<b>VCD</b> Audio mode LR ↔ L ↔ R
	<b>DVD-A</b> <b>DVD-V</b> ① Audio track number ② Audio track Language: See <b>A</b> for language abbreviations. ③ Audio signal type: See <b>B</b> for details.
	<b>DVD-A</b> <b>DVD-V</b> Karaoke vocal on/off (Karaoke DVD only) Solo: OFF or ON Duet: OFF, V1+V2, V1 or V2
	<b>DVD-A</b> <b>DVD-V</b> ① Subtitle on/off ② Subtitle language

	<b>DVD-A</b> <b>DVD-V</b> Angle number
	<b>VCD</b> Playback control Indicates whether playback control is on or off.
	<b>DVD-A</b> Page number

### A Language

ENG: English	SVE: Swedish	CHI: Chinese
FRA: French	NOR: Norwegian	KOR: Korean
DEU: German	DAN: Danish	MAL: Malay
ITA: Italian	POR: Portuguese	VIE: Vietnamese
ESP: Spanish	RUS: Russian	THA: Thai
NLD: Dutch	JPN: Japanese	*: Others

### B Signal type/data

LPCM/PPCM/**D**Digital/DTS/MPEG: Signal type

k (kHz): Sampling frequency

b (bit): Number of bits

ch (channel): Number of channels

Example:

3/2 .1ch

1: Subwoofer (not displayed if there is no subwoofer signal)
0: Rear channel not available on the disc
1: Rear channel (monaural)
2: Rear channels (left/right)
1: Main channel (monaural)
2: Main channels (left/right)
3: Main channels (left/right) + Center

### Notes

- Display may differ in accordance with the disc's specification.
- Time remaining on the disc does not appear during program or random-sequence play.

## Shuttle screen

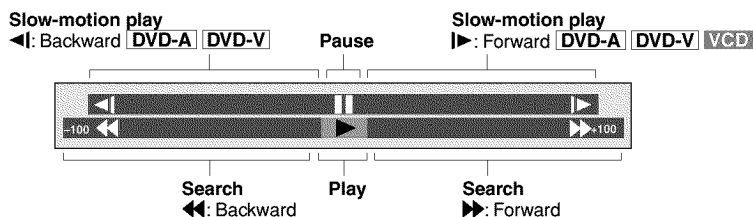

### Note



- Slow-motion only works on the video parts of DVD-Audio.

## Icons for player menu

### ■ Play mode menu

example: DVD-Video





	<b>A-B repeat (→ p.18)</b> [ENTER] (start point) → [ENTER] (finish point) To cancel [ENTER]
	<b>Bookmarks (→ p.20)</b> You can mark up to 5 points. To mark a point [◀, ▶] → [ENTER] (at the desired point) To recall a bookmark [◀, ▶] → [ENTER] To erase a bookmark [◀, ▶] → [CANCEL]

### ■ Display menu

example: DVD-Video



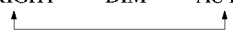

	<b>DVD-V</b> <b>IPB display</b> Displays the picture type (I/P/B)* of a still picture (when paused). ON ↔ OFF
	<b>Display dimmer</b> Changes the brightness of the front panel display BRIGHT ↔ DIM ↔ AUTO*  * The display dims and any indicators that were on turn off during play. The display brightens and the indicators light up temporarily when you perform an operation.

\* 'I' (intra coded picture) indicates that the picture is the original one and has greater amount of information than that of 'P' or 'B'. 'P' (predictive coded picture) is made from 'I' and 'B' (bidirectionally-predictive coded picture) is to fill in the space between 'I' and 'P'. It is recommended to use 'I' picture for adjusting video image.

### ■ Audio menu

example: DVD-Video



	<b>DVD-V VCD</b> <b>Virtual surround mode</b> Allows you to enjoy surround-like effect without surround speakers when playing a disc encoded with multi-channel audio track (may not effective with some discs). You can also enjoy the feature connecting headphones to your AV amplifier. <b>SP</b> (with main speakers): Dolby Digital, DTS, MPEG, LPCM multi-channel source <b>HP</b> (with headphones): Dolby Digital, MPEG, LPCM multi-channel source <b>SP/HP OFF:</b> Virtual surround-off <b>SP/HP 1:</b> Virtual surround-on <b>SP/HP 2:</b> Virtual surround-enhanced
	<b>DVD-V</b> <b>Cinema dialog</b> Increases the volume level of the dialog part (center channel).

#### Notes

- Audio output from this unit is 2-channels when the virtual surround is turned on.
- Turn off the sound effect of the AV amplifier, etc. connected to this unit when turning on the virtual surround.
- Turn the virtual surround off if it causes sound distortion.

## Video menu



	<p><b>Digital picture mode</b> To select the picture mode: [<math>\Delta</math>, <math>\nabla</math>]  <b>N:</b> Normal  <b>C:</b> Cinema image (suited for movie viewing)  <b>U:</b> User mode  <b>To change the user mode</b>                      1 Select User mode and press <math>\triangleright</math>.                      2 Press (<math>\leftarrow</math>, <math>\rightarrow</math>) to select the item you wish to change.                      3 Press (<math>\Delta</math>, <math>\nabla</math>) to change the setting.                      The following items are also displayed when you select 'U'.</p>
	<p><b>U Contrast</b> (-7 to +7) Adjusts the contrast between light and dark part of the picture.</p>
	<p><b>Brightness</b> (0 to +15) Adjusts the brightness of the picture.</p>
	<p><b>Sharpness</b> (-6 to +6) (Australia model) Adjusts the horizontal resolution of the picture.</p>
	<p><b>Color</b> (-7 to +7) Adjusts the shade of the picture's color.</p>

When PROGRESSIVE is on (U.S.A. and Canada models)

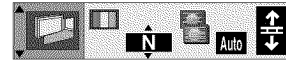

	<p><b>Digital picture mode</b> To select the picture mode: [<math>\Delta</math>, <math>\nabla</math>]  <b>N:</b> Normal  <b>C:</b> Cinema image (suited for movie viewing)</p>
	<p><b>Transfer MODE</b> Selects the method of conversion for progressive output to suit the type of material being played.  <b>Auto (normal):</b> for viewing film material  <b>Video:</b> for video material</p>

## Adjusting the screen position (when using progressive output)

(U.S.A. and Canada models)

With some video monitors, the screen may shift off center with progressive signals output from this unit. To adjust the position, follow the below method.

- 1 Press  $\square$  (PAUSE) to pause play.
- 2 Follow the steps 1 and 2 on 'Operating menu bar' on p.21 to show the video menu.
- 3 Press  $\triangleright$  to select the rightmost icon ( $\frac{\pm}{\square}$ ).
- 4 Adjust the position.  
 To move to the left, press the numeric button 1.  
 To move to the right, press the numeric button 3.  
 To set the screen back to the original position, press the numeric button 2.

### Example:

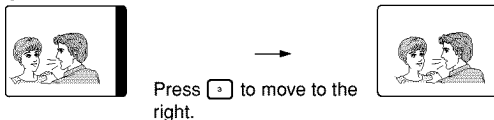

- You can check whether the picture is in the center or not by switching to normal output (press PROGRESSIVE so the indicator turns off).
- 5 Save the adjusted position.  
 First press  $\square$  (STOP) and then press SET UP to show setup menu. Then press SET UP once again (or RETURN) and now the position is saved. Even if you skip this procedure, the position is saved until you turn the power off.

# SETUP MENU

With the setup menu, you can change this unit's system defaults to suit your preference and your home theater system. Some items must be adjusted to play a disc properly.

## Operating the setup menu

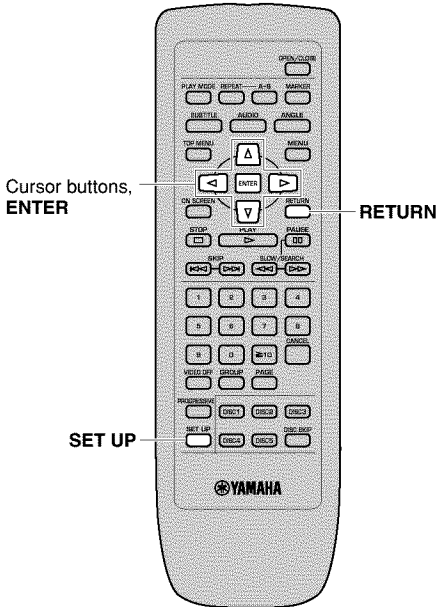

This section shows common procedures (some items require additional steps). Use the remote control to operate the setup menu.

**1 Press SET UP while playback is stopped.**  
The menu screen appears on the video monitor.

**2 Press the cursor buttons (◀, ▶) to select a menu group.**

There are five menu groups. The screen shows the items that belong to the menu group of the selected tab.

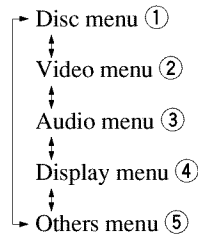

**3 Press the cursor buttons (Δ, ▽) to select the desired item and press ENTER.**

**4 Press the cursor buttons (Δ, ▽) to change the setting and press ENTER.**

■ **To go back to the previous screen**  
Press RETURN.

■ **To get out from the setup menu mode**  
Press SET UP.

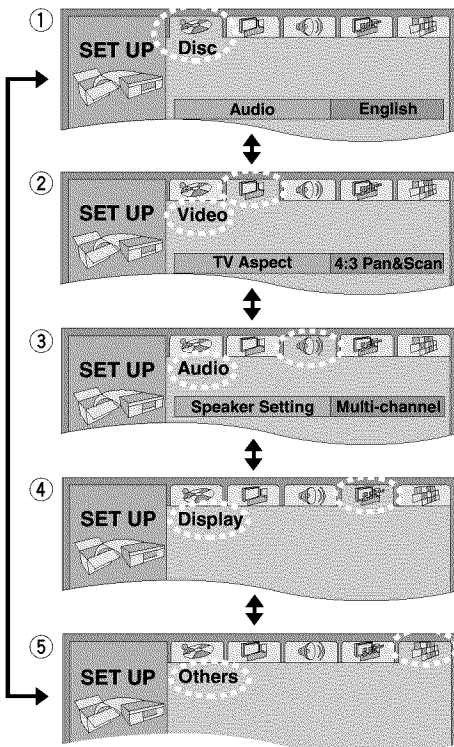

## Summary of settings

The below chart shows the menu groups and each items. In the 'Options' column, the factory settings are underlined.

Menu groups	Items	Options
<b>Disc</b> → See p.27 and 28 for details.	<b>Audio</b> <b>DVD-A</b> <b>DVD-V</b> Select the preferred audio track language.	(U.S.A. and Canada models) <u>English</u> French Spanish Original Other**** (Australia model) <u>English</u> French German Italian Spanish Original Other****
	<b>Subtitle</b> <b>DVD-A</b> <b>DVD-V</b> Select the preferred subtitle language.	(U.S.A. and Canada models) <u>Automatic</u> English French Spanish Other**** (Australia model) <u>Automatic</u> English French German Italian Spanish Other****
	<b>Menus</b> <b>DVD-A</b> <b>DVD-V</b> Select the preferred disc menu language.	(U.S.A. and Canada models) <u>English</u> French Spanish Other**** (Australia model) <u>English</u> French German Italian Spanish Other****
	<b>Ratings</b> <b>DVD-V</b> Set a ratings level to limit DVD-Video play. See p.28 for details.	<b>Setting ratings (When level 8 is selected)</b> <u>8 No Limit</u> 1 to 7 0 Lock All ----- <b>Changing ratings (When level 0—7 is selected)</b> Unlock Player Change Level Change Password Temporary Unlock
<b>Video</b>	<b>TV Aspect</b> If you connect to a 4:3 conventional-type monitor, select '4:3 Pan&Scan' (left and right sides trimmed when playing 16:9 software) or '4:3 Letterbox' (black areas appear at the top and bottom when playing 16:9 software). Select '16:9' if you connect to a widescreen monitor.	<u>4:3 Pan&amp;Scan</u> 4:3 Letterbox 16:9
	<b>Still Mode</b> Specify the type of picture shown when paused. First select 'Automatic'. If a still picture jitters, select 'Field'. If details don't appear clearly enough, select 'Frame'.	<u>Automatic</u> Field Frame
	<b>Black Level Control</b> (U.S.A. and Canada models) Change the black level of the picture. Select 'Lighter' when you connect to the monitor using VIDEO or S VIDEO terminal. Select 'Darker' when using COMPONENT terminals.	<u>Lighter</u> Darker
	<b>NTSC Disc Output</b> (Australia model) Select video signal format (PAL 60 or NTSC) to be output when playing NTSC disc.	<u>PAL 60</u> NTSC
<b>Audio</b>	<b>Speaker Setting</b> Adjust the settings to suit your audio system and your listening environment when you connect to your AV amplifier using 6CH DISCRETE terminals. See p.29 for details.	<u>Multi-channel</u> : Select this when connected to multi-channel system. There are three sub-items as below. • Speaker presence and size • Delay time • Channel balance ----- 2-channel: Select this when connected to 2-channel system.
	<b>PCM Down Conversion</b> <b>DVD-A</b> <b>DVD-V</b> Select how to output the high sampling-frequency audio signals on a disc that is not copyright-protected. See p.28 for details.	<u>No</u> Yes

Menu groups	Items	Options
Audio	<b>Dolby Digital</b> <b>DVD-A</b> <b>DVD-V</b> Decide the signal type that output from this unit's digital outputs. Select 'Bitstream' when connected device has Dolby Digital decoder. Select 'PCM' when not.	<u>Bitstream</u> PCM
	<b>DTS Digital Surround</b> <b>DVD-A</b> <b>DVD-V</b> Decide the signal type that output from this unit's digital outputs. Select 'Bitstream' when connected device has DTS decoder. Select 'PCM' when not.	PCM <u>Bitstream</u>
	<b>MPEG</b> <b>DVD-A</b> <b>DVD-V</b> (Australia model) Decide the signal type that output from this unit's digital outputs. Select 'Bitstream' when connected device has MPEG decoder. Select 'PCM' when not.	PCM <u>Bitstream</u>
	<b>D. Range Compression</b> <b>DVD-A</b> <b>DVD-V</b> (Dolby Digital only) Change the dynamic range for late night viewing. Select 'On' to make it easier to hear dialog etc. even at low volume level.	<u>Off</u> On
	<b>Audio during Search</b> <b>DVD-A</b> <b>DVD-V</b> <b>VCD</b> Select whether to have sound during search. Select 'Off' if sound distorted when searching with Dolby Digital or DTS material. With DVD-Audio, the sound may be heard even if you select 'Off'.	<u>On</u> Off
Display	<b>Menu Language</b> Select the preferred language for on-screen messages and setup menu.	(U.S.A. and Canada models) <u>English</u> Français Español (Australia model) <u>English</u> Français Deutsch Italiano Español
	<b>On-Screen Messages</b> Select whether to show on-screen messages or not.	<u>On</u> Off
Others	<b>DVD-Video Mode</b> Decide whether to play a DVD Audio disc with DVD Video contents as a DVD Video disc or not.	<u>Off</u> On
	<b>Demo</b> A demonstration of the unit's on-screen displays starts when you select 'On'. The demonstration stops when you press a button and the setting reverts to 'Off'.	<u>Off</u> On

## Language selection and language code list

If you set to 'Original' at Audio, Subtitle or Menus, the original language of each disc is selected. If you set to 'Other', you need to select a four-digit number of the desired language from the list below and enter with numeric buttons.

### Language code list

6565: Afar	6890: Bhutani	7285: Hungarian	7679: Laotian	8084: Portuguese	8469: Telugu
6566: Abkhazian	6976: Greek	7289: Armenian	7684: Lithuanian	8185: Quechua	8471: Tajik
6570: Afrikaans	6978: English	7365: Interlingua	7686: Latvian, Lettish	8277: Rhaeto-Romance	8472: Thai
6577: Ameharic	6979: Esperanto	7378: Indonesian	7771: Malagasy	8279: Romanian	8473: Tigrinya
6582: Arabic	6983: Spanish	7383: Icelandic	7773: Maori	8285: Russian	8475: Turkmen
6583: Assamese	6984: Estonian	7384: Italian	7775: Macedonian	8376: Slovenian	8476: Tagalog
6588: Aymara	6985: Basque	7387: Hebrew	7776: Malayalam	8365: Sanskrit	8479: Tonga
6590: Azerbaijani	7065: Persian	7465: Japanese	7778: Mongolian	8368: Sindhi	8482: Turkish
6665: Bashkir	7073: Finnish	7473: Yiddish	7779: Moldavian	8372: Serbo-Croatian	8484: Tatar
6669: Byelorussian	7074: Fiji	7487: Javanese	7782: Marathi	8373: Singhalese	8487: Twi
6671: Bulgarian	7079: Faroese	7565: Georgian	7783: Malay	8375: Slovak	8575: Ukrainian
6672: Bihari	7082: French	7575: Kazakh	7784: Maltese	8376: Slovenian	8582: Urdu
6678: Bengali; Bangla	7089: Frisian	7576: Greenlandic	7789: Burmese	8377: Samoan	8590: Uzbek
6679: Tibetan	7165: Irish	7577: Cambodian	7865: Nauru	8378: Shona	8673: Vietnamese
6682: Breton	7168: Scots Gaelic	7578: Kannada	7869: Nepali	8379: Somali	8679: Volapük
6765: Catalan	7176: Galician	7579: Korean	7876: Dutch	8381: Albanian	8779: Wolof
6779: Corsican	7178: Guarani	7583: Kashmiri	7879: Norwegian	8382: Serbian	8872: Xhosa
6783: Czech	7185: Gujarati	7585: Kurdish	7982: Oriya	8385: Sundanese	8979: Yoruba
6789: Welsh	7265: Hausa	7589: Kirghiz	8065: Punjabi	8386: Swedish	9072: Chinese
6865: Danish	7273: Hindi	7665: Latin	8076: Polish	8387: Swahili	9085: Zulu
6869: German	7282: Croatian	7678: Lingala	8083: Pashto, Pushto	8465: Tamil	

### Note

Selecting audio, subtitle or disc menu language is a disc-dependent matter. The language selected at the setup menu is not effective if a disc does not have it.

## Ratings [DVD-V]

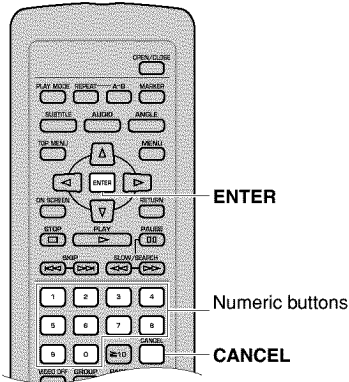

Depending on software capability, you can prevent discs or scenes with objectionable material from being played according to your desired rating. You can select the level and lock it by designating password.

Level 8	All DVDs can be played.
Level 7 to 1	Level of restriction becomes severer as the number gets smaller.
Level 0	All DVDs cannot be played.

### Setting method

**1** Follow steps 1 to 4 of 'Operating the Setup Menu' (see p.25) to select the desired level.

**2** Enter 4-digit number with numeric buttons and press ENTER.

- Press CANCEL if you want to re-enter other number.  
The screen that confirms your password appears. Do not forget your password.

**3** Press ENTER.

When you select a disc that exceeds the rating you have set, a message appears on the monitor. If you want to play the disc, select 'Yes' and enter your password. The unit unlocks the setting. It will be locked again by selecting another disc, opening the disc tray or turning the unit off.

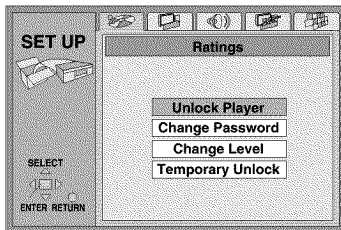
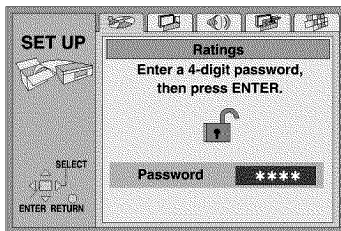

### To change settings

You must enter your designated password when you unlock the player (level is set to 8), change the level, change the password, or unlock the playback of currently selected disc.

Select 'Ratings' and then follow each procedure appears on the screen.

## PCM down conversion [DVD-A] [DVD-V]

Decide whether to output high-quality digital signals (sampling frequency of 88.2 kHz and 96 kHz) or not, in accordance with the capability of the connected component.

- If your AV amplifier etc. is capable of handling high-rate sampling frequency digital signals, select 'No'.
- If not, select 'Yes' so that digital output signals are converted to 48 kHz or 44.1 kHz.

### Note

- If a disc is copy-right protected or has a sampling frequency of 176.4 kHz or more, signals are automatically converted to either 48 kHz or 44.1 kHz.

## Speaker settings

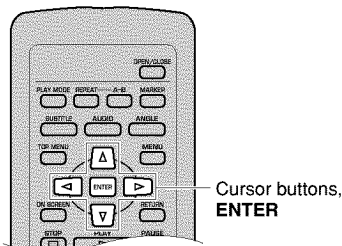

If you wish to enjoy multi-channel sound reproduction connecting this unit's 6CH DISCRETE output terminals to your amplifier etc., you need to select 'Multi-channel' and make following adjustments. Also, set your amplifier's input mode to analog.



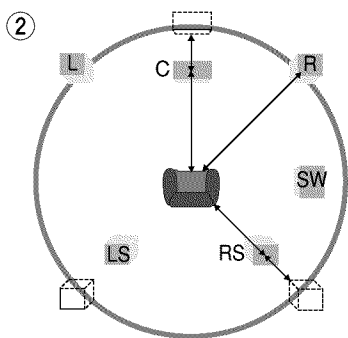
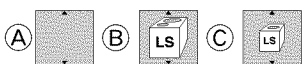
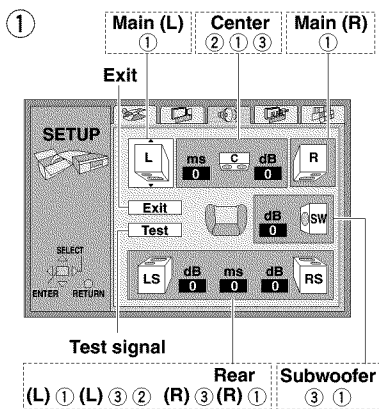

• Center speaker

Difference	Setting
Approx. 50 cm (1 1/2 feet)	1.3 ms
Approx. 100 cm (3 feet)	2.6 ms
Approx. 150 cm (5 feet)	3.9 ms
Approx. 200 cm (6 feet)	5.3 ms

• Rear speakers

Difference	Setting
Approx. 200 cm (6 feet)	5.3 ms
Approx. 400 cm (12 feet)	10.6 ms
Approx. 600 cm (18 feet)	15.9 ms

### Output mode ①

Change the settings of each speaker in accordance with your speaker system.

**1** Press the cursor buttons (◀, ▶, ▲, ▼) to select a speaker and press ENTER.

**2** Press the cursor buttons (▲, ▼) to select the setting and press ENTER.

Example: Left surround (rear) speaker

- Ⓐ when the speaker is not used
- Ⓑ when using a large speaker capable of low-frequency (under 100 Hz) output.
- Ⓒ when using a small speaker that is not capable of low-frequency output.

The L and R (left and right main speakers) settings are automatically decided by the SW (subwoofer) setting.

### Delay time ②

To obtain the maximum effect of Dolby Digital 5.1 channel source, all speakers should be located at the same distance from the listening position. However, in many cases they are not the center speaker is placed in line with the main speakers, etc. You can virtually increase the distance of the center and rear speakers by adjusting the delay time.

**1** Press the cursor buttons (◀, ▶, ▲, ▼) to select a 'ms' box and press ENTER.

**2** Press the cursor buttons (▲, ▼) to adjust the delay time and press ENTER.

### Speaker balance ③

You can adjust the output level of each effect speakers (center, surround L/R) using the test tone.

**1** Press the cursor buttons (◀, ▶, ▲, ▼) to select 'Test' and press ENTER.

The test tone is one speaker at a time in below order, starting with the left main speaker.

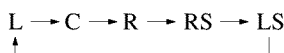

**2** Listening to the test tone, press the cursor buttons (▲, ▼) to adjust the volume of effect speakers and press ENTER.

The value in the 'dB' box changes.

**Note**

The subwoofer cannot output the test tone. Play something and return to this screen to adjust the output level of the subwoofer.

### To exit the speaker setting mode

Press the cursor buttons (◀, ▶, ▲, ▼) to select 'EXIT' and press ENTER.

**Notes**

- These adjustments are not effective on digital signal output from this unit. Make adjustments at your amplifier.
- These adjustments may not be effective when the disc's original sound design is protected. PPCM indicator lights up or DMIX indicator turns off in that case.

# TROUBLESHOOTING

If this unit fails to operate normally, check the following points to determine whether the fault can be corrected, or if the fault is not listed in the PROBLEM column, disconnect the power cord and contact your authorized YAMAHA dealer or service center.

PROBLEM	POSSIBLE CAUSE	WHAT TO DO	Refer to Page
<b>This unit fails to turn on when the POWER switch is pressed.</b>	The power cord is not connected or the plug is not completely inserted.	Firmly connect the power cord.	—
<b>This unit does not work normally.</b>	This unit is affected by an external shock (lightning, excessive static electricity, incorrect operation, etc.)	Turn the power off and disconnect the power cord. After about 30 seconds have passed, connect the power and operate the unit again.	—
<b>Playback does not start.</b>	The disc is damaged.	Check the disc carefully; replace it if necessary.	—
	There is moisture on the laser pickup.	Wait 1 to 2 hours after switching the unit on before trying to play a disc.	—
	The disc has been loaded upside down.	Reload the disc with the label side facing up.	—
	The disc is dirty.	Clean the disc.	3
<b>No picture.</b>	Incorrect video connections.	Connect this unit and other equipment properly.	9
	Input selection at your AV amplifier or your video monitor is not the one connected to this unit.	Set the input to the right position.	—
	VIDEO OFF is functioning.	Press VIDEO OFF to cancel the feature.	15
	(U.S.A. and Canada models) If you play PAL system DVD-Audio, 'This disc is PAL system. The output is sound only' may appear on the monitor. Picture is not available because the disc's video signal system is different.		—
<b>Picture appears incorrectly.</b>	Incorrect 'TV aspect' setting.	Select the right position. However, it may be difficult to adjust many DVD-Videos' widescreen format to fit perfectly in your 4:3 video monitor.	26
	A VCR is connected between this unit and the video monitor.	Connect this unit's video outputs directly to your video monitor or to your AV amplifier and then to a video monitor.	9
	(U.S.A. and Canada models) PROGRESSIVE is turned on even though the connected monitor cannot receive the progressive signals.	Turn off the PROGRESSIVE feature.	14
	(U.S.A. and Canada models) Due to the editing method or material used on a DVD, ghosting may occur with progressive output.	Turn off the PROGRESSIVE feature.	14
<b>Play is delayed, or starts at the wrong place.</b>	The disc may be scratched or damaged.		—
<b>This unit does not recognize discs ('No disc' appears on the display, or the display shows the status when no disc is loaded).</b>	The disc(s) is not placed properly.	Place the disc(s) correctly along the guide(s).	—
<b>No sound.</b>	Incorrect cable connections.	Connect the cables properly. If the problem persists, the cables may be defective.	8
	Incorrect amplifier operation.	Set the amplifier controls to the correct input selection.	—

PROBLEM	POSSIBLE CAUSE	WHAT TO DO	Refer to Page
<b>No sound when playing a disc encoded with DTS.</b>	Incorrect setting(s) at the audio section of 'Setup menu' on this unit or at 'input mode' on your amplifier.	Select proper settings.	26, 27
<b>No sound from some speakers.</b>	With some DVD-Audio, output channels are specified by the disc.		—
	Incorrect 'Speaker settings'. (when 6CH DISCRETE outputs are connected to your amplifier)	Change the settings to suit your speaker system.	29
	Audio output from this unit becomes two channels when the virtual surround feature is on.	Turn virtual surround mode off.	23
<b>Sound distorted.</b>	Virtual surround effect is emphasized too much.	Turn virtual surround mode off.	23
<b>Sound 'skips'.</b>	This unit is being subjected to vibrations or impacts.	Relocate the unit.	—
	The disc is dirty.	Clean the disc.	3
<b>Sound 'hums'.</b>	Incorrect cable connections.	Securely connect the audio cables. If the problem persists, the cables may be defective.	8
<b>Noise from a nearby tuner.</b>	The tuner is too close to the unit.	Place the tuner and the unit farther apart.	—
<b>Noise from inside of the unit.</b>	The disc maybe warped.	Replace the disc.	—
<b>The remote control does not work.</b>	The batteries are weak.	Replace all batteries with new ones.	7
	Direct sunlight or lighting (from an inverter type of fluorescent lamp, etc.) is striking the remote control sensor of this unit.	Relocate the unit.	7
<b>Audio track and/or subtitle language is not the selected one.</b>	The disc does not contain the language you have selected.		—
<b>No subtitles.</b>	The disc does not have subtitles.		—
	Subtitle is turned off.	Show subtitles by pressing SUBTITLE or using on-screen menu.	16
<b>Angle cannot be changed.</b>	The disc or the scene being played does not support multi-angle.		—
<b>The password for setting parental level has been forgotten.</b>		Clear all settings on the setup menu. See 'Returning setup menu to the factory-setting' below this table.	—

### ■ Returning setup menu to the factory-setting

While playback is stopped, press and hold **⏸** (PAUSE), and then **DISC SKIP** and **PLAYXCHANGE** on the front panel until 'Initialized' appears on the video monitor. All settings on the setup menu return to the factory settings.

# SPECIFICATIONS

## ■ Audio section

### Frequency response

DVD (48 kHz sampling): ..... 2 Hz to 22 kHz  
DVD (96 kHz sampling): ..... 2 Hz to 44 kHz  
DVD Audio (192 kHz sampling): ..... 2 Hz to 88 kHz

CD, Video CD: ..... 2 Hz to 20 kHz

Harmonic distortion + noise (1 kHz): ..... 0.002 %

S/N ratio: ..... 115 dB (Weighted)

### Dynamic range

DVD (48 kHz, 24 bit): ..... 103 dB  
CD, Video CD: ..... 99 dB

Output level (1 kHz, 0 dB): ..... 2±0.3 V

## ■ Video section

VIDEO output: ..... 1 Vp-p (75 Ω)

### S VIDEO output

Y output: ..... 1 Vp-p (75 Ω)

#### C output:

NTSC ..... 0.286 Vp-p (75 Ω)

PAL ..... 0.3 Vp-p (75 Ω)

### COMPONENT VIDEO output

Y output: ..... 1 Vp-p (75 Ω)

P<sub>B</sub> output: ..... 0.7 Vp-p (75 Ω)

P<sub>R</sub> output: ..... 0.7 Vp-p (75 Ω)

## ■ General

### Power supply:

[U.S.A. and Canada models] ..... 120 V, 60 Hz  
[Australia model] ..... 240 V, 50 Hz

Power consumption: ..... 21 W

### Laser pickup:

Wave length ..... 665 nm  
Laser power ..... CLASS II  
Laser output ..... Max. 1.0 mW (Continuous)  
Output value determined by 21 CFR CHAPTER 1,  
SUBCHAPTER J

Dimensions: ..... 435 (W) × 116 (H) × 404 (D) mm  
(17-1/8" × 4-1/2" × 15-7/8")

Weight: ..... 6.2 kg  
(13 lbs 10 oz)

Accessories: ..... RCA pin cable (audio/video)  
Remote control  
Batteries (AA, R6, UM-3)



YAMAHA ELECTRONICS CORPORATION, USA 6660 ORANGETHORPE AVE., BUENA PARK, CALIF. 90620, U.S.A.  
YAMAHA CANADA MUSIC LTD. 135 MILNER AVE., SCARBOROUGH, ONTARIO M1S 3R1, CANADA  
YAMAHA ELECTRONIK EUROPA G.m.b.H. SIEMENSSTR. 22-34, 25462 RELLINGEN BEI HAMBURG, F.R. OF GERMANY  
YAMAHA ELECTRONIQUE FRANCE S.A. RUE AMBROISE CROIZAT BP70 CROISSY-BEAUBOURG 77312 MARNE-LA-VALLEE CEDEX02, FRANCE  
YAMAHA ELECTRONICS (UK) LTD. YAMAHA HOUSE, 200 RICKMANSWORTH ROAD WATFORD, HERTS WD1 7JS, ENGLAND  
YAMAHA SCANDINAVIA A.B. J A WETTERGRENS GATA 1, BOX 30053, 400 43 VÄSTRA FRÖLUNDA, SWEDEN  
YAMAHA MUSIC AUSTRALIA PTY, LTD. 17-33 MARKET ST., SOUTH MELBOURNE, 3205 VIC., AUSTRALIA

YAMAHA CORPORATION

Printed in Malaysia **UP** VIDEO V816670