

# JVC

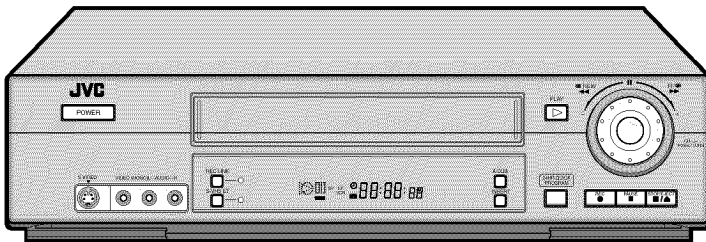

## VIDEO CASSETTE RECORDER

# HR-S5900U/5910U HR-S3900U/3910U



HR-S5900U/5910U



HR-S3900U/3910U

**S** VHS

*Hi-Fi*

**VCRplus+**<sup>®</sup>  
CABLE BOX  
CONTROL

**Super VHS ET**

## **INSTRUCTIONS**

### For Customer Use:

Enter below the Model No. and Serial No. which are located on the rear of cabinet. Retain this information for future reference.

Model No. \_\_\_\_\_

Serial No. \_\_\_\_\_

**Dear Customer,**

Thank you for purchasing the JVC S-VHS video cassette recorder. Before use, please read the safety information and precautions contained in the following pages to ensure safe use of your new VCR.

**CAUTIONS**

**CAUTION**  
RISK OF ELECTRIC SHOCK  
DO NOT OPEN



**CAUTION:** TO REDUCE THE RISK OF ELECTRIC SHOCK,  
DO NOT REMOVE COVER (OR BACK).  
NO USER-SERVICEABLE PARTS INSIDE.  
REFER SERVICING TO QUALIFIED SERVICE PERSONNEL.



The lightning flash with arrowhead symbol, within an equilateral triangle, is intended to alert the user to the presence of uninsulated "dangerous voltage" within the product's enclosure that may be of sufficient magnitude to constitute a risk of electric shock to persons.



The exclamation point within an equilateral triangle is intended to alert the user to the presence of important operating and maintenance (servicing) instructions in the literature accompanying the appliance.

**WARNING:**  
**TO PREVENT FIRE OR SHOCK HAZARD, DO NOT EXPOSE THIS UNIT TO RAIN OR MOISTURE.**

**CAUTION:**

This video cassette recorder should be used with AC 120V~, 60Hz only.  
To prevent electric shocks and fire hazards, DO NOT use any other power source.

**CAUTION:**

TO PREVENT ELECTRIC SHOCK, MATCH WIDE BLADE OF PLUG TO WIDE SLOT, FULLY INSERT.

**ATTENTION:**

POUR ÉVITER LES CHOCS ÉLECTRIQUES, INTRODUIRE LA LAME LA PLUS LARGE DE LA FICHE DANS LA BORNE CORRESPONDANTE DE LA PRISE ET POUSSER JUSQU'AU FOND.

**Note to CATV system installer:**

This reminder is provided to call the CATV system installer's attention to Article 820-40 of the NEC that provides guidelines for proper grounding and, in particular, specifies that the cable ground shall be connected to the grounding system of the building, as close to the point of cable entry as practical.

**CAUTION:**

Changes or modifications not approved by JVC could void user's authority to operate the equipment.

**Declaration of Conformity**

**Model Number** :HR-S5900U  
HR-S5910U  
HR-S3900U  
HR-S3910U  
**Trade Name** :JVC  
**Responsible Party** :JVC Americas Corp.  
**Address** :1700 Valley Road Wayne,  
N.J. 07470  
**Telephone Number** :973-315-5000

This device complies with Part 15 of FCC Rules.

Operation is subject to the following two conditions:

(1) This device may not cause harmful interference, and (2) this device must accept any interference received, including interference that may cause undesired operation.

**Failure to heed the following precautions may result in damage to the VCR, Remote or video cassette.****1. DO NOT place the VCR . . .**

- ... in an environment prone to extreme temperatures or humidity.
- ... in direct sunlight.
- ... in a dusty environment.
- ... in an environment where strong magnetic fields are generated.
- ... on a surface that is unstable or subject to vibration.

**2. DO NOT block the VCR's ventilation openings.****3. DO NOT place heavy objects on the VCR or on the Remote.****4. DO NOT place anything which might spill on the top of the VCR or on the Remote.****5. AVOID violent shocks to the VCR during transport.**

VCR Plus+, C<sup>3</sup> and PlusCode are registered trademarks of Gemstar Development Corporation.

The VCR Plus+ system is manufactured under license from Gemstar Development Corporation.



- Cassettes marked "S-VHS" and "VHS" can be used with this video cassette recorder. However, S-VHS recordings are possible only with cassettes marked "S-VHS".  
By using S-VHS ET it is possible to record and play back with S-VHS picture quality on VHS cassettes with this VCR.
- As an ENERGY STAR® Partner, JVC has determined that this product or product model meets the ENERGY STAR® guidelines for energy efficiency.

# IMPORTANT PRODUCT SAFETY INSTRUCTIONS

Electrical energy can perform many useful functions. But improper use can result in potential electrical shock or fire hazards. This product has been engineered and manufactured to assure your personal safety. In order not to defeat the built-in safeguards, observe the following basic rules for its installation, use and servicing.

## ATTENTION:

Follow and obey all warnings and instructions marked on your product and its operating instructions. For your safety, please read all the safety and operating instructions before you operate this product and keep this booklet for future reference.

## INSTALLATION

### 1. Grounding or Polarization

(A) Your product may be equipped with a polarized alternating-current line plug (a plug having one blade wider than the other). This plug will fit into the power outlet only one way. This is a safety feature.

If you are unable to insert the plug fully into the outlet, try reversing the plug. If the plug should still fail to fit, contact your electrician to replace your obsolete outlet. Do not defeat the safety purpose of the polarized plug.

(B) Your product may be equipped with a 3-wire grounding-type plug, a plug having a third (grounding) pin. This plug will only fit into a grounding-type power outlet. This is a safety feature.

If you are unable to insert the plug into the outlet, contact your electrician to replace your obsolete outlet. Do not defeat the safety purpose of the grounding-type plug.

### 2. Power Sources

Operate your product only from the type of power source indicated on the marking label. If you are not sure of the type of power supply to your home, consult your product dealer or local power company. If your product is intended to operate from battery power, or other sources, refer to the operating instructions.

### 3. Overloading

Do not overload wall outlets, extension cords, or integral convenience receptacles as this can result in a risk of fire or electric shock.

### 4. Power Cord Protection

Power supply cords should be routed so that they are not likely to be walked on or pinched by items placed upon or against them, paying particular attention to cords at plugs, convenience receptacles, and the point where they exit from the product.

### 5. Ventilation

Slots and openings in the cabinet are provided for ventilation. To ensure reliable operation of the product and to protect it from overheating, these openings must not be blocked or covered.

- Do not block the openings by placing the product on a bed, sofa, rug or other similar surface.
- Do not place the product in a built-in installation such as a bookcase or rack unless proper ventilation is provided or the manufacturer's instructions have been adhered to.

### 6. Wall or Ceiling Mounting

The product should be mounted to a wall or ceiling only as recommended by the manufacturer.

## ANTENNA INSTALLATION INSTRUCTIONS

### 1. Outdoor Antenna Grounding

If an outside antenna or cable system is connected to the product, be sure the antenna or cable system is grounded so as to provide some protection against voltage surges and built-up static charges. Article 810 of the National Electrical Code, ANSI/NFPA 70, provides information with regard to proper grounding of the mast and supporting structure, grounding of the lead-in wire to an antenna discharge unit, size of grounding connectors, location of antenna discharge unit, connection to grounding electrodes, and requirements for the grounding electrode.

### 2. Lightning

For added protection for this product during a lightning storm, or when it is left unattended and unused for long periods of time, unplug it from the wall outlet and disconnect the antenna or cable system. This will prevent damage to the product due to lightning and power-line surges.

### 3. Power Lines

An outside antenna system should not be located in the vicinity of overhead power lines or other electric light or power circuits, or where it can fall into such power lines or circuits. When installing an outside antenna system, extreme care should be taken to keep from touching such power lines or circuits as contact with them might be fatal.

EXAMPLE OF ANTENNA GROUNDING AS PER NATIONAL ELECTRICAL CODE, ANSI/NFPA 70

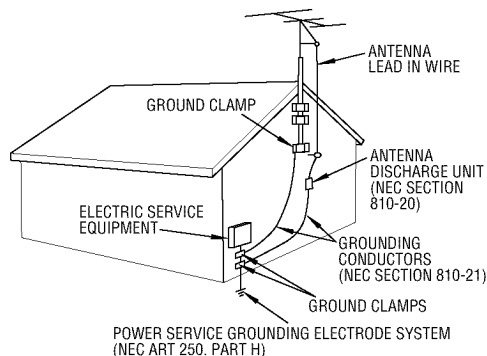

NEC – NATIONAL ELECTRICAL CODE

## USE

### 1. Accessories

To avoid personal injury:

- Do not place this product on an unstable cart, stand, tripod, bracket, or table. It may fall, causing serious injury to a child or adult, and serious damage to the product.
- Use only with a cart, stand, tripod, bracket, or table recommended by the manufacturer or sold with the product.
- Use a mounting accessory recommended by the manufacturer and follow the manufacturer's instructions for any mounting of the product.
- Do not try to roll a cart with small casters across thresholds or deep-pile carpets.

### 2. Product and Cart Combination

A product and cart combination should be moved with care. Quick stops, excessive force, and uneven surfaces may cause the product and cart combination to overturn.

PORTABLE CART WARNING  
(Symbol provided by RETAC)



### 3. Water and Moisture

Do not use this product near water—for example, near a bath tub, wash bowl, kitchen sink or laundry tub, in a wet basement, or near a swimming pool and the like.

### 4. Object and Liquid Entry

Never push objects of any kind into this product through openings as they may touch dangerous voltage points or short-out parts that could result in a fire or electric shock. Never spill liquid of any kind on the product.

### 5. Attachments

Do not use attachments not recommended by the manufacturer of this product as they may cause hazards.

### 6. Cleaning

Unplug this product from the wall outlet before cleaning. Do not use liquid cleaners or aerosol cleaners. Use a damp cloth for cleaning.

### 7. Heat

The product should be situated away from heat sources such as radiators, heat registers, stoves, or other products (including amplifiers) that produce heat.

## SERVICING

### 1. Servicing

If your product is not operating correctly or exhibits a marked change in performance and you are unable to restore normal operation by following the detailed procedure in its operating instructions, do not attempt to service it yourself as opening or removing covers may expose you to dangerous voltage or other hazards. Refer all servicing to qualified service personnel.

### 2. Damage Requiring Service

Unplug this product from the wall outlet and refer servicing to qualified service personnel under the following conditions:

- When the power supply cord or plug is damaged.
- If liquid has been spilled, or objects have fallen into the product.
- If the product has been exposed to rain or water.
- If the product does not operate normally by following the operating instructions. Adjust only those controls that are covered by the operating instructions as an improper adjustment of other controls may result in damage and will often require extensive work by a qualified technician to restore the product to its normal operation.
- If the product has been dropped or damaged in any way.
- When the product exhibits a distinct change in performance—this indicates a need for service.

### 3. Replacement Parts

When replacement parts are required, be sure the service technician has used replacement parts specified by the manufacturer or which have the same characteristics as the original part. Unauthorized substitutions may result in fire, electric shock or other hazards.

### 4. Safety Check

Upon completion of any service or repairs to this product, ask the service technician to perform safety checks to determine that the product is in safe operating condition.

## HOW TO USE THIS INSTRUCTION MANUAL

- The Index on pages 60 – 64 lists frequently-used terms, and the number of the page on which they are used or explained in the manual. This section also illustrates the controls and connections on the front and rear panel, the front display panel and the Remote.
- The  mark signals a reference to another page for instructions or related information.
- Operation buttons necessary for the various procedures are clearly indicated through the use of illustrations at the beginning of each major section.
- **The illustrations used in this instruction manual is of HR-S5900U/5910U, unless mentioned otherwise.**

## BEFORE YOU INSTALL YOUR NEW VCR . . .

. . . please read the sections/literature listed below.

- "CAUTIONS" on page 2
- "IMPORTANT PRODUCT SAFETY INSTRUCTIONS" on the previous page

<b>INSTALLING YOUR NEW VCR</b>	<b>6</b>	<b>SPECIAL EFFECT PLAYBACK</b>	<b>28</b>
<b>Basic Connections</b> .....	<b>6</b>	<b>Special Effect Playback</b> .....	<b>28</b>
<b>INITIAL SETTINGS</b>	<b>8</b>	Locating particular scene rapidly	
<b>Plug &amp; Play Setting</b> .....	<b>8</b>	— Picture Search .....	28
Auto Clock Set/Auto Tuner Set .....	8	Viewing still picture — Still Picture Playback .....	29
<b>Language Setting</b> .....	<b>9</b>	Skipping unwanted portions — Skip Search .....	29
<b>Clock Setting</b> .....	<b>10</b>	Viewing still picture frame by frame	
Preparations .....	10	— Frame-by-Frame Playback .....	29
Setting clock semiautomatically		Viewing slow motion picture	
— Semiauto Clock Set .....	11	— Slow Motion Playback .....	29
Setting clock manually		<b>TIMER RECORDING</b>	<b>30</b>
— Manual Clock Set .....	12	<b>VCR Plus+® Timer Programing</b> .....	<b>30</b>
<b>Tuner Setting</b> .....	<b>13</b>	<b>Changing VCR Plus+® Setting</b> .....	<b>32</b>
Setting channels automatically		<b>Express Timer Programing</b> .....	<b>34</b>
— Auto Channel Set .....	13	<b>24HR Quick Programing</b> .....	<b>36</b>
Setting channels manually		Checking program settings .....	37
— Manual Channel Set .....	14	Canceling or changing program settings .....	37
<b>Cable Box Control Setting</b> .....	<b>15</b>	When programs overlap each other .....	38
Installing Controller .....	15	<b>OTHER USEFUL FUNCTIONS</b>	<b>39</b>
Setting cable box output channel & brand .....	16	<b>Useful Function Settings</b> .....	<b>39</b>
<b>DBS Receiver Control Setting</b> .....	<b>18</b>	<b>Satellite Auto Recording</b> .....	<b>44</b>
Installing Controller .....	18	<b>Child Lock</b> .....	<b>45</b>
Setting DBS receiver output channel & brand .....	19	<b>EDITING</b>	<b>46</b>
<b>BASIC PLAYBACK AND RECORDING</b>	<b>21</b>	<b>Edit From Camcorder</b> .....	<b>46</b>
<b>Basic Playback</b> .....	<b>21</b>	<b>Edit To Or From Another VCR</b> .....	<b>48</b>
To stop playback .....	21	<b>Audio Dubbing</b>	
To rewind the tape .....	21	<b>(ONLY FOR HR-S5900U/5910U)</b> .....	<b>49</b>
To fast-forward the tape .....	21	<b>Insert Editing and AV Dubbing</b>	
To eject the tape .....	21	<b>(ONLY FOR HR-S5900U/5910U)</b> .....	<b>50</b>
To turn off the VCR .....	21	<b>MULTI-BRAND REMOTE CONTROL</b>	<b>52</b>
<b>Basic Playback Features</b> .....	<b>22</b>	<b>TV Brand Setting</b> .....	<b>52</b>
Changing display information .....	22	<b>Cable Box Brand Setting</b> .....	<b>53</b>
Checking tape position .....	22	<b>DBS Receiver Brand Setting</b> .....	<b>54</b>
Playing back tape repeatedly — Repeat Play .....	22	<b>Changing Remote Control Code</b> .....	<b>55</b>
Adjusting tracking condition		<b>TROUBLESHOOTING</b>	<b>56</b>
— Tracking Adjustments .....	23	Questions and answers .....	59
Selecting monitor sound — Audio Monitor .....	23	<b>INDEX</b>	<b>60</b>
Automatic operations after rewinding		List of terms .....	60
— Next Function Memory .....	23	Front panel (HR-S5900U/5910U) .....	61
Locating beginning of recordings		Front panel (HR-S3900U/3910U) .....	61
— Index Search .....	24	Front display panel .....	62
Locating beginning of timer recordings		Rear panel .....	63
— Instant Review .....	24	On-screen display .....	63
<b>Basic Recording</b> .....	<b>25</b>	Remote .....	64
To pause recording .....	25	<b>SPECIFICATIONS</b>	<b>65</b>
To stop recording .....	25	<b>FOR SERVICING (Only in U.S.A.)</b>	<b>66</b>
To rewind the tape (when it is not running) .....	25	<b>WARRANTY (Only in U.S.A.)</b>	<b>67</b>
To fast-forward the tape (when it is not running) .....	25		
To eject the tape .....	25		
To turn off the VCR .....	25		
<b>Basic Recording Features</b> .....	<b>26</b>		
Changing display information .....	26		
Specifying recording length			
— Instant Timer Recording (ITR) .....	26		
Watching one program while recording another .....	26		
Showing on-screen display .....	27		
Recording on VHS tapes with S-VHS quality			
— Super VHS ET .....	27		

# Basic Connections

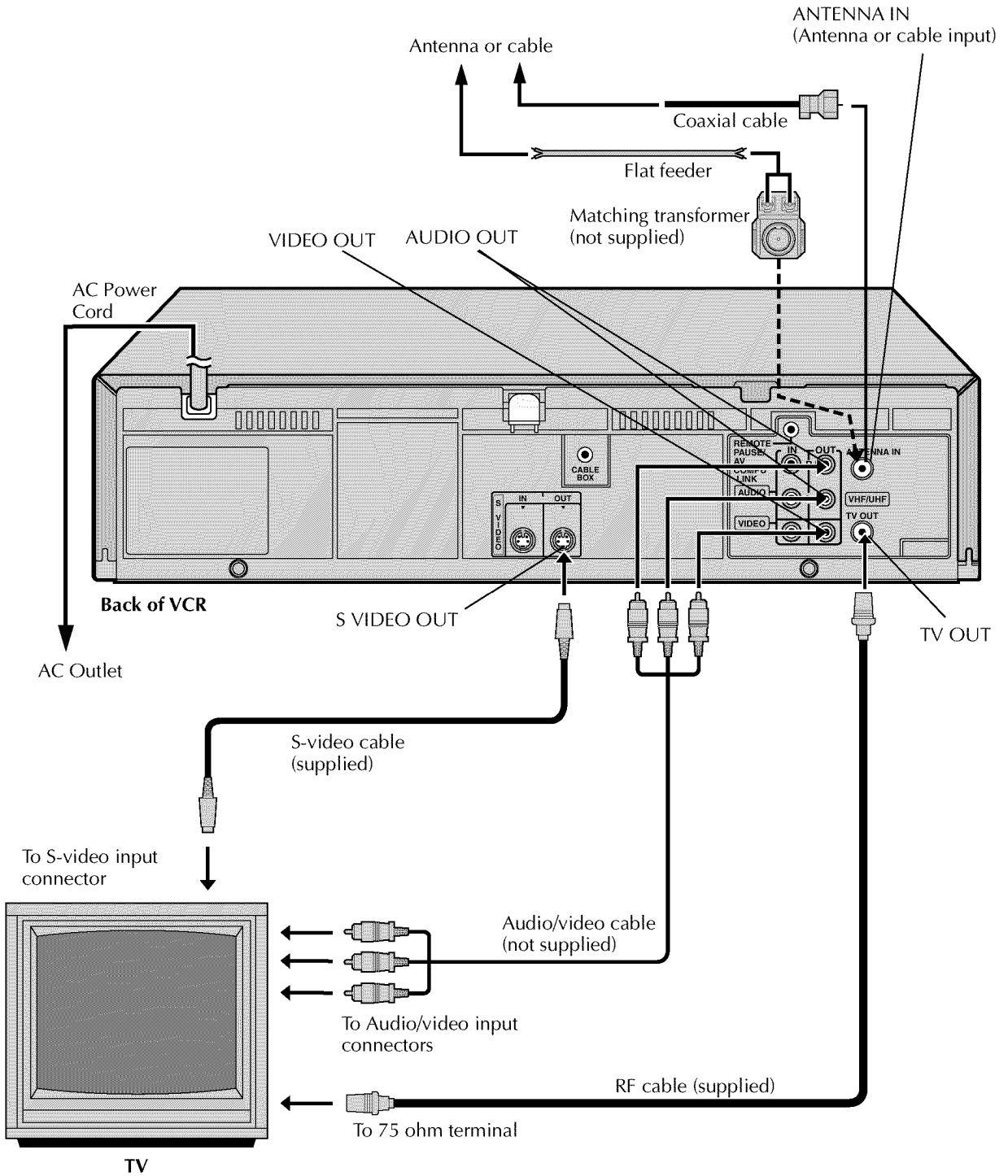

## 1 Check contents

Make sure the package contains all of the accessories listed in "SPECIFICATIONS" (☞ pg. 65).

## 2 Situate VCR

Place the VCR on a stable, horizontal surface.

## 3 Connect VCR to TV

The following connections are required.

### RF Connection

- ❶ Disconnect the TV antenna from the TV.
- ❷ Connect the TV antenna cable to the ANTENNA IN terminal on the rear of the VCR.
- ❸ Connect the supplied RF cable between the TV OUT terminal on the rear of the VCR and the TV's antenna input terminal.

**AV Connection** (improves picture quality during tape playback.)

*If your TV is equipped with audio/video input connectors*

- ❶ Connect the antenna, VCR and TV as shown in the illustration.
- ❷ Connect an audio/video cable between the AUDIO/VIDEO OUT connectors on the rear of the VCR and the audio/video input connectors on the TV.

**S-video Connection** (allows you to make the most of the S-VHS picture performance.)

*If your TV is equipped with an S-video input connector*

- ❶ Perform "RF Connection" and "AV Connection" above.
- ❷ Connect an S-video cable between the S VIDEO OUT connector on the rear of the VCR and the S-video input connector on the TV.

## 4 Connect VCR to power source

Connect the AC power plug to an AC outlet.

- The clock and tuner channels will automatically be set when the antenna is connected and when the AC power cord is first connected to an AC power outlet (☞ pg. 8). (If "Auto" or "CH" is displayed on the front display panel before the VCR is turned on, the clock and tuner channels are being set automatically. Wait until the clock time is displayed on the front display panel before turning on the VCR.)

## 5 Set VCR channel

Press **POWER** to turn off the VCR and press **STOP/EJECT** (■/▲) on the front panel for more than 5 seconds. "3CH" appears on the display panel. Press **CH +** and **-** on the Remote to select "3CH" or "4CH" for only RF connection, "-CH" (OFF) for RF and AV connection, then press **OK**.

- The VCR channel is preset to 3CH. Set to 4CH if 3CH is used for broadcasting in your area. (To view the picture from this VCR through this channel, select the same channel on the TV with the VCR channel setting on the VCR.)
- You can now perform basic playback (☞ pg. 21) or basic recording (☞ pg. 25).

### NOTES:

- *The VCR channel is the channel on which you can watch the picture from the VCR on the TV when only using the RF connection.*
- *Even if you are using audio/video cables to connect your VCR to your TV, you must also connect it using the RF cable. This will ensure that you can record one show while watching another (☞ pg. 26).*
- *For full identification of the VCR's rear panel, refer to the Index (☞ pg. 63).*

# Plug & Play Setting

## Auto Clock Set/Auto Tuner Set

### ATTENTION

- If you use a cable box, Plug & Play will not function; set the clock and tuner channels separately. (☞ pg.10 – 14)
- It takes several minutes for the VCR to complete the Plug & Play setting.
- Do not press any buttons on the front panel or on the Remote while Plug & Play is in progress.

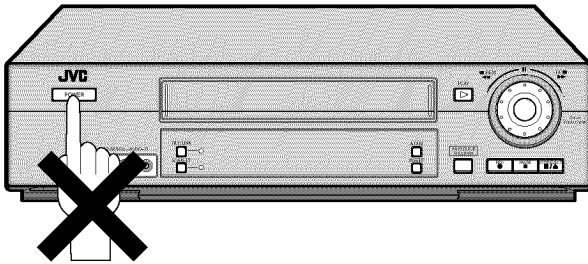

### 1 Perform Plug & Play setup

**Connect the antenna cable to the VCR (☞ pg. 6). Then connect the AC power cord to an AC outlet. Do not turn on the VCR.**

The clock and tuner channels will be set automatically.

### NOTES:

- *Auto Clock Set is performed first. "Auto" blinks on the front display panel during Auto Clock Set.*
- *Auto Channel Set is performed next. Auto Channel Set scans all the channels that are receivable by your VCR. During Auto Channel Set, the channel numbers are displayed as they are scanned and set.*
- *When Plug & Play setting has been complete successfully, the correct clock time is displayed. If you perform Plug & Play setting successfully, there is no need to perform the clock (☞ pg. 10) and tuner (☞ pg. 13) settings. If, however, you want to add or delete channels, refer to Manual Channel Set on page 14.*

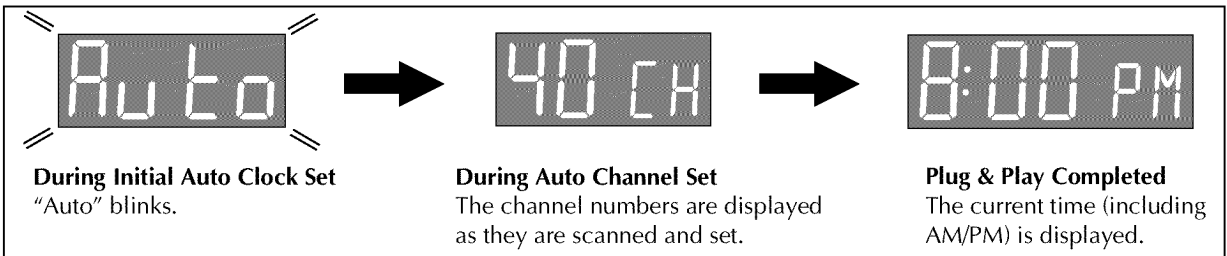

\* If an incorrect clock time or "--:--" appears on the display panel, see "What to do if Plug & Play setting failed" below.

### INFORMATION

- If "AUTO CLOCK" is set to "ON" on the Clock Set screen on page 11, the clock will be adjusted automatically by the host channel every hour (except 11:00 PM, midnight, 1:00 AM and 2:00 AM) using the incoming PBS channel clock setting data. (This automatic clock adjustment can only be performed when the VCR is turned off. The clock will be adjusted just on these hours — on the time displayed on the front display panel, not on the actual real time.) The default setting of "AUTO CLOCK" is "ON".
- If the memory backup fails, because a power outage occurs or because the AC power cord is unplugged, Plug & Play will be performed when power is restored to the VCR.
- Poor antenna or cable signal may prevent the VCR from receiving the Auto clock setting data from the PBS channel. If this function is taking a considerable amount of time, it may be necessary to perform the Semiauto or Manual Clock Set procedure.

### What to do if Plug & Play setting failed

- If an incorrect time is displayed on the front display panel, you may be receiving the clock setting data of a PBS channel from an adjacent time zone, or an incorrect PBS channel from a cable TV system. In this case, perform the Semiauto (☞ pg. 11) or Manual Clock Set (☞ pg. 12) procedure.
- If "--:--" appears on the front display panel, your antenna cable may not be connected to the VCR or there may not be a Host PBS signal available in your area. Ensure that the antenna cable is connected correctly. Then turn on and off the VCR; the Plug & Play setting will be automatically reactivated. If Plug & Play setting is not performed though the antenna cable is connected correctly, perform Manual Clock Set (☞ pg. 12) and Auto Channel Set or Manual Channel Set (☞ pg. 13 or 14).



# Language Setting

Turn on the VCR and the TV, and select the VCR channel 3 or 4 (or AV mode) on the TV.

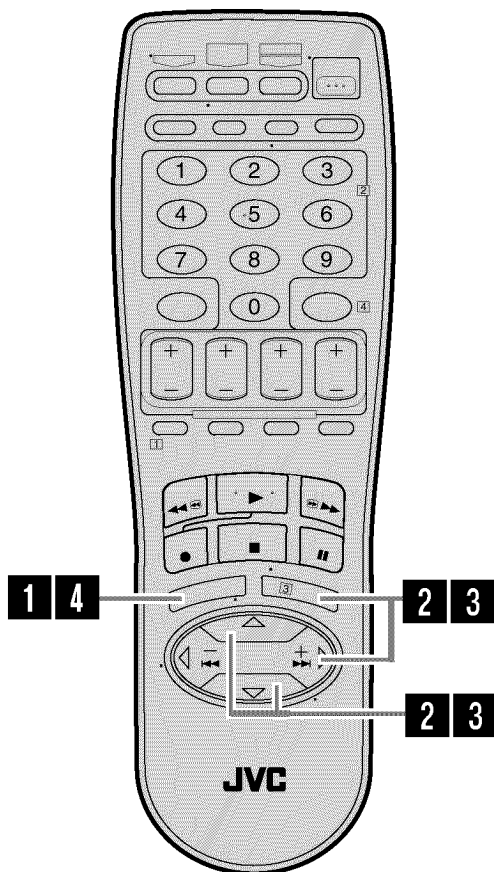

This VCR offers you the language choice to view menus and some messages (excluding the on-screen display superimposed on the TV screen) — in English, Spanish or French.

Select the desired language using the following procedure. The default setting is “ENGLISH”.

## 1 Access Main Menu screen

Press **MENU**.

## 2 Access Initial Set screen

Press **SHUTTLE PLUS**  $\Delta \nabla$  to move the highlight bar (arrow) to “INITIAL SET”, then press **OK** or **SHUTTLE PLUS**  $\triangleright$ .

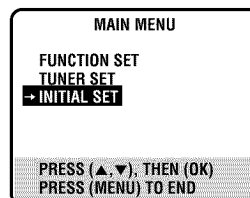

## 3 Select language

Press **SHUTTLE PLUS**  $\Delta \nabla$  to move the highlight bar (arrow) to “LANGUAGE”, then press **OK** or **SHUTTLE PLUS**  $\triangleright$  repeatedly until the desired language is selected.

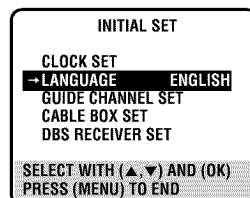

## 4 Return to normal screen

Press **MENU**.

# Clock Setting

Turn on the VCR and the TV, and select the VCR channel 3 or 4 (or AV mode) on the TV.

Perform clock setting only if the clock has not been set correctly by the Plug & Play setting or if you use a cable box.

Access the Clock Set screen to perform the Semiauto or Manual Clock Set. Each procedure starts from step 4 after preparation steps below are finished.

If you use a cable box, set the clock manually. (→ pg. 12)

## Preparations

### 1 Access Main Menu screen

Press **MENU**.

### 2 Access Initial Set screen

Press **SHUTTLE PLUS**  $\Delta \nabla$  to move the highlight bar (arrow) to "INITIAL SET", then press **OK** or **SHUTTLE PLUS**  $\triangleright$ .

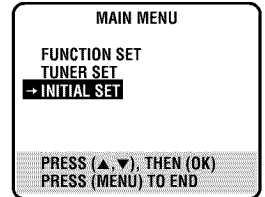

### 3 Select clock set

Press **SHUTTLE PLUS**  $\Delta \nabla$  to move the highlight bar (arrow) to "CLOCK SET", then press **OK** or **SHUTTLE PLUS**  $\triangleright$ .

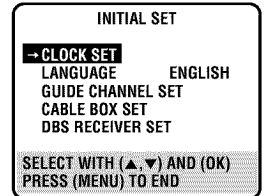

- "CABLE BOX USERS SET CLOCK MANUALLY" appears on the screen for about 5 seconds, then the Clock Set screen appears.

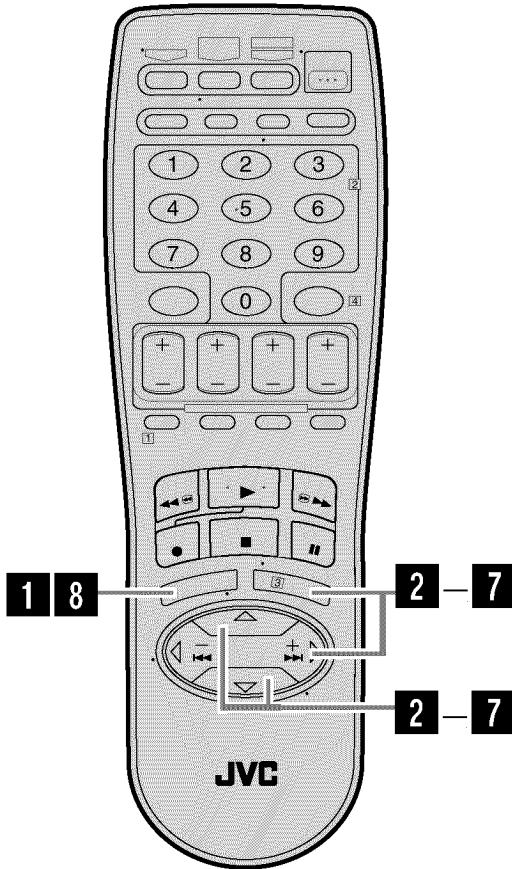

## Setting clock semiautomatically

### — Semiauto Clock Set

You can change the host channel/D.S.T./time zone setting manually.

First follow steps **1** to **3** on page 10, then go to the following steps.

#### 4 Set Auto Clock to ON

Press **SHUTTLE PLUS**  $\triangleright$  to move the highlight bar to "AUTO CLOCK", then press **SHUTTLE PLUS**  $\Delta\nabla$  so that "ON" is selected.

Then;

To select the host channel — go to step **5**.

To select the D.S.T. mode — go to step **6**.

To select the time zone — go to step **7**.

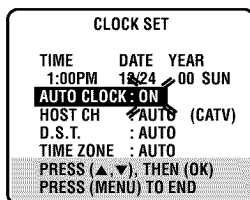

#### NOTE:

The time set previously will be erased when "AUTO CLOCK", "HOST CH", "D.S.T." or "TIME ZONE" setting is changed.

#### 5 Select host channel

You can either select "AUTO" or enter a PBS channel number.

Press **SHUTTLE PLUS**  $\triangleright$  to move the highlight bar to "HOST CH", then press **SHUTTLE PLUS**  $\Delta\nabla$  until "AUTO" or the desired PBS channel number is selected.

#### NOTE:

Some PBS channels do not transmit clock setting data.

#### 6 Select D.S.T. mode

You have three choices:

**AUTO**— Select if you want to adjust your VCR's clock automatically by the incoming signal from the host channel. (Auto Daylight Saving Time\*)

**ON**— Adjustment will be made by the built-in clock itself.

**OFF**— Select when Daylight Saving Time does not apply to you.

Press **SHUTTLE PLUS**  $\triangleright$  to move the highlight bar to "D.S.T.", then press **SHUTTLE PLUS**  $\Delta\nabla$  repeatedly until the desired setting is selected.

#### 7 Select time zone

You can select the time zone automatically or manually.

Press **SHUTTLE PLUS**  $\triangleright$  to move the highlight bar to "TIME ZONE", press **SHUTTLE PLUS**  $\Delta\nabla$  repeatedly until "AUTO" or the desired time zone is selected.

Each time you press the button, the time zone changes as follows:

→ AUTO → ATLANTIC → EASTERN

→ CENTRAL → MOUNTAIN → PACIFIC

→ ALASKA → HAWAII → (back to the beginning)

#### NOTE:

If an incorrect clock time is displayed by the Plug & Play setting, you may be receiving the clock setting data of a PBS channel from an adjacent time zone or from an incorrect PBS channel from a cable TV system. If you selected "AUTO" for the host channel in step **5**, be sure to select the correct time zone manually.

#### 8 Return to normal screen

Press **MENU**.

#### \* Auto Daylight Saving Time

This function enables automatic adjustment of the VCR's clock at the start and end of Daylight Saving Time.

With Auto DST activated, . . .

. . . on the first Sunday of April at 2:00 AM, the clock is adjusted to 3:00 AM.

. . . on the last Sunday of October at 2:00 AM, the clock is adjusted to 1:00 AM.

#### IMPORTANT

Turn off the VCR after performing Semiauto Clock Set. "Auto" will appear on the front display panel while the clock is being set. The current clock time will appear automatically when the clock setting is complete.

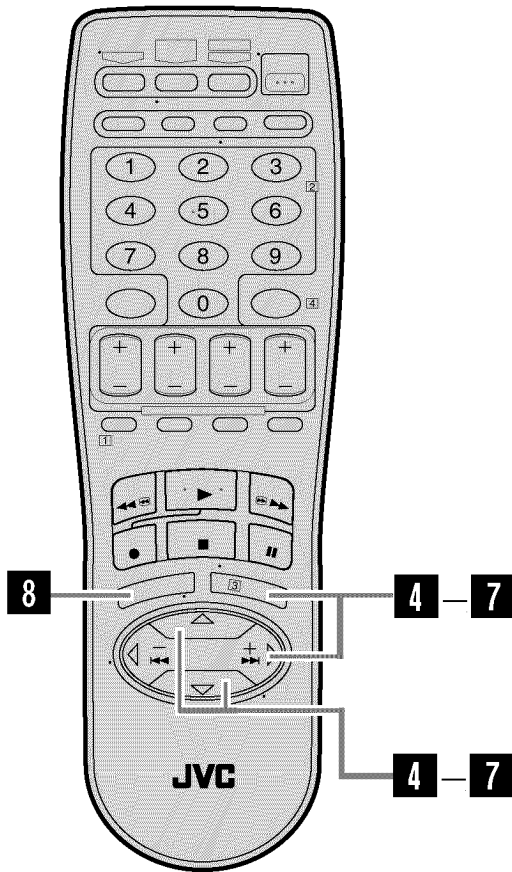

## 5 Set date

Press **SHUTTLE PLUS**  $\Delta\nabla$  until the desired date appears, then press **OK** or **SHUTTLE PLUS**  $\triangleright$ .

- Holding **SHUTTLE PLUS**  $\Delta\nabla$  changes the date in 15-day intervals.

## 6 Set year

Press **SHUTTLE PLUS**  $\Delta\nabla$  until the desired year appears, then press **OK** or **SHUTTLE PLUS**  $\triangleright$  twice.

## 7 Select D.S.T. mode

You can select either "ON" or "OFF".

**ON**— Adjustment will be made by the built-in clock itself.

**OFF**— Select when Daylight Saving Time does not apply to you.

Press **SHUTTLE PLUS**  $\Delta\nabla$  to select the desired setting.

## 8 Start clock

Press **MENU** and normal screen appears.

### To make corrections any time during the process

Press **OK** or **SHUTTLE PLUS**  $\triangleright$  repeatedly until the item you want to change blinks, then press **SHUTTLE PLUS**  $\Delta\nabla$ .

## Setting clock manually

### — Manual Clock Set

First follow steps **1** to **3** on page 10, then go to the following steps.

## 4 Set time

Press **SHUTTLE PLUS**  $\Delta\nabla$  until the desired time appears, then press **OK** or **SHUTTLE PLUS**  $\triangleright$ .

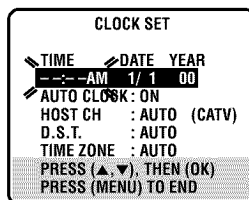

- Holding **SHUTTLE PLUS**  $\Delta\nabla$  changes the time in 30-minute intervals.
- When the time is entered manually, "AUTO CLOCK" is automatically set to "OFF", and "HOST CH" and "TIME ZONE" disappear.

# Tuner Setting

Turn on the VCR and the TV, and select the VCR channel 3 or 4 (or AV mode) on the TV.

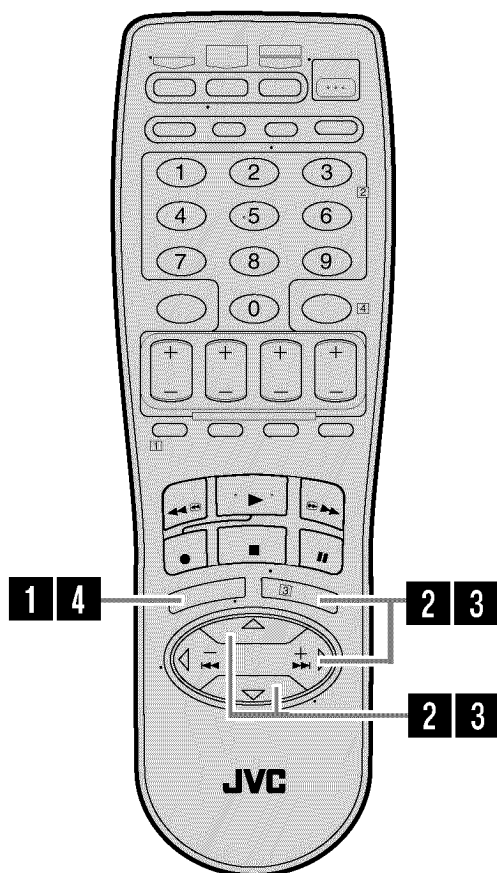

## Setting channels automatically — Auto Channel Set

Use Auto Channel Set only if channels have not been set correctly by the Plug & Play setting. If you want to add or delete channels, use Manual Channel Set (pg. 14).

### 1 Access Main Menu screen

Press **MENU**.

### 2 Access Tuner Set screen

Press **SHUTTLE PLUS**  $\Delta \nabla$  to move the highlight bar (arrow) to "TUNER SET", then press **OK** or **SHUTTLE PLUS**  $\triangleright$ .

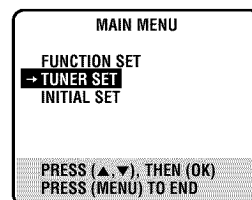

### 3 Perform Auto Channel Set

You can automatically set the receivable channels in your area in the order of their frequencies.

Press **SHUTTLE PLUS**  $\Delta \nabla$  to move the highlight bar (arrow) to "AUTO CHANNEL SET", then press **OK** or **SHUTTLE PLUS**  $\triangleright$ .

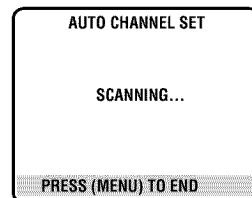
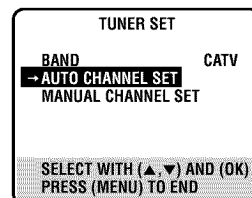

### NOTES:

- When Auto Channel Set is complete, "SCAN COMPLETED" appears on screen.
- If the scan was unsuccessful, "SCAN COMPLETED—NO SIGNAL" appears on screen. Check the connections and start again.

### 4 Return to normal screen

Press **MENU**.

### INFORMATION

The VCR selects the correct band (TV or CATV) automatically during Auto Channel Set. The selected band will be displayed on the right side of "BAND" on the Tuner Set screen.

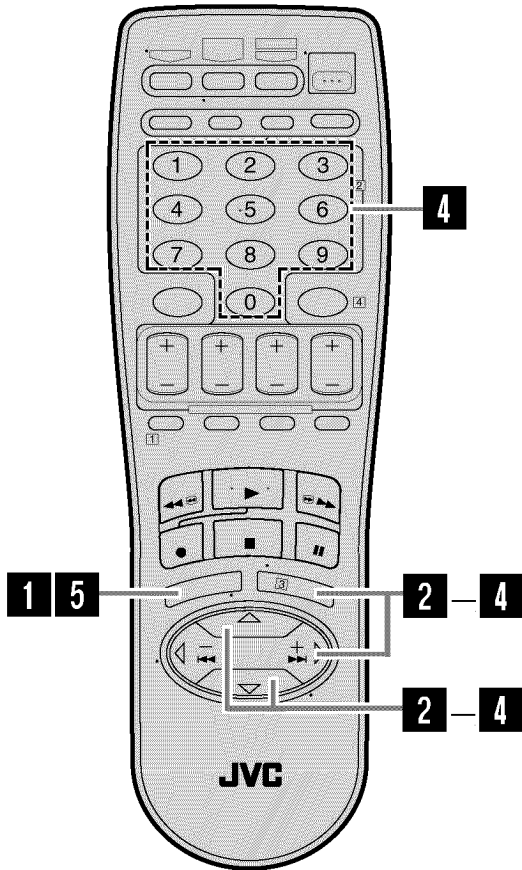

## Setting channels manually

### — Manual Channel Set

You can add the channels you want or delete the channels you do not want manually.

#### 1 Access Main Menu screen

Press MENU.

#### 2 Access Tuner Set screen

Press SHUTTLE PLUS  $\Delta \nabla$  to move the highlight bar (arrow) to "TUNER SET", then press OK or SHUTTLE PLUS  $\triangleright$ .

#### 3 Access Manual Channel Set screen

Press SHUTTLE PLUS  $\Delta \nabla$  to move the highlight bar (arrow) to "MANUAL CHANNEL SET", then press OK or SHUTTLE PLUS  $\triangleright$ .

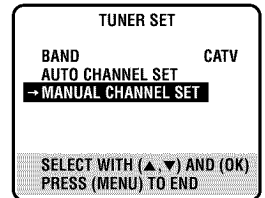

#### 4 Add or skip desired channels

##### To add channels

- 1 Press the **Number** keys to input a channel number you want to add.
- 2 Press OK or SHUTTLE PLUS  $\triangleright$  to set to "ADD".
- 3 Repeat 1 and 2 to add other channels.

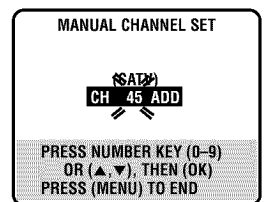

##### To skip channels

- 1 Press the **Number** keys or SHUTTLE PLUS  $\Delta \nabla$  to input a channel number you want to skip.
- 2 Press OK or SHUTTLE PLUS  $\triangleright$  to set to "SKIP".
- 3 Repeat 1 and 2 to skip other channels.

#### 5 Return to normal screen

Press MENU.

# Cable Box Control Setting

## Suggested location

Place the cable box on top of the VCR. Attach the VCR's Controller to the top of the VCR with the Controller's transmitter pointed towards the cable box's remote sensor.

## ATTENTION:

The Controller can also control a DBS receiver. If both a cable box and a DBS receiver are used, position the Controller so its signal reaches the remote sensors on both the cable box and DBS receiver.

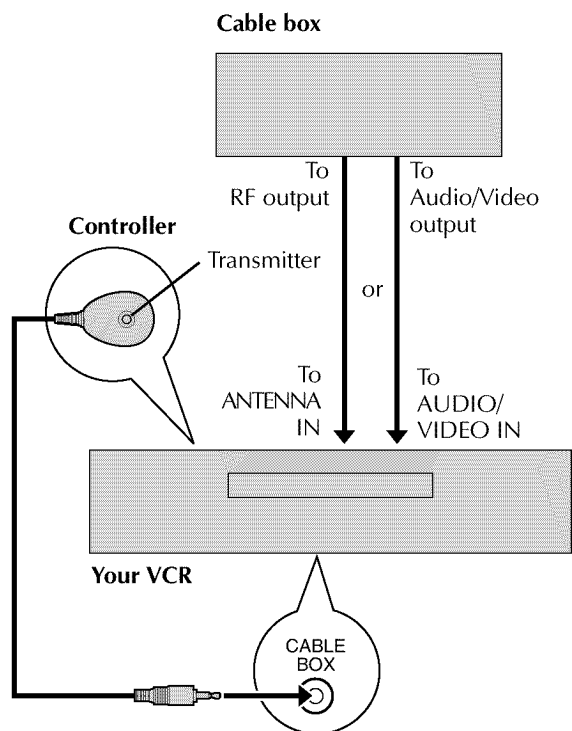
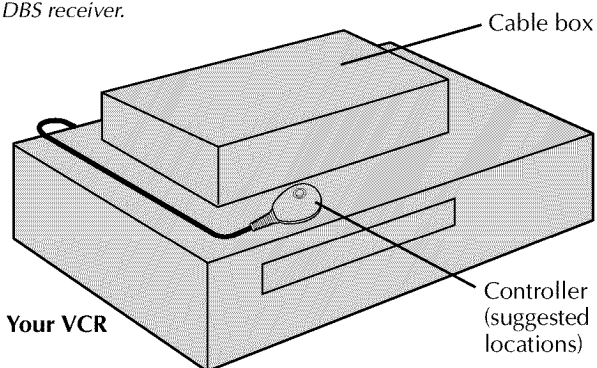

The following procedure is required if you receive your TV channels through a cable box (descrambler). The Controller allows the VCR to automatically switch the cable box channel during timer recording. The Controller is effective for recording broadcasts that have been programmed using VCR Plus+ (➤ pg. 30), Express timer programming (➤ pg. 34) or 24HR quick programming (➤ pg. 36).

## NOTE:

The Controller is not supplied with this unit. It can be requested by mailing in the completed JVC Cable Mouse Certificate that is included with the accessory package.

## Installing Controller

### 1 Situate Controller

Place the Controller so that its transmitter is facing the cable box's remote sensor.

- Make sure the path between the Controller and the cable box's remote sensor is not blocked.

### 2 Attach Controller

Fix securely using the adhesive strip attached on the back of the Controller.

### 3 Connect cable box to VCR

- **If your cable box does not have audio/video output connectors**  
Connect the RF output terminal on the cable box to the ANTENNA IN terminal on the rear of your VCR.
- **If your cable box has audio/video output connectors**  
Connect an audio/video cable between the AUDIO/VIDEO IN connectors on the rear of the VCR and the audio/video output connectors on the cable box.

## NOTE:

When connecting your cable box, refer to its instruction manual.

### 4 Connect Controller to VCR

Connect the Controller to the CABLE BOX Controller connector on the rear panel.

#### How to control the cable box

This VCR has two separate methods to control your cable box.

- The VCR's wireless Remote can control your cable box. This eliminates the need for a separate cable box's Remote.
- The VCR's Controller can also control your cable box. This allows the VCR to change your cable box's channel number during timer recording.

Each method must be set up separately. To set up the VCR's Remote, refer to page 53. To set up the Controller, go to page 16.

Turn on the VCR and the TV, and select the VCR channel 3 or 4 (or AV mode) on the TV.

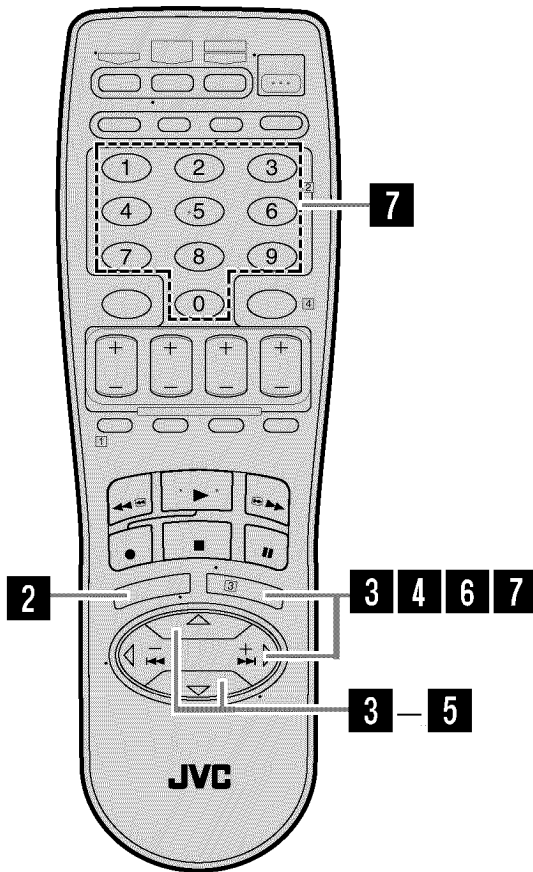

## Setting cable box output channel & brand

After installation, set the cable box output's channel and its brand correctly; otherwise, the Controller cannot work correctly.

### 1 Turn on cable box

Select a channel other than channel 9 on your cable box.

### 2 Access Main Menu screen on VCR

Press **MENU**.

### 3 Access Initial Set screen

Press **SHUTTLE PLUS**  $\Delta\nabla$  to move the highlight bar (arrow) to "INITIAL SET", then press **OK** or **SHUTTLE PLUS**  $\triangleright$ .

### 4 Access Cable Box Set screen

Press **SHUTTLE PLUS**  $\Delta\nabla$  to move the highlight bar (arrow) to "CABLE BOX SET", then press **OK** or **SHUTTLE PLUS**  $\triangleright$ .

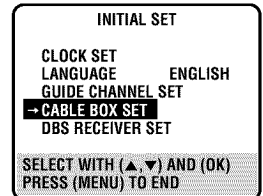

### 5 Select cable box output channel

Your selection depends on how your cable box is connected to your VCR.

- If your cable box is connected to your VCR's ANTENNA IN terminal on the rear**  
 Press **SHUTTLE PLUS**  $\Delta\nabla$  on the Remote until the channel number representing the cable box's output (CH2 – CH9) appears on the screen.
- If your cable box is connected to your VCR's AUDIO/VIDEO IN connectors on the front panel**  
 Press **SHUTTLE PLUS**  $\Delta\nabla$  on the Remote until "ON F-1 (FRONT)" appears on the screen.
- If your cable box is connected to your VCR's AUDIO/VIDEO IN connectors on the rear panel**  
 Press **SHUTTLE PLUS**  $\Delta\nabla$  on the Remote until "ON L-1 (REAR)" appears on the screen.
- If you do not use a cable box**  
 Press **SHUTTLE PLUS**  $\Delta\nabla$  on the Remote until "OFF" appears on the screen.

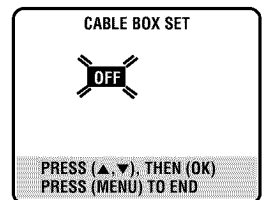



**6 Access Cable Box Brand Set screen**

Press **OK**.

**7 Enter cable box brand**

Press the appropriate **Number** keys to enter the brand code from the list shown to the right, then press **OK**.

● **If the cable box's channel changes to 9, setting is complete**

Press **OK** and "CABLE BOX CONTROL IS ON" appears on the screen for about 5 seconds, then it returns to the normal screen.

● **If the cable box's channel does not change to 9**

- ① Press **SHUTTLE PLUS**  $\Delta\nabla$  to move the highlight bar (arrow) to "NO".
- ② Press **OK**.
- ③ Repeat step ⑦ until the cable box's channel changes to 9 by entering another code.
- ④ If the channel does not change after going through all the code numbers listed for your model of cable box, then try all the other numbers between 1 and 25.

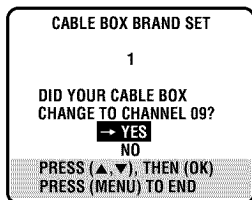
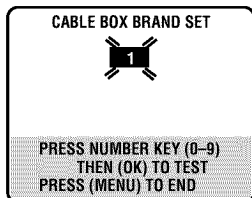
**CABLE BOX BRAND LIST**

BRAND	CODE
ARCHER	1, 5, 17
CABLETENNA	1, 17
CABLEVIEW	15, 16, 17, 21, 25
CITIZEN	15, 16, 17, 21, 25
CURTIS	2, 8
DIAMOND	1, 17
EASTERN	19
GC BRAND	15, 16, 17, 21, 25
GEMINI	15
GENERAL INSTRUMENTS	1, 4, 6, 11, 12, 15, 28
HAMLIN	10, 18, 19, 23
JASCO	15
JERROLD	1, 4, 6, 11, 12, 15, 28
NOVAVISION	2, 8
OAK	7, 20
PANASONIC	13, 14
PULSER	15, 16, 17, 21, 25
RCA	13, 14
REGAL	10, 18, 19, 23
REGENCY	19
REMBRANDT	1, 16, 17
SAMSUNG	5, 16, 24
SCIENTIFIC ATLANTA	2, 8
SIGMA	7, 20
SL MARX	5, 16, 17, 24, 25
SPRUCER	13, 14
STARGATE	5, 15, 16, 17, 21, 24, 25
TELEVIEW	5, 16, 24
TOCOM	1, 4, 16
UNIKA	1, 17
UNIVERSAL	16, 17, 25
VIDEOWAY	3, 9, 22
ZENITH	3, 9, 22

**If the VCR's clock has not been set (with AUTO CLOCK set to ON)**

"CABLE BOX USERS SET CLOCK MANUALLY" appears for about 5 seconds when you press **OK** in step ⑥, then the Clock Set screen appears.

Perform Manual Clock Set on page 12. If you press **MENU** after the clock has been set, the Cable Box Brand Set screen appears.

**NOTES:**

- The Controller may not work with all types of cable box.
- If your cable box does not respond to any code between 1 and 25, you cannot use the Controller to change cable box channels. In this case, make sure to leave the cable box turned on and tuned to the proper channel before the scheduled start time of timer recording. Contact your cable company about the possibility of exchanging your current cable box with the one compatible with your VCR.
- The VCR can only change the cable box channel through the Controller during timer recording.
- If your cable box cannot be operated with a remote control (because it has no remote sensor), you cannot use the Controller to change its channels. Make sure to leave the cable box turned on and tuned to the proper channel before the scheduled start time of timer recording.
- If the VCR's memory backup expires because of a power failure, set the cable box output channel and brand again.
- **For customers in U.S.A.:** If you are unable to set the Controller, contact JVC toll free at 1-800-537-5722.

# DBS Receiver Control Setting

## Suggested location

Place the DBS (Direct Broadcast Satellite) receiver on top of the VCR. Attach the VCR's Controller to the top of the VCR with the Controller's transmitter pointed towards the DBS receiver's remote sensor.

## ATTENTION:

The Controller can also control a cable box. If both a DBS receiver and a cable box are used, position the Controller so its signal reaches the remote sensors on both the DBS receiver and cable box.

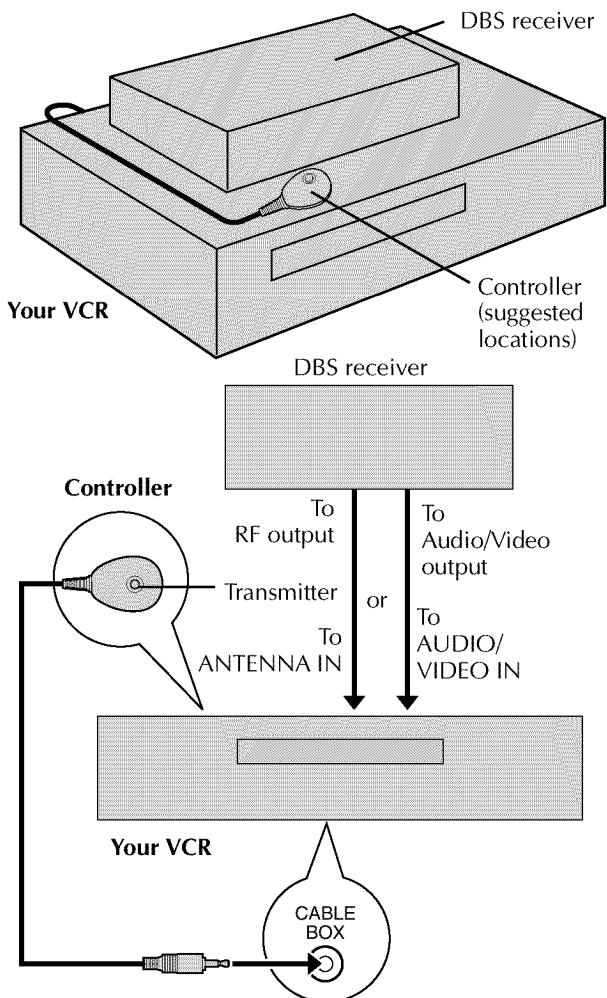

The following procedure is required if you receive satellite channels through a DBS (Direct Broadcast Satellite) receiver. The Controller allows the VCR to automatically switch the DBS receiver's channels during timer recording.

## NOTES:

- The Controller is not supplied with this unit. It can be requested by mailing in the completed JVC Cable Mouse Certificate that is included with the accessory package.
- The VCR can automatically change the DBS receiver channels using the Controller when the VCR has been programmed using Express timer programming (☞ pg. 34) or 24HR quick programming (☞ pg. 36). Because satellite programming does not use PlusCode, the Controller cannot change the DBS receiver channels during VCR Plus+ timer recording.
- If a cable box is also used, it is recommended that you connect the DBS receiver to your VCR's audio/video input connectors and the cable box to your VCR's antenna input terminal.

## Installing Controller

### 1 Situate Controller

Place the Controller so that its transmitter is facing the DBS receiver's remote sensor.

- Make sure the path between the Controller and the DBS receiver's remote sensor is not blocked.

### 2 Attach Controller

Fix securely using the adhesive strip attached on the back of the Controller.

### 3 Connect DBS receiver to VCR

- **If your DBS receiver does not have audio/video output connectors**

Connect the RF output terminal on the DBS receiver to the ANTENNA IN terminal on the rear of your VCR.

- **If your DBS receiver has audio/video output connectors**

Connect an audio/video cable between the AUDIO/VIDEO IN connectors on the rear of the VCR and the audio/video output connectors on the DBS receiver.

## NOTE:

When connecting your DBS receiver, refer to its instruction manual.

### 4 Connect Controller to VCR

Connect the Controller to the CABLE BOX Controller connector on the rear panel.

## How to control the DBS receiver

This VCR has two separate methods to control your DBS receiver.

- The VCR's wireless Remote can control your DBS receiver. This eliminates the need for a separate DBS receiver's Remote.
- The VCR's Controller can also control your DBS receiver. This allows the VCR to change your DBS receiver's channel number during timer-recording.

Each method must be set up separately. To set up the VCR's Remote, refer to page 54. To set up the Controller, go to page 19.

Turn on the VCR and the TV, and select the VCR channel 3 or 4 (or AV mode) on the TV.

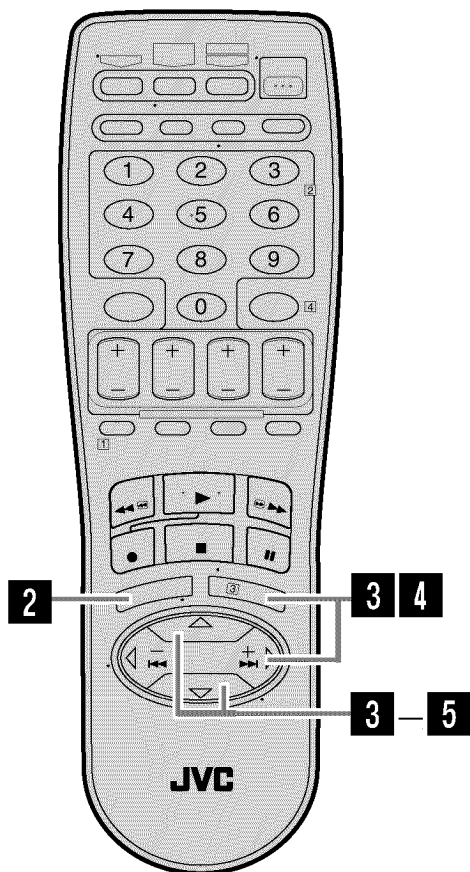

## Setting DBS receiver output channel & brand

After installation, set the DBS receiver's output channel and its brand correctly; otherwise, the Controller cannot work correctly.

### 1 Turn on DBS receiver

Select a channel other than channel 55, 100 or 205 on your DBS receiver.

### 2 Access Main Menu screen on VCR

Press **MENU**.

### 3 Access Initial Set screen

Press **SHUTTLE PLUS**  $\Delta\nabla$  to move the highlight bar (arrow) to "INITIAL SET", then press **OK** or **SHUTTLE PLUS**  $\triangleright$ .

### 4 Access DBS Receiver Set screen

Press **SHUTTLE PLUS**  $\Delta\nabla$  to move the highlight bar (arrow) to "DBS RECEIVER SET", then press **OK** or **SHUTTLE PLUS**  $\triangleright$ .

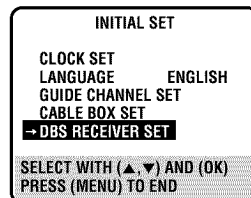

### 5 Select DBS receiver output channel

Your selection depends on how your DBS receiver is connected to your VCR.



- If your DBS receiver is connected to your VCR's **ANTENNA IN terminal on the rear**  
Press **SHUTTLE PLUS**  $\Delta\nabla$  on the Remote until the channel number representing the DBS receiver's output (CH3 or CH4) appears on the screen.
- If your DBS receiver is connected to your VCR's **AUDIO/VIDEO IN connectors on the front panel**  
Press **SHUTTLE PLUS**  $\Delta\nabla$  on the Remote until "ON F-1 (FRONT)" appears on the screen.
- If your DBS receiver is connected to your VCR's **AUDIO/VIDEO IN connectors on the rear panel**  
Press **SHUTTLE PLUS**  $\Delta\nabla$  on the Remote until "ON L-1 (REAR)" appears on the screen.
- If you do not use a DBS receiver  
Press **SHUTTLE PLUS**  $\Delta\nabla$  on the Remote until "OFF" appears on the screen.

CONTINUED ON NEXT PAGE  $\rightarrow$

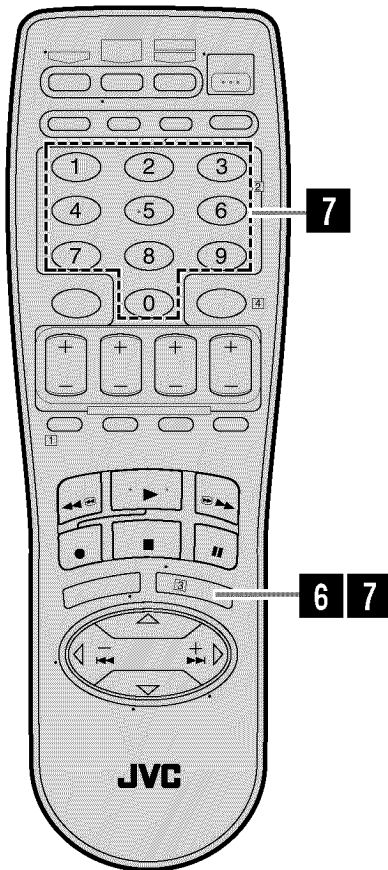

## 6 Access DBS Receiver Brand Set screen

Press **OK**.

## 7 Enter DBS Receiver's brand

Press the appropriate **Number** keys to enter the brand code from the following list, then press **OK**.

The program currently received through the DBS receiver appears for about 10 seconds.



BRAND	CODE
JVC (DISH Network)	51
ECHOSTAR (DISH Network)	51
PRIMESTAR	50
SONY (DSS)	41
RCA (DSS)	40

- If the DBS receiver's channel changes to the channel listed below for your brand, setting is complete

JVC → 100  
 ECHOSTAR → 100  
 PRIMESTAR → 55  
 SONY → 205  
 RCA → 205

Press **OK** and "DBS RECEIVER CONTROL IS ON" appears on the screen for about 5 seconds, then it returns to the normal screen.

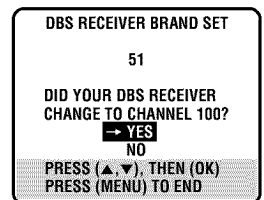

- If the DBS receiver's channel does not change as shown above

- ① Press **SHUTTLE PLUS**  $\Delta \nabla$  to move the highlight bar (arrow) to "NO".
- ② Press **OK**.
- ③ Re-enter the correct code.

## NOTES:

- The Controller may not work with all types of DBS receiver.
- If your DBS receiver does not respond to the code, you cannot use the Controller to change satellite channels. In this case, make sure to leave the DBS receiver turned on and tuned to the proper channel before the scheduled start time of timer recording.
- The VCR can only change the satellite channel through the Controller during timer recording.
- If your DBS receiver cannot be operated with a remote control (because it has no remote sensor), you cannot use the Controller to change its channels. Make sure to leave the DBS receiver turned on and tuned to the proper channel before the scheduled start time of timer recording.
- **For customers in U.S.A.:** If you are unable to set the Controller, contact JVC toll free at 1-800-537-5722.

# Basic Playback

Turn on the VCR and the TV, and select the VCR channel 3 or 4 (or AV mode) on the TV.

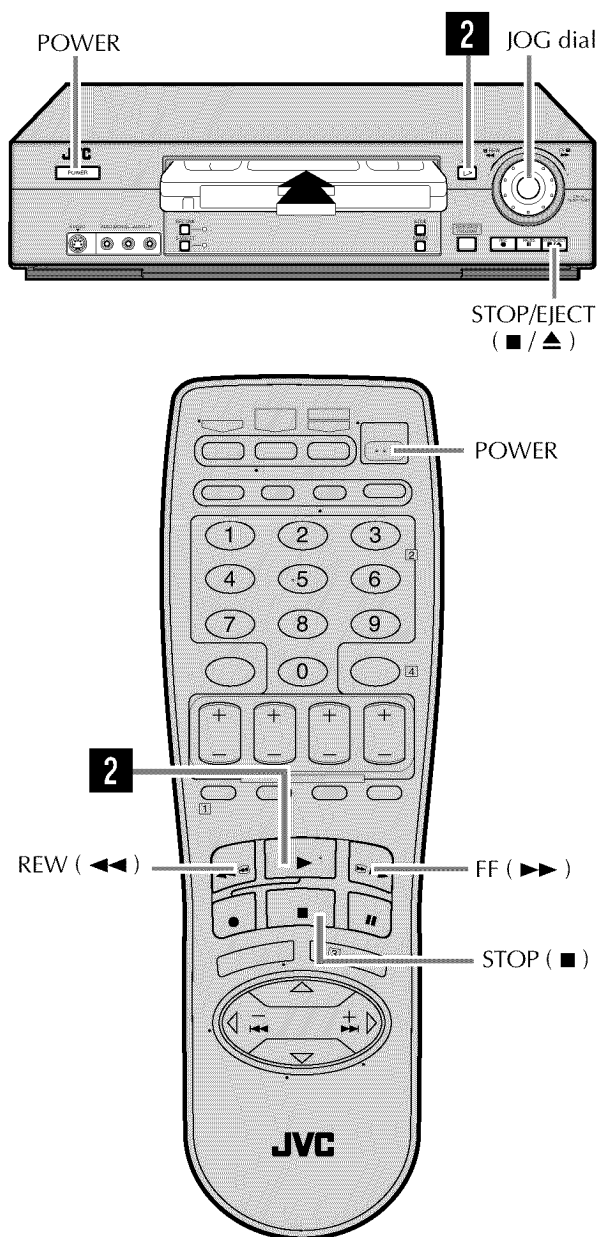

This VCR can check the tape condition during playback (and recording), and realizes the best possible pictures.

## 1 Load a cassette

Make sure the window side is up, the rear label side is facing you and the arrow on the front of the cassette is pointing towards the VCR. Do not apply too much pressure when inserting.

- The VCR turns on automatically.
- The counter is automatically reset to "0:00:00".
- If the cassette's record safety tab has been removed, playback begins automatically.

## 2 Start playback

Press **PLAY** (▶).

- Tape speed (SP or EP) is automatically detected.
- The S-VHS indicator lights up when you play back a tape recorded in S-VHS mode or in S-VHS ET mode (▶ pg. 27)
- If "VIDEO CALIBRATION" is set to "ON" (default setting: ▶ pg. 40), "VIDEO CALIBRATION" appears on the screen, and this VCR checks the tape condition during automatic tracking.
- If the tape ends during playback or fast-forward search, the cassette indication "◻◻" blinks for a few seconds and the VCR starts rewinding the tape automatically.

### To stop playback

Press **STOP** (■) on the Remote or **STOP/EJECT** (■ / ▲) on the front panel.

### To rewind the tape

Press **REW** (◀◀) (or turn the **JOG** dial on the front panel to the left).

### To fast-forward the tape

Press **FF** (▶▶) (or turn the **JOG** dial on the front panel to the right).

### To eject the tape

Press **STOP/EJECT** (■ / ▲) on the front panel when the tape is not running.

- You can also eject the cassette with the VCR turned off.

### To turn off the VCR

Press **POWER**.

*Clean the video heads using a dry cleaning cassette — TCL-2UX — when:*

- Rough, poor picture appears while a tape is played back.
- The picture is unclear or no picture appears.
- "USE CLEANING CASSETTE" appears on the screen (only with "SUPERIMPOSE" set to "ON": ▶ pg. 39, 40.)

# Basic Playback Features

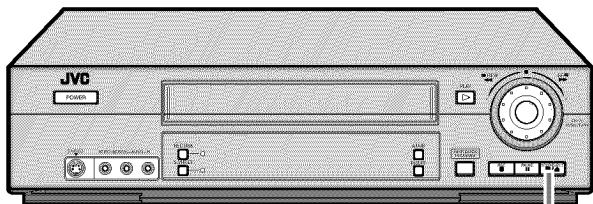

STOP/EJECT  
(■/▲)

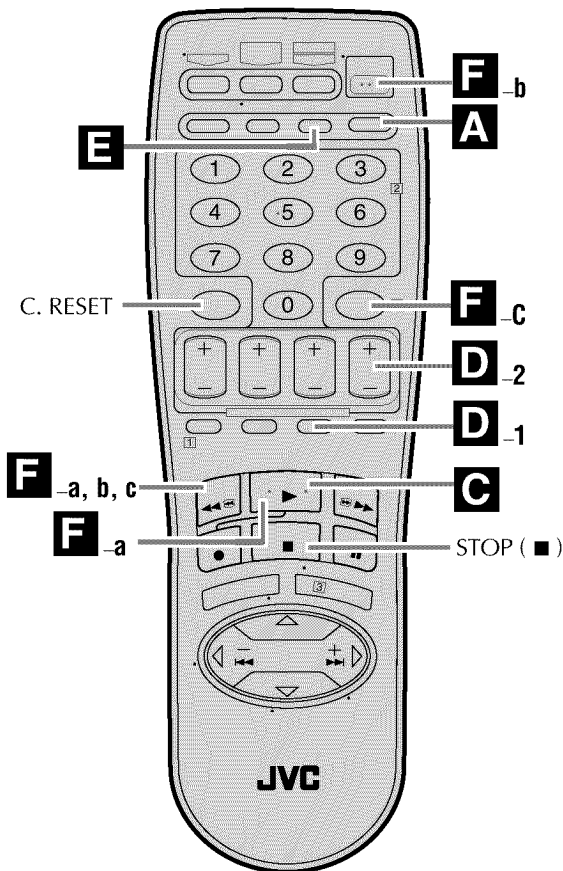

## A Changing display information

Press **DISPLAY** during playback.

Each time you press the button, the front display panel shows the time counter, tape remaining time and the clock time in sequence.

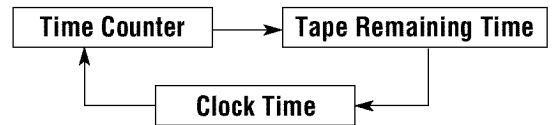

- To display the VCR status including the tape remaining time, the time counter and the clock time on the TV screen, see "Showing on-screen display" (pg. 27).
- The approximate tape remaining time appears and the "■" indicator lights on the front display panel.
- The tape remaining time is calculated based on the tape speed (SP or EP) being used. The indicated remaining time is only an estimate.

To reset the time counter, press **C. RESET** on the Remote. The counter reading becomes "0:00:00". It is also reset when a tape is inserted.

## B Checking tape position

The tape position indicator appears on screen in the following cases:

- When you change the VCR operation mode from the stop mode to fast forward or rewind mode.
- When you perform an Index Search (pg. 24) or Instant Review (pg. 24).

The position of "■" in relation to "B" (Beginning) or "E" (End) shows you where you are on the tape.

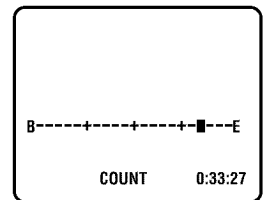

### NOTES:

- "SUPERIMPOSE" must be set to "ON", or the indicator will not appear (pg. 39, 40).
- It may take a few seconds for the tape position indicator to be displayed.

## C Playing back tape repeatedly

### — Repeat Play

You can play back a tape repeatedly (100 times).

While playing back a tape, press and hold **PLAY (▶)** for more than 5 seconds.

The play indicator (▷) on the front display panel starts flashing slowly, and a tape will be played back 100 times.

To stop playback, press **STOP (■)** on the Remote or **STOP/EJECT (■/▲)** on the front panel.

## D Adjusting tracking condition

### — Tracking Adjustments

#### Automatic tracking adjustment

This VCR automatically adjusts the tracking condition. Whenever you insert a tape and start playback, automatic tracking starts working and continuously analyzes the signal to enable optimum picture quality during playback.

#### Manual tracking adjustment

If automatic tracking cannot eliminate noises well during playback, use the manual tracking following the procedures below.

- You can also use the manual tracking during slow motion playback (☞ pg. 29).

### 1 Activate manual tracking

Press **SP/EP** on the Remote during playback.

### 2 Eliminate the noises on the TV screen

Press **CH +** or **-** on the Remote.

- Press it briefly for a fine adjustment, or press and hold for coarse adjustment. Watch the screen and continue adjustment until optimum picture and sound quality are achieved.
- To reactivate automatic tracking, press **SP/EP** on the Remote. The automatic tracking becomes active again.

## E Selecting monitor sound

### — Audio Monitor

You can select the desired monitor sound.

**While playing back a tape on which stereo sound or SAP sound is recorded, press A. MONITOR on the Remote.**

Each time you press the button, sound changes as follows:

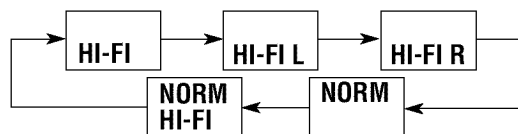

HI-FI: Normally select this.

Hi-Fi sound is played back.

HI-FI L: Sound on the left Hi-Fi channel is played back.

HI-FI R: Sound on the right Hi-Fi channel is played back.

NORM: Sound on the normal track is played back.

NORM HI-FI:

Both sounds on the Hi-Fi track and normal track are mixed and played back.

### NOTES:

- The above indication appears when "SUPERIMPOSE" is set to "ON" (☞ pg. 39, 40), though the monitor sound changes in sequence.
- If the tape being played back has no Hi-Fi sound track, the normal sound track will be heard regardless of this setting.
- If RF connection (☞ pg. 7) is used for viewing pictures on the TV, sound will be monaural even though you select "HI-FI".
- You can also use the menu to select your desired monitor sound. (☞ pg. 42)

## F Automatic operations after rewinding

### — Next Function Memory

The Next Function Memory "tells" the VCR what to do after rewinding is complete.

- Ensure that the VCR is in stop mode.

#### a- For Automatic Playback Start

Press **REW** (◀◀), then press **PLAY** (▶) within 2 seconds.

#### b- For Automatic Power Off

Press **REW** (◀◀), then press **POWER** within 2 seconds.

#### c- For Automatic Timer Standby

Press **REW** (◀◀), then press **TIMER** within 2 seconds.

### NOTE:

It is not possible to select the Automatic Timer Standby function if the cassette's record safety tab is removed.

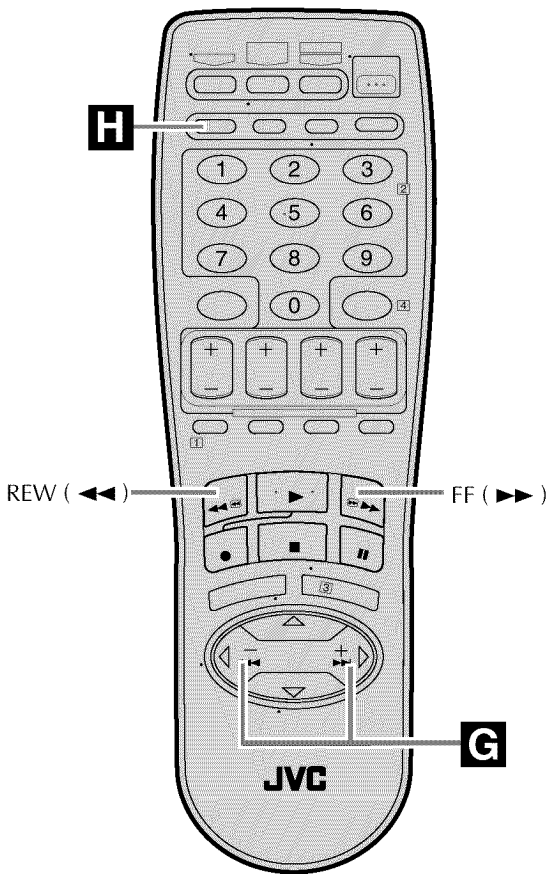

## G Locating beginning of recordings — Index Search

Index codes are placed on the tape at the beginning of each recording when recording on this VCR. You can find and automatically play back from the beginning of any recording using the Index Search function.

### 1 Start search

While the tape is not running, press **SHUTTLE PLUS**  $\lll$  or  $\ggg$  on the Remote.

### 2 Access distant code

To access a recording of 2 to 9 index codes away, press **SHUTTLE PLUS**  $\lll$  or  $\ggg$  repeatedly until the correct number is displayed on screen (only if "SUPERIMPOSE" is set to "ON";  $\text{pg. 39, 40}$ ). Playback begins automatically when the desired recording is located.

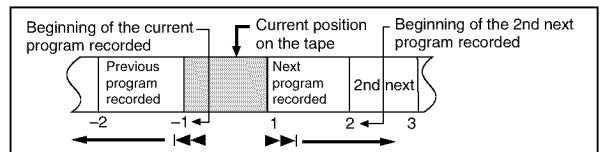

- If you want to find the very beginning of the desired program, press **REW** ( $\lll$ ) or **FF** ( $\ggg$ ) after playback starts.

### NOTE:

An index code is not placed on the tape when recording is resumed from recording pause.

### Other Useful functions for playback

You can also use the following functions for recording.

#### • Video Calibration ( $\text{pg. 40}$ )

When this function is set to "ON", this VCR checks the condition of the tape in use during playback and recording, and compensates to provide the highest-possible pictures.

#### • Picture Control ( $\text{pg. 40}$ )

This function helps you to adjust the playback picture quality according to your preference.

#### • Video Stabilizer ( $\text{pg. 41}$ )

You can automatically correct vertical vibrations in the picture when playing back unstable recordings made on another VCR.

#### • Blue Back ( $\text{pg. 41}$ )

When this function is set to "ON", the TV screen becomes all blue in the following cases:

- When receiving a channel not in use.
- When stopping playback.

## H Locating beginning of timer recordings — Instant Review

At the press of a button, you can turn on the VCR, rewind the tape and begin to view the most recent timer-recorded program.

**After ensuring that the VCR is turned off and that the timer mode is disengaged, press REVIEW.**

- The VCR turns on, and rewinds to the index code indicating the beginning of the last timer-recorded program, then begins playback automatically.
- You can access a program of 2 to 9 index codes away from the current position on the tape. If, for example, you have 5 programs recorded and you want to watch the third one, press **REVIEW** three times.
- If you want to find the very beginning of the desired program, press **REW** ( $\lll$ ) or **FF** ( $\ggg$ ) after playback starts.
- If the tape is already rewound when **REVIEW** is pressed, it will play the tape from the beginning. It will not fast-forward to an index code.
- The Instant Review function will also operate if the VCR is turned on.



# Basic Recording

Turn on the VCR and the TV, and select the VCR channel 3 or 4 (or AV mode) on the TV.

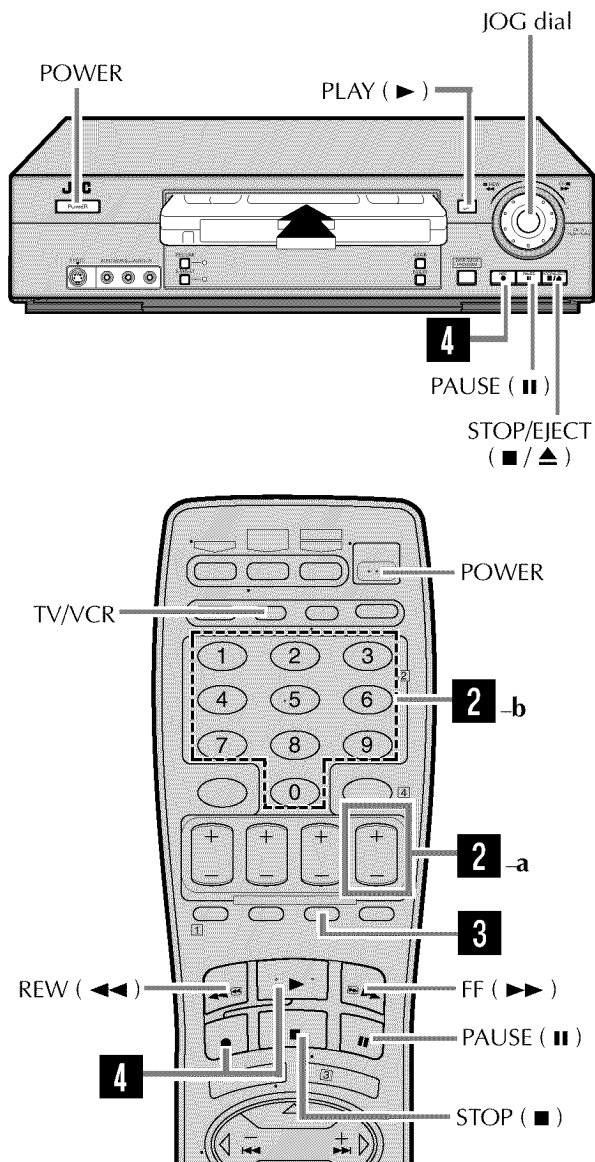

This VCR can check the tape condition during recording (and playback), and realizes the best possible pictures.

## 1 Load a cassette

Make sure the record safety tab is intact. If not, cover the hole with adhesive tape before inserting the cassette.

## 2 Select recording channel

**On the front panel:**

Push the **JOG** dial, then turn it to the left or right.

**On the Remote:**

a- Press **CH +** or **-**.  
or

b- Press the **Number** keys.

- If you connect the TV and the VCR only using the RF connection, press **TV/VCR** on the Remote so that the VCR mode indicator lights on the front display panel, to view the program to be recorded.

## 3 Set tape speed

Press **SP/EP** to set the recording speed.

## 4 Start recording

**On the front panel:**

Press **REC (●)**.

**On the Remote:**

While holding **REC (●)**, press **PLAY (▶)**.

- If "VIDEO CALIBRATION" is set to "ON" (default setting: pg. 40), this VCR checks the tape condition for about seven seconds, then starts recording. This means that the first seven seconds of the program will not be recorded. If this is inconvenient for you, follow the steps below:

- 1 Press **REC (●)** and **PAUSE (||)** to start Video Calibration.
- 2 Then press **PLAY (▶)** to start recording after Video Calibration is complete.

### To pause recording

Press **PAUSE (||)**. To resume recording, press **PLAY (▶)**.

### To stop recording

Press **STOP (■)** on the Remote or **STOP/EJECT (■/▲)** on the front panel.

### To rewind the tape (when it is not running)

Press **REW (◀)** (or turn the **JOG** dial on the front panel to the left).

### To fast-forward the tape (when it is not running)

Press **FF (▶▶)** (or turn the **JOG** dial on the front panel to the right).

### To eject the tape

Press **STOP/EJECT (■/▲)** on the front panel when the tape is not running.

- You can also eject the cassette with the VCR turned off.

### To turn off the VCR

Press **POWER**.

It may be unlawful to record or play back copyrighted material without the consent of the copyright owner.

# Basic Recording Features

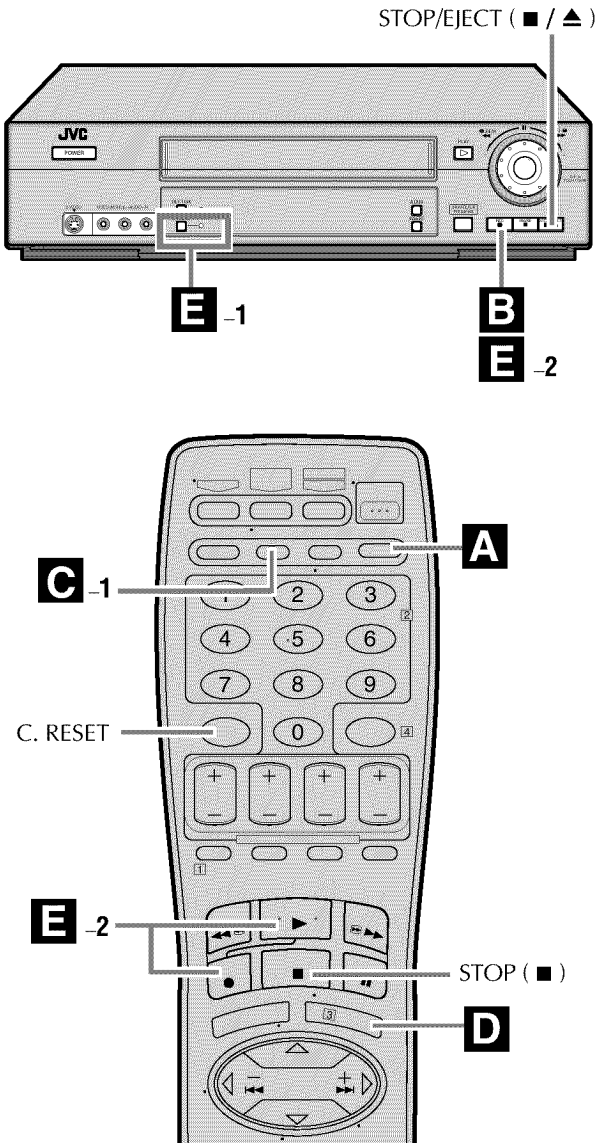

## Accidental erasure prevention

To prevent accidental recording on a recorded cassette, remove its record safety tab. To record on it later, cover the hole with adhesive tape.

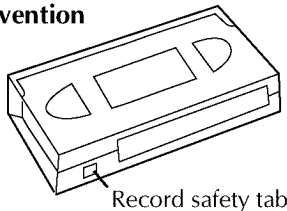

## A Changing display information

Press **DISPLAY** during recording or recording pause. Each time you press the button, the front display panel shows the time counter, channel number, tape remaining time and the clock time in sequence.

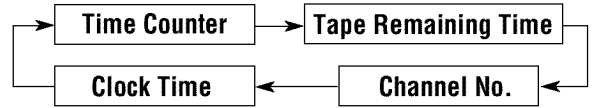

- To display the VCR status including the tape remaining time, the time counter and the clock time on the TV screen, see "Showing on-screen display" (pg. 27).
- The approximate tape remaining time appears and the "▲" indicator lights on the front display panel.
- The tape remaining time is calculated based on the tape speed (SP or EP) being used. The indicated remaining time is only an estimate.

To reset the time counter, press **C. RESET** on the Remote. The counter reading becomes "0:00:00". It is also reset when a tape is inserted.

## B Specifying recording length

### — Instant Timer Recording (ITR)

You can easily specify the recording length from 30 minutes to 6 hours and the VCR shuts off after recording is finished.

During recording, press **REC (●)** on the front panel repeatedly until the recording length you want appears on the front display panel.

The  (record) indicator starts flashing.

Each time you press the button, recording length increases in 30-minute intervals (up to 6 hours).

To cancel an ITR, press **STOP (■)** on the Remote or **STOP/EJECT (■/▲)** on the front panel.

## C Watching one program while recording another

### 1 Engage TV mode

During recording...

- If you connect the TV and the VCR only using the RF connection (pg. 7) to view pictures from the VCR

Press **TV/VCR** on the Remote so that VCR mode indicator goes off from the front display panel. (The TV broadcast being recorded disappears.)

- If you are using the AV connection (pg. 7) to view pictures from the VCR, change the TV's input mode from AV to TV.

### 2 Select channel for viewing

Select the channel, you want to watch, on the TV.

## D Showing on-screen display

When "SUPERIMPOSE" is set to "ON" (☞ pg. 39, 40), you can see the current VCR status on the TV screen.

- For more detailed information about the on-screen display, see page 63.

### 1 Display VCR status on TV screen

During recording or recording pause, press **OSD**.

All indications corresponding to the current VCR status are displayed for 5 seconds.

The time counter remains on the screen indicating the elapsed time.

- The indications are not recorded.

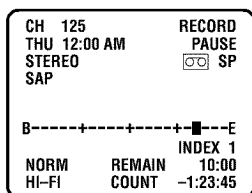

### 2 Exit on-screen display

Press **OSD** again.

#### NOTE:

- If the VCR is in recording pause mode, "RECORD/PAUSE" is always displayed.
- The VCR status can be also displayed during playback.

## E Recording on VHS tapes with S-VHS quality — Super VHS ET

This function allows you to record on VHS tapes with S-VHS picture quality. Tapes recorded using this function can be played back on a VCR equipped with the S-VHS ET function.

- You can activate this function only before you start recording on a VHS tape.
- Before recording, make sure "VIDEO CALIBRATION" is set to "ON." (☞ pg. 40)

### 1 Select S-VHS ET mode

Press **S-VHS ET** on the front panel. The S-VHS ET lamp lights up.

- The S-VHS indicator lights on the front display panel.
- To disengage the S-VHS ET mode, press **S-VHS ET**. The lamp goes off.

### 2 Start recording

**On the front panel:**

Press **REC** (●).

**On the Remote:**

While holding **REC** (●), press **PLAY** (▶).

#### NOTES:

- You cannot activate the S-VHS ET function...
  - while recording is in progress.
  - while timer-recording or Instant Timer Recording (☞ pg. 26) is in progress.
  - while Video Calibration (☞ pg. 40) is in progress.
- S-VHS ET does not work with S-VHS tapes.
- To keep the highest quality recording and playback pictures over a long period of time, S-VHS recording on S-VHS tapes is recommended.
- Use of high grade tapes are recommended for S-VHS ET recordings.
 

On some tapes, picture quality will not improve even if the S-VHS ET function is used. Check the recording quality before you start important recordings.
- You can play back S-VHS ET recordings on most of S-VHS VCRs and of VHS VCR equipped with SQPB (S-VHS QUASI PLAYBACK) function. (Notice some VCRs are not compatible with this function.)
- While playing back a tape recorded with this function on some tapes, noise may appear. (If playback picture becomes blurred or interrupted, use a cleaning cassette.)
- During special effect playback (☞ pg. 28), noise may appear. If special effect playback is performed frequently on a tape recorded with this function, the tape may be damaged and picture may be deteriorated.

#### Other useful functions for recording

You can also use the following functions for recording.

##### • Video Calibration (☞ pg. 40)

When this function is set to "ON", this VCR checks the condition of the tape in use during playback and recording, and compensates to provide the highest-possible pictures.

##### • Second Audio Recording (☞ pg. 41)

This VCR's built-in MTS decoder enables reception of Multichannel TV Sound broadcast.

To record a SAP program received, set "2ND AUDIO RECORD" to "ON" using the menu screen.

#### NOTE:

When the channel is changed on the VCR;

- The "STEREO" indication appears on the screen for about 5 seconds if the program is a stereo broadcast.
- The "SAP" indication appears on the screen for about 5 seconds if the program is a SAP broadcast.
- Both indications appear when a stereo program is accompanied by SAP sound.

##### • S-VHS Recording Mode (☞ pg. 42)

This VCR allows you to record on an S-VHS tape with VHS picture quality.

# Special Effect Playback

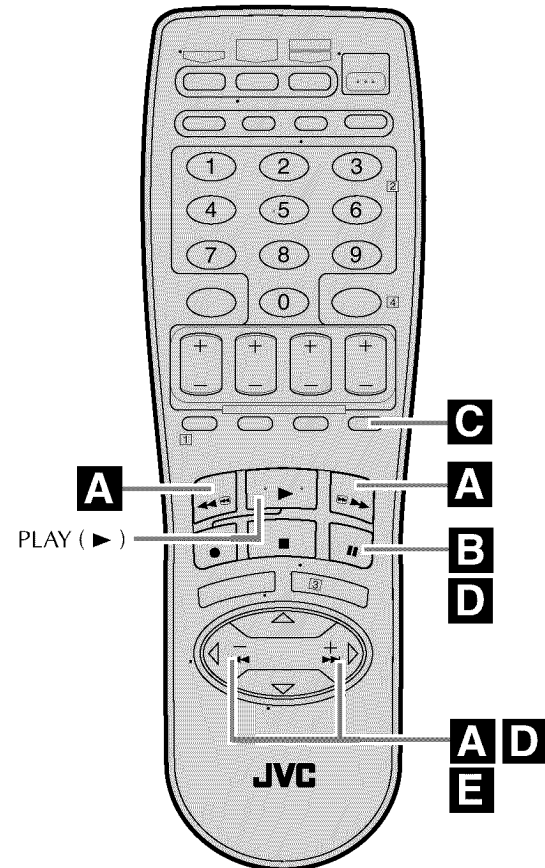
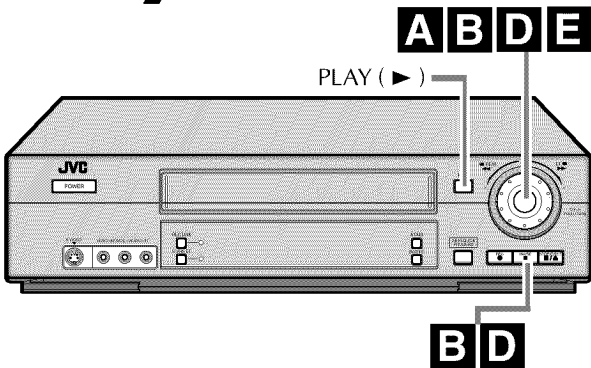

## A Locating particular scene rapidly — Picture Search

### ■ High-Speed Picture Search:

You can rapidly locate a particular scene on the tape.

#### On the front panel:

Possible during normal playback.

To do forward picture search, turn the **JOG** dial quickly to the right.

To do reverse picture search, turn the **JOG** dial quickly to the left.

- If you release the dial, picture search continues.

#### On the Remote:

Possible during normal playback or still picture playback.

To do forward picture search, press **FF** (▶▶).

To do reverse picture search, press **REW** (◀◀).

- If you press and hold the button for more than 2 seconds, simply releasing it cancels the picture search, and normal playback resumes.

To resume normal playback, press **PLAY** (▶).

### ■ Variable-Speed Picture Search:

Possible during normal playback.

You can change the speed of picture search.

#### How to use the JOG dial on the front panel:

Turn the **JOG** dial to the right (forward search) or to the left (reverse search).

Each time the **JOG** dial passes a click position, picture search speed changes (see the diagram below).

If you release the dial, picture search continues.

- The speed of picture search is determined by the number of click stops of the **JOG** dial.

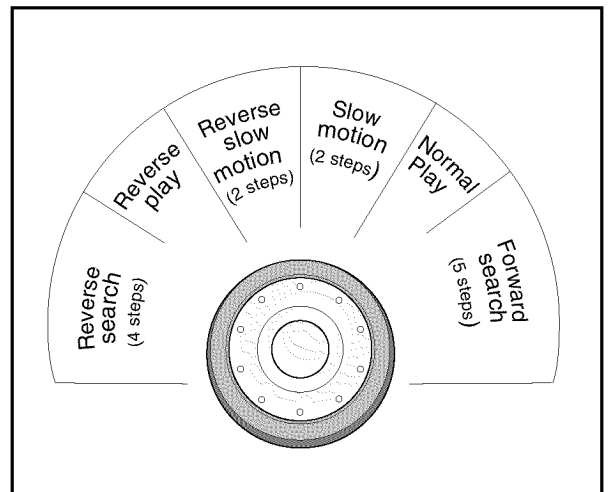

**How to use the SHUTTLE PLUS buttons on the Remote:**

**To do forward picture search,** press **SHUTTLE PLUS** ►► repeatedly.

Each time you press the button, the search speed increases.

- To decrease the speed while forward picture search (toward normal playback, then reverse picture search), press **SHUTTLE PLUS** ◀◀ repeatedly.

**To do reverse picture search,** press **SHUTTLE PLUS** ◀◀ repeatedly.

Each time you press the button, the search speed increases while reverse picture search.

- To decrease the speed while reverse picture search (toward normal playback, then forward picture search), press **SHUTTLE PLUS** ►► repeatedly.

**To resume normal playback,** press **PLAY** (►).

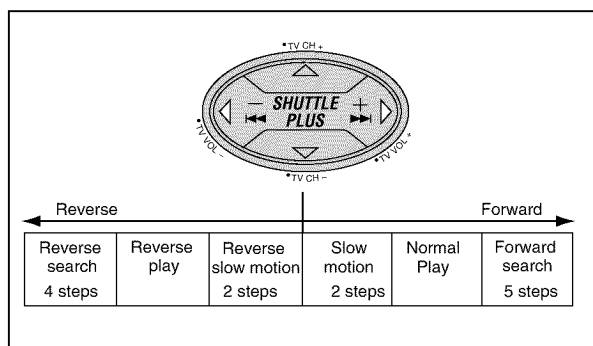

## B Viewing still picture

### — Still Picture Playback

**On the front panel:**

Push the **JOG** dial during normal playback.

**On the front panel or the Remote:**

Press **PAUSE** (||) during normal playback.

Playback is frozen and a still picture appears.

**To resume normal playback,** press **PLAY** (►).

**NOTE:**

To obtain a noiseless still picture, it may be necessary to adjust tracking in slow motion playback before starting still picture playback.

## C Skipping unwanted portions

### — Skip Search

You can skip over (view at high speed) unwanted portions of the tape.

**Press SKIP SEARCH once to 4 times during playback.**

Each press initiates a 30-second period of high speed playback (up to 2 minutes). When the specified portion of the tape is skipped, normal playback resumes automatically.

**To return to normal playback during Skip Search,** press **PLAY** (►).

## D Viewing still picture frame by frame

### — Frame-by-Frame Playback

**On the front panel:****During normal playback:**

Push the **JOG** dial or press **PAUSE** (||) to pause.

**To advance a still picture,** turn the **JOG** dial to the right.

**To reverse a still picture,** turn the **JOG** dial to the left.

**On the Remote:****During normal playback:**

Press **PAUSE** (||) to pause.

**To advance a still picture,** press **SHUTTLE PLUS** ►► (or **PAUSE** (||)) repeatedly.

**To reverse a still picture,** press **SHUTTLE PLUS** ◀◀ repeatedly.

**To resume normal playback,** press **PLAY** (►).

## E Viewing slow motion picture

### — Slow Motion Playback

**On the front panel:****During normal playback:**

Turn the **JOG** dial to the first or second click-stop to the left (forward slow motion) or to the third or fourth click-stop to the left (reverse slow motion) so that slow motion playback starts. If you release the dial, slow motion playback continues.

- Holding **PAUSE** (||) for more than 2 seconds also starts forward slow motion playback.

**On the Remote:****● During normal playback:**

Press **SHUTTLE PLUS** ◀◀ to decrease the playback speed.

Each time you press the button, the speed decreases (toward reverse slow motion playback, then reverse picture search).

- Holding **PAUSE** (||) for more than 2 seconds also starts forward slow motion playback.

**To resume normal playback,** press **PLAY** (►).

**● During still picture playback:**

Press and hold **SHUTTLE PLUS** ►► to start forward (or **SHUTTLE PLUS** ◀◀ to start reverse) slow motion playback. When you release the button, slow motion playback stops and a still picture appears.

- Holding **PAUSE** (||) for more than 2 seconds also starts forward slow motion playback.

**To resume normal playback,** press **PLAY** (►).

**NOTE:**

Manual tracking is possible during slow motion playback. During slow motion playback, simply press **CH +** or **-** on the Remote to adjust tracking.

# VCR Plus+® Timer Programming

Turn on the VCR and the TV, and select the VCR channel 3 or 4 (or AV mode) on the TV.

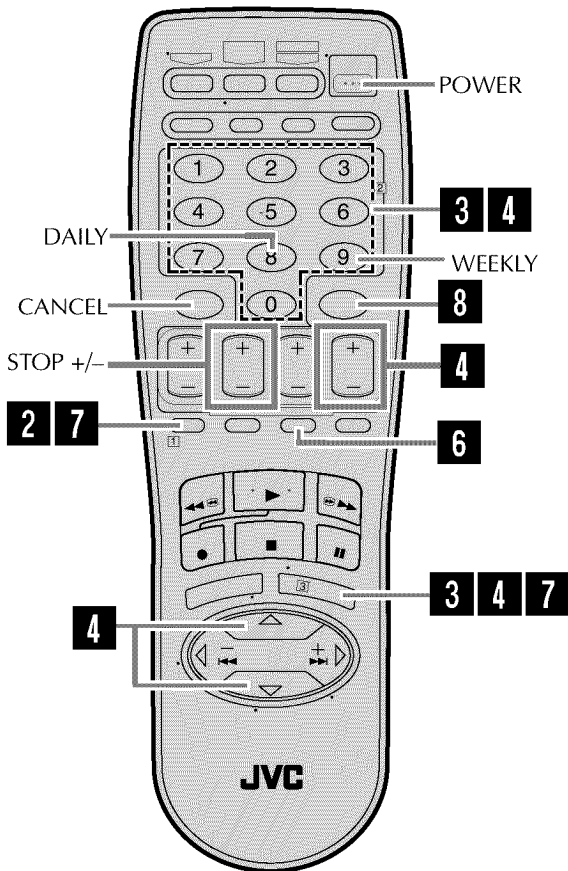

## 1 Load a cassette

Make sure the record safety tab is intact. If not, cover the hole with adhesive tape, then load it into the VCR.

- The VCR turns on, and the counter is reset, automatically.

## 2 Access PlusCode No. screen

Press **PROG.** on the Remote.

- The clock must be set to access the VCR Plus+ screen. If you have not set the clock, the Main Menu screen appears after an error message is displayed. Refer to page 8 for the Plug & Play setting or page 10 for the clock setting procedure.

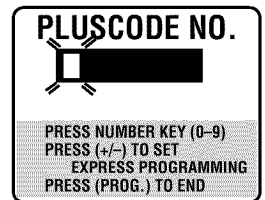

## 3 Enter PlusCode number

Press the appropriate **Number** keys to input the PlusCode number printed in the TV listings for the TV broadcast you wish to record, then press **OK**.

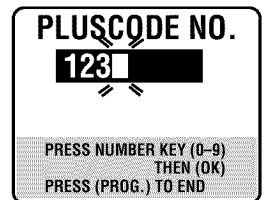

Then;

If the Guide Channel Set screen appears

— go to step **4**.

If the VCR Plus+ Program screen appears

— go to step **5**.

- To make corrections, press **CANCEL** and input the correct PlusCode number.

## 4 Input receiving channel number

The guide channel number, which is assigned to the TV or cable station for the PlusCode number that you entered in step 3, will appear automatically on the Guide Channel Set screen.

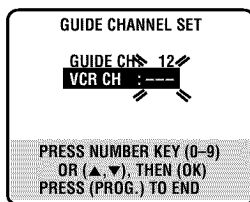

Press the **Number** keys (or **CH +/-** or **SHUTTLE PLUS**  $\Delta\nabla$ ) to input the number of the channel on which the broadcast for the PlusCode number is received on the VCR or cable box, then press **OK**.

- The Guide Channel Set screen appears only when you input the PlusCode number of a station for which the guide channel number has not been set previously.
- If you receive your channels with a cable box and if you have properly set your Controller, "CABLE CH" appears in place of "VCR CH". If not, refer to pages 15 – 17.

## 5 Check program date

The PlusCode number you entered and the corresponding timer recording program is displayed on the Program screen. Check to make sure it is accurate.

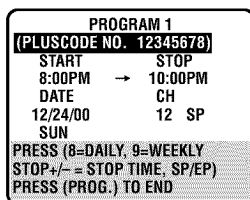

- To change the stop time, press **STOP +/-**.
- To timer-record daily (Monday–Friday) or weekly serials, press **DAILY (M-F)** (number "8") or **WEEKLY** (number "9"). "DAILY" or "WEEKLY" appears on the Program screen. Pressing the button again makes each corresponding display disappear.
- If you made a mistake, press **CANCEL** to access the VCR Plus+ screen again and input the correct PlusCode number.
- If an incorrect PlusCode number or the one for a broadcast already finished has been inputted, "ERROR" is displayed for about 5 seconds, then the VCR Plus+ screen reappears.

## 6 Set tape speed

Press **SP/EP**.

## 7 Return to normal screen

Press **PROG.** or **OK**.

"PROGRAM COMPLETED" appears on the screen for about 5 seconds, then normal screen appears.

- If "PROGRAM NOT COMPLETED PROGRAM OVERLAP" appears, you have another program overlapping the program you have just made. The Program Check screen appears and conflicting programs will start blinking. You can now correct the conflicting programs. See "When programs overlap each other" on page 38.

## 8 Engage timer recording standby mode

Press **TIMER**.

The VCR turns off automatically and "⊕" is displayed on the front display panel.

### To use the VCR while it is in timer recording standby mode

Press **TIMER** to cancel the timer recording standby mode, then press **POWER** to turn on the VCR.

DO NOT forget to put the VCR into timer recording standby mode again by pressing **TIMER** after you use the VCR; otherwise, you cannot record the broadcasts you want.

- When "AUTO TIMER" (pg. 40) is set to "ON", the timer recording standby mode is automatically engaged when the VCR is turned off. It is temporarily canceled when the VCR is turned on. You do not have to press **TIMER** to engage or disengage the timer recording standby mode.

### IMPORTANT

If you have moved to a different area or if a broadcasting station's channel number has been changed, the wrong VCR CH or CABLE CH number will be displayed on the Program screen in step 5. When this happens, set the correct guide channel number for that station. (pg. 32, "Changing VCR Plus+ Setting")

### NOTES:

- Even if a power failure occurs, the VCR keeps your timer programs. However, the clock time, channel settings, and other menu settings are lost. As a result, when the power is supplied again to this VCR after the power failure, the following will take place.
  1. This VCR starts the Plug & Play setting automatically to restore the clock time and channel setting.
  2. If the clock time and channel setting are restored correctly, each timer program you have made will start at its start time unless its end time has elapsed.
- To timer-record cable channels received through a cable box, be sure to keep the cable box turned on.

# Changing VCR Plus+® Setting

Turn on the VCR and the TV, and select the VCR channel 3 or 4 (or AV mode) on the TV.

## IMPORTANT

If you have moved to a different area or if a broadcasting station's channel number has been changed, the wrong VCR CH or CABLE CH number will be displayed on the Program screen (step 5 on page 31). When this happens, perform the following steps to set the correct guide channel number for that station.

To ensure that VCR Plus+ timer recording operates correctly, it is necessary to set the VCR Plus+ "Guide Channel Set" for each station. Read the following information carefully.

## VCR Plus+ guide channel matching

The VCR Plus+ programming system assigns a VCR Plus+ guide channel to the TV channels and the cable channels. These guide channel numbers are also called the VCR Plus+ channel codes. Most TV listings have a section, usually a chart, indicating the guide channel numbers assigned to each station. For accurate VCR Plus+ programming, the VCR Plus+ guide channel number for each station should match the channel number on which it is received in your area.

## NOTES:

- In many instances, the VCR Plus+ guide channel numbers for cable and broadcast TV stations DO NOT match the channel number on which it is received by your VCR or cable box. Check your TV listing, or contact your cable supplier for details.
- Many TV stations can be viewed on cable. Check your TV listing, or contact your cable supplier for details.

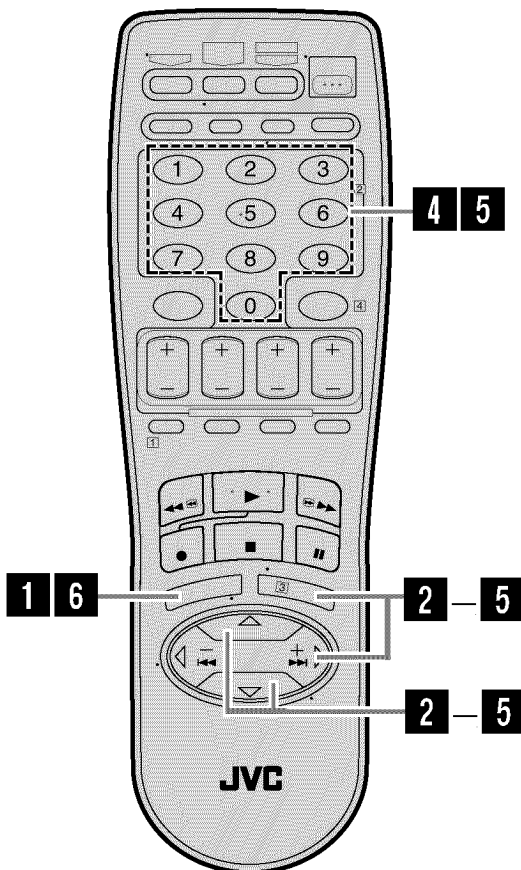



**1 Access Main Menu screen**

Press **MENU**.

**2 Access Initial Set screen**

Press **SHUTTLE PLUS**  $\Delta$ / $\nabla$  to move the highlight bar (arrow) to "INITIAL SET", then press **OK** or **SHUTTLE PLUS**  $\triangleright$ .

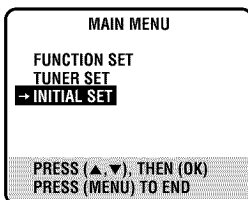
**3 Access Guide Channel Set screen**

Press **SHUTTLE PLUS**  $\Delta$ / $\nabla$  to move the highlight bar (arrow) to "GUIDE CHANNEL SET", then press **OK** or **SHUTTLE PLUS**  $\triangleright$ .

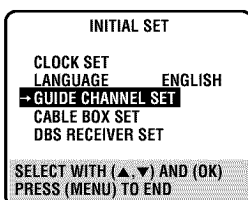
**4 Input guide channel number**

Press the **Number** keys or **SHUTTLE PLUS**  $\Delta$ / $\nabla$  to input the VCR Plus+ guide channel number as shown in the TV listing, then press **OK** or **SHUTTLE PLUS**  $\triangleright$ .

(Ex.) When inputting the guide channel number 6 for WNJU(Ind.)

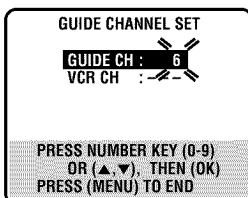

- If you receive your channels with a cable box and if you have properly set your Controller, "CABLE CH" appears in place of "VCR CH". If not, refer to pages 15 – 17 and re-perform the procedure.

**5 Input receiving channel number**

Press the **Number** keys or **SHUTTLE PLUS**  $\Delta$ / $\nabla$  to input the number of the channel on which the guide channel's broadcasts are received, then press **OK** or **SHUTTLE PLUS**  $\triangleright$ .

(Ex.) If WNJU(Ind.) is received on channel 47

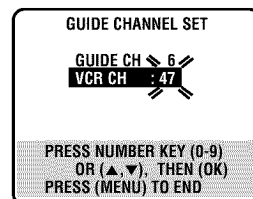

- Repeat steps **4** and **5** for each instance.

**6 Return to normal screen**

Press **MENU**.

# Express Timer Programming

Turn on the VCR and the TV, and select the VCR channel 3 or 4 (or AV mode) on the TV.

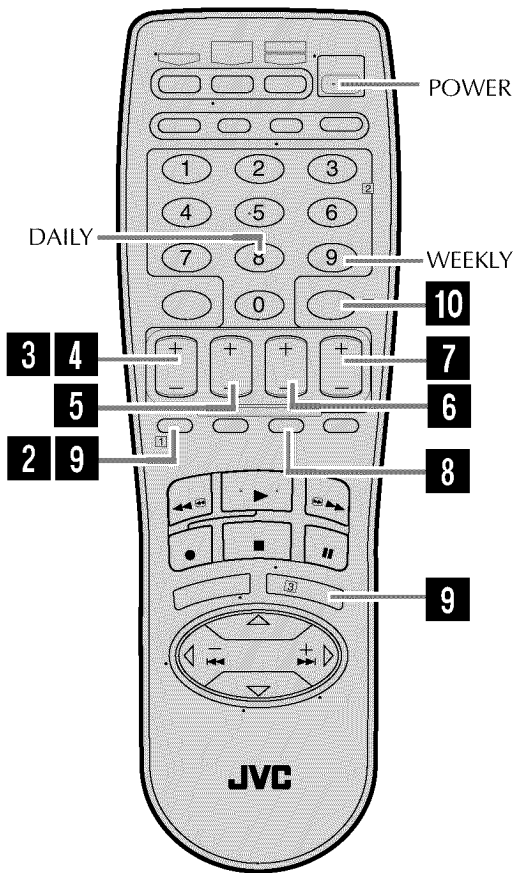

You can directly program the VCR's timer to record up to 8 broadcasts, as far as a year in advance. Remember, the clock must be set before you can program the timer (pg. 8 or 10).

## 1 Load a cassette

Make sure the record safety tab is intact. If not, cover the hole with adhesive tape, then load it into the VCR.

- The VCR turns on, and the counter is reset, automatically.

## 2 Access VCR PLUS+ screen

Press **PROG.**.

## 3 Access Program screen

Press **START +/-** once. (If no program is stored, "PROGRAM 1" appears.)

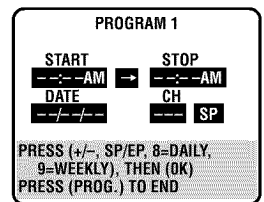

## 4 Set program start time

Press **START +/-** repeatedly to enter the time you want recording to start.

- Press and hold **START +/-** to increase the time in 30-minute intervals.

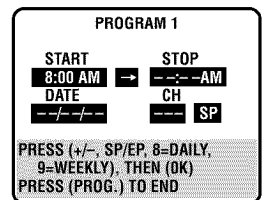

## 5 Set program stop time

Press **STOP +/-** repeatedly to enter the time you want recording to stop.

- Press and hold **STOP +/-** to increase the time in 30-minute intervals.

## 6 Set program date

Press **DATE +/-**. (The current date is displayed on the screen. The date you enter appears in its place.)

## 7 Set channel number

Press **CH +/-**.

- If you are using a DBS receiver, see "ATTENTION FOR DBS RECEIVER USERS" on next page.
- Holding down **CH +/-** rapidly changes the channel numbers.

**8 Set tape speed**

Press **SP/EP** to set the tape speed.

**9 Return to normal screen**

Press **PROG.** or **OK**.

"PROGRAM COMPLETED" appears on the screen for about 5 seconds, then normal screen appears.

- If "PROGRAM NOT COMPLETED PROGRAM OVERLAP" appears, you have another program overlapping the program you have just made. The Program Check screen appears and conflicting programs will start blinking. You can now correct the conflicting programs. See "When programs overlap each other" on page 38.

**10 Engage timer recording standby mode**

Press **TIMER**.

The VCR turns off automatically and "Ⓢ" is displayed on the front display panel.

**To timer-record daily (Monday–Friday) or weekly serials**

Press **DAILY (M-F)** (number "8") or **WEEKLY** (number "9") anytime during steps 3 through 9.

"DAILY" or "WEEKLY" appears on the Program screen.

- Pressing the button again makes the corresponding indication disappear.

**To use the VCR while it is in timer recording standby mode**

Press **TIMER** to cancel the timer recording standby mode, then press **POWER** to turn on the VCR. DO NOT forget to put the VCR into timer recording standby mode again by pressing **TIMER** after you use the VCR; otherwise, you cannot record the broadcast you want.

- When "AUTO TIMER" (ⓘ pg. 40) is set to "ON", the timer recording standby mode is automatically engaged when the VCR is turned off. It is temporarily canceled when the VCR is turned on. You do not have to press **TIMER** to engage or disengage the timer recording standby mode.

**NOTES:**

- Even if a power failure occurs, the VCR keeps your timer programs. However, the clock time, channel settings, and other menu settings are lost. As a result, when the power is supplied again to this VCR after the power failure, the following will take place.
  1. This VCR starts the Plug & Play setting automatically to restore the clock time and channel setting.
  2. If the clock time and channel setting are restored correctly, each timer program you have made will start at its start time unless its end time has elapsed.
- Programs that start after midnight must have the next day's date.
- After timer recording is completed, the VCR turns off automatically.
- You can program the timer recording while a regular recording is in progress; the menu screens will not be recorded.
- If the tape reaches its end during timer recording, the cassette is automatically ejected.
- To timer-record cable or satellite channels, be sure to keep the cable box or DBS receiver turned on.

**ATTENTION FOR DBS RECEIVER USERS**

If you are using a DBS receiver (unless "DBS RECEIVER SET" is set to "OFF" ⓘ pg. 19), the band indication (TV, CATV or DBS) appears under the channel number indication.

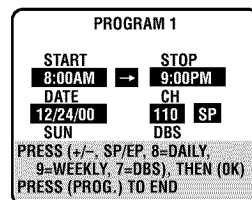

TV :To timer-record a regular TV broadcast received on the VCR.

CATV :To timer-record a cable TV broadcast received on the VCR, or through a cable box (unless "CABLE BOX SET" is set to "OFF" ⓘ pg. 16).

DBS :To timer-record a satellite broadcast received through a DBS receiver.

**NOTE:**

If "BAND" is set to "TV" on the Tuner Set screen (ⓘ pg. 13) and "CABLE BOX SET" is set to "OFF" on the Cable Box Set screen (ⓘ pg. 16), "CATV" will not be displayed on the Program screen; If "BAND" is set to "CATV" or "CABLE BOX SET" is set to "ON", "TV" will not be displayed.

If the channel number entered requires that the band be set, "7=DBS" is displayed on the screen.

If this happens, press the **Number** key "7 (DBS)" to select "DBS".

# 24HR Quick Programing

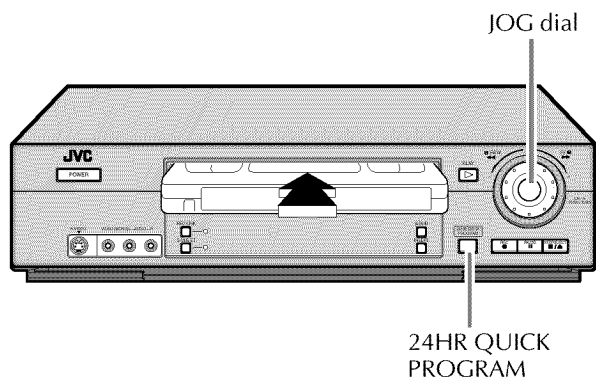

## NOTES:

- If "Err" appears on the display panel, repeat the steps again.
- When a menu screen is shown, you cannot use 24HR quick programing function. Press **MENU** to return to normal screen, and try again.
- You can use 24HR quick programing function also when the VCR is turned off.
- For 24HR quick programing function, the program overlap warning display does not appear even if some programs overlap each other.
- Even if a power failure occurs, the VCR keeps your timer programs. However, the clock time, channel settings, and other menu settings are lost.

As a result, when the power is supplied again to this VCR after the power failure, the following will take place.

1. This VCR starts the Plug & Play setting automatically to restore the clock time and channel setting.
2. If the clock time and channel setting are restored correctly, each timer program you have made will start at its start time unless its end time has elapsed.

### Timer warning display

A warning appears on the TV screen to tell you that the timer-recording is to start in 5 minutes if you are not in the timer recording standby mode at that time. Press **TIMER** to put the VCR into timer recording standby mode. To clear the display, press **CANCEL** on the Remote.

-WARNING-  
TIMER RECORDING  
TO START SOON  
(CANCEL)

You can program a timer recording that starts within 24 hours. Up to 8 timer recording programs can be made as far as a year in advance. Remember, the clock must be set before you can program the timer (see pg. 8 or 10).

## 1 Load a cassette

Make sure the record safety tab is intact. If not, cover the hole with adhesive tape, then load it into the VCR.

- The VCR turns on, and the counter is reset, automatically.

## 2 Access 24HR quick program display.

Push **24HR QUICK PROGRAM**. "▶" and start time start blinking on the display panel.

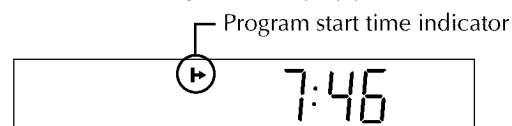

## 3 Set program start time

Turn the **JOG** dial to the left or right. Then, push the **JOG** dial. "▶" and start time start blinking on the display panel.

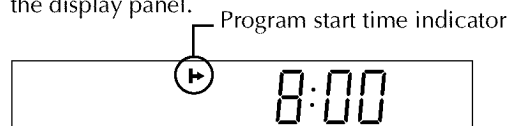

- One click stop of the **JOG** dial changes the time in 5-minute intervals.

## 4 Set program stop time

Turn the **JOG** dial to the left or right. Then, push the **JOG** dial and channel number will start blinking.

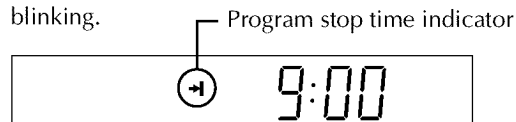

- One click stop of the **JOG** dial changes the time in 5-minute intervals.

## 5 Set channel number

Turn the **JOG** dial to the left or right.



- You can cancel the setting at any time by pressing and holding the **JOG** dial for more than 3 seconds. Repeat from the step 3.

## 6 Engage timer recording standby mode

Press **24HR QUICK PROGRAM**.

The VCR turns off automatically and "⓪" is displayed on the front display panel.

Turn on the VCR and the TV, and select the VCR channel 3 or 4 (or AV mode) on the TV.

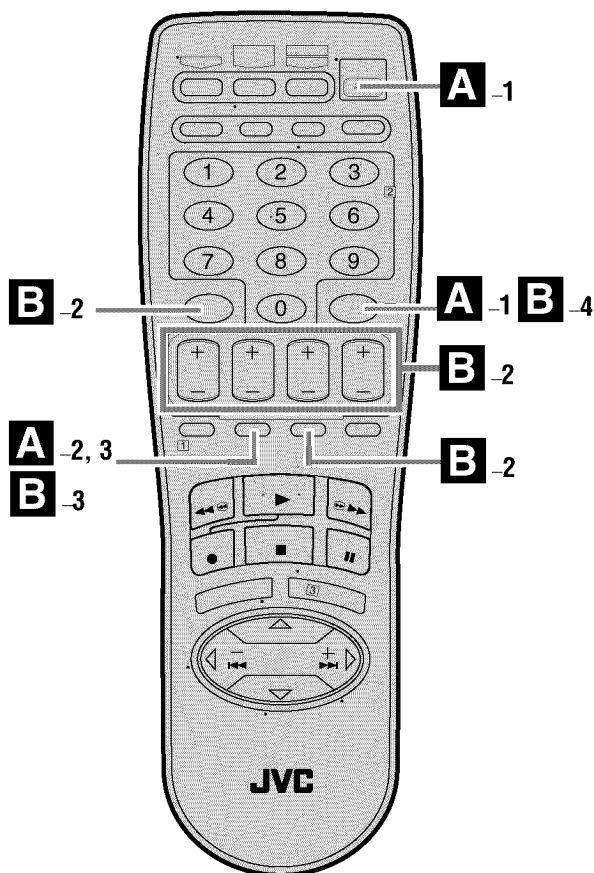

### Other Useful functions for timer recording

You can also use the following functions for timer recording.

#### • Auto Timer (pg. 40)

When "AUTO TIMER" is set to "ON", the timer recording standby mode is automatically engaged when the VCR is turned off. It is temporarily canceled when the VCR is turned on. You do not have to press **TIMER** to engage or disengage the timer recording standby mode.

#### • Auto SP → EP Timer (pg. 41)

If there is not enough tape to record the entire broadcast for recording in SP mode, the VCR automatically switches to EP mode to allow complete recording. This feature is especially handy when recording a broadcast of more than 2 hours in length.

## A Checking program settings

### 1 Disengage timer

Press **TIMER**, then press **POWER**.

- When "AUTO TIMER" (pg. 40) is set to "ON", you do not have to press **TIMER**.

### 2 Access Program Check screen

Press **PROG. CHECK**.

PR	START	STOP	CH	DATE
1	8:00P	10:00	12	12/24
2	10:00A	10:45	40	12/25
3	11:30P	1:00	125	12/25
4				
5				
6				
7				
8				

PRESS (CHECK) TO NEXT

### 3 Access Program screen

Press **PROG. CHECK** again to check more detailed information. Each time you press **PROG. CHECK**, the next program's Program screen appears. When all Program screens are shown, normal screen resumes.

## B Canceling or changing program settings

### 1 Access Program screen

Repeat steps **1** to **3** above.

### 2 Cancel or change program setting

**To cancel a program**, press **CANCEL** when the Program screen you do not want is shown.

**To change a program**, press the appropriate button: **START+/-**, **STOP+/-**, **DATE+/-**, **CH+/-**, and/or **SP/EP** when the Program screen on which you want to make changes is shown.

### 3 Return to normal screen

Press **PROG. CHECK** as many times as necessary until no Program screen is shown.

### 4 Reengage timer recording standby mode

Press **TIMER**.

- When "AUTO TIMER" (pg. 40) is set to "ON", the timer recording standby mode automatically resumes when you turn off the VCR.

### 3 Cancel or change program setting

To cancel a program, press **CANCEL** when the Program screen you do not want is shown.

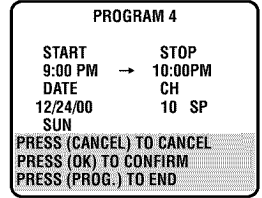

"PROGRAM COMPLETED" appears on the screen for about 5 seconds, then normal screen appears.

To change a program, press the appropriate button: **START+/-**, **STOP+/-**, **DATE+/-**, **CH+/-**, and/or **SP/EP** when the Program screen on which you want to make changes is shown, then press **OK**.

"PROGRAM COMPLETED" appears on the screen for about 5 seconds, then normal screen appears.

**NOTE:**

If the overlap is not yet solved or another overlap occurs with the timer program setting made last after making correction on a program, the conflicting programs will be shown on the Program Check screen again. Repeat the above steps again until the overlap is solved.

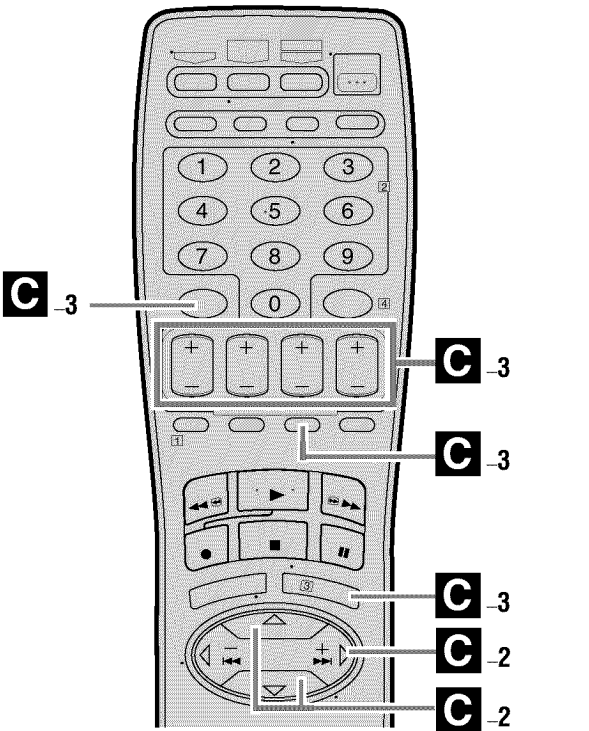

## C When programs overlap each other

If "PROGRAM NOT COMPLETED OVERLAP" appears, you have another program overlapping the program you have just made. The Program Check screen appears and conflicting programs will start blinking.

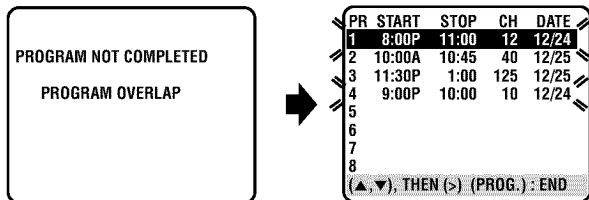

EX. Program 1 (you have just made) and Program 4 overlap each other

### 1 Confirm overlapping programs

Overlapping programs blink on the screen.

### 2 Select program to modify

Press **SHUTTLE PLUS**  $\Delta \nabla$ , then press **SHUTTLE PLUS**  $\triangleright$ .

- You can only select one of the overlapping programs.

**NOTE:**

If you do not mind this overlap, press **PROG.** to finish the timer program setting. See "ATTENTION" to the right. Without doing anything for about 1 minute, the VCR will finish the timer programming.

### ATTENTION

If there is a conflict in the timer schedule and one program overlaps with another, only the parts shown below in grey will be recorded.

**Pattern 1:** The program with the lower program number will be recorded.

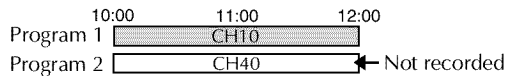

**Pattern 2:** The program starting earlier will be recorded.

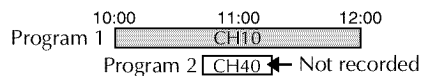

**Pattern 3:** The program starting earlier will be recorded, followed by the remaining portion of the other program.

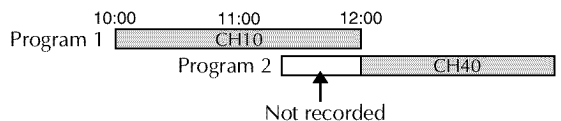

# Useful Function Settings

Turn on the VCR and the TV, and select the VCR channel 3 or 4 (or AV mode) on the TV.

You can use the other useful function settings on the Function Set screen by following the procedure described below.

- For the functions you can set on the Function Set screen, see pages 40 to 43.

## 1 Access Main Menu screen

Press **MENU**.

## 2 Access Function Set screen

Press **SHUTTLE PLUS**  $\Delta \nabla$  to move the highlight bar (arrow) to "FUNCTION SET", then press **OK** or **SHUTTLE PLUS**  $\triangleright$ .

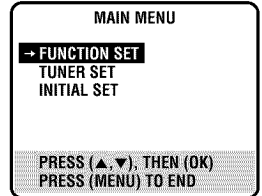

## 3 Select Function.

Press **SHUTTLE PLUS**  $\Delta \nabla$  to move the highlight bar (arrow) to the function you want to set.

For HR-S5900U/5910U

FUNCTION		PREVIOUS PAGE	
→ VIDEO CALIBRATION	ON	→ BLUE BACK	ON
PICTURE CONTROL	AUTO	2ND AUDIO RECORD	OFF
AUTO TIMER	OFF	AUDIO MONITOR	HI-FI
SUPERIMPOSE	ON	S-VHS MODE	ON
AUTO SP→EP TIMER	OFF	AV COMPU-LINK	ON
VIDEO STABILIZER	OFF	FRONT AUX INPUT	VIDEO
NEXT PAGE		REAR AUX INPUT	VIDEO
SELECT WITH ( $\Delta, \nabla$ ) AND (OK) PRESS (MENU) TO END		SELECT WITH ( $\Delta, \nabla$ ) AND (OK) PRESS (MENU) TO END	

For HR-S3900U/3910U

FUNCTION		PREVIOUS PAGE	
→ VIDEO CALIBRATION	ON	→ BLUE BACK	ON
PICTURE CONTROL	AUTO	2ND AUDIO RECORD	OFF
AUTO TIMER	OFF	AUDIO MONITOR	HI-FI
SUPERIMPOSE	ON	S-VHS MODE	ON
AUTO SP→EP TIMER	OFF	AV COMPU-LINK	ON
VIDEO STABILIZER	OFF	REAR AUX INPUT	VIDEO
NEXT PAGE			
SELECT WITH ( $\Delta, \nabla$ ) AND (OK) PRESS (MENU) TO END		SELECT WITH ( $\Delta, \nabla$ ) AND (OK) PRESS (MENU) TO END	

## 4 Change setting

Press **OK** or **SHUTTLE PLUS**  $\triangleright$ .

## 5 Return to normal screen

Press **MENU**.

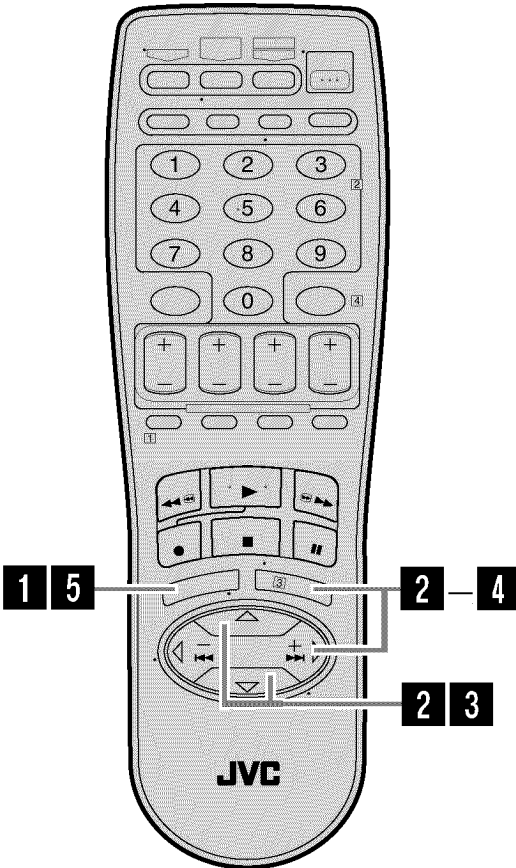

\* The default setting is **bold** in the table below.

<p>■ <b>VIDEO CALIBRATION</b> ON OFF</p>	<p>When this function is set to "ON", this VCR checks the condition of the tape in use during playback and recording, and compensates to provide the highest-possible pictures. This takes place whenever you play back a tape or start recording after inserting a tape.</p> <p><b>NOTES:</b></p> <ul style="list-style-type: none"> <li>• During playback, this function is always working even though "VIDEO CALIBRATION" appears just at the beginning of automatic tracking.</li> <li>• During recording, this function works only for the first EP recording and the first SP recording on an inserted tape. For timer recording, this function checks the tape condition both for the SP recording and the EP recording before the first timer recording starts.</li> <li>• When you play back rental tapes or tapes recorded on other VCRs, set this function either "ON" or "OFF" whichever gives you the best picture.</li> </ul>
<p>■ <b>PICTURE CONTROL</b> <b>AUTO</b> (NORM): Normally select this. Picture quality is adjusted automatically. When "VIDEO CALIBRATION" is "OFF", "NORM" will appear instead of "AUTO". <b>EDIT</b>: Minimizes picture degradation during editing (recording and playback). <b>SOFT</b>: Reduces image coarseness when viewing overplayed tapes containing much noise. <b>SHARP</b>: Clearer, sharper-edged picture when viewing images with much flat, same-colored surfaces such as cartoons.</p>	<p>This function helps you to adjust the playback picture quality according to your preference.</p> <p><b>NOTES:</b></p> <ul style="list-style-type: none"> <li>• When you select "EDIT", "SOFT" or "SHARP", the selected mode will not change until you select again.</li> <li>• Select "EDIT" when you are editing tapes (see pg. 47, 48, and 51). After you finish editing the tapes, select "AUTO" ("NORM" when "VIDEO CALIBRATION" is "OFF".)</li> </ul>
<p>■ <b>AUTO TIMER</b> ON OFF</p>	<ul style="list-style-type: none"> <li>• <b>When this function is set to "ON":</b> The timer recording standby mode is automatically engaged when the VCR is turned off. It is temporarily canceled when the VCR is turned on. You do not have to press <b>TIMER</b> to engage or disengage the timer recording standby mode.</li> <li>• <b>When this function is set to "OFF":</b> You have to press <b>TIMER</b> to engage or disengage the timer recording standby mode.</li> </ul>
<p>■ <b>SUPERIMPOSE</b> ON OFF</p>	<p>When this function is set to "ON", various VCR status information (on-screen display) appears on the screen.</p> <p><b>NOTES:</b></p> <ul style="list-style-type: none"> <li>• When you use this VCR as the playback VCR for editing a tape, be sure to set this function to "OFF"; otherwise, the VCR status information (on-screen display) will be recorded on the edited tape.</li> <li>• If you select a channel on which no signal is received, the channel number is displayed regardless of this function setting.</li> </ul>



\* The default setting is **bold** in the table below.

<p>■ <b>AUTO SP → EP TIMER</b> ON OFF</p>	<p>When this function is set to “ON”, the VCR automatically switches to EP mode to allow complete recording if there is not enough tape to record the entire program while timer-recording in SP mode.</p> <p><b>For Example . . .</b> Recording a program of 140 minutes in length onto a 120-minute tape</p> <table border="1" style="margin-left: auto; margin-right: auto;"> <tr> <td style="text-align: center;">Approximately 110 minutes</td> <td style="text-align: center;">Approximately 30 minutes</td> </tr> <tr> <td style="text-align: center;">SP mode</td> <td style="text-align: center;">EP mode</td> </tr> </table> <p>Make sure you set this function to “ON” before the timer-recording starts.</p> <p><b>NOTES:</b></p> <ul style="list-style-type: none"> <li>● If you have programed the VCR to timer-record 2 or more programs, the second program and those thereafter may not fit on the tape with this function set to “ON”. In this case, do not use this function, but change the tape speed manually during timer programing.</li> <li>● In order to ensure that the recording fits on the tape, this function may leave a slight non-recorded portion at the end of the tape.</li> <li>● There may be some noise and sound disturbance where the tape speed switches from SP to EP mode on the tape.</li> <li>● This function is not available during ITR (Instant Timer Recording), and will not work properly on the following tapes: T(ST)-30, T(ST)-60, T(ST)-90, and T(ST)-120.</li> </ul>	Approximately 110 minutes	Approximately 30 minutes	SP mode	EP mode
Approximately 110 minutes	Approximately 30 minutes				
SP mode	EP mode				
<p>■ <b>VIDEO STABILIZER</b> ON OFF</p>	<p>When this function is set to “ON”, you can automatically correct vertical vibrations in the picture when playing back unstable recordings made on another VCR.</p> <p><b>NOTES:</b></p> <ul style="list-style-type: none"> <li>● When you finish viewing a tape, be sure to set this function to “OFF”.</li> <li>● Regardless of the setting, this function has no effect during recording and during special effects playback.</li> <li>● The on-screen display may jitter vertically when this function is set to “ON”.</li> <li>● To watch recordings with close-caption, set this function to “OFF”.</li> </ul>				
<p>■ <b>BLUE BACK</b> ON OFF</p>	<p>When this function is set to “ON”, the TV screen becomes all blue in the following cases:</p> <ul style="list-style-type: none"> <li>● When receiving a channel not in use.</li> <li>● When stopping playback.</li> </ul> <p><b>NOTE:</b> When you want to receive an unstable channel with poor signals, set this function to “OFF”.</p>				
<p>■ <b>2ND AUDIO RECORD</b> ON OFF</p>	<p><b>When this function is set to “ON”;</b></p> <ul style="list-style-type: none"> <li>● If a SAP program is received, the SAP audio is recorded on both the normal and Hi-Fi tracks. The main audio is not recorded.</li> <li>● If a non-SAP program is received, the main audio is recorded on both the Hi-Fi and normal tracks.</li> </ul> <p><b>When this function is set to “OFF”,</b> the SAP audio cannot be recorded.</p>				

\* The default setting is **bold** in the table below.

<p>■ <b>AUDIO MONITOR</b></p> <p><b>HI-FI:</b> Normally select this. Hi-Fi sound is played back.</p> <p><b>HI-FI L:</b> Sound on the left Hi-Fi channel is played back.</p> <p><b>HI-FI R:</b> Sound on the right Hi-Fi channel is played back.</p> <p><b>NORM:</b> Sound on the normal track is played back.</p> <p><b>MIX:</b> Both sounds on the Hi-Fi track and normal track are mixed and played back.</p>	<p>This VCR can record two sound tracks simultaneously (normal and Hi-Fi) on a Hi-Fi stereo tape.</p> <p>You can select the sound track(s) to listen to while playing back a Hi-Fi stereo tape.</p> <p>In addition, when playing back a prerecorded tape containing two separate audio programs on the Hi-Fi tracks, you can choose either one by selecting either "HI-FI L" or "HI-FI R".</p> <p><b>NOTES:</b></p> <ul style="list-style-type: none"> <li>• While playing back a monaural tape, sounds on the normal track will be heard regardless of this setting.</li> <li>• If RF connection (☞ pg. 7) is used for viewing pictures on the TV, sound will be monaural even though you select "HI-FI".</li> <li>• You can also use the <b>A. MONITOR</b> button on the Remote to select the desired monitor sound. (☞ pg. 23)</li> </ul>
<p>■ <b>S-VHS MODE</b></p> <p><b>ON</b></p> <p><b>OFF</b></p>	<p>You can determine which recording mode — either S-VHS mode or VHS mode — is used for recording on S-VHS tapes.</p> <p><b>When this function is set to "ON",</b> you can record on S-VHS tapes with S-VHS picture quality.</p> <p><b>When this function is set to "OFF",</b> you can record on S-VHS tapes with VHS picture quality.</p> <p><b>NOTES:</b></p> <ul style="list-style-type: none"> <li>• S-VHS mode allows you to make high quality video recordings with horizontal resolution of 400 lines, comparing with the 230 lines of resolution of conventional VHS recordings. To achieve the highest quality picture we recommended to record in S-VHS mode. (But remember that a conventional VHS VCR without SQPB cannot play back S-VHS tapes recorded in S-VHS mode.)</li> <li>• S-VHS MODE setting does not affect recording on VHS tapes. Recording on VHS tapes is always performed in VHS mode except when using S-VHS ET mode (☞ pg. 27).</li> </ul>
<p>■ <b>AV COMPU-LINK</b></p> <p><b>ON</b></p> <p><b>OFF</b></p>	<p>The REMOTE PAUSE/AV COMPULINK terminal on the rear panel can be used as either the REMOTE PAUSE terminal or the AV COMPULINK terminal.</p> <p><b>When this function is set to "ON",</b> you can use the this terminal as the AV COMPULINK terminal.</p> <p>By connecting other JVC's AV COMPULINK components (see the diagram on page 43), including amplifiers (or receivers) and televisions, one touch control of the audio and video components linked via their AV COMPULINK connectors becomes possible.</p> <p><b>For example:</b> simply load a cassette in the VCR and press <b>PLAY</b> (▶) and the AV COMPULINK components automatically turn on, the TV's AV mode is selected and the VCR starts playback. (You do not have to press <b>PLAY</b> (▶) if the cassette's record safety tab is removed.)</p> <p><b>When this function is set to "OFF",</b> you can use this terminal as the REMOTE PAUSE terminal. (☞ pg. 47)</p> <p><b>NOTE:</b></p> <p>Connection varies depending on the type of JVC TV you have. Refer to the TV's instruction manual when making this connection.</p> <p style="text-align: right;"><b>CONTINUED ON NEXT PAGE ➡</b></p>

\* The default setting is **bold** in the table below.

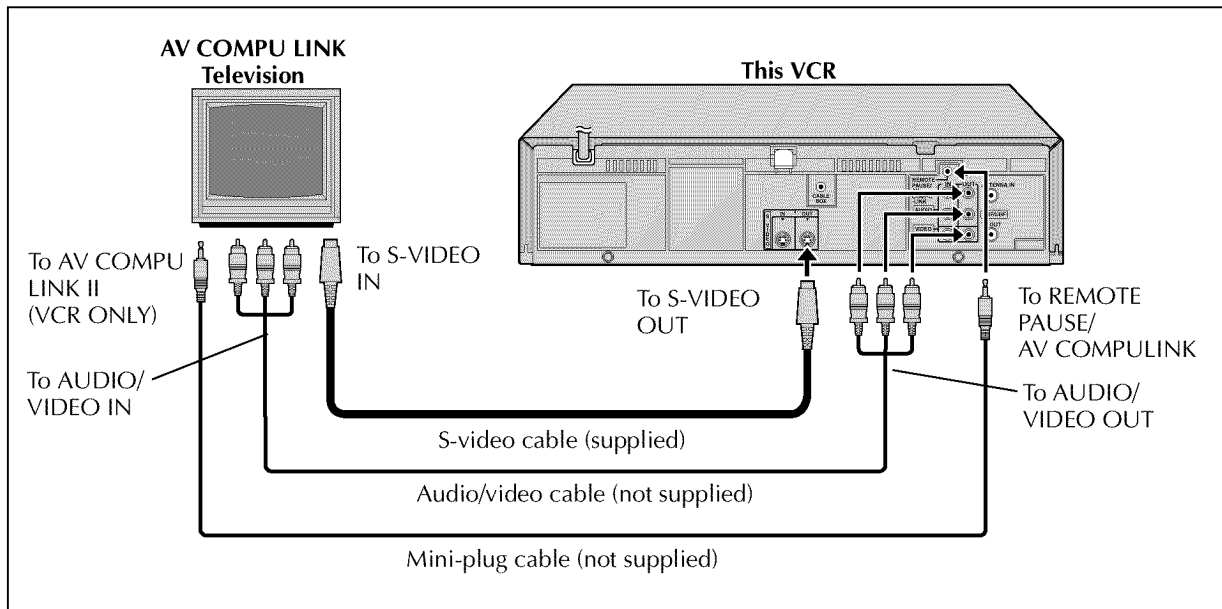

<p>■ <b>FRONT AUX INPUT</b>  <b>VIDEO</b>  <b>S-VIDEO</b></p>	<p><b>This function is ONLY FOR HR-S5900U/5910U.</b>          You have to select which terminal — either VIDEO (composite) or S VIDEO (Y/C separate signals) to use as the video input terminal on the front panel.           Make sure to select the correct terminal; otherwise, you may fail in recording (editing) on this VCR.</p>
<p>■ <b>REAR AUX INPUT</b>  <b>VIDEO</b>  <b>S-VIDEO</b></p>	<p>You have to select which terminal — either VIDEO (composite) or S VIDEO (Y/C separate signals) to use as the video input terminal on the rear panel.           Make sure you select the correct terminal; otherwise, you may fail in recording (editing) on this VCR.</p>

# Satellite Auto Recording

This function allows you to automatically record a satellite program which is timer-programmed on your DBS receiver.

**Preparation:** Connect a DBS receiver to the AUDIO/VIDEO IN or S VIDEO IN (L-1) connectors\* on the rear; otherwise, you cannot use this function.

• You can also connect the cable box if it has a timer.

\* To use these connectors, you have to select which one to use (☞ pg. 43).

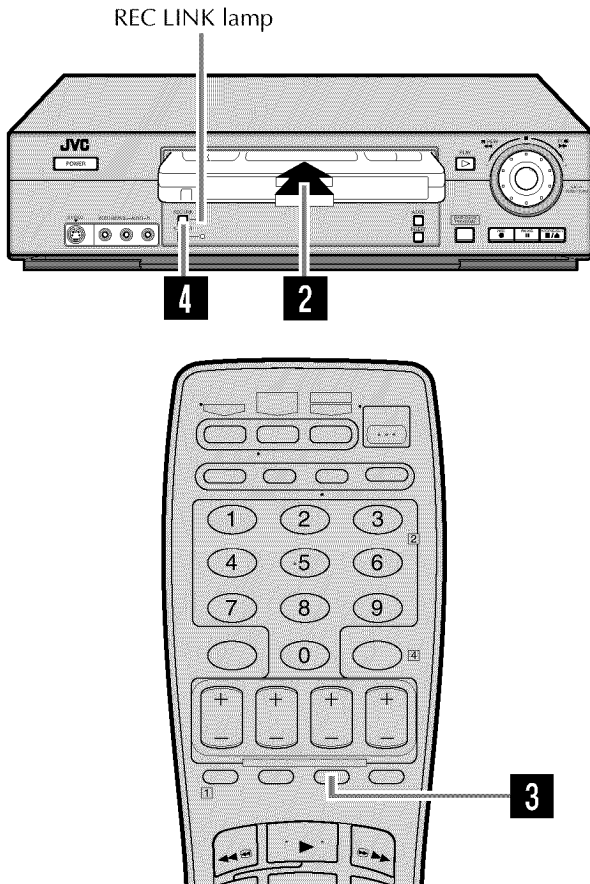

## 1 Set timer program on DBS receiver

• For timer programming method, refer to the manual supplied with the DBS receiver.

## 2 Load a cassette

Make sure the record safety tab is intact.

## 3 Set tape speed

Press SP/EP ( // ) to set the recording speed.

## 4 Engage Satellite Auto Recording standby mode

Press **REC LINK**.

The VCR turns off automatically and the REC LINK lamp lights (Satellite Auto Recording standby mode).

When signals come into the VCR from the DBS receiver, the VCR starts recording (the REC LINK lamp blinks), and stops recording and goes off when signals stop coming in.

• Each time you press the button, Satellite Auto Recording standby mode turns on and off. When it is off, the REC LINK lamp goes off.

**IMPORTANT:** Be sure not to turn on the DBS receiver before the program starts broadcasting; otherwise, the VCR will start recording when the DBS receiver is turned on.

## NOTES:

- While the Satellite Auto Recording standby mode or after Satellite Auto Recording is finished, the VCR will not enter the timer recording standby mode even though "AUTO TIMER" is set to "ON". (☞ pg. 40)
- If you turn off this VCR while Satellite Auto Recording is in progress, recording stops.
- Video Calibration (☞ pg. 40) does not work while Satellite Auto Recording is in progress.
- Auto Clock (☞ pg. 11) does not work while in the Satellite Auto Recording standby mode.
- The VCR may not record a short portion at the beginning of the program or may record slightly longer than the actual length of the program when Satellite Auto Recording method is used.
- If you engage the Satellite Auto Recording standby mode while the DBS receiver is turned on, the VCR will not start Satellite Auto Recording even though the REC LINK lamp blinks. When you turn off and on the DBS receiver once again, the VCR starts recording.
- If you have connected another component other than a DBS receiver (or cable box) to the AUDIO/VIDEO IN or S VIDEO IN (L-1) connectors, be sure not to engage the Satellite Auto Recording standby mode; otherwise, the VCR will start recording when the connected component is turned on.
- Satellite Auto Recording and timer-recording cannot be performed at the same time.
- If the REC LINK lamp does not light but blinks quickly in the Satellite Auto Recording standby mode (even though your DBS receiver is turned off), Satellite Auto Recording will not work properly. If this is the case, perform "Express Timer Programming" (☞ pg. 34) to timer-record a satellite program. (Some DBS receivers output signals even if the power is off. Satellite Auto Recording is not possible with those DBS receivers.)

# Child Lock

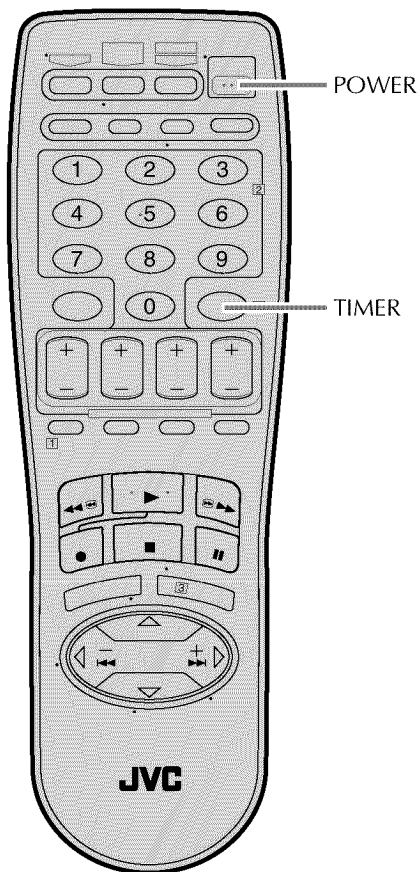

You can disable the VCR operations.

- You can only use the Remote for this operation.

**While the VCR is turned on, press and hold POWER on the Remote for more than 10 seconds.**

The VCR turns off, and "CL" appears on the front display panel for about 5 seconds, then the clock time appears again.



- The child lock function is now activated and you cannot turn on the VCR by pressing **POWER** on the front panel.

**To release the child lock,** press and hold **POWER** on the Remote until the VCR turns on.

- Pressing **TIMER** during timer recording, unplugging the AC power cord or a power outage also releases the child lock.

## NOTES:

- When the child lock function is in use, keep the Remote out of the children's reach.
- Timer recording programs will be performed even if the child lock function is activated.
- If any button on the VCR or on the Remote is pressed when the child lock function is activated, "CL" appears on the front display panel for about 5 seconds, then the clock time appears again.

# Edit From Camcorder

## Connection

This VCR (for recording)  
(HR-S5900U/5910U)

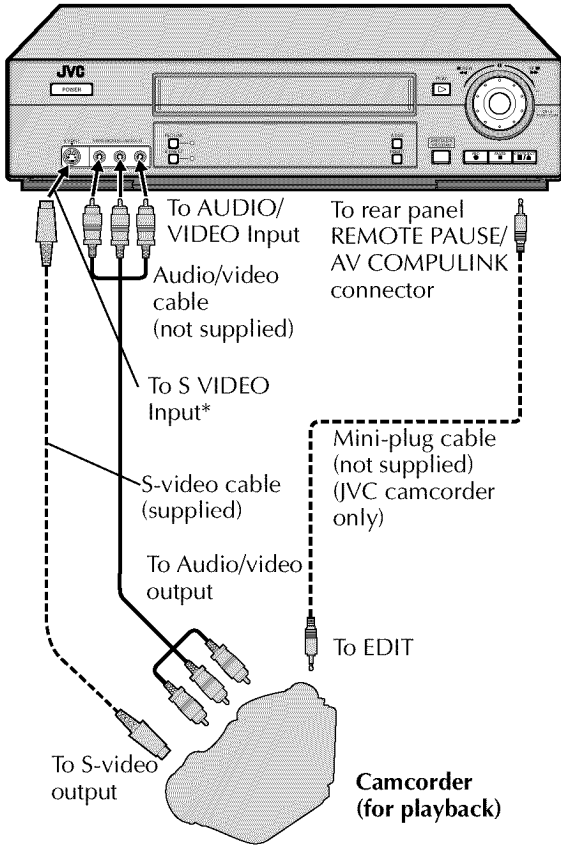

\* For HR-S3900U/3910U, the S VIDEO input connector is located on the rear panel.

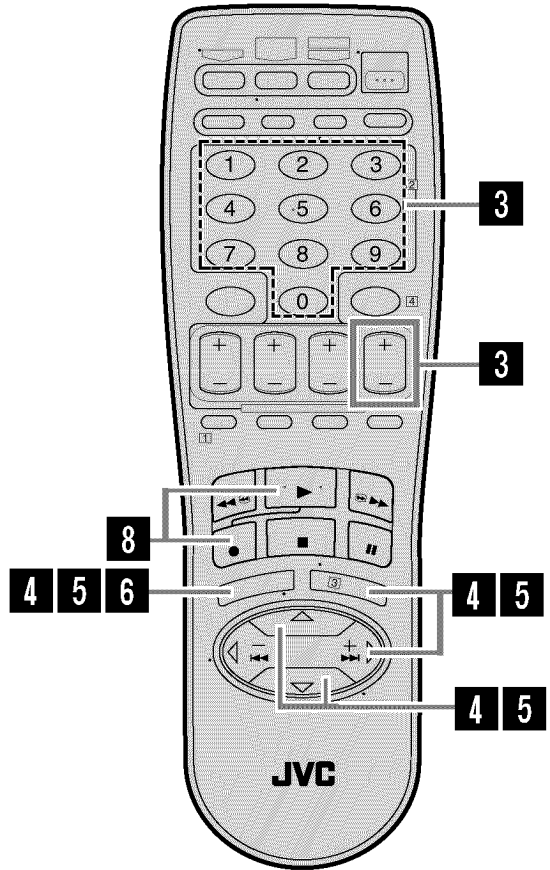
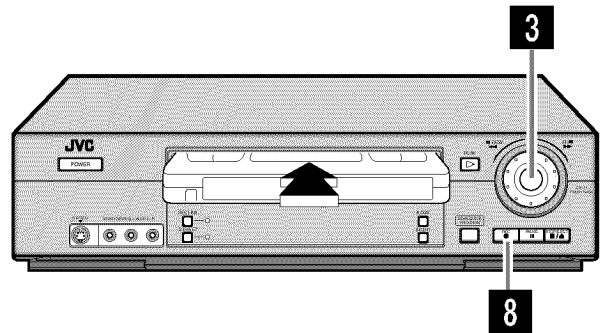

### Various connection for editing tapes

The following three methods can be used for editing tapes.

- **VHS to S-VHS editing (VIDEO-VIDEO connection):**  
Although the picture quality is inherently limited by the original VHS quality, the edited tape has better picture quality than those made by VHS-to-VHS editing.
- **S-VHS to VHS editing (VIDEO-VIDEO connection):**  
Since the original source is recorded in S-VHS mode, the edited tape has better picture quality than those made by VHS-to-VHS editing.
- **S-VHS to S-VHS (S-VIDEO connection):** Original picture quality of S-VHS made can be duplicated with minimal picture degradation. This is the best editing method you can use on S-VHS VCRs.

You can use a camcorder as the playback VCR and your VCR as the recording VCR

## 1 Make connections

Connect an audio/video cable between the camcorder's audio/video output connectors and your VCR's audio/video input connectors.

- When the JVC camcorder is equipped with the Master Edit Control, you can control the VCR from the camcorder. Connect the mini-plug cable (not supplied with this VCR) as illustrated to the left.
- When using a camcorder with a monaural output, connect the audio output connector on the camcorder to the left audio input connector on this VCR.

## 2 Load a cassette

Insert the cassette to be recorded on into this VCR (for recording).

## 3 Select input mode on this VCR

Select "L-1" — when connecting the camcorder to the audio/video input connectors on the rear panel.

Select "F-1" — when connecting the camcorder to the audio/video input connectors on the front panel.

### On the front panel:

Push the **JOG** dial, then turn it to the left or right.

### On the Remote:

Press the **Number** key **"0 (AUX)"** or **CH +/-**.

## 4 Select video input terminal

Follow the procedure described on pages 39 and 43.

**When using S VIDEO terminal**, set "FRONT AUX INPUT" (or "REAR AUX INPUT" if you use the connectors on the rear) to "S-VIDEO".

**When using VIDEO terminal**, set "FRONT AUX INPUT" (or "REAR AUX INPUT") to "VIDEO".

## 5 Set "PICTURE CONTROL" to "EDIT"

Follow the procedure described on pages 39 and 40.

**If your camcorder is a JVC Master Edit Control-equipped type** — go to step **6**.

**If your camcorder is NOT a JVC Master Edit Control-equipped type** — go to step **7**.

## 6 Set "AV COMPU-LINK" to "OFF"

Follow the procedure described on pages 39 and 42.

- The REMOTE PAUSE/AV COMPU-LINK connector works as the Remote Pause connector when "AV COMPU-LINK" is set to "OFF".

## 7 Return to normal screen

Press **MENU**.

## 8 Start playback

Press **PLAY (▶)** on the camcorder.

### NOTE:

*If the camcorder is equipped with a superimpose/OSD disable feature then set it to "OFF" before starting playback.*

## 9 Start recording

### On the front panel:

Press **REC (●)**.

### On the Remote:

Press **REC (●)** and **PLAY (▶)** at the same time.

- If you are using a Master Edit Control-equipped JVC camcorder, recording starts automatically on this VCR. (Refer to camcorder's instruction manual.)

### NOTE:

*Be sure to select "AUTO" for "PICTURE CONTROL" (or "NORM" when "VIDEO CALIBRATION" is set to "OFF") after you finish dubbing the tapes (☞ pg. 39 and 40).*

# Edit To Or From Another VCR

## Connection

Ex. When using this VCR as the playback VCR

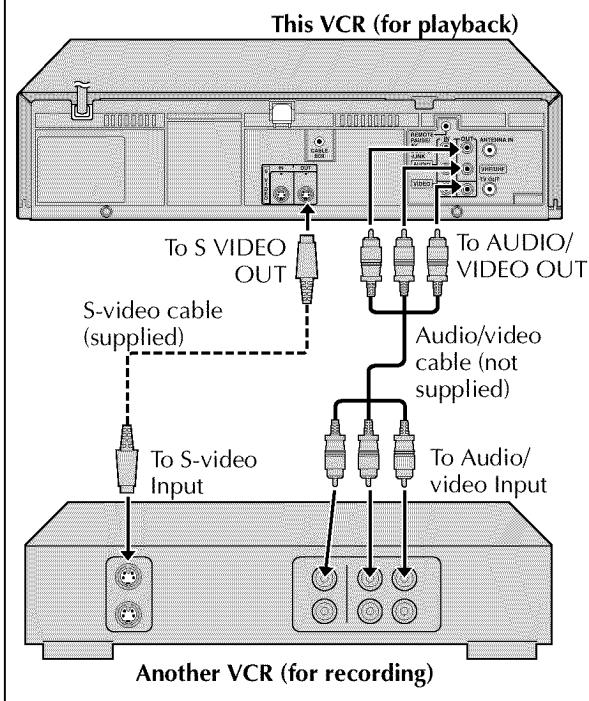

You can use your VCR as the playback or recording VCR.

- Refer also to the other VCR's instruction manual for connection and its operations.

## 1 Make connections

Connect an audio/video cable between the playback VCR's audio/video output connectors and the recording VCR's audio/video input connectors.

- When using this VCR as the recording VCR, connect this VCR's audio/video input connectors to the audio/video output connectors on the other VCR.  
If the playback VCR is monaural, connect the audio output connector on the playback VCR to the left audio input connector on this VCR.

## 2 Load cassettes

Insert the playback cassette into the playback VCR and the cassette to be recorded on into the recording VCR.

## 3 Select input mode on recording VCR

Select the correct external input on the other VCR.

- On this VCR (when using this VCR as the recording VCR);  
Select "L-1" — when connecting the other VCR to the audio/video input connectors on the rear panel;  
Select "F-1" — when connecting the other VCR to the audio/video input connectors on the front panel.

### On the front panel:

Push the **JOG** dial, then turn it to the left or right.

### On the Remote:

Press the **Number** key "0 (AUX)" or **CH +/-**.

## 4 Select video input terminal on recording VCR

When using this VCR as the recording VCR, follow the procedure described on pages 39 and 43.

**When using S VIDEO terminal**, set "FRONT AUX INPUT" (or "REAR AUX INPUT" if you use the connectors on the rear) to "S-VIDEO".

**When using VIDEO terminal**, set "FRONT AUX INPUT" (or "REAR AUX INPUT") to "VIDEO".

## 5 Select edit mode

Set the edit mode to "ON" for the VCRs if such a mode is equipped.

- On this VCR, set "PICTURE CONTROL" to "EDIT" by following the procedure described on pages 39 and 40.

## 6 Start playback

Press **PLAY** (▶) on the playback VCR.

### NOTE:

If the playback VCR is equipped with a superimpose/OSD disable feature then set it to "OFF" before starting playback (☞ pg. 39 and 40).

## 7 Start recording

Press **REC** (●) on the recording VCR.

### NOTE:

Be sure to select "AUTO" for "PICTURE CONTROL" (or "NORM" when "VIDEO CALIBRATION" is set to "OFF") after you finish dubbing the tapes (☞ pg. 39 and 40).



# Audio Dubbing

(ONLY FOR HR-S5900U/5910U)

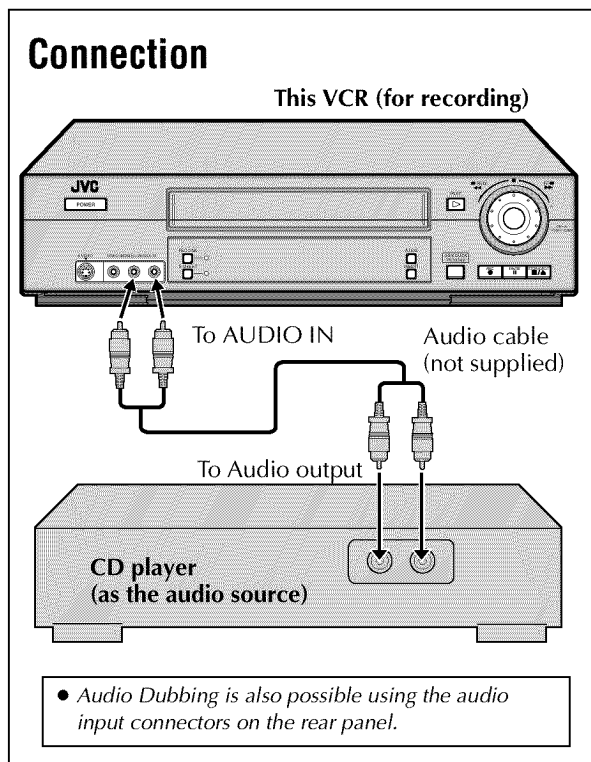

You can replace sounds recorded on the normal track with new sounds — for example, your favorite song played back on the CD player.

- Refer also to the other audio component's instruction manual for connection and its operations.

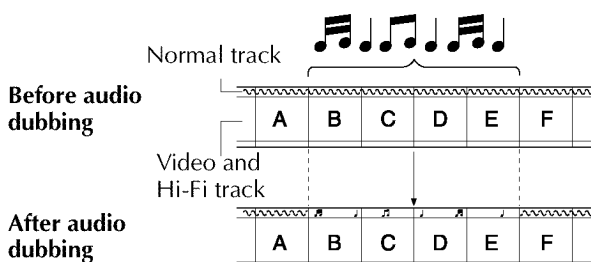

## 1 Make connections

Connect an audio cable between the VCR's audio input connectors and the audio component's audio output connectors.

- If the audio component is monaural, connect the AUDIO L (MONO) input connector on the VCR.

## 2 Load a cassette and prepare the audio source

## 3 Select input mode

Select "F-1" — when connecting the audio component to the audio input connectors on the front panel.

Select "L-1" — when connecting the audio component to the audio input connectors on the rear panel.

### On the front panel:

Push the JOG dial, then turn it to the left or right.

### On the Remote:

Press the Number key "0 (AUX)" or CH +/-.

## 4 Locate start point

- 1 Press PLAY (▶) to start playback.
- 2 Press PAUSE (⏸) when you find the beginning of the scene for which you want to audio-dub.

## 5 Activate editing mode

Press A.DUB on the front panel.

- The VCR enters the Audio Dubbing pause mode.
- blinks, and light up on the front display panel.

## 6 Start audio dubbing

Press PLAY (▶) on this VCR and start playing the audio source.

- blinks and is displayed on the front display panel.

## To stop audio dubbing

Press STOP (■) on the Remote or STOP/EJECT (■ / ▲) on the front panel.

- Audio dubbing automatically stops when the counter reading becomes "0:00:00", and the VCR starts normal playback.

## NOTES:

- During Audio Dubbing, the sound recorded on the normal track is selected as the monitor sound. If you want to listen to the Hi-Fi or mixed sound (Hi-Fi sound and monaural sound), see "Selecting monitor sound — Audio Monitor" (⌘ pg. 23).
- Audio Dubbing cannot be performed on a tape with its record safety tab removed.
- When playing back an audio-dubbed tape, select the sound you want. See "Selecting monitor sound — Audio Monitor" (⌘ pg. 23).
- Picture may be distorted if you pause Audio Dubbing.

# Insert Editing and AV Dubbing

(ONLY FOR HR-S5900U/5910U)

## Connection

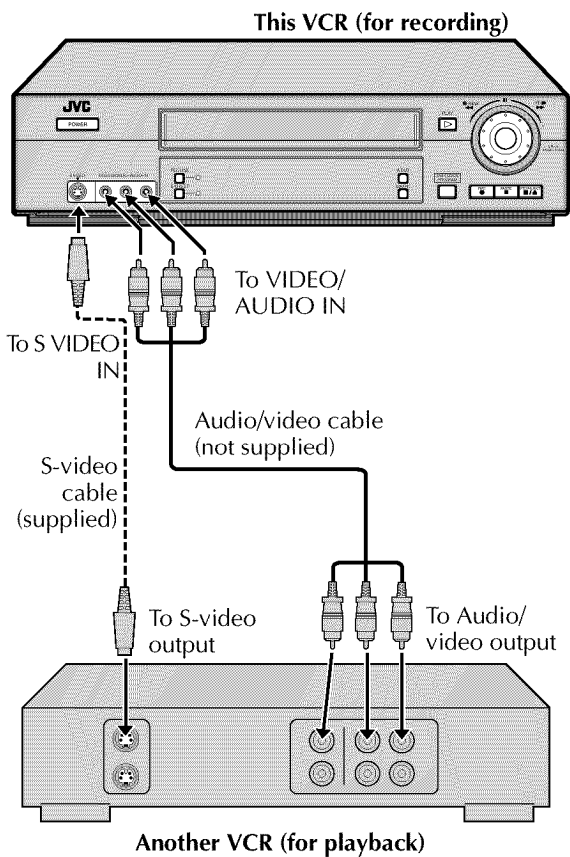

- Insert Editing and AV Dubbing are also possible using the audio/video connectors on the rear panel.

Refer also to the other component's instruction manual for connection and its operations.

**Insert Editing:** You can replace a recorded scene with new scene recorded on another tape or with other material. Both the picture and the sound recorded on the Hi-Fi sound track are replaced at the same time.

**Audio/Video Dubbing:** You can perform Audio Dubbing and Insert Editing at the same time. This means that the picture and the sounds recorded on the Hi-Fi sound track and on the normal track are replaced at the same time.

- For Audio/Video Dubbing, you can edit pictures and sound using different sources; connect a video source to the video input connector, and an audio source to the audio input connectors.

## Insert Editing

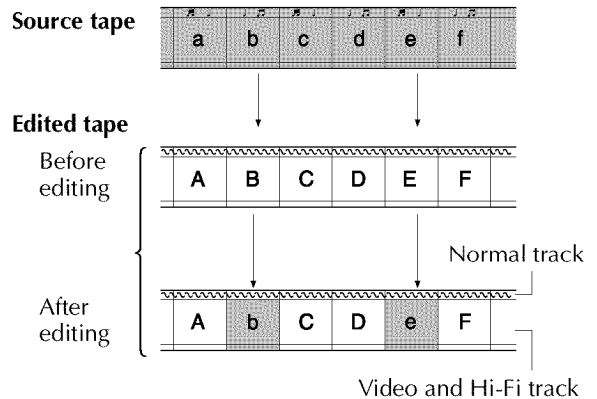

## AV Dubbing

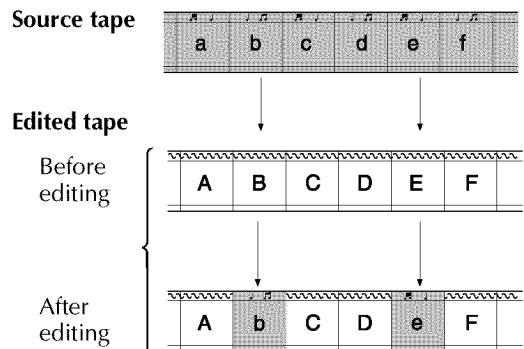

**1 Make connections**

Connect an audio/video cable between the VCR's audio/video input connectors and the other component's audio/video output connectors.

**2 Prepare tapes**

Load the source tape on the other VCR, and the tape to be edited on this VCR.

**3 Select input mode**

Select "F-1" — when connecting the other component to the audio/video input connectors on the front panel.

Select "L-1" — when connecting the other component to the audio/video input connectors on the rear panel.

**On the front panel:**

Push the **JOG** dial, then turn it to the left or right.

**On the Remote:**

Press the **Number** key "0 (AUX)" or **CH +/-**.

**4 Select video input terminal**

Follow the procedure described on pages 39 and 43.

**When using S VIDEO terminal**, set "FRONT AUX INPUT" (or "REAR AUX INPUT" if you use the connectors on the rear) to "S-VIDEO".

**When using VIDEO terminal**, set "FRONT AUX INPUT" (or "REAR AUX INPUT") to "VIDEO".

**5 Select edit mode**

Set the edit mode to "ON" for the VCRs if such a mode is equipped.

- On this VCR, set "PICTURE CONTROL" to "EDIT" by following the procedure described on pages 39 and 40.

**6 Locate end point**

- 1 Press **PLAY** (▶) to start playback.
- 2 Press **PAUSE** (⏸) when you find the end of the scene for which you want to edit.
- 3 Press **C. RESET** so that the counter reading becomes "0:00:00".

**NOTE:**

You can also use **REW** (◀) or **JOG** dial to locate the end point (See "Special Effect Playback": pg. 28).

**7 Locate start point**

Use **REW** (◀) or **JOG** dial to reverse the tape (See "Special Effect Playback": pg. 28).

When you find the beginning of the scene you want to edit, press **PAUSE** (⏸).

**8 Activate editing mode**

Press **INSERT** on the front panel.

- Make sure to set the recording format (VHS, S-VHS or S-VHS ET) on the VCR is the same as that of the original recording on the tape.
- During Insert Editing pause mode (⦿, ▶ and ⦿ light up on the front display panel.)
- For AV Dubbing, after pressing **INSERT**, press **A.DUB** also. During AV Dubbing insert pause mode (⦿ and ▶ blink, and ⦿ lights up on the front display panel.)

**9 Start editing**

Press **PLAY** (▶) on this VCR, and start playback on the other component at the same time.

- During Insert Editing mode (⦿ and ▶ light up on the front display panel.)
- During AV Dubbing mode (⦿ and ▶ blink on the front display panel.)
- When the counter reading becomes "0:00:00", editing automatically stops, and the VCR starts normal playback.

**To stop editing any time during recording**

Press **STOP** (■) on the Remote or **STOP/EJECT** (■ / ▲) on the front panel.

**NOTES:**

- Be sure to select "AUTO" for "PICTURE CONTROL" (or "NORM" when "VIDEO CALIBRATION" is set to "OFF") after you finish editing the tapes (pg. 39 and 40).
- Editing cannot be performed on a tape with its record safety tab removed.
- The recording speed (SP/EP) is determined by the previous recording to be replaced. If the recording speed changes on the tape to be edited while editing the tape, the inserted picture will be distorted where the recording speed changes.
- When you edit a tape, a small portion of the recording preceding to the editing start point will be erased from the edited tape.

# TV Brand Setting

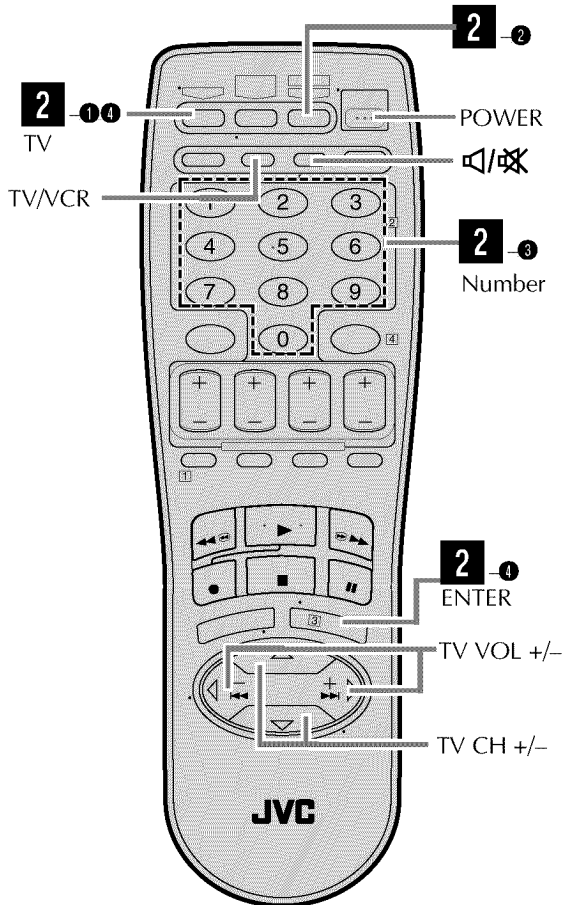

This Remote can control some functions of remote controllable TVs listed below. Without setting, you can control a JVC TV.

## 1 Turn on the TV

Turn on the TV using the Power button on the TV or its Remote.

## 2 Set TV brand code

Follow the example shown below.

- ① Press and hold **TV**.
- ② Press **MBR SET**.
- ③ Press the **Number** keys to enter your TV's brand code by referring to the table below.
- ④ Press **OK**, and release **TV**.

The TV should turn off. If it does, try other operations below. (→ step 3).

- Once you have set the Remote to operate the TV, you do not have to set it until you replace the batteries from the Remote.
- PANASONIC has two codes. If the TV does not function with one code, try entering the other.

## 3 Operate TV

While holding down **TV**, press one of the following buttons: **POWER**, **TV/VCR**, **TV CH +/-**, **Muting** (TV Muting), **TV VOL +/-**, and **Number** keys.

- For some brands, you must press **ENTER** after having pressed the **Number** keys to enter a channel number.

## NOTES:

- Depending on the type of TV, some or all functions cannot be operated using this Remote.
- It's not possible to operate a TV not equipped with a remote sensor.

### (Ex.) To set Remote to RCA 05:

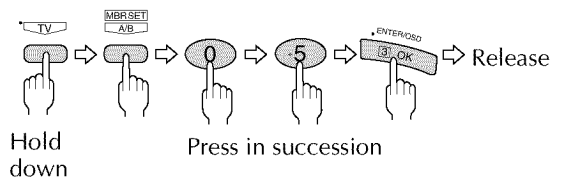

TV BRAND NAME	BRAND CODE
JVC	01, 03
HITACHI	10
MAGNAVOX	02
MITSUBISHI	03
PANASONIC	04, 11
RCA	05
SHARP	06
SONY	07
SAMSUNG	12
SANYO	13
SEARS	13
TOSHIBA	08
ZENITH	09

# Cable Box Brand Setting

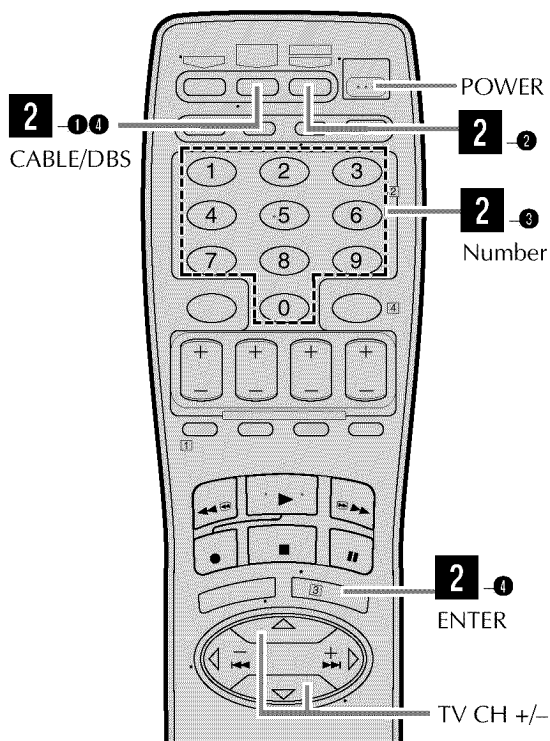

This Remote can control some functions of the cable boxes listed below. Some cable box brands have more than one code. If your cable box does not function with a specified code, try other codes.

## 1 Turn on the cable box

Turn on the cable box using the Power button on the cable box or its Remote.

## 2 Enter cable box brand code

Follow the example shown below.

- 1 Press and hold **CABLE/DBS**.
- 2 Press **MBR SET**.
- 3 Press the **Number** keys to enter your cable box's brand code by referring to the table below.
- 4 Press **OK**, and release **CABLE/DBS**.  
The cable box should turn off. If it does, try other operations below. (➡ step 3).

- Once you have set the Remote to operate the cable box, you do not have to set it until you replace the batteries from the Remote.

## 3 Operate cable box

While holding down **CABLE/DBS**, press one of the following buttons: **POWER**, **TV CH +/-**, and **Number** keys.

- For some brands, you must press **ENTER** after having pressed the **Number** keys to enter a channel number.
- To change the cable box's channels, press **TV CH +/-** or the **Number** keys. (The **CH +/-** button can be used to change the VCR's channels only.)

## NOTES:

- Depending on the type of cable box, some or all functions cannot be operated using this Remote.
- It's not possible to operate a cable box not equipped with a remote sensor.
- It's not possible to set the Remote for both your cable box and a DBS receiver at the same time. You can only set the Remote control to operate one of these units at a time.

### (Ex.) To set the Remote to RCA 14:

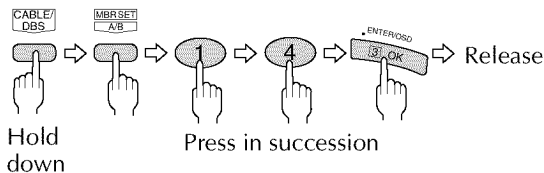

CABLE BOX BRAND NAME	BRAND CODE
ARCHER	01, 05, 17
CABLETENNA	01, 17
CABLEVIEW	15, 16, 17, 21, 25
CITIZEN	15, 16, 17, 21, 25
CURTIS	02
DIAMOND	01, 17
EASTERN	19
GC BRAND	15, 16, 17, 21, 25
GEMINI	15
GENERAL INSTRUMENTS	01, 04, 06, 11, 12, 15, 28
HAMLIN	10, 18, 19, 23
JASCO	15
JERROLD	01, 04, 06, 11, 12, 15, 28
NOVAVISION	02
OAK	07
PANASONIC	13, 14
PULSER	15, 16, 17, 21, 25
RCA	13, 14
REGAL	10, 18, 19, 23
REGENCY	19
REMBRANDT	01, 16, 17
SAMSUNG	05, 16, 24
SCIENTIFIC ATLANTA	02
SIGMA	07
SL MARX	05, 16, 17, 24, 25
SPRUCER	13, 14
STARGATE	05, 15, 16, 17, 21, 24, 25
TELEVIEW	05, 16, 24
TOCOM	01, 04, 16
UNIKA	01, 17
UNIVERSAL	16, 17, 25
VIDEOWAY	03, 09, 22
ZENITH	03, 09, 22

# DBS Receiver Brand Setting

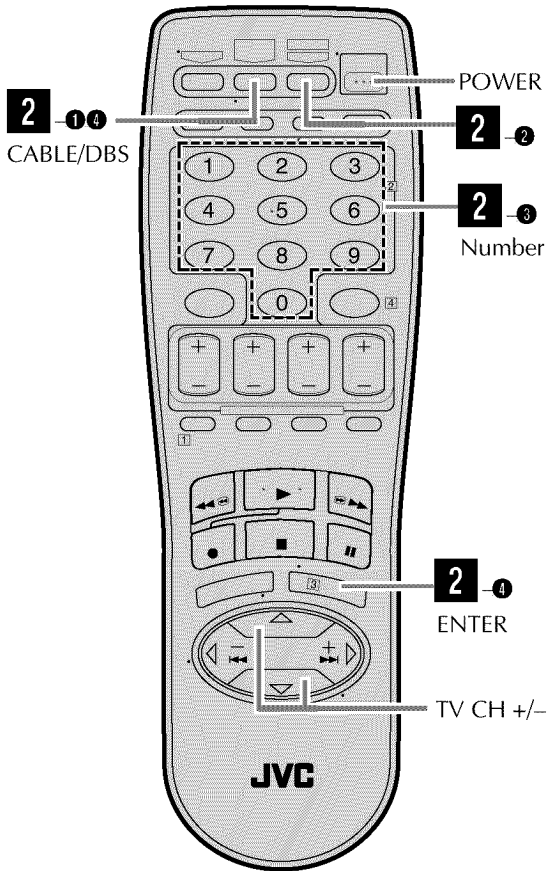

## 1 Turn on the DBS receiver

Turn on the DBS receiver using the Power button on the DBS receiver or its Remote.

## 2 Enter DBS receiver brand code

Follow the example shown below.

① Press and hold **CABLE/DBS**.

② Press **MBR SET**.

③ Press the **Number** keys to enter your DBS receiver's brand code by referring to the table below.

④ Press **OK**, and release **CABLE/DBS**.

The DBS receiver should turn off. If it does, try other operations below (→ step 3).

- Once you have set the Remote to operate the DBS receiver, you do not have to set it until you replace the batteries from the Remote.

## 3 Operate DBS receiver

While holding down **CABLE/DBS**, press one of the following buttons: **POWER**, **TV CH +/-**, and **Number** keys.

- For some brands, you must press **ENTER** after having pressed the **Number** keys to enter a channel number.
- To change the DBS receiver's channels, press **TV CH +/-** or the **Number** keys. (The **CH +/-** button can be used to change the VCR's channels only.)

## NOTES:

- Depending on the type of DBS receiver, some or all functions cannot be operated using this Remote.
- It's not possible to operate a DBS receiver not equipped with a remote sensor.
- It's not possible to set the Remote for both your DBS receiver and a cable box at the same time. You can only set the Remote to operate one of these units at a time.

DBS BRAND NAME	BRAND CODE
JVC (DISH Network)	51
ECHOSTAR (DISH Network)	51
PRIMESTAR	50
SONY (DSS)	41
RCA (DSS)	40

### (Ex.) To set the Remote to JVC 51:

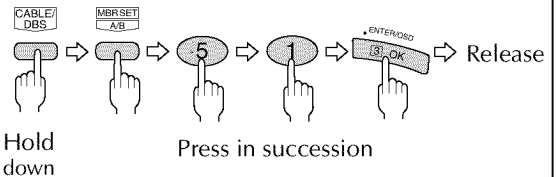

# Changing Remote Control Code

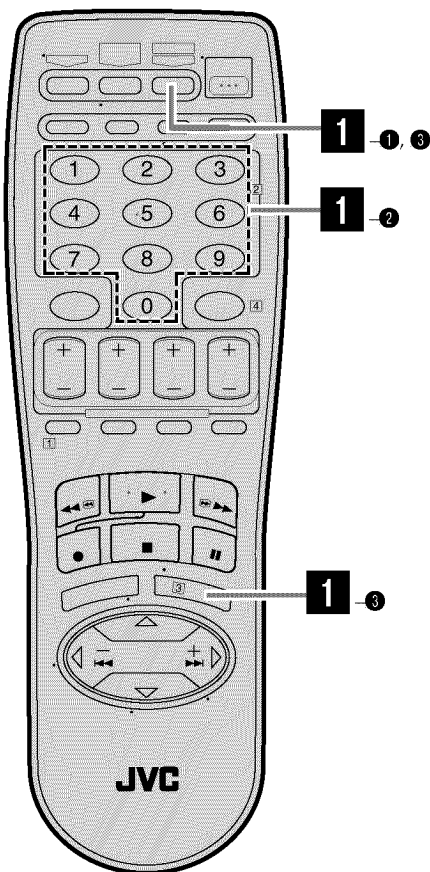
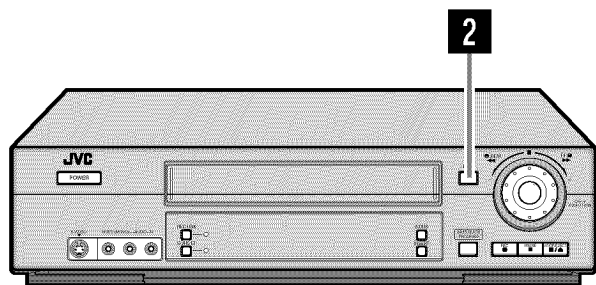

This Remote is capable of transmitting two control codes; one set to respond to A code control signals and another set to respond to B code control signals. This Remote control is preset to send A code signals because your VCR is initially set to respond to A code signals. You can easily modify your VCR and the Remote to respond to B code signals. When using two JVC VCRs, set two VCRs and their Remotes to different codes, so that you can operate these VCRs separately.

## 1 Set remote control code for Remote

- ① Press and hold A/B.
- ② Press the **Number** key "2".
- ③ Press **OK**, and release A/B.

- The Remote now can transmit B code control signals.

## 2 Check remote control code for VCR

Press and hold ► on the VCR for more than 5 seconds while the VCR is turned off. The code currently set appears on the display panel.

## 3 Change code for VCR

Press any key on the Remote.

- The VCR now responds to B code control signals.
- To set the Remote and the VCR back to A code control signals, repeat the same procedure as shown above except pressing the **Number** key "1" in step ② of 1.

### To control two VCRs with the same Remote

You can control two JVC VCRs by switching the remote control code for the Remote between A and B (step 1), keeping two VCRs to different control codes.

- Press the **Number** key "1" for A code control signals and the **Number** key "2" for B code control signals. (To change only the remote control code for the Remote, DO NOT perform steps 2 and 3.)

#### (Ex.) To set Remote to B code:

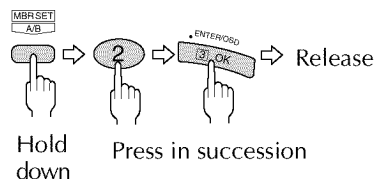

Before requesting service, use this chart and see if you can repair the trouble yourself. Small problems are often easily corrected, and this can save you the trouble of sending your VCR off for repair.

## POWER

SYMPTOM	POSSIBLE CAUSE	CORRECTIVE ACTION
1. The power will not come on.	<ul style="list-style-type: none"> <li>• The AC power cord is disconnected.</li> <li>• Child lock is on.</li> </ul>	Connect the AC power cord. Turn off child lock function (☞ pg. 45).
2. The clock works, but the VCR's power will not come on.	<ul style="list-style-type: none"> <li>• The VCR is in the timer recording standby mode with "AUTO TIMER" set to "OFF" (☞ pg. 40).</li> <li>• The child lock function is activated.</li> </ul>	Press <b>TIMER</b> to disengage.  Press and hold <b>POWER</b> for more than 10 seconds to release the child lock function (☞ pg. 45).
3. The Remote will not function.	<ul style="list-style-type: none"> <li>• The batteries are discharged.</li> <li>• Timer is on.</li> <li>• Remote control A/B code is wrong.</li> </ul>	Replace batteries. Press <b>TIMER</b> button on the remote. Reset A/B code (☞ pg. 55).

## TAPE TRANSPORT

SYMPTOM	POSSIBLE CAUSE	CORRECTIVE ACTION
1. The cassette gets stuck partway during loading, and is ejected.	<ul style="list-style-type: none"> <li>• The cassette was inserted incorrectly.</li> </ul>	Make sure the cassette's window is facing up, the rear label side is facing you and the arrow on the front of the cassette is pointing towards the VCR. Then insert the cassette.

## PLAYBACK



















SYMPTOM	POSSIBLE CAUSE	CORRECTIVE ACTION
1. The tape is running but the picture will not appear.	<ul style="list-style-type: none"> <li>• If the RF connection (☞ pg. 7) is used to view the picture, the channel on the TV is set incorrectly.</li> <li>• If the AV connection (☞ pg. 7) is used to view the picture, the TV receiver is set to the wrong mode.</li> </ul>	Select channel 3 or 4 on the TV.  Select the AV mode on the TV.
2. Breaks are noticeable in Hi-Fi sound track.	<ul style="list-style-type: none"> <li>• Automatic tracking is engaged.</li> </ul>	Disengage auto tracking and adjust the tracking manually (☞ pg. 23).
3. The playback picture is blurred or interrupted, even though TV broadcasts are clear. Or "USE CLEANING CASSETTE" appears on the screen.	<ul style="list-style-type: none"> <li>• The video heads may be dirty.</li> </ul>	The heads must be cleaned. Use a dry cleaning cassette -TCL-2UX- or consult your JVC dealer.
4. The Hi-Fi sound cannot be heard.	<ul style="list-style-type: none"> <li>• Audio Monitor setting is incorrect.</li> </ul>	Set Audio Monitor to "HI-FI" (☞ pg. 23 or 42).

## RECORDING

SYMPTOM	POSSIBLE CAUSE	CORRECTIVE ACTION
1. Recording will not start.	<ul style="list-style-type: none"> <li>• There is no cassette loaded.</li> <li>• The loaded cassette has had its record safety tab removed.</li> </ul>	Insert a cassette. Remove the cassette and cover the hole with adhesive tape, or load a cassette on which the record safety tab is intact.
2. TV broadcasts will not be recorded properly.	<ul style="list-style-type: none"> <li>• The VCR has been set to "L-1" or "F-1" input mode by mistake.</li> </ul>	Select the appropriate channel on the VCR.
3. Tape-to-tape editing will not work.	<ul style="list-style-type: none"> <li>• The components have been incorrectly connected, or correct video connector (S VIDEO or VIDEO) is not selected.</li> <li>• The power to one or more of the units has not been turned on.</li> <li>• The recording VCR's input mode has been set incorrectly.</li> </ul>	Connect the components correctly (☞ pg. 46 – 51) or check "REAR AUX INPUT" (or "FRONT AUX INPUT" only for HR-S5900U/5910U) setting (☞ pg. 43). Make sure the power to all units is on.  Select the appropriate input mode on the recording VCR.



## TIMER RECORDING

SYMPTOM	POSSIBLE CAUSE	CORRECTIVE ACTION
1. Timer recording will not work.	<ul style="list-style-type: none"> <li>• The clock and/or the timer have been set incorrectly.</li> <li>• The timer is not engaged.</li> <li>• The VCR has not been set up properly.</li> </ul>	<p>Set the clock and/or timer correctly.</p> <p>Press <b>TIMER</b> and check to make sure that  appears on the front display panel. Re-perform the set-up procedures. Make sure you have compensated for guide channel and VCR or cable box channel number mismatches ( pg. 32).</p>
2. Timer programming will not work.	<ul style="list-style-type: none"> <li>• Timer recording is in progress.</li> </ul>	<p>Timer programming cannot be performed when timer recording is in progress. Wait until it finishes.</p>
3.  and  on the front display panel will not stop blinking.	<ul style="list-style-type: none"> <li>• The timer is engaged but there is no cassette loaded.</li> </ul>	<p>Load a cassette with the record safety tab intact, or with the hole covered with adhesive tape.</p>
4. The cassette is automatically ejected, and  and  on the front display panel will not stop blinking.	<ul style="list-style-type: none"> <li>• The loaded cassette has had its record safety tab removed.</li> </ul>	<p>Remove the cassette and cover its hole with adhesive tape, or replace it with a cassette on which the safety tab is intact.</p>
5.  blinks for 10 seconds and the timer mode is disengaged.	<ul style="list-style-type: none"> <li>• <b>TIMER</b> has been pressed when there are no programs in memory, or the timer recording program has not been set correctly.</li> </ul>	<p>Check the programmed data and set again if necessary, then press <b>TIMER</b> again.</p>
6. The cassette is automatically ejected, the power shuts off and  and  will not stop blinking.	<ul style="list-style-type: none"> <li>• The tape reaches its end during timer recording.</li> </ul>	<p>The program may not have been recorded in its entirety. Next time be sure you have enough time on the tape to record the entire broadcast.</p>
7. Cable channels are not automatically switched during timer recording.	<ul style="list-style-type: none"> <li>• The Controller is not properly connected to the VCR.</li> <li>• The output channel selected in the Cable Box Set screen is incorrect.</li> <li>• The cable box is turned off.</li> </ul>	<p>Connect the Controller correctly ( pg. 15). After confirming your cable box's output channel number, re-access the Cable Box Set screen and select the correct number ( pg. 16). Make sure the power is on before timer recording starts.</p>
8. Satellite channels are not automatically switched during timer recording.	<ul style="list-style-type: none"> <li>• The Controller is not properly connected to the VCR.</li> <li>• The output channel selected in the DBS Receiver Set screen is incorrect.</li> <li>• The VCR is not set correctly to control the DBS receiver.</li> <li>• The DBS receiver is turned off.</li> </ul>	<p>Connect the Controller correctly ( pg. 18). After confirming your DBS receiver's output channel number, re-access the DBS Receiver Set screen and select the correct number ( pg. 19). Set the correct DBS receiver brand code ( pg. 20). Make sure the power is on before timer recording starts.</p>
9. Timer recording begins as scheduled, but the channel is always incorrect.	<ul style="list-style-type: none"> <li>• Even though you do not use an external cable box or DBS receiver, "CABLE BOX SET" is set to "ON" or "DBS RECEIVER SET" is set to "ON".</li> </ul>	<p>Set "CABLE BOX SET" to "OFF" ( pg. 16) or "DBS RECEIVER SET" is set to "OFF" ( pg. 19).</p>
10. You moved, and now VCR Plus+ does not work properly.	<ul style="list-style-type: none"> <li>• The receivable stations in the new area are received on different channels than those in the previous area.</li> </ul>	<p>Re-perform the Changing VCR Plus+ Setting procedure ( pg. 32).</p>
11. "PROGRAM FULL" is displayed on the screen.	<ul style="list-style-type: none"> <li>• All 8 programs of the VCR's timer memory are used.</li> </ul>	<p>Wait until a space in memory clears, or cancel unnecessary program information ( pg. 37).</p>

## OTHER PROBLEMS

SYMPTOM	POSSIBLE CAUSE	CORRECTIVE ACTION
1. When scanning channels, some of them are skipped over.	<ul style="list-style-type: none"> <li>Those channels have been preset to be skipped.</li> </ul>	If you need the skipped channels, restore them (ⓘ pg. 14).
2. The channel cannot be changed.	<ul style="list-style-type: none"> <li>Recording is in progress.</li> </ul>	Press <b>PAUSE</b> (⏸) to pause the recording, change channels, then press <b>PLAY</b> (▶) to resume recording.
3. The Remote will not operate your TV or cable box or DBS receiver.	<ul style="list-style-type: none"> <li>The brand codes are set incorrectly.</li> </ul>	Reset the correct brand codes (ⓘ pg. 52, 53 or 54).
4. Even though Auto or Semiauto Clock Set has been performed, the clock is incorrect.	<ul style="list-style-type: none"> <li>The clock setting data received from the host channel is incorrect.</li> </ul>	Select a different host channel during Semiauto Clock Set (ⓘ pg. 11), or perform Manual Clock Set (ⓘ pg. 12).

### MOISTURE CONDENSATION

Moisture in the air will condense on the VCR when you move it from a cold place to a warm place, or under extremely humid conditions—just as water droplets form on the surface of a glass filled with cold liquid. Moisture condensation on the head drum will cause damage to the tape. In conditions where condensation may occur, keep the VCR turned on for a few hours to evaporate the moisture before inserting a tape.

### ATTENTION

This VCR contains microcomputers. External electronic noise or interference can cause microcomputer to malfunction. If the VCR does not operate correctly switch its power off and unplug the AC power cord from the AC supply. Wait for a while and then plug the power back in. Eject and check the condition of the cassette. If everything appears normal, you can operate the VCR as usual.

## Questions and answers

### PLAYBACK

- Q. What happens if the tape reaches its end during playback or search?**  
 A. The VCR automatically rewinds it to the beginning.
- Q. Can the VCR indefinitely remain in still mode?**  
 A. No. It stops automatically after 5 minutes to protect the heads.
- Q. During picture search, still picture playback and frame-by-frame playback, the picture is intermittent. What's the cause?**  
 A. Picture loss occurs when these types of playback are attempted with a tape recorded in LP mode. Pressing **PLAY (▶)** to return to normal playback will restore the picture.
- Q. When returning from variable-speed picture search to normal playback, the picture is disturbed. Should I be concerned about this?**  
 A. No, it is normal.
- Q. When playing back programs that have been timer-recorded consecutively (such one program from 8:00 to 9:00 and another one from 9:00 to 10:00), the picture and sound become momentarily distorted where the first program ends and the second program begins. Is this a malfunction?**  
 A. No. This is normal.
- Q. Other than preventing further recording, what effect does removing the safety tab have?**  
 A. It disables marking of index codes.
- Q. Sometimes, during index search, the VCR cannot find the program I want to see. Why not?**  
 A. There may be index codes too close together.
- Q. During playback, on-screen display sometimes jitters. Why does this happen?**  
 A. If the condition of the tape being played back is not good, jittering of the video (including on-screen display) may occur.

### RECORDING

- Q. When I pause and then resume a recording, the end of the recording before the pause is overlapped by the new recording. Why does this happen?**  
 A. This is normal. It reduces distortion at the pause and resume points.
- Q. Can the VCR indefinitely remain in the recording pause mode?**  
 A. No. The VCR automatically stops after 5 minutes to protect the heads. When paused during Instant Timer Recording (ITR), the VCR shuts off automatically after 5 minutes.
- Q. What happens if the tape reaches its end during recording?**  
 A. Recording stops and  on the front display panel blinks.

### TIMER RECORDING

- Q. REC and ⊖ remain lit on the front display panel. Is there a problem?**  
 A. No. This is a normal condition for a timer recording in progress.
- Q. Can I program the timer while I'm watching a tape or a TV broadcast?**  
 A. Yes, but while you are setting the timer you will not see the tape's or broadcast program's picture as it is replaced by the on-screen menu. (The sound from the tape or broadcast program will be heard during the timer setting.)

## List of terms

This guide serves as a quick way to locate frequently used terms and on-screen display names.

### A

Accidental erasure prevention 26  
 AUDIO MONITOR 42  
 Audio Monitor 23  
 Auto Daylight Saving Time 11  
 AUTO SP → EP TIMER 41  
 AUTO TIMER 40  
 Automatic tracking 23  
 AV COMPU-LINK 42

### B

Basic connections  
   AV connection 6  
   RF connection 6  
   S-video connection 6  
 BLUE BACK 41

### C

Cable box control setting 15  
   Brand 16  
   Installing Controller 15  
   Output channel 16  
 Channel No. indication 26  
 Clock setting 10  
   Manual setting 12  
   Preparation 10  
   Semiauto setting 11  
 Clock time 22, 26  
 Contents 5  
 Counter reset 22, 26

### D

DBS receiver control setting 18  
   Brand 19  
   Installing Controller 18  
   Output channel 19

### E

Editing  
   From a camcorder 46  
   From another VCR 48  
   To another VCR 48  
 Express timer programing 34

### F

FRONT AUX INPUT 43  
 Function Set screen 39

### G

Guide channel 32

### H

Host channel 8

### I

Index Search 24  
 Instant Review 24  
 Instant Timer Recording (ITR) 26

### L

Language setting 9

### M

Manual tracking 23  
 Multi-Brand Remote  
   Setting cable box brand 53  
   Setting DBS receiver brand 54  
   Setting TV brand 52

### N

Next Function Memory 23

### O

On-screen display 27

### P

PBS channel 8  
 PICTURE CONTROL 40  
 Playback 21  
 Plug & Play 8

### R

REAR AUX INPUT 43  
 Recording 25  
 Repeat play 22

### S

S-VHS MODE 42  
 Satellite Auto Recording 44  
 Special effect playback  
   Frame-by-Frame Playback 29  
   High-Speed Picture Search 28  
   How to use the JOG dial 28  
   How to use the SHUTTLE PLUS  
     buttons 29  
   Picture Search 28  
   Skip Search 29  
   Slow Motion Playback 29  
   Still Picture Playback 29  
   Variable-Speed Picture Search 28  
 Specifications 65  
 SUPERIMPOSE 40

### T

Tape speed 25, 44  
 Time counter 22, 26  
 Time zone selection 11  
 Timer recording  
   Canceling 37  
   Changing 37  
   Checking 37  
   Express 34  
   Guide channel setting 32  
   VCR Plus+ 30  
 Timer warning display 36  
 Tracking 23  
 Troubleshooting 56  
 Tuner setting  
   Adding channels 14  
   Auto Channel Set 13  
   Deleting channels 14  
   Manual Channel Set 14

### V

VCR Plus+ timer programing 30  
 VIDEO CALIBRATION 40  
 VIDEO STABILIZER 41

24HR quick programing 36  
 2ND AUDIO RECORD 41

## Front panel (HR-S5900U/5910U)

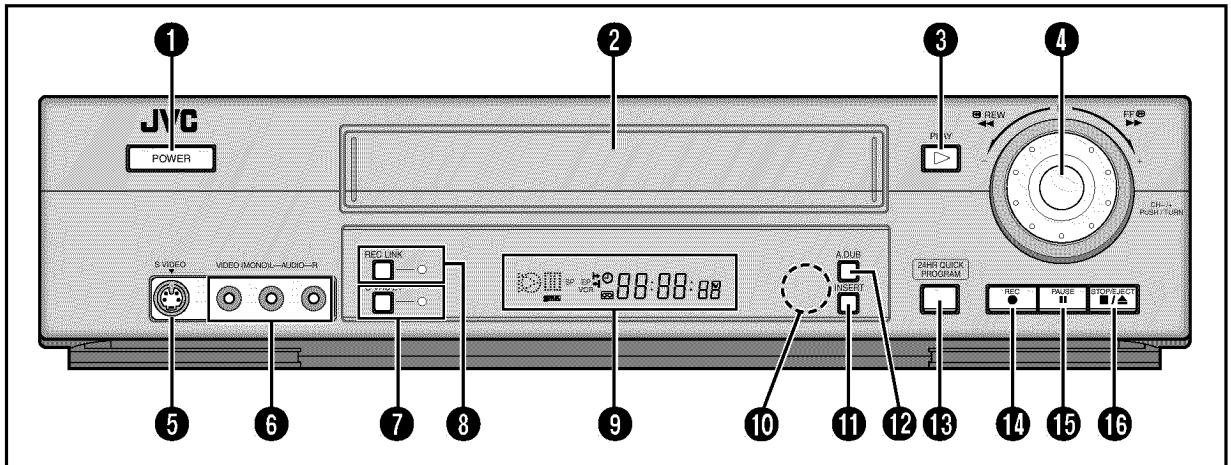

## Front panel (HR-S3900U/3910U)

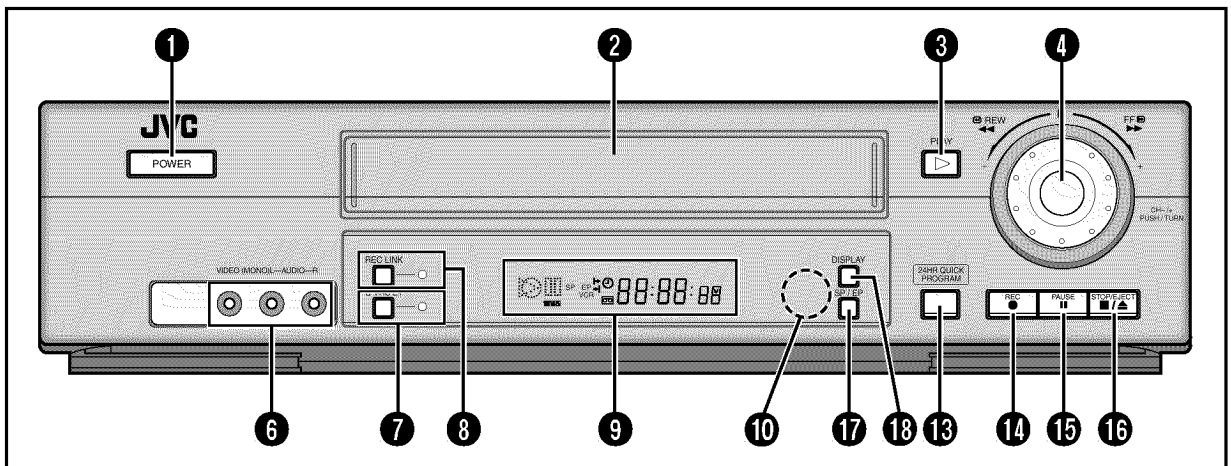

- ❶ POWER button : ☞ pg. 21, 25
- ❷ Cassette loading slot
- ❸ PLAY (▷) button : ☞ pg. 21
- ❹ Advanced JOG dial : ☞ pg. 21, 25, 28
- ❺ S VIDEO input connector (ONLY FOR HR-S5900U/5910U) : ☞ pg. 46, 50
- ❻ AUDIO/VIDEO input connectors : ☞ pg. 49, 50
- ❼ S VHS ET button and lamp : ☞ pg. 27
- ❽ REC LINK button and lamp : ☞ pg. 44
- ❾ Front display panel : ☞ pg. 62
- ❿ Remote sensor
- ⓫ INSERT button  
(ONLY FOR HR-S5900U/5910U) : ☞ pg. 51
- ⓬ A.DUB button  
(ONLY FOR HR-S5900U/5910U) : ☞ pg. 49
- ⓭ 24HR QUICK PROGRAM button : ☞ pg. 36
- ⓮ REC (●) button : ☞ pg. 25, 26
- ⓯ PAUSE (⏸) button : ☞ pg. 25, 29
- ⓰ STOP/EJECT (■/▲) button : ☞ pg. 21, 25
- ⓱ SP/EP button (ONLY FOR HR-S3900U/3910U) :  
☞ pg. 25, 31, 35
- ⓲ DISPLAY button  
(ONLY FOR HR-S3900U/3910U) : ☞ pg. 22, 26

## Front display panel

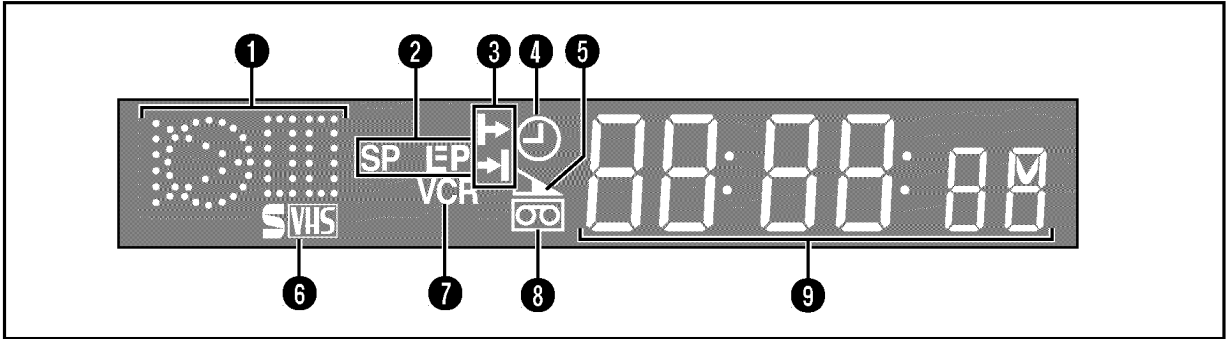

### 1 Symbolic Mode Indicators

PLAY: FF/REW VARIABLE SHUTTLE SEARCH:		STILL: SLOW:	
		RECORD:	
		RECORD PAUSE:	
AUDIO DUBBING*:			
AUDIO DUBBING PAUSE*:			
INSERT*:			
INSERT PAUSE*:			
AUDIO DUBBING INSERT*:			
AUDIO DUBBING INSERT PAUSE*:			

\* ONLY FOR HR-S5900U/5910U.

### 2 Tape speed indicators

3 Program start time and stop time indicator :  
 pg. 36

4 Timer mode indicator : pg. 31, 35

5 Tape remaining time indicator : pg. 22, 26

6 S-VHS indicator : pg. 21, 27

7 VCR mode indicator : pg. 25, 26

8 Cassette mark

9 Channel and auxiliary input ("L-1" and "F-1")

Counter reading : pg. 22, 26

Clock time : pg. 22, 26

## Rear panel

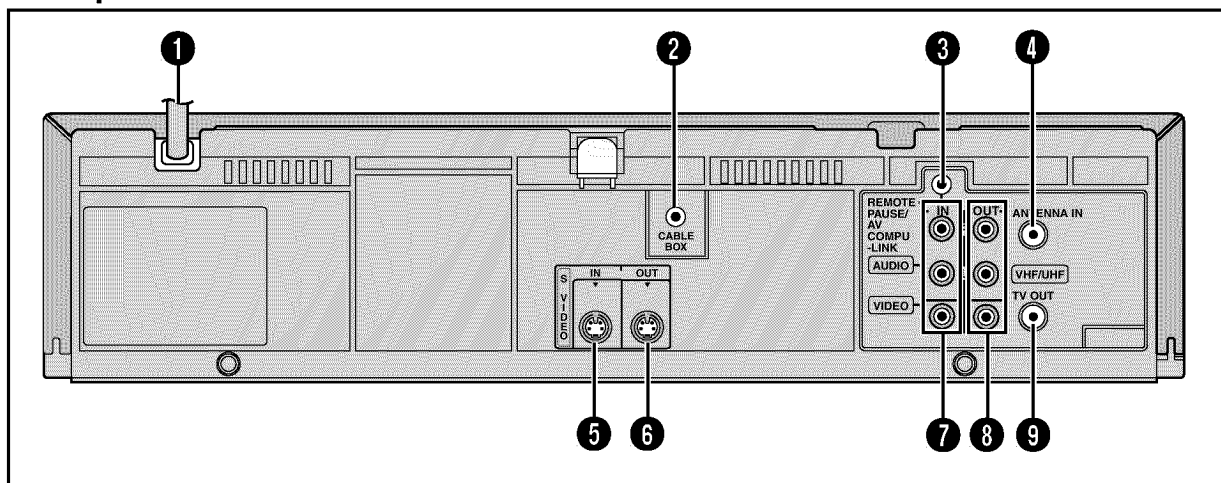

- ❶ AC power cord : [pg. 6](#)
- ❷ CABLE BOX Controller connector :  
[pg. 15, 18](#)
- ❸ REMOTE PAUSE/AV COMPULINK terminal
  - REMOTE PAUSE terminal : [pg. 42, 46](#)
  - AV COMPULINK terminal : [pg. 42](#)
- ❹ ANTENNA IN terminal : [pg. 6](#)
- ❺ S VIDEO IN connector : [pg. 50](#)
- ❻ S VIDEO OUT connector : [pg. 6](#)
- ❼ AUDIO/VIDEO IN connectors : [pg. 50](#)
- ❽ AUDIO/VIDEO OUT connectors : [pg. 48](#)
- ❾ TV OUT terminal : [pg. 6](#)

## On-screen display

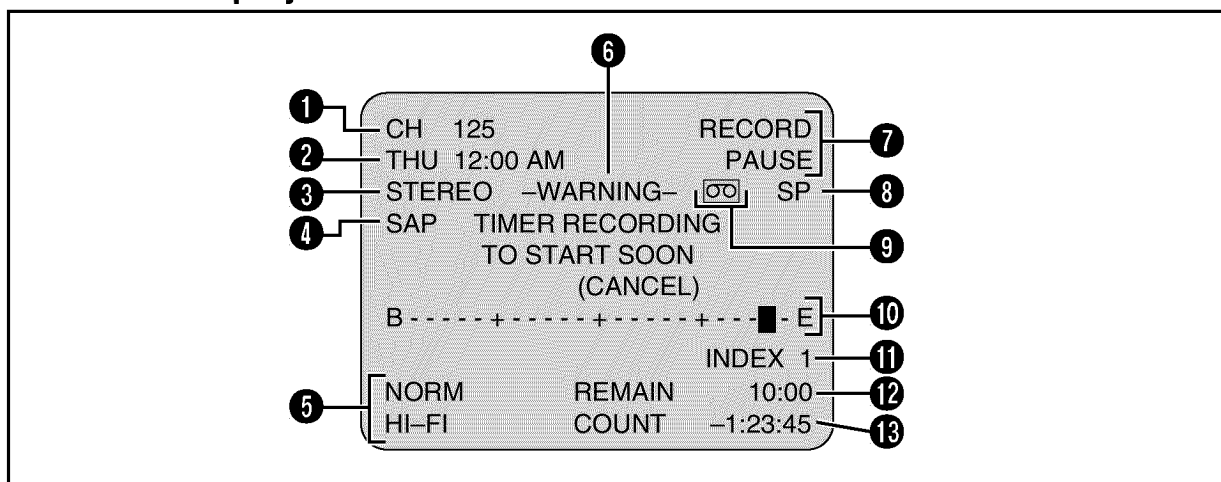

- ❶ Channel and auxiliary input ("L-1" and "F-1")
- ❷ Day and clock time
- ❸ STEREO program indication : [pg. 27](#)
- ❹ SAP (Second Audio Program) indication :  
[pg. 27](#)
- ❺ Audio monitor indications : [pg. 23, 42](#)
- ❻ Timer warning display : [pg. 36](#)
- ❼ VCR operation mode indication
- ❽ Tape speed indication
- ❹ Cassette indication
- ❺ Tape position indicator : [pg. 22](#)
- ❻ Index no. indication : [pg. 24](#)
- ❼ Tape remaining time : [pg. 22, 26](#)
- ❽ Time counter : [pg. 22, 26](#)

## Remote

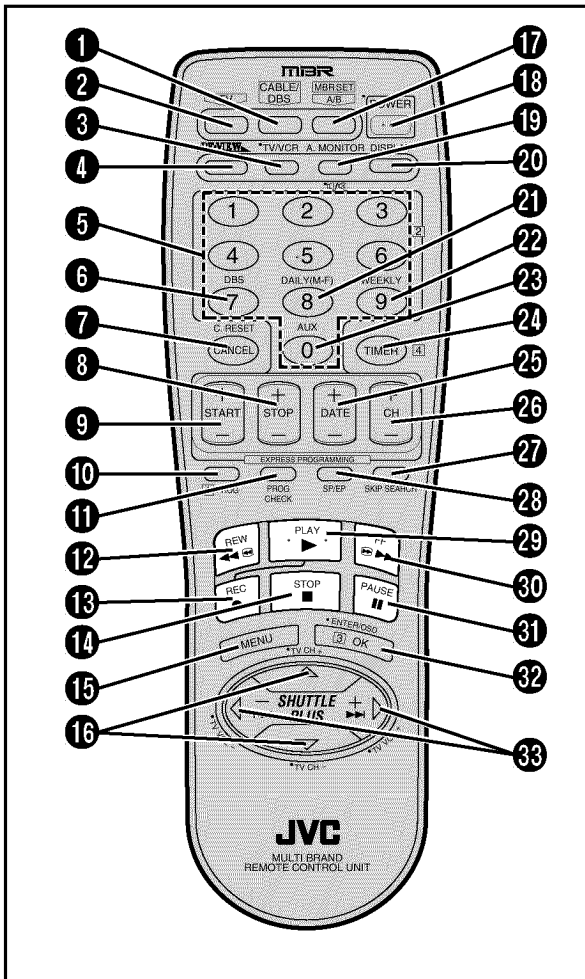

The glow-in-the-dark buttons shown in white on the illustration above are helpful when using the Remote in darkened rooms.

Buttons with a small dot on the left side of the name can also be used to operate your TV while holding down TV on the Remote. (pg. 52).

- ① CABLE/DBS button : pg. 53, 54
- ② TV button: pg. 52
- ③ TV/VCR button : pg. 25, 26, 52
- ④ REVIEW button : pg. 24
- ⑤ Number buttons : pg. 25, 30, 33
- ⑥ DBS button : pg. 35
- ⑦ CANCEL button : pg. 31, 37
- ⑧ STOP +/- button : pg. 31, 34
- ⑨ START +/- button : pg. 34
- ⑩ PROG. (Program) button : pg. 30, 34
- ⑪ PROG. CHECK button : pg. 37
- ⑫ REW ( ◀ ◀ ) button : pg. 21, 25, 28
- ⑬ REC ( ● ) button : pg. 25, 26
- ⑭ STOP ( ■ ) button : pg. 21, 25
- ⑮ MENU button
- ⑯ SHUTTLE PLUS Δ∇ buttons
- ⑰ TV CH +/- buttons : pg. 52, 53, 54
- ⑱ MBR SET button : pg. 52, 53, 54
- ⑲ A/B button : pg. 55
- ⑳ POWER button : pg. 21, 25
- ㉑ A. (Audio) MONITOR button : pg. 23
- ㉒ (TV Muting) button : pg. 52
- ㉓ DISPLAY button : pg. 22, 26
- ㉔ DAILY (M-F) button : pg. 31, 35
- ㉕ WEEKLY button : pg. 31, 35
- ㉖ AUX button : pg. 47, 48, 49, 51
- ㉗ TIMER button : pg. 31, 35, 37
- ㉘ DATE +/- button : pg. 34
- ㉙ CH +/- button : pg. 25, 34
- ㉚ SKIP SEARCH button : pg. 29
- ㉛ SP/EP button : pg. 25, 31, 35
- ㉜ PLAY ( ▶ ) button: pg. 21, 25
- ㉝ FF ( ▶▶ ) button: pg. 21, 25, 28
- ㉞ PAUSE ( || ) button: pg. 25, 29
- ㉟ OK button
- ENTER button : pg. 52, 53, 54
- OSD button : pg. 27
- ㊸ SHUTTLE PLUS ◀◀▶▶ (◀▶) button : pg. 29
- TV VOL +/- button : pg. 52

**How to use the Remote**

Before use, insert two AA size batteries into the Remote with the polarity (⊕ and ⊖) matched correctly as indicated on the battery compartment or on the lid.

The Remote can operate most of your VCR's functions, as well as basic functions of TV sets, cable boxes and DBS receivers.

- Point the Remote toward the remote sensor on the target component.
- The maximum operating distance of the remote control is about 8 m.

**NOTE:**

If the Remote does not work properly, remove its batteries, wait for a few seconds, replace the batteries and then try again.



## GENERAL

Power requirement	: AC 120 V $\sim$ , 60 Hz
Power consumption	
Power on	: 20 W
Power off	: 2.5 W
Temperature	
Operating	: 5°C to 40°C (41°F to 104°F)
Storage	: -20°C to 60°C (-4°F to 140°F)
Operating position	: Horizontal only
Dimensions (W x H x D)	: 400 x 94 x 283 mm
Weight	: 3.3 kg
Format	: S-VHS/VHS NTSC standard
Maximum recording time	
SP	: 210 min. with ST-210 video cassette
EP	: 630 min. with ST-210 video cassette

## VIDEO/AUDIO

Signal system	: NTSC-type color signal and EIA monochrome signal, 525 lines/60 fields
Recording/ Playback system	: DA-4 (Double Azimuth) head helical scan system
Signal-to-noise ratio	: 45 dB
Horizontal resolution	
VHS	: 230 lines
S-VHS	: 400 lines
Frequency range	
Normal audio	: 70 Hz to 10,000 Hz
Hi-Fi audio	: 20 Hz to 20,000 Hz
Input/Output	: RCA connectors (IN x 2, OUT x 1) S-video connectors For HR-S5900U/5910U: (IN x 2, OUT x 1) For HR-S3900U/3910U: (IN x 1, OUT x 1)

## TUNER

Tuning system	: Frequency-synthesized tuner
Channel coverage	
VHF	: Channels 2-13
UHF	: Channels 14-69
CATV	: 113 Channels
RF output	: Channel 3 or 4 (switchable; preset to Channel 3 when shipped) 75 ohms, unbalanced

## TIMER

Clock reference	: Quartz
Program capacity	: 1-year programmable timer/8 programs
Memory backup for timer	is not supported.

## ACCESSORIES

Provided accessories	: Infrared remote control unit, "AA" battery x 2, S-video cable (4-pin), RF cable (F-type)
----------------------	--

*Specifications shown are for SP mode unless specified otherwise.*

*E. & O.E. Design and specifications subject to change without notice.*

### Usable cassettes

Full-Size VHS  
T-30 (ST-30\*\*)  
T-60 (ST-60\*\*)  
T-90  
T-120 (ST-120\*\*)  
T-160 (ST-160\*\*)  
ST-210\*\*

Compact VHS\*  
TC-20 (ST-C20\*\*)  
TC-30 (ST-C30\*\*)  
TC-40 (ST-C40\*\*)

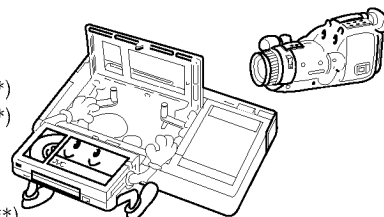

\* Compact VHS camcorder recordings can be played on this video recorder. Simply place the recorded cassette into a VHS Cassette Adapter and it can be used just like any full-sized VHS cassette.

\*\* This VCR can record on regular VHS and Super VHS cassettes. While only VHS signals can be recorded on regular VHS cassettes <sup>1)</sup>, both VHS and Super VHS signals can be recorded and played back using Super VHS cassettes.

<sup>1)</sup> By using the S-VHS ET function, it is possible to record and play back with S-VHS picture quality on VHS cassettes on this VCR.

**HOW TO LOCATE YOUR JVC SERVICE CENTER****TOLL FREE: 1-800-537-5722****<http://www.jvc.com>****Dear customer,**

*In order to receive the most satisfaction from your purchase, please read the instruction booklet before operating the unit. In the event that repair is necessary, or for the address nearest your location within the Continental United States, please call 1-800-537-5722 for your nearest authorized servicer or visit our website at [www.JVC.com](http://www.JVC.com). Remember to retain your Bill of Sale for Warranty Service.*

— JVC

**JVC SERVICE & ENGINEERING  
COMPANY OF AMERICA  
DIVISION OF JVC AMERICAS CORP.**

*Sophisticated electronic products may require occasional service. Just as quality is a keyword in the engineering and production of the wide array of JVC products, service is the key to maintaining the high level performance for which JVC is world famous. The JVC service and engineering organization stands behind our products.*

NATIONAL HEADQUARTERS  
JVC SERVICE & ENGINEERING COMPANY OF AMERICA  
DIVISION OF JVC AMERICAS CORP.  
10 New Maple Avenue  
Pine Brook, NJ 07058-9641

**ACCESSORIES**

*To purchase accessories for your JVC product, you may contact your local JVC Dealer. From the 48 Continental United States call toll free: 1-800-882-2345 or on the web at [www.JVC.com](http://www.JVC.com)*

**Don't service the product yourself.****CAUTION**

*To prevent electrical shock, do not open the cabinet. There are no user serviceable parts inside. Please refer to qualified service personnel for repairs.*

**LIMITED WARRANTY**

**CONSUMER VIDEO 1-90**

JVC COMPANY OF AMERICA warrants this product and all parts thereof, except as set forth below ONLY TO THE ORIGINAL PURCHASER AT RETAIL to be FREE FROM DEFECTIVE MATERIALS AND WORKMANSHIP from the date of original retail purchase for the period as shown below. ("The Warranty Period")

PARTS	<b>1</b> YR	LABOR	<b>90</b> DAYS
-------	-------------	-------	----------------

THIS LIMITED WARRANTY IS VALID ONLY IN THE FIFTY (50) UNITED STATES, THE DISTRICT OF COLUMBIA AND IN COMMONWEALTH OF PUERTO RICO.

**WHAT WE WILL DO:**

If this product is found to be defective, JVC will repair or replace defective parts at no charge to the original owner. Such repair and replacement services shall be rendered by JVC during normal business hours at JVC authorized service centers. Parts used for replacement are warranted only for the remainder of the Warranty Period. All products and parts thereof may be brought to a JVC authorized service center on a carry-in basis except for Television sets having a screen size 25 inches and above which are covered on an in-home basis.

**WHAT YOU MUST DO FOR WARRANTY SERVICE:**

Return your product to a JVC authorized service center with a copy of your bill of sale. For your nearest JVC authorized service center, please call toll free: (800) 537-5722.

If service is not available locally, box the product carefully, preferably in the original carton, and ship, insured, with a copy of your bill of sale plus a letter of explanation of the problem to the nearest JVC Factory Service Center, the name and location of which will be given to you by the toll-free number.

If you have any questions concerning your JVC Product, please contact our Customer Relations Department.

**WHAT IS NOT COVERED:**

This limited warranty provided by JVC does not cover:

1. Products which have been subject to abuse, accident, alteration, modification, tampering, negligence, misuse, faulty installation, lack of reasonable care, or if repaired or serviced by anyone other than a service facility authorized by JVC to render such service, or if affixed to any attachment not provided with the products, or if the model or serial number has been altered, tampered with, defaced or removed;
2. Initial installation and installation and removal for repair;
3. Operational adjustments covered in the Owner's Manual, normal maintenance, video and audio head cleaning;
4. Damage that occurs in shipment, due to act of God, and cosmetic damage;
5. Signal reception problems and failures due to line power surge;
6. Video Pick-up Tubes/CCD Image Sensor, Cartridge, Stylus (Needle) are covered for 90 days from the date of purchase;
7. Accessories;
8. Batteries (except that Rechargeable Batteries are covered for 90 days from the date of purchase)

There are no other express warranties except as listed above.

THE DURATION OF ANY IMPLIED WARRANTIES INCLUDING THE IMPLIED WARRANTY OF MERCHANTABILITY, IS LIMITED TO THE DURATION OF THE EXPRESS WARRANTY HEREIN.

JVC SHALL NOT BE LIABLE FOR THE LOSS OF USE OF THE PRODUCT, INCONVENIENCE, LOSS OR ANY OTHER DAMAGES, WHETHER DIRECT, INCIDENTAL OR CONSEQUENTIAL (INCLUDING, WITHOUT LIMITATION, DAMAGE TO TAPES, RECORDS OR DISCS) RESULTING FROM THE USE OF THIS PRODUCT, OR ARISING OUT OF ANY BREACH OF THIS WARRANTY. ALL EXPRESS AND IMPLIED WARRANTIES, INCLUDING THE WARRANTIES OF MERCHANTABILITY AND FITNESS FOR PARTICULAR PURPOSE, ARE LIMITED TO THE WARRANTY PERIOD SET FORTH ABOVE.

Some states do not allow the exclusion of incidental or consequential damages or limitations on how long an implied warranty lasts, so these limitations or exclusions may not apply to you. This warranty gives you specific legal rights and you may also have other rights which vary from state to state.

JVC COMPANY OF AMERICA  
DIVISION OF JVC AMERICAS CORP.

1700 Valley Road  
Wayne, New Jersey 07470

REFURBISHED PRODUCTS CARRY A SEPARATE WARRANTY, THIS WARRANTY DOES NOT APPLY. FOR DETAILS OF REFURBISHED PRODUCT WARRANTY, PLEASE REFER TO THE REFURBISHED PRODUCT WARRANTY INFORMATION PACKAGED WITH EACH REFURBISHED PRODUCT.

**For customer use:**

Enter below the Model No. and Serial No. which is located either on the rear, bottom or side of the cabinet. Retain this information for future reference.

Model No.: \_\_\_\_\_

Serial No.: \_\_\_\_\_

Purchase date: \_\_\_\_\_

Name of dealer: \_\_\_\_\_

HR-S5900U/5910U  
HR-S3900U/3910U

**JVC**

VICTOR COMPANY OF JAPAN, LIMITED