

# JVC

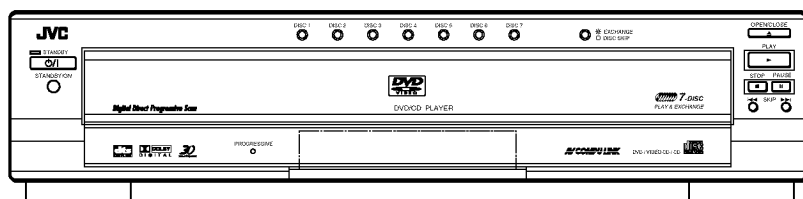

## DVD VIDEO PLAYER

# XV-F80BK/XV-F85GD

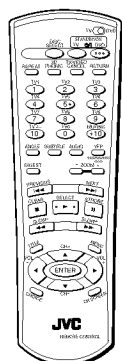

Video CD



**AV COMPU LINK**

## INSTRUCTIONS

Introduction	2
Preliminary knowledge	6
Getting started	16
Basic operations	24
Advanced operations	30
MP3 disc playback	46
Initial settings	49
Additional information	56

### For Customer Use:

Enter below the Model No. and Serial No. which are located on the rear, bottom or side of the cabinet. Retain this information for future reference.

Model No. \_\_\_\_\_

Serial No. \_\_\_\_\_

LET0189-001B

[J]

# Warnings, Cautions and Others

## Mises en garde, précautions et indications diverses

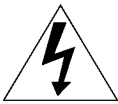
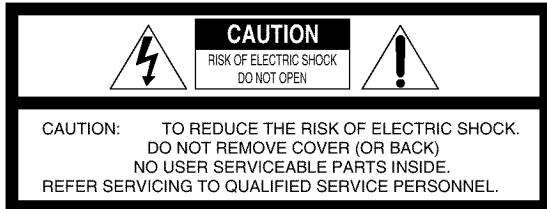

The lightning flash with arrowhead symbol, within an equilateral triangle is intended to alert the user to the presence of uninsulated "dangerous voltage" within the product's enclosure that may be of sufficient magnitude to constitute a risk of electric shock to persons.



The exclamation point within an equilateral triangle is intended to alert the user to the presence of important operating and maintenance (servicing) instructions in the literature accompanying the appliance.

### For U.S.A.

This equipment has been tested and found to comply with the limits for a Class B digital device, pursuant to part 15 of the FCC Rules. These limits are designed to provide reasonable protection against harmful interference in a residential installation.

This equipment generates, uses and can radiate radio frequency energy and, if not installed and used in accordance with the instructions, may cause harmful interference to radio communications. However, there is no guarantee that interference will not occur in a particular installation. If this equipment does cause harmful interference to radio or television reception, which can be determined by turning the equipment off and on, the user is encouraged to try to correct the interference by one or more of the following measures:

- Reorient or relocate the receiving antenna.
- Increase the separation between the equipment and receiver.
- Connect the equipment into an outlet on a circuit different from that to which the receiver is connected.
- Consult the dealer or an experienced radio/TV technician for help.

**WARNING: TO REDUCE THE RISK OF FIRE OR ELECTRIC SHOCK, DO NOT EXPOSE THIS APPLIANCE TO RAIN OR MOISTURE.**

### For Canada/pour le Canada

**CAUTION: TO PREVENT ELECTRIC SHOCK, MATCH WIDE BLADE OF PLUG TO WIDE SLOT, FULLY INSERT**

**ATTENTION: POUR EVITER LES CHOCS ELECTRIQUES, INTRODUIRE LA LAME LA PLUS LARGE DE LA FICHE DANS LA BORNE CORRESPONDANTE DE LA PRISE ET POUSSER JUSQU'AU FOND**

### For Canada / Pour le Canada

THIS DIGITAL APPARATUS DOES NOT EXCEED THE CLASS B LIMITS FOR RADIO NOISE EMISSIONS FORM DIGITAL APPARATUS AS SET OUT IN THE INTERFERENCE-CAUSING EQUIPMENT STANDARD ENTITLED "DIGITAL APPARATUS," ICES-003 OF THE DEPARTMENT OF COMMUNICATIONS.

CET APPAREIL NUMERIQUE RESPECTE LES LIMITES DE BRUITS RADIOELECTRIQUES APPLICABLES AUX APPAREILS NUMERIQUE DE CLASSE B PRESCRITES DANS LA NORME SUR LE MATERIEL BROUILLEUR: "APPAREILS NUMERIQUE", NMB-003 EDICTEE PAR LE MINISTRE DES COMMUNICATIONS.

### CAUTION

To reduce the risk of electrical shocks, fire, etc.:

1. Do not remove screws, covers or cabinet.
2. Do not expose this appliance to rain or moisture.

### ATTENTION

Afin d'éviter tout risque d'électrocution, d'incendie, etc.:

1. Ne pas enlever les vis ni les panneaux et ne pas ouvrir le coffret de l'appareil.
2. Ne pas exposer l'appareil à la pluie ni à l'humidité.

### Caution — STANDBY/ON switch!

Disconnect the mains plug to shut the power off completely. The STANDBY/ON  switch in any position does not disconnect the mains line. The power can be remote controlled.

### Attention — Commutateur STANDBY/ON switch!

Déconnecter la fiche de secteur pour couper complètement le courant. Le commutateur STANDBY/ON  ne coupe jamais complètement la ligne de secteur, quelle que soit sa position. Le courant peut être télécommandé.

### IMPORTANT FOR LASER PRODUCTS IMPORTANT POUR LES PRODUITS LASER

1. CLASS 1 LASER PRODUCT
  2. **CAUTION:** Visible laser radiation when open and interlock failed or defeated. Avoid direct exposure to beam.
  3. **CAUTION:** Do not open the top cover. There are no user serviceable parts inside the Unit; leave all servicing to qualified service personnel.
1. PRODUIT LASER CLASSE 1
  2. **ATTENTION:** Radiation laser visible quand l'appareil est ouvert ou que le verrouillage est en panne ou désactivé. Eviter une exposition directe au rayon.
  3. **ATTENTION:** Ne pas ouvrir le couvercle du dessus. Il n'y a aucune pièce utilisable à l'intérieur. Laisser à un personnel qualifié le soin de réparer votre appareil.

### CAUTION:

- Do not block the ventilation openings or holes. (If the ventilation openings or holes are blocked by a newspaper or cloth, etc., the heat may not be able to get out.)
- Do not place any naked flame sources, such as lighted candles, on the apparatus.
- When discarding batteries, environmental problems must be considered and local rules or laws governing the disposal of these batteries must be followed strictly.
- Do not use this apparatus in a bathroom or places with water. Also do not place any containers filled with water or liquids (such as cosmetics or medicines, flower vases, potted plants, cups, etc.) on top of this apparatus.

### ATTENTION

- Ne bloquez pas les orifices ou les trous de ventilation. (Si les orifices ou les trous de ventilation sont bloqués par un journal un tissu, etc., la chaleur peut ne pas être évacuée correctement de l'appareil.)
- Ne placez aucune source de flamme nue, telle qu'une bougie, sur l'appareil.
- Lors de la mise au rebut des piles, veuillez prendre en considération les problèmes de l'environnement et suivre strictement les règles et les lois locales sur la mise au rebut des piles.
- N'utilisez pas cet appareil dans une salle de bain ou un autre endroit avec de l'eau. Ne placez aucun récipient contenant de l'eau (tel que des cosmétiques ou des médicaments, un vase de fleurs, un pot de fleurs, une tasse, etc.) sur cet appareil.

# Table of Contents

<b>Introduction</b>	Page 2
<b>Features</b>	2
<b>Supplied accessories</b>	3
<b>About this instruction manual</b>	4
<b>Notes on handling</b>	5
<b>Preliminary knowledge</b>	Page 6
<b>Names of parts and controls</b>	6
Front panel	6
Display window	7
Remote control unit	8
Rear panel	10
<b>Operational Principles</b>	11
On-screen displays	11
To prevent the monitor from burning out [SCREEN SAVER]	13
On-screen guide icons	14
How to use numeric buttons	14
<b>About discs</b>	15
Playable disc types	15
Disc structure	15
<b>Getting started</b>	Page 16
<b>Connections</b>	16
Before making any connections	16
To connect to a conventional TV	16
To connect to a TV with the component video input jacks	17
To connect to an audio amplifier or receiver	18
To connect to audio equipment with a digital input	19
To connect the power cord	20
<b>Using the remote control unit</b>	20
To install batteries in the remote control unit	20
Remote sensor	21
To use the remote control unit for TV operation	22
<b>Basic operations</b>	Page 24
<b>Turning on/off the unit</b>	24
<b>Inserting and removing discs</b>	24
<b>Basic playback</b>	26
To start playback	26
To stop playback completely	27
To stop playback temporarily	27
To advance or reverse playback rapidly while monitoring	27
To locate the beginning of the scene or song	28
Changing discs during playback [PLAY EXCHANGE]	28
<b>Resuming playback</b>	29
To memorize the interrupted position	29
To resume playback	29
<b>Advanced operations</b>	Page 30
<b>Playing from a specific position on a disc</b>	30
To locate a desired scene from the DVD menu	30
To locate a desired scene from the menu of the Video CD with PBC	30
To locate a desired selection using the numeric buttons	31

To locate a desired selection using ◀◀ or ▶▶	31
To locate a desired scene by specifying the chapter number [CHAP.SEARCH]	32
To locate a desired position in the current title or track [TIME SEARCH]	32
To locate a desired scene from the display [DIGEST]	33
<b>Special picture playback</b>	34
To advance a still picture frame-by-frame	34
To display continuous still pictures [STROBE]	34
To playback in slow-motion [SLOW]	35
To zoom in/out [ZOOM]	35
<b>Changing the playback order</b>	36
To playback in the desired order [PROGRAM]	36
To playback in random order [RANDOM]	37
<b>Repeat playback</b>	37
To repeat the current selection or all tracks [REPEAT]	37
To repeat a desired part [A-B REPEAT]	39
<b>Selecting a scene angle of DVD VIDEO</b>	40
To select a scene angle from the normal screen [ANGLE]	40
To select a scene angle from the angle list display [ANGLE]	41
<b>Changing the language and sound</b>	41
To select the subtitle language [SUBTITLE]	41
To change the audio language or sound [AUDIO]	42
<b>Miscellaneous functions</b>	43
To adjust the picture character [VFP]	43
To simulate surround sound [3D PHONIC]	44
To check the disc time [TIME SELECT]	45
Changing the brightness of the display window	45

<b>MP3 disc playback</b>	Page 46
<b>About MP3 disc</b>	46
<b>Operations</b>	46
Basic operations	46
Specifying the desired Group and Track	47
Repeat playback	48

<b>Initial settings</b>	Page 49
<b>Selecting preferences</b>	49
How to set preferences	49
Language and display preference	49
Audio and system preference	51
<b>Limiting playback by children</b>	53
To set Parental Lock for the first time [PARENTAL LOCK]	53
To change the settings [PARENTAL LOCK]	54
To temporarily release the Parental Lock [PARENTAL LOCK]	55

<b>Additional information</b>	Page 56
<b>AV COMPU LINK remote control system</b>	56
Connection and setup	56
Operation	57
<b>Care and handling of discs</b>	58
<b>Troubleshooting</b>	59
<b>Specifications</b>	60
<b>Table of languages and their abbreviations</b>	Appendix A
<b>Country code list for Parental Lock</b>	Appendix B

## Features

This unit is a compatible player for DVD VIDEO, Audio CD and Video CD discs.

### Picture functions

#### ■ Progressive Scan system

Supports the Progressive scan system, as well as the conventional (current) Interlace scan system.

\* To enjoy the progressive video picture, you must connect the unit to a television or monitor that supports the progressive video input.

#### ■ Strobe function

The unit can display nine continuous still pictures on the TV screen.

#### ■ Digest function

You can select the desired selection to be played from the opening scenes displayed on the TV screen.

#### ■ Angle function\*

You can select a desired angle from multiple camera angles recorded on the DVD VIDEO disc.

#### ■ Zoom function

You can view scenes close-up.

#### ■ VFP (Video Fine Processor) function

You can adjust the picture character according to the type of programming, picture tone or personal preferences.

#### ■ Parental Lock\*

You can restrict the playback of DVD VIDEO discs with scenes which you do not want children to see, such as adult or violent films.

### Audio functions

#### ■ High quality digital sound

You can enjoy high quality sound with Linear-PCM.

#### ■ Surround function\*

The unit accommodates the Dolby Digital and DTS surround systems.

(These surround signals are output only from the DIGITAL OUT jacks.)

#### ■ 3D PHONIC function

You can enjoy Virtual surround sound with your 2-channel (stereo) system.

### Other functions

#### ■ Multi-disc tray and continuous playback

You can set up to 7 discs on the disc tray carousel and playback them continuously.

#### ■ MP3 disc playback

This unit can playback CD discs recorded by the MP3 format (we refer to those discs as "MP3 discs" in this manual).

#### ■ CD-R/CD-RW playback

You can playback a CD-RW disc recorded with the Audio CD format, and a CD-R disc recorded with the Audio CD, Video CD or MP3 format.

#### ■ Multi-language subtitles and sound\*

You can select a subtitle or sound language from those recorded on the DVD VIDEO disc.

#### ■ Operation from the on-screen display

User-friendly on-screen displays allow you to operate the unit easily.

Functions with (\*) mark only work on a DVD VIDEO disc that is compatible with each function.

## Supplied accessories

- Audio/video cable (x 1)

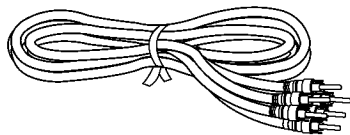

- Component video cable (x 1)

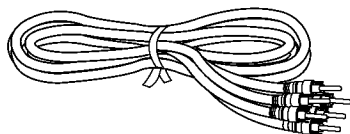

- AV compulink cable (x 1)

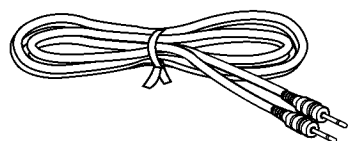

- Remote Control Unit (x 1)

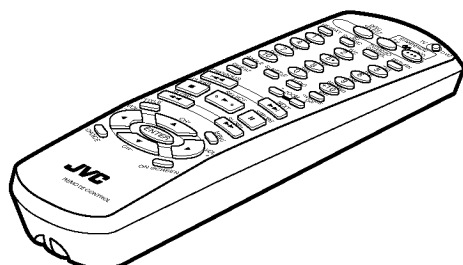

- R6P(SUM-3)/AA(15F) batteries (x 2)

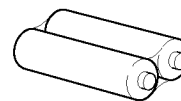

- Instruction manual (x 1)

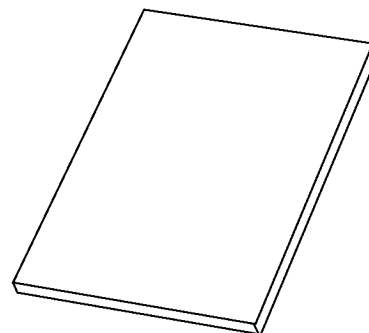

- AC power cord (x 1)

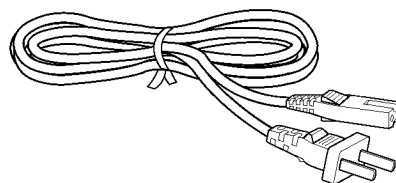

# About this instruction manual

- This instruction manual is written in the following manner.
- This unit can playback CD-R discs recorded by the MP3 format (we refer to those discs as MP3 discs in this manual).
- Regarding operations for MP3 discs, see "MP3 disc playback" on and after page 46. The other sections of this manual basically do not refer to MP3 disc playback.

## To playback in random order [RANDOM]



You can play tracks on an Audio CD or Video CD discs in random order by using the Random function.

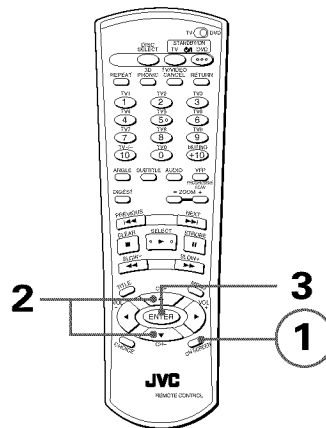

These symbols indicate the types of discs which the operation can be used for.

The number indicates the following procedural step(s) in which the button(s) is(are) used.

You may also use the corresponding buttons on the front panel of the unit if available.

- While stopped

### 1 Press ON SCREEN.

The on-screen display appears on the TV screen.

The number indicates the procedural step.

### 2 Use CURSOR ▲/▼ to move to [RANDOM].

(for Audio CD)

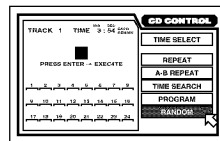

(for Video CD)

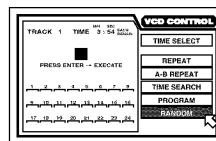

### 3 Press ENTER.

The color of [RANDOM] changes.  
The unit starts random playback.  
The "RANDOM" indicator appears in the display window on the front panel. After playing all tracks of the disc loaded, random playback ends.

The names of buttons on the remote control unit (or on the front panel of the unit) are all given in uppercase letters.

Other convenient procedures, etc.



- The same track will not be played back more than once during random play.
- During Audio CD playback, pressing ENTER when  points [RANDOM] quits random mode and continues playback in the normal order.
- **To quit random playback in the middle**  
Press ■. The unit stops playback and quits the random playback mode.

#### NOTE

- Random playback is carried out only within the disc currently loaded.

# Notes on handling

## Important cautions

### Installation of the unit

- Select a place which is level, dry and neither too hot nor too cold (between 5°C and 35°C, 41°F and 95°F).
- Leave sufficient distance between the unit and the TV.
- Do not use the player in a place subject to vibrations.

### Power cord

- Do not handle the power cord with wet hands!
- A small amount of power (2.7 W) is always consumed while the power cord is connected to the wall outlet.
- When unplugging the player from the wall outlet, always pull the plug, not the power cord.

### To prevent malfunction of the unit

- There are no user-serviceable parts inside. If anything goes wrong, unplug the power cord and consult your dealer.
- Do not insert any metallic object into the unit.
- Do not use any non-standard shape disc available on the market, because it may damage the unit.
- Do not use a disc with tape, seals, or paste on it, because damage to the unit may result.

### Note about copyright laws

- Please check the copyright laws in your country before recording from DVD VIDEO, Audio CD, Video CD and MP3 discs. Recording of copyrighted material may infringe copyright laws.

### Note about the copyguard system

- The DVD VIDEO disc is protected by the copyguard system. When you connect the unit to your VCR directly, the copyguard system activates and the picture may not be played back correctly.

## Safety precautions

### Avoid moisture, water and dust

Do not place the unit in moist or dusty places.

### Avoid high temperatures

Do not expose the unit to direct sunlight or place it near a heating device.

### When you are away

When away on travel or otherwise for an extended period of time, remove the plug from the wall outlet.

### Do not insert foreign objects into the unit

Do not insert wires, hairpins, coins, etc. into the unit.

### Do not block the vents

Blocking the vents may damage the unit.

### Care of the cabinet

When cleaning the unit, use a soft cloth and follow the relevant instructions on the use of chemically-coated cloths. Do not use benzene, thinner or other organic solvents and disinfectants. These may cause deformation or discoloring.

### If water gets inside the unit

Turn off the power switch and remove the plug from the wall outlet, then call the store where you made your purchase. Using the unit in this state may cause a fire or electrical shock.

This product incorporates copyright protection technology that is protected by method claims of certain U.S. patents and other intellectual property rights owned by Macrovision Corporation and other rights owners. Use of this copyright protection technology must be authorized by Macrovision Corporation, and is intended for home and other limited viewing uses only unless otherwise authorized by Macrovision Corporation. Reverse engineering or disassembly is prohibited.

Manufactured under license from Dolby Laboratories. "Dolby" and the double-D symbol are trademarks of Dolby Laboratories.

Confidential unpublished works.

© 1992-1998 Dolby Laboratories. All rights reserved.

Manufactured under license from Digital Theater Systems, Inc. US Pat. No. 5,451,942 and other world-wide patents issued and pending. "DTS", "DTS Digital Surround", are trademarks of Digital Theater Systems, Inc.

© 1996 Digital Theater Systems, Inc. All Rights Reserved.

## Names of parts and controls

Refer to the corresponding pages indicated in () for details.

### Front panel

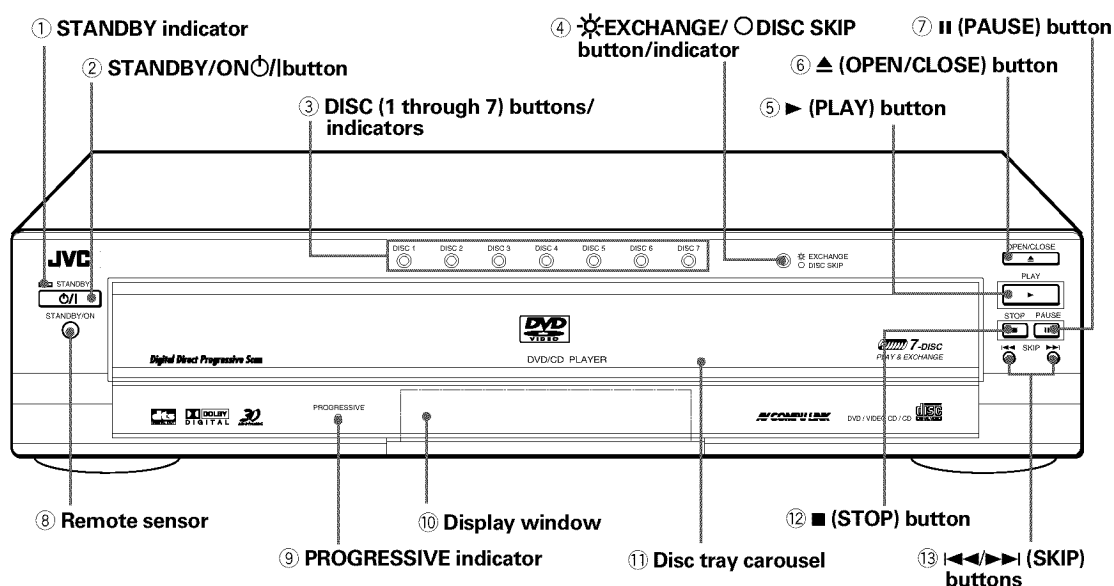

#### ① STANDBY indicator (24)

Lights in red when the power cord is connected and the unit is on standby. When the unit is turned on, the STANDBY indicator goes off.

#### ② STANDBY/ON button (24)

Turns the unit on or off (standby).

#### ③ DISC (1 through 7) buttons/indicators (26)

Select a disc set on the carousel to be played back by pressing the appropriate button. The indicator on each button shows the current status of the corresponding disc/disc tray.

See "About DISC indicators (1 through 7)" on page 26 for details.

#### ④ EXCHANGE/DISC SKIP button/indicator (25, 28)

This button has two functions. When the indicator is illuminated, pressing the button activates the play exchange function. When the indicator is unlit, pressing the button rotates the carousel.

- When the tray carousel is closed during playback, pressing the button activates the play exchange function and opens the carousel.
- When the tray carousel is open during playback, each press of this button rotates the carousel to access other trays except the one for the disc being played.
- When the tray carousel is open while stopped, each press of this button rotates the carousel clockwise by an amount of accessing the next two trays.

#### ⑤ (PLAY) button (26)

Starts playback. Also, used as a SELECT button for PBC of Video CDs.



- ⑥ ▲ (OPEN/CLOSE) button (24, 28)  
Used to open and close the carousel. You can also use this button in the play exchange mode.
- ⑦ ■ (PAUSE) button (27, 34, 46)  
Pauses playback. Also, used to display nine continuous still pictures (STROBE function).
- ⑧ Remote sensor (21)  
Receives signals from the remote control unit.
- ⑨ PROGRESSIVE indicator (17)  
Lights up when the Progressive scan mode is active. It lights in green during playback of a film-source DVD VIDEO disc when "PROGRESSIVE MODE" in "PREFERENCE 1" is set to "SMART", "FILM" or "AUTO." In other conditions when the Progressive scan mode is active, it lights in red.
- ⑩ Display window (7)  
Indicates the current status of the unit.
- ⑪ Disc tray carousel  
Used to set up to 7 discs.
- ⑫ ■ (STOP) button (27, 46)  
Stops playback.
- ⑬ ◀◀/▶▶ (SKIP) buttons (27, 46)  
Used to skip a chapter, title or track. Also, used for the page selection of a menu screen (for Video CD). Holding down ◀◀ or ▶▶ during playback reverses or advances playback rapidly (except MP3 disc).

## Display window

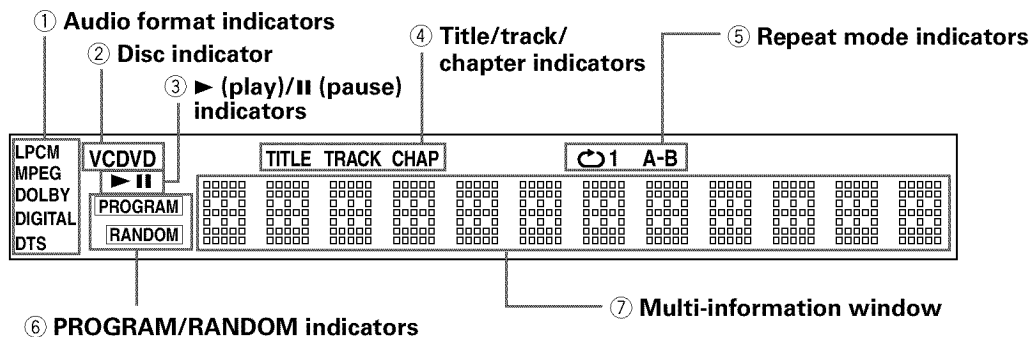

- ① **Audio format indicators**  
Indicates the format of audio currently being played back.
- ② **Disc indicator**  
Indicates the type of the disc set in the current tray. When DVD VIDEO disc is set, "DVD" lights up. When a Video CD disc is set, "VCD" lights up. When an Audio CD is set, "CD" lights up.
- ③ **► (play)/|| (pause) indicators**  
► or || illuminates during playback or while paused, respectively.  
Neither of them illuminates while stopped.
- ④ **Title/track/chapter indicators**  
One or more appropriate indicators illuminate according to the disc inserted.
- ⑤ **Repeat mode indicators**  
The appropriate indicator illuminates according to the current repeat mode.
- ⑥ **PROGRAM/RANDOM indicators**  
The appropriate indicator illuminates while the unit is in the Program or Random playback mode.
- ⑦ **Multi-information window**  
Displays the current title/track/chapter number(s), time and status information.

## Remote control unit

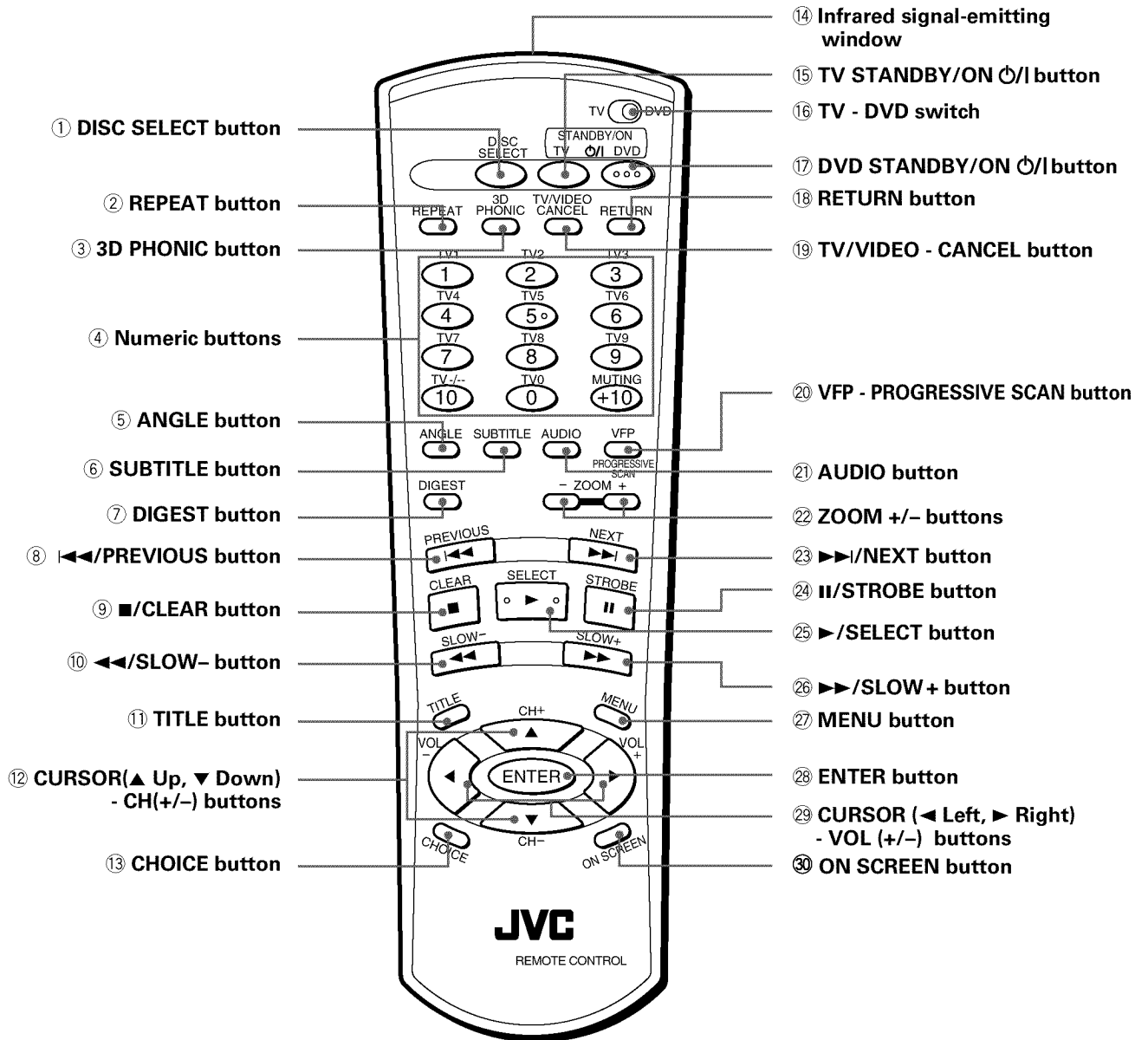

**① DISC SELECT button (14, 26)**

Pressing this button followed by the appropriate numeric button (1 through 7) within 5 seconds selects a disc to be played back.

**② REPEAT button (37, 48)**

Selects the repeat mode.

**③ 3D PHONIC button (44)**

Produces a simulated surround effect.

**④ Numeric buttons (14, 22)**

When the TV - DVD switch is set to DVD, these buttons are used to select a disc and specify a title, chapter, track number, as well as used to select a disc and enter a time for the Time search function.

They are also used to select a disc number to be played back in conjunction with the DISC SELECT button. When the TV - DVD switch is set to TV, these buttons are used to select a TV channel as well as mute the TV audio.

- ⑤ **ANGLE button (40, 41, 45)**  
Changes camera angles during playback of a DVD VIDEO disc containing multiple camera angles. Also used to change the brightness of the display window.
- ⑥ **SUBTITLE button (41)**  
Used to display the subtitle selection display on the TV screen, as well as used to turn the subtitle on or off (for DVD VIDEO).
- ⑦ **DIGEST button (33)**  
Displays beginning scenes of each title, chapter or track on the TV screen (for DVD VIDEO/Video CD).
- ⑧ **◀◀/PREVIOUS button (27, 28, 31, 46)**  
Skips back a chapter, title or track. Also used for the page selection of a menu screen (for DVD VIDEO/Video CD).  
Holding down this button during playback reverses playback rapidly (except MP3 disc).
- ⑨ **■/CLEAR button (27, 36, 46)**  
Stops playback. Also used to clear all the programmed selections for the program play.
- ⑩ **◀◀/SLOW- button (27, 35)**  
Pressing this button during playback reverses playback rapidly (except MP3 disc).  
Pressing this button while a DVD VIDEO disc is paused reverses playback slowly.
- ⑪ **TITLE button (30)**  
Displays the title menu of a DVD VIDEO disc on the TV screen.
- ⑫ **CURSOR (▲ Up, ▼ Down) - CH (+/-) buttons**  
When the TV - DVD switch is set to DVD, these buttons are used to select an item from a menu or on-screen display, or to change the setting of an on-screen display item.  
In this case, we call them "CURSOR ▲/▼" buttons in this manual.  
When the TV - DVD switch is set to TV, they are used to select a TV channel.
- ⑬ **CHOICE button (49)**  
Brings up the preference on-screen display on the TV screen.
- ⑭ **Infrared signal-emitting window (21)**  
Point this window toward the remote sensor on the front panel when pressing buttons.
- ⑮ **TV STANDBY/ON ⏻/⏻ button (22)**  
Turns the TV on or off (standby).
- ⑯ **TV - DVD switch (14, 23, 30)**  
When setting this switch to "TV", the numeric, cursor and TV/VIDEO - CANCEL buttons are used to control your TV.  
When setting it to "DVD", these buttons are used to control the unit.
- ⑰ **DVD STANDBY/ON ⏻/⏻ button (24)**  
Turns the unit on or off (standby).
- ⑱ **RETURN button (31)**  
Returns to the previous menu (for Video CD).
- ⑲ **TV/VIDEO - CANCEL button (22, 36)**  
Switches the TV input mode when the TV - DVD switch is set to TV.  
Cancels the last selection of the program when the TV - DVD switch is set to DVD.
- ⑳ **VFP - PROGRESSIVE SCAN button (17, 43)**  
Pressing this button brings up the VFP (Video Fine Processor) window in which you can select or adjust the picture character.  
Holding down this button for a few seconds switches the scan mode between the progressive scan and interlace scan modes. See "How to make the Progressive scan mode active" on page 17 for details.
- ㉑ **AUDIO button (42)**  
Selects the audio (for DVD VIDEO/Video CD).
- ㉒ **ZOOM +/- buttons (35)**  
Zooms in or out the picture (for DVD VIDEO/Video CD).
- ㉓ **▶▶/NEXT button (27, 28, 31, 46)**  
Skips forward a chapter, title or track. Also used for the page selection of a menu screen (for DVD VIDEO/Video CD).  
Holding down this button during playback advances playback rapidly (except MP3 disc).
- ㉔ **⏸/STROBE button (27, 34, 46)**  
Pauses playback. Also, used to display nine continuous still pictures (STROBE function).  
Pressing this button while paused advances the still picture frame-by-frame.
- ㉕ **▶/SELECT button (26, 30)**  
Starts playback. Also used as a SELECT button for PBC of Video CDs.
- ㉖ **▶▶/SLOW+ button (27, 35)**  
Pressing this button during playback advances playback rapidly (except MP3 disc).  
Pressing this button while a DVD VIDEO or Video CD disc is paused advances playback slowly.
- ㉗ **MENU button (30)**  
Displays a DVD menu on the TV screen.
- ㉘ **ENTER button**  
Executes the selected item in a menu or on-screen display.
- ㉙ **CURSOR (◀ Left, ▶ Right) - VOL (+/-) buttons**  
When the TV - DVD switch is set to DVD, these buttons are used to select an item from a menu or on-screen display, or to change the setting of an on-screen display item.  
In this case, we call them "CURSOR ◀▶" buttons in this manual.  
When the TV - DVD switch is set to TV, they are used to change the TV audio volume.
- ㉚ **ON SCREEN button**  
Brings up an appropriate on-screen display for controlling advanced functions for the current disc on the TV screen.

## Rear panel

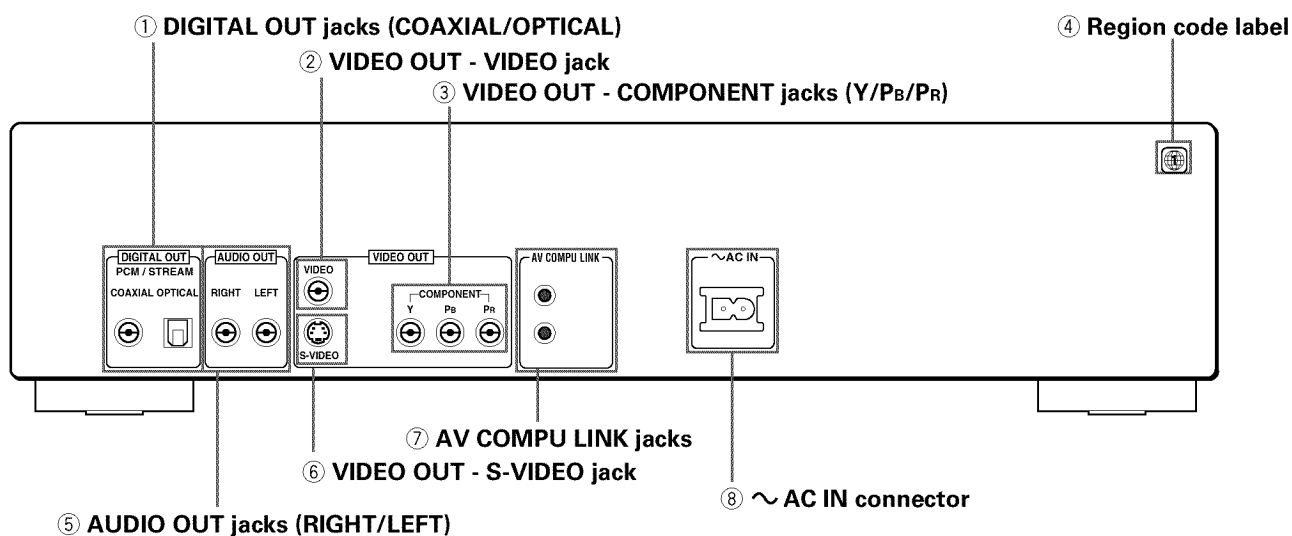

- ① **DIGITAL OUT jacks (COAXIAL/OPTICAL) (19)**  
Outputs digital audio signals. You must select the signal type correctly according to the external device connected to via the Preference display. Both the COAXIAL and OPTICAL connectors are provided.

- ② **VIDEO OUT - VIDEO jack (16)**  
Outputs a composite video signal.

- ③ **VIDEO OUT - COMPONENT jacks (Y/P<sub>B</sub>/P<sub>R</sub>) (17)**  
Output component video signals. These jacks can output the Progressive scan signals as well as the conventional Interlace scan signals. See "How to make the Progressive scan mode active" on page 17 for details.

- ④ **Region code label (15)**  
Indicates the region code of the unit.

- ⑤ **AUDIO OUT jacks (RIGHT/LEFT) (16, 17)**  
Outputs stereo analog audio signals.

- ⑥ **VIDEO OUT - S-VIDEO jack (16)**  
Outputs an S-video signal.

- ⑦ **AV COMPU LINK jacks (56)**  
Connects with other JVC equipment supporting the AV Compulink function to facilitate integrated operations.













- ⑧ **~ AC IN connector (20)**  
Connects to the wall outlet using the supplied AC power cord.

# Operational Principles

## On-screen displays

You can set preferences and perform advanced playback functions via various on-screen displays, including the Opening, Preference, Parental Lock and Control displays.

### Basic operations of on-screen displays

- You can move  using the CURSOR / / /  buttons to select items you want to work with.
- With an item like  you can change the setting by using the CURSOR /  buttons when  is on the item.
-  - type item works when you place  on the item and press ENTER.
- In the message box, the operation to be performed is displayed according to the item pointed by .
- Numbers are entered using the numeric buttons.
- Some functions become effective by pressing ENTER after specifying necessary entries.

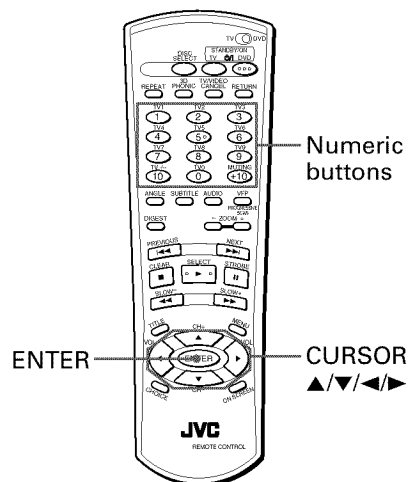

### Opening display

An opening display appears automatically (without pressing any button) in some conditions.

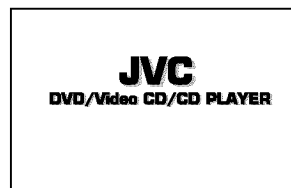

One of the displays shown on the right appears when a disc is set and stopped. For a disc that does not contain any picture (such as an Audio CD), the opening display does not disappear after starting playback.

(for DVD VIDEO)

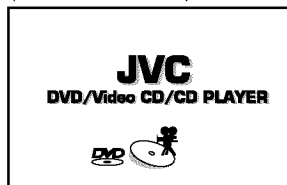

(for Audio CD)



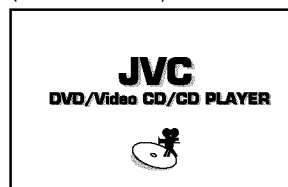

(for Video CD)



## PREFERENCE (1, 2) displays (see page 49)

You can set preferences via these displays.

- **To bring up the PREFERENCE 1/PREFERENCE 2 display**
  - 1 When a DVD VIDEO disc is set and stopped or no disc is inserted, press CHOICE.
  - 2 To select the display, move  to the desired tab using the CURSOR /  buttons.

(PREFERENCE 1)

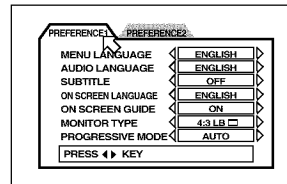

(PREFERENCE 2)

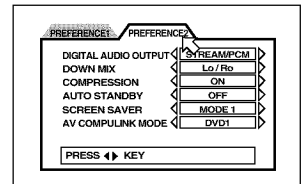

## PARENTAL LOCK display (see page 53)

You can set the Parental Lock from this display.

- **To bring up the PARENTAL LOCK display**  
When no disc is inserted or a DVD VIDEO disc is stopped, press ENTER while holding down .

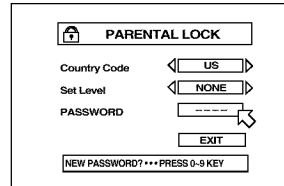

## DVD VIDEO CONTROL display

You can select and set various functions for DVD VIDEO playback from this display.

This display is available only during DVD VIDEO playback.

- **To bring up the DVD VIDEO CONTROL display**  
During DVD VIDEO playback, press ON SCREEN.

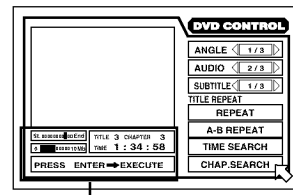

Current relative position of the title (St: start,End: end)

Current title number

Current chapter number

Transmission rate

Elapsed time from the beginning of the current title

## CD CONTROL display

You can select and set various functions for Audio CD playback from this display.

- **To bring up the CD CONTROL display**  
Whenever an Audio CD is inserted, press ON SCREEN.

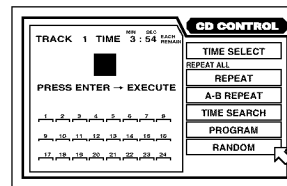

## VCD CONTROL display

There are two types of VCD CONTROL display. The display shown on the right is available only during Video CD playback.

When a Video CD disc is stopped, a display similar to the CD CONTROL display appears.

- **To bring up the VCD CONTROL display**

Press ON SCREEN when a Video CD is inserted. The appropriate display appears according to the unit's status.

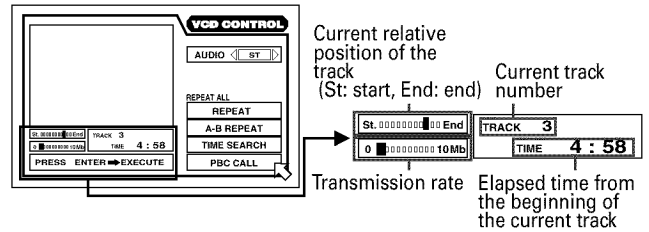

## MP3 CONTROL display (See page 46)

The display shown on the right appears when an MP3 disc is set. You can select the desired Group or track to be played back.

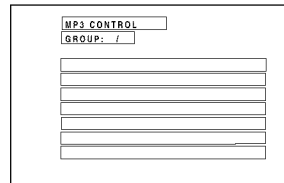

## To prevent the monitor from burning out [SCREEN SAVER]

A television monitor screen may be burned out if a static picture is displayed for a long time. To prevent this, the unit automatically activates the screen saver function if a static picture, such as an on-screen display or menu, is displayed for over 5 minutes.

- Pressing any button on the unit or the remote control unit will release the screen saver function and return to the previous display.
- You can select one of several screen saver modes available (see page 52).
- The screen saver function is not activated during Audio CD/MP3 disc playback or after stopping Audio CD/MP3 disc playback.

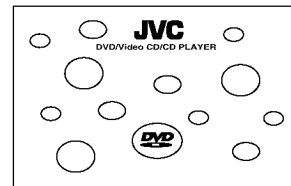

## On-screen guide icons

During DVD VIDEO playback, you may see icons displayed over the picture. These have the following meanings.



: Displayed at the beginning of a scene recorded from multiple angles. (See page 40.)



: Displayed at the beginning of a scene recorded with multiple audio languages. (See page 42.)



: Displayed at the beginning of a scene recorded with multiple subtitle languages. (See page 41.)

You can set the unit not to display on-screen icons above via the preference settings described on page 50.

### About invalid operation icon

When you press a button, if the unit does not accept its operation, appears on your television screen. Operations are occasionally unacceptable even if is not displayed.

Note that some operations may not be accepted. For example, some discs may not allow rapid advance/reverse or slow-motion playback.

## How to use numeric buttons

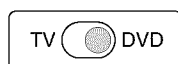

The function of the numeric buttons differs depending on the setting of the TV - DVD switch. When setting it to TV, the buttons are used to select a TV channel (see page 22). When setting it to DVD, the buttons are used to select a disc, select a track/title/chapter or enter a disc time or chapter number.

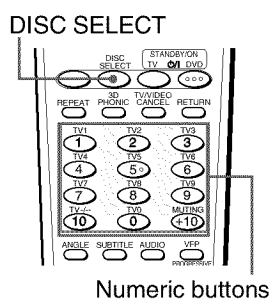

Numeric buttons

### To select a disc

Press the DISC SELECT button, followed by the appropriate numeric button (1 through 7) within 5 seconds.

### To select a track/title number

- **To select a number between 1 and 10**  
Press the corresponding button for the number.
- **To select a number higher than 10**  
Use the +10 button.

Examples:

- To select 13            +10 → 3
- To select 34            +10 → +10 → +10 → 4
- To select 40            +10 → +10 → +10 → 10

### To enter a time or chapter number

The method for entering a time for Time search or chapter number for Chapter search is different from above. See the corresponding sections in this manual for the details.

\* There is another method for selecting a Track or Group of an MP3 disc. See the appropriate section.

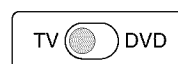

### To select a TV channel

Press the corresponding numeric buttons. See page 22 and 23 for details.



# About discs

## Playable disc types

Playable and non-playable disc types are as follows:

### Playable discs

DVD VIDEO 	Video CD 	Audio CD 
--	---	---

The DVD VIDEO Logo is a trademark.

- CD-R and CD-RW discs recorded with the Audio CD format and CD-R discs recorded with the Audio CD, Video CD and MP3 format can be played back, though some discs may not be played back because of the disc characteristics or recording condition.
- DVD VIDEO players and DVD VIDEO discs have their own Region Code numbers. This unit only can play back DVD VIDEO discs whose Region Code numbers include "1".

Examples of playable DVD VIDEO discs:



This unit accommodates both the NTSC and PAL system and can playback discs recorded with either system. Note that a PAL video signal on a disc is converted to an NTSC signal and output.

- When playing back a "PAL" disc, the Progressive scan mode is never active even if you set the Progressive scan mode to active.

### Non-playable discs

DVD-ROM, DVD-RAM, DVD AUDIO, DVD-R, DVD-RW, CD-ROM, PHOTO CD, CD-EXTRA, CD-G, CD-TEXT

- Playing back discs listed as "Non-playable discs" above may generate noise and damage speakers.
- This unit can play back audio recorded in CD-G, CD-EXTRA and CD-TEXT discs.

## Disc structure

A DVD VIDEO disc is comprised of "titles," while an Audio CD or Video CD is comprised of "tracks." Each title may be divided into some "chapters." For example, if a DVD VIDEO disc contains some movies, each movie may have its own title number, and each movie may be divided into some chapters. In a DVD VIDEO KARAOKE disc, each song usually has its own title number and does not have chapters. In general, each title has independent content, while each chapter in the same title has continuity.

(Example: DVD VIDEO disc)

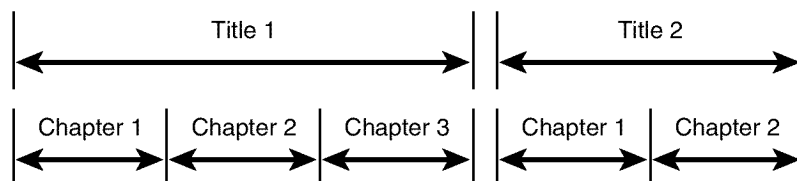

(Example: Audio CD/Video CD)

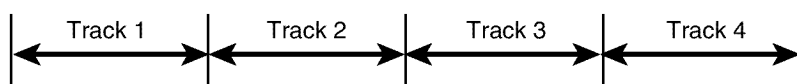

## Connections

\*In the following description, "TV" may be substituted with "monitor" or "projector."

\*Before using the unit, you have to connect the unit to a TV and/or amplifier.

### Before making any connections

- **Do not connect the AC power cord until all other connections have been made.**
- Since different components often have different terminal names, carefully read the instructions supplied with the component you are going to connect.

### To connect to a conventional TV

You can enjoy playback by simply connecting the unit to a TV. To improve audio sound quality, connect the AUDIO OUT jacks to your separate audio equipment. (See the following pages.)

The unit

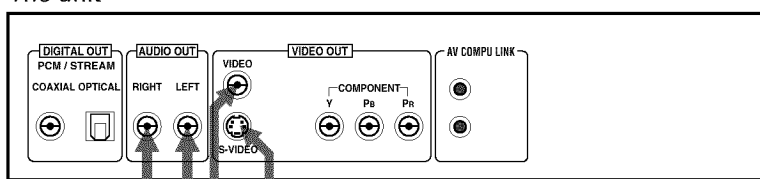

If the TV has an AV COMPU LINK terminal, you can use the AV COMPU LINK function. See "AV COMPU LINK remote control system" on page 56 for details.



Connect the unit to a TV equipped with stereo audio input and video input jacks using the supplied audio/video cables.

- If your TV has a monaural audio input instead of stereo, you need to use an optional audio cable which converts stereo audio output to monaural.
- If your TV has an S-video input, you can get better picture quality by connecting it with the S-VIDEO output of the unit using the S-video cable (optional) in addition to the (standard) video connection.

#### NOTES

- When connecting to a TV using the VIDEO OUT jack, make sure that the PROGRESSIVE indicator on the front panel is not lit. If it is lit, the VIDEO and S-VIDEO outputs do not feed the correct signals. To turn off the PROGRESSIVE indicator, see "How to make the Progressive scan mode active" on page 17.
- Connect VIDEO OUT of the unit directly to the video input of your TV. Connecting VIDEO OUT of the unit to a TV via a VCR may cause a monitor problem when playing back a copy-protected disc.

## To connect to a TV with the component video input jacks

You can enjoy high picture quality by connecting the unit's COMPONENT VIDEO OUT jacks (Y, P<sub>B</sub>, P<sub>R</sub>) to the COMPONENT VIDEO IN jacks (Y, P<sub>B</sub>, P<sub>R</sub>) of your TV with the video cables.

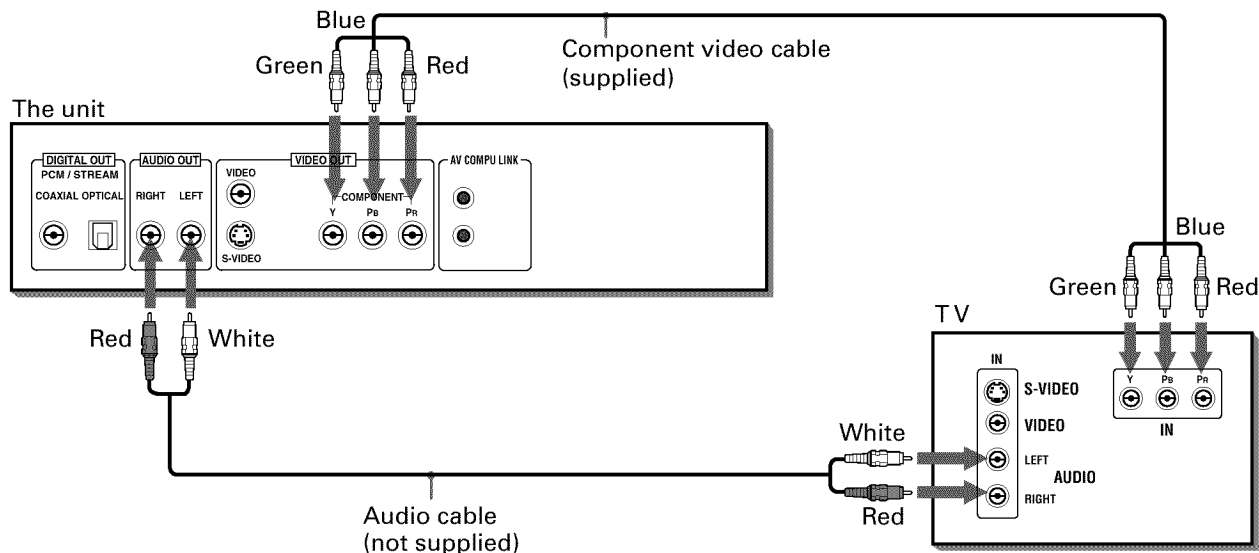

The unit supports the Progressive scan system as well as the conventional Interlace scan system. If your television or monitor supports the progressive video input, you can enjoy a high quality picture by making the Progressive scan mode active.

### How to make the Progressive scan mode active

Press and hold down the VFP - PROGRESSIVE SCAN button for a few seconds.

The scan mode switches between the Progressive scan and Interlace scan modes. When the Progressive scan mode is selected, the PROGRESSIVE indicator on the front panel is lit in red. This indicator turns green during playback of a film-source DVD VIDEO disc while the "PROGRESSIVE MODE" on the "PREFERENCE1" display is set to AUTO, FILM or SMART (see page 51).

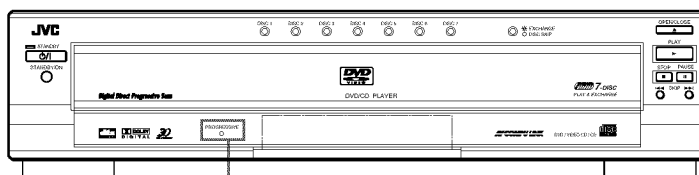
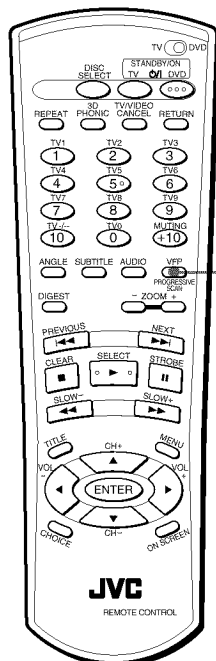

- You should note that not all Progressive TV and High-Definition TV sets are fully compatible with the unit and may cause artifacts to be displayed in the picture. In case of progressive scan picture problems, it is recommended that you switch the setting to the "Interlace Scan" output. If there are questions regarding our TV set compatibility with the unit, please contact our customer service center.
- All JVC Progressive TV and High-Definition TV sets have no problem. (Example: AV-61S902)

**NOTES**

- Connect "Y" to "Y", "Pb" to "Pb", "Pr" to "Pr" correctly.
- When the component video input jacks of the TV is of the BNC type, use an adapter to convert a pin jack to a BNC jack (optional).
- When the Progressive scan mode is selected, the VIDEO and S-VIDEO outputs do not feed the correct signals.

**About SCAN MODE**

To display video on the monitor (television) screen, the conventional scanning method is called "Interlaced scan". With this method, only half of the horizontal lines are displayed at a time. So two fields complete a single picture (frame); i.e., the first field, containing all the odd-numbered lines, is displayed followed by the second field, containing all the even-numbered lines.

On the other hand, the Progressive scan system scans all horizontal lines at a time, so you can double the number of pictures compared with the interlaced scan, resulting flicker-free, high-density picture.

To enjoy the progressive scanned video, a monitor (or TV or projector) to be connected to the unit must have the Progressive inputs.

Depending on the material source format, DVD VIDEO discs can be classified into two types; film source and video source (Note that some DVD VIDEO discs contain both film source and video source). Film sources are recorded as 24-frame-per-second information, while (NTSC) video sources are recorded as 30-frame-per-second (60-field-per-second interlaced) information.

When the unit plays back a film source material, uninterlaced progressive output signals are created using the original information. When a video source material is played back, the unit interleaves lines between the interlaced lines on each to create the pseudo uninterlaced picture and outputs as the progressive signal.

**To connect to an audio amplifier or receiver**

You can enjoy high-quality audio by connecting the unit's audio output to your amplifier or receiver.

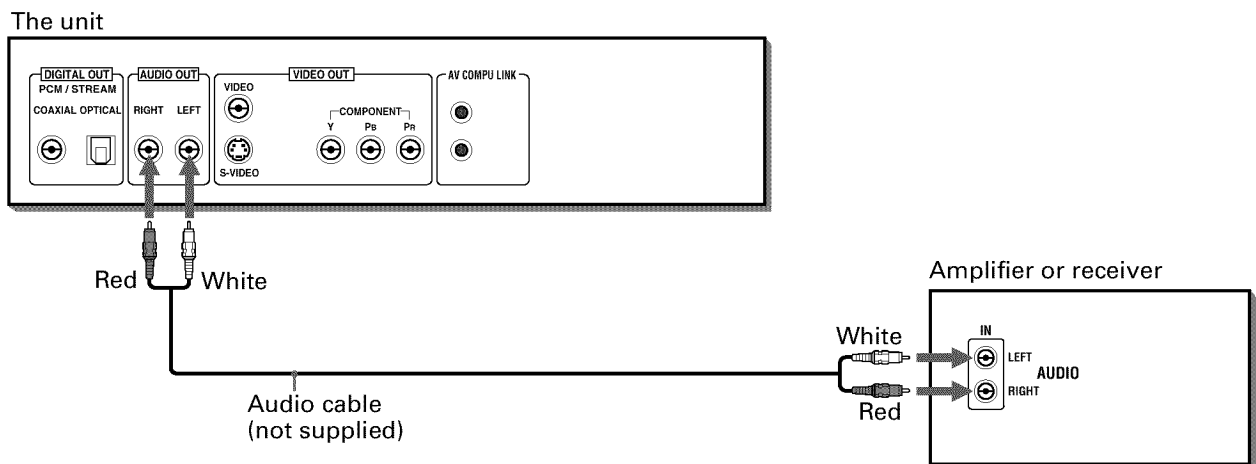

- Connect the unit's AUDIO OUT to any line-level inputs (such as AUX, DVD, CD, etc.) of an audio amplifier or receiver.

**NOTE**

- When using the unit with a stereo amplifier or receiver, make the "DOWN MIX" setting in "PREFERENCE 2" to "Lo/Ro". (See page 52.)

## To connect to audio equipment with a digital input

You can enhance the sound quality by connecting either of the unit's DIGITAL OUT jacks to the digital input of an amplifier, MD, etc. by using an optional digital cable (OPTICAL or COAXIAL). The digital audio signal from a disc is directly transferred. If you connect the unit to a Dolby Digital or DTS decoder or an amplifier with a built-in decoder by using an optional digital cable, you can enjoy high-quality surround sound.

When you make the digital connection, we recommend also to make the analog connection, because, depending on discs, no signal may be output from the DIGITAL OUT.

The unit

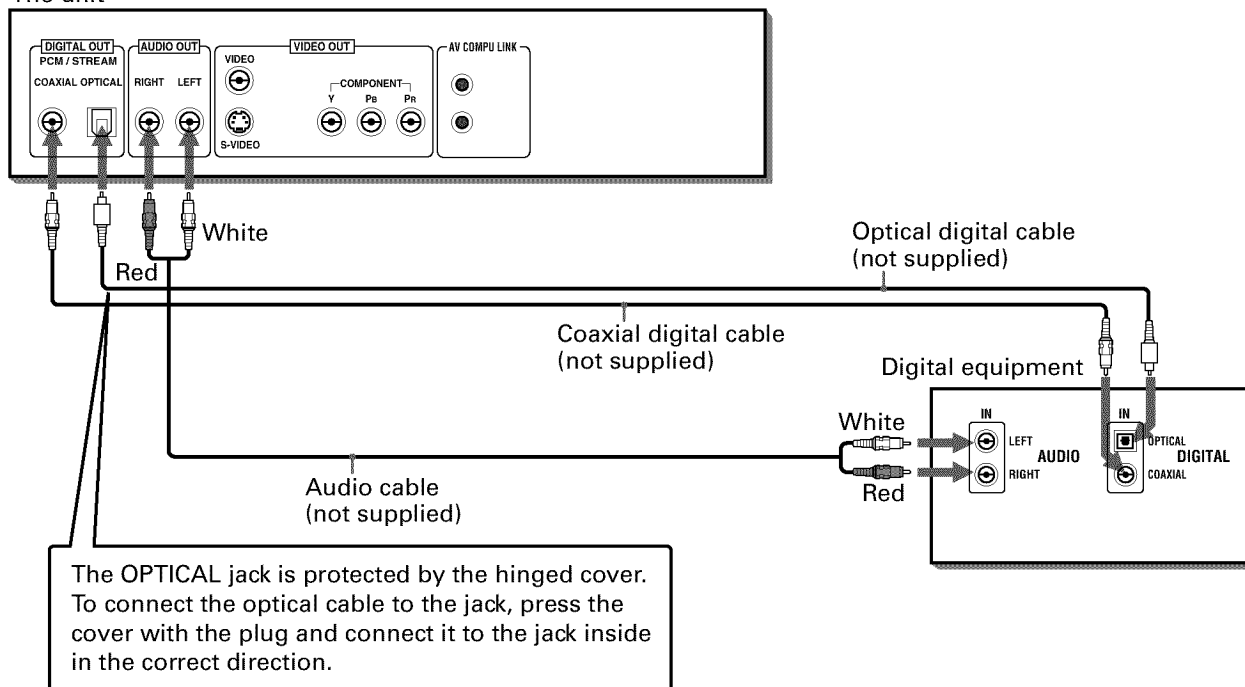

### NOTES

- When you connect the unit's DIGITAL OUT to digital audio equipment, before using, make the "DIGITAL AUDIO OUTPUT" setting in the "PREFERENCE 2" on-screen display correctly according to the connected audio equipment. If the "DIGITAL AUDIO OUTPUT" is not set correctly, loud noise may be generated from speakers, causing damage to them. See "DIGITAL AUDIO OUTPUT" on page 51.
- With the digital connection, the "COMPRESSION" settings in the "PREFERENCE 2" on-screen display are invalid. Settings for these items must be made from the decoder.

## To connect the power cord

When all the audio/video connections have been made, insert the smaller plug of the supplied AC power cord to the unit's  $\sim$  AC IN connector, then insert the other end to the wall outlet. Make sure that plugs are inserted firmly. The STANDBY indicator lights and setup is completed.

### Warning

- Disconnect the power cord if you are not going to use the unit for a long time.
- Disconnect the power cord before cleaning the unit.
- Disconnect the power cord before moving the unit.
- Do not connect or disconnect the power cord with wet hands.
- Do not pull the power cord when disconnecting it, as this may damage the cord and cause fire, electric shock, or other accidents.

### Caution

- Do not damage, alter, twist, or pull the power cord, as this may cause fire, electric shock, or other accidents.
- To prevent any accidents or damages caused by an unsuitable AC power cord, only use the supplied power cord. If the cord is damaged, contact a dealer and get the new power cord.
- Do not put anything heavy, or the unit, on the power cord, as this may cause fire, electric shock, or other accidents.

## Using the remote control unit

Using the remote control, you can operate not only all the functions of the unit but also basic functions of your TV.

## To install batteries in the remote control unit

The battery compartment is located on the back of the remote control unit.

- 1 Press down on the point shown by the arrow at the top of the compartment cover, and pull up the cover to open the compartment.

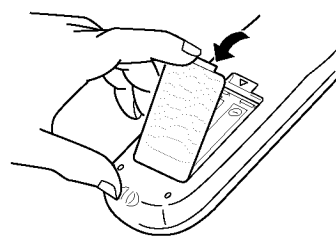

- 2 Place the two accessory R6P (SUM-3)/AA(15F) batteries in the remote control according to the polarity markings ("+" and "-") inside the compartment and on the batteries.

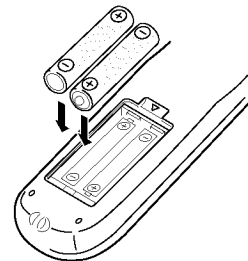

- 3 Place the cover over the compartment, and press down lightly.

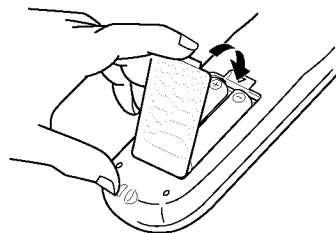

- The batteries will last about six months with normal use. If the functions of the remote control become erratic, replace the batteries. See next page for more information.

## Precautions for the safe use of batteries

Observe the following precautions for the safe use of batteries. If they are used improperly their life will be shortened, they may burst or their contents may leak.

### Precaution

- Remove the batteries from the remote control if it is not going to be used for a long period of time.
- Remove dead batteries and dispose of them properly.
- Never leave dead batteries lying around, take them apart, mix them with other refuse, or throw them into an incinerator.
- Never touch liquid that has leaked out of a battery.
- Do not mix new and old batteries, or batteries of different types, when replacing them.

## Remote sensor

- Operate the remote control unit while pointing it toward the remote sensor on the unit.
- The remote control unit can be used within a range of about 5 meters from the remote sensor. If you operate the remote control unit from a diagonal position, controllable distance may be shorter.

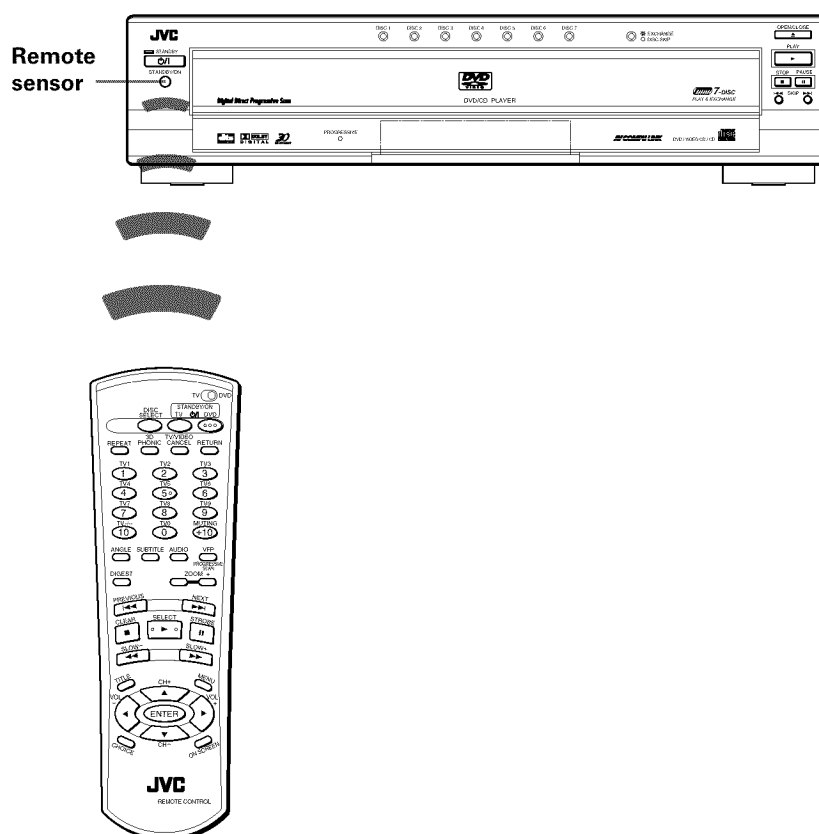

### NOTE

- If the remote sensor on the unit is exposed to the sunshine or strong light, you may not be able to control the unit from the remote control unit.

## To use the remote control unit for TV operation

You can operate your TV from the remote control unit.

### Setting the remote control signal for operating your TV.

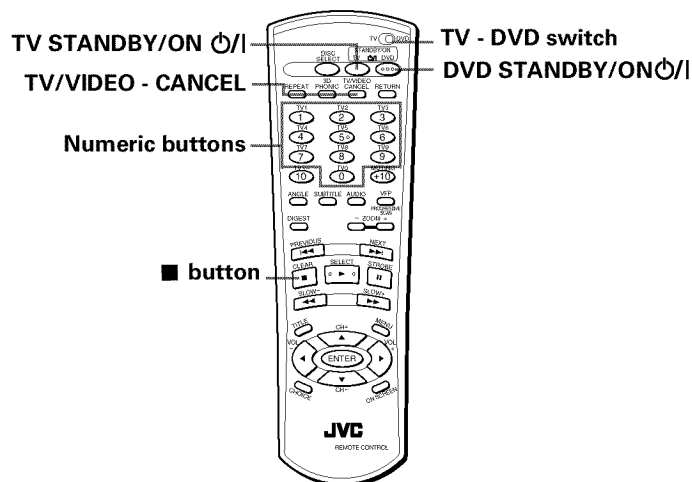

- 1 Holding down TV/VIDEO - CANCEL, enter the manufacturer code of your TV listed below by using the numeric buttons (0 to 9).  
Do not release TV/VIDEO - CANCEL. Keep holding it until the next step is completed.

#### Example:

To enter the manufacturer code "01": Press "0" then "1".

- 2 Press ■ while holding down TV/VIDEO - CANCEL.
- 3 Try to operate your TV by pressing TV STANDBY/ON  $\odot/\text{I}$ .  
If your TV turns on or off, you have successfully set the control signal.

#### Manufacturer code list

No.	Manufacturer
01	JVC
02	PHILIPS/CCE/MAGNAVOX
03	mitsubishi
04	PANASONIC
05	RCA
06	SHARP
07	SONY
08	TOSHIBA
09	ZENITH
10	PHILCO/HITACHI
11	PANASONIC
12	SAMSUNG
13	SANYO/SEARS
14	TOSHIBA

No.	Manufacturer
15	GRADIENTE
16	SANYO
17	PHILCO/DAEWOO
18	LG (GOLDSTAR)
19	GRUNDIG
20	NEC/GRADIENTE
21	PHILCO
22	BEIJING/NOBLEX
23	JVC (ONWA)
24	JVC (ONWA)
25	JVC (ONWA)
26	THOMSON
27	FERGUSON
28	ITT





No.	Manufacturer
29	MIVAR
30	FINLUX
31	NOKIA
32	FUNAI
33	SAMSUNG
34	SAMSUNG/PEONY/CHANGHONG
35	SAMSUNG
36	AIWA
37	DAEWOO
38	JINXING/PEONY
39	PEONY
40	KONKA
41	TCL

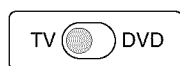

The following buttons can be used for operating the TV:

To use the CURSOR (CH-, CH+, VOL-, VOL+), TV/VIDEO - CANCEL and numeric buttons for TV control, set the TV - DVD switch to "TV":

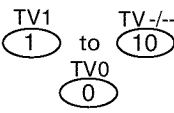

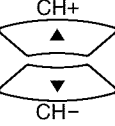
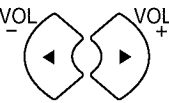
	<p><b>Turns the TV on or off.</b></p>
	<p><b>Switches the TV input mode between TV and VIDEO.</b></p>
	<p><b>Selects the TV channels directly.</b>  <b>* For some TVs, pressing "+10" functions as the "100+," while "10" functions as the ENTER button if your TV requires pressing the ENTER button after selecting a channel number.</b></p>
	<p><b>Mutes the TV sound.</b></p>
	<p><b>Changes the TV channels.</b></p>
	<p><b>Adjusts the TV volume.</b></p>



#### NOTES

- The remote control unit is initially set operating a JVC TV.
- If there is more than one code listed for the manufacturer of your TV, try them one by one until you succeed.

# Basic operations



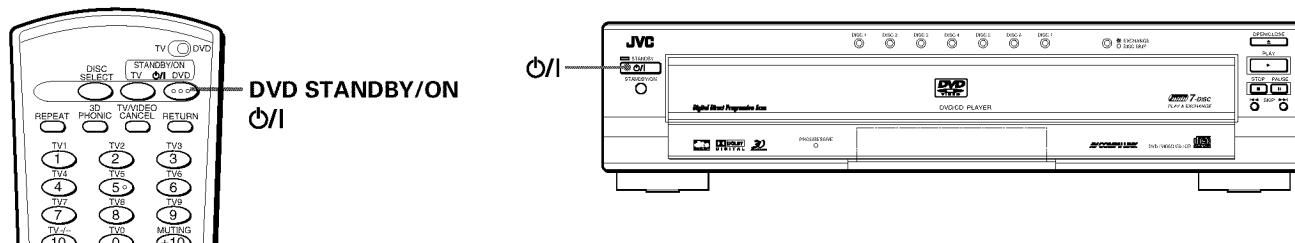

In the following description, the buttons on the remote control unit are mainly used, however, you may use the corresponding buttons on the front panel of the unit if available.

## Turning on/off the unit



Press DVD STANDBY/ON  on the remote control unit or press STANDBY/ON  on the front panel. The STANDBY/ON indicator, which illuminates in red during the standby mode, goes off, while each DISC indicator (1 through 7) shows the current status of whether a disc is set or not in the corresponding tray.



### Hints

- The first time you turn on the unit after connecting the power cord, the DISC indicators are illuminated until the unit detects that no disc is set in the corresponding tray. Once detecting the status, the unit memorizes it unless you unplug the power cord, so the DISC indicators show the status of corresponding trays correctly.
- You can directly turn on the unit by pressing the , DISC (1 through 7) or  (OPEN/CLOSE) button while the unit is on standby, without pressing the DVD STANDBY/ON  on the remote control unit or STANDBY/ON  on the front panel. The behavior of the unit after pressing these buttons while the unit is on standby is the same as pressing them while the power is on. See the following description in which the unit is assumed that the power is on when starting operations.

### NOTE

- Even if you press the DVD STANDBY/ON  or STANDBY/ON  button to turn off the unit, the unit is not disconnected from the AC power source as long as it is connected to the wall outlet. This state is called the standby mode. In this state, the unit consumes a very small amount of power.

## Inserting and removing discs

Up to 7 discs can be set on the disc tray carousel.

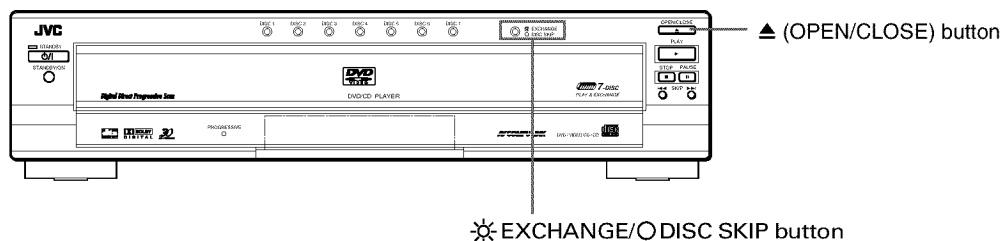

### 1 Press ▲ (OPEN/CLOSE) on the front panel.

The carousel opens and you can access to two of seven trays.

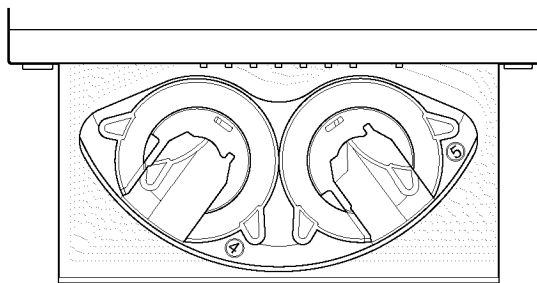

### Hints

- From the second time on, the carousel opens with the previously played disc on the left-front tray.

## 2 Press ☀ EXCHANGE/ ○ DISC SKIP to select accessible trays if required.

Each press of the button rotates the carousel clockwise by an amount for accessing the next two trays.

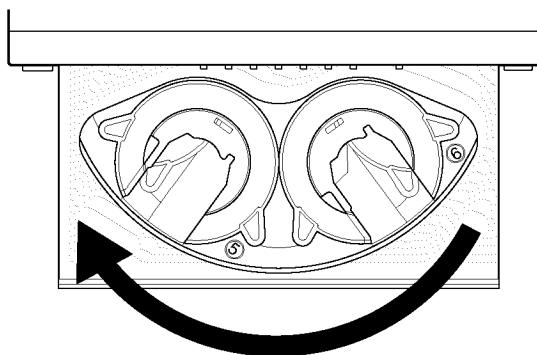

## 3 Place one or two discs in the tray(s).

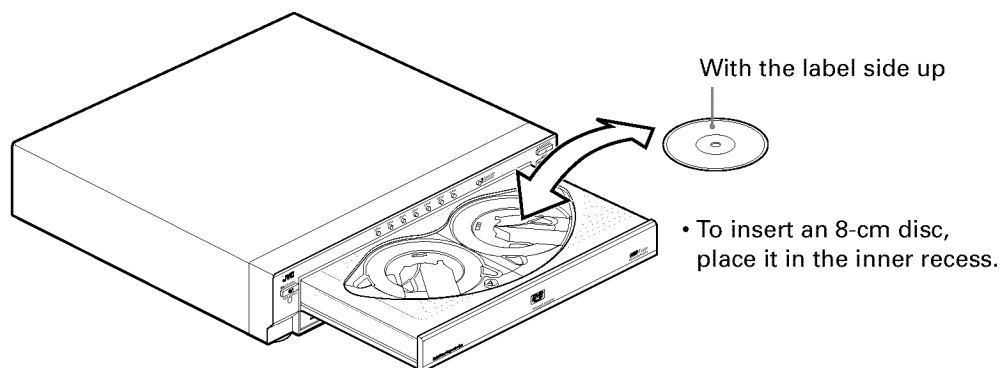

## 4 Repeat steps 2 and 3 if you wish to set one or more discs to other trays.

## 5 Press ▲ (OPEN/CLOSE).

The carousel closes.

The disc set in the front left tray when the carousel closes is loaded for playback. If no disc is set in the front left tray when the carousel closes, the unit rotates the carousel clockwise until it finds a disc for loading. If no disc is set at all in the carousel, "NO DISC" appears in the display window.

When a disc is loaded, the unit reads the information of the disc and the appropriate opening display according to the disc type appears on the TV screen (see page 11).

### NOTES

- Do not set a non-playable disc. For details about playable and non-playable disc types, see page 15.
- When placing a disc in the tray, be sure to position the disc inside the recess. Otherwise, the disc may be damaged when the tray is closed, or the disc may not be removed from the unit.
- Do not use any stabilizer when playing back a disc.
- With most DVD VIDEO discs, the unit starts playback automatically after inserting the disc and pauses at the menu screen.
- If you insert a DVD VIDEO disc whose region code does not match the unit, "REGION CODE ERROR!" is shown in the DVD opening display. For detail about the region code, see page 15.

## Basic playback

Note that this section describes basic operations for playback of DVD VIDEO, Audio CD and Video CD discs. For MP3 disc playback, see the independent chapter on and after page 46.

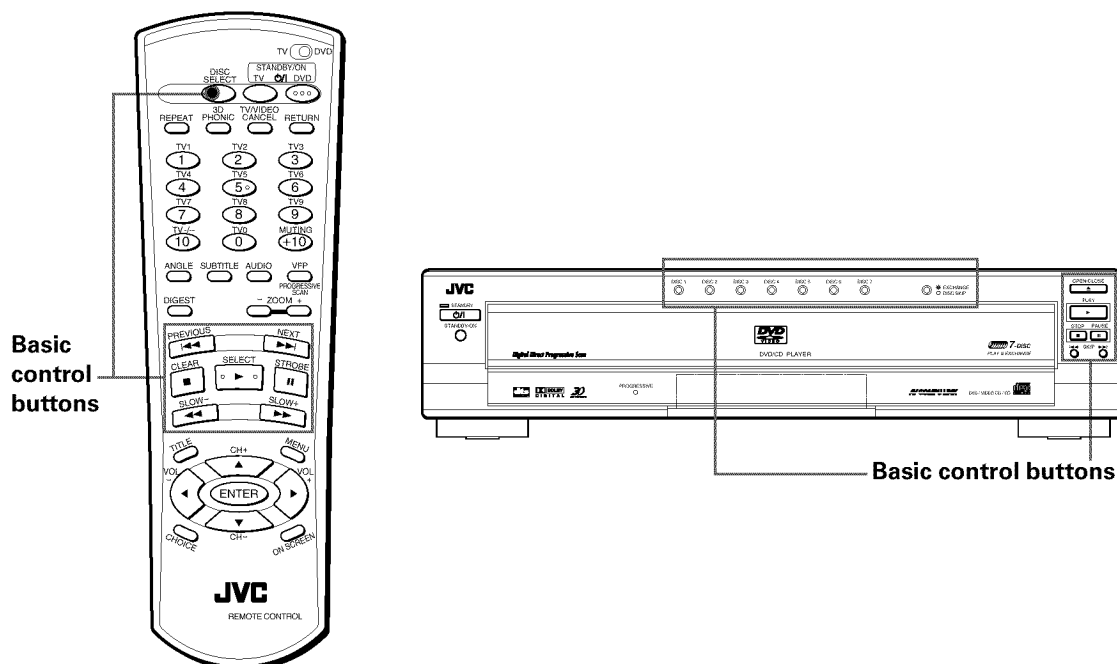

### To start playback



Press ►.

or

Press a desired DISC (1 through 7) button on the front panel, or press DISC SELECT followed by a desired numeric (1 through 7) button on the remote control unit.

By the former operation (pressing ►), the unit starts playback from the disc loaded for playback after closing the carousel (see the previous page for details about which disc is loaded for playback).

By the latter operation (using DISC, or DISC SELECT + numeric buttons), the unit starts playback from the disc set in the specified tray. If no disc is set in the specified tray, the unit rotates the carousel clockwise until it finds a disc for playback.

Regardless of operations for starting playback, the unit plays all available discs sequentially until you stop playback. With some discs, which automatically goes to the menu screen and waits for the next instruction, the unit does not move to the next disc.

### About DISC indicators (1 through 7)

Each DISC indicator shows the current status of the corresponding tray as follows.

- Illuminates if a disc is set in the corresponding tray.
- Flashes when the corresponding disc is being played back.
- Unlit if no disc is set in the corresponding tray.

#### NOTES

- Once a tray whose status is known by the unit becomes accessible when the carousel opens, the corresponding indicator lights regardless of whether or not a disc is set.
- When the resume point is memorized, pressing ► starts playback from that point instead of the beginning. See page 29.
- During playback, the display window shows the title/chapter or track number being played.
- With Video CD discs with PBC control or some DVD discs, the menu display may appear on the TV screen after starting playback. In such a case, select an item to be played back from the menu. Otherwise, the playback cannot go forward. For operation using a menu, see page 30.
- When a DVD disc is set in the front left tray, the unit usually starts playback automatically after closing the carousel and reading the disc contents.

## To stop playback completely



Press ■.

The unit stops playback.



- If you press ▲ (OPEN/CLOSE) during playback, the unit stops playback and opens the tray carousel.

## To stop playback temporarily



Press II.

The unit pauses playback. To resume playback, press ►.

## To advance or reverse playback rapidly while monitoring



- During playback

### Method 1 (from the remote control unit only)

Press ◀◀ or ▶▶.

Each press of ◀◀ or ▶▶ increases the playback speed. You can select the speed among 2x, 5x, 20x and 60x the normal speed.

Pressing ► returns the unit to normal playback.

### Method 2

Hold down I◀◀ or ▶▶I.

Holding down ▶▶I advances playback rapidly, while holding down I◀◀ reverses playback rapidly at 4 times the normal speed. Releasing the button returns the unit to normal playback.

## To locate the beginning of the scene or song



- During playback

Press **I◀◀** or **▶▶I**.

Press **I◀◀** to locate the beginning of the current chapter, title, or track, and press **▶▶I** to locate the beginning of the next chapter, title, or track.

### NOTE

- When you play a Video CD disc with the PBC function or a DVD VIDEO disc, the unit may locate a different place, but it will generally locate the beginning of the chapter, title or track.

## Changing discs during playback [PLAY EXCHANGE]



You can open the carousel during playback and change discs that are not being played back.

- During playback (with the carousel closed)

In this condition, you can see the ✳ EXCHANGE/○ DISC SKIP indicator is illuminated in green.

### 1 Press ✳ EXCHANGE/○ DISC SKIP.

The carousel opens without interrupting playback, while the ✳ EXCHANGE/○ DISC SKIP indicator goes off. "EXCHANGE" is briefly shown in the display window.

### 2 Set, remove or change discs in the accessible trays.

### 3 To access to the other trays, press ✳ EXCHANGE/○ DISC SKIP.

Each press of the button rotates the carousel, however, the tray corresponding to the disc being played back is never accessible.

### NOTES

- During the steps 2 and 3 above, only the **■**, **||**, **I◀◀/▶▶I**, **◀◀** and **▶▶** buttons are effective for the disc being played back.
- For details about functions of the ✳ EXCHANGE/○ DISC SKIP button, see the appropriate section on page 25.

## Resuming playback

The unit can memorize the position on a disc where you interrupt playback, and resume playback from that position later.

### To memorize the interrupted position



- During playback

Press ■, or press DVD STANDBY/ON on the remote control unit or STANDBY/ON on the front panel.

The unit memorizes the interrupted position.

“RESUME” appears in the display window for a few seconds.



- If you interrupt playback by pressing ■ and then turn off the power, the memory is not cleared.

### To resume playback



- While the disc you interrupt playback last time is still loaded in the disc tray

Press ►.

The unit starts playback from the position where you interrupted playback last time.

“RESUME PLAY” appears in the display window for a few seconds.

- **To clear the resume position memory**

Carry out one of the followings.

- \* Open the carousel.
- \* Press ■ while stopped.
- \* Press any of the DISC buttons (1 through 7) on the front panel, or the DISC SELECT button followed by any of the 1 through 7 numeric buttons.

#### NOTES

- The resume function does not work with Audio CD and MP3 discs.
- In the case of a Video CD disc with PBC function, the unit may resume playback from a point slightly earlier or later than the resume point you stored.

# Advanced operations

- Note that this section describes operations for playback of DVD VIDEO, Audio CD and Video CD discs. For MP3 disc playback, see the independent chapter on and after page 46.
- Make sure that the TV - DVD switch is set to "DVD" when using the CURSOR ▲/▼/◀/▶, numeric and TV/VIDEO - CANCEL buttons for controlling the unit.



## Playing from a specific position on a disc

You can play a disc from the selected track, title or chapter, or from the specified time.

### To locate a desired scene from the DVD menu



DVD VIDEO discs generally have their own menus which show the disc contents. These menus contain various items such as titles of a movie, names of songs, or artist information, and display them on the TV screen. You can locate a desired scene by using the menu.

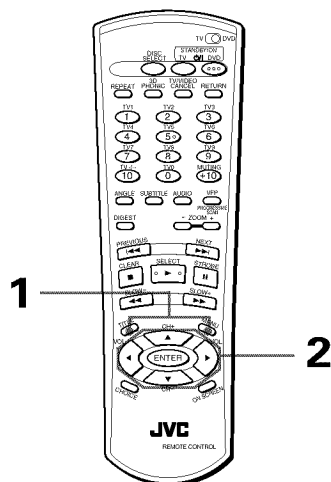

- Whenever a DVD VIDEO disc is loaded
- Press TITLE or MENU.  
The menu appears on the TV screen.



#### About menu

Normally, a DVD VIDEO disc which contains more than one title may have a "title" menu which lists the titles. In this case, the menu appears on the TV screen by pressing the TITLE button. Some DVD VIDEO discs may also have a different menu which appears by pressing the MENU button.

See the instructions of each DVD VIDEO disc for its particular menu.

Example:

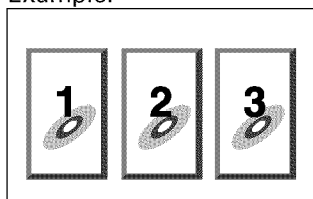

- Use CURSOR ▲/▼/◀/▶ to select a desired item, then press ENTER.

The unit starts playback of the selected item.



- With some discs, you can also select items by entering the corresponding number using the numeric buttons, which may cause the unit to automatically start playback.

#### NOTES

- When a disc icon appears on the TV screen by pressing TITLE in step 1:  
The disc does not have a menu listing the titles.
- When a disc icon appears on the TV screen by pressing MENU in step 1:  
The disc does not have a menu.
- The MENU button does not work while stopped.

### To locate a desired scene from the menu of the Video CD with PBC



Some Video CD discs supports the PBC function. PBC is an abbreviation of "PlayBack Control." A Video CD disc recorded with PBC has its own menus, such as a list of the songs of the disc. You can locate a specific scene by using the menu.

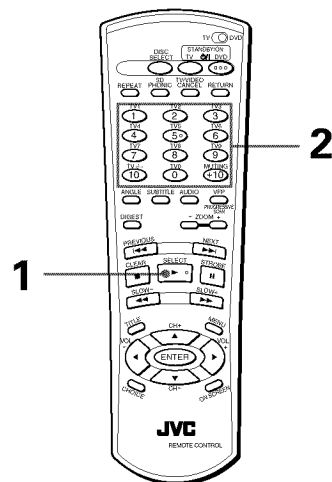

- When a Video CD disc with PBC is stopped
- Press ►.

A disc menu appears on the TV screen (The PBC function is activated).

Example:

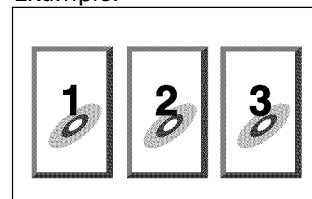

"PBC" is indicated in the display window on the front panel.

- Use the numeric buttons to select the desired item.

- See page 14 for details about how to use the numeric buttons.



The unit starts playback of the selected item. You can return to the menu by pressing the RETURN button.

When "NEXT" or "PREVIOUS" appears on the TV screen, the unit generally works as follows:

- Pressing ►► advances to the next page.
- Pressing ◀◀ returns to the previous page.

\* The method of the operation is different depending on the disc.

### Hints

- To activate the PBC function when a PBC-compatible Video CD disc is being played back without the PBC function, press ■ then press ►.
- You can also activate the PBC function using the on screen menu display as follows.
  - 1 Press ON SCREEN.
  - 2 Use CURSOR ▲/▼ to move Ⓕ to [PBC CALL], then press ENTER.
- If you want to playback a PBC-compatible Video CD disc without activating the PBC function, start playback by using the numeric buttons instead of the ►. See the next paragraph.

## To locate a desired selection using the numeric buttons



You can locate a desired title or chapter (DVD VIDEO) or track (Audio CD/Video CD) by specifying the number.

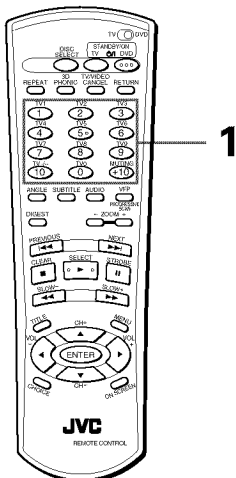

- For DVD VIDEO/Audio CD: During playback or while stopped
- For Video CD: During playback without PBC function or while stopped

### 1 Use the numeric buttons to specify the number.

- \* During DVD VIDEO playback (except when a menu is shown), a chapter is specified.
- \* While a DVD VIDEO is stopped, a title is specified.
- \* For an Audio CD or Video CD, a track is specified.

The unit starts playback from the beginning of the selection.

- See page 14 for details about how to use the numeric buttons.

Depending on the disc type and the unit status, what is specified differs.

Unit status	Disc type	What is specified
While stopped	DVD VIDEO	title or chapter(*)
	Audio CD/ Video CD	track
During playback	DVD VIDEO	chapter
	Audio CD/ Video CD	track

- \* If a disc contains more than one title, a title is specified. If a disc contains only one title, a chapter is specified.

The selected title or track number appears in the display window on the front panel.

### NOTES

- During DVD VIDEO playback, if a menu is shown on the TV screen, the numeric buttons may be used for selecting an item in the menu.
- When ⓪ appears on the TV screen: The title or track you have selected is not contained in the disc.
- This function does not work during Video CD playback with PBC function.

## To locate a desired selection using

◀◀ or ►►



You can locate the beginning of a chapter (for DVD VIDEO) or track (for Audio CD/Video CD) by using the ◀◀ or ►►.

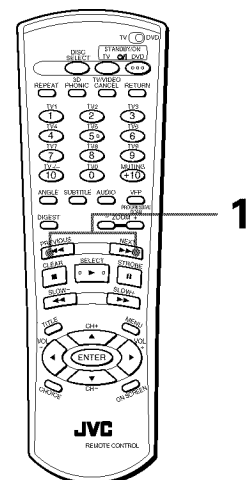

- For DVD VIDEO: During playback
- For Audio CD: During playback or while stopped
- For Video CD: During playback without PBC function

### 1 Press ◀◀ or ►►.

With an Audio CD or Video CD, pressing the button skips a track. With a DVD VIDEO disc, pressing the button skips a chapter or title depending on the disc configuration.

The selection number appears in the display window on the front panel.

- To skip forward chapters/tracks, press ►► as many times as required.
- To skip to the beginning of the current track/chapter, press ◀◀ once.
- To skip back chapters/tracks, press ◀◀ as many times required.

**NOTES**

- You can skip tracks within the current disc only.
- This function may not work with some DVD VIDEO discs.
- This function does not work during Video CD playback with PBC function.

**To locate a desired scene by specifying the chapter number [CHAP. SEARCH]**



If the current title of a DVD VIDEO disc being played is divided into chapters, you can skip to a desired chapter by specifying the chapter number using the on-screen display.

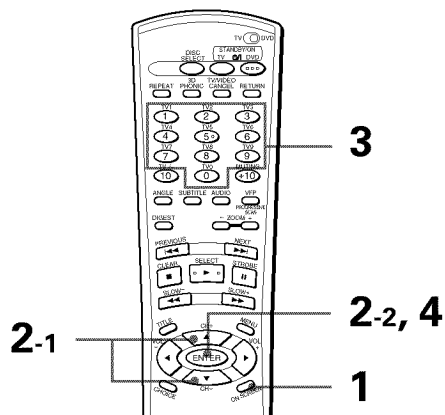

- During DVD VIDEO playback

**1** Press ON SCREEN.

The on-screen display appears on the TV screen.

**2** Use CURSOR ▲/▼ to move to [CHAP. SEARCH], then press ENTER.

"GO TO CHAPTER =" appears in the message area. The color of [CHAP. SEARCH] changes.

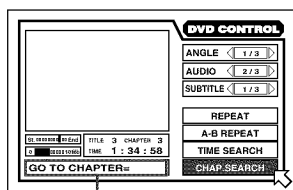

Message area

**3** Use the numeric buttons (0 to 9) to enter the desired chapter number.

Example:

To select chapter number 8:  
Press "8" → ENTER.

To select chapter number 37:  
Press "3" → "7" → ENTER.

The specified number appears in the message area.

**4** Press ENTER.

The unit starts playback from the selected chapter.



- The "10" and "+10" buttons are not used in this function.

**NOTES**

- You can also locate a desired chapter directly by specifying the chapter number using the numeric buttons during playback (except when a menu is shown). See page 31.
- When the chapter number is incorrect in step 3:  
Overwrite the incorrect number with the correct number.
- When is displayed on the TV screen in step 4:  
The chapter you have selected is not contained in the disc, or chapter search does not work on the disc.
- To return to the regular display:  
Press ON SCREEN.

**To locate a desired position in the current title or track [TIME SEARCH]**



You can play a disc from the desired position by specifying the elapsed time from the beginning of the current title or track using the TIME SEARCH function. Note that some DVD VIDEO discs do not contain time information, and the TIME SEARCH function cannot be used.

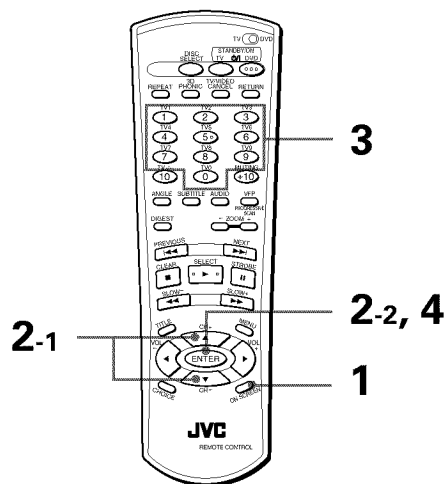

- For DVD VIDEO: During playback
- For Audio CD: During playback or while stopped
- For Video CD: During playback without PBC function or while stopped

**1** Press ON SCREEN.

The on-screen display appears on the TV screen.

**2** Use CURSOR ▲/▼ to move to [TIME SEARCH], then press ENTER.

"GO TO" appears in the message area. The color of [TIME SEARCH] changes.

### 3 Use the numeric buttons (0 to 9) to enter the time.

The specified time appears in the message area.

### 4 Press ENTER.

The unit starts playback from the specified time.

(for DVD VIDEO)

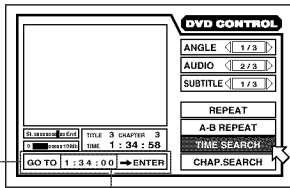

Selected time Message area

(for Audio CD)

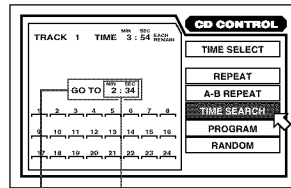

Selected time Message area

#### Hints

- "10" and "+10" buttons are not used with this function.
- You can specify the time in hour/minute/second format for DVD VIDEO discs, and in minute/second format for Audio and Video CD discs.

(for Video CD)

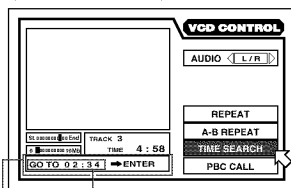

Selected time Message area

#### Example (for DVD VIDEO)

To playback from 2(H):34(M):00(S)

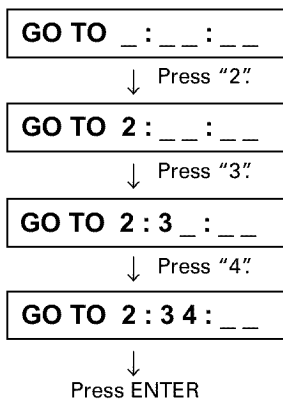

You do not have to press "0" to enter the trailing zeros (for the last two digits in the example above). Of course, it is possible to enter them.

#### When you make a mistake

Move the cursor to the incorrect value, then press the correct button to re-select the value.

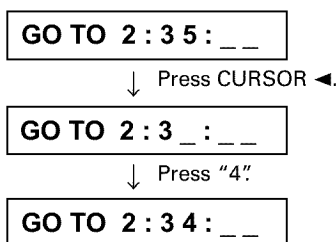

#### NOTES

- When appears on the TV screen in step 2: The time you have selected is not contained on the disc, or the Time search function does not work on the disc. Also note that the Time search function does not work during Video CD playback with the PBC function.
- To return to the regular display: Press ON SCREEN.
- The TIME SEARCH function cannot be used during program playback.

## To locate a desired scene from the display [DIGEST]



The unit can display the opening scene of each title or chapter on a DVD VIDEO or each track of a Video CD. You can select a desired scene from those displayed on the TV screen.

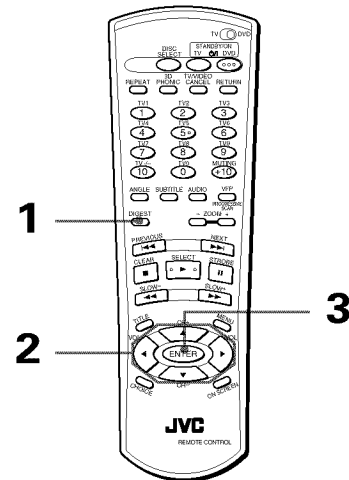

- For DVD VIDEO: While stopped or during playback
- For Video CD: While stopped or during playback without PBC function

### 1 Press DIGEST.

Up to nine opening scenes are displayed.

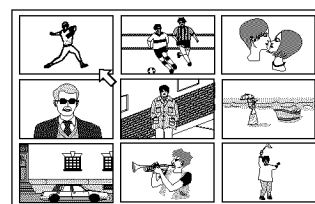

- While a DVD VIDEO disc is stopped:  
The opening scene of each title appears on the TV screen.
- During DVD VIDEO disc playback:  
The opening scene of each chapter in the current title appears on the TV screen.
- When a Video CD disc is loaded:  
The opening scene of each track appears on the TV screen.

**2** Use CURSOR ▲/▼/◀/▶ to move  to select the desired scene.

If there are more than 9 scenes, the digest screen will have more than one page. In this case, pressing **▶▶** advances to the next page, while pressing **◀◀** returns to the previous page.

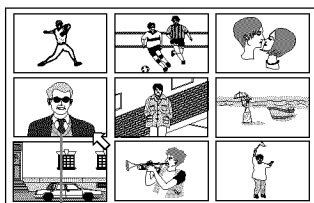

Selected scene

**Hints**

- When the lower right scene is selected, pressing CURSOR **▶** advances to the next page if available. Similarly, when the upper left scene is selected, pressing CURSOR **◀** returns to the previous page (if available).
- Depending on discs, it may take some time until all scenes of the current page appear on the TV screen. If you want to turn the page, you do not have to wait to press **◀◀** or **▶▶** until all scenes appear.

**3** Press ENTER.

The unit starts playback from the selected scene.

**NOTE**

- With some discs, depending on the contents, it may take some time until all the scenes appear on the screen.

## Special picture playback

The unit provides special picture playback functions including Frame-by-frame, Strobe, Slow-motion and Zoom.

### To advance a still picture frame-by-frame

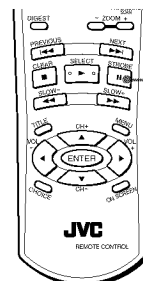

- While paused (still)

**1** Press **II**.

Each time you press **II**, the still picture advances to the next frame.

Pressing **▶** returns to normal playback.

### To display continuous still pictures [STROBE]

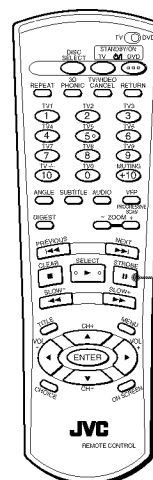

- During playback

**1** At the point you want to view as continuous photographs, press **II**.

The unit pauses playback.

**2** Press and hold **II** for more than 1 second.

Nine continuous still pictures appear on the TV screen.

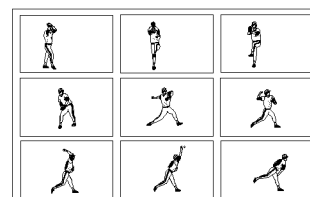



- Pressing **II** when the nine still pictures are shown will advance pictures frame by frame.
- **To cancel strobe play**  
Press and hold **II** for more than 1 second.

### NOTES

- The sound is muted during **STROBE** playback.
- If you press and hold **II** for more than 1 second during playback, nine still pictures also appear but they advance in normal playback speed.

## To playback in slow-motion [SLOW]

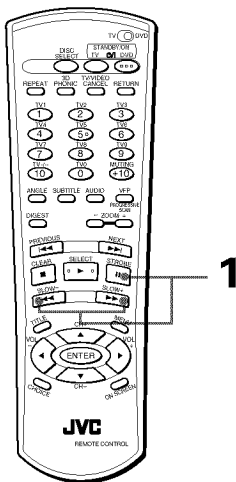

- During playback

### 1 Press **II**, then use **◀◀/▶▶**.

To play forward slow-motion, press **▶▶**, and to play reverse slow-motion (for DVD VIDEO discs only), press **◀◀**. First, the unit plays the slowest speed, and each time you press the button, the playback speed increases.

- **To return to normal playback**  
Press **▶**.
- **To pause slow-motion playback**  
Press **II**.

### NOTES

- The sound is muted during slow-motion playback.
- Reverse slow-motion playback is not possible for a Video CD.

## To zoom in/out [ZOOM]



English

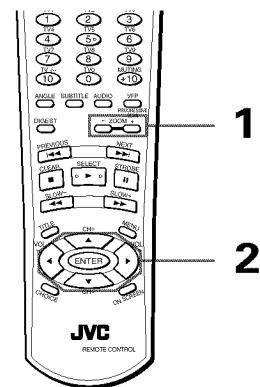

- During playback or while paused

### 1 Press **ZOOM +** or **-**.

The unit zooms in by pressing **ZOOM +** or zooms out by pressing **ZOOM -**. Each time you press **ZOOM +**, the magnification is doubled (up to x 1024). Each time you press **ZOOM -**, the magnification is halved (down to x 1/8).

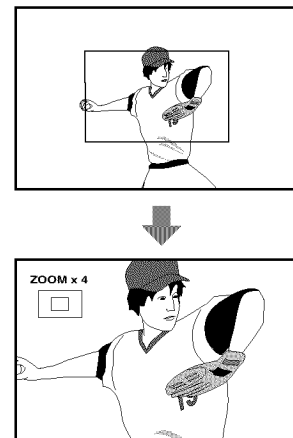

At the top-left of the screen, the information for the current magnification appears, as well as the zoomed-in position of the scene that can be moved by operating the next step.

### 2 Use **CURSOR ▲/▼/◀/▶** to move the zoomed position.

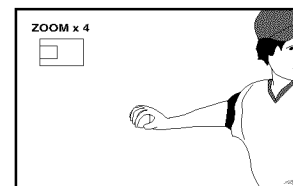

- **To return to normal playback**  
Press **ENTER**.

### NOTE

- While zoomed, the picture may look coarse.

# Changing the playback order

You can play tracks on a Audio or Video CD disc currently loaded in the desired order or in random order using the Program or Random playback function.

Note that you cannot use these functions among multiple discs.

## To playback in the desired order [PROGRAM]



You can play tracks on an Audio CD/Video CD disc in the desired order by using the Program function.

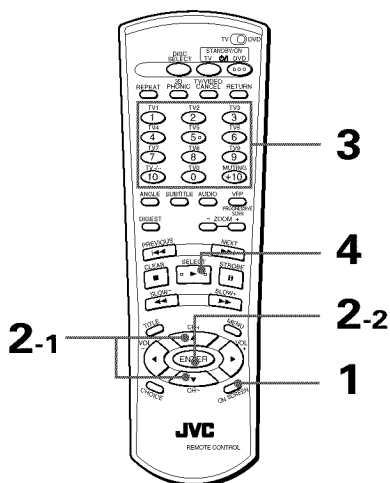

• While stopped

**1** Press ON SCREEN.

The on-screen display appears on the TV screen.

**2** Use CURSOR ▲/▼ to move to [PROGRAM] and press ENTER.

The color of [PROGRAM] changes.

(for Audio CD)

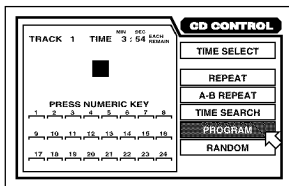

(for Video CD)

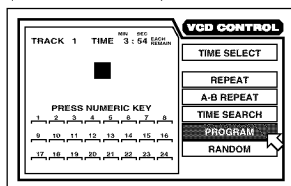

The program table appears on the on-screen display (as shown above).

The "PROGRAM" indicator lights in the display window on the front panel.

**3** Specify tracks on the disc loaded in the desired order using the numeric buttons.

See page 14 for details about how to use the numeric buttons.

Up to 24 tracks can be programmed. You may select the same track more than once.

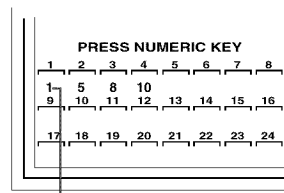

Selected track number

• **If you specify a wrong selection**  
Press TV/VIDEO - CANCEL button. The last selection programmed is erased.

• **To clear the program**

Press .

**4** Press to start program play.

When all of the programmed tracks have finished playback, the unit stops but the program remains.

### NOTES

- You cannot use the program playback function among discs set in the carousel. You can program only tracks on the disc currently loaded.
- During program playback, pressing skip to the next selection of the program. Pressing returns to the beginning of the current selection.

• **To quit program playback**

Press ENTER when points [PROGRAM]. [PROGRAM] returns to its original color.

(When playing back a Video CD, you have to press and then press ON SCREEN to bring up the on-screen display.)

• **To clear the program**

While stopped and the on-screen display is shown on the TV screen, move to [PROGRAM] and then press . All the programmed tracks are erased. You can also clear the program by opening the carousel or changing the current disc.

## To playback in random order [RANDOM]



You can play tracks on an Audio CD or Video CD disc in random order by using the Random function.

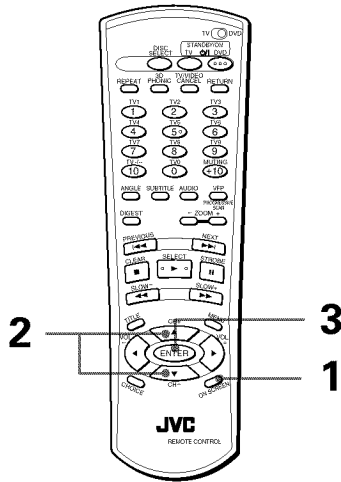

● While stopped

### 1 Press ON SCREEN.

The on-screen display appears on the TV screen.

### 2 Use CURSOR ▲/▼ to move to [RANDOM].

(for Audio CD)

(for Video CD)

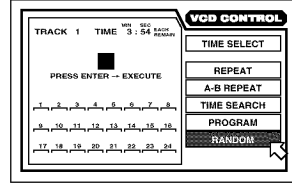
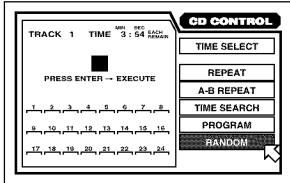

### 3 Press ENTER.

The color of [RANDOM] changes.

The unit starts random playback.

The "RANDOM" indicator appears in the display window on the front panel. After playing all tracks of the disc loaded, random playback ends.

### Hints

- The same track will not be played back more than once during random play.
- During Audio CD playback, pressing ENTER when points [RANDOM] quits random mode and continues playback in the normal order.

### To quit random playback in the middle

Press . The unit stops playback and quits the random playback mode.

You can also clear the random mode by opening the carousel or changing the current disc.

### NOTE

- Random playback is carried out only within the disc currently loaded.

## Repeat playback

You can repeat playback of the current selection or all disc contents on the disc currently loaded (except DVD VIDEO). You can also repeat playback of a desired part. Note that you cannot repeat playback of multiple discs.

## To repeat the current selection or all tracks [REPEAT]



### Method 1

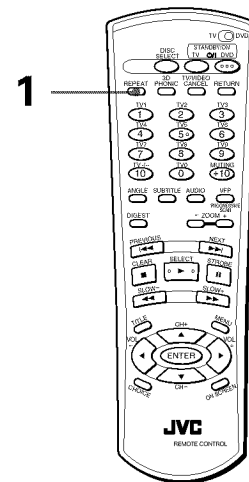

● For DVD VIDEO:

During playback

For Audio CD/Video CD: In any condition except

Video CD playback with PBC

### 1 Press REPEAT.

Each time you press REPEAT, the repeat mode toggles among All repeat, Repeat 1 and OFF. You can see the selected mode by icons in the display window on the front panel as below.

: Repeats the current title for DVD VIDEO or the all tracks on the current disc for Audio CD/Video CD.

: Repeats the current chapter for DVD VIDEO or the current track for Audio CD/Video CD.

No indication: The repeat mode is off.

(Display window)



Repeat mode indicators

## Method 2

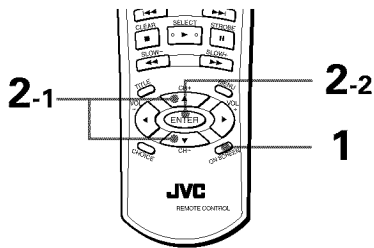

- For DVD VIDEO: During playback
- For Audio CD/Video CD: In any condition except Video CD playback with PBC

### 1 Press ON SCREEN.

The on-screen display appears on the TV screen.

### 2 Use CURSOR ▲/▼ to move [REPEAT], then press ENTER.

Each time you press ENTER, the repeat mode changes as follows depending on the disc type and unit's status:

- During DVD VIDEO playback

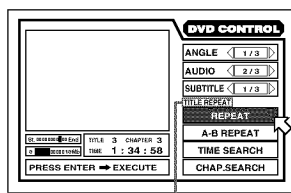

Selected repeat mode

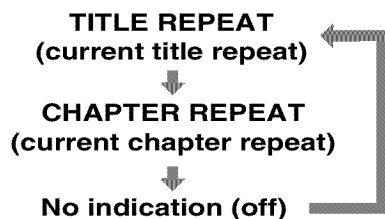

- Audio CD/Video CD

(for Audio CD)

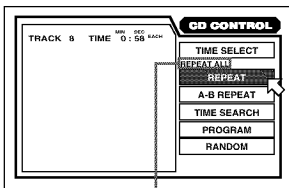

Selected repeat mode

(for Video CD)

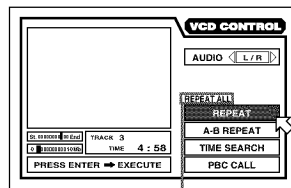

Selected repeat mode

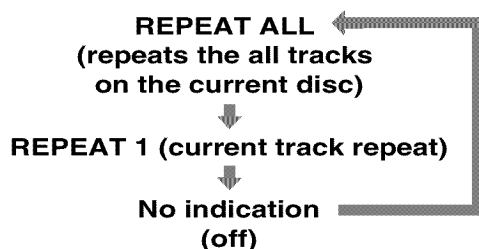

The selected mode is also shown on the on-screen display, however, it is shown in the different way from the display window. The following table shows the relation between them.

Disc type	On-screen display	Display window
DVD VIDEO	TITLE REPEAT	⌚
	CHAPTER REPEAT	⌚1
Audio CD/ Video CD	REPEAT ALL	⌚
	REPEAT 1	⌚1

- To stop repeat playback

Press ■.

When a DVD VIDEO disc is set, the unit stops playback and quits the repeat mode.

When an Audio CD or Video CD disc is set, the unit stops playback but does not quit the repeat mode.

- To quit repeat playback

Perform one of the following:

- \* Press REPEAT until the repeat mode indicator goes off in the display window.

- \* When [REPEAT] points [REPEAT], press ENTER repeatedly until [REPEAT] returns to its original color.

You can also clear the repeat mode by opening the carousel or changing the current disc.

### NOTES

- The repeat function can be applied only to the disc currently being played back.
- When the program playback mode is active with an Audio CD or Video CD, the repeat mode changes in the same manner (i.e. toggles among REPEAT ALL, REPEAT 1 and no indication). Note that, however, in the "REPEAT ALL" mode the unit repeats all the programmed tracks, instead of all tracks on the disc.
- If ⌚ appears when pressing ENTER in step 2 above during DVD VIDEO playback

You cannot repeat the title or chapter because of the disc contents.

- Repeat playback function cannot be used during Video CD playback with PBC function.

- To turn off the on-screen display

Press ON SCREEN.



## To repeat a desired part [A-B REPEAT]

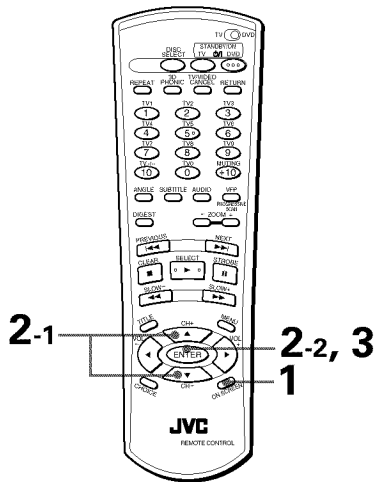

- During playback

### 1 Press ON SCREEN.

The on-screen display appears on the TV screen.

### 2 Use CURSOR ▲/▼ to move to [A-B REPEAT], then press ENTER at the beginning of the part you want to repeat (point A).

The color of [A-B REPEAT] changes.

### 3 Press ENTER at the end of the part you want to repeat (point B).

The unit locates "A" and starts repeat playback between "A" and "B."

(for DVD VIDEO)

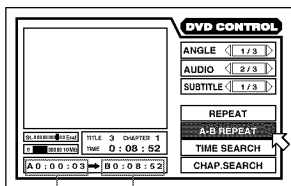

Point A Point B

(for Audio CD)

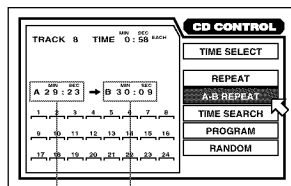

Point A Point B

(for Video CD)

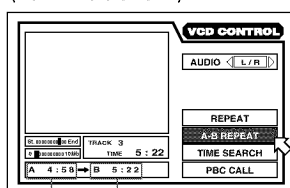



Point A Point B

- To quit A-B repeat playback

Press . The unit stops playback and quits A-B repeat mode.

You can also clear the A-B repeat mode by opening the carousel or changing the current disc.



- During playback, pressing ENTER when  is pointed at [A-B REPEAT] quits A-B repeat mode and continues playback.
- You can also quit A-B repeat mode by pressing  or .

### NOTES

- Points A and B must be specified on the same track or chapter.

After specifying point A, if you do not specify point B until the playback position moves to the next track/ chapter, the unit quits the A-B repeat mode and the color of [A-B REPEAT] on the on-screen display returns to its original color.

- To turn off on-screen display

Press ON SCREEN.

- If  appears when pressing ENTER in step 2 during DVD VIDEO playback

You cannot repeat the selected portion because of the disc contents.

# Selecting a scene angle of DVD VIDEO

You can enjoy a variety of scene angles if the DVD VIDEO disc contains "multi-angle" parts, where multiple cameras were used to shoot the same scene from different angles.

### Hints

- At the beginning of a "multi-angle" part,  appears on the TV screen.

## To select a scene angle from the normal screen [ANGLE]



### From normal screen

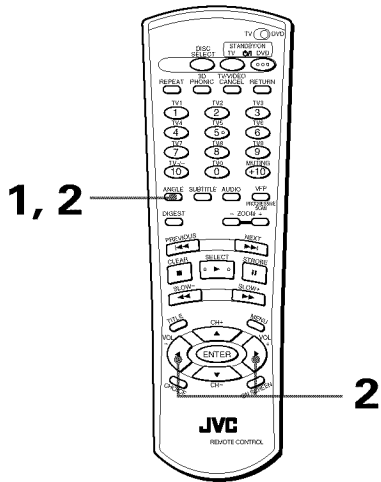

- During DVD VIDEO playback

#### 1 Press ANGLE.

The Angle selection display appears on the TV screen.



#### 2 Use ANGLE or CURSOR to select the desired angle.

Each time you press ANGLE or CURSOR  , the angle changes.

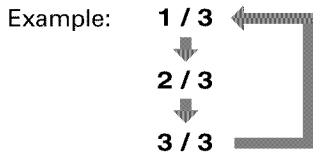

### NOTES

- The Angle selection display will automatically disappear if you do not change the angle for several seconds.
- To turn off the Angle selection display manually, press ENTER.
- When  appears on the TV screen  
The current scene is not recorded from multiple angles.

### From on-screen display

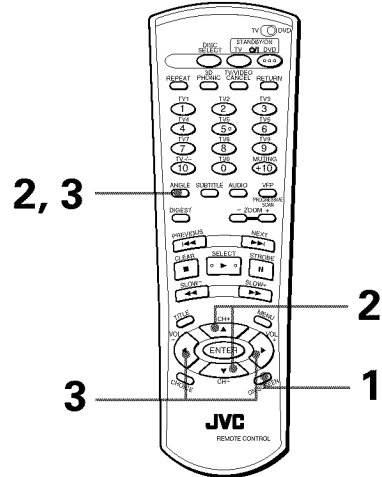

- During DVD VIDEO playback

#### 1 Press ON SCREEN.

The on-screen display appears on the TV screen.

#### 2 Use CURSOR / or ANGLE to move to [ANGLE].

The total number of recorded angles

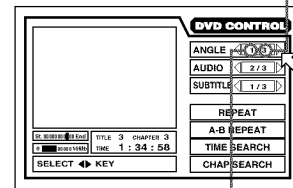

The current angle number

#### 3 Use CURSOR / or ANGLE to select the desired angle number.



### NOTES

- To turn off the on-screen display  
Press ON SCREEN.
- When  appears on the TV screen  
The current scene is not recorded from multiple angles.

## To select a scene angle from the angle list display [ANGLE]

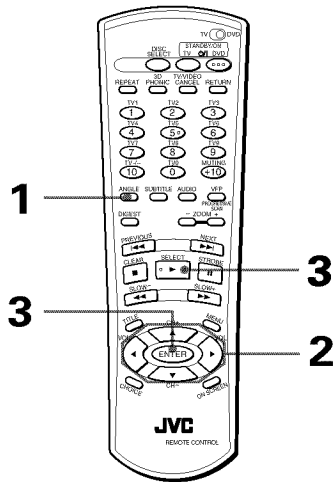

● During DVD VIDEO playback

**1** Press and hold ANGLE for more than 1 second.

Up to nine camera angles recorded on a disc appear on the TV screen.

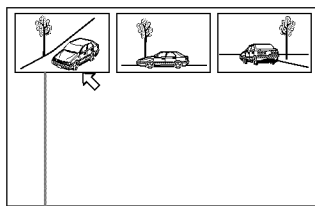

The selected camera angle

**2** Use CURSOR ▲/▼/◀/▶ to select the desired angle.

**3** Press ENTER or ▶.

The unit starts playback by the selected angle on the full-sized screen.

### NOTES

- When  appears on the TV screen in step 1: The current scene is not recorded from multiple angles.
- During the operation above, audio is muted.

## Changing the language and sound

For DVD VIDEO discs, you can select the subtitle language, as well as the audio language/sound included on a disc. For Video CD discs, you can select the audio channel(s).

### To select the subtitle language [SUBTITLE]



From normal screen

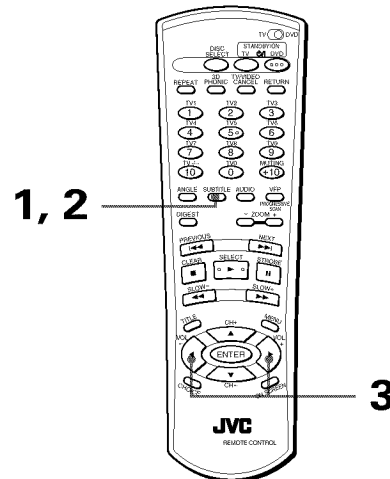

● During DVD VIDEO playback

**1** Press SUBTITLE.

The Subtitle selection display appears on the TV screen.

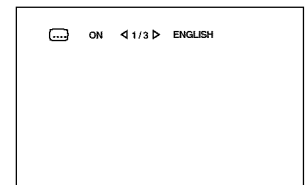

**2** To turn the subtitle on and off, press SUBTITLE.

**3** To select the desired subtitle language, use CURSOR ◀/▶.

Each time you press CURSOR ◀/▶, the subtitle language changes.

Example:

**1/3 ENGLISH**



**2/3 FRENCH**



**3/3 SPANISH**



**-/3 (off)**

## From on-screen display

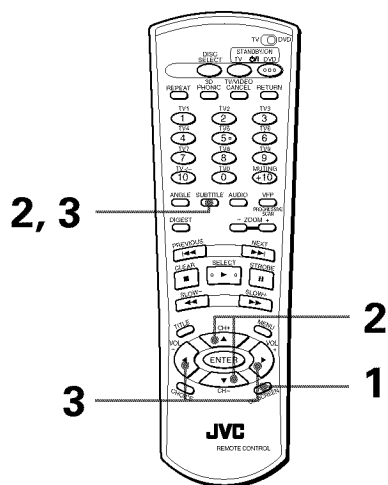

- During DVD VIDEO playback

### 1 Press ON SCREEN.

The on-screen display appears on the TV screen.

### 2 Use CURSOR ▲/▼ or SUBTITLE to move to [SUBTITLE].

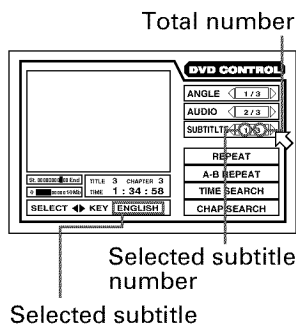

### 3 Use CURSOR ◀/▶ or SUBTITLE to select the desired subtitle.

Each time you press CURSOR ◀/▶ or SUBTITLE, the subtitle changes.

#### NOTES

- For DVD VIDEO, the selected language may be abbreviated on the TV screen. See "Appendix A: Table of languages and their abbreviations" at the end of this manual.
- The Subtitle selection display will automatically disappear if you do not change the subtitle for several seconds.
- To turn off the Subtitle selection display manually, press ENTER.
- To turn off the on-screen display: Press ON SCREEN.
- When  appears on the TV screen: You cannot select the subtitle.

## To change the audio language or sound [AUDIO]



By AUDIO selection, you can choose the audio language of movies or enjoy KARAOKE with or without the vocal.

## From normal screen

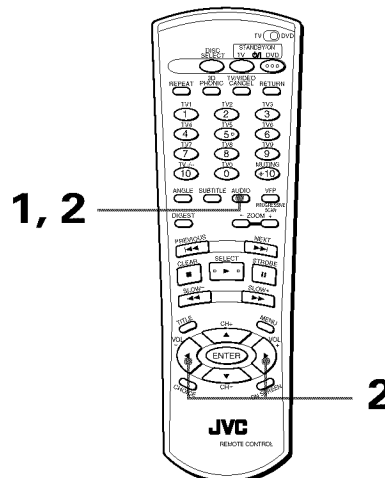

- During playback

### 1 Press AUDIO.

The Audio selection display appears on the TV screen.

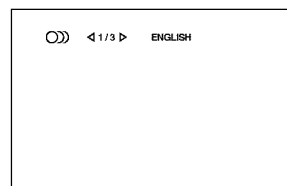

### 2 Use AUDIO or CURSOR ◀/▶ to select the desired audio.

## From on-screen display

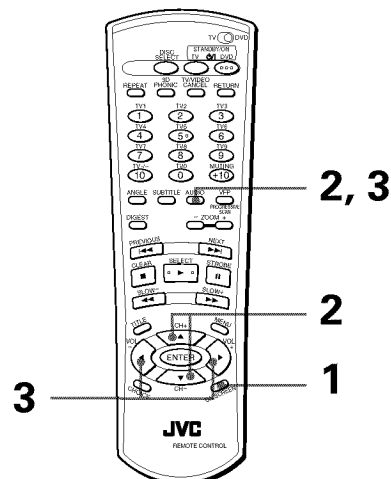

- During playback

### 1 Press ON SCREEN.

The on-screen display appears on the TV screen.

## 2 Use CURSOR ▲/▼ or AUDIO to move [ ] to [AUDIO].

(for DVD VIDEO)

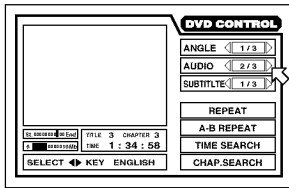

(for Video CD)

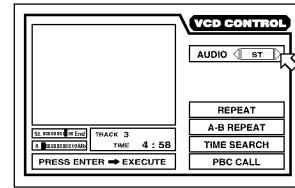

## 3 Use CURSOR ◀/▶ or AUDIO for audio selection.

Each time you press CURSOR ◀/▶ or AUDIO, the audio changes.

See the following examples for audio selection.

### • For DVD VIDEO

Each time you press CURSOR ◀/▶ or AUDIO, the audio language or sound changes.

Total number

Example:  
 1/3 ENGLISH  
 ↓  
 2/3 FRENCH  
 ↓  
 3/3 SPANISH

Selected audio number  
 Selected audio language

### • For Video CD

Each time you press CURSOR ◀/▶ or AUDIO, the playback audio changes as follows.

ST (stereo)  
 ↓  
 L  
 ↓  
 R

### NOTES

- For DVD VIDEO, the selected language may be abbreviated on the TV screen. See "Appendix A: Table of languages and their abbreviations" at the end of this manual.
- The Audio selection display will automatically disappear if you do not change the audio for several seconds.
- To turn off the Audio selection display manually, press ENTER.
- To turn off the on-screen display:  
Press ON SCREEN.
- When [ ] appears on the TV screen (for a DVD VIDEO disc):  
You cannot select the audio.

## Miscellaneous functions

### To adjust the picture character [VFP]



The VFP (Video Fine Processor) function enables you to adjust the picture character according to the type of programming, picture tone or personal preferences.

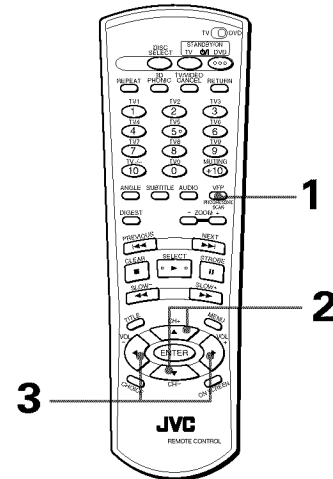

### • During playback

#### 1 Press VFP - PROGRESSIVE SCAN to select the desired preset.

Each time you press the button, the preset changes as follows:

Selected preset

Level  
 Parameter

NORMAL  
 ↓  
 CINEMA  
 ↓  
 USER 1  
 ↓  
 USER 2

"NORMAL" and "CINEMA" are factory presets and you cannot change parameters for them.

While selecting "USER 1" or "USER 2", you can adjust parameters that affect the picture character and store the settings as the user preset. See the step below.

#### 2 To define a user setting, select a parameter to be edited using CURSOR ▲/▼ from the followings.

- **BRIGHTNESS**  
Controls the brightness of the screen.
- **CONTRAST**  
Controls the contrast of the screen.
- **COLOR**  
Controls the color depth of the screen.

- **TINT**  
Controls the tint of the screen.
- **SHARPNESS**  
Controls the sharpness of the screen.
- **Y DELAY**  
Controls the color gap of the screen.
- **GAMMA**  
Controls the brightness of neutral tints with maintaining the brightness of dark and bright portions.

**3** Adjust the level of the parameter using **CURSOR** ◀/▶.

Moving the adjusting bar to the left reduces the effect, while moving the bar to the right enhances the effect.

**NOTE**

- The number of setting steps depends on parameters.

**Hints**

- The VFP screen disappears if no operations are made for more than 10 seconds. You can also turn off the VFP screen manually by pressing ENTER.

**To simulate surround sound [3D PHONIC]**



Using the 3D PHONIC function, you can get a simulated surround effect from your stereo system.

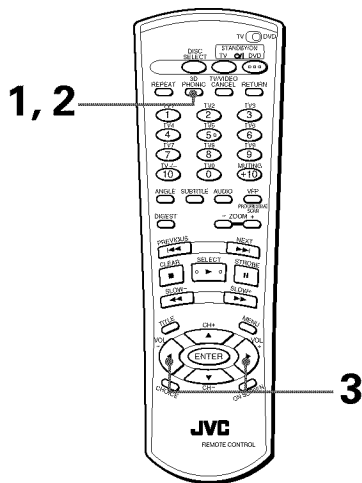

- During playback

**1** Press 3D PHONIC.

The 3D PHONIC display appears on the TV screen.

**2** Select the desired mode by using 3D PHONIC.

Each time you press the 3D PHONIC button, the 3D PHONIC mode changes as follows:

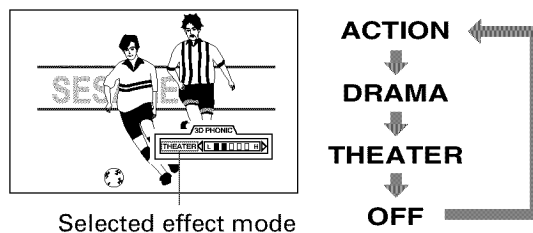

Selected effect mode

- **ACTION**  
Suitable for action movies and sports programs in which sounds dynamically move.
- **DRAMA**  
Natural and warm sound. You can enjoy movies in a relaxed mood.
- **THEATER**  
You can enjoy sound effects like in a major theater in Hollywood.

**3** Press **CURSOR** ◀/▶ to adjust the effect level.

You can adjust the effect level in 5 steps.



Effect level

- Toward L: Reduces the effect.
- Toward H: Enhances the effect.

**Hints**

- To turn off the 3D PHONIC screen, press ENTER. The 3D PHONIC screen disappears if no operations are made for more than 10 seconds.

**NOTES**

- The 3D PHONIC function works correctly only when playing back a DVD VIDEO disc recorded with the Dolby Digital. With other sources, you cannot get any effect if you press the 3D PHONIC button.
- When playing back a DVD VIDEO disc recorded with the Dolby Digital that does not contain the rear signal, you cannot get a correct 3D PHONIC sound though you can change the 3D PHONIC setting.
- The 3D PHONIC function does not affect the Dolby Digital bitstream signal from the DIGITAL output jack.
- When you set the 3D PHONIC function is active, the "DOWN MIX" and "COMPRESSION" setting in the "PREFERENCE 2" display are disabled.

## To check the disc time [TIME SELECT]



You can choose the time display mode for an Audio CD or Video CD disc in the display on the front panel and in the on-screen display.

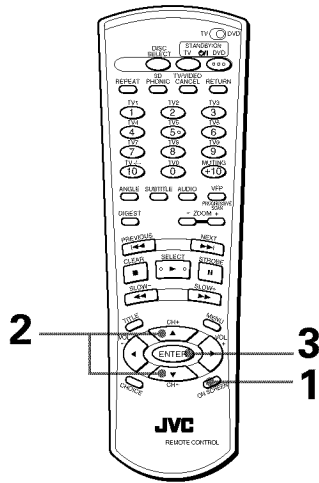

- For Audio CD: During playback or while stopped  
For Video CD: While stopped

**1** Press ON SCREEN.

The on-screen display appears on the TV screen.

**2** Use CURSOR ▲/▼ to move to [TIME SELECT].

(for Audio CD)

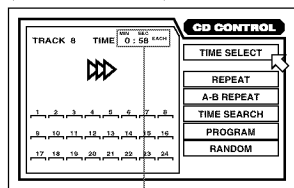

Time display

(for Video CD)

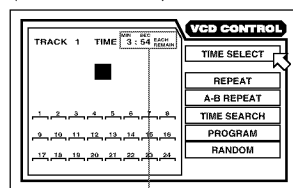

Time display

**3** Press ENTER.

Each time you press ENTER, the time mode changes as follows:

- During playback (for Audio CD)

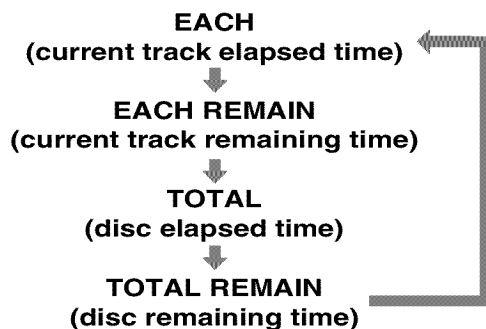

- While stopped

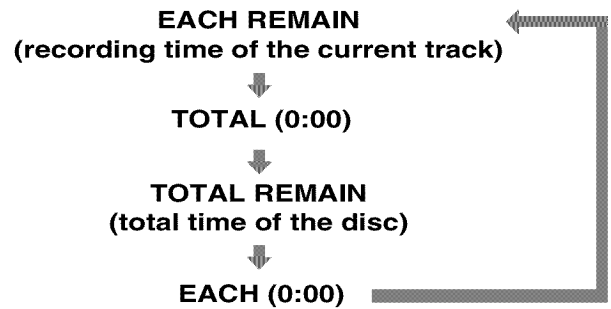

- When you select "EACH REMAIN" while stopped, you can change the track by pressing ◀◀ or ▶▶.

## Changing the brightness of the display window

You can dim the brightness of the display window.

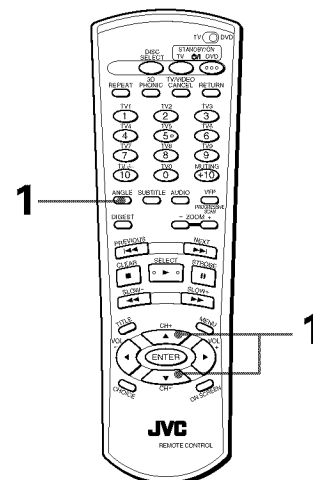

- When no disc is inserted

**1** Press CURSOR ▲ or ▼ while holding down ANGLE.

You can select the brightness of the display window from among three levels.

# MP3 disc playback

This unit can playback CD-R discs recorded by the MP3 format (we refer to those discs as MP3 discs in this manual).  
Though available functions with MP3 discs are limited, operations for the available functions are similar to those with Audio CD discs.

## What is MP3?

MP3 is the abbreviation of "MPEG1 Audio Layer 3". MPEG Audio is a compression specification that compresses the audio portion only. This image compression method is used in DVD or Video CD, etc. The audio data has been compressed into about 1/10.

## About MP3 disc

On an MP3 disc, each material (song) is recorded on a Track (file). Tracks are usually grouped into a "Group" (folder) by category, by artist, etc. In addition, Groups can also be members of Groups (Groups' Group), creating hierarchical Group layers. If you are familiar with personal computers, you may easily understand the hierarchical Group layer construction of MP3 discs because it is similar to the folder layer construction of computers.

This unit can handle up to 100 Tracks per Group, up to 100 Groups per Group layer and up to 10 Group layers. If a disc has more Tracks, Groups or Group layers than the above, the unit does not recognize those exceeding the maximum numbers and cannot playback them.

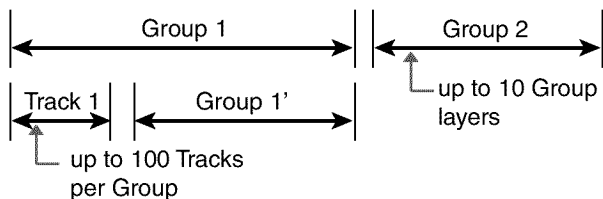

## NOTES for making a private MP3 disc using a CD-R disc:

- Select "ISO 9660" as the disc format.
- Do not select the "multi-session" recording.
- Finalize the disc after completing recording.

## NOTES

- The unit does not support "packet write" discs.
- Some disc may not be played back because of the disc characteristics or recording condition.
- The unit does not output a digital audio signal from DIGITAL OUT when playing back an MP3 disc.
- You cannot playback Tracks in the desired (programmed) or random order.
- The screen saver function is not active with an MP3 disc, as with an Audio CD.
- The unit only can play back Tracks with any of the following file extensions; "MP3", "Mp3", ".mp3" and ".mP3".

## Operations

### Basic operations

MP3

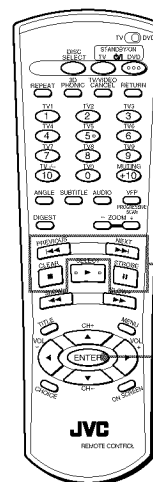

Basic control buttons

The following table shows basic functions of basic control buttons.

Buttons	Functions
<b>ENTER</b>	Starts playback
■	Stops playback completely
	Pauses playback temporarily
◀◀/▶▶	Skips back or forward a Track in the Group*

\* You cannot skip a Track across a Group.

## NOTES

- The current Track number is shown on the display window in the following manner.



Current track elapsed time  
Current track number

- Only MP3 files are shown on the display window as a track.
- Group number is not shown in the display window.
- You cannot advance or reverse playback of an MP3 disc rapidly.
- You cannot see any other time information but the current track elapsed time.



## Specifying the desired Group and Track

MP3

When loading an MP3 disc, after the disc contents are read, the MP3 CONTROL display automatically appears on the TV screen. You can specify the desired Group and Track for playback via this display.

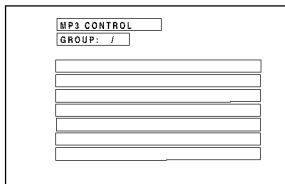

You can specify the desired Group/Track from the display by the following procedure.

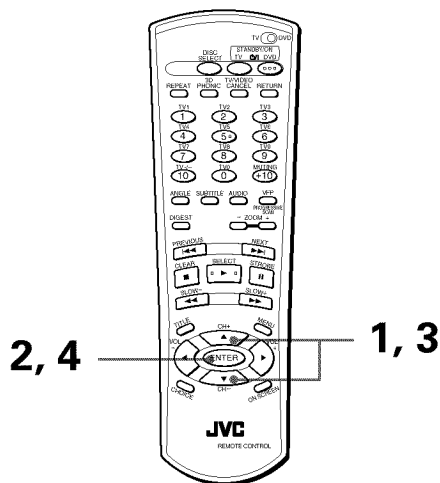

- When the MP3 selection display is shown while stopped

**1** Highlight a desired Group using CURSOR ▲/▼.

**2** Press ENTER.

The highlighted Group is selected, and contents of the Group is shown.

- If tracks in the selected Group are shown, go to the next step.
- If there are one or more Groups in the selected Group, repeat steps 1 and 2 until tracks in the selected Group are shown.

**3** Highlight a desired Track using CURSOR ▲/▼.

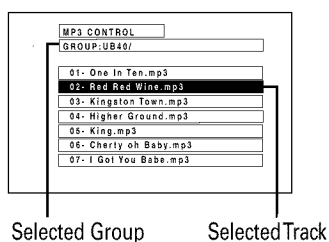

**4** Press ENTER.

The unit starts playback from the specified Track. During playback, the bottom row of the display shows something like below.

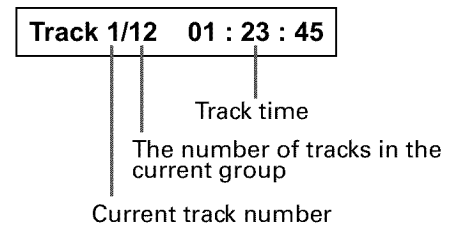

### NOTES

- If a MP3 file name includes any 2-byte character, the unit may not show the file name correctly.
- You can select (highlight) a track which does not belong to any Group (if there is any). In this case, pressing ENTER immediately starts playback.
- Pressing the CURSOR ◀ button returns to the higher hierarchical layer of Groups.
- Only MP3 files are shown on the MP3 CONTROL display.
- The order of Groups/Tracks shown in the MP3 CONTROL display may differ from the order shown on your personal computer when you set the disc on your computer.

## Repeat playback

MP3

You can repeat playback of the current track or group.

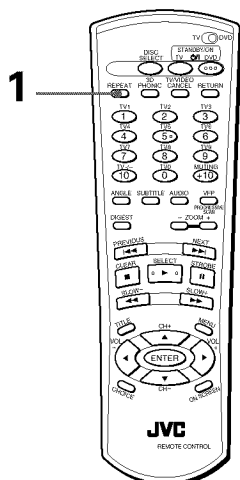

- During playback or while stopped

### 1 Press REPEAT.

Each time you press REPEAT, the repeat mode toggles among current group repeat, current track repeat and off.

You can see the selected mode by icons in the display window on the front panel as below.

↻: Repeats the current group on the disc.

↻1: Repeats the current track.

No indication: The repeat mode is off.

- **To stop repeat playback**

Press ■.

- **To quit repeat playback**

Press REPEAT as many times until no repeat icon is shown on the display window.

#### NOTE

- You cannot repeat all contents on the disc.

## Selecting preferences

You can set various preferences for playback via two preference displays.

### How to set preferences

You can bring up a preference display at any time except the unit is turned off.

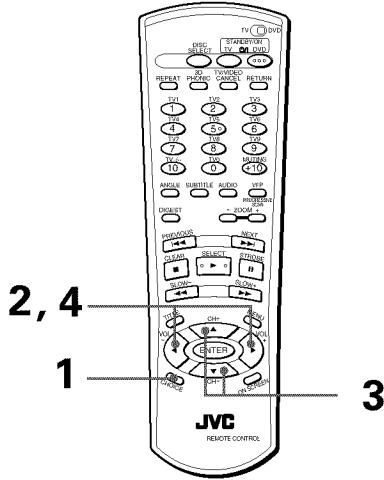

● In any condition except the unit is turned off.

#### 1 Press CHOICE.

One of the Preference on-screen displays appears on the TV monitor.

You can see two tabs for the displays (PREFERENCE 1 and PREFERENCE 2) at the top.

#### 2 Select the appropriate tab using CURSOR ◀/▶ when points either one of the tabs.

PREFERENCE 1

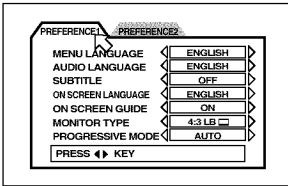

PREFERENCE 2

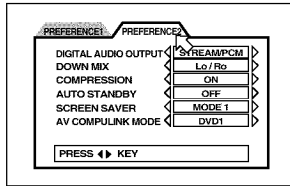

#### 3 Move to select the item you want to edit by using CURSOR ▲/▼.

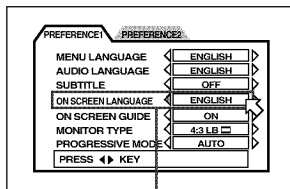

Selected item

#### 4 Press CURSOR ◀/▶ to select from options.

- For details about each setting, see the following paragraphs:

### NOTES

- To return to the normal screen: Press CHOICE.
- If you bring up a PREFERENCE display during DVD VIDEO/Video CD playback, the unit memorizes the current playback position, and resumes playback from that position later when dismissing the PREFERENCE display.

## Language and display preference

The "PREFERENCE 1" display handles preferences related to language and display.

### MENU LANGUAGE

You can select the default "display" language to be displayed if it is contained on a DVD VIDEO disc.

Each time you press CURSOR ▶, the language setting changes in the following order:

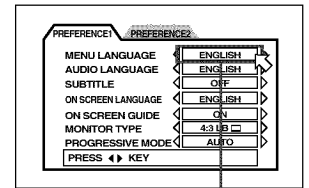

Selected language

**ENGLISH → SPANISH → FRENCH → CHINESE → GERMAN → ITALIAN → JAPANESE → language code from AA to ZU**

(See "Appendix A: Table of languages and their abbreviations" at the end of this manual.)

Pressing CURSOR ◀ changes the language setting in the reverse order of the above.

\* If the selected language is not recorded, the disc's default display language will be displayed.

### AUDIO LANGUAGE

You can select the default audio language to be played if it is contained on a DVD VIDEO disc.

Each time you press CURSOR ▶, the language setting changes in the following order:

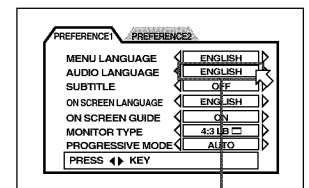

Selected language

**ENGLISH → SPANISH → FRENCH → CHINESE → GERMAN → ITALIAN → JAPANESE → language code from AA to ZU**

(See "Appendix A: Table of languages and their abbreviations" at the end of this manual.)

Pressing CURSOR ◀ changes the language setting in the reverse order of the above.

\* If the selected language is not recorded, the disc's default audio language will be played.

## SUBTITLE

You can select the default subtitle language to be displayed if it is contained on a DVD VIDEO disc.

Each time you press CURSOR ►, the language setting changes in the following order:

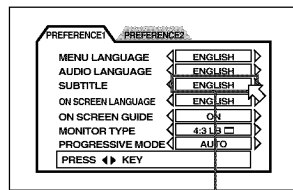

Selected language

**OFF → ENGLISH → SPANISH → FRENCH → CHINESE → GERMAN → ITALIAN → JAPANESE → language code from AA to ZU**

(See "Appendix A: Table of languages and their abbreviations" at the end of this manual.)

Pressing CURSOR ◀ changes the language setting in the reverse order of the above.

\* If the selected language is not recorded, the disc's default subtitle language will be displayed.

## ON SCREEN LANGUAGE

You can select the on-screen display language of the unit.

Each time you press CURSOR ►, the language setting changes as follows:

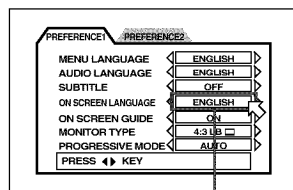

Selected language



English	ON SCREEN LANGUAGE ◀ ENGLISH ▶
French	LANGUE D'ECRAN ◀ FRANCAIS ▶
Spanish	IDIOMA EN PANTALLA ◀ ESPAÑOL ▶

Pressing CURSOR ◀ changes the language setting in the reverse order of the above.

## ON SCREEN GUIDE

The unit can display "on-screen guide" icons or characters, which show what is happening to the disc or the unit.

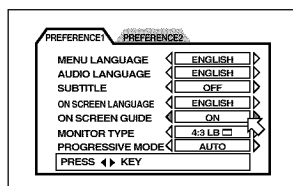

Examples of "on-screen guide" icons or characters:



- **ON**  
The on-screen guide will be displayed.
- **OFF**  
The on-screen guide will not be displayed.

## MONITOR TYPE

You can select the monitor type to match your TV when you playback DVD VIDEO discs recorded for wide screen televisions.

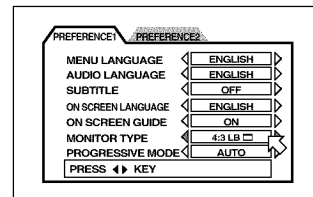

- **4:3 LB.  (Letter Box Conversion)**

Should be selected when you connect a normal TV to the unit.

When you play a wide picture recorded on a DVD VIDEO disc, the picture is displayed with bands across the upper and lower portions of the screen.

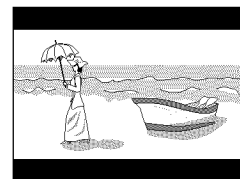

- **4:3 PS.  (Pan Scan Conversion)**

Should be selected when you connect a normal TV to the unit.

When you play a wide picture recorded on a DVD VIDEO disc, a portion of the picture is automatically cut off from the left and right sides of the image.

Depending on the disc, it may not be possible to playback in this mode. In that case, the picture is played back as in 4:3 LB.  mode.

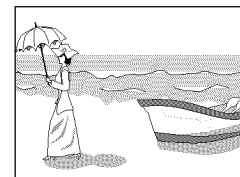

- **16:9 AUTO (Wide Television screen)**

Should be selected when you connect a wide-screen TV to the unit.

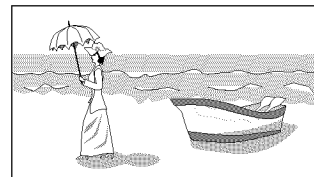

- **16:9 NORMAL (Wide Television screen)**

Should be selected when you connect the unit to a wide-screen TV whose aspect ratio is fixed to 16:9 (the unit automatically adjusts the screen width of the output signal correctly when playing back a "4:3" source).

## NOTES

- If a disc does not support "4:3 Pan Scan", the letter box screen appears even if you set the MONITOR TYPE to "4:3 PS. ".
- If you playback a "4:3" DVD VIDEO source with the "16:9 NORMAL" mode, the picture character slightly changes due to the process for converting the picture width.

## PROGRESSIVE MODE

You can select the progressive mode from the following options.

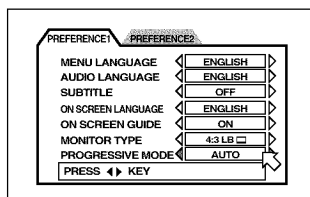

- **AUTO**

The unit recognizes the picture type (film or video source) of the current disc according to the disc information.

- **VIDEO 1**

Suitable for playing back a video source disc with static (inactive) pictures.

- **VIDEO 2**

Suitable for playing back a video source disc with dynamic (active) pictures.

- **FILM**

Suitable for playing back a film or progressive source disc.

- **SMART**

Used to playback a disc containing both video and film source materials.

\* Normally, set the PROGRESSIVE MODE to "AUTO".

\* Some DVD VIDEO discs may not be played back correctly with the "AUTO" mode. If the playback picture is unclear or noisy with a particular DVD VIDEO disc, try to change the mode.

### NOTE

- When playing back a film-source DVD VIDEO disc with the "PROGRESSIVE MODE" set to "FILM", "SMART" or "AUTO" and the progressive scan mode is active, the PROGRESSIVE indicator on the front panel lights in green. (See page 17.)

## Audio and system preference

The "PREFERENCE 2" display handles preferences related to audio and system.

### DIGITAL AUDIO OUTPUT

To connect the unit's digital output to an external device equipped with a digital input, this item must be set correctly.

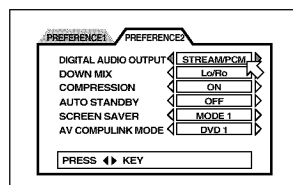

- **PCM ONLY**

Should be selected when you connect the DIGITAL OUT jack of the unit to the linear PCM digital input of other audio equipment.

- **STREAM/PCM**

Should be selected when you connect with the digital input of an amplifier with a built-in DTS, Dolby Digital, or MPEG multichannel decoder.

- **DOLBY DIGITAL/PCM**

Should be selected when you connect to the digital input of a Dolby Digital decoder, or an amplifier with a built-in Dolby Digital decoder.

The following chart shows the relationship between types of playback discs and output signals.

Playback discs	Output		
	STREAM/PCM	DOLBY DIGITAL/PCM	PCM ONLY
DVD with 48/44.1 kHz, 16 bit linear PCM	48/44.1 kHz, 16 bit, stereo linear PCM	←	←
DVD with 48/44.1 kHz, 20/24 bit linear PCM	48/44.1 kHz, 16 bit, stereo linear PCM*	←	←
DVD with 96/88.2 kHz, linear PCM	No output	←	←
DVD with DTS	DTS bitstream	48 kHz, 16 bit, stereo linear PCM*	←
DVD with Dolby Digital	Dolby Digital bitstream	←	48 kHz, 16 bit, stereo linear PCM*
Video CD	44.1 kHz, 16 bit, stereo linear PCM	←	←
Audio CD	44.1 kHz, 16 bit, stereo linear PCM	←	←
Audio CD with DTS	DTS bitstream	44.1 kHz, 16 bit, stereo linear PCM	←
CD -R with MP3	No output	←	←

\* With some DVD VIDEO discs that are not fully copy-protected, a 20 or 24 bit digital signal may be output.

### NOTES

- The unit does not provide the DTS decoding function.
- When playing a DVD VIDEO or Audio CD disc with DTS, use a DTS decoder to get correct signals from your speakers.

## DOWN MIX

To playback a DVD VIDEO disc recorded with surround multichannel audio correctly, the DOWN MIX setting must be properly made according to your audio system.

Note that this setting affects only the output signal from the ANALOG AUDIO output jacks when playing back a DVD VIDEO disc recorded with surround multichannel audio.

- **Lt/Rt**

Should be selected when you enjoy multichannel surround audio by connecting the unit's ANALOG AUDIO output to a surround decoder.

- **Lo/Ro**

Should be selected when you enjoy conventional 2-channel stereo audio by connecting the unit's AUDIO output to a stereo amplifier/receiver or television set, or when you duplicate audio of a DVD VIDEO disc recorded with surround audio to your MD, cassette, etc.

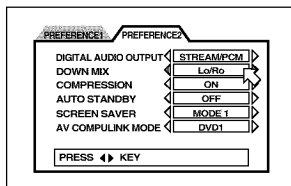

### NOTE

- The Down mix function does not work when the 3D PHONIC function is activated.

## COMPRESSION

The compression function suppresses the dynamic range of 2-channel audio output signals. This function is always active when playing back a 5.1-channel source.

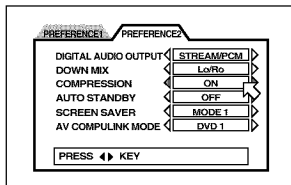

- **ON**

The compression function is always active regardless of sources.

- **OFF**

The compression function is inactive when playing back a one- or two-channel source.

## AUTO STANDBY

When the unit is stopped for more than 30 minutes or 60 minutes, the unit enters standby mode automatically.

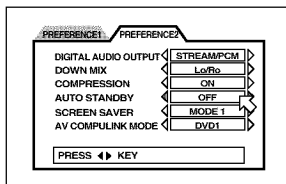

- **60**

Time is set to 60 minutes.

- **30**

Time is set to 30 minutes.

- **OFF**

The auto standby function is off.

## SCREEN SAVER

A television monitor screen may be burned out if a static picture is displayed for a long time. To prevent this, the unit automatically activates the screen saver function if a static picture, such as an on-screen display or menu, is displayed for over 5 minutes.

- **MODE 1**

The current picture gets dark.

- **MODE 2**

The "screen saver" picture appears and its brightness changes.

- **OFF**

The screen saver function is off.

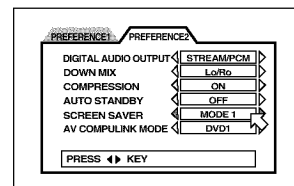

### NOTE

- The monitor screen of a projector or projection TV is easily burned out if the screen saver mode is set to OFF and a static picture is displayed for a long time.
- When a static picture is displayed for a long time during playback, the screen saver function is always activated in "MODE 1" regardless of whether you select "MODE 1" or "MODE 2".

## AV COMPULINK MODE

If you use the AV COMPULINK system, you must set this item correctly.

Select from the three options: "DVD1", "DVD2" and "DVD3" according to the equipment to be connected.

See page 56.

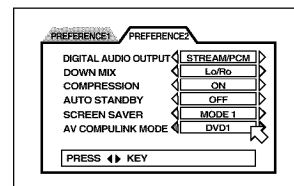

## Limiting playback by children

This function restricts playback of DVD VIDEO discs which contain violent (and other) scenes according to the level set by the user. For example, if a movie which includes violent scenes supports the parental lock feature, such scenes which you do not want to let children view can be cut or replaced with other scenes.

### To set Parental Lock for the first time [PARENTAL LOCK]

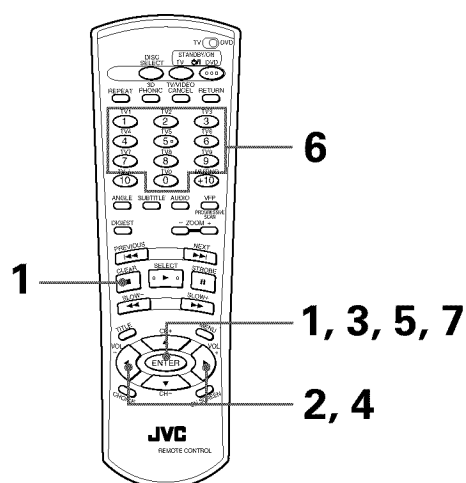

- While a DVD VIDEO disc is stopped or no disc is inserted

#### 1 Press ENTER while holding down ■ on the remote control unit.

The Parental Lock on-screen display appears on the TV screen.

↔ points [Country Code].

#### 2 While ↔ points [Country Code], use CURSOR ◀/▶ to select the "US" for country code.

The country code whose standards were applied to rate the DVD VIDEO disc should be selected.

See "Appendix B: Country code list for Parental Locks".

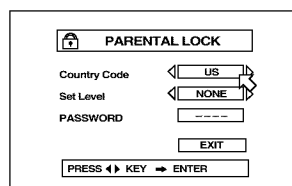

#### 3 Press ENTER.

↔ moves to [Set Level].

#### 4 While ↔ points [Set Level], use CURSOR ◀/▶ to select the Parental Lock level.

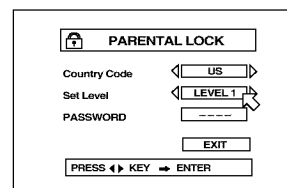

Each time you press CURSOR ◀/▶, the Parental level changes as follows:



- "LEVEL1" is the strictest level. "NONE" means no restriction. Discs rated higher than the selected level are restricted.

#### 5 Press ENTER.

↔ moves to [PASSWORD].

#### 6 Enter your 4-digit password using the numeric buttons (0 to 9).

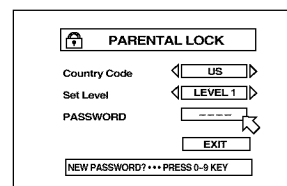

#### 7 Press ENTER.

The Parental level and password are set.

↔ moves to [EXIT].

Pressing ENTER again returns to the opening display.



- If you enter an undesired password in step 6 above, reenter the password before pressing ENTER.

## To change the settings [PARENTAL LOCK]



You can change the Parental Lock settings later.

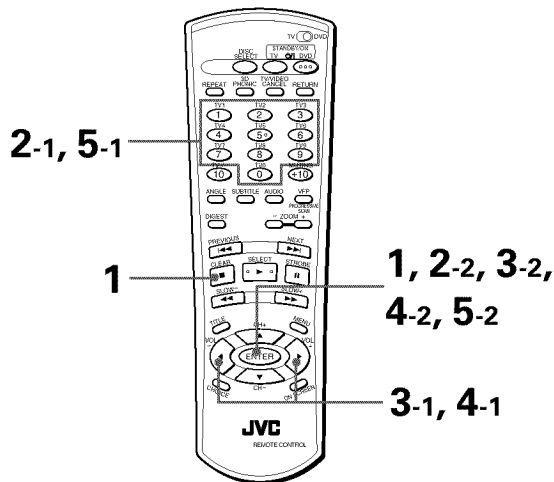

- While a DVD VIDEO disc is stopped or no disc is inserted

### 1 Press ENTER while holding down **■** on the remote control unit.

The Parental Lock on-screen display appears on the TV screen.

points [PASSWORD].

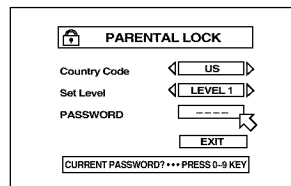

### 2 Enter your current 4-digit password using the numeric buttons (0 to 9) and press ENTER.

moves to [Country Code] if you enter the correct password.

If you enter the wrong password, "WRONG! RETRY..." appears on the TV screen, and you cannot go to the next step.

### 3 To change the country code, use CURSOR /▶ to select the desired country code and press ENTER.

moves to [Set Level].

When you change the country code, you must select the parental level.

### 4 To change the set level, use CURSOR /▶ to select the desired level while points [Set Level], and then press ENTER.

moves to [PASSWORD].

### 5 Enter the password using the numeric buttons (0 to 9) and press ENTER.

moves to [EXIT].

The password entered in the above step becomes the new password. If you do not change the password, enter the same password as in the step 2. Even if you want to change only the country code and/or parental level, do not forget to enter the password after changing the country code and/or parental level. Otherwise, the new country code and/or parental level will not become effective. Pressing ENTER again returns to the opening display.

#### NOTES

- When you enter the wrong password more than 3 times in step 2 above, moves to [EXIT] automatically and CURSOR /▼ does not work.
- If you forget your password in step 2 Enter "8888."



## To temporarily release the Parental Lock [PARENTAL LOCK]



When you set the Parental level strictly, some discs may not be played back at all. When you insert such a disc and try to play it, the following Parental Lock on-screen display appears on the TV screen, asking you whether you want the Parental Lock to be temporarily released or not.

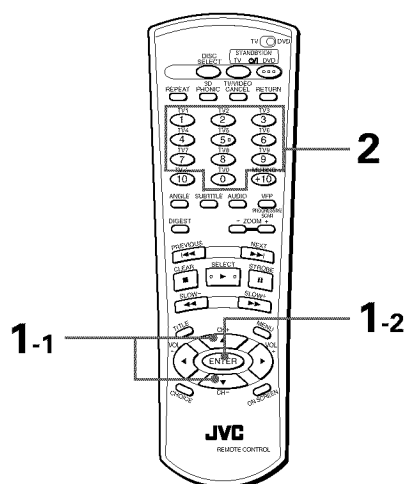

- 1** Use the CURSOR ▲/▼ to move  to [YES], then press ENTER.

 moves to the [PASSWORD].

When selecting [NO], press ▲ (OPEN/CLOSE) button on the front panel to remove the disc.

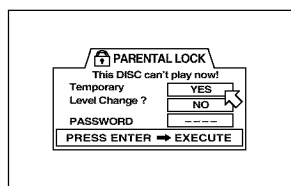

- 2** Enter your 4-digit password using the numeric buttons (0 to 9).

The Parental Lock is released, and the unit starts playback.

If you enter the wrong password, "WRONG! RETRY..." appears on the TV screen.

Enter the correct password.

### NOTE

- When you enter the wrong password more than 3 times in step 2 above,  moves to [NO] automatically and CURSOR ▲/▼ do not work.

## AV COMPU LINK remote control system

The JVC AV COMPU LINK system allows you to enjoy video or audio with the simplest operation.

If your video/audio player (such as a DVD player, CD player and VCR) and television or/and amplifier/receiver support the JVC AV COMPU LINK system and are tied with the JVC AV COMPU LINK cable(s), when you simply starting the player, all the necessary settings of the television and/or amplifier/receiver for enjoying playback are automatically performed.

**AV COMPU LINK**

### NOTE

- The cable for connecting between the AV COMPU LINK jacks is not supplied with the unit. Purchase an optional audio cable with monaural mini-plugs on both ends for AV COMPU LINK connection.

### Connection and setup

Using the AV COMPU LINK cable, connect the AV COMPU LINK terminals of each component to one another.

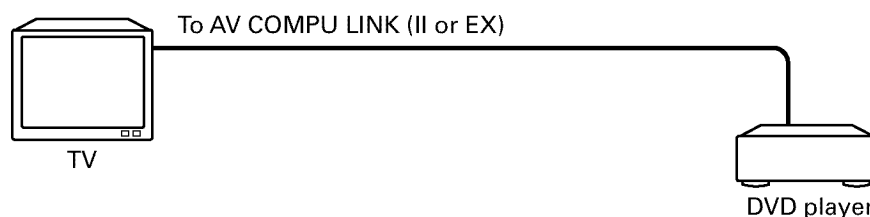

- If you connect a DVD player to a television via AV COMPU LINK, set the DVD player's AV COMPU LINK setting as follows.

- When connecting to VIDEO-1 input terminal of the television: DVD2
- When connecting to VIDEO-2 input terminal of the television: DVD3

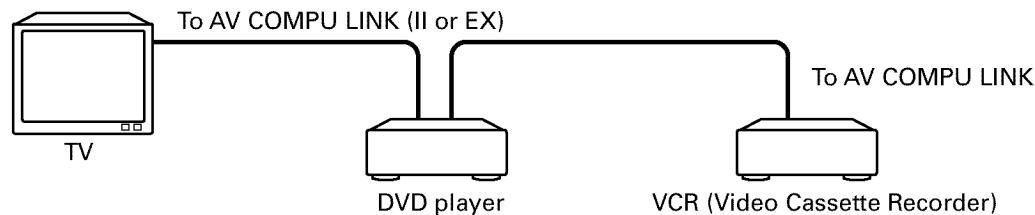

- If you connect a DVD player to a television and VCR via AV COMPU LINK, set the VCR's Remote Control Code and DVD player's AV COMPU LINK setting as follows.

- When connecting to VIDEO-1 input terminal of the television:  
DVD player's AV COMPU LINK setting: DVD2  
VCR's Remote Control Code: B
- When connecting to VIDEO-2 input terminal of the television:  
DVD player's AV COMPU LINK setting: DVD3  
VCR's Remote Control Code: A

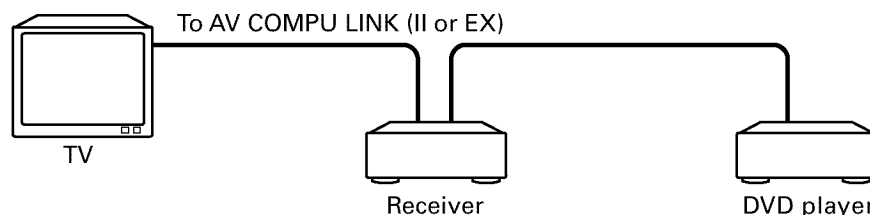

- If you connect a DVD player to a television and receiver via AV COMPU LINK, set the DVD player's AV COMPU LINK setting to DVD1.

- The DVD player's AV COMPU LINK setting is operated in the PREFERENCE 2 display. See page 52 for operation.
- For information on the connection between the TV and the Receiver, refer to the Receiver's Instructions.

**IMPORTANT!**

You connect the component video output to your TV:

- Set the DVD player's AV COMPU LINK setting to DVD1.
- Make the video/audio connection between the DVD player and your receiver using the supplied audio/video cable, and do not make the S-VIDEO connection.

**Notes for connection**

- If you connect a DVD player to a receiver via AV COMPU LINK in a system including a Dolby digital decoder, some functions may not be performed automatically.
- The AV COMPU LINK terminal on some televisions indicates "II." Do not connect the terminal indicating "II" with the AV COMPU LINK terminal on a receiver. If connected, the system will not work correctly.
- Connect the AUDIO OUT jacks of the DVD player to the audio input jacks of a receiver that indicating "DVD." Otherwise, the system will not work correctly.
- There may be no description about connections to a DVD player in the instruction manual of a television or VCR. However a television or VCR with AV COMPU LINK terminals indicating "II" or "EX" can be connected to a DVD player.

**Operation**

You can enjoy pictures and/or sound by just putting a source component (which plays back the pictures and/or sound such as a DVD player or VCR) into play mode. You do not have to operate the TV and receiver including not having to perform power switching.

- 1** Turn on the main power of the television.
- 2** Insert a disc (or tape) into the source component.
- 3** Press ► of the source component.

The following actions are performed automatically:

- Turning on the power for the television.
- Setting the source of the television to the external input (VIDEO-1 or VIDEO-2).
- Turning on the power for the receiver.
- Setting the source of the receiver to the component which has started playback.

## Care and handling of discs

### How to handle discs

When handling a disc, do not touch the surface of the disc. Since discs are made of plastic, they are easily damaged. If a disc gets dirty, dusty, scratched or warped, the images and sound will not be picked up correctly, and such a disc may cause the player to malfunction.

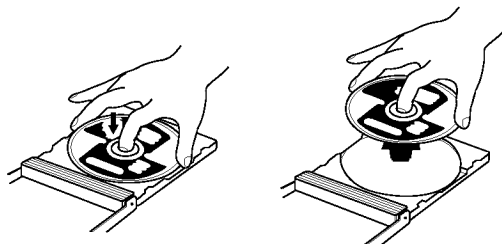

### Label side

Do not damage the label side, stick paper to or use any adhesive on its surface.

### Storage

Make sure that discs are kept in their cases. If discs are piled on top of one another without their protective cases, they can be damaged. Do not put discs in a location where they may be exposed to direct sunlight, or in a place where the humidity or temperature is high. Avoid leaving discs in your car!

### Maintenance of discs

If there are fingerprints or other dirt adhering to a disc, wipe with a soft dry cloth, moving from the center outwards. If a disc is difficult to clean, wipe with a cloth moistened with water. Never use record cleaners, petrol, alcohol or any anti-static agents.

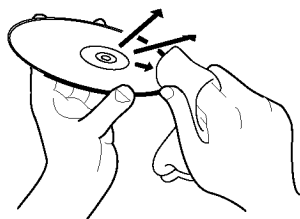

### CAUTION

Sometimes during play noise or images may be garbled. This is sometimes due to the disc. (It may not be up to industry standards.)

These symptoms are caused by the discs, not by the malfunction of the unit.

# Troubleshooting

What appears to be a malfunction may not always be serious. Please go through the following list before requesting service.

Symptom	Possible case	Remedy
Power does not come on.	Power plug is not inserted securely.	Plug in securely.
Remote control does not work.	Too far from the unit.	Move closer to the unit.
	The tip of the remote unit is not pointed in the right direction.	Point the infrared light-emitting window toward the remote sensor on the front panel.
	Batteries are exhausted.	Replace the batteries with new ones.
	Battery polarity is incorrect.	Take out the batteries and insert them again in the correct direction.
The TV/VIDEO - CANCEL, CURSOR or numeric buttons do not work.	The TV - DVD switch is not correctly set.	To control the unit, set the TV - DVD switch to "DVD". To control your TV, set the TV - DVD switch to "TV".
No picture is displayed on the monitor.	Connection of video cable is incorrect.	Connect the cable correctly.
	Input selection of TV is incorrect.	Select correctly.
	Disc is not playable.	Use a playable disc. (See page 15.)
	The Progressive scan mode is set to ON though the unit is connected to a TV via the VIDEO OUT jack.	Set the Progressive scan mode to OFF. (See page 17.)
Picture is noisy or blurred.	The unit is connected to a VCR directly and the copyguard function is activated.	Connect the unit so that the picture signal flows directly to the TV.
	With some discs, a picture may be blurred when setting the "PROGRESSIVE MODE" to "FILM" or "AUTO".	Set the "PROGRESSIVE MODE" to "VIDEO".
No audio is reproduced.	Connection is incorrect.	Check the connections.
	Input selection of amplifier is incorrect.	Select correctly.
No audio is reproduced when playing back a DVD disc recorded with 88.2 kHz or more, linear PCM audio using the DIGITAL OUT jack.	The audio signal is not derived from the unit's DIGITAL OUT.	Use the AUDIO OUT when playing back such discs.
Sound is distorted or noise is generated.	Disc is dirty.	Wipe the disc surface.
Picture does not fit the television screen.	MONITOR TYPE is not correctly set.	Select monitor type correctly. (See page 50.)
	Television is not correctly set.	Set the television correctly.
Operation is not possible.	Microcomputer malfunction due to lightning or static electricity.	Turn off the power and unplug the power cord, then connect the power cord again.
	Moisture condensation caused by a sudden change of temperature or humidity.	Turn off the power, then turn it on a few hours later.
The carousel does not move.	The system malfunctions. An alien substance is jammed on the carousel.	Press the STOP button or turn off the power.

# Specifications

## General

Readable discs: DVD VIDEO, Audio CD, Video CD  
 Video format: NTSC, 525i/525p selectable

## Other

Power requirements: AC 120 V  $\sim$ , 60 Hz  
 Power consumption: 18 W (POWER ON), 2.7 W (STANDBY mode)  
 Mass: 5.6 kg (12.4 lbs)  
 Dimensions (W x H x D): 435 mm x 102 mm x 448 mm  
 (17-3/16 inch x 4-1/16 inch x 17-11/16 inch)

## Video outputs

COMPONENT (pin jacks): Y Output: 1.0 V<sub>p-p</sub> (75  $\Omega$ )  
 Pb/P<sub>R</sub> Output: 0.7 V<sub>p-p</sub> (75  $\Omega$ )  
 VIDEO OUT (pin jack): 1.0 V<sub>p-p</sub> (75  $\Omega$ )  
 S-VIDEO OUT (S jack): Y Output: 1.0 V<sub>p-p</sub> (75  $\Omega$ )  
 C Output: 286 mV<sub>p-p</sub> (75  $\Omega$ )  
 Horizontal resolution: 500 Lines or more

## Audio outputs

ANALOG OUT (pin jack): 2.0 V<sub>rms</sub> (10 k $\Omega$ )  
 DIGITAL OUT: (COAXIAL): 0.5 V<sub>p-p</sub> (75  $\Omega$  termination)  
 (OPTICAL): -21 dBm to -15 dBm (Peak)

## Audio characteristics

Frequency response: CD (sampling frequency 44.1 kHz): 2 Hz to 20 kHz  
 DVD (sampling frequency 48 kHz): 2 Hz to 22 kHz  
 (2 Hz to 20 kHz for DTS and Dolby Digital bitstream signals)  
 DVD (sampling frequency 96 kHz): 2 Hz to 44 kHz  
 Dynamic range: 16 bit: More than 98 dB  
 20 bit: More than 106 dB  
 24 bit: More than 106 dB  
 Wow and flutter: Unmeasurable (less than  $\pm 0.002\%$ )  
 Total harmonic distortion: less than 0.002%

\* Specifications and appearance subject to change without prior notice.

## Appendix A: Table of languages and their abbreviations

When you select the subtitle language or sound, the languages shown below are displayed as abbreviations. To select the desired language, select the abbreviation corresponding the language you want to.

AA	Afar
AB	Abkhazian
AF	Afrikaans
AM	Ameharic
AR	Arabic
AS	Assamese
AY	Aymara
AZ	Azerbaijani
BA	Bashkir
BE	Byelorussian
BG	Bulgarian
BH	Bihari
BI	Bislama
BN	Bengali, Bangla
BO	Tibetan
BR	Breton
CA	Catalan
CO	Corsican
CS	Czech
CY	Welsh
DA	Danish
DZ	Bhutani
EL	Greek
EO	Esperanto
ET	Estonian
EU	Basque
FA	Persian
FI	Finnish
FJ	Fiji
FO	Faroese
FY	Frisian
GA	Irish
GD	Scots Gaelic
GL	Galician
GN	Guarani
GU	Gujarati
HA	Hausa
HI	Hindi
HR	Croatian
HU	Hungarian
HY	Armenian
IA	Interlingua
IE	Interlingue

IK	Inupiak
IN	Indonesian
IS	Icelandic
IW	Hebrew
JI	Yiddish
JW	Javanese
KA	Georgian
KK	Kazakh
KL	Greenlandic
KM	Cambodian
KN	Kannada
KO	Korean (KOR)
KS	Kashmiri
KU	Kurdish
KY	Kirghiz
LA	Latin
LN	Lingala
LO	Laothian
LT	Lithuanian
LV	Latvian, Lettish
MG	Malagasy
MI	Maori
MK	Macedonian
ML	Malayalam
MN	Mongolian
MO	Moldavian
MR	Marathi
MS	Malay (MAY)
MT	Maltese
MY	Burmese
NA	Nauru
NE	Nepali
NL	Dutch
NO	Norwegian
OC	Occitan
OM	(Afan) Oromo
OR	Oriya
PA	Panjabi
PL	Polish
PS	Pashto, Pushto
PT	Portuguese
QU	Quechua
RM	Rhaeto-Romance

RN	Kirundi
RO	Rumanian
RU	Russian
RW	Kinyarwanda
SA	Sanskrit
SD	Sindhi
SG	Sangho
SH	Serbo-Croatian
SI	Singhalese
SK	Slovak
SL	Slovenian
SM	Samoan
SN	Shona
SO	Somali
SQ	Albanian
SR	Serbian
SS	Siswati
ST	Sesotho
SU	Sundanese
SV	Swedish
SW	Swahili
TA	Tamil
TE	Telugu
TG	Tajik
TH	Thai
TI	Tigrinya
TK	Turkmen
TL	Tagalog
TN	Setswana
TO	Tonga
TR	Turkish
TS	Tsonga
TT	Tatar
TW	Twi
UK	Ukrainian
UR	Urdu
UZ	Uzbek
VI	Vietnamese
VO	Volapuk
WO	Wolof
XH	Xhosa
YO	Yoruba
ZU	Zulu

## Appendix B:Country code list for Parental Locks

This list is used for the Parental Lock operation. For details, see page 53.

AD	Andorra
AE	United Arab Emirates
AF	Afghanistan
AG	Antigua and Barbuda
AI	Anguilla
AL	Albania
AM	Armenia
AN	Netherlands Antilles
AO	Angola
AQ	Antarctica
AR	Argentina
AS	American Samoa
AT	Austria
AU	Australia
AW	Aruba
AZ	Azerbaijan
BA	Bosnia and
BB	Barbados
BD	Bangladesh
BE	Belgium
BF	Burkina Faso
BG	Bulgaria
BH	Bahrain
BI	Burundi
BJ	Benin
BM	Bermuda
BN	Brunei Darussalam
BO	Bolivia
BR	Brazil
BS	Bahamas
BT	Bhutan
BV	Bouvet Island
BW	Botswana
BY	Belarus
BZ	Belize
CA	Canada
CC	Cocos (Keeling) Islands
CF	Central African Republic
CG	Congo
CH	Switzerland
CI	Côte d'Ivoire
CK	Cook Islands
CL	Chile
CM	Cameroon
CN	China
CO	Colombia
CR	Costa Rica
CU	Cuba
CV	Cape Verde
CX	Christmas Island
CY	Cyprus
CZ	Czech Republic
DE	Germany
DJ	Djibouti
DK	Denmark
DM	Dominica
DO	Dominican Republic
DZ	Algeria
EC	Ecuador
EE	Estonia
EG	Egypt
EH	Western Sahara
ER	Eritrea
ES	Spain
ET	Ethiopia
FI	Finland
FJ	Fiji
FK	Falkland Islands
FM	Micronesia (Federated States of)
FO	Faroe Islands
FR	France
FX	France, Metropolitan
GA	Gabon
GB	United Kingdom
GD	Grenada
GE	Georgia
GF	French Guiana
GH	Ghana
GI	Gibraltar
GL	Greenland
GM	Gambia
GN	Guinea
GP	Guadeloupe
GQ	Equatorial Guinea
GR	Greece
GS	South Georgia and the South Sandwich
GT	Guatemala
GU	Guam
GW	Guinea-Bissau
GY	Guyana
HK	Hong Kong
HM	Heard Island and McDonald Islands
HN	Honduras
HR	Croatia
HT	Haiti
HU	Hungary
ID	Indonesia
IE	Ireland
IL	Israel
IN	India
IO	British Indian Ocean Territory
IQ	Iraq
IR	Iran (Islamic Republic of)
IS	Iceland
IT	Italy
JM	Jamaica
JO	Jordan
JP	Japan
KE	Kenya
KG	Kyrgyzstan
KH	Cambodia
KI	Kiribati
KM	Comoros
KN	Saint Kitts and Nevis
KP	Korea, Democratic People's Republic of
KR	Korea, Republic of
KW	Kuwait
KY	Cayman Islands
KZ	Kazakhstan
LA	Lao People's Democratic Republic
LB	Lebanon
LC	Saint Lucia
LI	Liechtenstein
LK	Sri Lanka
LR	Liberia
LS	Lesotho
LT	Lithuania
LU	Luxembourg
LV	Latvia
LY	Libyan Arab
MA	Morocco
MC	Monaco
MD	Moldova, Republic of
MG	Madagascar
MH	Marshall Islands
ML	Mali
MM	Myanmar
MN	Mongolia
MO	Macau
MP	Northern Mariana Islands
MQ	Martinique
MR	Mauritania
MS	Montserrat
MT	Malta
MU	Mauritius
MV	Maldives
MW	Malawi
MX	Mexico
MY	Malaysia
MZ	Mozambique
NA	Namibia
NC	New Caledonia
NE	Niger
NF	Norfolk Island
NG	Nigeria
NI	Nicaragua
NL	Netherlands
NO	Norway
NP	Nepal
NR	Nauru
NU	Niue
NZ	New Zealand
OM	Oman
PA	Panama
PE	Peru
PF	French Polynesia
PG	Papua New Guinea
PH	Philippines
PK	Pakistan
PL	Poland
PM	Saint Pierre and Miquelon
PN	Pitcairn
PR	Puerto Rico
PT	Portugal
PW	Palau
PY	Paraguay
QA	Qatar
RE	Réunion
RO	Romania
RU	Russian Federation
RW	Rwanda
SA	Saudi Arabia
SB	Solomon Islands
SC	Seychelles
SD	Sudan
SE	Sweden
SG	Singapore
SH	Saint Helena
SI	Slovenia
SJ	Svalbard and Jan Mayen
SK	Slovakia
SL	Sierra Leone
SM	San Marino
SN	Senegal
SO	Somalia
SR	Suriname
ST	Sao Tome and Principe
SV	El Salvador
SY	Syrian Arab Republic
SZ	Swaziland
TC	Turks and Caicos Islands
TD	Chad
TF	French Southern Territories
TG	Togo
TH	Thailand
TJ	Tajikistan
TK	Tokelau
TM	Turkmenistan
TN	Tunisia
TO	Tonga
TP	East Timor
TR	Turkey
TT	Trinidad and Tobago
TV	Tuvalu
TW	Taiwan
TZ	Tanzania, United Republic of
UA	Ukraine
UG	Uganda
UM	United States Minor Outlying Islands
US	United States
UY	Uruguay
UZ	Uzbekistan
VA	Vatican City State (Holy See)
VC	Saint Vincent and the Grenadines
VE	Venezuela
VG	Virgin Islands (British)
VI	Virgin Islands (U.S.)
VN	Vietnam
VU	Vanuatu
WF	Wallis and Futuna Islands
WS	Samoa
YE	Yemen
YT	Mayotte
YU	Yugoslavia
ZA	South Africa
ZM	Zambia
ZR	Zaire
ZW	Zimbabwe



# Authorized Service Centers

---

QUALITY **JVC**<sup>®</sup> SERVICE  
*HOW TO LOCATE YOUR JVC SERVICE CENTER*  
**TOLL FREE: 1 (800) 537-5722**  
**<http://www.jvc.com>**

Dear Customer,

In order to receive the most satisfaction from your purchase, please read the instruction booklet before operating the unit. In the event that repairs are necessary, please call 1 (800)537-5722 for your nearest authorized servicer or visit our website at **[www.JVC.com](http://www.JVC.com)**

Remember to retain your Bill of Sale for Warranty Service.

---

## **Do not service the television yourself**

---

### **Caution**

To prevent electrical shock, do not open the cabinet. There are no user serviceable parts inside. Please refer to qualified service personnel for repairs.

### **Accessories**

To purchase accessories for your JVC product, please call toll free: 1 (800)882-2345 or on the web at **[www.JVC.com](http://www.JVC.com)**

---



# LIMITED WARRANTY

## CONSUMER VIDEO 1-90

JVC COMPANY OF AMERICA warrants this product and all parts thereof, except as set forth below ONLY TO THE ORIGINAL PURCHASER AT RETAIL to be FREE FROM DEFECTIVE MATERIALS AND WORKMANSHIP from the date of original retail purchase for the period as shown below. ("The Warranty Period")

PARTS	<b>1 YR</b>	LABOR	<b>90 DAYS</b>
-------	-------------	-------	----------------

THIS LIMITED WARRANTY IS VALID ONLY IN THE FIFTY (50) UNITED STATES, THE DISTRICT OF COLUMBIA AND IN COMMONWEALTH OF PUERTO RICO.

**WHAT WE WILL DO:**

If this product is found to be defective, JVC will repair or replace defective parts at no charge to the original owner. Such repair and replacement services shall be rendered by JVC during normal business hours at JVC authorized service centers. Parts used for replacement are warranted only for the remainder of the Warranty Period. All products and parts thereof may be brought to a JVC authorized service center on a carry-in basis except for Television sets having a screen size 25 inches and above which are covered on an in-home basis.

**WHAT YOU MUST DO FOR WARRANTY SERVICE:**

Return your product to a JVC authorized service center with a copy of your bill of sale. For your nearest JVC authorized service center, please call toll free: (800) 537-5722.

If service is not available locally, box the product carefully, preferably in the original carton, and ship, insured, with a copy of your bill of sale plus a letter of explanation of the problem to the nearest JVC Factory Service Center, the name and location of which will be given to you by the toll-free number.

If you have any questions concerning your JVC Product, please contact our Customer Relations Department.

**WHAT IS NOT COVERED:**

This limited warranty provided by JVC does not cover:

1. Products which have been subject to abuse, accident, alteration, modification, tampering, negligence, misuse, faulty installation, lack of reasonable care, or if repaired or serviced by anyone other than a service facility authorized by JVC to render such service, or if affixed to any attachment not provided with the products, or if the model number or serial number has been altered, tampered with, defaced or removed;
2. Initial installation and installation and removal for repair;
3. Operational adjustments covered in the Owner's Manual, normal maintenance, video and audio head cleaning;
4. Damage that occurs in shipment, due to act of God, and cosmetic damage;
5. Signal reception problems and failures due to line power surge;
6. Video Pick-up Tubes/CCD Image Sensor, Cartridge, Stylus (Needle) are covered for 90 days from the date of purchase;
7. Accessories;
8. Batteries (except that Rechargeable Batteries are covered for 90 days from the date of purchase);

There are no express warranties except as listed above.

THE DURATION OF ANY IMPLIED WARRANTIES, INCLUDING THE IMPLIED WARRANTY OF MERCHANTABILITY, IS LIMITED TO THE DURATION OF THE EXPRESS WARRANTY HEREIN.

JVC SHALL NOT BE LIABLE FOR THE LOSS OF USE OF THE PRODUCT, INCONVENIENCE, LOSS OR ANY OTHER DAMAGES, WHETHER DIRECT, INCIDENTAL OR CONSEQUENTIAL (INCLUDING, WITHOUT LIMITATION, DAMAGE TO TAPES, RECORDS OR DISCS) RESULTING FROM THE USE OF THIS PRODUCT, OR ARISING OUT OF ANY BREACH OF THIS WARRANTY. ALL EXPRESS AND IMPLIED WARRANTIES, INCLUDING THE WARRANTIES OF MERCHANTABILITY AND FITNESS FOR PARTICULAR PURPOSE, ARE LIMITED TO THE WARRANTY PERIOD SET FORTH ABOVE.

Some states do not allow the exclusion of incidental or consequential damages or limitations on how long an implied warranty lasts, so these limitations or exclusions may not apply to you. This warranty gives you specific legal rights and you may also have other rights which vary from state to state.

JVC COMPANY OF AMERICA  
DIVISION OF JVC AMERICAS CORP.

1700 Valley Road  
Wayne, NJ 07470

REFURBISHED PRODUCTS CARRY A SEPARATE WARRANTY, THIS WARRANTY DOES NOT APPLY. FOR DETAILS OF REFURBISHED PRODUCT WARRANTY, PLEASE REFER TO THE REFURBISHED PRODUCT WARRANTY INFORMATION PACKAGED WITH EACH REFURBISHED PRODUCT.

**For customer use:**

Enter below the Model No. which is located either on the rear, bottom or side of the cabinet. Retain this information for future reference.

Model No. : \_\_\_\_\_

Serial No. : \_\_\_\_\_

Purchase data : \_\_\_\_\_

Name of dealer : \_\_\_\_\_

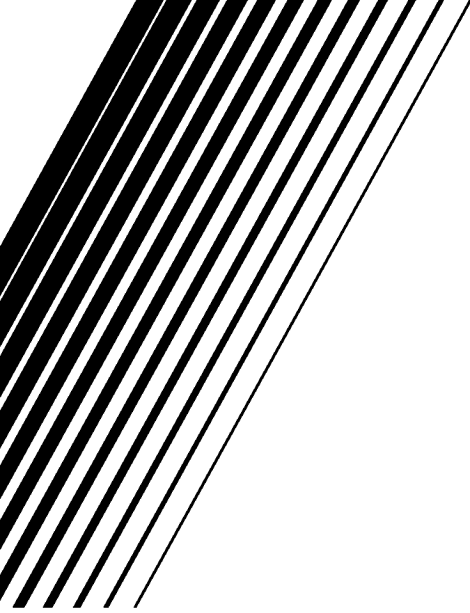

**JVC**  
VICTOR COMPANY OF JAPAN, LIMITED