OWNER'S GUIDE

Ceramic Glass Cooktop
Radiant Surface Elements
Electronic Oven Control - ES III
Self Cleaning Oven Feature

READ AND SAVE THESE INSTRUCTIONS

Contents

Product Registration	2
Versión en español	2
IMPORTANT SAFETY INSTRUCTIONS	3-4
Setting Surface Controls	5-6
Setting Warm Zone Controls (if equipped)	7
Setting Warmer Drawer Controls (if equipped)	8
Before Setting Oven Controls	9
Control Pad Functions	10
Setting the Clock and Minute Timer	11
Setting Oven Controls	12-15
Self-Cleaning	16-17
General Cleaning	18-20
Customizing Your Oven Performance	21
Changing Cooktop and/or Oven Lights	21
Avoid Service Checklist	22-23
Warranty	24

ELECTRIC RANGE

This Owner's Guide contains general operating instructions for your range and feature information for several models. Your range **will not** have all the described features.

Product Registration

Register Your Product

The self-addressed **PRODUCT REGISTRATION CARD** should be filled in completely, signed and returned to Frigidaire Home Products.

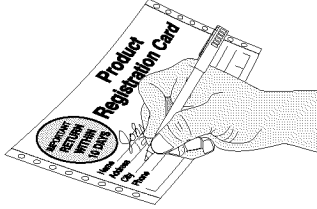

Versión en español

Si desea obtener una copia en español de este Manual del Usuario, sírvase escribir a la dirección que se incluye a continuación. Solicite la P/N 316080290E.

Spanish Owner's Guides
Frigidaire Home Products
P. O. Box 360797
Strongsville, OH 44136

Thank you for choosing this appliance. The information contained within this Owner's Guide will instruct you on how to properly operate and care for your range. Please read through the information contained in your literature pack to learn more about your new appliance.

Record Your Model and Serial Numbers

Record in the space provided below the model and serial numbers. The serial number is found on the right side of the oven front frame for models equipped with a ceramic-glass cook top.

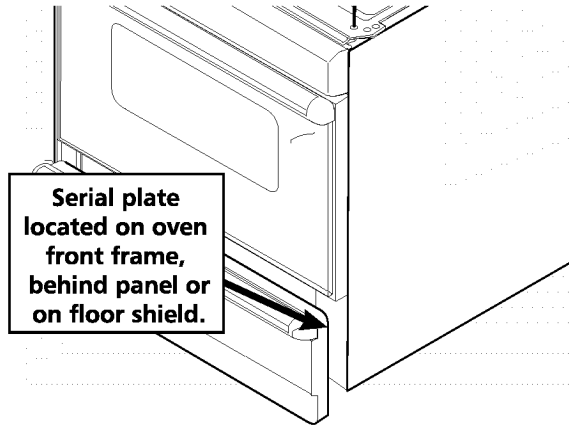

Model Number: _____

Serial Number: _____

Date of Purchase: _____

This Owner's Guide contains general operating instructions for your range and feature information for several models. Your range **may not** have all the described features. The graphics shown are representational. The graphics on your range may not look exactly like those shown.

Note: The instructions appearing in this Owner's Guide are not meant to cover every possible condition and situation that may occur. Common sense and caution must be practiced when installing, operating and maintaining any appliance.

IMPORTANT SAFETY INSTRUCTIONS

Read all instructions before using this appliance.
Save these instructions for future reference.

This guide contains important safety symbols and instructions. Please pay attention to these symbols and follow all instructions given. Here is a brief explanation of the use of these symbols.

⚠ WARNING This symbol will help alert you to situations that may cause serious bodily harm, death or property damage.

⚠ CAUTION This symbol will help alert you to situations that may cause bodily injury or property damage.

- **Remove all tape and packaging before using the range.** Destroy the carton and plastic bags after unpacking the range. Never allow children to play with packaging material.
- **Proper Installation—Be sure your appliance is properly installed and grounded by a qualified technician in accordance with the National Electrical Code ANSI/NFPA No. 70 latest edition and local electrical code requirements.** Install only per installation instructions provided in the literature package for this range. Ask your dealer to recommend a qualified technician and an authorized repair service. Know how to disconnect the power to the range at the circuit breaker or fuse box in case of an emergency.
- **User servicing—Do not repair or replace any part of the appliance unless specifically recommended in the manuals.** All other servicing should be done only by a qualified technician. This may reduce the risk of personal injury and damage to the range.
- **Never modify or alter the construction of a range by removing leveling legs, panels, wire covers, anti-tip brackets/screws, or any other part of the product.**

⚠ CAUTION Do not store items of interest to children in the cabinets above a range or on the backguard of a range. Children climbing on the range to reach items could be seriously injured.

⚠ WARNING Never Use Your Appliance for Warming or Heating the Room.

- **Storage in or on Appliance—Flammable materials should not be stored in an oven, warmer drawer, near surface units or in the storage drawer.** This includes paper, plastic and cloth items, such as cookbooks, plasticware and towels, as well as flammable liquids. Do not store explosives, such as aerosol cans, on or near the range.
- **Do Not Leave Children Alone—Children should not be left alone or unattended in the area where appliance is in use.** They should never be allowed to sit or stand on any part of the appliance.
- **DO NOT TOUCH SURFACE UNITS, AREAS NEAR THESE UNITS, HEATING ELEMENTS OR INTERIOR SURFACES OF THE OVEN.** Both surface units and oven heating elements may be hot even though they are dark in color. Areas near surface units may become hot enough to cause burns. During and after use, do not touch, or let clothing or other flammable materials touch these areas until they have had sufficient time to cool. Among these areas are the cook top, surfaces facing the cook top, the oven vent openings and surfaces near these openings, oven door and window.
- **Wear Proper Apparel—Loose-fitting or hanging garments should never be worn while using the appliance.** Do not let clothing or other flammable materials contact hot surfaces.
- **Do Not Use Water or Flour on Grease Fires—Smother the fire with a pan lid, or use baking soda, a dry chemical or foam-type extinguisher.**
- **When heating fat or grease, watch it closely.** Fat or grease may catch fire if allowed to become too hot.
- **Use Only Dry Potholders—Moist or damp potholders on hot surfaces may result in burns from steam.** Do not let potholders touch hot heating elements. Do not use a towel or other bulky cloth instead of a potholder.
- **Do Not Heat Unopened Food Containers—Buildup of pressure may cause container to burst and result in injury.**
- **Remove the oven door from any unused range if it is to be stored or discarded.**

⚠ WARNING

- All ranges can tip.
- Injury to persons could result.
- Install anti-tip device packed with range.
- See Installation Instructions.



⚠ WARNING To reduce the risk of tipping, the range must be secured by properly installed anti-tip bracket provided with the range. To check if the bracket is installed properly, visually check that rear leveling leg is inserted into and fully secured by the anti-tip bracket by removing lower panel or storage drawer. For models with a warmer drawer, grasp the top rear edge of the range and carefully attempt to tilt it forward. Refer to the Installation Instructions for proper anti-tip bracket installation.



⚠ WARNING Stepping, leaning or sitting on the doors or drawers of this range can result in serious injuries and also cause damage to the range. Do not allow children to climb or play around the range. The weight of a child on an open door may cause the range to tip, resulting in serious burns or other injury.

⚠ WARNING Do not use the oven or warmer drawer (if equipped) for storage.

IMPORTANT—Do not attempt to operate the range during a power failure. If the power fails, always turn off the range. If the range is not turned off and the power resumes, the range will begin to operate again. Once the power resumes, reset the clock and oven function.

IMPORTANT SAFETY INSTRUCTIONS

IMPORTANT INSTRUCTIONS FOR USING YOUR COOK TOP

- **Know which knob controls each surface heating unit.** Place a pan of food on the unit before turning it on, and turn the unit off before removing the pan.
- **Use Proper Pan Size**—This appliance is equipped with one or more surface units of different sizes. Select utensils having flat bottoms large enough to cover the surface unit heating element. The use of undersized utensils will expose a portion of the heating element to direct contact and may result in ignition of clothing. Proper relationship of utensil to element will also improve efficiency.
- **Utensil Handles Should Be Turned Inward and Not Extend Over Adjacent Surface Units**—To reduce the risk of burns, ignition of flammable materials, and spillage due to unintentional contact with the utensil, the handle of the utensil should be positioned so that it is turned inward, and does not extend over adjacent surface units.
- **Never Leave Surface Units Unattended at High Heat Settings**—Boilovers cause smoking and greasy spillovers that may ignite, or a pan that has boiled dry may melt.
- **Do Not Immerse or Soak Removable Heating Elements**—Heating elements should never be immersed in water. Heating elements clean themselves during normal operation.
- **Glazed Cooking Utensils**—Only certain types of glass, glass/ceramic, ceramic, earthenware, or other glazed utensils are suitable for cook top service without breaking due to the sudden change in temperature. Check the manufacturer's recommendations for cook top use.
- **When flaming foods under a ventilating hood, turn the fan on.**

FOR CERAMIC-GLASS COOK TOP MODELS

- **Do Not Cook on Broken Cook Top**—If cook top should break, cleaning solutions and spillovers may penetrate the broken cook top and create a risk of electric shock. Contact a qualified technician immediately.
- **Clean Cook Top with Caution**—If a wet sponge or cloth is used to wipe spills on a hot cooking area, be careful to avoid a steam burn. Some cleaners can produce noxious fumes if applied to a hot surface.

IMPORTANT INSTRUCTIONS FOR USING YOUR OVEN

- **Use Care When Opening Oven Door or Warmer Drawer (if equipped)**—Stand to the side of the range when opening the door of a hot oven. Let hot air or steam escape before you remove or replace food in the oven.
- **Keep Oven Vent Ducts Unobstructed.** The oven vent is located under the left rear surface element if your model is equipped with coil elements. The oven vent is located below the backguard for models equipped with ceramic-glass cook tops. Touching the surfaces in this area when the oven is operating may cause severe burns. Also, do not place plastic or heat-sensitive items on or near the oven vent. These items could melt or ignite.
- **Placement of Oven Racks.** Always place oven racks in desired location while oven is cool. If rack must be moved while oven is hot use extreme caution. Use potholders and grasp the rack with both hands to reposition. Do not let potholders contact the hot heating elements in the oven. Remove all utensils from the rack before moving.
- **Do not use the broiler pan without its insert.** The broiler pan and its insert allow dripping fat to drain and be kept away from the high heat of the broiler.
- **Do not cover the broiler insert with aluminum foil. Exposed fat and grease could ignite.**
- **Protective Liners**—Do not use aluminum foil to line the oven bottom. Only use aluminum foil as recommended in this manual. Improper installation of these liners may result in risk of electric shock, or fire. Improper installation of these liners may result in risk of electric shock, or fire.

IMPORTANT INSTRUCTIONS FOR CLEANING YOUR RANGE

- **Clean the range regularly to keep all parts free of grease that could catch fire.** Pay particular attention to the area underneath each surface element. Do not allow grease to accumulate.
- **Kitchen cleaners and aerosols**—Always follow the manufacturer's recommended directions for use. Be aware that excess residue from cleaners and aerosols may ignite causing damage and injury.
- **Clean Ventilating Hoods Frequently**—Grease should not be allowed to accumulate on the hood or filter. Follow manufacturer's instructions for cleaning.

SELF CLEANING OVENS

- **Clean in the self-cleaning cycle only the parts listed in this Owner's Guide.** Before self cleaning the oven, remove the broiler pan and any utensils or foods from the oven.
- **Do Not Use Oven Cleaners**—No commercial oven cleaner or oven liner protective coating of any kind should be used in or around any part of the oven.
- **Do Not Clean Door Gasket**—The door gasket is essential for a good seal. Care should be taken not to rub, damage or move the gasket.
- **The health of some birds is extremely sensitive to the fumes given off during the self-cleaning cycle of any range.** Move birds to another well-ventilated room.

Surface Cooking for Models with a Ceramic-Glass Cook Top

NOTE: Please read detailed instructions for Ceramic-Glass Cooktop Cleaning in the **General Cleaning** and **Avoid Service Checklist** sections of this Use and Care Guide.

NOTE: Radiant elements have a limiter that allows the element to cycle on and off, even at the HI setting. This helps to prevent damage to the glass top. Cycling at the HI setting is normal and can occur if the pan is too small for the element or if the pan bottom is not flat.

Ceramic-Glass Cooktop

The ceramic-glass cooktop has electric heating coils located below the surface of the glass. The design of the glass cooktop outlines the area of the surface unit below. Most importantly, make sure the diameter of the pan matches the diameter of the unit. Heat is transferred up through the surface of the cooktop to the cooking utensil. Only flat-bottomed pans should be used. The type and size of the cookware, number of surface units in use and the settings of the units are factors that will affect the amount of heat that will spread to areas surrounding the surface units. The areas surrounding the units may become hot enough to cause burns.

The cooktop should not be used as a cutting board or work surface in the kitchen. Dropping heavy or hard objects on the cooktop may crack it. Pans with rough bottoms may scratch the cooktop surface. Do not place foods directly on the smoothtop surface (without cooking utensils) damage to glass or difficulty in cleaning will result.

Radiant Surface Units

The Radiant Surface Unit is a group of heating coils enclosed in a ceramic fixture below the glass cooktop. The unit temperature rises gradually and evenly. As the temperature rises, the unit will glow red. To maintain the selected setting, the unit will cycle on and off. The heating unit retains enough heat to provide a uniform and consistent heat during the off cycle. The ceramic fixture thermally insulates the heating unit, concentrating heat in the heating zone. For efficient cooking, turn off the unit several minutes before cooking is complete. This will allow residual heat to complete the cooking process. The amount of residual heat depends on the type and quality of cooking utensil, the quantity of food being cooked and the selected heat setting.

Dual Radiant Surface Units (If equipped)

The dual radiant surface unit is made up of an inner and outer coil within the same surface unit. A control knob and rocker switch is used for operating the different coils. The smaller unit or inner coil has a lower wattage and can be used to prepare smaller quantities of food in smaller pans. The larger unit or both inner and outer coils has a higher wattage and can be used to prepare larger quantities of food in larger pans. When using the outer coil, both inner and outer coils operate.

Indicator Light(s)

There are 2 different surface control lights that will glow on your range—a **surface indicator** and a **hot cooktop surface indicator**.

The **surface indicator**, located on the control panel, glows when any surface unit is turned on. A quick glance at the light after cooking is an easy check to be sure all surface controls are turned off.

The **hot cooktop surface indicator**, located under the glass cooktop or on the control panel, will come on as the surface cooking area heats up and will continue to glow until the glass cooktop has cooled down to a moderate level.

Setting Surface Controls for Models with Radiant Elements

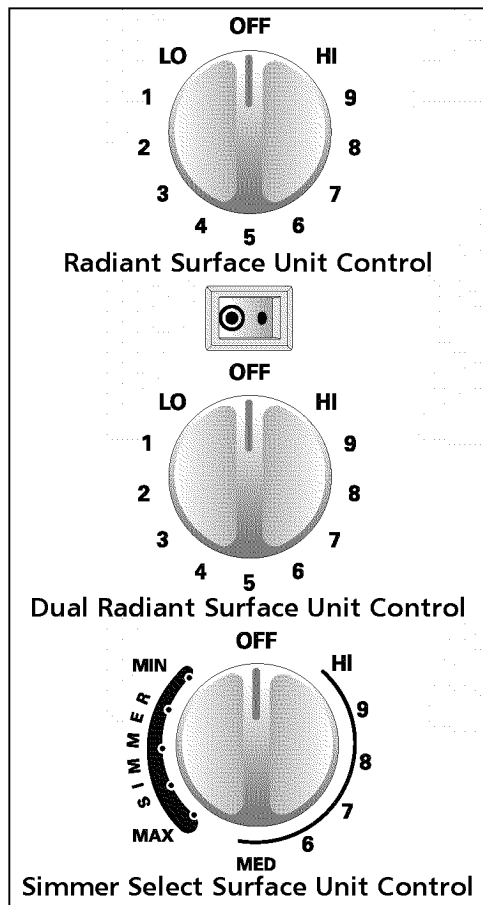

To Operate Radiant Surface Unit

1. Place cooking utensil on the surface element.
2. Push in and turn the Surface Control knob in either direction to the desired setting. Start most cooking operations on a higher setting and then turn to a lower setting to finish cooking. The control knobs do not have to be set exactly on a particular mark. Use the marks as a guide and adjust the control knob as needed. Each surface unit provides a constant amount of heat at each setting. A glowing red surface unit extending beyond the bottom edge of the utensil indicates the utensil is too small for the unit.
3. When cooking is completed, turn the surface element off before removing the pan. Note: The surface signal light will glow when one or more elements are turned on. A quick glance at the signal light(s) when cooking is finished is an easy check to be sure all control knobs are turned off. The hot cooktop surface light will continue to glow after the control knob is turned to off and will glow until the element has cooled sufficiently.

To Operate Dual Radiant Surface Unit (If equipped)

Set the rocker switch to the desired coil size. ● Indicates inner coil only.

⊙ Indicates both inner and outer coils operate. You may switch from either coil setting at any time during cooking. Push in and turn the Control Knob in either direction to the desired setting as instructed above.

To Operate Simmer Select Surface Unit (If equipped)

The right side of the control knob allows you to use the Simmer Select unit as you would any normal surface unit on the medium to high settings.

The left side of the control knob is used to operate the Simmer Select feature. This feature allows the element to heat at a much lower temperature than when used as a normal surface unit. This allows you to precisely simmer delicate foods.

You may switch between normal cooking and Simmer Select at any time during the cooking process. Be sure to set the knob indicator between **MAX** and **MIN** for simmering or between **MED** and **HI** for normal cooking.

NOTE: The unit will not operate if the knob is positioned in the space between **MAX** and **MED**.

The suggested settings found in the chart below are based on cooking in medium-weight aluminum pans with lids. Settings may vary when using other types of pans.

STANDARD AND DUAL RADIANT SURFACE UNITS

Setting	Type of Cooking
HIGH (HI - 9)	Start most foods, bring water to a boil, pan broiling
MEDIUM HIGH (7 - 8)	Continue a rapid boil, fry, deep fat fry
MEDIUM (5 - 6)	Maintain a slow boil, thicken sauces and gravies, steam vegetables
MEDIUM LOW (2 - 4)	Keep foods cooking, poach, stew
LOW (LO - 1)	Keep warm, melt, simmer

SIMMER SELECT SURFACE UNIT

MAX	Larger quantities of food, stews and soups
MIN	Smaller quantities of food, delicate foods, melting chocolate or butter

CAUTION After turning a Radiant Surface Unit **OFF**, be careful not to touch either unit until it has had enough time to **COOL**. Surface Units will turn dark in color after they have been turned off and burns may occur if the units are touched at this time.

CAUTION Do not place plastic items such as salt and pepper shakers, spoon holders or plastic wrappings on top of the range when it is in use. These items could melt or ignite. Potholders, towels or wooden spoons could catch fire if placed too close to the unit.

CAUTION When using the Simmer Select feature the element will not glow red when it is hot.

Note: The size and type of utensil used, and the amount and type of food being cooked will influence the setting needed for best cooking results.

Setting Warm Zone Controls (if equipped)

Use the warm zone to keep cooked foods hot such as: vegetables, gravies, casseroles, soups, stews, breads, pastries and oven-safe dinner plates.

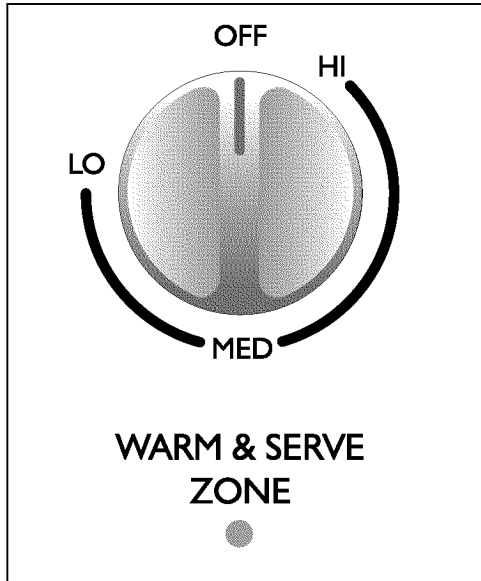

To Operate the Warm Zone

The purpose of the warm zone is to keep hot cooked foods at serving temperature. Always start with hot food. It is not recommended to heat cold food on the warm zone.

All food placed on the warm zone should be covered with a lid or aluminum foil to maintain quality. For best results, when warming pastries or breads, the cover should have an opening to allow moisture to escape. **Do not use plastic wrap to cover food. Plastic may melt onto the surface and be very difficult to clean.**

Use only dishware, utensils and cookware recommended for oven and cooktop use on the warm zone.

CAUTION Unlike the surface elements, the warm zone will not glow red when it is hot.

CAUTION Always use potholders or oven mitts when removing food from the warm zone as cookware and plates will be hot.

To Set the Warm Zone Control

1. To set the control, push in and turn the knob. The temperatures are approximate, and are designated by HI, MED and LO. However, the control can be set at any position between HI and LO for different levels of heating.
2. When done, turn the control to OFF. The warm zone will remain warm until the hot surface indicator light goes off.

Temperature Selection

Refer to the chart in the side column for recommended heating levels. If a particular food is not listed, start with the medium level, and adjust as needed. Most foods can be kept at serving temperatures by using the medium level.

Indicator Lights

The surface indicator light is located below the warm zone control. It turns on when the control is set, and stays on until the control is turned off. The hot surface indicator light, located under the glass cooktop or on the control panel, will come on when the control is set and will continue to glow until the glass cooktop has cooled down to a moderate level.

Warm Zone Recommended Food Settings Chart	
Food Item	Heating Level
Breads/Pastries	LO
Casseroles	LO
Dinner Plates with Food	LO
Eggs	LO
Gravies	LO
Meats	MED
Sauces	MED
Soups (cream)	MED
Stews	MED
Vegetables	MED
Fried Foods	HI
Hot Beverages	HI
Soups (liquid)	HI

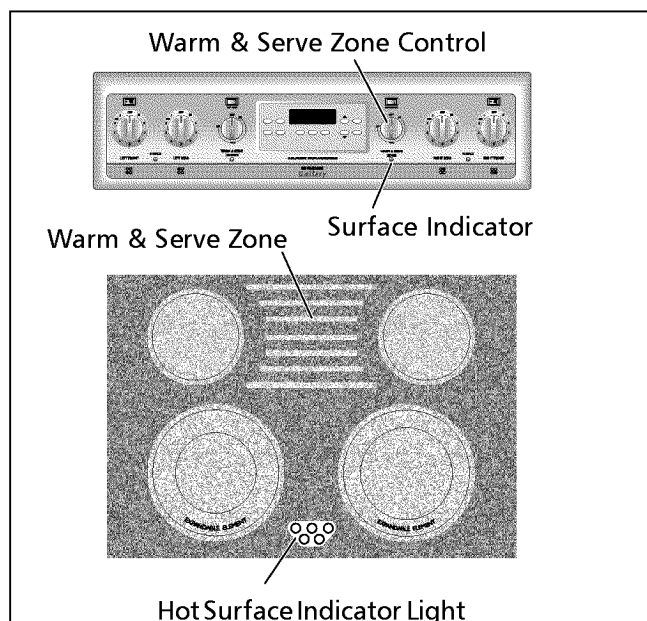

Setting Warmer Drawer Controls (if equipped)

Use the warmer drawer to keep hot foods hot such as: vegetables, gravies, meats, casseroles, biscuits and rolls, pastries and heated dinner plates.

The warmer drawer is equipped with a catch which may require extra force when opening and closing the drawer.

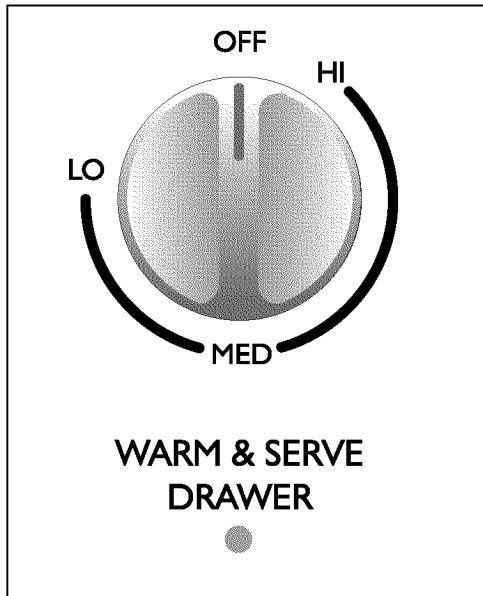

Warmer Drawer Recommended Food Settings Chart	
Food Item	Setting
Roasts (Beef, Pork, Lamb)	MED
Pork Chops	HI
Bacon	HI
Hamburger Patties	HI
Poultry	HI
Gravies	MED
Casseroles	MED
Eggs	MED
Fried Foods	HI
Vegetables	MED
Pizza	HI
Biscuits	MED
Rolls, soft	LO
Rolls, hard	MED
Pastries	MED
Empty Dinner Plates	LO

Arranging Warmer Drawer Rack Positions

The rack can be used in 2 ways:

- In the **upright position** to allow low profile food items to be placed both under and on top of the rack (for example, rolls or biscuits on top of the rack and a casserole dish under).
- In the **downward position** to allow you to place light weight food items and empty dishware (for example, rolls or pastries and dinner plates). Set the warmer drawer rack as shown below.

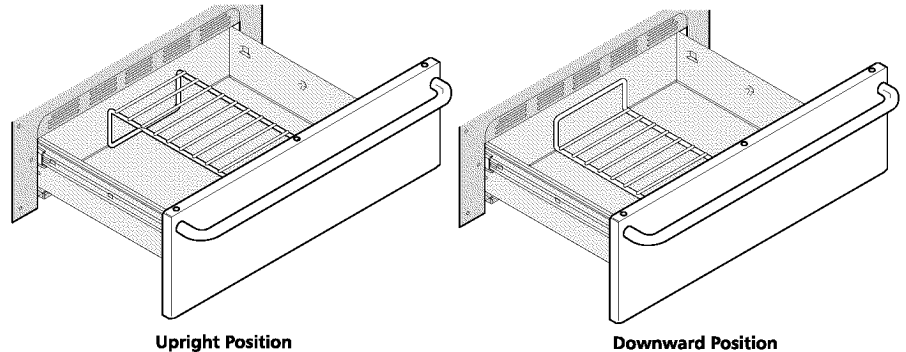

To Operate the Warmer Drawer

Your range is equipped with a warmer drawer. The purpose of the warmer drawer is to keep hot cooked foods at serving temperature. Always start with hot food. It is not recommended to heat cold food in the warmer drawer.

All food placed in the warmer drawer should be covered with a lid or aluminum foil to maintain quality. **Do not use plastic wrap to cover food. Plastic may melt onto the drawer and be very difficult to clean.**

Use only dishware, utensils and cookware recommended for oven use in the warmer drawer.

CAUTION Always use potholders or oven mitts when removing food from the warmer drawer as cookware and plates will be hot.

To Set the Warmer Drawer Thermostat Control

The thermostat control is used to select the temperature of the warmer drawer. It is located on the control panel. To set the thermostat, push in and turn the knob to the desired setting. The temperatures are approximate, and are designated by HI, MED and LO.

1. Turn the knob to select the desired temperature setting.
2. For best results, preheat the drawer before adding food. An empty drawer will preheat in approximately 15 minutes.
3. Turn the thermostat control to OFF after use.

Temperature Selection

Refer to the chart in the side column for recommended settings. If a particular food is not listed, start with the medium setting. If more crispness is desired, remove the lid or aluminum foil.

Most foods can be kept at serving temperatures by using the medium setting.

When a combination of foods are to be kept warm (for instance, a meat with 2 vegetables and rolls), use the high setting.

Refrain from opening the warmer drawer while in use to eliminate loss of heat from the drawer.

Indicator Light

The indicator light is located below the thermostat control. It turns on when the control is set, and stays on until the control is turned off. The warmer drawer is inoperable during the self-clean cycle. The indicator light will not come on during the self-clean cycle.

Before Setting Oven Controls

Oven Vent Location

For models equipped with coil surface elements, the oven vent is located **under the left rear surface element**. For models equipped with a ceramic-glass cook top the oven vent is located **below the backguard**. When the oven is on, warm air is released through the vents. This venting is necessary for proper air circulation in the oven and good baking results.

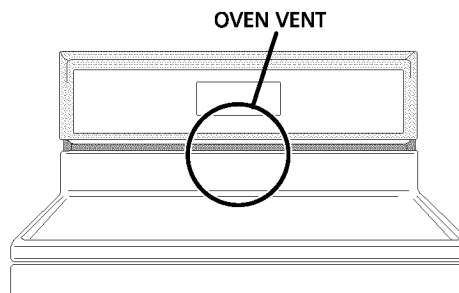

Arranging Oven Racks

ALWAYS ARRANGE OVEN RACKS WHEN THE OVEN IS COOL (PRIOR TO OPERATING THE OVEN). Always use oven mitts when using the oven.

REMOVING & REPLACING OVEN RACKS

To remove, pull the rack forward until it stops. Lift up front of rack and slide out. **To replace**, fit the rack onto the guides on the oven walls. Tilt the front of the rack upward and slide the rack back into place.

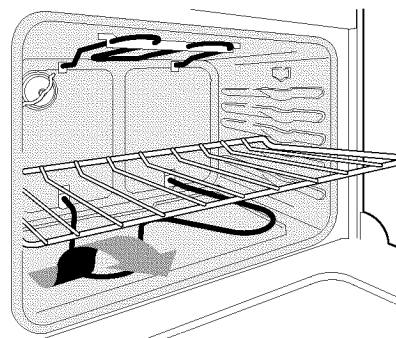

ARRANGING OVEN RACKS WITH 5 RACK POSITIONS

To bake on 1 rack, place the rack on position 3 or 4. **To bake on 2 racks**, place the racks on positions 2 and 4. Convection ranges are equipped with 3 racks and should be placed in positions 1, 3 and 4.

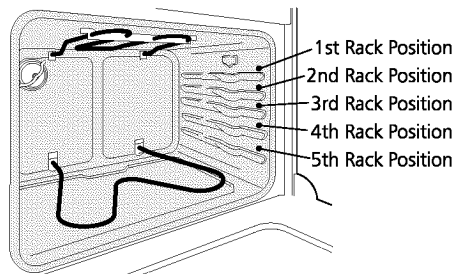

Control Pad Functions

READ THE INSTRUCTIONS CAREFULLY BEFORE USING THE OVEN. For satisfactory use of your oven, become familiar with the various functions of the oven as described below.

CLEAR PAD— Used to clear any function previously entered except the time of day and minute timer. Push **CLEAR** to stop cooking.

BAKE PAD—Used to enter the normal baking mode temperature.

BROIL PAD— Used to select the variable broil function.

CLEAN PAD— Used to select the self-cleaning cycle.

UP and DOWN ARROW PADS— Used along with the function pads to select oven temperature, cooking time, stop time (when programming an automatic stop time), time of day, clean time and minute timer.

CLOCK PAD— Used to set the time of day.

FEATURE INDICATOR LIGHTS— These light to show which feature is in use.

BAKE TIME PAD— Used to enter the length of the baking time.

STOP TIME PAD— Used to set the desired stop time for baking. Can be used with **BAKE TIME** to program a delayed bake cycle.

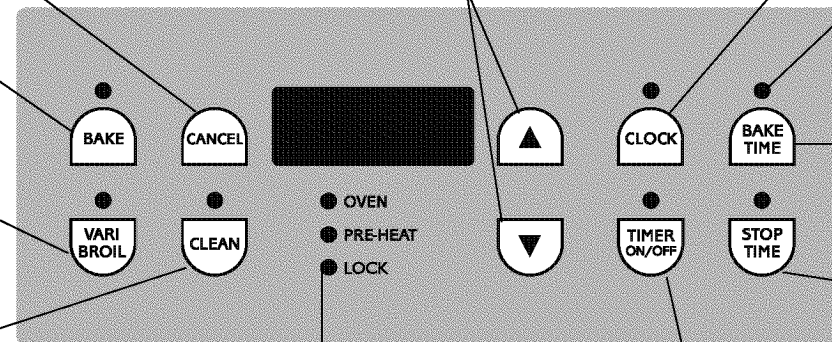



OVEN, PREHEAT & LOCK LIGHTS— The "OVEN" light will glow each time the oven unit turns on to maintain the set oven temperature. The "PREHEAT" light will glow when the oven is first set to operate, or if the desired temperature is reset higher than the actual oven temperature. The "LOCK" light will flash until the door locks when the self-clean cycle is in use. It glows constantly after the door locks.

TIMER PAD— Used to set or cancel the minute timer. The minute timer does not start or stop cooking.

The oven can be programmed to:

- Bake normally
- Time bake
- Broil
- Self-clean

For a silent control panel:





When choosing a function, a beep will be heard each time a pad is pushed. If desired, the controls can be programmed for silent operation. Push and hold . After 7 seconds, the control will beep once. This will block the controls from sounding when a pad is pushed. To return the sound, push and hold  again for 7 seconds until 1 beep is heard.

Note: The control will return to the audible mode after a power outage.

Temperature conversion:

The electronic oven control is set to operate in °F (Fahrenheit) when shipped from the factory. The oven can be programmed for any temperature from 170°F to 550°F (65°C to 287°C).

To change the temperature to °C (Celsius) or from °C to °F (control should not be in a Bake or Clean mode):

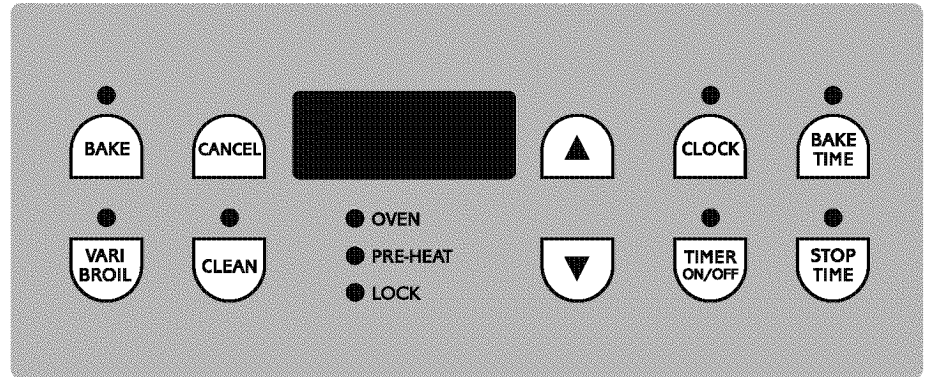

1. Push . "— — —" appears in the display.
2. Push and hold the  until "HI" appears in the display.
3. Push and hold  until °F or °C appears in the display.
4. Push the  or  to change °F to °C or °C to °F.
5. Push any function pad to return to normal operating mode.

Setting the Clock and Minute Timer



To Set the Clock - Control Style 4



When the range is first plugged in, or when the power supply to the range has been interrupted, the display will flash "12:00".

1. Push .
2. Within 5 seconds, push and hold the  or  until the correct time of day appears in the display.

Note: The oven function will not work if the time of day clock is not set.

Note: The clock cannot be changed during any timed bake or self-clean cycle.

To Set the Minute Timer - Control Style 4



1. Push .
2. Push the  to increase the time in one minute increments. Push and hold the  to increase the time in 10 minute increments. The timer can be set for any amount of time from 1 minute to 11 hours and 59 minutes.

Note: If you push the  first, the timer will advance to 11 hours and 59 minutes.

3. The display shows the timer count down in minutes until one minute remains. Then the display will count down in seconds.
4. When the set time has run out, the timer will beep 3 times. It will then continue to beep 3 times every 60 seconds until  is pushed.

Note: The minute timer does not start or stop cooking. It serves as an extra timer in the kitchen that will beep when the set time has run out. The minute timer can be used alone or during any of the other oven functions. When the minute timer is in use with any other mode, the minute timer will be shown in the display. To view other functions, push the function pad for that mode.

To Change the Minute Timer while it is in use:

While the timer is active and shows in the display, push and hold the  or  to increase or decrease the time.

To Cancel the Minute Timer before the set time has run out:

Push .

Setting Oven Controls

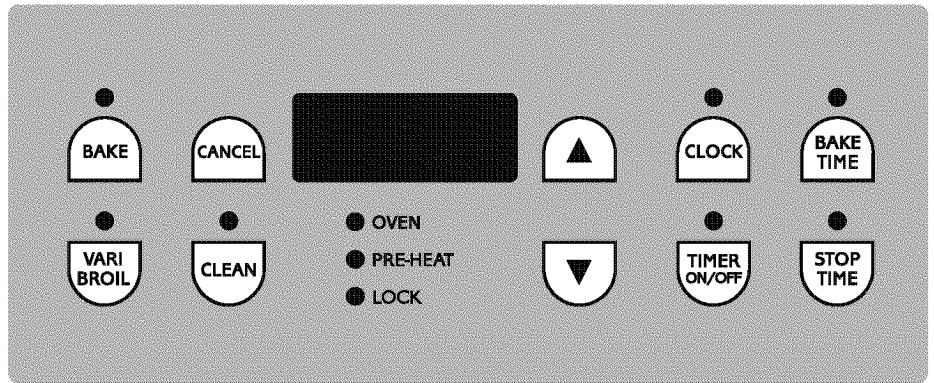

Note: The oven function will not work if the time of day clock is not set.

Note: The oven control has a built-in safety feature that will shut off the oven if the control is left on for more than 11 hours 59 minutes.

To Set or Change the Temperature for Normal Baking

The oven can be programmed to bake at any temperature from 170°F to 550°F (65°C to 287°C).

To Set the Controls for Normal Baking:

1. Push **BAKE**. "— — —" appears in the display.
2. Within 5 seconds, push the **▲** or **▼**. The display will show "350°F (177°C)." By holding the **▲** or **▼**, the temperature can then be adjusted in 5°F (1°C) increments.
3. As soon as the **▲** or **▼** is released, the oven will begin heating to the selected temperature. When the displayed temperature reaches the desired baking temperature, the control will beep 3 times.
4. To cancel the baking function, push **CANCEL**.

To Change the Oven Temperature after Baking has Started:

1. If you are using the minute timer, push **BAKE** and make sure the bake temperature is displayed.
2. Push the **▲** or **▼** to increase or decrease the set temperature.

Setting Oven Control

Benefits of Speed Bake™ Cooking System:

- Foods cook up to 30% faster, saving time and energy.
- Two racks can be used with more even cooking and browning.
- No special pans or bakeware needed.

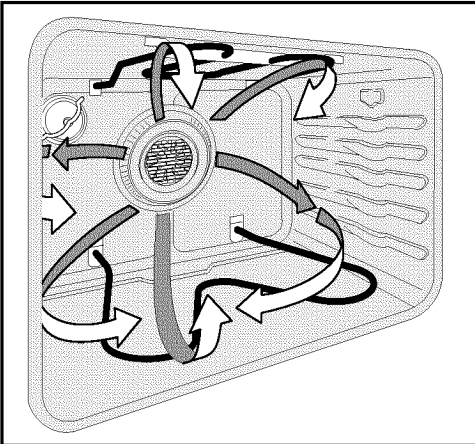

Recommended Foods for Speed Bake™ Cooking System

Food Item	Decrease Cook Time by:
Casseroles	25%
Meats	15% (or 5 min/lb)
Poultry	30% (or 10 min/lb)
Frozen foods	20%
Refrigerator cookies	25% (or 2 to 5 min.)
Refrigerator biscuits	25% (or 2 to 4 min.)
Rolls/Breads/Pizza	25% (or 5 min.)
Vegetables	25%
Baked Potatoes	25%
Pies/Pastries	30%

SPEED BAKE

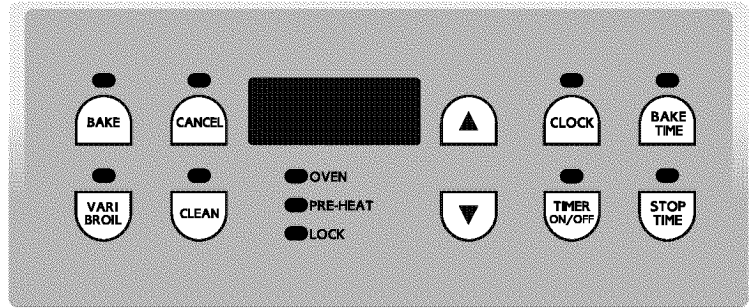

Speed Bake™ Cooking System - (If equipped)

Speed Bake™ Cooking System uses a fan to circulate the oven's heat uniformly and continuously around the oven. This improved heat distribution allows for fast, even cooking and browning results. It also gives better baking results when using two racks at the same time.

Heated air flows around the food from all sides, sealing in juices and flavors. Meats cooked with Speed Bake™ Cooking System are juicier. Poultry is crisp on the outside while staying tender and moist on the inside. Breads and pastry brown more evenly. Most foods baked in a standard oven can be cooked faster and more evenly with Speed Bake™ Cooking System.

General Cooking Instructions:

1. To convert baking times for normal recipes to Speed Bake times, start with a 30% reduction in time and increase the time until the desired doneness is obtained. Time reductions will vary depending on the amount and type of food.
2. Preheating is not necessary when cooking with Speed Bake, except with items such as cakes, cookies, biscuits, breads, etc.
3. When using two racks at the same time, place in positions 2 and 5 for the best results.
4. When baking cakes with Speed Bake, set temperature 25F° (13C) degrees lower than the recommended setting for best results.

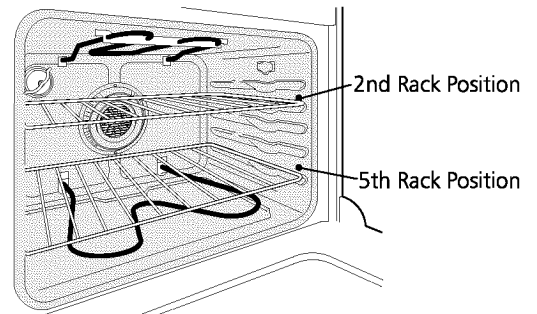

To Set Speed Bake™ Cooking System:

1. Program the oven as you normally would for baking. Speed Bake may be used with Bake, Time Bake and Delayed Time Bake modes.
2. Push and release Speed Bake switch. The indicator light will glow and the fan will come on. The fan stays on when the oven door is closed and shuts off while the oven door is opened. The fan will continue to operate until baking is complete.
3. To cancel Speed baking function, push CANCEL on the oven control as you would to cancel any baking function.

NOTE: The Speed Bake mode will not work during a clean cycle.

Setting Oven Control

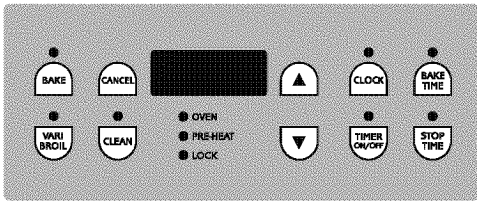

CAUTION Use caution when using the automatic timer. Use the automatic timer when cooking cured or frozen meats and most fruits and vegetables. Foods that can easily spoil such as milk, eggs, fish, meat or poultry, should be chilled in the refrigerator first. Even when chilled, they should not stand in the oven for more than 1 hour before cooking begins, and should be removed promptly when cooking is completed.

NOTE: When using the Speed Bake feature along with the Delayed Timed Bake mode, the fan will begin to operate when the oven control is set. The oven elements will not begin to operate until the Delayed Start Time is reached. This operation is normal.

To Set the Automatic Timer (Timed Bake Feature)

The BAKE TIME and STOP TIME controls operate the Timed Bake feature. The automatic timer will turn the oven on and off at the times you select in advance. The oven can be programmed to start immediately and shut off automatically or to begin baking at a later time with an automatic shutoff.

To Program the Oven to Begin Baking Immediately and To Shut Off Automatically:

1. Be sure that the clock shows the correct time of day.
2. Place the food in the oven.
3. Push **BAKE**.
4. Within 5 seconds, push the **▲** or **▼**. The display will show "350°F (177°C)." By holding the **▲** or **▼**, the temperature can then be adjusted in 5°F (1°C) increments.
5. Push **BAKE TIME**. "0:00" will flash in the display.
6. Push the **▲** or **▼** until the desired amount of baking time appears in the display.

To Program Oven for a Delayed Start Time and to Shut-Off Automatically

1. Be sure that the clock shows the correct time of day.
2. Place the food in the oven.
3. Push **BAKE**.
4. Within 5 seconds, push the **▲** or **▼**. The display will show "350°F (177°C)." By holding the **▲** or **▼**, the temperature can then be adjusted in 5°F (1°C) increments.
5. Push **BAKE TIME**. "0:00" will flash in the display.
6. Push the **▲** or **▼** until the desired amount of baking time appears.
7. Push **STOP TIME**. The earliest possible stop time will flash in the display.
8. Push the **▲** or **▼** until the desired stop time appears in the display.
9. Once the controls are set, the control calculates the time when baking will start in order to finish at the time you have set.

Once the Controls are Set:

- a. The oven will come on and begin heating to the selected baking temperature.
- b. The oven temperature (or time of day) will show in the display.

When the Set Bake Time Runs Out:

- a. "END" will appear in the display window and the oven will shut off automatically.
- b. The control will beep 3 times every 60 seconds until **CANCEL** is pushed.

To Change the Oven Temperature or Bake Time after Baking has Started:

1. Push the function pad you want to change.
2. Push the **▲** or **▼** to adjust the setting.

Setting Oven Controls

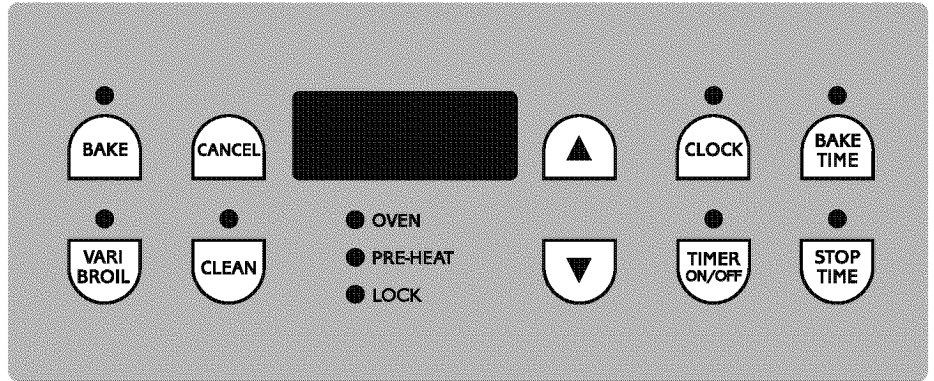





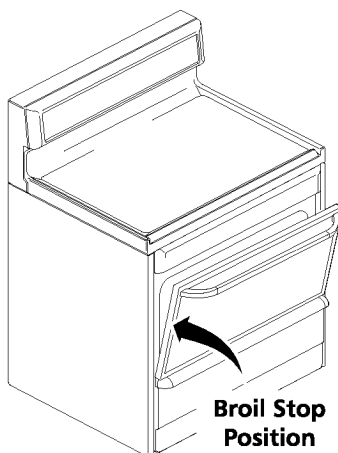
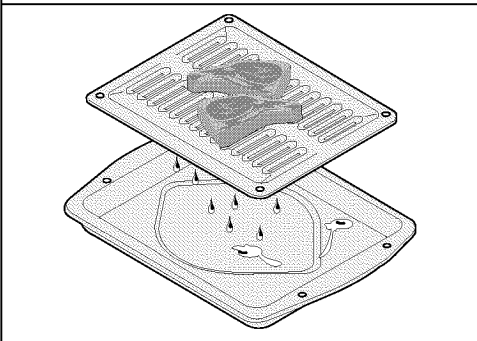

To Broil

1. Arrange oven rack while oven is still cool. Position the rack as suggested in the chart below.

Rack Position From Top	Food
1	Rare steaks
2	Ham slices, fish, medium steaks, hamburgers and chops
3	Well-done foods such as chicken and lobster

The broiler pan and its grid allow dripping grease to drain and be kept away from the high heat of the broiler. **DO NOT** use the pan without its grid. **DO NOT** cover the grid with foil. The exposed grease could ignite.



2. Push .
3. Push and hold the  or  until the desired broil setting level appears in the display. Push the  for HI broil or the  for LO broil. Most foods can be broiled at the HI broil setting. Select the LO broil setting to avoid excess browning or drying of foods that should be cooked to the well-done stage.
4. Place the grid on the broiler pan, then place the food on the grid. **DO NOT** use the broiler pan without the grid or cover the grid with aluminum foil. The exposed fat could ignite.
5. Place the pan on the oven rack. **Open the oven door to the broil stop position when broiling.**
6. Broil on one side until food is browned; turn and cook on the second side. **Note:** Always pull the rack out to the stop position before turning or removing food.
7. When broiling is finished, push .

CAUTION Should an oven fire occur, close the oven door and turn off the oven. If the fire continues, use a fire extinguisher. **DO NOT** put water or flour on the fire. Flour may be explosive.

NOTE: **DO NOT** operate Speed Bake feature in Broil Mode. Speed Bake is intended for use in Bake modes only.

Self-Cleaning

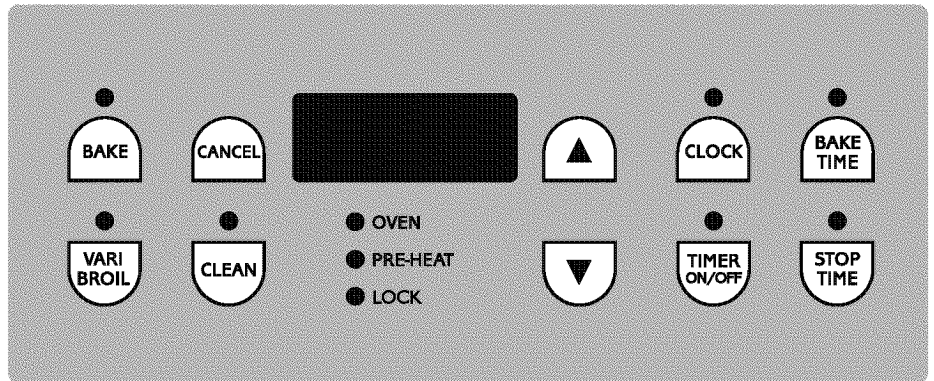

CAUTION During the self-cleaning cycle, the outside of the range can become very hot to the touch. **DO NOT** leave small children unattended near the appliance.

CAUTION The health of some birds is extremely sensitive to the fumes given off during the self-cleaning cycle of any range. Move birds to another well-ventilated room.

CAUTION **DO NOT** line the oven walls, racks, bottom or any other part of the range with aluminum foil. Doing so will destroy heat distribution, produce poor baking results and cause permanent damage to the oven interior (aluminum foil will melt to the interior surface of the oven).

CAUTION **DO NOT** force the oven door open. This can damage the automatic door locking system. Use caution when opening the door after the self-cleaning cycle is completed. The oven may still be **VERY HOT**.

Self-Cleaning Oven

A self-cleaning oven cleans itself with high temperatures (well above cooking temperatures) which eliminate soil completely or reduce it to a fine powdered ash you can wipe away with a damp cloth.

1. Adhere to the following cleaning precautions:

- Allow the oven to cool before precleaning.
 - Wear rubber gloves when precleaning and while wiping up the residue after the self-clean cycle.
 - **DO NOT** use oven cleaners or oven protective coatings in or around any part of the self-cleaning oven.
 - **DO NOT** clean the oven door gasket. The woven material of the oven door gasket is essential for a good seal. Care should be taken not to rub, damage or remove the gasket.
 - **DO NOT** use any cleaning materials on the oven door gasket. Doing so could cause damage.
- ### 2. Remove the broiler pan and insert, all utensils and any aluminum foil. These items cannot withstand high cleaning temperatures.
- ### 3. Oven racks may be left in the oven or may be removed. If they go through the clean cycle their color will turn slightly blue and the finish will be dull. After the cycle is complete and the oven has cooled, rub the sides of the racks with wax paper or a cloth containing a small amount of baby oil or salad oil (this will make the racks glide easier into the rack position).
- ### 4. Remove any excess spillovers in the oven cavity before starting the self-cleaning cycle. To clean, use hot, soapy water and a cloth. Large spillovers can cause heavy smoke or fire when subjected to high temperatures. **DO NOT** allow food spills with a high sugar or acid content (such as milk, tomatoes, sauerkraut, fruit juices or pie filling) to remain on the surface as they may cause a dull spot even after cleaning.
- ### 5. Clean any soil from the oven frame, the door liner outside the oven door gasket and the small area at the front center of the oven bottom. These areas heat sufficiently to burn soil on. Clean with soap and water.

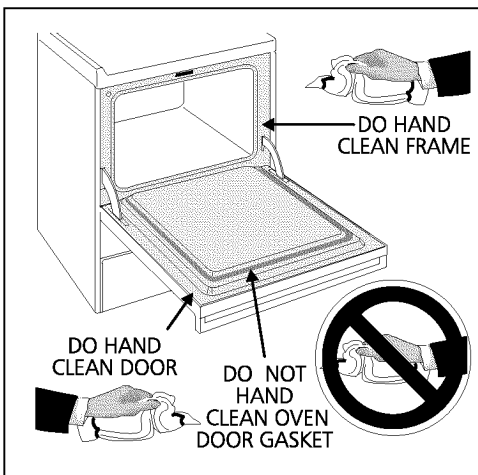

Self-Cleaning

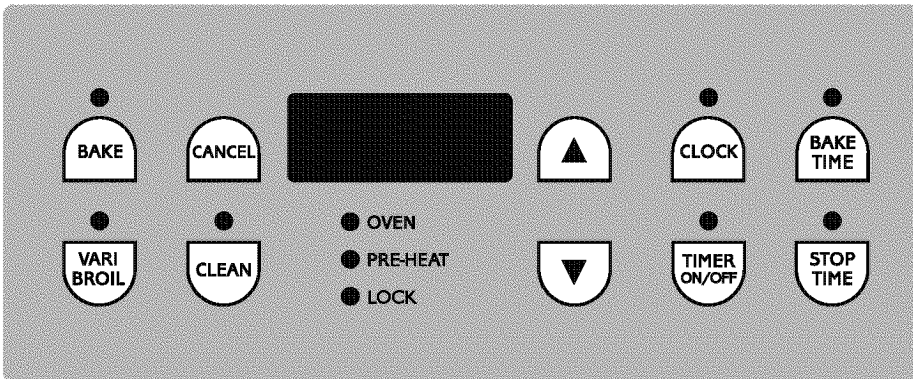

CAUTION Use care when opening the oven door after the self-cleaning cycle. Stand to the side of the oven when opening the door to allow hot air or steam to escape.

CAUTION DO NOT force the oven door open. This can damage the automatic door locking system. Use caution when opening the door after the self-cleaning cycle is completed. The oven may still be VERY HOT.

To Start the Self-Clean Cycle

*We recommend a 2 hour self-clean cycle for **light soils** and a 3 hour cycle for **average to heavy soils** (to assure satisfactory results).

To Set the Controls for a Self-Clean Cycle:

1. Be sure the clock shows the correct time of day.
2. Push **CLEAN**. "— — —" appears in the display.
3. Push the **▲** until "3:00" appears in the display for a 3 hour cycle, or push the **▼** until "2:00" appears in the display for a 2 hour cycle.
4. As soon as the **▲** or **▼** is released, "CLn" appears in the display.
5. As soon as the controls are set, the motor driven lock will begin to close automatically and the "LOCK" indicator light will flash. **DO NOT** open the door while the light is flashing (it takes about 15 seconds for the lock to close).
6. The "LOCK" light will glow until the cleaning cycle is completed or cancelled, and the oven temperature has cooled.

When the Self-Clean Cycle is Completed:

1. The time of day or "End" will appear in the display window and the "Clean" and "LOCK" light will continue to glow.
2. Once the oven has cooled down for about 1 HOUR and the "LOCK" light has gone out, the oven door can be opened.
3. If "End" is in the display and the "Clean" indicator remains on, press **CANCEL** or **CLEAR**. The time of day will appear in the display.

Stopping or Interrupting a Self-Cleaning Cycle

If it becomes necessary to stop or interrupt a self-cleaning cycle due to excessive smoke or fire:

1. Push **CLEAR** or **CANCEL**
2. Once the oven has cooled down for about 1 HOUR and the "LOCK" light has gone out, the oven door can be opened.
3. Correct the condition which caused the smoking.
4. Restart the self-clean cycle once all conditions have been corrected.

General Cleaning

Cleaning Various Parts of Your Range

Before cleaning any part of the range, be sure all controls are turned OFF and the range is cool. Remove spillovers and heavy soiling as soon as possible. Regular cleanings will reduce the effort required for major cleanings later.

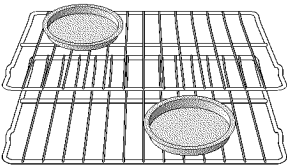
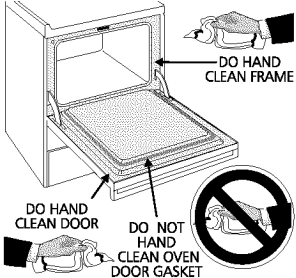
Surfaces	How to Clean
Aluminum (Trim Pieces) & Vinyl	Use hot, soapy water and a cloth. Dry with a clean cloth.
Glass, Painted and Plastic Control Knobs, Body Parts, and Decorative Trim	<i>For general cleaning</i> , use hot, soapy water and a cloth. <i>For more difficult soils and built-up grease</i> , apply a liquid detergent directly onto the soil. Leave on soil for 30 to 60 minutes. Rinse with a damp cloth and dry. DO NOT use abrasive cleaners on any of these materials; they can scratch. To remove control knobs, turn to the OFF position; grasp firmly and pull straight off the shaft. To replace knobs after cleaning, line up the flat sides of both the knob and the shaft; then push the knob into place.
Stainless Steel, Chrome Control Panel, Decorative Trim	<i>Before cleaning the control panel</i> , turn all controls to OFF and remove the control knobs. To remove, pull each knob straight off the shaft. Clean using hot, soapy water and a dishcloth. Rinse with a clean water and a dishcloth. Cover stubborn spots with an ammonia-soaked paper towel for 30 to 40 minutes. Rinse. Be sure to squeeze excess water from the cloth before wiping the panel; especially when wiping around the controls. Excess water in or around the controls may cause damage to the appliance. Cleaners made especially for stainless steel such as Stainless Steel Magic, trademark of Magic American Corp., or similar products are recommended. Always follow the manufacturer's instructions. Be sure to rinse the cleaners as bluish stains may occur during heating and cannot be removed. To replace knobs after cleaning, line up the flat sides of both the knob and the shaft; then push the knob into place.
Porcelain Enamel Broiler Pan and Insert, Door Liner, Body Parts, Warmer Drawer (if equipped)	Gentle scouring with a soapy scouring pad will remove most spots. Rinse with a 1:1 solution of clear water and ammonia. <i>If necessary</i> , cover difficult spots with an ammonia-soaked paper towel for 30 to 40 minutes. Rinse with clean water and a damp cloth, and then scrub with a soap-filled scouring pad. Rinse and wipe dry with a clean cloth. Remove all cleaners or the porcelain may become damaged during future heating. DO NOT use spray oven cleaners on the cooktop.
<p>Oven Racks</p> 	<p>Oven racks may be removed or left in the oven during the self-clean cycle for cleaning. If removed, clean by using a mild, abrasive cleaner following manufacturer's instructions. Rinse with clean water and dry.</p> <p>If the racks are cleaned in the self-clean cycle, their color will turn slightly blue and the finish will be dull. After the self-clean cycle is complete, and the oven has cooled, rub the sides of the racks with wax paper or a cloth containing a small amount of baby oil or salad oil (this will make the racks glide easier into the rack positions).</p>
<p>Oven Door</p> 	<p>To clean oven door, wash with hot, soapy water and a clean cloth. DO NOT immerse the door in water.</p> <p>DO NOT clean the oven door gasket. The oven door gasket is made of a woven material, on self cleaning models, which is essential for a good seal. Care should be taken not to rub, damage or remove the gasket.</p>

General Cleaning - Ceramic Glass Cooktop

⚠ WARNING DO NOT use a cooktop cleaner on a hot cooktop. The fumes can be hazardous to your health, and can chemically damage the ceramic-glass surface.

⚠ CAUTION Before cleaning the cooktop, be sure the controls are turned to OFF and the cooktop is COOL.

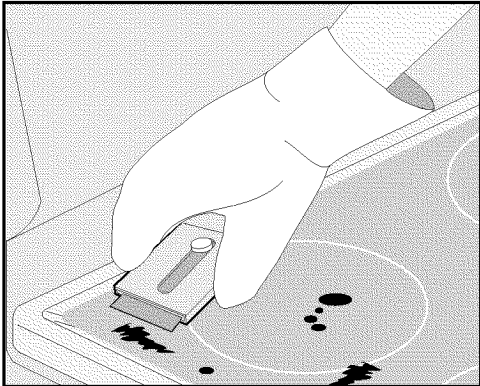

Ceramic-Glass Cooktop Cleaning

Correct and consistent cleaning is essential to maintaining your ceramic-glass cooktop. If food spills, grease spatters and metal rub-off from aluminum cookware are not removed, they may be burned onto the surface of the cooktop and cause permanent discoloration.

Daily Cleaning

For normal soil:

1. Allow cooktop surface to cool.
2. Wipe up spills and spatters using a clean paper towel. Always use a new, clean paper towel when cleaning the ceramic-glass cooktop.
3. Rub a few drops of a recommended ceramic-glass cooktop cleaning cream onto soiled area using a clean, damp paper towel. Buff with a dry paper towel until all soil and cream are removed. Frequent cleaning leaves a protective coating of silicone which helps in preventing scratches and abrasions. Clean surface with the cooktop cleaning cream after each use.
4. Rinse with another clean damp, paper towel. Buff dry with a dry paper towel.

For heavy, burned-on soil:

1. Allow cooktop surface to cool.
2. Carefully scrape soil with a metal razor blade scraper. Hold razor blade scraper at a 30° angle to the cooktop.
3. Remove loosened soil with a clean paper towel.
4. Apply cooktop cleaning cream as described for normal soil.
5. If any soil remains, repeat the steps listed above. After all soil has been removed, polish the entire surface with the cooktop cleaning cream.

For sugary spillovers:

Sugary spills can cause pitting of your cooktop surface. Therefore, you must begin cleaning the spills while the cooktop is still hot. Use caution when following the steps below.

1. Turn off all surface units and remove all pans immediately.
2. Wearing an oven mitt, use a razor blade scraper to scrape the hot spill out of the cooking zone to a cooler area on the cooktop.
3. Allow the cooktop to cool.
4. Follow the instructions above for heavy, burned-on soil.

DO NOT use the following on the ceramic-glass cooktop:

- Abrasive plastic, nylon, metal scouring or cloth pads. They may scratch the cooktop and make it more difficult to clean later.
- Sponges, cloths or dish towels. Lint or soil remaining on the cooktop from a cloth or sponge can burn and cause discoloration.
- Anything that may melt (plastics, aluminum foil).
- Cleansers other than a recommended ceramic-glass cooktop cleaning cream.
- Chlorine bleach, ammonia, hydrofluoric acid, chemical oven cleaners or any other kind of chemical cleaner. They may etch or discolor the cooktop.

General Cleaning

CAUTION The door is heavy. For safe, temporary storage, lay the door flat with the inside of the door facing down.

To Remove and Replace Oven Door

To Remove Oven Door:

1. Open the door.
2. Remove screws located on the inside of the oven door near the hinges **A** (one on each side.)
3. Close the door to the quarter-open position. Grasp the door firmly on both sides and lift up and off the hinges.
4. To clean oven door, follow the instructions provided in the cleaning chart under **General Cleaning**

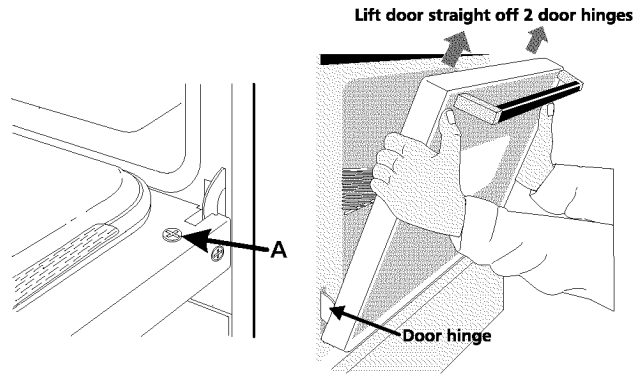

To Replace Oven Door:

1. Be sure the hinge arms are in the quarter-open position. Be careful if pulling the hinges open by hand. The hinges may snap back against the oven frame and could pinch fingers.
2. Hold the door at the sides near the top. Insert the hinge arms into slots at the bottom of the door.
3. Hinge arms must go into the range slots evenly. The hinge arms should be inserted into the bottom corners of the door as far as they can go.
4. If the door is not in line with the oven frame, remove it and repeat the above steps.

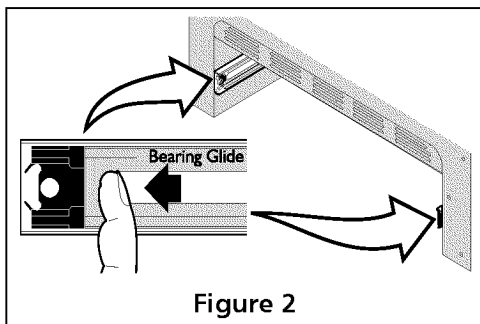
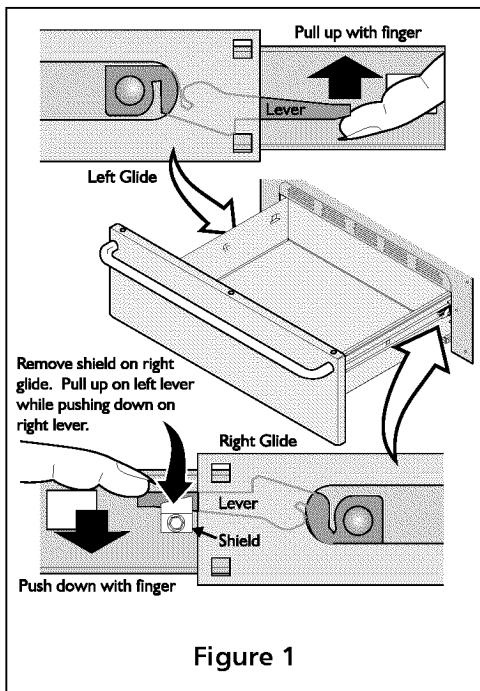

To Remove and Replace Warmer Drawer (if equipped)

To Remove Warmer Drawer:

1. **CAUTION** Turn power off before removing the warmer drawer.
2. Open the drawer to the fully opened position.
3. On the right glide you will find a shield attached with a hex-head screw (see figure 1). Using a 1/4" socket and ratchet remove the shield.
4. Locate glide lever on each side of drawer, pull up on the left glide lever and push down on the right glide lever.
5. Pull the drawer away from the range.

To Replace Warmer Drawer:

1. Replace shield on the right glide of the drawer body.
2. Pull the bearing glides to the front of the chassis glide (see figure 2).
3. Align the glide on each side of the drawer with the glide slots on the range.
4. Push the drawer into the range until levers "click" (approximately 2"). Pull the drawer open again to seat bearing glides into position. If you do not hear the levers "click" or the bearing glides do not feel seated remove the drawer and repeat steps 2-4. This will minimize possible damage to the bearing glides.



WARNING Electrical Shock Hazard can occur and result in serious injury or death. Disconnect appliance from electric power before cleaning and servicing the warmer drawer.

Changing Cooktop and/or Oven Lights

(if equipped)

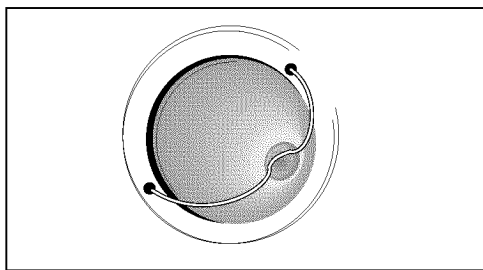
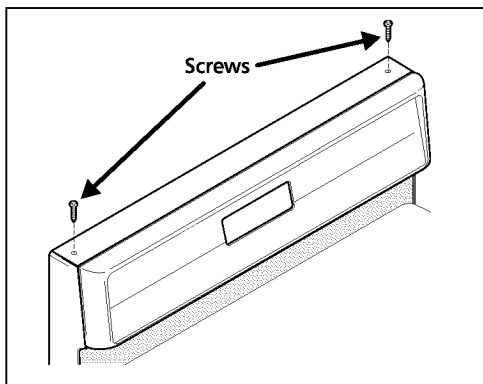

CAUTION Be sure the range is unplugged and all parts are COOL before replacing the surface or oven lights. Wear a leather-faced glove for protection against possible broken glass.

To Change the Cooktop Light (some models)

1. Turn power off at the main source or unplug the range.
2. Remove Phillips® Head screws (2) that secure the light cover and then lift the light cover off.
3. Remove bulb by rolling back and up. Install the new bulb by sliding down and rolling forward into place.
4. Re-install light cover and secure with Phillips® Head screws (2).

To Change the Oven Light (some Self Cleaning Models)

On some models, the oven light automatically turns on when the door is opened. Some models have a switch located on the control panel to turn on the light. The oven light is located at the rear of the oven and is covered with a glass shield held by a wire holder. The glass shield must be in place whenever the oven is in use.

To replace the oven light:

1. Turn electrical power off at the main source or unplug the range.
2. Press wire holder to one side to release the glass shield.
3. Replace bulb with a new 40 watt appliance bulb.
4. Replace glass shield over bulb and snap wire holder into place.
5. Turn power back on again at the main source (or plug the range back in).
6. The clock(if equipped) will then need to be reset. To reset, see **Setting the Clock and Minute Timer** in this Owner's Guide.

Customizing Your Oven Performance

Note: The adjustments made will not change the self-cleaning temperature.

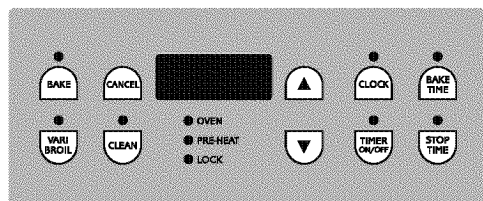

The temperature in the oven has been set at the factory. When first using the oven, be sure to follow recipe times and temperatures. If you think the oven is too hot or too cool, the temperature in the oven can be adjusted. Before adjusting, test a recipe by using a temperature setting that is higher or lower than the recommended temperature. The baking results should help you to decide how much of an adjustment is needed.

To Adjust Oven Temperature

1. Push **BAKE**.
2. Set the temperature to 550°F (287°C) by pushing and holding the **▲**.
3. Within 2 seconds, push and hold **BAKE** until the special 2 digit display appears. Release **BAKE**. The display now indicates the amount of degrees offset between the original factory temperature setting and the current temperature setting. If the oven control has the original factory calibration, the display will read "00."
4. The temperature can now be adjusted up or down 35°F (17°C), in 5°F (1°C) steps, by pushing and holding the **▲** or **▼**. Adjust until the desired amount of offset appears in the display. When lowering the oven temperature, a minus sign (-) will appear before the number to indicate that the oven will be cooler by the displayed amount of degrees.
5. When you have made the desired adjustment, push **CANCEL** to go back to the time of day display.

Avoid Service Checklist

Before you call for service, review this list. It may save you time and expense. The list includes common occurrences that are not the result of defective workmanship or materials in this appliance.

OCCURRENCE

POSSIBLE CAUSE/SOLUTION

Range is not level.

Poor installation. Place oven rack in center of oven. Place a level on the oven rack. Adjust leveling legs at base of range until the oven rack is level.

Be sure floor is level and is strong and stable enough to adequately support range.

If floor is sagging or sloping, contact a carpenter to correct the situation.

Kitchen cabinet alignment may make range appear unlevel. Be sure cabinets are square and have sufficient room for range clearance.

Cannot move appliance easily. Appliance must be accessible for service.

Cabinets not square or are built in too tightly. Contact builder or installer to make appliance accessible.

Carpet interferes with range. Provide sufficient space so range can be lifted over carpet.

Surface element too hot or not hot enough.

Incorrect control setting. Make sure the correct control is on for the surface element to be used.

Lightweight or warped pans used. Use only flat, evenly balanced, medium or heavyweight cookware. Flat pans heat better than warped pans. Cookware materials and weight of the material affect heating. Heavy- and medium-weight pans heat evenly. Because lightweight pans heat unevenly, foods may burn easily.

Surface element does not heat.

No power to the appliance. Check steps under "Entire Appliance Does Not Operate" in this **Avoid Service Checklist**.

Incorrect control setting. Make sure the correct control is on for the surface element to be used.

Element not making contact in block. Follow instructions under "Surface Elements and Drip Bowls" in the **General Cleaning** section.

Entire appliance does not operate.

Make sure cord/plug is plugged tightly into outlet.

Service wiring is not complete. Contact your dealer, installing agent or authorized servicer.

Power outage. Check house lights to be sure. Call your local electric company for service.

Cooktop and/or oven light (some models) does not work.

Replace or tighten bulb. See **Changing Cooktop and/or Oven Lights (some models)** in this Owner's Guide for instructions.

Oven smokes excessively during broiling.

Control(s) not set properly. Follow instructions under **Setting Oven Controls**.

Make sure oven door is opened to **broil stop position**.

Meat too close to the element. Reposition the rack to provide proper clearance between the meat and the element. Preheat broil element for searing.

Meat not properly prepared. Remove excess fat from meat. Cut remaining fatty edges to prevent curling, but do not cut into lean.

Grid on broiler pan wrong side up and grease not draining. Always place grid on the broiler pan with ribs up and slots down to allow grease to drip into pan.

Grease has built up on oven surfaces. Regular cleaning is necessary when broiling frequently. Old grease or food spatters cause excessive smoking.

Drip bowls are pitting or rusting.	Foods with acids, such as tomatoes, if allowed to stand in/on bowls will cause corrosion. Remove and wash drip bowls as soon as possible after a spillover Normal environment. Houses along sea coast are exposed to salt air. Protect bowls as much as possible from direct exposure to salt air.
Drip bowls turning color or distorted.	Bottom surface of cookware extends beyond surface elements and touches cooktop surface. This can cause high enough temperatures to discolor the drip bowls. DO NOT use cookware of this type. Pan sizes should be matched to the size of the element. Replacement drip bowls may be purchased from your dealer.
Oven control beeps continuously with no indicator lights flashing. (If model is equipped with a display, F1 or F3 will show.)	This oven is equipped with a state of the art electronic oven controller. Among its many features is a full time oven circuit diagnostics system. The controller constantly monitors its internal circuitry as well as several crucial oven circuits to insure they are all operating correctly. If at any time one of these systems fails, the controller will immediately stop operation, and beep continuously (flashing an error code of F1 or F3 in the display window, if equipped). Electronic control has detected a fault condition. Push CANCEL to clear the display and stop the beeping. Reprogram oven. If fault recurs, record fault number, push CANCEL and contact an authorized servicer.
Poor baking results.	Many factors affect baking results. Make sure the proper rack position is used. Center food in the oven and space pans to allow air to circulate. Allow the oven to preheat to the set temperature before placing food in the oven. Try adjusting the recipe's recommended temperature or baking time. If you feel the oven is too hot or cool, see Adjusting Oven Temperature in this Owner's Guide.
Self-cleaning cycle does not work.	Control(s) not set properly. Follow instructions under Oven Cleaning . Self-cleaning cycle was interrupted. Follow steps under "Stopping or Interrupting a Self-Cleaning Cycle" under Oven Cleaning .
Soil not completely removed after self-cleaning cycle.	Failure to clean bottom, front top of oven, frame of oven or door area outside oven seal. These areas are not in the self-cleaning area, but get hot enough to burn on residue. Clean these areas before the self-cleaning cycle is started. Burned-on residue can be cleaned with a stiff nylon brush and water or a nylon scrubber. Be careful not to damage the oven gasket.
Flames inside oven or smoking from vent.	Excessive spillovers in oven. Set self-clean cycle for a longer cleaning time. Excessive spillovers in oven. This is normal, especially for high oven temperatures, pie spillovers or large amounts of grease on bottom of oven. Wipe up excessive spillovers before starting cycle. If flames or excessive smoke are present, stop the self-clean cycle and follow steps under "Stopping or Interrupting a Self-Cleaning Cycle" in the Oven Cleaning section.
Drip bowls are pitting or rusting.	Foods with acids, such as tomatoes, if allowed to stand in/on bowls will cause corrosion. Remove and wash drip bowls as soon as possible after a spillover Normal environment. Houses along sea coast are exposed to salt air. Protect bowls as much as possible from direct exposure to salt air.
Drip bowls turning color or distorted.	Bottom surface of cookware extends beyond surface elements and touches cooktop surface. This can cause high enough temperatures to discolor the drip bowls. DO NOT use cookware of this type. Pan sizes should be matched to the size of the element. Replacement drip bowls may be purchased from your dealer.

RANGE WARRANTY

Your range is protected by this warranty

	WARRANTY PERIOD	THROUGH OUR AUTHORIZED SERVICERS, WE WILL:	THE CONSUMER WILL BE RESPONSIBLE FOR:
FULL ONE-YEAR WARRANTY	One year from original purchase date.	Pay all costs for repairing or replacing any parts of this appliance which prove to be defective in materials or workmanship.	Costs of service calls that are listed under NORMAL RESPONSIBILITIES OF THE CONSUMER.*
LIMITED 2ND-5TH YEAR WARRANTY (Glass Smoothtop, Seal & Elements)	Second through fifth years from original purchase date.	Provide a replacement for any defective surface heating element, deteriorated rubberized-silicone seal (upswept models only), or glass smoothtop that cracks due to thermal breakage (not customer abuse).	Diagnostic costs and any transportation and labor costs which are required because of service.
LIMITED WARRANTY (Applicable to the State of Alaska)	Time periods listed above.	All of the provisions of the full and limited warranties above and the exclusions listed below apply.	Costs of the technician's travel to the home and any costs for pick up and delivery of the appliance required because of service.

In the U.S.A., your appliance is warranted by Electrolux Home Products North America, a division of White Consolidated Industries, Inc. We authorize no person to change or add to any of our obligations under this warranty. Our obligations for service and parts under this warranty must be performed by us or an authorized Electrolux Home Products North America servicer. In Canada, your appliance is warranted by WCI Canada, Inc.

***NORMAL RESPONSIBILITIES OF THE CONSUMER**

This warranty applies only to products in ordinary household use, and the consumer is responsible for the items listed below:

1. Proper use of the appliance in accordance with instructions provided with the product.
2. Proper installation by an authorized servicer in accordance with instructions provided with the appliance and in accordance with all local plumbing, electrical and/or gas codes.
3. Proper connection to a grounded power supply of sufficient voltage, replacement of blown fuses, repair of loose connections or defects in house wiring.
4. Expenses for making the appliance accessible for servicing, such as removal of trim, cupboards, shelves, etc., which are not a part of the appliance when it was shipped from the factory.
5. Damages to finish after installation.
6. Replacement of light bulbs and/or fluorescent tubes (on models with these features).

EXCLUSIONS

This warranty does not cover the following:

1. CONSEQUENTIAL OR INCIDENTAL DAMAGES SUCH AS PROPERTY DAMAGE AND INCIDENTAL EXPENSES RESULTING FROM ANY BREACH OF THIS WRITTEN OR ANY IMPLIED WARRANTY.
NOTE: Some states do not allow the exclusion or limitation of incidental or consequential damages, so this limitation or exclusion may not apply to you.
2. Service calls which do not involve malfunction or defects in workmanship or material, or for appliances not in ordinary household use. The consumer shall pay for such service calls.
3. Damages caused by services performed by servicers other than Electrolux Home Products North America or its authorized servicers; use of parts other than genuine Electrolux Home Products parts; obtained from persons other than such servicers; or external causes such as abuse, misuse, inadequate power supply or acts of God.
4. Products with original serial numbers that have been removed or altered and cannot be readily determined.

IF YOU NEED SERVICE

Keep your bill of sale, delivery slip, or some other appropriate payment record. The date on the bill establishes the warranty period should service be required. If service is performed, it is in your best interest to obtain and keep all receipts. This written warranty gives you specific legal rights. You may also have other rights that vary from state to state. Service under this warranty must be obtained by contacting Electrolux Home Products:

This warranty only applies in the 50 states of the U.S.A., Puerto Rico, and Canada. Product features or specifications as described or illustrated are subject to change without notice. All warranties are made by Electrolux Home Products North America, a division of White Consolidated Industries, Inc. In Canada, your appliance is warranted by WCI Canada, Inc.

03-U-RA-01 (rev. 01/2001)

USA
800•944•9044
 Electrolux Home Products North America
 P.O. Box 212378
 Augusta, GA 30917

Canada
866•213•9397 (English)
866•294•9911 (French)
 Electrolux Home Products North America
 6150 McLaughlin Road
 Mississauga, Ontario, Canada
 L5R 4C2