

Use & Care Manual

Electric Range

Drop-in / Slide-in Models

CONTENTS

Page

Product Registration	2
Important Safety Instructions	3-5
Selecting Surface Cooking Utensils	5
Specialty Pans & Trivets	6
Canning Tips & Information	6
Setting Surface Controls	7
Ceramic Glass Cooktop	7-9
Before Setting Oven Controls	9
Setting Oven Controls	9
Before Setting Warmer Drawer Controls	10
Setting Warmer Drawer Controls	10-11
Convection Cooking	11
Convection Roasting	11
Oven Baking	12
Air Circulation in the Oven	12
Broiling	13
General Cleaning	14-21
Changing Oven Light	21
Avoid Service Checklist	22-25
Notes	26-27
Warranty	28

Visit the Frigidaire Web Site at:
<http://www.frigidaire.com>

Product Registration

Register Your Product

The self-addressed **PRODUCT REGISTRATION CARD** should be filled in completely, signed and returned to Electrolux Home Products North America.

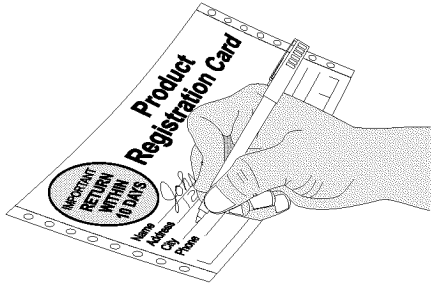

Versión en español

Si desea obtener una copia en español de este Manual del Usuario, sírvase escribir a la dirección que se incluye a continuación. Solicite la P/N **318204006**.

Spanish Owner's Guides
Electrolux Home Products North America
Consumer Relations
P.O. Box 212378
Augusta, Georgia
30917-2378

Thank you for choosing this appliance. The information contained within this **Owner's Guide** will instruct you on how to properly operate and care for your range. Please read through the information contained in your literature pack to learn more about your new appliance.

Record Your Model and Serial Numbers

Record in the space provided below the model and serial numbers. The numbers are found on the serial plate located at the left of the range frame and are visible when the oven door is open or on the inside of the drawer along the side of the frame.

Model Number: _____

Serial Number: _____

Date of Purchase: _____

This Owner's Guide contains general operating instructions for your range and feature information for several models. Your range **may not** have all the described features. The graphics shown are representational. The graphics on your range may not look exactly like those shown.

Note: The instructions appearing in this Owner's Guide are not meant to cover every possible condition and situation that may occur. Common sense and caution must be practiced when installing, operating and maintaining any appliance.

Important: Keep a copy of your bill of sale. The date on the bill establishes the warranty period service be required. Place it where it can be easily retrieved. If service is performed while the appliance is under warranty, you may have to show your bill of sale.

SLIDE-IN MODELS ONLY	
	<p>⚠ WARNING</p> <ul style="list-style-type: none"> • All ranges can tip. • Injury to persons could result. • Install anti-tip device packed with range. • See Installation instructions.
	<p>⚠ WARNING To reduce the risk of tipping of the range, the range must be secured by properly installed anti-tip bracket (s) provided with the range. To check if the bracket (s) is installed properly, remove the lower panel or storage drawer and verify that the anti-tip bracket (s) is engaged. Refer to the installation instructions for proper anti-tip bracket(s).</p>

DROP-IN MODELS ONLY	
	<p>⚠ WARNING</p> <ul style="list-style-type: none"> • All ranges can tip. • Injury to persons could result. • Install anti-tip device packed with range. • See Installation instructions.
	<p>⚠ WARNING To reduce the risk of tipping of the range, the range must be secured by properly installed anti-tip screws provided with the range. To check if the screws are installed properly, raise the lift-up cooktop and verify that the anti-tip screws are engaged. Refer to the installation instructions for proper anti-tip screw installation.</p>

IMPORTANT SAFETY INSTRUCTIONS

Read all instructions before using this appliance.
Save these instructions for future reference.

This guide contains important safety symbols and instructions. Please pay special attention to these symbols and follow all instructions given. Here is a brief explanation of these symbols.

⚠ WARNING This symbol will help you to situations that may cause serious bodily harm, death or property damage.

⚠ CAUTION This symbol will help you to situations that may cause bodily injury or property damage.

- **Remove all tape and packaging wrap before using the appliance. Destroy the carton and plastic bags after unpacking the appliance.** Never allow children to play with packaging material.
- **Proper Installation—Be sure your appliance is properly installed and grounded by a qualified technician in accordance in the United States with National Electrical Code ANSI/NFPA No. 70—latest edition and local code requirements, and in Canada with CSA C22.1 PART 1—latest edition and local code requirements.** Install only per installation instructions provided in the literature package for this appliance.

Ask your dealer to recommend a qualified technician and an authorized repair service. Know how to disconnect the electrical power to the range at the circuit breaker or fuse box in case of an emergency.

- **User Servicing—Do not repair or replace any part of the appliance unless specifically recommended in the manuals.** All other servicing should be done only by a qualified technician to reduce the risk of personal injury and damage to the appliance.
- **Never modify or alter the construction of a range by removing leveling legs, panels, wire covers, anti-tip brackets/screws, or any other part of the product.**

⚠ WARNING Stepping, leaning or sitting on the door or drawer of this appliance can result in serious injuries and may also cause damage to the appliance. Do not allow children to climb or play around the appliance. The weight of a child on an open door may cause the appliance to tip, resulting in serious burns or other injury. An open drawer, when hot, may cause burns.

⚠ WARNING Do not use the oven or warmer drawer (if equipped) for storage.

- **Storage in or on Appliance—Flammable materials should not be stored in an oven, near surface units or in the drawer (if equipped).** This includes paper, plastic and cloth items, such as cookbooks, plasticware and towels, as well as flammable liquids. Do not store explosives, such as aerosol cans, on or near the appliance. Flammable materials may explode and result in fire or property damage.

⚠ CAUTION Do not store items of interest to children in the cabinets above the appliance. Children climbing on the range to reach items could be seriously injured.

- **Do not leave children alone. Children should not be left alone or unattended in the area where an appliance is in use.** They should never be allowed to sit or stand on any part of the appliance.

- **DO NOT TOUCH SURFACE UNITS, AREAS NEAR THESE UNITS, OVEN HEATING ELEMENTS OR INTERIOR SURFACES OF THE OVEN OR WARMER DRAWER (if equipped).** Both surface units and oven heating elements may be hot even though they are dark in color. Areas near surface units may become hot enough to cause burns. During and after use, do not touch, or let clothing or other flammable materials touch these areas until they have had sufficient time to cool. Among these areas are the cooktop, surfaces facing the cooktop, the oven vent openings and surfaces near these openings, oven door and window.

- **Wear Proper Apparel—Loose-fitting or hanging garments should never be worn while using the appliance.** Do not let clothing or other flammable materials contact hot surfaces.

⚠ WARNING Never use your appliance for warming or heating the room.

- **Do Not Use Water or Flour on Grease Fires—Smother the fire with a pan lid, or use baking soda, a dry chemical or foam-type extinguisher.**

- **When heating fat or grease, watch it closely.** Fat or grease may catch fire if allowed to become too hot.

- **Use Only Dry Potholders—Moist or damp potholders on hot surfaces may result in burns from steam.** Do not let the potholders touch hot heating surface units or interior oven elements. Do not use a towel or other bulky cloth instead of a potholder.

- **Do Not Heat Unopened Food Containers—Build up of pressure may cause the container to burst and result in injury.**

- **Remove the oven door from any unused appliance if it is to be stored or discarded.**

- **IMPORTANT—Do not attempt to operate the oven during a power failure. If the power fails, always turn the oven off.** If the oven is not turned off and the power resumes, the oven may begin to operate again. Food left unattended could catch fire or spoil.

IMPORTANT SAFETY INSTRUCTIONS (continued)

⚠ CAUTION Electronic controllers can be damaged by cold temperatures. When you use your appliance for the first time, or if it has not been used for a long period of time, make sure that it has been exposed to a temperature above 0°C/32°F for at least 3 hours before connecting it to the power supply.

IMPORTANT INSTRUCTIONS FOR USING YOUR COOKTOP

- **Know which knob controls each surface heating unit.**
- **Use Proper Pan Size**—This appliance is equipped with one or more surface units of different sizes. Select utensils having flat bottoms large enough to cover the surface unit. The use of undersized utensils will expose a portion of the surface heating unit to direct contact and may result in ignition of clothing. Proper relationship of utensil to the surface unit will also improve efficiency.
- **Utensil Handles Should Be Turned Inward and Should Not Extend Over Adjacent Surface Units**—To reduce the risk of burns, ignition of flammable materials, and spillage due to unintentional contact with the utensil. The handle of the utensil should be positioned so that it is turned inward, and does not extend over adjacent surface unit.
- **Never Leave Surface Units Unattended**—Boilovers cause smoking and greasy spillovers that may ignite, or a pan that has boiled dry may melt.
- **Protective liners**— Do not use aluminum foil to line oven bottom or any other part of the appliance. Only use aluminum foil as recommended for baking if used as a cover placed on the food. Any other use of protective liners or aluminum foil may result in a risk of electric shock or fire or a short circuit.
- **Glazed Cooking Utensils**—Only certain types of glass, glass/ceramic, ceramic, earthenware, or other glazed utensils are suitable for rangetop service without breaking due to the sudden change in temperature. Check the manufacturer's recommendations for rangetop use.
- **Do Not Use Decorative Surface Element Covers.** If an element is accidentally turned on, the decorative cover will become hot and possibly melt. Burns will occur if the hot covers are touched. Damage may also be done to the cooktop.

FOR COOKTOPS WITH COIL ELEMENTS ONLY

- **Do Not Immerse or Soak Removable Surface Heating elements**— Surface heating elements should never be immersed in water. Heating elements clean themselves during normal operation.
- **Make Sure Drip Pans or Drip Bowls Are in Place**—Absence of these pans or bowls during cooking may subject wiring or components underneath to damage.

FOR GLASS COOKTOPS ONLY

- **Do Not Clean or Operate a Broken Cooktop** —If cooktop should break, cleaning solutions and spillovers may penetrate the broken cooktop and create a risk of electric shock. Contact a qualified technician immediately.
- **Clean Cooktop Glass with Caution**—If a wet sponge or cloth is used to wipe spills on a hot cooking area, be careful to avoid a steam burn. Some cleaners can produce harmful fumes if applied to a hot surface.
- **Do Not Place Hot Cookware on cold cooktop glass.** This could cause glass to break.
- **Avoid scratching the cooktop glass with sharp objects.**

IMPORTANT INSTRUCTIONS FOR USING YOUR OVEN

- **Use Care When Opening Door or Warmer Drawer (if equipped)**—Stand to the side of the appliance when opening the door of a hot oven. Let hot air or steam escape before you remove or replace food in the oven/warmer drawer.
- **Keep Oven Vent Ducts Unobstructed.** The oven is vented at the rear of the cooktop. Touching the surfaces in this area when the oven is operating may cause severe burns. Also, do not place plastic or heat-sensitive items on or near the oven vent. These items could melt or ignite.
- **Placement of Oven/Warmer Drawer (if equipped) Racks.** Always place oven racks in desired location while oven/drawer (if equipped) is cool. Remove all utensils from the rack before removing rack. If rack must be moved while oven is hot, use extreme caution. Use potholders and grasp the rack with both hands to reposition. Do not let potholders contact the hot oven element or interior of the oven/warmer drawer (if equipped).
- **Do not use the broiler pan without its insert.** The broiler pan and grid allow dripping fat to drain and be kept away from the high heat of the broiler.
- **Do not cover the broiler or warmer drawer (if equipped) grid with aluminum foil.** Exposed fat and grease could ignite.
- **Do not touch a hot light bulb with a damp cloth.** Doing so could cause the bulb to break. Disconnect the appliance or turn off the power to the appliance before removing and replacing light bulb.

IMPORTANT SAFETY INSTRUCTIONS (continued)

IMPORTANT INSTRUCTIONS FOR CLEANING YOUR RANGE

- **Clean the range regularly to keep all parts free of grease that could catch fire.** Exhaust fan ventilation hoods and grease filters should be kept clean. Do not allow grease to accumulate. Greasy deposits in the fan could catch fire. Refer to the hood manufacturer's instructions for cleaning.
- **Cleaners/aerosols**—Always follow the manufacturer's recommended directions for use. Be aware that excess residue from cleaners and aerosols may ignite causing damage and/or injury.

SELF-CLEANING OVENS:

- **Clean in the self-cleaning cycle only the parts of the oven listed in this owner's guide.** Before self-cleaning the oven, remove the broiler pan and any utensils stored in the oven.

- **Do not clean the oven door gasket.** The door gasket is essential for a good seal. Care should be taken not to rub, damage or move the gasket.
- **Do not use oven cleaners.** No oven cleaner or oven liner protective coating of any kind should be used in or around any part of the oven.
- **Remove oven racks.** Oven racks color will change if left in the oven during a self-cleaning cycle.

⚠ CAUTION The health of some birds is extremely sensitive to the fumes given off during the self-clean cycle of any range. Move birds to another well ventilated room.

IMPORTANT SAFETY NOTICE

The California Safe Drinking Water and Toxic Enforcement Act requires the Governor of California to publish a list of substances known to the state to cause cancer, birth defects or other reproductive harm, and requires businesses to warn customers of potential exposure to such substances.

SAVE THESE INSTRUCTIONS

Selecting Surface Cooking Utensils

For best result and energy conservation, choose cooking utensils that have these characteristics:

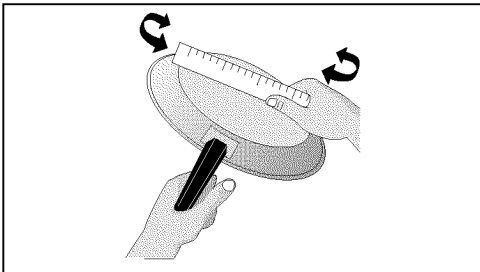

Pans should have flat bottoms that make good contact with the entire surface element. Check for flatness by rotating a ruler across the bottom. There should be no gaps between the pan and ruler.

Note: Always use a utensil for its intended purpose. Follow manufacturer's instructions. Some utensils were not made to be used in the oven or on the cooktop.

*GOOD

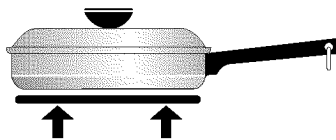

- **Flat bottom** and straight sides.
- Tight fitting lids.
- Weight of handle does not tilt pan. Pan is well balanced.
- Pan sizes match the amount of food to be prepared and the size of the surface element.
- Made of material that conducts heat well.
- Easy to clean.

* Specialty pans such as lobster pots, griddles and pressure cookers may be used but must conform to the above recommended cookware requirements.

POOR

- Curved and warped pan bottoms.
- Pan overhangs unit by more than 2.5 cm (1").
- Heavy handle tilts pan.
- Pan is smaller than element.

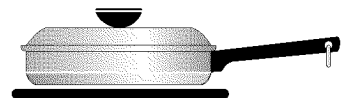
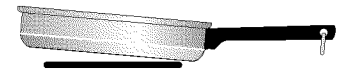
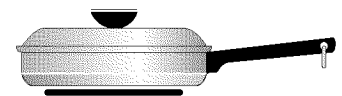
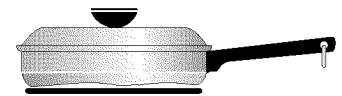

Specialty Pans & Trivets

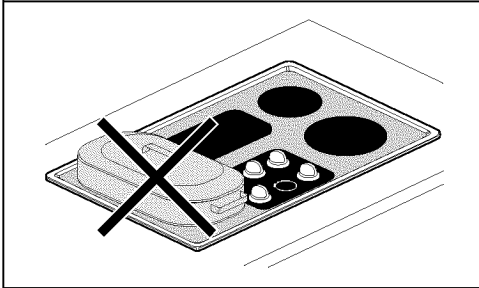
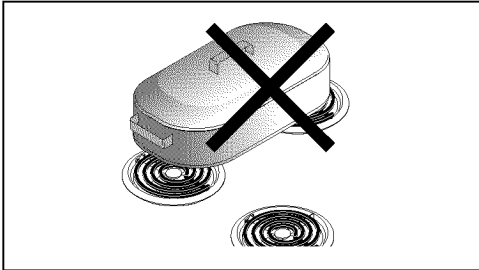

Woks with flat bottoms suitable for use on your cooktop are available in most cookshop or hardware stores. Round-bottomed woks (with a support ring that does not extend beyond the heating element) may also be used. The metal ring was designed to support the wok safely when it is filled with large amounts of liquids (soup making) or fat (frying).

⚠ CAUTION DO NOT use two elements (if the cooktop is not equipped with bridge element) to heat one large pan such as a roaster or griddle, or allow cooking utensils to boil dry. The bottom surface of the pan in either of these situations could cause discoloring or crazing of the porcelain enamel range surface, and damage to the surface elements and/or damage to the drip pans (if equipped).

Wire trivets: Do not use wire trivets. Cookware bottoms must be in direct contact with the surface elements.

DO NOT use a wok if it is equipped with a metal ring that extends beyond the surface element. Because this ring traps heat, the surface element and cooktop surface could be damaged.

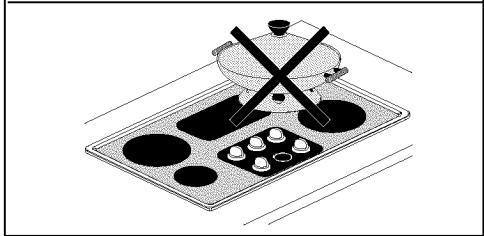
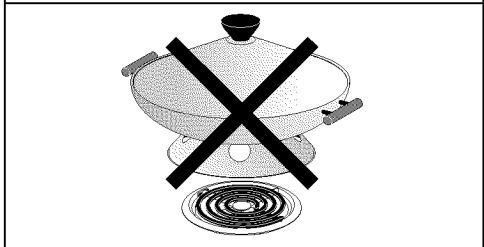

For glass smoothtop models, only flat bottomed woks (without support rings) may be used.

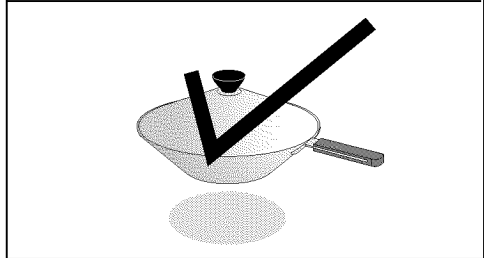

Canning Tips & Information

⚠ CAUTION Canning can generate large amounts of steam. Use extreme caution to prevent burns. Always raise the lid to vent steam away from you.

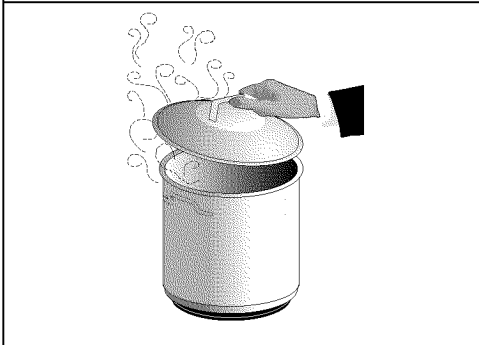

1. Use tested recipes and follow instructions carefully. Check with your local Cooperative Agricultural Extension Service or a manufacturer of glass jars for the latest canning information.
2. Use flat-bottomed canners only. Heat is spread more evenly when the bottom surface is flat.
3. Center canner on the surface element.
4. Start with hot water and a high heat setting to reduce the time it takes to bring the water to a boil; then reduce the heat setting as low as possible to maintain a constant boil.
5. It is best to can small amounts and light loads.

⚠ CAUTION Prevent damage to cooktop:

1. Do not use water bath or pressure canners that extend more than one inch beyond the edge of the surface element.
2. Do not leave water bath or pressure canners on high heat for an extended amount of time.
3. Alternate surface elements between each batch to allow the units and surrounding surfaces to cool down. Try to avoid canning on the same element all day.

⚠ CAUTION Safe canning requires that harmful micro-organisms are destroyed and the jars are sealed completely. When canning in a water bath canner, a gentle but steady boil must be maintained continuously for the required time.

Setting Surface Controls

NOTE: All knobs shown in this owner's Guide are typical only.

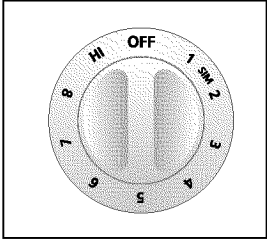

1. Place the pan on the surface element.
2. Push in and turn the surface element control knob to desired setting.
3. The surface signal light will glow when one or more elements are turned on. Always turn the element off before removing the pan.

The suggested settings found in the chart beside are based on cooking in medium-weight aluminum pans with lids. Settings may vary when using other types of pans.

Note: The size and type of utensil used, and the amount and type of food being cooked will influence the setting needed for best cooking results.

CAUTION Do not place plastic items such as salt and pepper shakers, spoon holders or plastic wrappings on top of the cooktop when it is in use. These items could melt or ignite. Potholders, towels or wood spoons could catch fire if placed too close to the element.

Setting	Type of cooking
MAX (HI)	Start most foods, bring water to a boil, pan broiling
MEDIUM (5)	Maintain a slow boil, thicken sauces and gravies, steam vegetables.
MEDIUM - LOW (2-4)	Keep food cooking, poach, stew.
MIN (1-SIM)	Keep warm, melt, simmer.

Ceramic Glass Cooktop (some models)

The ceramic-glass cooktop has electric heating coils located below the ceramic glass surface. The design of the glass cooktop outlines the area of the surface heating unit below. Most importantly, make sure the diameter of the pan matches the diameter of the surface unit. Heat is transferred up through the surface of the cooktop. Only flat-bottomed pans should be used. The type and size of the cookware, number of surface units in use and the settings of the surface units are factors that will affect the amount of heat that will spread to areas surrounding the units. The areas surrounding the units may become hot enough to cause burns. The cooktop should not be used as a cutting board or work surface. Dropping heavy or hard objects on the cooktop may crack it. Pans with rough bottoms may scratch the cooktop surface. Placing foods directly on the smoothtop surface (without cooking utensils) is not recommended as difficult cleaning will result and foods may smoke and cause a potential fire hazard. Never use the griddle or similar cooking sheet on the ceramic glass cooktop.

NOTE: Due to the high intensity of heat generated by the surface elements, the glass surface will turn green when the element will be turned off. This phenomenon is normal and the glass will come back to its original white color after it has completely cooled down. (White glass cooktops only)

Types of heating units used

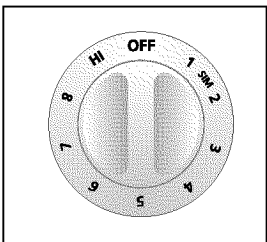

Regular Radiant Elements (some models)

The ceramic glass design shows the location of the heating surfaces.

Control knobs are used to set the heat power levels; knobs need first to be pressed in when at OFF position, then turned to the desired heat settings.

A glowing red surface unit extending beyond the bottom edge of the cooking utensil indicates the utensil is too small for the unit. The control knob does not have to be set exactly on a particular mark. Use the marks as a guide and adjust the control knob as needed. The hot surface and surface indicator lights will glow.

Note: A built-in protector will automatically turn off the radiant and expandable radiant elements if the ceramic-glass temperature exceeds the set limit.

Ceramic Glass Cooktop (some models, continued)

Types of heating units used (continued)

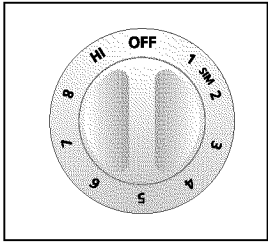

Expandable Radiant Heating Units (some models)

This heating unit combines the characteristics of a small and a large regular radiant heating unit. Its principal advantage is to allow small and large utensils to be used on the same heating unit, therefore increasing the cooktop flexibility. Heat power levels are adjusted by a special control knob that has a dual set of graduations; for small utensils use the small graduations; the inner surface only will be heating. For larger utensils use the larger graduations; the whole surface will be heating. The hot surface and surface indicator lights will glow when the heating unit is turned ON.

Note: During any heat setting of the outer radiant element, the inner radiant element cycles on and off with the outer element.

To Operate the Expandable Element

Set the rocker switch to the desired coil size. ● indicates inner coil only. ● indicates both inner and outer coils operate. You may switch from either coil setting at any time during the cooking process. Push in and turn the surface element control knob in either direction to the desired setting.

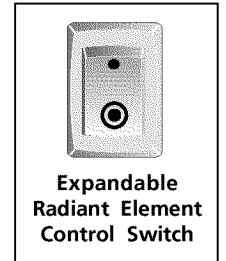

Each element provides a constant amount of heat at each setting. Start most cooking operations on a higher setting, then turn to a lower setting to finish. A glowing red element extending beyond the bottom edge of the cooking utensil indicates the utensil is too small for the element. The control knob does not have to be set exactly on a particular mark. Use the marks as a guide and adjust the control knob as needed.

Indicator Lights

There are 2 different surface control lights that will glow on your range—surface indicator lights **and** hot surface indicator lights.

- The **surface indicator lights**, located on the control panel, glow when any surface unit is turned on. A quick glance at the lights after cooking is an easy check to be sure all surface controls are turned off.
- The **hot surface indicator lights**, located under the glass cooktop, will come on as the surface cooking area heats up and will continue to glow until the glass cooktop has cooled down to a moderate level. The lights may remain on even though the controls are turned to OFF.

Setting Warm Zone Control (some models)

To Operate the warm zone

Your appliance is equipped with a warm zone. The purpose of the warm zone is to keep hot cooked foods at serving temperature. Always start with hot food. It is not recommended to heat cold food on the warm zone.

Use the warm zone to keep cooked foods hot such as: vegetables, gravies, casseroles, soups, stews, breads, pastries and oven-safe dinner

All food placed on the warm zone should be covered with a lid or aluminum foil to maintain quality. For best results, when warming pastries or breads, the cover should have an opening to allow moisture to escape. **Do not use plastic wrap to cover food. Plastic may melt onto the surface and be very difficult to clean.**

Use only dishware, utensils and cookware recommended for oven and cooktop use on the warm zone.

CAUTION Unlike the surface elements, the warm zone will not glow red when it is hot. Always use potholders or oven mitts when removing food from the warm zone as cookware and plates will not be hot.

Indicator Lights

The **Surface indicator light** is located above or below the warm zone control. It turns on when the control is set, and stays on until the control is turned off. The **hot surface indicator light**, located under the glass cooktop, will come on when the control is set and will continue to glow until the glass cooktop has cooled down to moderate level.

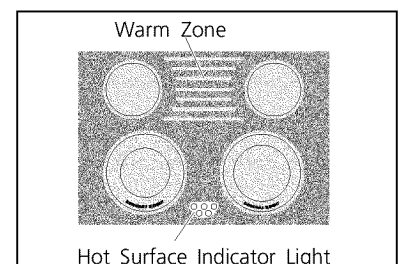

Ceramic Glass Cooktop (some models, continued)

Setting Warm Zone Control (some models, continued)

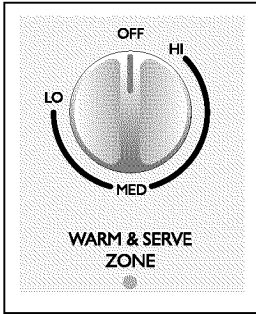

To Set the Warm Zone Control

1. To set the control, push in and turn the knob. The temperatures are approximate, and are designated by HI, MED and LO. However, the control can be set at any position between HI and LO for different levels of heating.
2. When done, turn the control to OFF. The warm zone will remain warm until the **hot surface indicator light** goes off.

Temperature Selection

Refer to the chart for recommended heating levels. If a particular food is not listed, start with the medium level, and adjust as needed. Most food can be kept at serving temperatures by using the medium level.

Warm Zone Recommended Food Settings Chart			
Food Item	Heating Level	Food Item	Heating Level
Breads/Pastries	LO	Sauces	MED
Casseroles	LO	Soups (cream)	MED
Dinner Plate with Food	LO	Stews	MED
Eggs	LO	Vegetables	MED
Gravies	LO	Fried Foods	HI
Meats	MED	Hot Beverages	HI
		Soups (liquid)	HI

Before Setting Oven Controls

Oven Vent Location

The oven is vented at the rear of the cooktop. When the oven is on, warm air is released through the vents. This venting is necessary for proper air circulation in the oven and good baking results. **DO NOT** block the vents. Doing so may cause cooking failures, fire or damage to the appliance

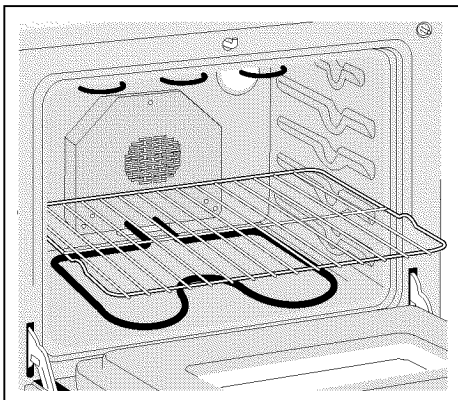

Arranging Oven Racks

ALWAYS ARRANGE OVEN RACKS WHEN THE OVEN IS COOL (PRIOR TO OPERATING THE OVEN). Always use oven mitts when using the oven.

To remove an oven rack, pull the rack forward until it stops. Lift up front of rack and slide out.

To replace an oven rack, Fit the rack onto the guides on the oven walls. Tilt the front of the rack upward and slide the rack back into place.

Setting Oven Controls

For oven settings, refer to the time or the electronic oven control section.

Before Setting Warmer Drawer Controls (some models)

Arranging Warmer Drawer Rack Positions

Set the warmer drawer rack in the vertical position as shown below:

The rack can be used in 2 ways:

- In the upright position to allow low profile food items to be placed both under and on top of the rack (for example, rolls or biscuits on top of the rack and a casserole dish under).
- In the Downward position to allow you to place light weight food items and empty dishware (for example, rolls or pastries and dinner plates).

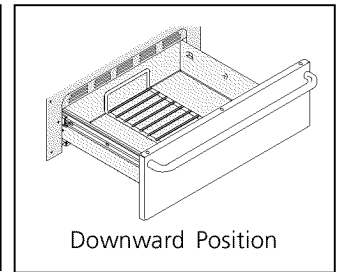
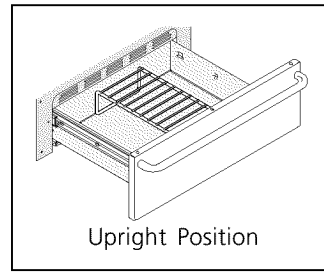

Setting Warmer Drawer Controls (some models)

Note: The warmer drawer cannot be used during an oven self-cleaning cycle. The warmer drawer is equipped with a catch which may require extra force when opening and closing the drawer.

Use the warmer drawer to keep hot foods hot such as: vegetables, gravies, meats, casseroles, biscuits and rolls, pastries and heated dinner plates.

To Operate the Warmer Drawer

The purpose of the warmer drawer is to keep hot cooked foods at serving temperature. Always start with hot food. It is not recommended to heat cold food in the warmer drawer.

All food placed in the warmer drawer should be covered with a lid or aluminum foil to maintain moisture and softness. Do not cover crisp foods. **Do not use plastic wrap to cover food. Plastic may melt onto the drawer and be very difficult to clean.**

Use only dishware, utensils and cookware recommended for oven use in the warmer drawer.

⚠ CAUTION Always use potholders or oven mitts when removing food from the warmer drawer as cookware and plates will be hot.

Indicator Light

The indicator light is located above or below the thermostat control knob. It turns on when the control is set, and stays on until the control is turned off. Make sure indicator light is off when removing food from drawer.

To Set the Thermostat Control

The thermostat control knob is used to select the temperature of the warmer drawer. It is located at the left side of the oven control. The temperatures are approximate, and are designated by HI, MED and LO. The control can be set to the three settings, or anywhere between.

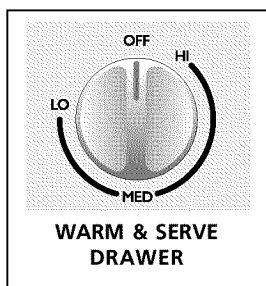

1. To set the thermostat, push in and turn the knob to the desired setting.
2. For best results, preheat the drawer before adding food. An empty drawer will reach the LO setting in about 12 minutes, the MED setting in about 15 minutes, and the HI setting in about 18 minutes.
3. When done, turn the thermostat control to OFF.

Setting Warmer Drawer Controls (some models) (continued)

Temperature Selection

Refer to the chart in the side column for recommended settings. If a particular food is not listed, start with the medium setting. If more crispness is desired, remove the lid or aluminum foil. Most foods can be kept at serving temperatures by using the medium setting. When a combination of foods are to be kept warm (for instance, a meat with 2 vegetables and rolls), use the high setting. Refrain from opening the warmer drawer while in use to eliminate loss of heat from the drawer. Open only for adding or removing food.

Warmer Drawer Recommended Food Settings Chart					
Food Item	Setting	Food Item	Setting	Food Item	Setting
Bacon	HI	Ham	MED	Potatoes (baked)	HI
Biscuits	MED	Hamburger Patties	HI	Potatoes (mashed)	MED
Casseroles	MED	Pancakes, Waffles	HI	Poultry	HI
Eggs	MED	Pastries	MED	Roast (Beef, Pork, Lamb)	MED
Empty Dinner Plate	LO	Pies	MED	Rolls, soft	LO
Fish, Seafood	MED	Pizza	HI	Rolls, hard	MED
Fried Foods	HI	Pork Chops	HI	Vegetables	MED
Gravies	MED				

Convection Cooking (some models)

NOTE: The convection fan automatically turns off when the oven door is opened while oven is in a convection mode and resumes when the door is closed again.

The convection oven uses a fan located in the rear wall of the oven to circulate heated air around the food to be cooked. The controlled air flow pattern quickly seals the food surface retaining the natural juices and flavor. This method of cooking enables you to obtain the best culinary results when baking, thawing, dehydrating and roasting foods.

Convection notes:

1. Most recipes can be made with temperatures set at 13°C (25°F) lower than temperatures required for normal radiant cooking methods. Refer to the electronic oven control operating instructions included in section "Electronic Oven Control". This can result in considerable reduction of food shrinkage and more tender meats.
2. Batch cooking is more convenient with better results.
3. Defrosting is quicker in convection mode when compared to regular radiant cooking.
4. Remember to use tested recipes with times adjusted for convection baking/roasting when using the convection mode. Times may be reduced by as much as 30% when using the convection feature.

Convection Roasting (some models)

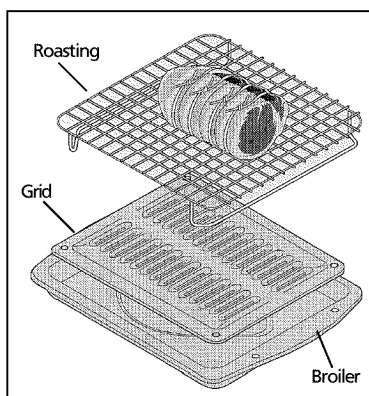



When convection roasting, use the broiler pan and grid, and the roasting rack. The broiler pan will catch grease spills and the grid will help prevent grease spatters. The roasting rack will hold the meat.

1. Place oven rack on bottom or next-bottom rack position.
2. Place the grid in the broiler pan. The roasting rack fits on the grid allowing the heated air to circulate under the food for even cooking and helps to increase browning on the underside. Make sure the roasting rack is securely seated on the grid in the broiler pan. **DO NOT** use the broiler pan without the grid or cover the grid with aluminum foil.

Oven Baking

For best cooking results, heat the oven before baking cookies, breads, cakes, pies or pastries, etc... There is no need to preheat the oven for roasting meat or baking casseroles.

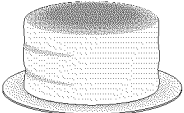
The cooking times and temperatures needed to bake a product may vary slightly from your previously owned appliance.

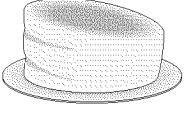
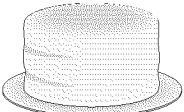
Baking Problems and Solutions Chart		
Baking Problems	Causes	Corrections
Cookies and biscuits burn on the bottom. 	<ul style="list-style-type: none"> • Cookies and biscuits put into the oven before the preheating time is completed. • Oven rack overcrowded. • Dark pan absorbs heat too fast. 	<ul style="list-style-type: none"> • Allow oven to preheat to the selected temperature before placing food in oven. • Choose pan sizes that will permit 5.1 cm to 10.2 cm (2" to 4") of air space on all sides when placed in the oven. • Use a medium-weight aluminum baking sheet.
Cakes too dark on top or bottom. 	<ul style="list-style-type: none"> • Cakes put into the oven before preheating time is completed. • Rack position too high or low. • Oven too hot. 	<ul style="list-style-type: none"> • Allow oven to preheat to the selected temperature before placing food in the oven. • Use proper rack position for baking needs. • Set oven temperature 25°F/12°C lower than recommended.
Cakes not done in the center. 	<ul style="list-style-type: none"> • Oven too hot. • Incorrect pan size. • Pan not centered in oven. 	<ul style="list-style-type: none"> • Set oven temperature 25°F/12°C lower than recommended. • Use pan size suggested in recipe. • Use proper rack position and place pan so there is 5.1 cm to 10.2 cm (2" to 4") of space on all sides of pan.
Cakes not level. 	<ul style="list-style-type: none"> • Range not level. • Pan too close to oven wall or rack overcrowded. • Pan warped. 	<ul style="list-style-type: none"> • Place a marked glass measuring cup filled with water on the center of the oven rack. If the water level is uneven, refer to the installation instructions for leveling the range. • Be sure to allow 5.1 cm to 10.2 cm (2" to 4") of clearance on all sides of each pan in the oven. • Do not use pans that are dented or warped.
Foods not done when cooking time is up. 	<ul style="list-style-type: none"> • Oven too cool. • Oven overcrowded. • Oven door opened too frequently. 	<ul style="list-style-type: none"> • Set oven temperature 25°F/12°C higher than suggested and bake for the recommended time. • Be sure to remove all pans from the oven except the ones to be used for baking. • Open oven door only after shortest recommended baking time.

Air Circulation in the Oven

For good air circulation in the oven and best baking results, center pans as much as possible. Allow 5.1 to 10.2 cm (2" to 4") around the utensil(s) for proper air circulation and be sure pans do not touch each other, the door, sides or back of oven. The hot air must circulate around the pans for even heat to reach all parts of the oven.

If using multiple pans, stagger as shown. If using one pan, place in center of oven.

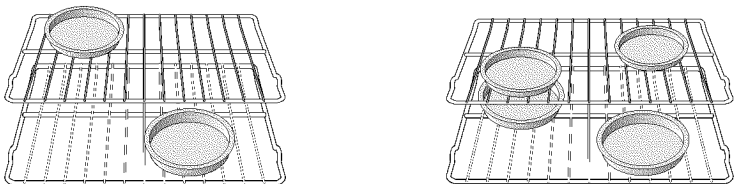

Broiling

Broiling is a method of cooking tender cuts of meat by direct heat under the broil element of the oven.

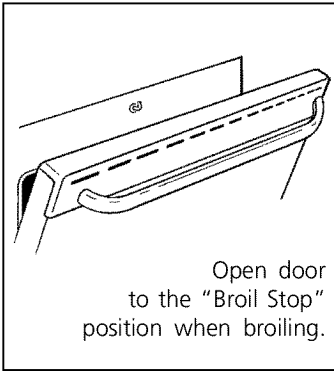

Always pull oven rack out to the "stop" position before turning or removing food.

Preheating

Preheating is suggested when searing rare steaks. (Remove the broiler pan before preheating. Foods will stick if placed on hot metal.) To preheat, set the oven control(s) to BROIL as instructed in the Owner's Guide. Wait for the element to become red-hot, usually about 2 minutes. Preheating is not necessary when broiling meats well-done.

To Broil

Broil on one side until the food is browned; turn and cook on the second side. Season and serve. Always pull rack out to the "stop" position before turning or removing food.

Determining Broiling Times

Broiling times vary, so watch the food closely. Time not only depends on the distance from the element, but on the thickness and aging of meat, fat content and doneness preferred. The first side usually requires a few minutes longer than the second. Frozen meats also require additional time.

Broiling Tips

The broiler pan and its grid allow dripping grease to drain and be kept away from the high heat of the broiler.

DO NOT use the pan without its grid. DO NOT cover the grid with foil. The exposed grease could ignite.

CAUTION Should an oven fire occur, close the oven door and turn off the oven. If the fire continues, throw baking soda on the fire or use a fire extinguisher. **DO NOT** put water or flour on the fire. Flour may be explosive.

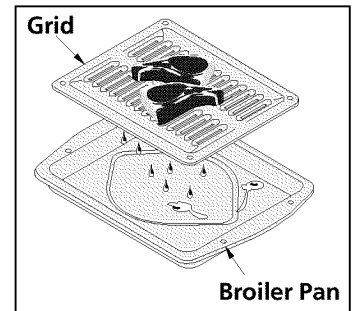

Broiler Clean-Up Tips:

- To make cleaning easier, line the bottom of the broiler pan with aluminum foil. **DO NOT** cover the broiler grid with foil.
- To prevent grease from baking on, remove the broiler pan from the oven as soon as cooking is completed. Use hot pads because the broiler pan is extremely hot. Pour off grease. Soak the pan in **HOT**, soapy water.
- Clean the broiler pan as soon as possible after each use. If necessary, use soap-filled steel wool pads. Heavy scouring may scratch the grid.

General Cleaning

Cleaning Various Parts of Your Range

Before cleaning any part of the range, be sure all controls are turned OFF and the range is COOL. REMOVE SPILLOVERS AND HEAVY SOILING AS SOON AS POSSIBLE. REGULAR CLEANING WILL REDUCE THE NUMBER OF MAJOR CLEANING LATER.

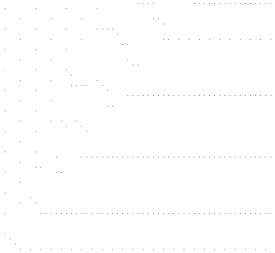
Surfaces	How to Clean
<p>Aluminum & Vinyl Control Panel and Trim Pieces</p> 	<p>Use hot, soapy water and a cloth. Dry with a clean cloth.</p> <p><i>Before cleaning the control panel</i>, turn all controls to OFF and remove the control knobs. To remove, pull each knob straight off the shaft. Clean using hot, soapy water and a dishcloth. Rinse with a clean water and a dishcloth. Cover stubborn spots with an ammonia-soaked paper towel for 30 to 40 minutes. Rinse. Be sure to squeeze excess water from the cloth before wiping the panel; especially when wiping around the controls. Excess water in or around the controls may cause damage to the appliance. Be sure to rinse the cleaners as bluish stains may occur during heating and cannot be removed. To replace knobs after cleaning, line up the flat sides of both the knob and the shaft; then push the knob into place.</p>
<p>Glass, Painted and Plastic Control Knobs, Body Parts, and Decorative Trim</p>	<p><i>For general cleaning</i>, use hot, soapy water and a cloth. <i>For more difficult soils and built-up grease</i>, apply a liquid detergent directly onto the soil. Leave on soil for 30 to 60 minutes. Rinse with a damp cloth and dry. DO NOT use abrasive cleaners on any of these materials; they can scratch. To remove control knobs, turn to the OFF position; grasp firmly and pull straight off the shaft. To replace knobs after cleaning, line up the flat sides of both the knob and the shaft; then push the knob into place.</p>
<p>Stainless Steel (some models) Oven Door & Drawer Front Panel</p>	<p>Cleaners made especially for stainless steel as Stainless Steel Magic, or other similar cleaners are recommended. Always follow the manufacturer's instructions. Be sure to rinse the cleaners as bluish stains may occur during heating and cannot be removed.</p>
<p>Surface Elements and Drip Bowls</p> 	<p>Surface elements can be unplugged and removed to make cleaning the drip bowls easier. The surface elements clean themselves when they are turned on. Food spilled on a hot element will burn off. Food spilled on a cold element can be cleaned with a damp cloth—any remaining soil will burn off the next time element is used. NEVER IMMERSE A SURFACE ELEMENT IN WATER. To remove surface element and drip bowls, follow the instructions under General Cleaning.</p> <p>To clean drip bowls, wash in hot, soapy water or in the dishwasher. Rinse and dry while still warm. Hard-to-remove, burned-on soils can be removed by soaking the drip bowls for about 20 minute in a slightly diluted liquid cleanser or solution made of equal parts ammonia and water. A nylon scrubber may be used after soaking. DO NOT use abrasive cleanser or steel wool, as they will scratch the surface. Always rinse with clean water and polish, and dry with a soft cloth. To replace drip bowls and surface elements, follow the instructions under General Cleaning.</p>
<p>Porcelain Enamel Broiler Pan and Insert, Door Liner, Body Parts and Warmer Drawer and Drawer Cavity</p>	<p>Gentle scouring with a soapy scouring pad will remove most spots. Rinse with a 1:1 solution of clear water and ammonia. <i>If necessary</i>, cover difficult spots with an ammonia-soaked paper towel for 30 to 40 minutes. Rinse with clean water and a damp cloth, and then scrub with a soap-filled scouring pad. Rinse and wipe dry with a clean cloth. Remove all cleaners or the porcelain may become damaged during future heating. DO NOT use spray oven cleaners on the cooktop.</p>

General Cleaning (continued)

Ceramic Glass Cooktop (some models, continued)

Special Caution for Aluminum Foil and Aluminum Cooking Utensils

1) Aluminum foil

Use of aluminum foil will damage the cooktop. Do not use under any circumstances.

2) Aluminum utensils

The melting point of aluminum being much lower than that of other metals, care must be taken when aluminum pots or pans are used. If allowed to boil dry, not only will the utensil be ruined, but also permanent damage in the form of breakage, fusing or marking may affect the ceramic glass surface.

Things to Remember

1. **Do not slide utensils across cooktop surface in any circumstance, doing so may scratch or metalmark the cooktop surface.**
2. AVOID using bleach and don't use ammonia to clean the ceramic surface.
3. Do not put plastic items on warm cooking areas.
4. Never slide oven racks across cooktop surface. They may scratch or metalmark the cooktop.
5. **If cooktop should break, do not use cooktop or attempt to clean it. Call your authorized service technician immediately.**
6. Never use a trivet or metal stand between the cooking utensil and the ceramic cooktop. The ceramic surface may be scratched, metal marked or etched by such items.
7. Sugary spills can cause pitting of your cooktop surface. Therefore, you must begin cleaning the spills while the cooktop is still hot. Use caution when following the steps below.
 - a) Turn off all surface units and remove all pans immediately.
 - b) Wearing an oven mitt, use a razor blade scraper to scrape the hot spill out of the cooking zone to a cooler area on the cooktop.
 - c) Allow the cooktop to cool.

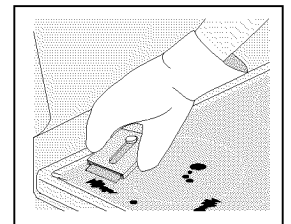
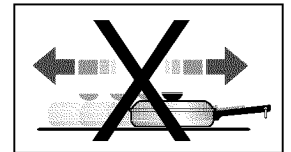

Use and Care of Glass Surface

Problem	Cause	To Prevent	To Remove
Fine "brown lines" (tiny scratches or abrasions which have collected soil).	Coarse particles (salt, sand, sugar or grit) between bottom of cookware and cooktop that are not removed before cooking. Using incorrect cleaning materials.	Clean cooktop after every use. Daily use of cleaner cream.	Tiny scratches are not removable. They can be minimized by continual use of cleaner cream. Such scratches do not affect cooking.
Metal marking (mark or black marks).	Sliding or scraoing metal utensils or oven shelves across cooktop.	Do not slide cookware across cooktop.	Apply cleaner cream with dampened paper towel to cooled surface.
Brown streaks and specks.	Cleaning with a sponge or dishcloth that has been used fot other tasks.	Use cleaner cream with clean, damp paper towel.	Use a small amount of cleaner cream with clean, damp paper towel.

NOTE: Due to the high intensity of heat generated by the surface elements, the glass surface will turn green when the element will be turned off. This phenomenon is normal and the glass will come back to its original white color after it has completely cooled down. (White glass cooktops only).

General Cleaning (continued)

Ceramic Glass Cooktop (some models, continued)

Use and Care of Glass Surface (continued)

Cleaning Materials for Ceramic Glass Cooktop

Some cleaning materials may contain an ingredient which can damage the cooktop. Use recommended materials only (see below). Cleaner cream should be used regularly. First use recommended products listed below, then use cleaner cream.

Use only recommended cleaning products and follow these basic cleaning suggestions.

1. BEFORE THE COOKTOP IS USED. Thoroughly clean and saturate the cooktop with cleaner cream.
 - a) Dampen clean paper towel and clean unit.
 - b) Wipe off with another clean, damp paper towel; then wipe dry.
2. For normal daily cleaning, apply a dab of cleaner cream in the center of each unit-area to be cleaned. Start with approximately 1/8 teaspoon. (Apply more if needed). Then, proceed as stated above in (a and b).
3. Make sure bottom of cookware and cooking area are clean and dry.
4. Select heat settings and cookware large enough for food and liquid. This stops boilovers and splatterings.
5. Wipe up food spills and spatters before they burn into surface.

IMPORTANT Regularly use cleaner cream. If you run out of cleaner cream, use one of the cleansers listed. Be sure to get a new supply of cleaner cream.

CAUTION Never mix cleaning products! Mixtures may interact, with damaging or hazardous results.

Do Use on Ceramic Glass Cooktop

1. Baking soda.
2. Non-impregnated plastic and nylon pads.
3. For burned on material, scrape with single-edged razor blade, held at a 30° angle.
4. Ceramic glass cleaning cream.

Do not Use on Ceramic Glass Cooktop

1. Avoid pads, that can leave marks and scratches.
2. Avoid heavy-duty cleansing powders, these can scratch, depending on their abrasiveness and cleaning pressure applied.
3. Avoid chemical oven cleaners. These can etch the cooktop surface and are caustic.
4. Avoid rust stain removers containing hydrofluoric acid.
5. Avoid using bleach and don't use ammonia.

Special Cleaning Instructions for Mineral Deposits and Discolorations

Problem: A gray brown stain that is not removed when using cleaner cream.

Cause: Condensation, when cooking, often collects and drips from cookware. The minerals found in water supply and foods may cause a gray or brown film to develop on cooktop. This film is so thin it cannot be felt and appears to be under cooktop.

To Prevent: Daily and proper use of cleaner cream.

To Remove:

- Wet surface with water and sprinkle on cleaner cream.
- Scrub with clean, damp paper towel until stain disappears.
- Clean remaining paste away with damp paper towel.
- Apply dab of cleaner cream and polish with a clean paper towel.

WARNING

- Do not use cleansers on a heated surface. Fumes could be hazardous. Wait for area to cool before cleaning.
- Do not use cleaner cream to clean porcelain, paint or aluminium.

General Cleaning (continued)

Coil Surface Element (some models)

CAUTION Be careful not to bend terminal ends when replacing elements after cleaning.

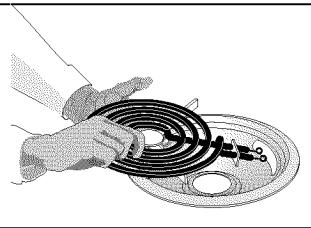

To Remove and Replace Surface Elements and Drip Bowls (some models)

ATTENTION: Never leave covers on the coil elements as they could be permanently damaged if the coil is turned on by accident.

Prior to cleaning the coil elements make sure they are cold and that control knobs are turned to OFF

Coil elements clean themselves when they are turned on.

Coil elements and drip bowls are removable and allow to clean the drip bowls.

To remove a coil element, push against the front edge and lift element up and out.

To clean by hand, wash the drip bowls in hot sudsy water. For hard to remove spots, use nylon scrubber with soap. Rinse and dry will still warm.

CAUTION Never immerse coil elements in water.

SURFACES	CLEANING AGENTS	INSTRUCTIONS
Porcelain enamel (cooktop, surface under cooktop)	Mild cleaners or soap-filled steel wool pads.	Use a damp sponge or dampened soap pad, rinse and dry.
Insert - Control Panel	Hot, soapy water or cleaner cream.	Use a clean soapy, dampened cloth or paper towel, remove soil and dry. Do not use abrasive products.

Porcelain enamel cooktop cleaning instructions (some models)

WARNING Do not use a cooktop cleaner on a hot cooktop. The fumes can be hazardous to your health, and can chemically damage the cooking surface.

CAUTION Before cleaning the surface cooktop, be sure the controls are turned to OFF and the cooktop is cool.

CAUTION DO NOT use commercial oven cleaners on the exterior surfaces including rangetop and door frame.

Correct and consistent cleaning is essential to maintaining your porcelain enamel cooktop. If food spills and grease spatters are not removed, they may burn onto the surface of the cooktop and cause permanent discoloration.

Daily Cleaning

For normal soil:

1. Allow cooktop surface to cool.
2. Wipe off spills and spatters using a clean paper towel or a clean cloth with warm, soapy water.
3. If needed, use a soapy steel wool pad or other mild household cleaners.
4. Be sure to rinse off the cleaners or the porcelain may become damaged during future heating.

For heavy, burned-on soil:

1. Allow cooktop surface to cool.
2. Use a soap filled scouring pad with warm water or cover heavily soiled spots with a solution of clear water and ammonia. Scour gently. Rinse and wipe dry with a clean cloth.
3. If any soil remains, apply a few drops of a recommended cooktop cleaning cream on the spots and rub gently using a clean damp cloth or scouring pad. Buff with a dry cloth until all soil and cream are removed. Frequent cleaning with the cooktop cleaning cream leaves a protective coating which helps in preventing scratches and abrasions.

For sugary spillovers:

Sugary spills can chemically damage your cooktop surface. Therefore, you must begin cleaning the spills while the cooktop is still hot. Use caution when following the steps below.

1. Turn off all surface units and remove all pans immediately.
2. Wearing an oven mitt, wipe up carefully or move hot spills away from the element area with a clean damp cloth.
3. Allow the cooktop to cool. Follow the instructions above for heavy, burned-on soil.

COOKTOP CLEANING / POLISHING CREAM can be purchased through authorized service centers or major department stores.

General Cleaning (continued)

To Raise the Top for Cleaning (some models)

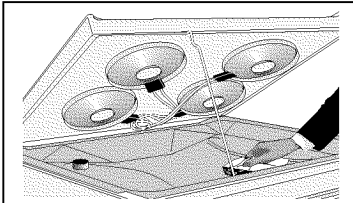

A rod swings up to support the top for cleaning underneath.

1. Grasp the sides and lift from the front. A lift-up rod will support the top in its raised position. Only lift the top high enough to allow the support rod to rest in place under the front of the cooktop.
2. Clean underneath using a clean cloth and hot, soapy water.
3. To lower the top, lift the top slightly and lower the rod. Lower the range top down into the range frame.

When lowering the lift-up range top, grasp the sides with fingertips only. Be careful not to pinch fingers. **DO NOT** drop or bend the range top when raising or lowering. This could damage the surface.

Cleaning the Regular Oven (non self-clean oven, some models)

Make sure the oven is cool and that all control knobs are at OFF position. Cleaning the oven is a lot easier when the door is removed.

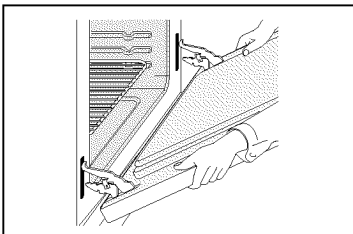

1. Remove the oven door; see under To Remove and Replace the Oven Door in this Owner's Guide.
2. Empty the oven including the racks.
3. You can wash the broiler pan, grid and racks in the kitchen sink.
4. Clean oven lining thoroughly with soap and a wet cloth and wipe with a dry cloth.

To remove burned-on fat on oven walls, moisten soiled parts with household ammonia, using a wet cloth. Follow suggested manufacturer's cleaning method. (Do not remove the oven door when using ammonia.)

Complete cleaning with a damp cloth and use a fine steel wool scouring agent if necessary.

The lower element can be moved up for cleaning purposes.

5. Replace racks in the oven. Reinstall oven door.

Cleaning the Self-Clean Oven (some models)

Adhere to the following cleaning precautions:

- Allow the oven to cool before cleaning.
- Wear rubber gloves when cleaning any exterior parts of the oven manually.

CAUTION During the self-clean cycle, the outside of the wall oven can become very hot to the touch. DO NOT leave small children unattended near the appliance.

CAUTION The health of some birds is extremely sensitive to the fumes given off during the self-cleaning cycle of any range. Move birds to another well ventilated room.

CAUTION Before cleaning any part of the oven, be sure the electronic oven control is turned off or else push CANCEL pad. Wait until the oven is cool.

DO NOT use commercial oven cleaners or oven protective coatings in or around any part of the self-cleaning oven. DO NOT clean the oven door gasket. The gasket on the oven door is essential for a good seal. Care should be taken not to rub, damage or move the gasket. DO NOT cooking or foil could melt and damage the oven surface.

A self-cleaning oven cleans itself with high temperatures (well above cooking temperatures) which eliminate soil completely or reduce it to a fine powdered ash you can wipe away with damp cloth.

General cleaning (continued)

Cleaning the Self-Clean Oven (some models, continued)

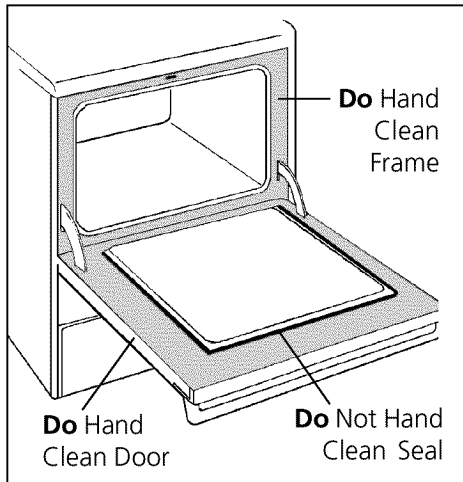

Preparing the Oven for Self-Cleaning

1. Remove all excess spillovers in the oven cavity before starting the self-cleaning cycle. To clean, use hot soapy water and a cloth. Large spillovers can cause heavy smoke or fire when subjected to high temperatures. DO NOT allow food spills with a high sugar or acid content (such as tomatoes, sauerkraut, fruit juices or pie filling) to remain on the surface as they may cause a dull spot even after cleaning.
2. Clean any soil from the oven frame and the door liner (see illustration). These areas heat sufficiently during self-cleaning cycle to burn soil on. Clean with soap and water.
3. Remove the broiler pan and insert, all utensils and any foil. These items do not withstand high cleaning temperatures
4. Oven racks may be left in the oven or may be removed. If they go through the clean cycle, their color will turn slightly dull. After the cycle is completed and the oven has cooled, rub the sides of the racks with wax paper or a cloth containing a small amount of baby oil or salad oil. This will make the racks glide easier.

What to Expect During Cleaning

While the oven is in operation, the oven heats to temperatures much higher than those used in normal cooking. Sounds of metal expansion and contraction are normal. Odor is also normal as the food soil is being removed. Smoke may appear through the oven vent, located on the top of the control panel.

If heavy spillovers are not wiped up before cleaning, they may flame and cause more smoke and odor than usual. This is normal and safe and should not cause alarm. If available, use an exhaust fan during the self-cleaning cycle.

NOTE: A smoke eliminator in the oven vent converts most of the soil into a colorless vapor.

Setting the Controls for Self-Clean Cycle

For the setting of the clean cycle, refer to Timer or Electronic Oven Control section.

To Remove and Replace Oven Door

1. Open the door to the fully opened position.
2. Pull up the lock located on both hinge supports and engage it in the hook of the hinge levers. You may have to apply a little downward pressure on the door to pull the locks fully over the hooks.
3. Grab the door by the sides, pull the bottom of the door up and toward you to disengage the hinge supports. Keep pulling the bottom of the door toward you while rotating the top of the door toward the range to completely disengage the hinge levers.
4. Proceed in reverse to reinstall the door.

Make sure the hinge supports are fully engaged before unlocking the hinge levers.

CAUTION The door is heavy. For safe, temporary storage, lay the door flat with the inside of the door facing down.

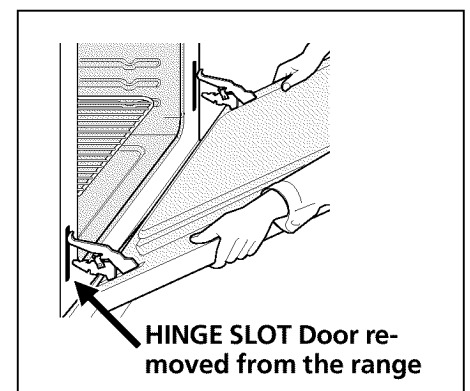
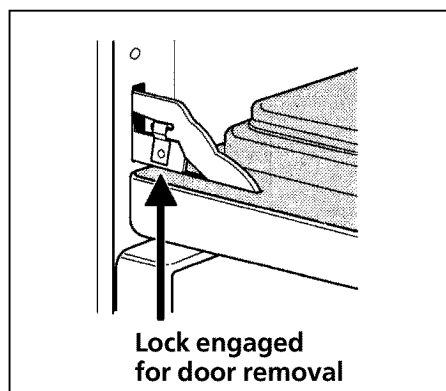
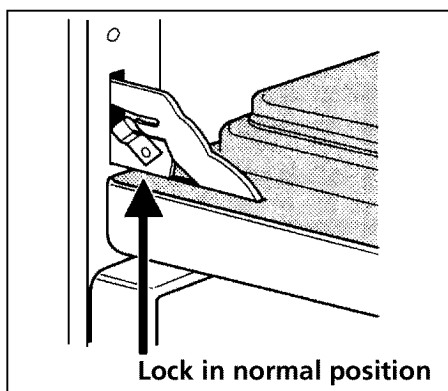

General Cleaning (continued)

Removable Outer Door Glass Panel (some models)

Applicable only to models with an external glass panel not held with a frame. This design allows you to clean the inside face of the exterior door panel as well as the hidden face of the door inner glass. There are two different kinds of glass panel; one with a lower metal trim fixed on the underside of the glass panel and the other one with a lower metal support rail.

To remove the external door glass panel:

1. Pull the door off the range as per instructions under **"To Remove and Replace Oven Door"** in "Cleaning the Appliance" section and lay the door flat.
2. Using a screwdriver, remove the screws fastening the glass lower metal trim or the glass assembly.
3. Grab both sides of the glass panel and slowly pull it out of the door upper moulding. Lay the glass flat.

CAUTION Handle the glass panel with care. When dropped on a corner the glass panel may shatter in multiple fragments and you could get hurt.

CAUTION DO NOT remove the lower metal trim, which is fixed on the underside of the glass panel.

To replace the external door panel:

1. Grab the sides of the glass panel and carefully insert the glass into the door top moulding.
2. Replace the glass lower trim or the glass assembly using the locking screws.
3. Replace the door onto the range as per **"To Remove and Replace Oven Door"** in "Cleaning the Appliance" section.

To Remove and Replace Warmer Drawer (some models)

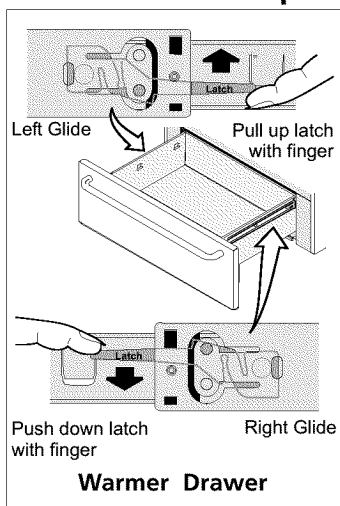

To remove Warmer Drawer

1. Turn power off before removing the warmer drawer.
2. Open the drawer to the fully opened position.
3. Locate the latches on both sides of the warmer drawer.
4. Pull up on the left glide latch and push down on the right glide latch.
5. Pull the drawer away from the range.
6. To clean warmer drawer, gently scour with a soapy scouring pad, this will remove most spots. Rinse with a 1:1 solution of clear water and ammonia. If necessary, cover difficult spots with an ammonia-soaked paper towel for 30 to 40 minutes. Rinse with clean water and a damp cloth. Remove all cleaners or the porcelain may become damaged during future heating. DO NOT use spray oven cleaners on the cooktop.

To Replace Warmer Drawer:

1. Align the glide latches on both sides of the drawer with the slots on the drawer.
2. Push the drawer back into the range.



WARNING Electrical Shock Hazard can occur and result in serious injury or death. Disconnect appliance from electric power before cleaning and servicing the warmer drawer.

General Cleaning (continued)

Storage Drawer (some models)

Use the storage drawer for storing cooking utensils. The drawer can be removed to facilitate cleaning under the range. Use care when handling the drawer.

To open the storage drawer, push the drawer in gently and it will spring open. To close, push the drawer until you hear a click, which indicates that the spring is compressed, and the drawer is closed.

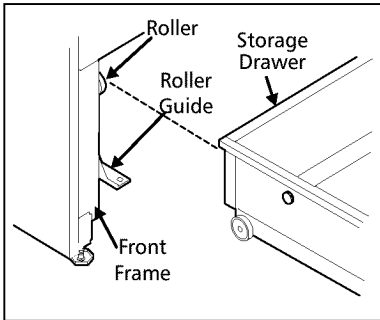

To remove the drawer:

1. Pull empty drawer out to the roller guide stop.
2. Tilt the drawer up and pull it out over the rollers.

To replace the drawer:

1. Insert the rear end of the drawer into the opening.
2. Fit the drawer end rollers onto the guide rails.
3. Push the drawer in until it stops, then lift to allow the rollers to clear the roller guide stop, and push in.

Changing Oven Light

CAUTION Be sure the oven is unplugged and all parts are COOL before replacing the oven light bulb. Do not turn the oven light on during the self-cleaning cycle. High temperature will reduce lamp life.

On some models an interior oven light will turn on automatically when the oven door is opened.

The oven light may be turned on when the door is closed by using the oven light switch located on the control panel.

On a self clean oven the lamp is covered with a glass shield held in place by a wire holder.

THIS GLASS SHIELD MUST BE IN PLACE WHENEVER THE OVEN IS IN USE.

To replace the light bulb:

CAUTION: BE SURE OVEN IS COOL

1. Turn the power off at the main source.
2. Wear a leather-faced glove for protection against possible broken glass.
3. Replace bulb with a 40 watt appliance bulb only.
4. For self-cleaning oven, press wire holder to one side to release glass shield, change bulb and be sure to replace glass shield.

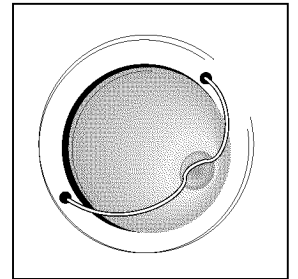

Avoid Service Checklist

Before you call for service - read this

You may save the cost and inconvenience of an unnecessary service call by first reviewing this easy to use Avoid-Service Check List of the most frequently encountered situations that are not the result of defective workmanship of materials.

You will be charged for a service call while the appliance is in warranty if the problem is not caused by defective product workmanship or materials.

Your new appliance is a carefully engineered product. Many times, what appears to be a reason to call for service requires nothing more than a simple adjustment you can easily make in your own home or is normal operating characteristic of appliance under certain conditions.

This list is applicable to a variety of models; some of the items will not necessarily apply to your appliance.

PROBLEM

POSSIBLE CAUSE/SOLUTION

INSTALLATION

Range is not level.

Poor installation. Place oven rack in center of oven. Adjust leveling legs (slide-in models) at base of range until the oven rack is level.

Be sure floor is level and is strong and stable enough to adequately support range.

If floor is sagging or sloping, contact a carpenter to correct the situation.

Kitchen cabinet alignment may make range appear unlevel. Be sure cabinets are square and have sufficient room for range clearance.

Cannot move appliance easily. Appliance must be accessible for service.

Cabinets not square or are built in too tightly. Contact builder or installer to make appliance accessible.

Carpet interferes with range. Provide sufficient space so range can be lifted over carpet.

RANGE DOES NOT OPERATE

Entire range or oven does not operate.

Make sure cord/plug is plugged tightly into outlet .

Service wiring is not complete. Contact your dealer, installing agent or authorized servicer.

Power outage. Check house lights to be sure. Call your local electric company for service.

Oven does not operate.

Oven control beeps and displays -F1-, -F3- or -F9-. Electronic control has detected a fault condition. Push the **CANCEL pad** to clear the display and stop the beeping. Reprogram oven. If fault recurs, record fault number, push **CANCEL pad** and contact authorized servicer.

Oven light does not work.

Replace or tighten bulb. See **Changing Oven Light** in this Owner's Guide for instructions.

Surface unit does not heat.

No power to the appliance. Check steps under "Entire Appliance Does Not Operate" in this **Avoid Service Checklist**.

Incorrect control setting. Make sure the correct control is on for the surface unit to be used.

Avoid Service Checklist (continued)

PROBLEM	POSSIBLE CAUSE/SOLUTION
<i>SURFACE UNITS</i>	
Surface units too hot or not hot enough.	<p>Incorrect control setting. Make sure the correct control is on for the surface unit to be used.</p> <p>Lightweight or warped pans used. Use only flat, evenly balanced, medium or heavyweight cookware. Flat pans heat better than warped pans. Cookware materials and weight of the material affect heating. Heavy- and medium-weight pans heat evenly. Because lightweight pans heat unevenly, foods may burn easily.</p>
Drip bowls are pitting or rusting.	<p>Foods with acids, such as tomatoes, if allowed to stand in/on bowls will cause corrosion. Remove and wash drip bowls as soon as possible after spillover.</p> <p>Normal environment. Houses along sea coast are exposed to salt air. Protect bowls as much as possible from direct exposure to salt air.</p>
Drip bowls turning color or distorted out of shape.	Bottom surface of cookware extends beyond surface elements and touches cooktop surface. This can cause high enough temperatures to discolor the drip bowls. DO NOT use cookware of this type. Pan sizes should be matched to the size of the element. Replacement drip bowls may be purchased from your dealer.
<i>CERAMIC GLASS COOKTOP (some models)</i>	
Scratches or abrasions on cooktop surface.	<p>Coarse particles such as salt or sand between cooktop and utensils can cause scratches. Be sure cooktop surface and bottoms of utensils are clean before usage. Small scratches do not affect cooking and will become less visible with time.</p> <p>Cleaning materials not recommended for ceramic-glass cooktop have been used. See "Ceramic-Glass Cooktop Cleaning" in the General Cleaning section.</p> <p>Cookware with rough bottom has been used. Use smooth, flat-bottomed cookware.</p>
Metal marks.	Sliding or scraping of metal utensils on cooktop surface. Do not slide metal utensils on cooktop surface. Use a ceramic-glass cooktop cleaning creme to remove the marks. See "Ceramic-Glass Cooktop Cleaning" in the General Cleaning section.
Brown streaks or specks.	Boilovers are cooked onto surface. Use razor blade scraper to remove soil. See "Ceramic-Glass Cooktop Cleaning" in the General Cleaning section.
Areas of discoloration with metallic sheen.	Mineral deposits from water and food. Remove using a ceramic-glass cooktop cleaning creme. Use cookware with clean, dry bottoms.

Avoid Service Checklist (continued)

PROBLEM

POSSIBLE CAUSE/SOLUTION

GAS BURNERS COOKTOP (some models)

Surface burners do not light.

Surface control knob has not been completely turned to LITE. Push in and turn the surface control knob to LITE (until burner ignites) and then turn the surface control knob to the desired flame size.

Burner ports are clogged. Clean burners. See “To Clean the Burner Grates, Contoured Burner Pans, Burner Cap Assembly, Trim Ring and Burner Base” under General Cleaning. With the burner off, use small-gauge wire or needle to clean ports or slots.

Electrical power outage (Electric Ignition models only), Check house lights to be sure. Call your local electric company for service. Surface burners can be lit manually. See **Setting Surface Controls** in this Owner’s Guide.

Gas supply is turned off. Turn gas supply on.

Surface burner flame burns half way around.

Burner ports or slots are clogged. With the burner off, clean by using a small-gauge wire or needle to clean ports or slots.

Moisture is present after cleaning. Lightly fan the flame and allow the burner to operate until flame is full. Dry the burners thoroughly following instructions under **General Cleaning**.

Surface burner flame is orange.

Dust particles in main line. Allow the burner to operate a few minutes until flame turns blue.

Salt air in coastal areas. A slightly orange flame is unavoidable.

POOR BAKING RESULTS

Poor baking results.

Many factors affect baking results. Make sure the proper rack position is used. Center food in the oven and space pans to allow air to circulate. Allow the oven to preheat to the set temperature before placing food in the oven. Try adjusting the recipe’s recommended temperature or baking time. If you feel the oven is too hot or cool, see **Adjusting Oven Temperature** in the Electronic Oven Control section.

Flames inside the oven or smoking from vent .

Excessive spillovers in oven. Set self-clean cycle for a longer cleaning time.

Excessive spillovers in oven. This is normal, especially for pie spillovers or large amounts of grease on bottom of oven. Wipe up excessive spillovers before starting cycle. If flames or excessive smoke are present, stop the self-clean cycle and follow steps under “To Stop or Interrupt a Self-Cleaning Cycle” in the Electronic Oven Control section.

Avoid Service Checklist (continued)

PROBLEM	POSSIBLE CAUSE/SOLUTION
BROILING	
Oven smokes excessively during broiling.	Control(s) not set properly. Follow instructions under Setting Oven Controls in the Electronic Oven Control section. Make sure oven door is opened to broil stop position . Meat too close to the element. Reposition the rack to provide proper clearance between the meat and the element. Preheat broil element for searing. Meat not properly prepared. Remove excess fat from meat. Cut remaining fatty edges to prevent curling, but do not cut into lean. Grid on broiler pan wrong side up and grease not draining. Always place grid on the broiler pan with ribs up and slots down to allow grease to drip into pan. Grease has built up on oven surfaces. Regular cleaning is necessary when broiling frequently. Old grease or food spatters cause excessive smoking.
SELF CLEANING OVEN (some models)	
Self-cleaning cycle does not work.	Control(s) not set properly. Follow instructions under Oven Cleaning in the Electronic Oven Control section. Self-cleaning cycle was interrupted. Stop time must be set 3 to 4 hours past the start time. Follow steps under To Stop or Interrupt a Self-Cleaning Cycle in the Electronic Oven Control section
Soil not completely removed after self-cleaning cycle.	Failure to clean bottom, front top of oven, frame or door area outside oven seal. These areas are not in the self-cleaning area, but get hot enough to burn on residue. Clean these areas before the self-cleaning cycle is started. Burned-on residue can be cleaned with a stiff nylon brush and water or nylon scrubber. Be careful not to damage the oven seal.

Avoid Transportation Damage to your Range

If you have to move your range into/out of your residence or when moving to a new home, it is suggested that you take the following precautions:

1. Screw in the levelling legs under the range.
2. Remove the racks and other utensils from the oven, and from the lower drawer.
3. Use adhesive tape to firmly secure the door and the drawer to the side panels. Also attach the electric power cord in the same manner.
4. Use a two-wheeled trolley with strap and fasten the range to it. Cover the appliance with a heavy blanket to prevent scratches and dents.
5. Avoid pulling or pushing the control panel when moving the appliance.

Notes

Notes

Warranty Information

RANGE WARRANTY

Your range is protected by this warranty

	WARRANTY PERIOD	THROUGH OUR AUTHORIZED SERVICERS, WE WILL:	THE CONSUMER WILL BE RESPONSIBLE FOR:
FULL ONE-YEAR WARRANTY	One year from original purchase date	Pay all costs for repairing or replacing any parts of this appliance which prove to be defective in materials or workmanship.	Costs of service calls that are listed under NORMAL RESPONSIBILITIES OF THE CONSUMER. *
LIMITED 2ND-5TH YEAR WARRANTY (Glass Smoothtop, Seal & Elements)	Second through fifth years from original purchase date	Provide a replacement for any defective surface heating element, deteriorated rubberized-silicone seal (upswept models only), or glass smoothtop that cracks due to thermal breakage (not customer abuse).	Diagnostic and any transportation and labor costs which are required because of service.
LIMITED WARRANTY (Applicable to the State of Alaska)	Time periods listed above.	All of the provisions of the full and limited warranties above and the exclusions listed below apply.	Costs of the technician's travel to the home and any costs for pick up and delivery of the appliance required because of service.

In the U.S.A., your appliance is warranted by Electrolux Home Products North America, a division of White Consolidated Industries, Inc. We authorize no person to change or add to any of our obligations under this warranty. Our obligations for service and parts under this warranty must be performed by us or an authorized Electrolux Home Products North America servicer. **In Canada**, your appliance is warranted by Electrolux Canada Corp.

*NORMAL RESPONSIBILITIES OF THE CONSUMER

This warranty applies only to products in ordinary household use, and the consumer is responsible for the items listed below:

1. Proper use of the appliance in accordance with instructions provided with the product.
2. Proper installation by an authorized servicer in accordance with instructions provided with the appliance and in accordance with all local plumbing, electrical and/or gas codes.
3. Proper connection to a grounded power supply of sufficient voltage, replacement of blown fuses, repair of loose connections or defects in house wiring.
4. Expenses for making the appliance accessible for servicing, such as removal of trim, cupboards, shelves, etc., which are not a part of the appliance when it was shipped from the factory.
5. Damages to finish after installation.
6. Replacement of light bulbs and/or fluorescent tubes (on models with these features).

EXCLUSIONS

This warranty does not cover the following:

1. CONSEQUENTIAL OR INCIDENTAL DAMAGES SUCH AS PROPERTY DAMAGE AND INCIDENTAL EXPENSES RESULTING FROM ANY BREACH OF THIS WRITTEN OR ANY IMPLIED WARRANTY.
NOTE: Some states do not allow the exclusion or limitation of incidental or consequential damages, so this limitation or exclusion may not apply to you.
2. Service calls which do not involve malfunction or defects in workmanship or material, or for appliances not in ordinary household use. The consumer shall pay for such service calls.
3. Damages caused by services performed by servicers other than Electrolux Home Products North America or its authorized servicers; use of parts other than genuine Electrolux Home Products parts; obtained from persons other than such servicers; or external causes such as abuse, misuse, inadequate power supply or acts of God.
4. Products with original serial numbers that have been removed or altered and cannot be readily determined.

IF YOU NEED SERVICE

Keep your bill of sale, delivery slip, or some other appropriate payment record. The date on the bill establishes the warranty period should service be required. If service is performed, it is in your best interest to obtain and keep all receipts. This written warranty gives you specific legal rights. You may also have other rights that vary from state to state. Service under this warranty must be obtained by contacting Electrolux Home Products:

USA
1•800•944•9044
 Electrolux Home Products
 North America
 P.O. Box 212378
 Augusta, GA 30917

Canada
1•866•294•9911
 Electrolux Home Products
 North America
 802, boul. L'Ange-Gardien
 L'Assomption, Québec
 J5W 1T6

This warranty only applies in the 50 states of the U.S.A., Puerto Rico, and Canada. Product features or specifications as described or illustrated are subject to change without notice. All warranties are made by Electrolux Home Products North America, a division of White Consolidated Industries, Inc. **In Canada**, your appliance is warranted by Electrolux Canada Corp.