

Panasonic®

Combination 11" Diagonal LCD TV/DVD Player Operating Instructions

Model No. **TC-11LV1**

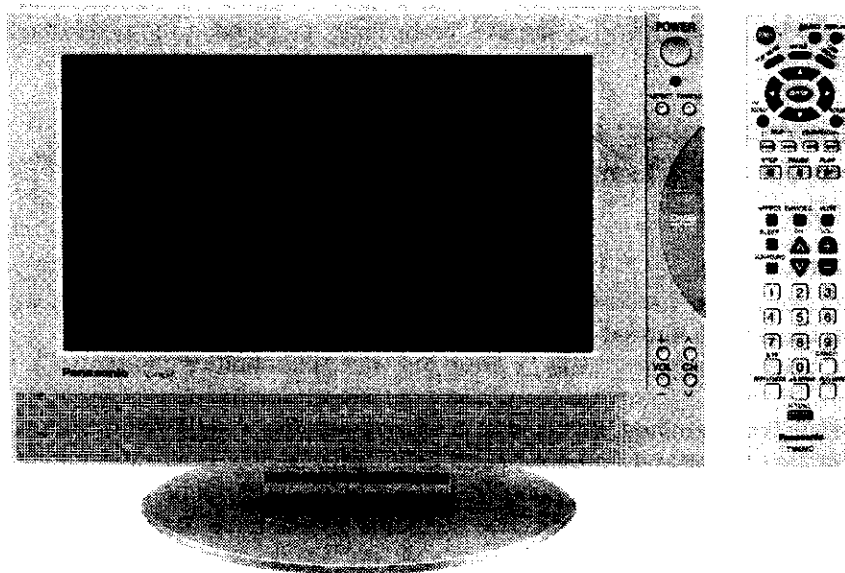

For assistance, please call : 1-800-211-PANA (7262)

or send e-mail to : consumerproducts@panasonic.com

or visit us at www.panasonic.com

(U.S.A)

For assistance, please call : 787-750-4300

or visit us at www.panasonic.com

(Puerto Rico)

For assistance, please call : 1-800-561-5505

or visit us at www.panasonic.ca

(Canada)

This manual is divided into two parts, the "Install and TV Adjusts" and "DVD Operation Guide" :

Install and TV Adjusts: Details on installation of the unit and adjustments to achieve optimum quality of the TV.

DVD Operation Guide: Details on operating instructions for playing discs such as DVDs and CDs.

Before connecting, operating or adjusting this product, please read these instructions completely. Please keep this manual for future reference.

Important Safety Instructions

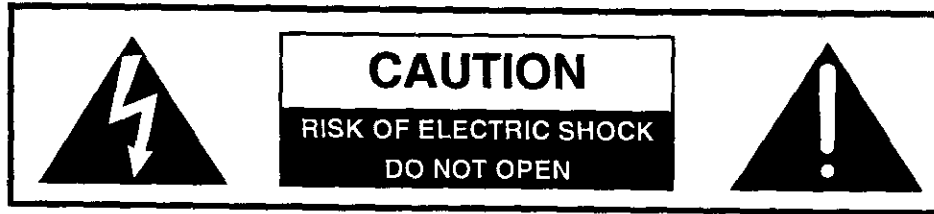

The lightning flash with arrow head within a triangle is intended to tell the user that parts inside the product are a risk of electric shock to persons.



The exclamation point within a triangle is intended to tell the user that important operating and servicing instructions are in the papers with the appliance.

■ **Note to CATV System Installer:** This reminder is provided to direct the CATV system installer's attention to Article 820-40 of the NEC that provides guidelines for proper grounding and, in particular, specifies that the cable ground shall be connected to the grounding system of the building, as close to the point of cable entry as practical.

■ Important Safety Instructions for LCD TV

- 1) Read these instructions and apply them with your LCD TV.
- 2) Keep these instructions.
- 3) Heed all warnings.
- 4) Follow all instructions.
- 5) Do not use this apparatus near water. For example: Avoid placing it near a bathtub, washbowl, kitchen sink, or laundry tub, in a wet basement, or near a swimming pool, etc.
- 6) Clean only with dry cloth. Unplug this LCD TV from the wall outlet before cleaning. Do not use liquid or aerosol cleaners.
- 7) Do not block any ventilation openings. Install in accordance with the manufacturer's instructions. Slots and openings in the cabinet and the back or bottom are provided for ventilation, and to ensure reliable operation of the LCD TV and to protect it from overheating. These openings must not be blocked or covered. There should be at least 10 cm of space from these openings. The openings should never be blocked by placing the LCD TV on a bed, sofa, rug or other similar surface. This LCD TV should not be placed in a built-in installation such as a bookcase unless proper ventilation is provided.
- 8) Do not install near any heat sources such as radiators, heat registers, stoves, or other apparatus (including amplifiers) that produce heat.
- 9) Protect the power cord from being walked on or pinched particularly at plugs, convenience receptacles, and the point where they exit from the apparatus.
- 10) Only use attachments/accessories specified by the manufacturer. Otherwise it may cause hazards.
- 11) Use only with the cart, stand, tripod, bracket, or table specified by the manufacturer, or sold with the apparatus. When a cart is used, use caution when moving the cart/apparatus combination to avoid injury from tip-over. 
- 12) Unplug this apparatus during lightning storms or when it will be left unused for long periods of time. This will prevent damage to the receiver due to lightning and power-line surges.
- 13) Refer all servicing to qualified service personnel. Servicing is required when the apparatus has been damaged in any way, such as when the power-supply cord or plug is damaged, liquid has been spilled or objects have fallen into the apparatus, the apparatus has been exposed to rain or moisture, does not operate normally, or has been dropped. Upon completion of any service or repairs to this LCD TV, ask the service technician to perform routine safety checks to determine that the television is in safe operating condition.
- 14) Operate only from the type of power source indicated on the marking label. If you are not sure of the type of power supplied to your home consult your television dealer or local power company.
- 15) Follow all warnings and instructions marked on the LCD TV.
- 16) Never push objects of any kind into this LCD TV through cabinet slots as they may touch dangerous voltage points or short out parts that could result in a fire or electric shock. Never spill liquid of any kind on the LCD TV.

Important Safety Instructions

17) If an outside antenna is connected to the television equipment, be sure the antenna system is grounded so as to provide some protection against voltage surges and built up static charges. In the U.S. Section 810-21 of the National Electrical Code provides information with respect to proper grounding of the mast and supporting structure, grounding of the lead-in wire to an antenna discharge unit, size of grounding conductors, location of antenna discharge unit, connection to grounding electrodes, and requirements for the grounding electrode.

18) An outside antenna system should not be located in the vicinity of overhead power lines or other electric light or power circuits, or where it can fall into such power lines or circuits. When installing an outside antenna system extreme care should be taken to keep from touching such power lines or circuits as contact with them might be fatal.

- 19) Unplug this LCD TV from the wall outlet, and refer servicing to qualified service personnel under the following conditions:
- When the power cord or plug is damaged or frayed.
 - If liquid has been spilled into the LCD TV.
 - If the LCD TV has been exposed to rain or water.
 - If the LCD TV does not operate normally by following the operating instructions.

Adjust only those controls that are covered by the operating instructions as improper adjustment of other controls may result in damage and will often require extensive work by a qualified technician to restore the LCD TV to normal operation.

- If the LCD TV has been dropped or the cabinet has been damaged.
 - When the LCD TV exhibits a distinct change in performance - this indicates a need for service.
- 20) When replacement parts are required, be sure the service technician to use replacement parts specified by the manufacturer that have the same characteristics as the original part. Unauthorized substitutions may result in fire, electric shock, or other hazards.
- 21) **WARNING: TO REDUCE THE RISK OF FIRE OR ELECTRIC SHOCK, DO NOT EXPOSE THIS APPARATUS TO RAIN OR MOISTURE.**
- 22) **CAUTION: TO PREVENT ELECTRIC SHOCK DO NOT USE THIS PLUG WITH A RECEPTACLE OR OTHER OUTLET UNLESS THE BLADES CAN BE FULLY INSERTED TO PREVENT BLADE EXPOSURE.**
- 23) **CAUTION: USE WITH OTHER STAND MAY RESULT IN INSTABILITY CAUSING POSSIBLE INJURY.**
- 24) **CAUTION: DANGER OF EXPLOSION IF BATTERY IS INCORRECTLY REPLACED. REPLACE ONLY WITH THE SAME OR EQUIVALENT TYPE.**

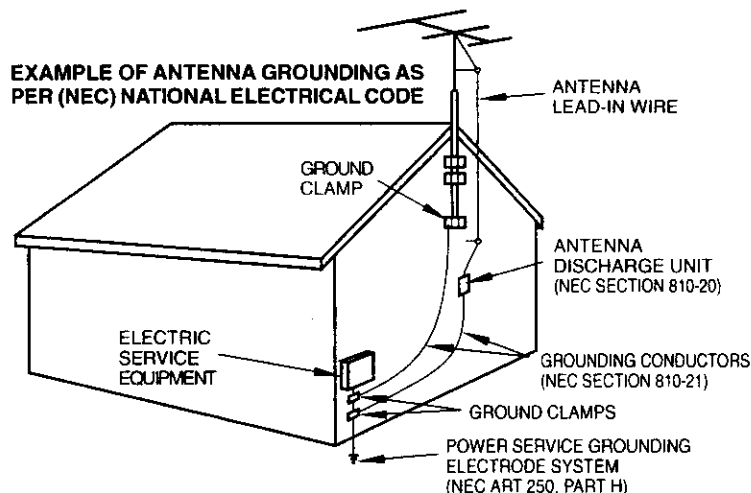

NOTE: ● This equipment is designed to operate in the U.S.A. and other countries where the broadcasting system and AC house current is exactly the same as in the U.S.A.

● The marking or retained image on the LCD panel resulting from fixed image use is not an operating defect and as such is not covered by Warranty. This product is not designed to display fixed image patterns for extended periods of time.

■ Important Information Regarding Use of Video Games, Computers, Captions or Other Fixed Image Displays.

The extended use of fixed image program material can cause a permanent "shadow image" on the LCD panel.

This background image is viewable on normal programs in the form of a stationary fixed image. This type of irreversible LCD panel deterioration can be limited by observing the following steps:

- Reduce the brightness/contrast setting to a minimum viewing level.
- Do not display the fixed image for extended periods of time.
- Turn the power off when not in actual use.

■ This product utilizes tin-lead solder, and has a fluorescent lamp containing a small amount of mercury. Disposal of these materials may be regulated in your community due to environmental considerations. For disposal or recycling information please contact your local authorities, or the Electronics Industries Alliance: www.eiae.org.

Dear Panasonic Customer

Welcome to the Panasonic family of customers.

We hope that you will have many years of enjoyment from your new combination 11" Diagonal LCD TV/DVD player.

To obtain maximum benefit from your set, please read these instructions before making any adjustments, and retain them for future reference.

Retain your purchase receipt, and note down the model number and serial number of your set in the space provided on the rear cover of these instructions.

For assistance, please call : 1-800-211-PANA (7262) or send e-mail to : consumerproducts@panasonic.com or visit us at www.panasonic.com (U.S.A)
For assistance, please call : 787-750-4300 or visit us at www.panasonic.com (Puerto Rico)
For assistance, please call : 1-800-561-5505 or visit us at www.panasonic.ca (Canada)

Federal Communication Commission Information

This equipment has been tested and found to comply with the limits for a TV Broadcast Receiver, pursuant to Part 15 of the FCC Rules. These limits are designed to provide reasonable protection against harmful interference in a residential installation. This equipment generates, uses and can radiate radio frequency energy and, if not installed and used in accordance with the instructions, may cause harmful interference to radio communications. If this equipment does cause or receive interference, which can be determined by turning equipment off and on, the user is encouraged to try to correct the interference by one of the following measures:

- Reorient or relocate the TV antenna.
- Increase the separation between TV and other equipment.
- Connect TV into separate outlet from other equipment.
- Consult the dealer or an experienced radio/TV technician for help.

FCC Caution: Any changes or modifications not expressly approved by the party responsible for compliance could void the user's authority to operate this equipment.

CAUTION:

COMBINATION 11" DIAGONAL LCD TV/DVD PLAYER IS A CLASS 1 LASER PRODUCT. HOWEVER THIS COMBINATION 11" DIAGONAL LCD TV/DVD PLAYER USES A VISIBLE LASER BEAM WHICH COULD CAUSE HAZARDOUS RADIATION EXPOSURE IF DIRECTED. BE SURE TO OPERATE THE COMBINATION 11" DIAGONAL LCD TV/DVD PLAYER CORRECTLY AS INSTRUCTED.

WHEN THIS COMBINATION 11" DIAGONAL LCD TV/DVD PLAYER IS PLUGGED INTO THE WALL OUTLET, DO NOT PLACE YOUR EYES CLOSE TO THE DISC SLOT OR OTHER OPENINGS TO LOOK INTO THE INSIDE OF THIS PLAYER.

USE OF CONTROLS OR ADJUSTMENTS OR PERFORMANCE OF PROCEDURES OTHER THAN THOSE SPECIFIED HEREIN MAY RESULT IN HAZARDOUS RADIATION EXPOSURE.

DO NOT OPEN COVERS AND DO NOT REPAIR YOURSELF. REFER SERVICING TO QUALIFIED PERSONNEL.

Table of Contents

Installation and TV Settings

Important Safety Instructions	2	Selecting LANGUAGE	16
Federal Communication Commission Information	4	Tuning channels (Automatic channel programming)	16
Installation	6	Tuning channels (Manual channel programming)	17
Disc handling	6	Playing a VCR or other peripheral equipment	18
SUPPLIED ACCESSORIES	7	Setting condition to be displayed	19
Remote control battery installation	7	Child lock	20
Connecting the Antenna Cable to the RF In Terminal	8	ASPECT Controls	21
Antenna / Cable Connection	8	Picture Adjustments	22
Antenna Connection (Cable Box, no VCR)	9	Adjusting screen position and size	24
Antenna Connection (Cable Box, and VCR)	9	Audio Adjustments	25
How to connect the input terminals	10	Selecting STEREO/SAP/MONO	26
How to connect the DVD OUT Terminals	10	SURROUND Control	26
Connecting Headphones / Earphones	10	Customizing the VIDEO INPUT labels	27
Connecting OPTICAL audio cable	10	Natural Color	28
Power ON / OFF	11	Automatically changing screen size	
Connecting the plug to the Wall Outlet	11	for VIDEO INPUT modes (ID-1)	28
How to Turn the Power On	11	To eliminate noise at the top and bottom of	
Location of Controls	12	the screen (IMAGE ADJ.)	29
Flow Chart of TV menu	14		

DVD (CD) Operation Guide

Features of DVD on this Product	32	Changing audio soundtrack language [DVD]	42
Enjoying digital audio output from the digital audio output connector	33	Changing subtitle language [DVD]	43
Location of Controls for DVD Operation	34	Viewing from another angle [DVD]	43
Location of front operation panel	35	General information about GUI screens	44
Basic play	36	Common procedures	44
To play	36	Screen for disc information (for DVD)	45
Stopping play	37	Screen for disc information (for Video CD/CD)	46
Skipping chapters or tracks	38	GUI screen reference chart	47
Still picture (Pause)	38	Initial settings	48
Rapid advance (Rapid reverse)	38	Common procedures	48
Frame advance (Frame reverse) [DVD/Video CD]	39	DISC MENU	49
Slow-motion play [DVD/Video CD]	39	VIDEO MENU	51
Cancelling playback control [Video CD]	39	DISPLAY MENU	52
Using a Top MENU [DVD]	39	AUDIO MENU	52
Using a DVD MENU [DVD]	39	Initial setting condition of DVD SETUP menu	53
Random play [CD]	40	Language code list	54
Selecting sound field	40	How images appear on your TV	
Repeat play	41	(aspect ratios of the screen)	55
A-B repeat play	41	Troubleshooting	56
		Maintenance	58
		Specifications	59

Installation

Receiver Location

Locate for comfortable viewing. Avoid placing where sunlight or other bright light (including reflections) will fall on the screen. Use of some types of fluorescent lighting can reduce remote control transmitter range.

Adequate ventilation is essential to prevent internal component failure. Keep away from areas of excessive heat or moisture. To ensure optimum picture quality do not position magnetic equipment (motors, fans, other speakers, etc.) nearby.

Optional External Equipment

The Video/Audio connection between components can be made with shielded video and audio cables. For best performance, Antenna cables should utilize 75 ohm coaxial shielded wire. Cables are available from your dealer or electronic supply store. Before you purchase any cables, be sure you know what type of output and input connectors your various components require. Also determine the length of cable you'll need.

For optimum quality picture

When the LCD is exposed to light from outdoors or lighting fixtures, high-contrast pictures may not be displayed clearly. Turn off florescent lamps near the LCD and place in a location not exposed to outdoor light.

Disc handling

Handling precautions

- Hold the disc by the edges so the surface will not be soiled with fingerprints. Fingerprints, dirt and scratches can cause skipping and distortion. **(A)**:
- Do not write on the label side.
- Do not use record cleaning sprays, benzine, thinner, static electricity prevention liquids or any other solvent.
- Be careful not to drop or bend the disc.
- Do not install more than 1 disc.
- Store the disc in its case when not in use.

A

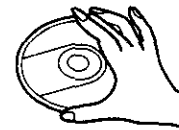

If the surface is soiled **(B)**

Wipe gently with a soft, damp (water only) cloth.
When wiping discs, always wipe from the center toward the outer edge.
(If you wipe using a circular motion, circular scratches can occur, which will cause noise.)

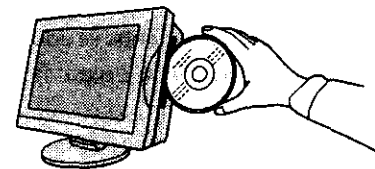

If the disc is brought from a cold to a warm environment, moisture may form on the disc

Wipe with a soft, dry, lint-free cloth before using the disc.

B

Improper disc storage

You can damage discs if you store them in the following places:

- Areas exposed to direct sunlight
- Humid or dusty areas
- Areas directly exposed to a heat outlet or heating appliance

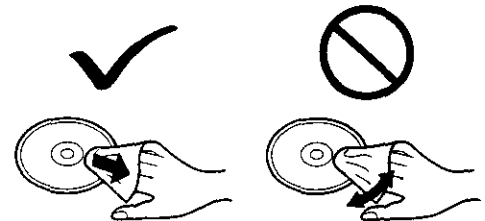

Discs which cannot be played with this player

- DVD with Region No. other than "1" or "ALL"
- DVD-ROM
- DVD-AUDIO
- VSD
- CD-G
- CVD+RW
- SVCD
- Do not try to play Photo CD or CD-R.
(Data on the disc may be damaged.)
- DVD-R/DVD-RAM
- CD-ROM
- CDV
- CD-RW
- CDV
- Divx Video Disc etc.

SUPPLIED ACCESSORIES

Check the accessories before installations.

- Operating Instruction book (TQBC0357/0358/0359)

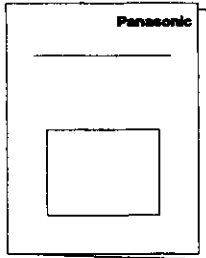

- Remote Control Transmitter (TNQE284)

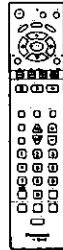

- Battery for the Remote Control Transmitter (2 × AAA size)

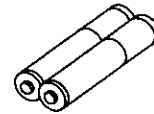

- Warranty Card (TQDC18014)

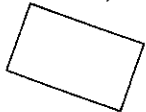

- Service Center List (TQBC7055-2)



- AC Adaptor & AC Cord
AC Adaptor: (N0JZHK000005)
AC Cord: (K2CA2EA00005)

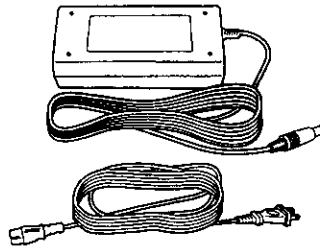

Remote control battery installation

Requires two AAA batteries.

1. Turn the transmitter face down. Remove top cover by pressing down on marking and sliding cover off in the direction indicated.
2. Install the batteries as shown in the battery compartment. (Polarity + or – must match the markings in the compartment).
3. Replace the cover and slide in reverse until the lock snaps.

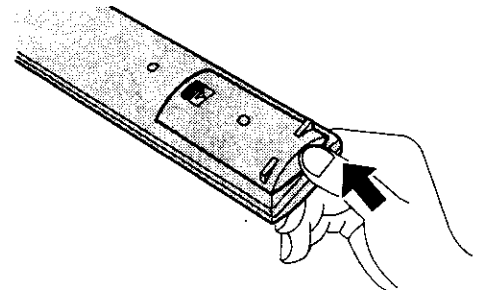
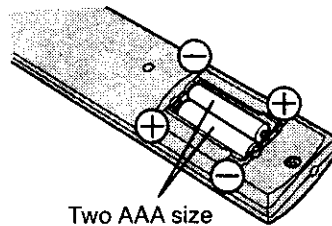
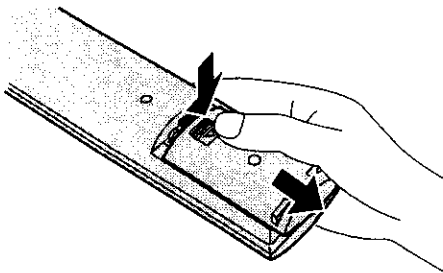

Helpful Hint:

For frequent remote control users, replace old batteries with Alkaline batteries for longer life.

⚠ Precaution on battery use

Incorrect installation can cause battery leakage and corrosion that will damage the remote control transmitter.

Observe the following precautions:

1. Batteries should always be replaced as a pair. Always use new batteries when replacing the old set.
2. Do not combine a used battery with a new one.
3. Do not mix battery types (example: "Zinc Carbon" with "Alkaline").
4. Do not attempt to charge, short-circuit, disassemble, heat or burn used batteries.
5. Battery replacement is necessary when the remote control acts sporadically or stops operating this unit.

Installation

Connecting the Antenna Cable to the RF In Terminal

Antenna Connection - For proper reception of VHF/UHF channels, an external antenna is required. For best reception an outdoor antenna is recommended. Antenna Mode must be set to TV.

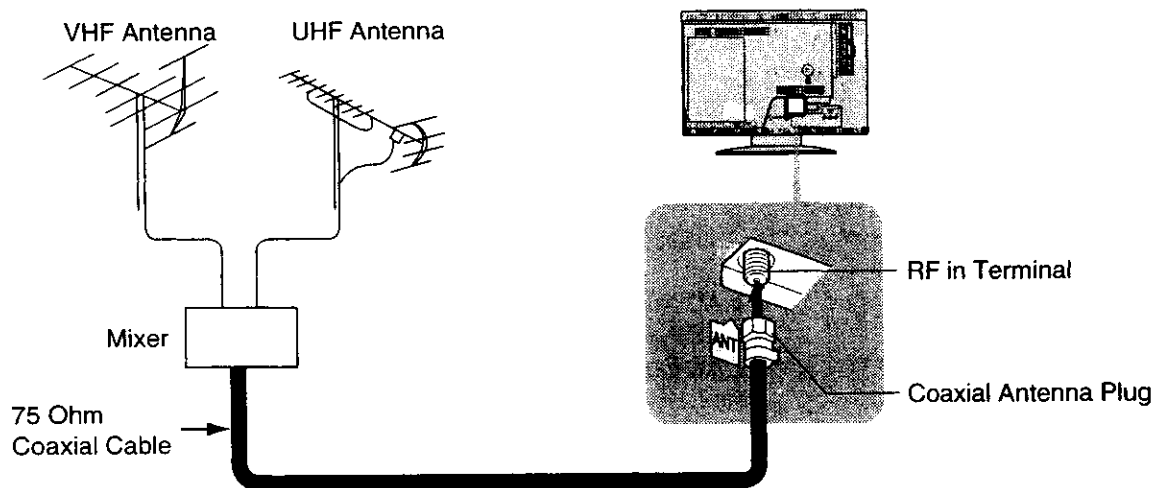

Antenna / Cable Connection

Incoming Cable From Home Antenna (75 Ohm)

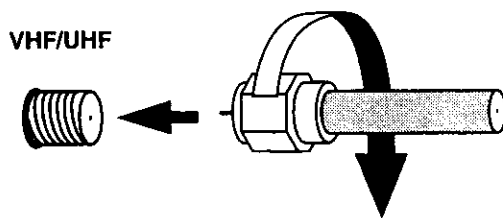

Incoming 75 Ohm Cable (From Cable Company)

Cable Connection - For reception of cable channels (01 - 125) connect the cable supplied by your local cable company. Antenna Mode must be set to CABLE. (Refer to Antenna Mode section.)

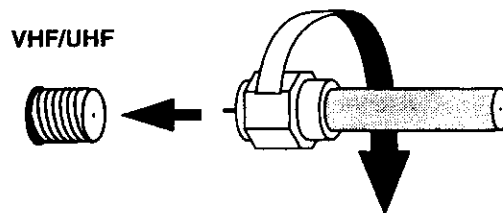

Note:

Certain cable systems offset some channels to reduce interference or have Premium (scrambled) channels. A cable converter box is required for proper reception. Check with your local Cable company for its compatibility requirements.

Antenna Connection (Cable Box, no VCR)

Use this configuration when connecting the TV to a cable TV system using a Cable Box.

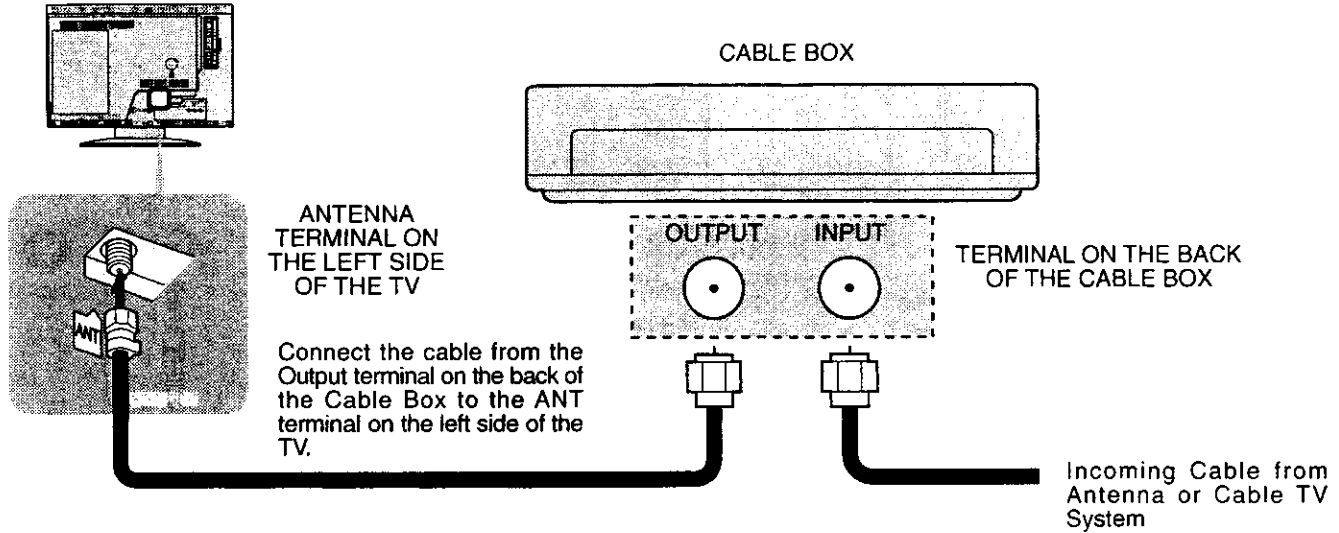

Antenna Connection (Cable Box, and VCR)

Use this configuration when connecting the TV to a cable TV system using a Cable Box and VCR.

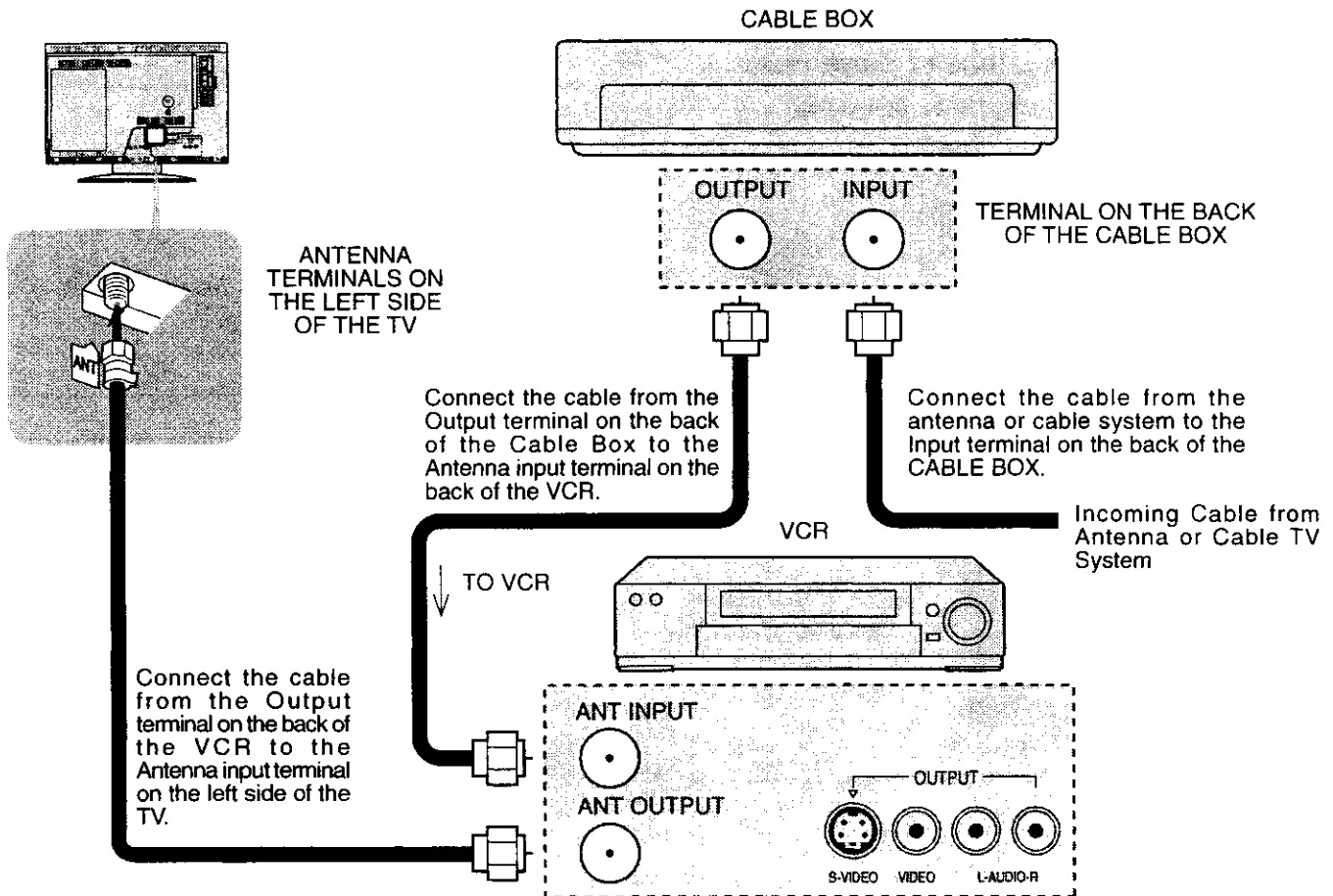

Note: When the antenna cable is connected to the TV antenna terminal via a cable box or VCR, set the TV channel to CH3 or CH4, cable. This does not apply when signal is input from VIDEO INPUT.

Installation

How to connect the input terminals

Connects VCRs and other peripheral equipment

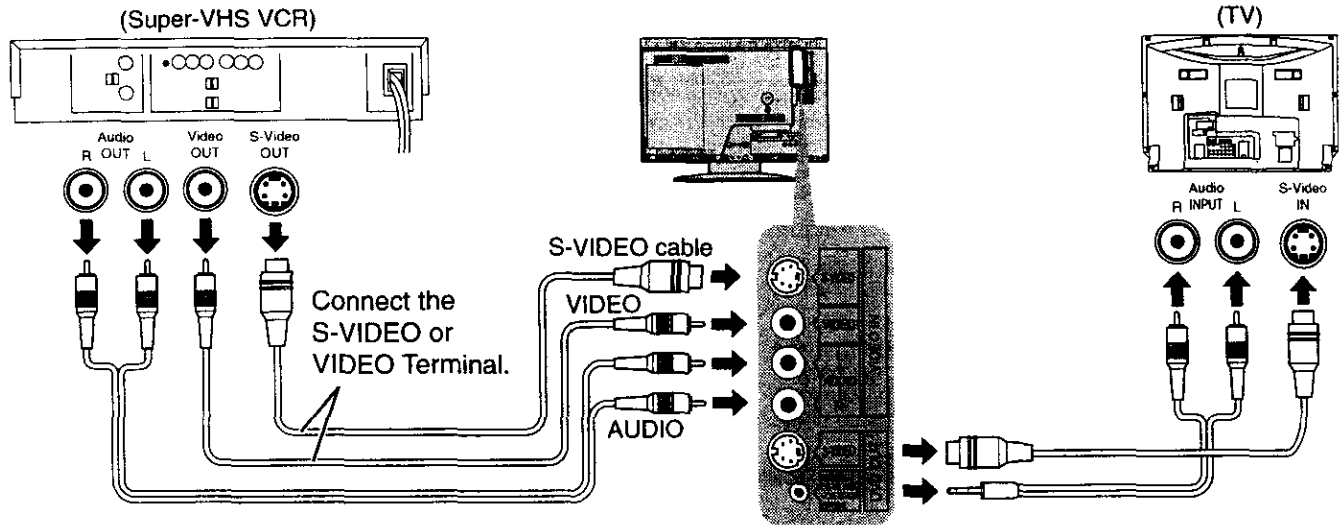

Notes:

- When a monaural VCR is used, connect the monaural audio cable to the AUDIO-L (Left) terminal.
- When connecting video cables, priority is given to the S-Video cable when the S-Video input terminal and the video input terminal are connected at the same time.

Connecting Headphones / Earphones

Connect headphones / earphones as follows.

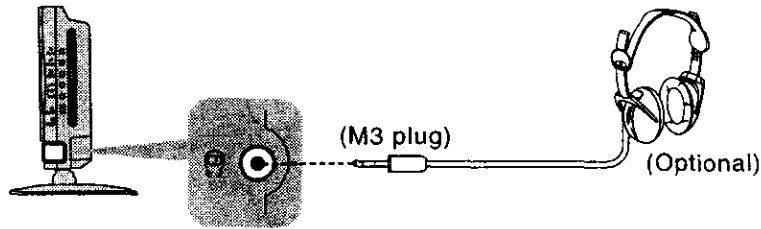

Connecting OPTICAL audio cable

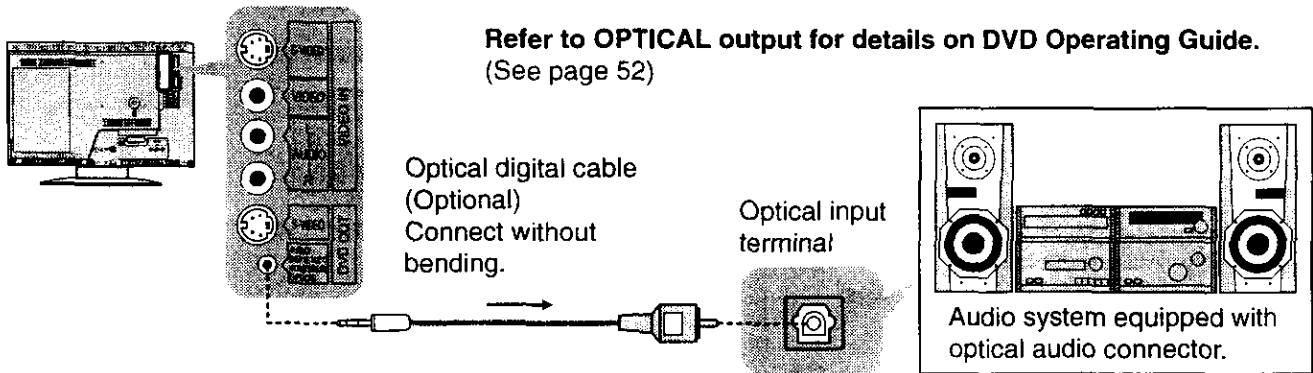

Power ON / OFF

Connecting the Plug to the Wall Outlet

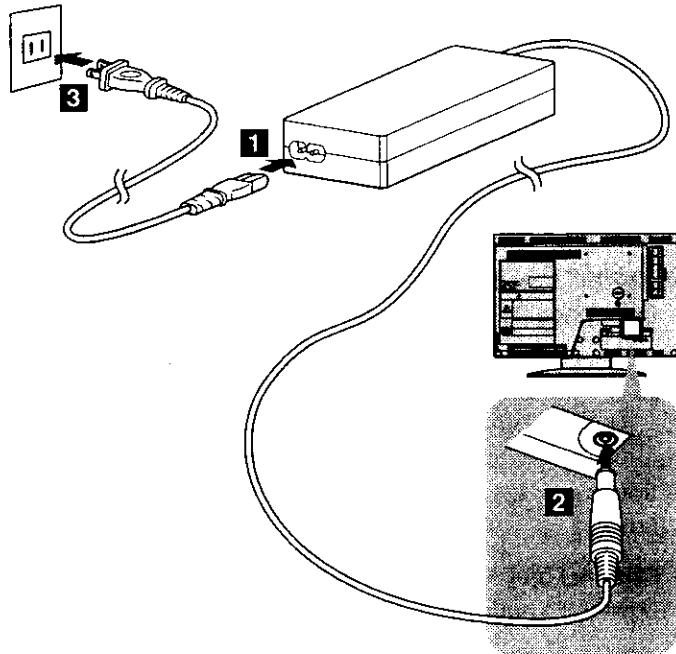

Note:

The TV and AC adaptor will still consume some power as long as the power cord is still inserted into the wall outlet.

How to Turn the Power On

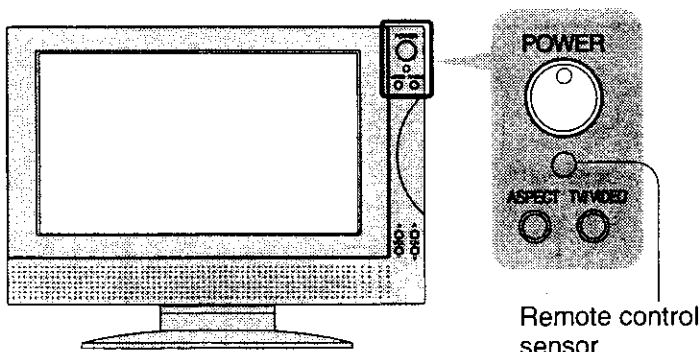

Push the POWER switch on the TV to turn the set on.
POWER-ON: Green

Turn the power of the TV set off by pressing the POWER switch on the TV when the TV is on or in standby mode.

Example: The screen below is displayed for a while after the TV is turned on. (setting condition is an example.)

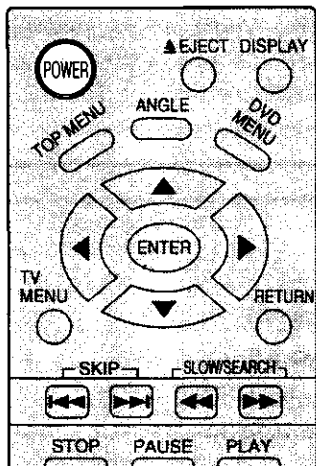
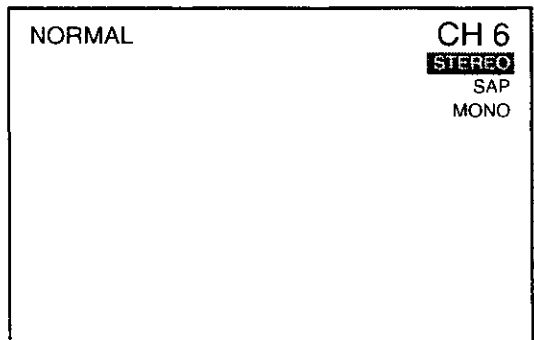

Press the POWER button on the remote control to turn the TV off: Red (standby)

Press the POWER button on the remote control to turn the TV on: Green

Location of Controls

Controls on the TV

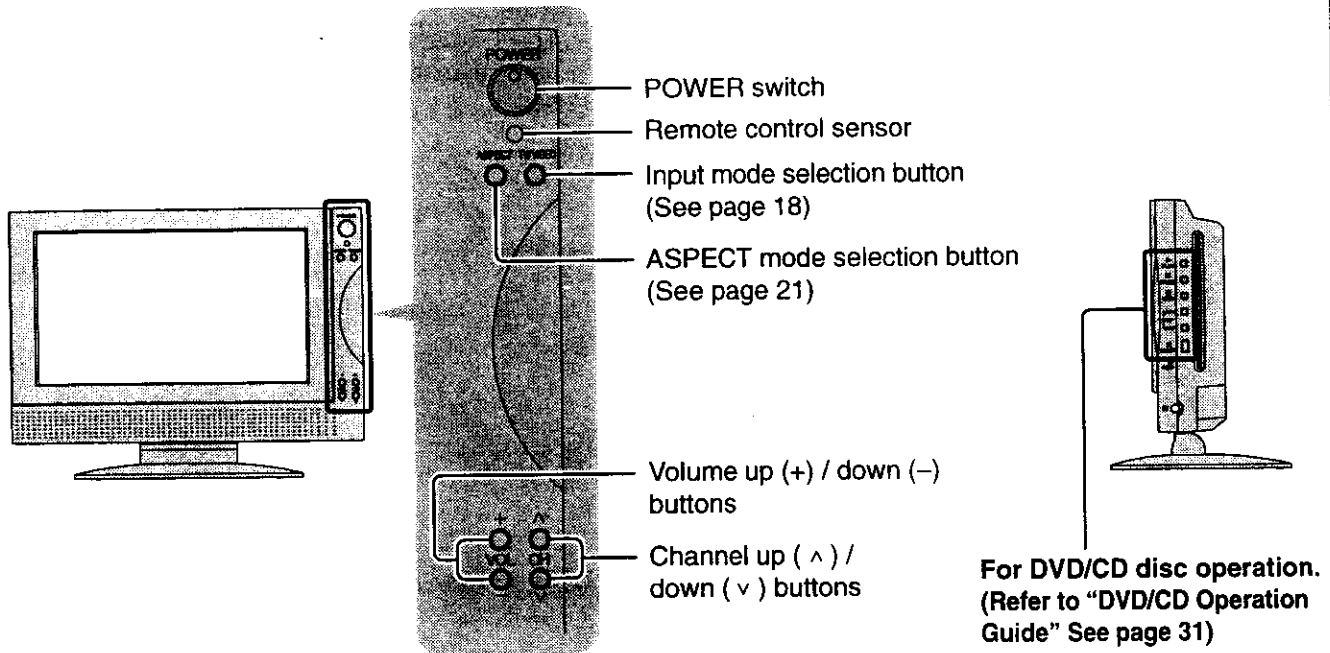

SLEEP timer button

The TV may be preset to switch to stand-by after a fixed period. The setting changes to 30 minutes, 60 minutes, 90 minutes and 0 minutes (off timer cancelled) each time the button is pressed.

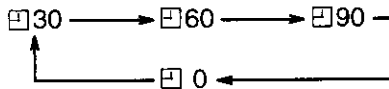

When three minutes remain, " 3 " will flash. The off timer is cancelled if the main power is turned off. Starting three minutes before the power is automatically turned off, the remaining time, 3 → 2 → 1 will blink on the screen.

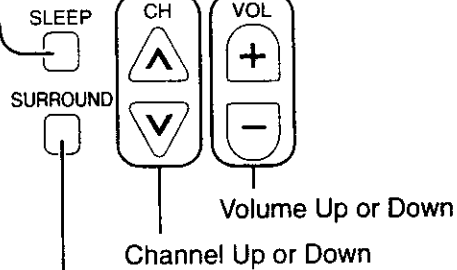

SURROUND button

The benefits of surround are astounding. You can be completely enveloped in sound, just as if you were at a concert hall or cinema. (See page 26)

Valid during DVD mode

REPEAT MODE A-B REPEAT PLAY MODE

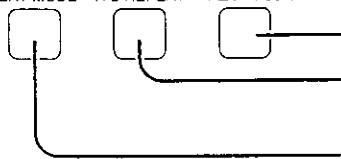

PLAY MODE button (See page 40)

A-B REPEAT button (See page 41)
Repeating selections between two specific points.

REPEAT MODE button (See pages 40, 41)

Location of Controls

Stand-by (ON/OFF) button

TV must first be plugged into the wall outlet and turned on at the power switch (See pages 12, 34, 35).

Use with DVD operation. (Refer to "DVD/CD Operation Guide"...See page 31)

EJECT button

Press to eject DVD or CD.

DISPLAY button

Press the DISPLAY button to display the current system status. Refer to "DVD Operation Guide" when using the DVD.

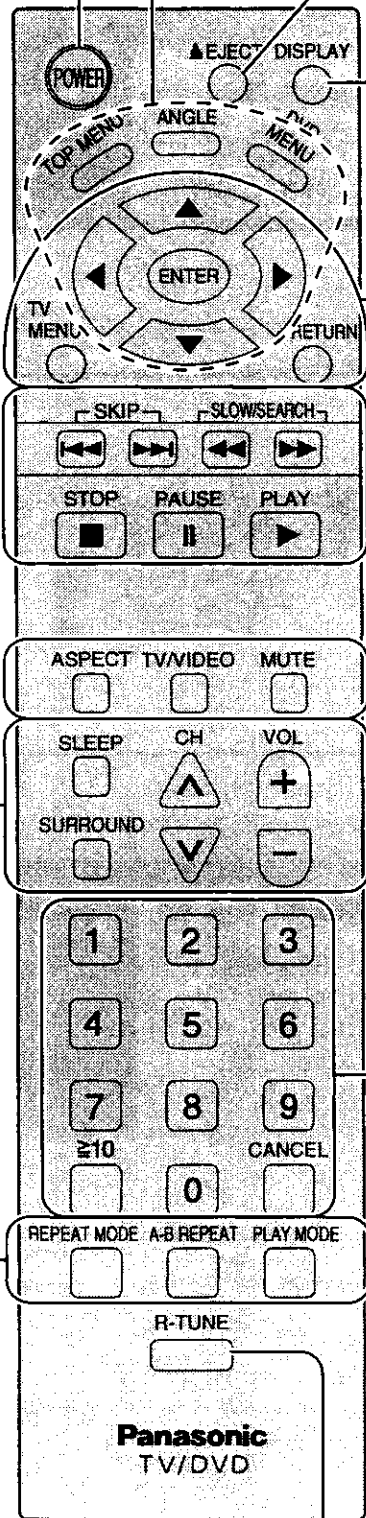

Moves cursor to the left during menu mode.

Moves cursor upward during menu mode.

Moves cursor to the right during menu mode.

Press TV MENU button to display the Menu screen.

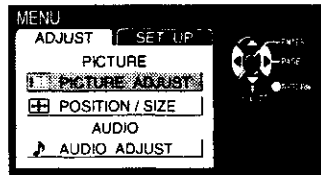

Moves cursor downward during menu mode.

Press to return to previous menu screen.

For disc operation use.

(Refer to "DVD/CD Operation Guide"...See page 31)

MUTE button

Press to mute the sound. Press again to reactivate sound. Sound is also reactivated when power is turned off or volume level is changed.

TV/VIDEO button

This input mode changes each time this button is pressed (See page 18).

ASPECT button

Changes screen size (See page 21).



Direct program number selection buttons

R-TUNE

R-TUNE button

Switches to previous channel or video mode.

Flow Chart of TV menu

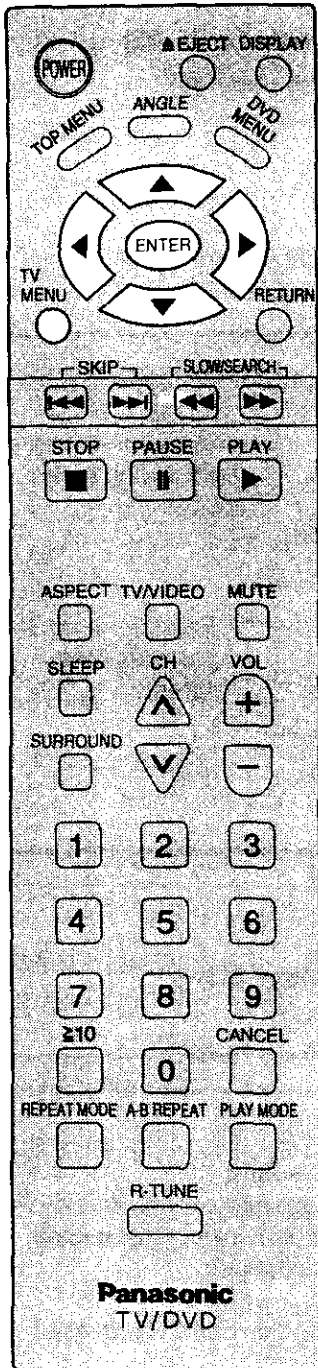

1

If the TV MENU button is pressed, the MENU screen will be displayed. If the TV MENU button is pressed once more, the MENU screen will be cleared.

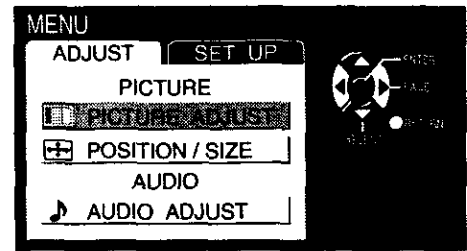

2

Select desired MENU by pushing Right "▶" button or Left "◀" button.

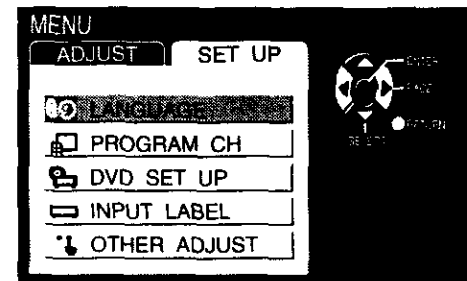
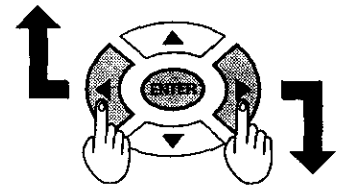

Flow Chart of TV menu

PICTURE ADJUST menu

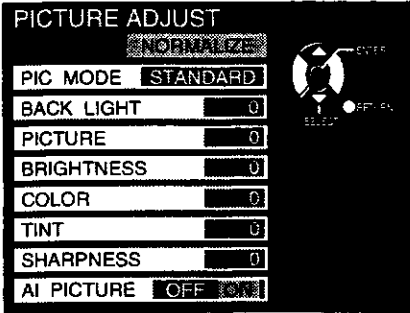

(See pages 22,23)

POSITION/SIZE menu

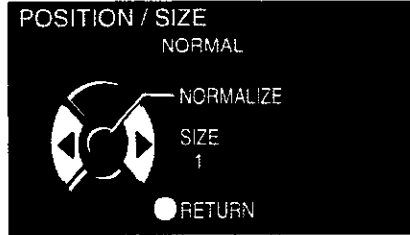

(See page 24)

AUDIO ADJUST menu

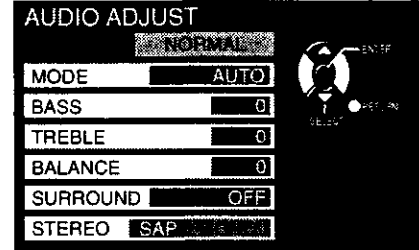

(See page 25)

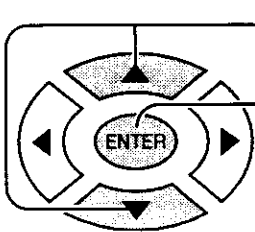

1 Press to select each item.

2 Press to adjust the screen that is displayed.

Notes:

- Items displayed in light blue cannot be adjusted.
- Display color changes according to input settings. (Press the TV/VIDEO button to switch inputs.)

LANGUAGE menu



(See page 16)

PROGRAM CHANNELS adjust screen



(See pages 16,17)

DVD SET UP

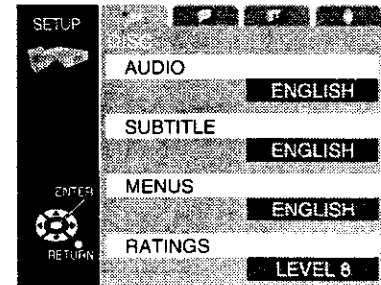

(See page 48)

VIDEO INPUT LABEL setting menu

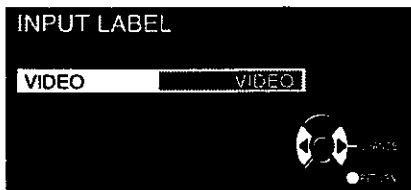

(See page 27)

OTHER ADJUST setting menu

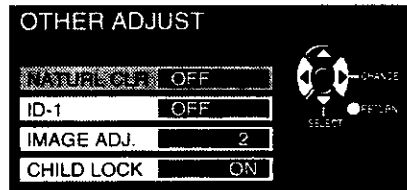

(See pages 28,29)

Selecting LANGUAGE

It is possible to change the screen menu language to a different language. (English, Français, Español)

- 1 Press the TV MENU button to display the MENU screen and select SET UP.

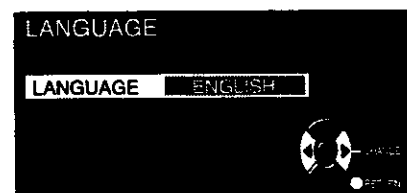
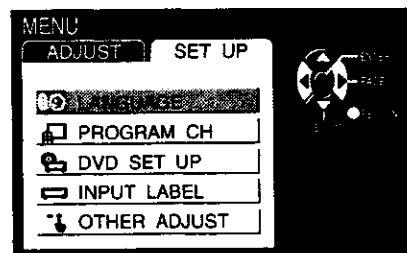
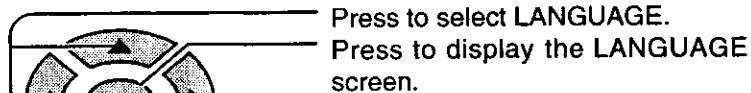

- 2 Press the RETURN button to return to the SET UP MENU.
- 3 Press the TV MENU button to exit the SET UP MENU.

Tuning channels (Automatic channel programming)

Automatically scans all TV channels and stores them in memory.

- 1 Turn the Power on and press the TV/VIDEO button to display the TV channel.

- 2 Press the TV MENU button to display the MENU screen and select SETUP.

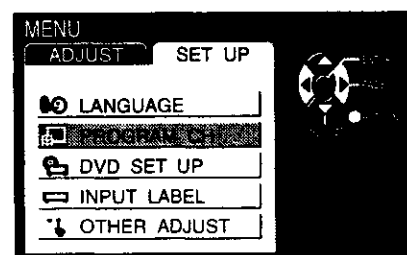
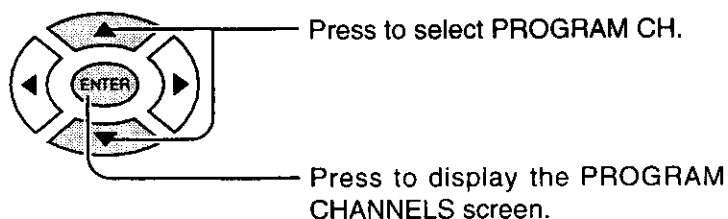

- 3 Press to select MODE.
Press to select TV or CABLE.

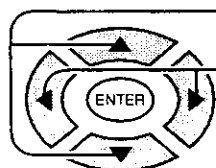

- 4 Press to select AUTO PROGRAM.
Press to display the confirmation screen.

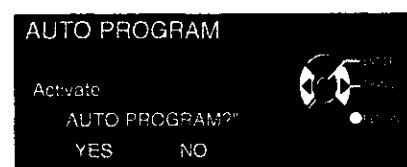
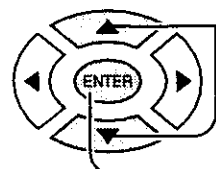

5

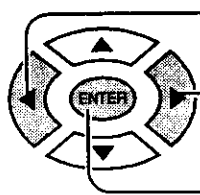

Press to select YES.

Press to select NO.

If YES selection
Press to run AUTO PROGRAM



Channels will automatically advance until all channels have been scanned. Channel numbers with a video signal present will turn light blue indicating it has been stored in the Channel Scan Memory.

6

Press the RETURN button to return to the PROGRAM CHANNELS.

7

Press the TV MENU button to exit the set up menu.

Notes:

- When buttons are pressed with AUTO PROGRAM running, the TV set will return to normal viewing. (Channels searched up to this point are added.)
- After AUTO PROGRAM is finished, the lowest channel number added will be received.
- When there are no receivable channels, channel 69 is displayed for TV and channel 125 is displayed for cable TV.

Tuning channels (Manual channel programming)

Use this setting when changing setting of receiving channels or changing the channel display.

Turn the TV on and select the broadcast channel. Follow the steps on the previous page to display the PROGRAM CHANNEL screen.

Selecting the PROGRAM CHANNELS menu.

1

Refer to previous page Tuning channels step 1 to 3.

2

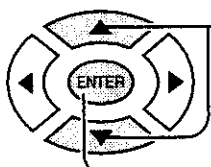

Press to select MANUAL PROGRAM.

Press to display the MANUAL PROGRAM screen.



Adding or deleting channels

3

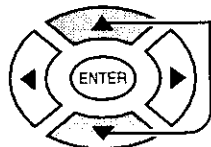

Press to select channel (or number keys).

4

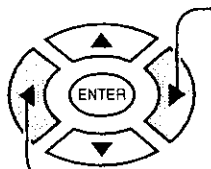

Press to add channels to memory
(Channel number turns blue).

Press to delete channels from memory
(Channel number turns yellow).



5

Repeat steps 3 and 4 to continue adding or deleting channels.

6

Press the TV MENU button to exit the set up menu.

Playing a VCR or other peripheral equipment

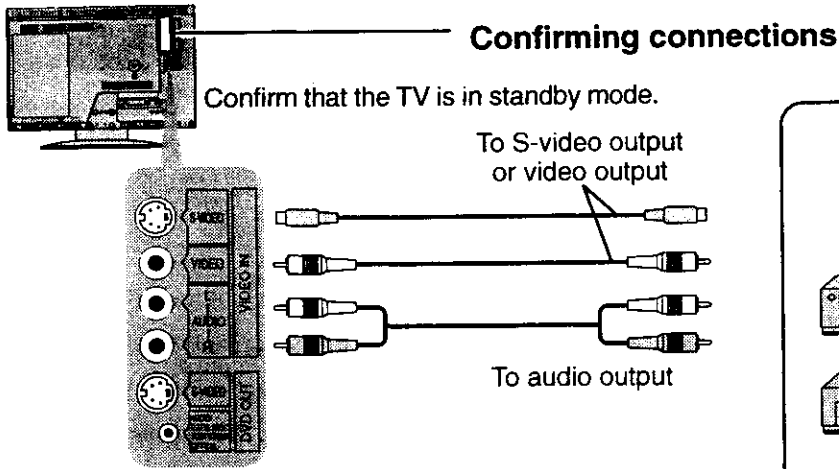

Video camera

VCR

Laser Disc Player

DVD player

This equipment can also be connected to the rear terminals. See Connections for details.

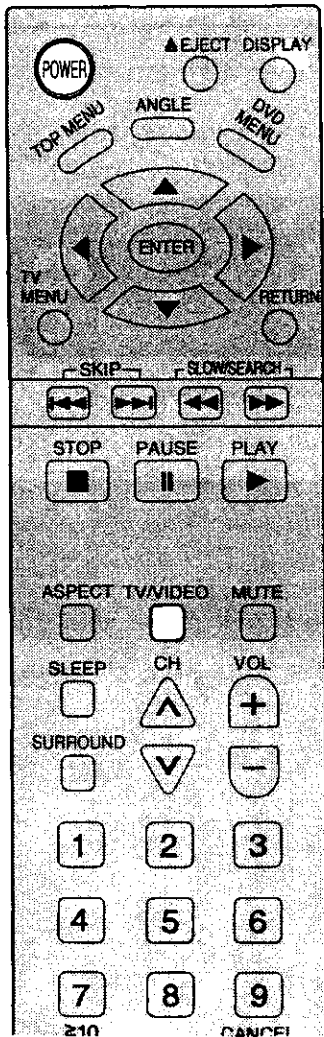

Turning the power on and switching input modes

1



Turn the TV on.

2



The input mode changes each time this button is pressed.

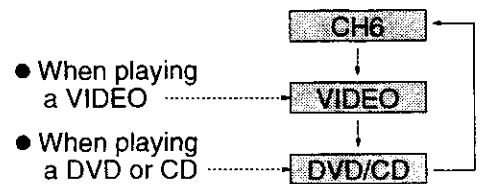

Note:

When the remote control is unavailable, input modes can also be switched on the TV set using the TV/VIDEO button.

3

Operate the connected equipment.

Setting condition to be displayed

DISPLAY (On-screen display)

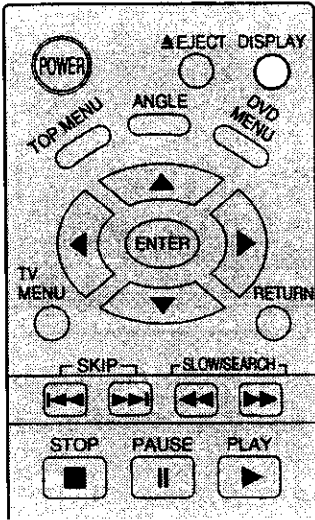

DISPLAY



Press this button to display channel number, off-timer remaining time, screen modes, and other settings. Display fades away after about 3 seconds. Press this button again to delete channel number display.

Aspect status

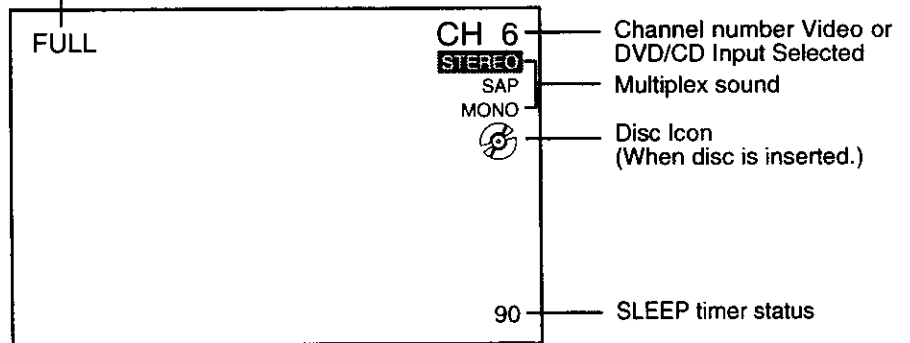

The GUI menu bar for DVD operation is displayed by pressing the DISPLAY button when the above screen is displayed.

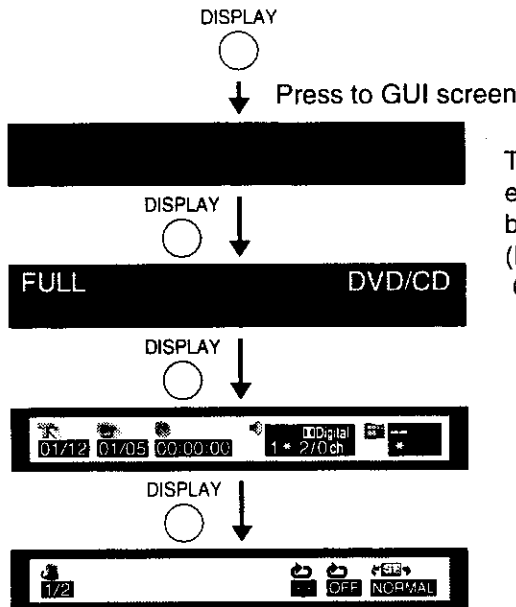

The GUI screen changes every time the DISPLAY button is pressed. (Refer to "DVD Operation Guide")

Child lock

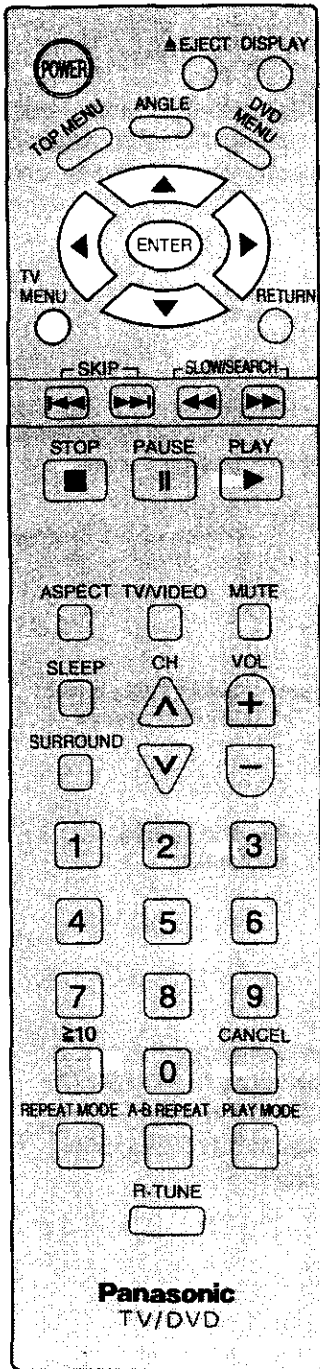

When CHILD LOCK is ON, the Disc cannot be ejected with the EJECT button. (The message below is displayed.)

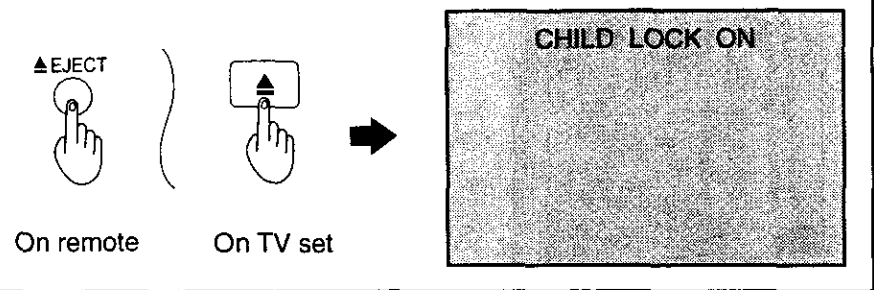

1 Press the TV MENU button to display the MENU screen and select SET UP.

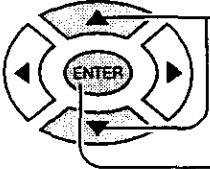
2  Press to select OTHER ADJUST.
Press to display the OTHER ADJUST screen.

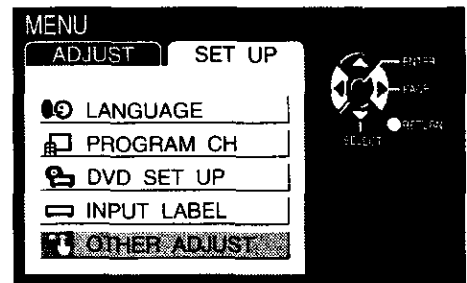

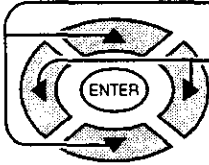
3  Press to select CHILD LOCK.
Press to set.

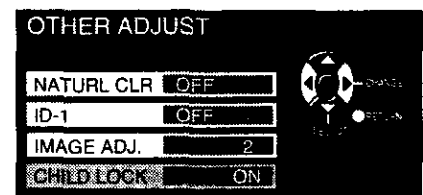

To end adjustment.

Note:
The settings are memorized even after power is turned OFF.

ASPECT Controls

The TV will allow you to enjoy viewing the picture at its maximum size, including wide screen cinema format picture.

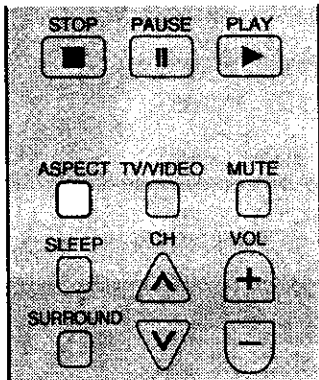

ASPECT button

The aspect mode changes each time the ASPECT button is pressed.

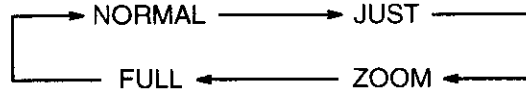

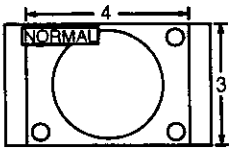
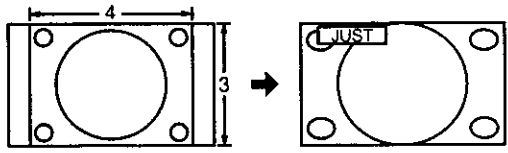
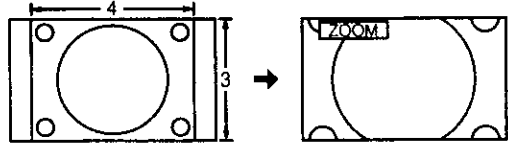
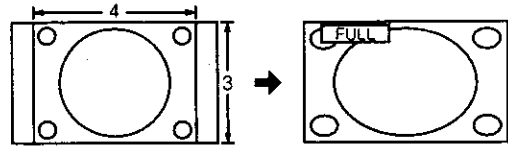
Mode	Picture	Explanation
NORMAL		NORMAL will display a 4:3 picture at its standard 4:3 size.
JUST		JUST mode will display a 4:3 picture at maximum size but with aspect correction applied to the center of the screen so that elongation is only apparent at the left and right edges of the screen. The size of the picture will depend on the original signal.
ZOOM		ZOOM mode magnifies the central section of the picture.
FULL		FULL will display the picture at its maximum size but with slight elongation.

Note:

- When ID-1 signal is detected, the ASPECT mode changes to FULL or ZOOM automatically.
- Priority is given to S1 when S1 and ID-1 are inputted simultaneously.

Picture Adjustments

1 Press the TV MENU button to display the MENU screen and select ADJUST.

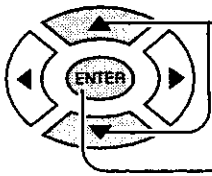

Press to select PICTURE ADJUST.

Press to display the PICTURE ADJUST screen.

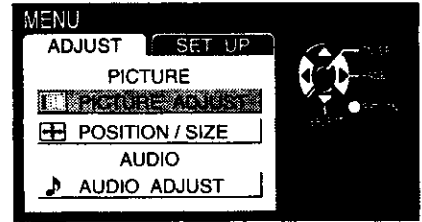

2

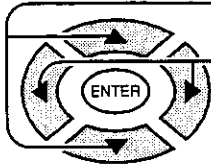

Press to select the menu to adjust.

Select the desired level by looking at the picture behind the menu.

NORMALIZE is displayed at default.

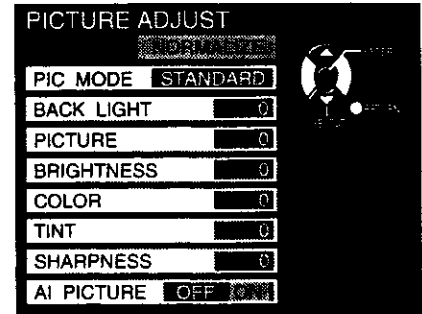

Press the left ◀ or right ▶ button to switch between modes.

STANDARD — CINEMA — DYNAMIC

STANDARD

STANDARD

Displays unaltered image.



CINEMA

CINEMA

Ideal for movies.



DYNAMIC

DYNAMIC

Displays a clear screen with contrast of light and dark.

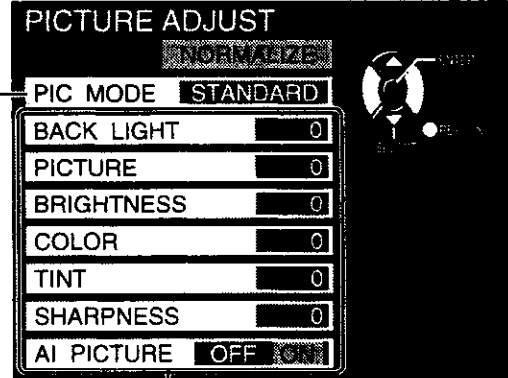

See next page

Picture Adjustments

BACKLIGHT

Luminance of the back light is adjusted.

PICTURE

Selects proper brightness and density for the room.

BRIGHTNESS

Adjusts for easier viewing of dark pictures such as night scenes or a hair portion.

COLOR

Adjusts slightly to a lighter color.

TINT

Adjust for flesh tone color.

SHARPNESS

Displays a sharp image.

AI PICTURE

Displays black and white colors more clearly when turned ON.

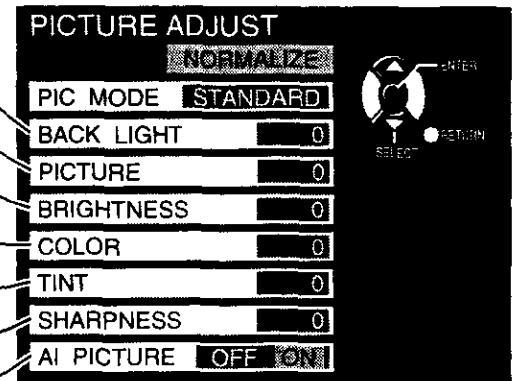

- To adjust each item, →

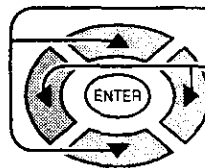

Press the up ▲ and down ▼ buttons to select each item.

Press the left ◀ and ▶ right buttons to make adjustments.

BACK LIGHT	+5	-30 to +30
PICTURE	0	-30 to +30
BRIGHTNESS	-5	-30 to +30
COLOR	+5	-30 to +30
TINT	+5	-30 to +30
SHARPNESS	0	-30 to +30
AI PICTURE	OFF	

- To reset to standard setting, →

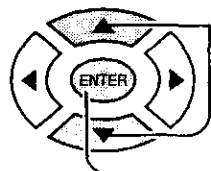

Select NORMALIZE with the up ▲ and down ▼ buttons.

Press ENTER button.

- To return to normal viewing →



Press TV MENU button.

Adjusting screen position and size

1



Press to select the screen mode to adjust screen position and size.

For adjusting position

ZOOM mode

For adjusting size

NORMAL and JUST mode

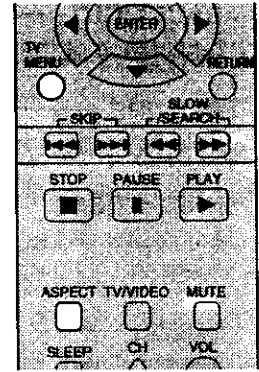

2



Press to display the MENU screen.

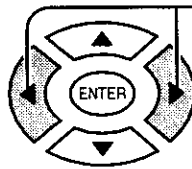

Press to select ADJUST menu.

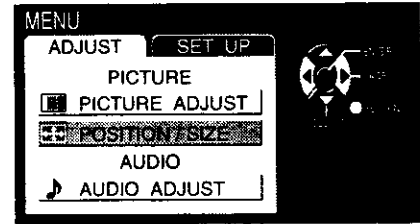

3 Adjusting position

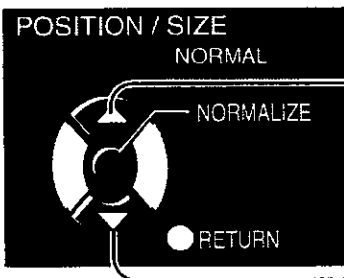

Press to move image upwards.

Press to move image downwards.

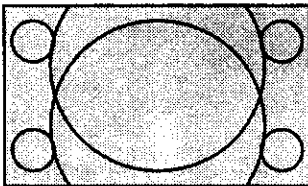

3 Adjusting size

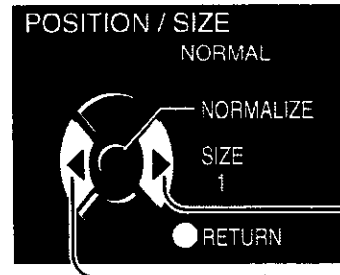

Press to narrow.

Press to widen.

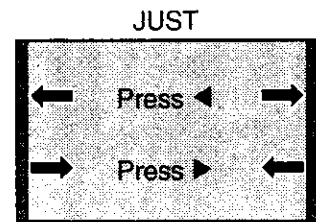
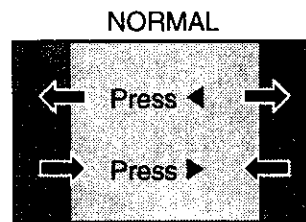

- To return to standard → Press ENTER
- To end adjustments → Press MENU (RETURN)

Notes:

- This TV is equipped with various screen modes. If a screen mode with a different aspect from the broadcast program is selected, the image will appear distorted. Select the proper screen mode with this in mind.
- Be careful when using this TV for commercial purposes or for public use, such as in cafes and hotels, as shrinking and enlarging images by using screen mode switching function (zoom, etc.) may violate copyright laws.
- Images displayed on a wide screen TV will be cut off or distorted at the edges, when viewing normal aspect images of 4:3 in ZOOM, JUST or FULL mode. Display in NORMAL mode to view the original image intended by the producer.
- The adjusted setting will remain even when the TV is turned off.
- The signals output from the output terminal on the left of the TV are not affected when the screen size and position are adjusted.

Audio Adjustments

1 Press the TV MENU button to display the MENU screen and select ADJUST.

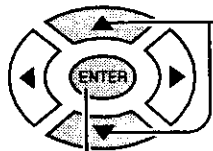

Press to select to AUDIO ADJUST.

Press to display the AUDIO ADJUST screen.

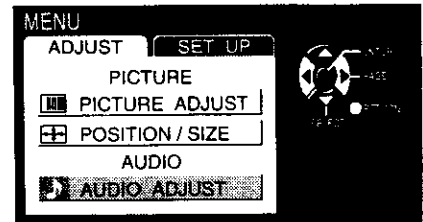

2

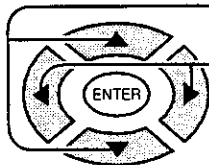

Press to select the menu to adjust each item.

Select the desired level by listening to the sound.

BASS
Adjusts low sounds

TREBLE
Adjusts high sounds

BALANCE
Adjust left and right volume

SURROUND
To enjoy a concert hall effect, turn SURROUND to ON when stereo is playing.
(See page 26)

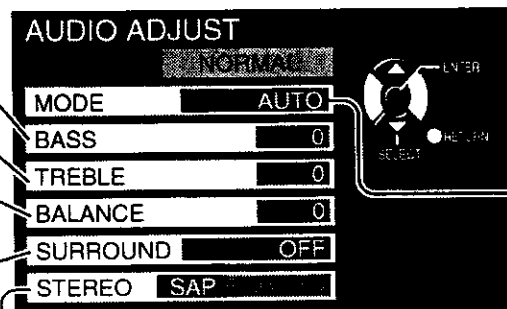

Selecting STEREO/
SAP/MONO.
(See page 26)

AUTO

AUTO

Automatically adjusts quiet sound and loud sound for ease of listening.



STANDARD

STANDARD

Emits the original sound.



DYNAMIC

DYNAMIC

Gives contrast to sound.



MUSIC

MUSIC

For programs consisting mainly of music. Enhances high sounds (around 4 kHz).

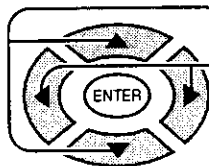

To reset to standard setting, select NORMAL with the up ▲ and down ▼ buttons and press ENTER.

To adjust settings individually, press the up ▲ and down ▼ buttons to select the desired menu and adjust using the left ◀ and ▶ right buttons.

TV
MENU



Press to end.

Selecting STEREO/SAP/MONO

Press the TV MENU button to display the MENU screen and select AUDIO ADJUST screen.

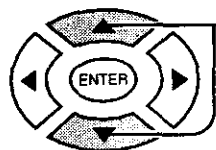

Press to select STEREO/SAP/MONO.

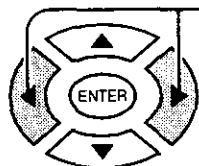
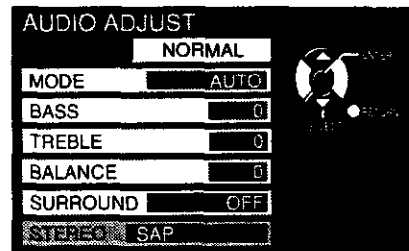

Press to select STEREO/SAP/MONO.



Press to end.

Helpful Hints:

- **STEREO** - Two channel Audio reception.
- **SAP** - Second Audio Programming (typically used for bilingual audio).
- **MONO** - Use when stereo signal is weak.

SURROUND Control

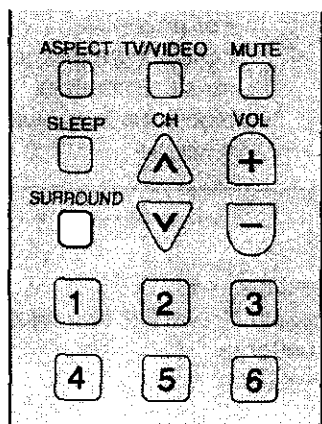

SURROUND



SURROUND Button

The benefits of surround are astounding. You can be completely enveloped in sound, just as if you were at a concert hall or cinema.

The surround setting switches on and off each time the SURROUND button is pressed.

SURROUND OFF
↑
SURROUND ON

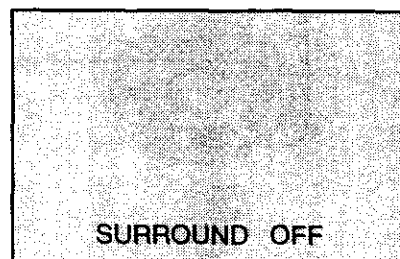

Notes:

- The surround settings are memorized separately for each SOUND mode (AUTO, STANDARD, DYNAMIC, MUSIC).
- Even from the MENU screen the surround setting is possible.
- See page 40 for DVD and CD operation.

Customizing the VIDEO INPUT labels

Display for each VIDEO INPUT can be changed to match with the connected device (VCR, DVD Player).

Example: When changing VIDEO to LD.

1 Press the TV MENU button to display the MENU screen and select SET UP.

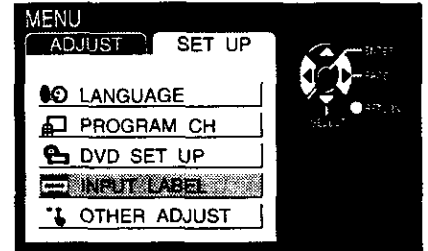
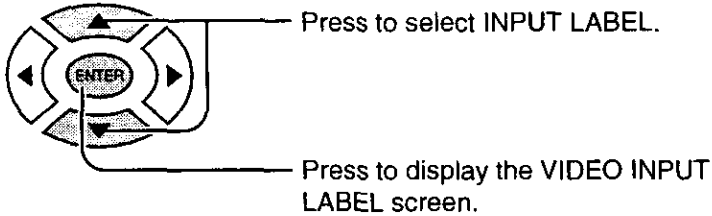

2 Press to change.

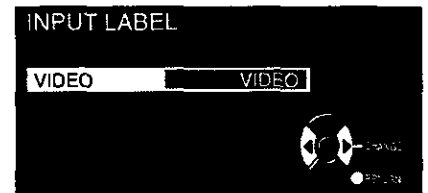
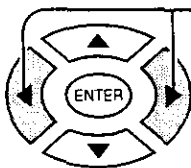

By pressing this button, display changes as follows:

```

          VIDEO  →  VCR  →  LD
          BLANK ←  DTV ←  DVD ←  GAME
        
```

This button rotates in reverse.

TV MENU



Press to end.

Natural Color

This feature allows you to set a natural color for the picture.

1 Press the MENU button to display the MENU screen and select SET UP.

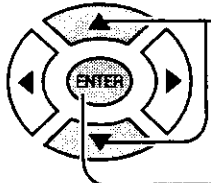
2  Press to select OTHER ADJUST.

Press to display the OTHER ADJUST screen.

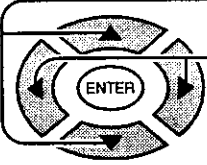
3  Press to select NATURL CLR.

Press to turn NATURL CLR ON.

TV MENU



Press to end.

Note:

Not available for DVD/CD mode.

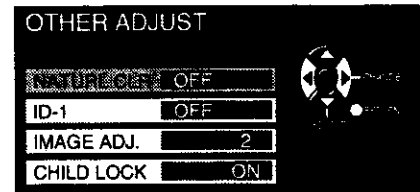
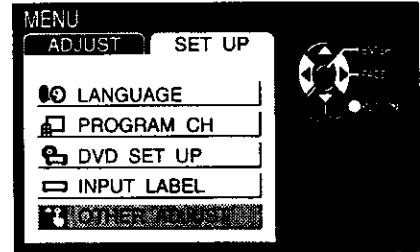

Automatically changing screen size for VIDEO INPUT modes (ID-1)

If the received signal contains screen size specifications in VIDEO INPUT the screen size is automatically changed.

1 Press the MENU button to display the MENU screen and select SET UP.

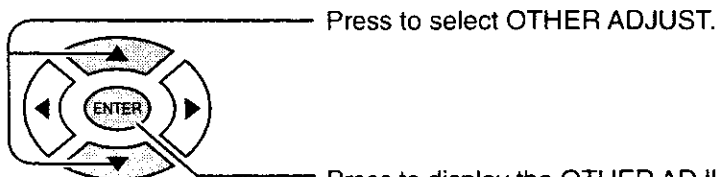

Press to select OTHER ADJUST.

Press to display the OTHER ADJUST screen.

2  Press to select ID-1 (Image Detection).

Press to set.

ON : When screen size specification signals are detected, ASPECT mode is automatically changed.

OFF : ASPECT mode is not automatically changed. (Turn OFF if this function does not operate properly.)

TV MENU



Press to end.

Note:

When ID-1 is detected, ASPECT mode changes to FULL.

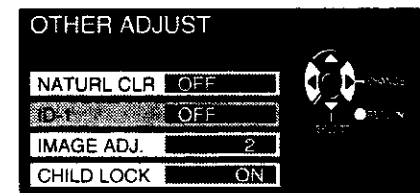
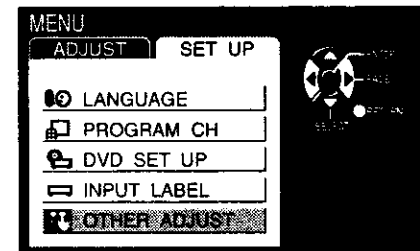

To eliminate noise at the top and bottom of the screen (IMAGE ADJ.)

1 Press the MENU button to display the MENU screen and select SET UP.

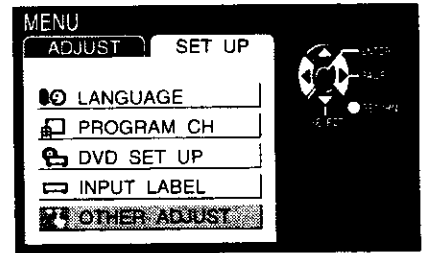
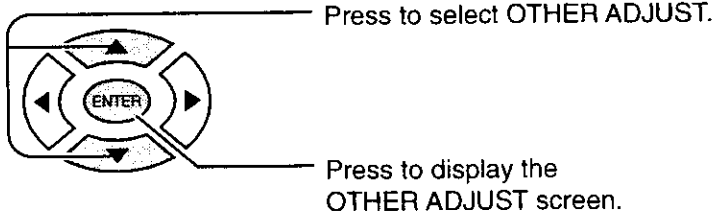

2 Press to select IMAGE ADJ.

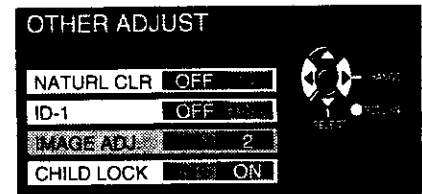
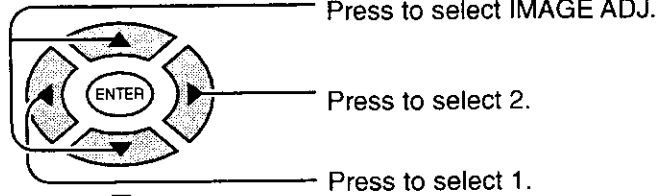

Press to end.

(Example)

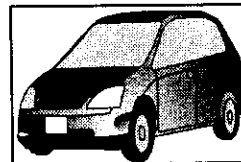

Select 1

(Example)

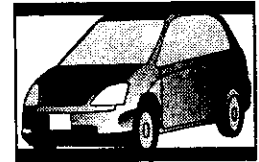

Select 2

Notes:

- IMAGE ADJ. settings are stored for TV, VIDEO and DVD each.
- This setting will not change during ZOOM.



DVD/CD Operation Guide

Features of DVD on this Product

High picture quality

- **10 bit video D/A converter**
Reproduces fine images faithfully.
- **An array of picture quality modes yielded by digital processing**
Signal deterioration is kept to minimum by processing the data digitally.
This feature can be used to tailor picture quality for DVD playback.

High sound quality

- **96 kHz/24 bit audio D/A converter**
This player enables 96 kHz/24 bit linear PCM signals, the highest specifications in DVD standards, to be reproduced faithfully. To support 96 kHz sampling/24 bit sound, the shaping noise of this multilevel digital sigma type D/A converter is kept flat up to 44 kHz, thus preventing the audio signals from being affected in any way. This means sound is reproduced faithfully.
- **Dolby Digital/dts (digital theater systems) digital output (See pages 45, 47.)**
By connecting a Dolby Digital/dts decoder or an amplifier incorporating a Dolby Digital/dts decoder, you can enjoy high quality digital surround sound from Dolby Digital/dts discs.

Graphical User Interface (GUI) screen (See pages 44 to 47.)

By simply pressing the DISPLAY button on the remote control, information on the DVD/Video CD/CD player and disc can be displayed on the TV screen for easy identification. The player's operations and settings can be easily accessed by operating the remote control while monitoring the TV screen. The color and position of the GUI screen can be changed.

Versatile DVD features

- **Multi-audio function (See pages 42, 45, 49.)**
The audio soundtrack can be heard in up to 8 languages. (The number of languages depends on the software.)
- **Multi-subtitle function (See pages 43, 45, 49.)**
Subtitles may be displayed in one of 32 languages. (The number of languages depends on the software.)
- **Multi-angle function (See pages 43, 45.)**
This function allows you to choose the camera angle of scenes shot from different angles. (Limited to DVDs recorded with multiple camera angles.)
- **Parental lock function (See page 50.)**
This function can prevent playback of DVD software which may be unsuitable for some audiences (especially for children). (Limited to DVDs encoded with specific rating level.)

Disc formats supported by this player

The player can playback discs bearing any of the following marks:



Discs which cannot be played with this player

- DVD with Region No. other than "1" or "ALL"
- DVD-ROM
- DVD-AUDIO
- CDV
- CD-G
- Divx Video Disc
- CVD
- DVD-R/DVD-RAM
- DVD-AUDIO
- CD-RW
- Do not try to play Photo CD or CD-R. (Data on the disc may be damaged.)
- SVCD
- CD-ROM
- CD-RW
- Do not try to play Photo CD or CD-R. (Data on the disc may be damaged.)
- VSD
- DVD + RW etc.
- Do not try to play Photo CD or CD-R. (Data on the disc may be damaged.)

Region Management Information

This player is designed to respond to the Region Management Information recorded on DVDs. The region number of this player is "1". If the region number described on the DVD does not correspond to the region number of this player, this player cannot play this disc. This player will play DVDs made for "ALL" regions. This player will play DVDs marked with labels containing the region number "1" or "ALL".

Example:

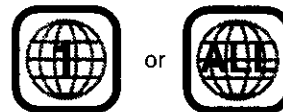

Features of DVD on this Product

Enjoying digital audio output from the digital audio output connector

Optical digital audio output connector

Disc	Sound recording format	Optical digital audio output from connector
DVD	Dolby Digital	Dolby Digital bitstream (1–5.1ch) or PCM (2ch) (48 kHz/16 bit)* ¹ * ²
	Linear PCM (48/96 kHz 16/20/24 bit)	Linear PCM (2ch) (48 kHz sampling/16 bit only) or no output* ¹
	dts	Dts bitstream (1–5.1ch)* ¹
Video CD	MPEG 1	PCM (44.1 kHz sampling)* ²
CD	Linear PCM	Linear PCM (44.1 kHz sampling)
	dts* ³	Dts bitstream (1–5.1ch)* ¹

*¹ The type of audio output from the connector can be selected by "7 Digital Audio Output" of the initial settings. (See page 52.)

*² Compressed sound converted to PCM will be output.

*³ The settings and connections necessary to enjoy CDs recorded in dts are the same as for DVDs recorded in dts.

Note:

- Some dts decoders which do not support DVD-dts interface may not work properly with the DVD/Video CD/CD player.

For your reference:

- Dolby Digital is a digital sound compression technique developed by the Dolby Laboratories, Inc. Supporting 5.1-channel surround sound, as well as stereo (2-channel) sound, this technique enables a large quantity of sound data to be efficiently recorded on a disc.
- The digital theater system (dts) is a 5.1-channel surround sound system, which is widely used in movie theatres around the world. It allows the bit rate to be increased in order to provide good sound quality without excessively compressing the data.
- Linear PCM is a signal recording format used in a CD. While a CD is recorded in 44.1 kHz/16 bit, a DVD is recorded in 48 kHz/16 bit up to 96 kHz/24 bit.
- If you have a Dolby Pro Logic Surround decoder, you will obtain the full benefit of Pro Logic from the same DVD movies that provide full 5.1-channel Dolby Digital soundtracks, as well as from titles with the Dolby Surround mark.
- The digital audio output connector (optical) converts electrical signals into optical signals and transfers them to an amplifier. These optical signals are immune from electrical interference, and they also have minimal effect on other equipment.

Caution for the optional digital audio output connector:

- Do not connect to the digital audio input of an amplifier that does not have Dolby Digital/dts/MPEG audio decoder.
- If such an amplifier should be connected to the player with "Bitstream" selected at the "2 Dolby digital", any attempt to play DVDs (or CDs recorded in dts) may cause such a high level of noise that it may be harmful to your ears and damage your speakers.
- Video CDs and CDs can be played as they would normally be played.

Manufactured under license from Dolby Laboratories. "Dolby", "Pro Logic" and the double-D symbol are trademarks of Dolby Laboratories. Confidential Unpublished Works. © 1992-1997 Dolby Laboratories, Inc. All rights reserved.

Manufactured under license from Digital Theater Systems, Inc. "DTS" and "DTS Digital Surround" are trademarks of Digital Theater Systems, Inc. © 1996 Digital Theater Systems, Inc. All rights reserved.

Apparatus Claims of U.S. Patent Nos. 4,631,603; 4,577,216; 4,819,098 and 4,907,093 licensed for limited viewing uses only.

This product incorporates copyright protection technology that is protected by method claims of certain U.S. patents and other intellectual property rights owned by Macrovision Corporation and other rights owners. Use of this copyright protection technology must be authorized by Macrovision Corporation, and is intended for home and other limited viewing uses only unless otherwise authorized by Macrovision Corporation. Reverse engineering or disassembly is prohibited.

Location of Controls for DVD Operation

Switches angles when scenes taken from several angles are being played.
(See page 43.)

Used to eject DVD or CD.

Turns the power ON and OFF when the power on the TV is ON.

Displays disc information and settings when pressed during play. (See pages 40 to 47.)

Displays the menu for discs with several titles recorded. (See page 37, 39.)

Displays the menu for DVDs with several menus. (See page 37, 39.)

Searches the beginning of a scene or song. (See page 38.)

Used to make selections, SELECT Key adjustments and settings. (See page 13.)

Stops operation of disc. (See page 37.)

For fast forwarding and re-winding or slow play. (See page 38.)

Pauses movies and music or forwards frames. (See page 38.)

Plays the disc. (See page 36.)

Select sound field. (See page 40.)

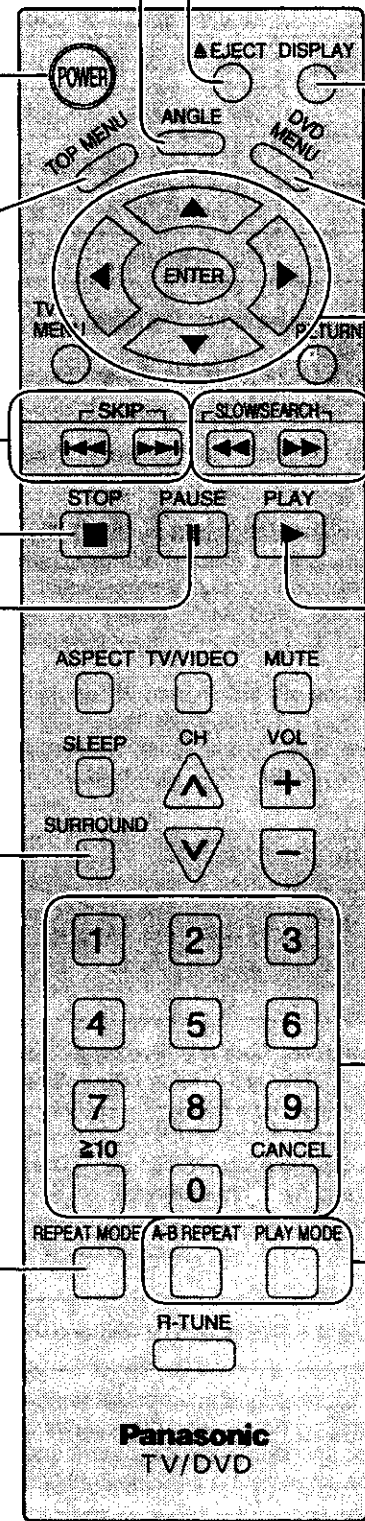

Selects groups. (See page 41.)

Used to select menus, songs, set time and input passwords.

Selects still pictures and play modes. PLAY MODE : CD ONLY. (See page 41.)

Functions of front operation panel

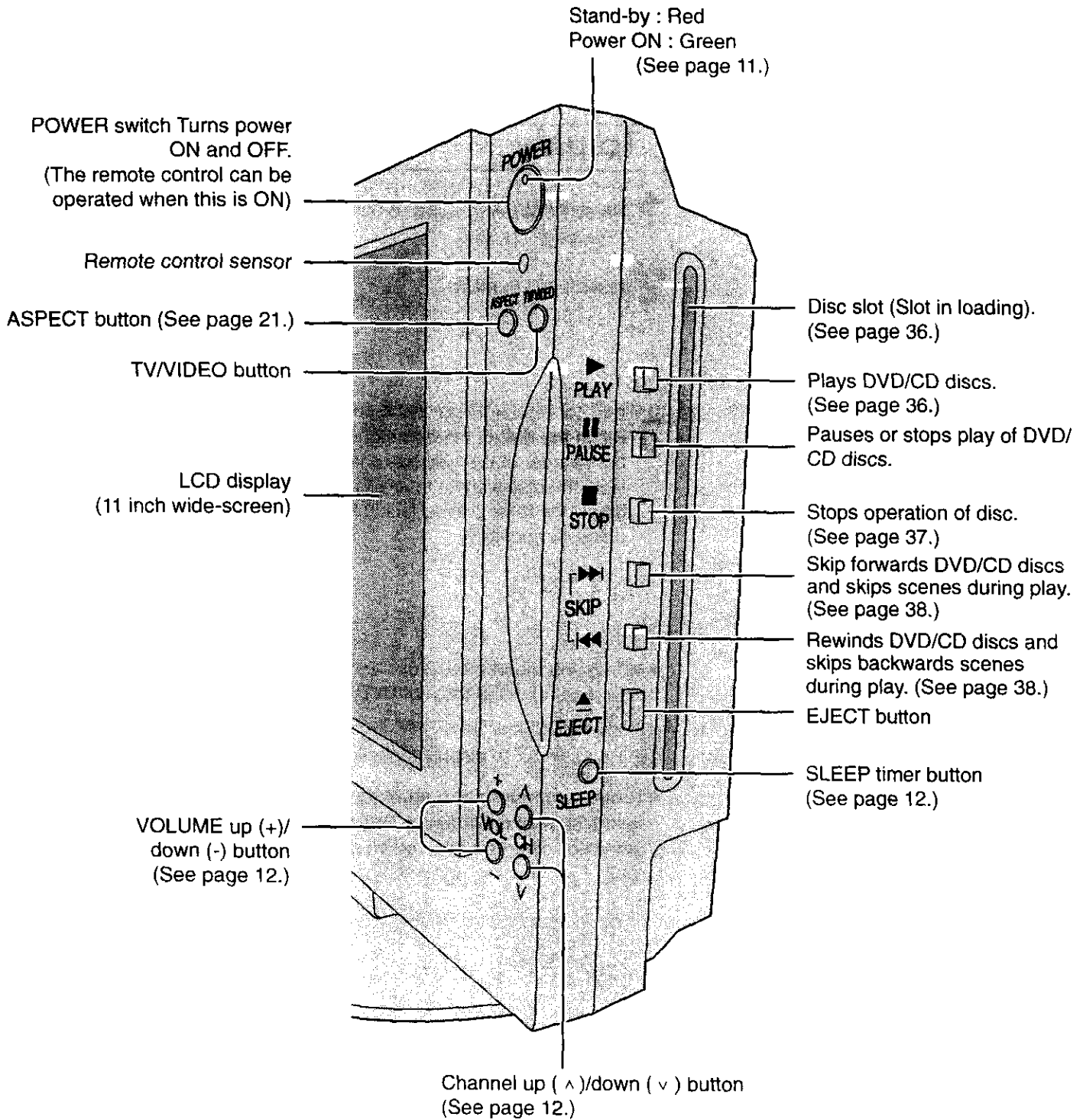

Basic play

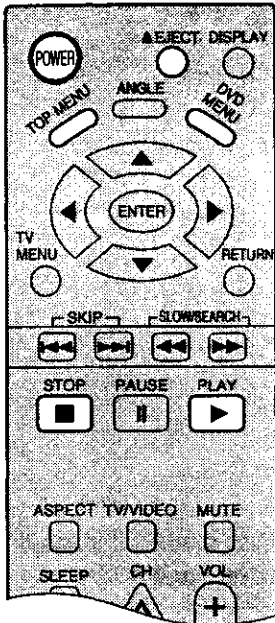

Before enjoying DVD/Video CD/CD

The On-Screen menu language of your player has been factory preset to English.

You can change the menu language to French or Spanish. Refer to "Selecting On-Screen Display menu language" on page 52.

In the explanations given below it is assumed that English has been selected as the menu language.

To play

1 Press POWER to switch on the power.
(See page 34, 35.)

2 Insert DVD to play.

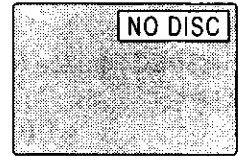

3 Place the disc in the disc slot with the label side to be played facing frontwards. (If the disc has a label)
Hold the disc without touching either of its surfaces, position it with the label side to be played facing frontwards, align it with the guides, and place it in position.

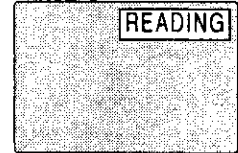

• When you insert a DVD or CD, loading will be carried out automatically and reading of the track of DVD or CD will begin.

4 Press PLAY to display the following:

• **When a menu screen appears on the TV.**

In the case of many movie DVDs, an interactive DVD, or a Video CD with playback control, a title screen appears on the TV. Perform step 5 to start play.

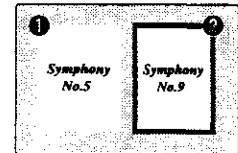

(Example of DVD)

5 Press SELECT (▲, ▼, ◀, ▶) button to select the title and press ENTER.

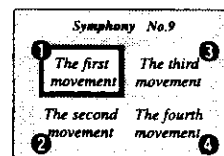

(Example)

Play of the selected title now begins.

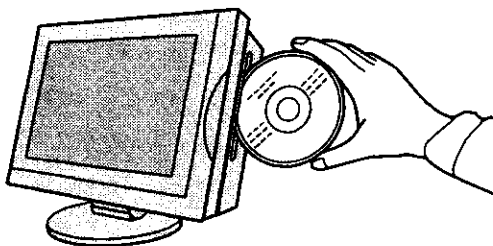
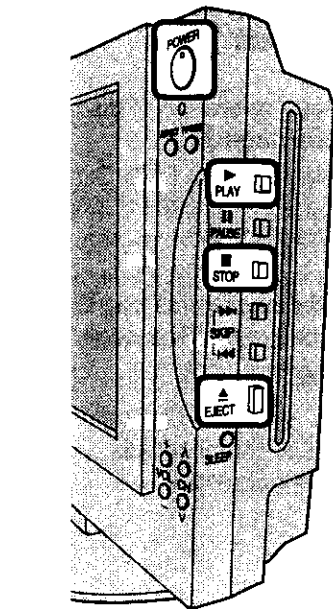

When the menu continues onto another screen

After step 3 on page 36, press SKIP (▶▶).

- To return to the previous menu screen Press SKIP (◀◀)
- Due to the design of some software titles, SKIP (◀◀, ▶▶) may not always work. For operation, refer also to the jacket of the disc concerned.

Stopping play and returning to the menu screen

Press DVD MENU or TOP MENU.

Play is suspended, and the menu screen is displayed.

- The buttons may not work depending on the disc used.

After operation

When the player is not in use, remove the disc and press POWER to set the player to the standby mode.

What is playback control?

If a Video CD has "playback control" written on its disc or jacket, it means that particular scenes or information can be selected for viewing interactively with the TV monitor using the menu screen.

Note:

- The disc continues to rotate while the menu is displayed even after the player has finished playing a particular item. When no further selections are to be played, be sure to press STOP to clear the menu display.

For your reference:

- When ⊘ appears on the screen when a button is pressed, the operation is prohibited by the player or disc.

Stopping play

Press STOP during play.

RESUME function

The player records the point where STOP was pressed during play.

- Press PLAY again, and play will resume from this point.
- When the tray is opened or STOP is pressed again, the RESUME function will be cleared.

This feature remains active if the player is set to the standby mode and then turned back ON.

Notes:

- Cancelling the RESUME function will also clear the chapter review function.
- The chapter review function may not work with some DVDs.
- The DVD/CD disc may feel warm when removed from the product, however, this will not affect the quality or efficiency of the disc.

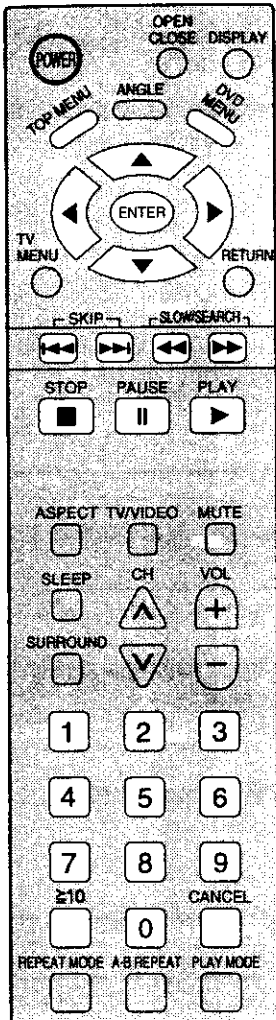

Skipping chapters or tracks

Press SKIP (◀◀, ▶▶) during play.

With the remote control

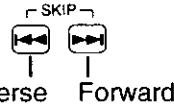

Reverse Forward

On the TV SET



Reverse Forward

For your reference:

- A chapter (DVD) or a track (Video CD/CD) is skipped each time the button is pressed.
- When SKIP (◀◀) is pressed once midway through a chapter/track, play returns to the start of that chapter/track. When it is pressed again, a chapter/track is skipped each time the button is pressed.
- When SKIP (◀◀, ▶▶) is pressed during menu play of Video CDs with playback control, a menu screen may sometimes be recalled.

Still picture (Pause)

Press PAUSE (||) during play.

- DVD/Video CD: The player will be placed in the still picture mode.
- CD: The player will be placed in the pause mode.
- Normal play is resumed when PLAY is pressed.



(DVD)

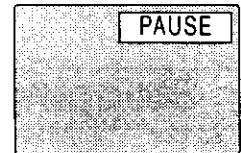

(CD)

Rapid advance (Rapid reverse)

Press SLOW/SEARCH (◀◀, ▶▶) during play.



Reverse Forward



(Example)

- The speed of advance (reverse) is relatively slow at first. When the button is pressed again, the speed increases up to 5 steps.
- Normal play is resumed when PLAY is pressed.

For your reference:

- When SLOW/SEARCH (◀◀, ▶▶) is used during menu play of Video CDs with playback control, a menu screen may sometimes be recalled.
- For DVDs and Video CDs, audio will be heard during scanning (forward direction only) at the initial scan speed. For CDs, audio will be heard during scanning at every scan speed (1 to 5). (For dts CDs, audio will not be heard at any speed.)

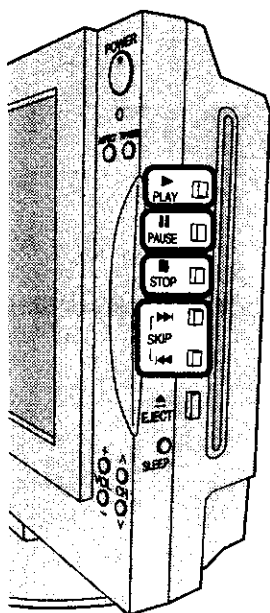

Frame advance (Frame reverse) [DVD/Video CD]

- 1 Press PAUSE button.
 - 2 Press SELECT (◀, ▶) in the still picture mode.
 - ◀ : Reverse
 - ▶ : Forward
- The disc is advanced (reversed) by one frame each time the SELECT (◀, ▶) is pressed.
 - When the SELECT (◀, ▶) is kept pressed, consecutive frame advance (reverse) works.
 - Normal play is resumed when PLAY is pressed.

Note:

- For Video CDs, frame reverse is not possible.

For your reference:

- Pressing PAUSE also activates frame advance.
- Whether the pictures are advanced by a "Frame" or "Field" is automatic.

Slow-motion play [DVD/Video CD]

- 1 Press PAUSE button.
- 2 Press SLOW/SEARCH (◀◀, ▶▶) in the still picture mode.

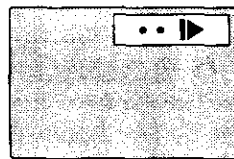
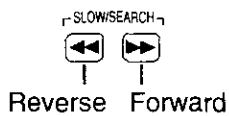

(Example)

- The speed of slow-motion is slow at first. When the button is pressed again, the speed increases up to 4 steps.
- Normal play is resumed when PLAY is pressed.

Note:

- For Video CDs, slow-motion playback in reverse direction is not possible.

Cancelling playback control [Video CD]

- 1 Press STOP after the menu screen appears .
- 2 Press the numeric buttons to select a track. (Play begins.)

- Refer to the jacket etc. of the disc concerned for the track numbers.
- Press "1" to start play from the beginning of the disc.

To return to menu play

Press STOP to stop playback and press DVD MENU.

Using a TOP MENU [DVD]

Some movie discs may have two or more titles. If the disc has a title menu recorded on it, pressing TOP MENU shows the title menu screen. (The details of operation depend on the disc used.)

- 1 Press TOP MENU during play. A list of the titles on the disc is now displayed.

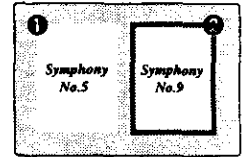

(Example)

- Pressing TITLE again resumes play from the scene when TITLE was first pressed.

- 2 Press SELECT (▲, ▼, ◀, ▶) button to select the item and press ENTER or PLAY.

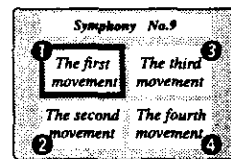

(Example)

The selected title now starts playing.

Using a DVD MENU [DVD]

Some DVDs have unique menus. These menus can be for language selection, audio output selection and/or subtitle language selection, etc. Although the DVD menu's contents and operation differ from disc to disc, the following explains basic operation when this feature is used:

- 1 Press DVD MENU during play. The DVD menu available on the disc is now displayed.

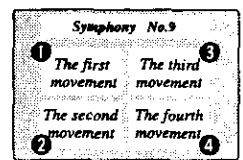

(Example)

- Pressing DVD MENU again resumes play from the scene when DVD MENU was first pressed.

- 2 Press SELECT (▲, ▼, ◀, ▶) button and then press ENTER, or press the numeric buttons, to select the item.

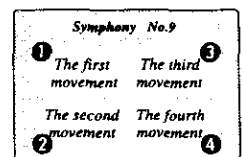

(Example)

The selected title now starts playing.

When the menu continues onto another screen

Repeat step 2.

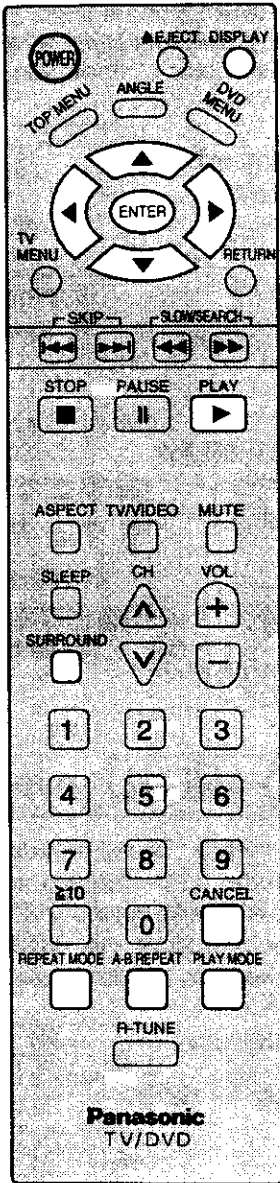

Random play [CD]

Two way setting method for Random Play. (1.From play mode, 2.From display mode)

The player plays the tracks on the disc in random order.

Using PLAY MODE button

- 1 Press PLAY MODE button in the stop mode.
The program Random play screen appears on the screen.
- 2 Press PLAY MODE button again, the Random play screen changes "OFF" to "ON".

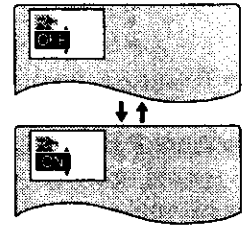

(Example)

Using GUI screen

- 1 Press DISPLAY button and display Random play screen.
- 2 Press SELECT (◀, ▶) to select Random Play.
- 3 Press SELECT (▲, ▼) button.
ON ↔ OFF



Selecting sound field

Two way setting method for Sound field.

Using GUI screen

- 1 Press DISPLAY button and display sound field screen.
- 2 Press SELECT (◀, ▶) to select sound field.
- 3 Press SELECT (▲, ▼) button.

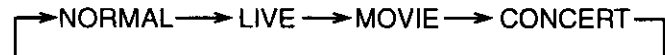
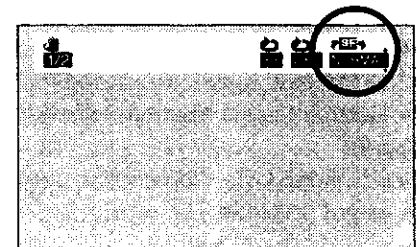

Using SURROUND button

During playback of disc, each time the SURROUND button is pressed, the sound field changes as shown below.

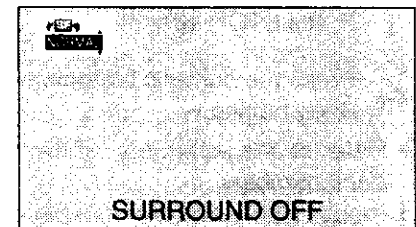

Repeat play

Repeat viewing (Listening)

Press REPEAT MODE during play.

Each time this button is pressed, the TV monitor changes as shown below and the disc will repeat a chapter, a title (DVD) or a track (Video CD/CD)

• DVD

Normal play



Repeat of chapter being played

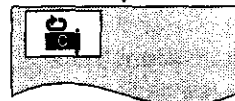

Repeat of title being played

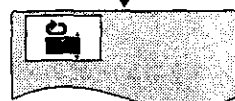

Cancel repeat mode (Normal play)



• Video CD / CD

Normal play



Repeat of track being played

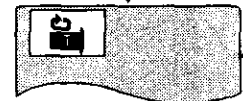

Repeat of entire disc contents

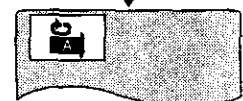

Cancel repeat mode (Normal play)



To return to normal play

Press REPEAT MODE until "OFF" is displayed.

Notes:

- Repeat play may not work correctly with some DVDs.
- Repeat play does not work with an interactive DVD or during menu play of a Video CD with playback control.

A-B repeat play

Repeating sections between two specific points (A-B repeat)

1 Press A-B REPEAT during play at the point where repeat play is to start (A).



2 Press A-B REPEAT at the point where repeat play is to be concluded (B).



Repeat play of the section between points A and B starts.

To return to normal play

Press A-B REPEAT until "OFF" is displayed.

Notes:

- A-B repeat play does not work with an interactive DVD.
- Some subtitles recorded around point A or B may fail to appear (DVD).
- A-B repeat play works only within a title (DVD) or a track (Video CD/CD).

For your reference:

- The end of a track or title is automatically determined as point B.

Changing audio soundtrack language [DVD]

It is possible to change the audio soundtrack language to a different language from the one selected at the initial settings if available. (See page 49.) This operation works only with discs on which multiple audio soundtrack languages are recorded.

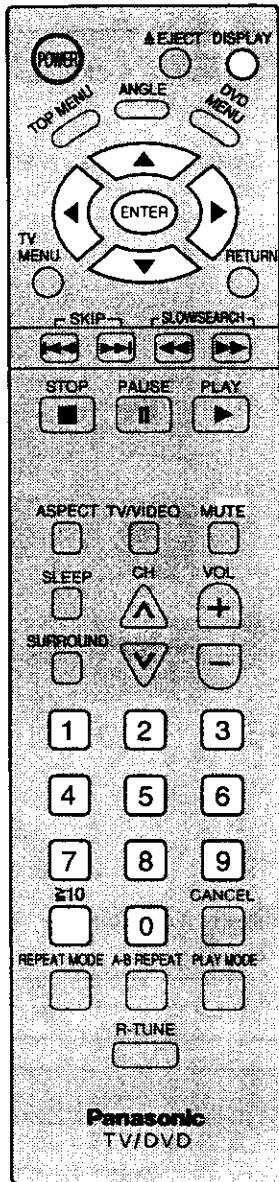

- 1** Press DISPLAY during play to display the disc information.
The program playback screen appears on the TV monitor.
 - When no audio soundtrack is recorded, “-” will be displayed instead of the language number.

- 2** Press SELECT (◀ , ▶) to select soundtrack language.

Number of the audio soundtrack language being played back

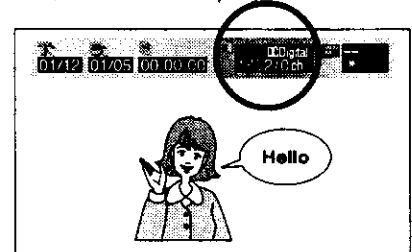

- 3** Press SELECT (▲ , ▼) to select the language.
Pressing the numeric buttons also changes the audio soundtrack language.

- Press DISPLAY to clear the display.

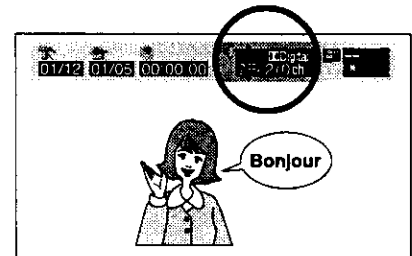

For your reference:

- When the preferred language is not selected, even after pressing the SELECT (▲ , ▼) button several times, it means that language is not available on the disc.
- When the power is turned on, or the disc is removed, the language heard is the one selected at the initial settings. If this language is not recorded on the disc, only the available language on the disc will be heard.

Changing subtitle language [DVD]

It is possible to change the subtitle language to a different language from the one selected at the initial settings if available. (See page 49.)

This operation works only with discs on which multiple subtitle languages are recorded.

- 1 Press DISPLAY button to display the player information.
 - When no subtitles are recorded, “—” will be displayed instead of the language number.

Number of the audio soundtrack language being played back

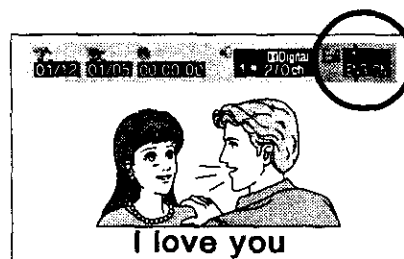

- 2 Press SELECT (◀ , ▶) to select SUBTITLE language item.

- 3 Press SELECT (▲ , ▼) to select the language.

Pressing the numeric buttons also changes the subtitle language.

- 4 Press SELECT (◀ , ▶) to select “ON OFF” item.

- 5 Press SELECT (▲ , ▼) to select subtitle “ON” or “OFF”.



To clear/display the subtitles

Press the RETURN button to clear the display.

For your reference:

- When the preferred language is not selected, even after pressing the SELECT (▲ , ▼) several times, it means that language is not available on the disc.
- When the power is turned on, or the disc is removed, the language heard is the one selected at the initial settings. If this language is not recorded on the disc, only the available language on the disc will be heard.

Viewing from another angle [DVD]

Some DVDs contain scenes which have been shot simultaneously from a number of different angles. For these discs, the same scene can be viewed from these different angles with the ANGLE button. (The angles depend on the disc used.)

- 1 Press ANGLE during play.

Number of angle being played back

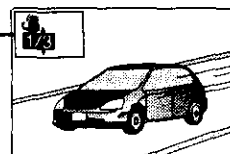

- 2 Press SELECT (▲ , ▼) to select the angle.

Pressing the numeric buttons also changes the angle.

- Press ENTER to clear the display.

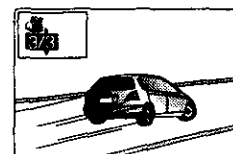

Note:

- This function only works for titles having scenes recorded at different angles.

General information about GUI screens

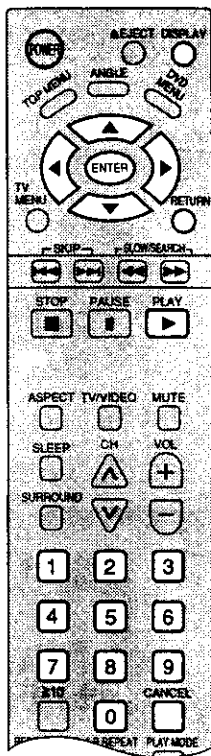

This player features GUI (Graphical User Interface) screens providing various functions. A “banner” will be displayed on the TV when DISPLAY button on the remote control is pressed. Operating the SELECT/ENTER button on the remote control will show disc information (title/chapter/track number, elapsed playing time, audio/subtitle language, and angle) and player information (repeat play, A-B repeat play, play mode, etc.). Some icons allow the settings to be changed.

Common procedures

1 Press DISPLAY during play or in the stop mode.

Each time this button is pressed, the TV monitor changes as shown below.

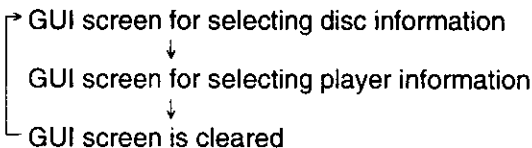

- Some functions cannot be accessed from the stop mode.

2 Press the SELECT (◀ , ▶) button to select the item.

- The currently selected item is indicated by the yellow frame on the GUI screen.

3 Press the SELECT (▲ , ▼) button to select the setting.

- For some functions, the setting will be registered immediately; for others, ENTER or PLAY must be pressed.
- When numbers are displayed (e.g. title No.), the numeric buttons are also effective for setting instead of the SELECT (▲ , ▼) button. When numbers are entered with numeric buttons, press ENTER to register the setting.

Press RETURN to clear the GUI screen.

Examples of GUI screens

See **A** , **B** and **C** for detailed illustration. The screens depend on the disc contents.

For your reference:

- The GUI screens may not be displayed when playing some kinds of DVD software.

A DVD

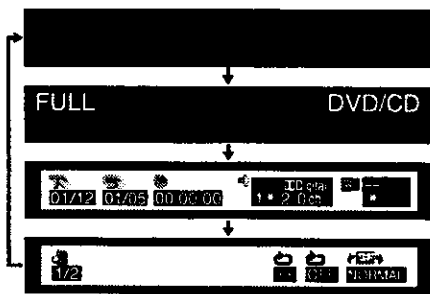

B Video CD

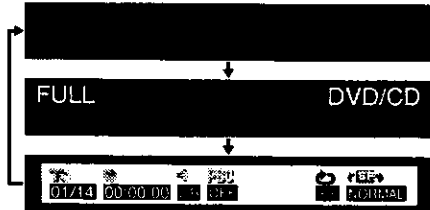

C CD

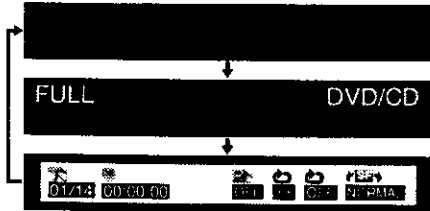

Screen for disc information (For DVD)

Title No.	Change the title No. with time SELECT (▲, ▼) button or the numeric buttons and press ENTER.
Chapter No.	Change the chapter No. with the SELECT (▲, ▼) button or the numeric buttons and press ENTER.
Elapsed playing time (hour: minute: second)	Change the time with the numeric buttons and press ENTER. Example: To specify "1 hour 10 min. 37 sec.", enter "11037". (This function does not work with some discs.)
Angle No. (See page 43.)	Change the No. with the SELECT (▲, ▼) button or the numeric buttons.
A-B repeat play (See page 41.)	Press ENTER during to store location A and press ENTER again to store location B. Repeat play between the two locations starts. Press ENTER again to return to normal play.



Audio soundtrack language No. (See page 42.)		Change the No. with the SELECT (▲, ▼) button or the numeric buttons.	
Audio soundtrack language		ENG: English FRA: French DEU: German ITA: Italian ESP: Spanish NLD: Dutch SVE: Swedish NOR: Norwegian DAN: Danish	POR: Portuguese RUS: Russian JPN: Japanese CHI: Chinese KOR: Korean MAL: Malay VIE: Vietnamese THA: Thai *: Other
Audio attribute	LPCM	96k or 48k	16b 20b 24b Linear PCM ("k" stands for kHz and "b" stands for bit.)
	Digital	1ch-3/2.1ch*	Dolby Digital
	DTS	-	dts surround

Repeat play (See page 41.)	Select the mode during play with the SELECT (▲, ▼) button.	
	OFF	Normal play
	C	Chapter repeat play
	T	Title repeat play

Sound field	Select the mode during play with the SELECT (▲, ▼) button. When sound quality is selected, playback is done with that effect.
	NORMAL: Normal sound quality LIVE: Sound quality like a live performance MOVIE: Sound quality like a movie theater CONCERT: Sound quality like a concert hall

Subtitle language No. (See pages 54.)	Change the No. with the SELECT (▲, ▼) button or the numeric buttons.		
Sub language	ENG: English FRA: French DEU: German ITA: Italian ESP: Spanish NLD: Dutch SVE: Swedish NOR: Norwegian DAN: Danish	POR: Portuguese RUS: Russian JPN: Japanese CHI: Chinese KOR: Korean MAL: Malay VIE: Vietnamese THA: Thai *: Other	
	Subtitle on/off	Select "ON" or "OFF" with the SELECT (▲, ▼) button.	
	OFF	Subtitles cleared.	
	ON	Subtitles displayed.	

Example:
3/2.1ch

- 0: No low frequency effect (for subwoofer)
 - 1: Low frequency effect (for subwoofer)
- 0: No Surround
 - 1: Mono Surround
 - 2: Stereo Surround (left/right)
- 1: Center
 - 2: Front left + Front right
 - 3: Front left + Front right + Center

Notes:

- Repeat play does not work with an interactive DVD or during menu play of a Video CD with playback control.
- A-B repeat play does not work with an interactive DVD.
- It is not possible to change the play mode using the GUI screen.

For your reference:

- "▲, ▼" around the icon means that the item can be changed with the SELECT (▲, ▼) button.



General information about GUI screens

Screen for disc information (For Video CD/CD)

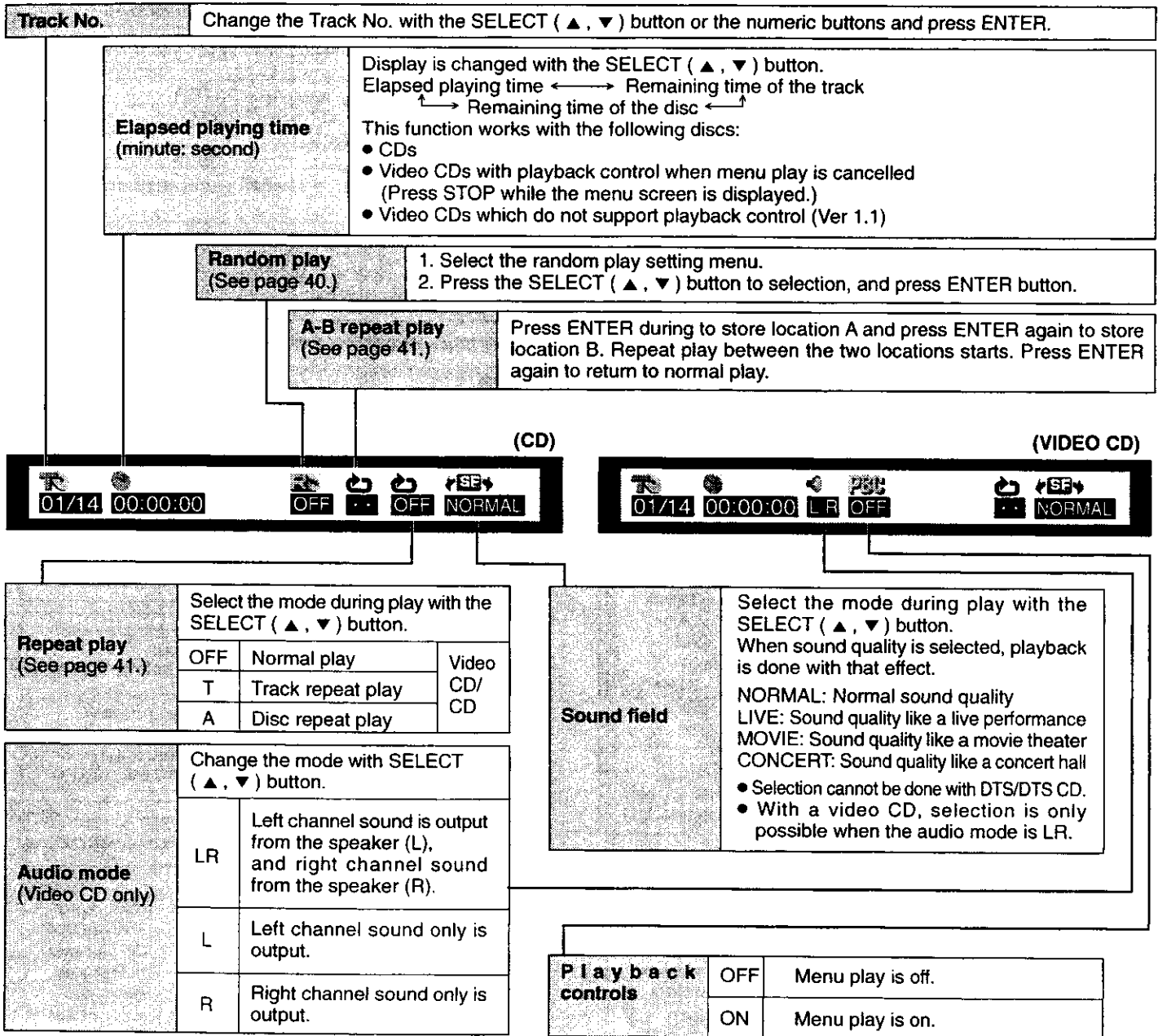

Notes:

- Track No. and the elapsed playing time are not displayed during menu play of Video CDs with playback control.
- It is not possible to turn playback control ON or OFF using the GUI screen.
- Repeat play does not work with an interactive DVD or during menu play of a Video CD with playback control.
- A-B repeat play does not work with an interactive DVD.
- It is not possible to change the play mode using the GUI screen.









For your reference:

- “▲, ▼” around the icon means that the item can be changed with the SELECT (▲, ▼) button.

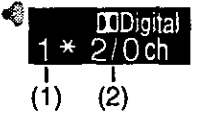

GUI screen reference chart

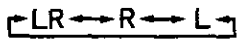
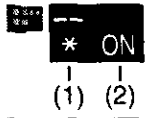



Disk information screen

 02/12	Title no. (DVD) Track no. (CD, video CD)	When you select a no. and press [Set], playback of that title/track begins. (Selection can also be made using the numerical buttons)
 02/05	Chapter no. (DVD)	When you select a no. and press [Set], playback of that chapter begins. (Selection can also be made using the numerical buttons)
 00:00:00	Elapsed time (DVD)	If you designate the time for starting playback with the numerical buttons, playback begins from that time. Example: To start playback after 1 hour, 6 minutes and 37 seconds, [1] → [10] → [6] → [3] → [7] → press [Set].
 00:00:00	Time display (CD, video CD)	During playback, this changes the display each time [▲] or [▼] is pressed. Track elapsed time ↔ Track remaining time ↔ Disc remaining time
 Digital 1 * 2/0 ch (1) (2)	Audio information (DVD)	When a no. is selected, playback begins with that audio. (1) Audio language allocated to no. (See page 45) (2) Audio attributes allocated to no. (See page 45)
 LR	Audio mode switching (Video CD)	When a channel is selected, playback is done with that audio. 
 * ON (1) (2)	Subtitle no. (DVD)	When a no. is selected, subtitles are displayed in that language. (1) Subtitle language allocated to no. (See page 45) (2) Select subtitle "On" or "Off".
 PBC ON	Playback control (Video CD)	This displays the "On" "Off" state of menu playback. (Content cannot be changed).
 1/2	Angle no.	When a no. is selected, playback is seen from that angle.

Audio attributes

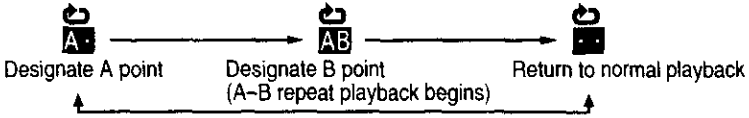
• LPCM /  Digital / DTS :Signal type • k :Sampling frequency • b :Number of bits • ch :Number of channels

Information screen for this device

 AB	Repeat playback between A and B	Playback is repeated between the designated 2 points. Each time [Set] is pressed during playback, the setting cycles are as indicated below.  • This is only possible in the same chapter (same title if there are no chapter divisions) (DVD), or the same track (video CD, music CD). • If the chapter(title)/track ends before the end point B is designated, the start point A is cancelled.
 OFF	Repeat playback	When the playback type is selected, repeat playback begins. • For DVD C ↔ T ↔ OFF (Chapter) (Title) (Normal playback) • For CD, video CD T ↔ A ↔ OFF (Track) (Entire disk) (Normal playback)
 SE NORMAL	Sound field	When sound quality is selected, playback is heard with that effect. NORMAL: Normal sound quality LIVE: Sound quality like a live performance MOVIE: Sound quality like a movie theater CONCERT: Sound quality like a concert hall • Selection cannot be done with DTS/DTS CD. • With a video CD, selection is only possible when the audio mode is LR.
 OFF	Random playback (CD)	Select "On" "Off" for random setting. If "On" is selected, random playback is used for playback.

Initial settings

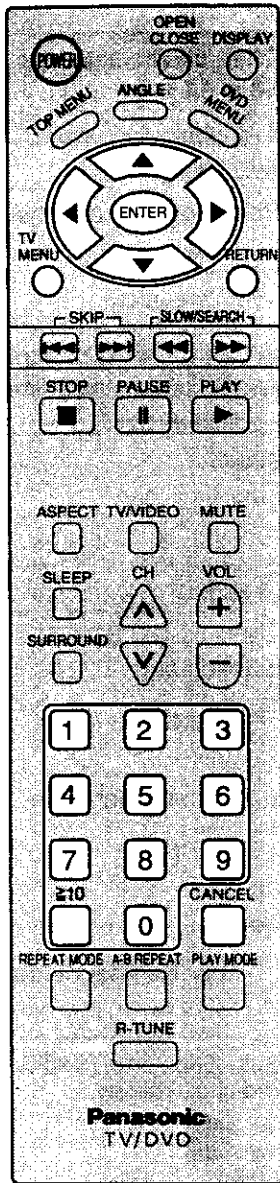

Once the initial settings have been completed, the player can always be operated under the same conditions (especially DVDs). The settings will be retained in the memory, until the settings are changed, even after switching to standby mode.

Common procedures

- 1 Press TV MENU to display menu screen during stop mode.
- 2 Press SELECT (◀, ▶) button to select SET UP.

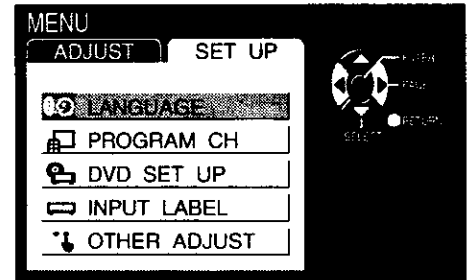

- 3 Press SELECT (▲, ▼) button to select DVD SET UP, and press ENTER.

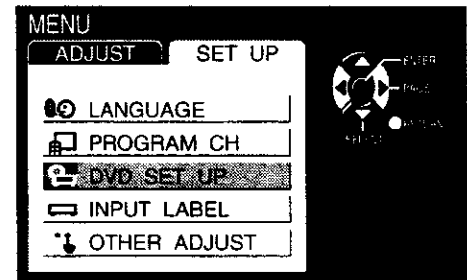

- 4 Press SELECT (◀, ▶, ▲, ▼) button to select the menu setup.

Each screen for setting the value is displayed.

DISC MENU

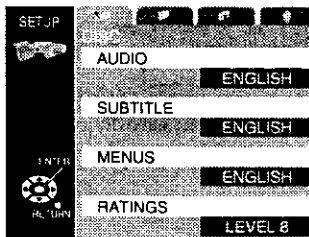

(See pages 49 to 51)

VIDEO MENU

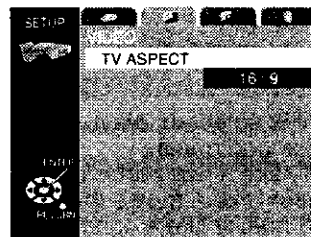

(See page 51)

DISPLAY MENU

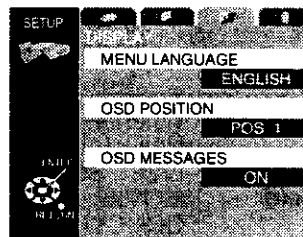

(See page 52)

AUDIO MENU

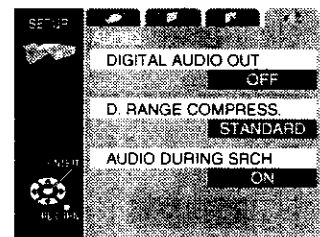

(See pages 52, 53)

DISC MENU

These settings allow you to choose the languages used when a DVD is played. If the language selected is not available on the disc, the language designated by each disc will be selected. There are cases where the selected language recorded by the disc designates another language.

■ Press the SELECT (◀ , ▶) button to select DISC menu and to set following steps.

■ Selecting AUDIO language [DVD]

1 Press the SELECT (▲ , ▼) button to select AUDIO and press ENTER button.

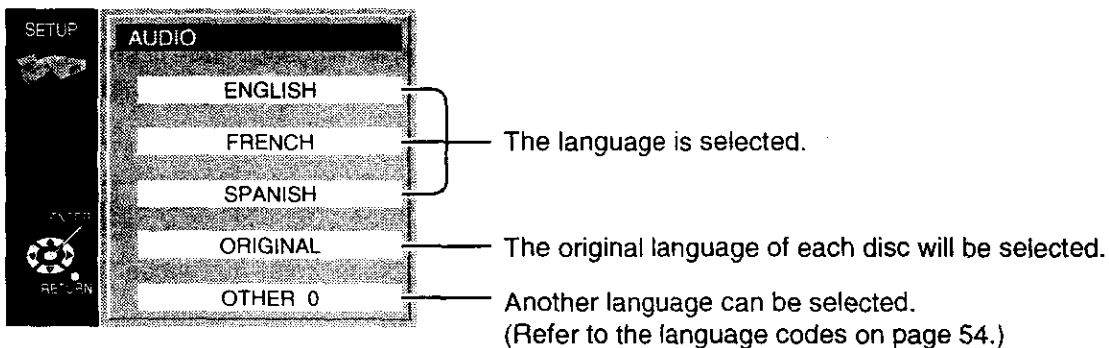

2 Press the SELECT (▲ , ▼) button to select item and press ENTER button.

- Press CANCEL if an incorrect language code is entered.

■ Selecting SUBTITLE language [DVD]

1 Press the SELECT (▲ , ▼) button to select SUBTITLE and press ENTER button.

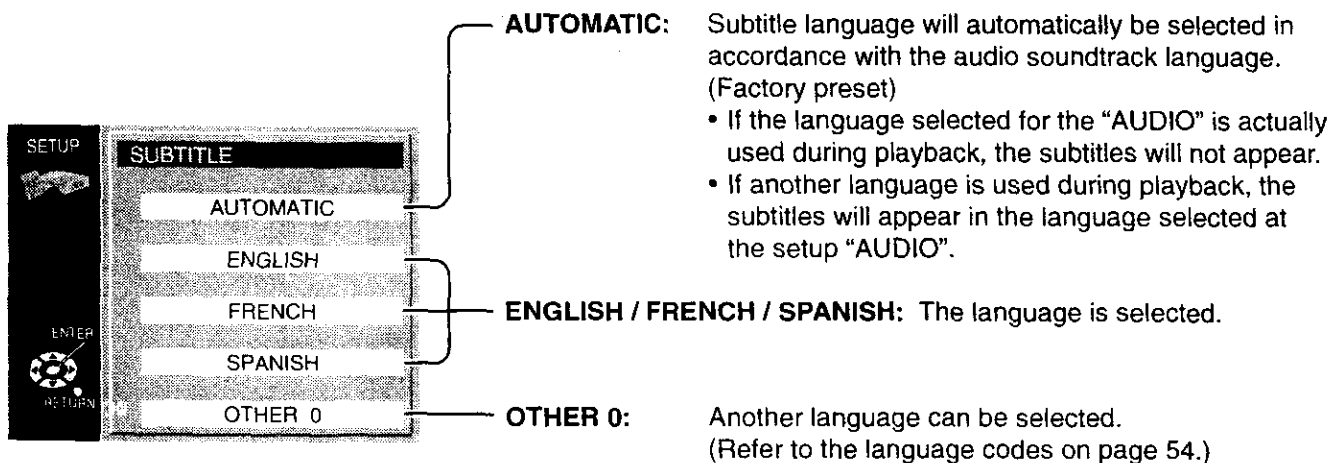

2 Press the SELECT (▲ , ▼) button to select item and press ENTER button.

- Press CANCEL if an incorrect language code is entered.

Initial settings

■ Selecting MENUS [DVD]

1 Press the SELECT (▲, ▼) button to select MENUS and press ENTER button.

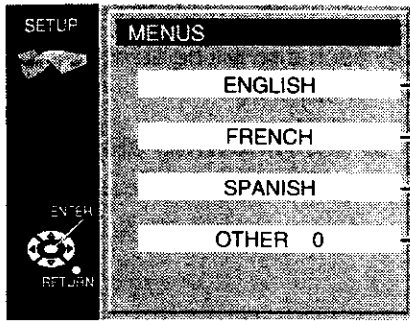

ENGLISH: English is selected. (Factory preset)

FRENCH / SPANISH: The language is selected.

OTHER 0: Another language of each disc will be selected. (Refer to the language codes on page 54.)

Notes:

- If the language selected is not available on the disc, the language designated by each disc will be selected.
- Press CANCEL if an incorrect language code is entered.
- Press return to the previous screen, press RETURN button.

2 Press the SELECT (▲, ▼) button to select item and press ENTER.

■ Selecting RATINGS [DVD]

This feature is used to disable the playing of some DVDs which are unsuitable for some audiences, for example, children.

- Some DVDs are encoded with a specific rating level. If the rating level of the disc is higher than that preset in the initial settings operation, playback of the disc will be prohibited.

1 Press the SELECT (▲, ▼) button to select RATINGS and press ENTER button.

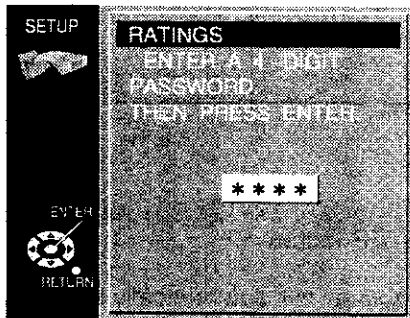

Input a 4-digit password with the numeric buttons and press ENTER button.

- Do not forget your password.
- Factory setting : 1111

2 Press the SELECT (▲, ▼) button to select the level and press ENTER button.

Setting is finished and the initial settings screen is displayed.

- The rating is locked. Any discs with a higher rating than the setting cannot be played back unless the password is entered.

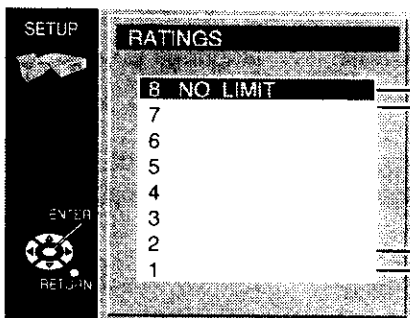

Level 8: All DVDs can be played. (Factory preset)

Level 7 to 2: DVDs for general audiences/children can be played. (DVDs for adults are prohibited.)

Level 1: DVDs for children can be played. (DVDs for adults/general audiences are prohibited.)

● Change the password

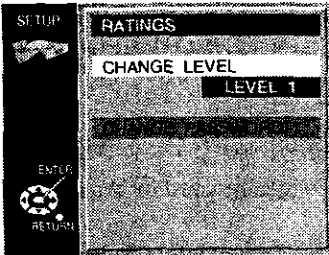

1 Press the SELECT (▲, ▼) button to select the CHANGE PASSWORD and press ENTER button.



2 Input new password and press ENTER button.

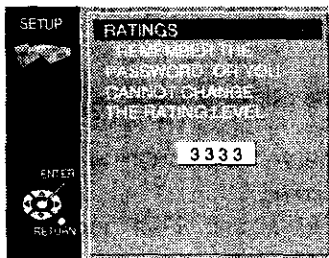

3 Press RETURN button to exit RATINGS menu.

VIDEO MENU

■ Setting TV screen aspect

Select the aspect, conventional size screen (4:3) or wide screen (16:9), when connecting to your TV set.

1 Press the SELECT (◀, ▶) button to select VIDEO menu and press ENTER button.

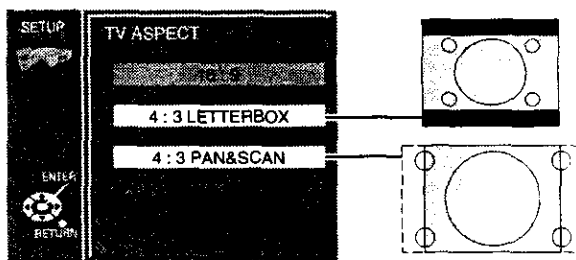
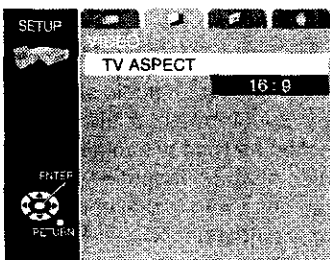

2 Press the SELECT (▲, ▼) button to select aspect item and press ENTER button.

"16:9": Select when a wide screen TV set is connected. (Factory preset)
Select this if the disc video type is 16:9. (For wide screen TV's, set the screen mode to "Full".)

"4:3 LETTERBOX": Select when a conventional TV set is connected.

Wide video with an aspect ratio like 16:9 is played back on the screen with black bands on the top and bottom.

"4:3 PAN&SCAN": Select when a conventional TV set is connected.

Wide video with an aspect ratio like 16:9 is played back on the screen with either both sides or one side cut off.

- If Pan & Scan or Letterbox is designated beforehand on the disc side, the disc designation takes priority.

Initial settings

DISPLAY MENU

■ Setting on screen DISPLAY

1 Press the SELECT (◀ , ▶) button to select DISPLAY menu .

2 Press the SELECT (▲ , ▼) button to select each item and press ENTER button.

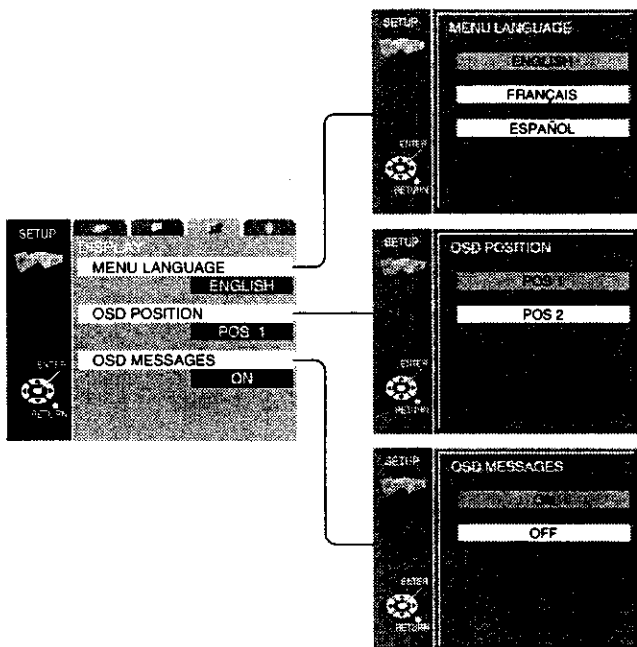

You can change the language used for the on screen display menus.

ENGLISH: SELECTED as onscreen language.

FRANÇAIS: SELECTED as onscreen language.

ESPAÑOL: SELECTED as onscreen language.

POS 1: Display appears at the position on the top side of the screen.

POS 2: Relative to "Position 1", the display appears at the bottom.

(Select this for example, when part of the display is missing.)

This is used to turn the display of functions like "PLAY" and "STOP" on or off.

ON: Functions like "PLAY" and "STOP" are displayed on the television screen.

OFF: Functions like "PLAY" and "STOP" are not displayed on the television screen.

● To return to the previous screen, press RETURN button.

AUDIO MENU

■ Setting AUDIO [DVD]

1 Press the SELECT (◀ , ▶) button to select AUDIO menu .

2 Press the SELECT (▲ , ▼) button to select each item and press ENTER button.

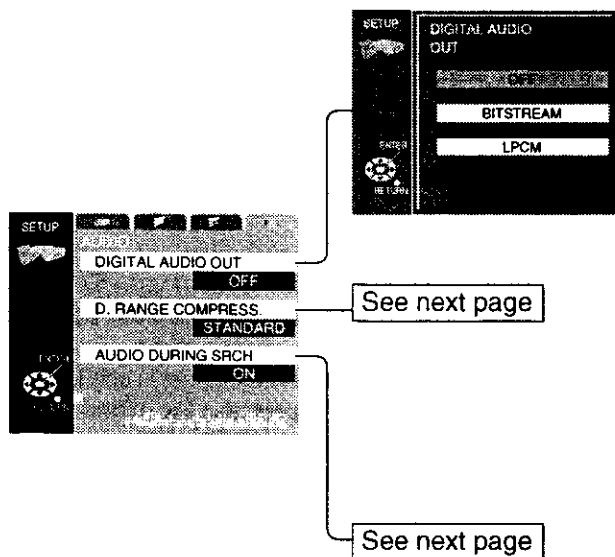

Digital audio output setting

• This is for selecting the type of digital audio signal output from the optical digital audio output terminal of this device, according to the connection method with other equipment.

OFF: For analog connection of audio output → Set to "OFF".

BITSTREAM: When connecting with digital equipment with a built-in Dolby digital decoder or DTS decoder → Set to "BITSTREAM".

LPCM: When connecting with digital equipment without a built-in Dolby digital decoder or DTS decoder → Set to "LPCM".

When playing back a DVD recorded at LPCM 96 kHz using 96 kHz sampling, perform analog connection by setting to "OFF". Optical digital output is not compatible in this case. (When "BITSTREAM" or "LPCM" is selected, downsampling to 48 kHz is done for both optical digital output and analog output.)

CAUTION:

• When performing digital connection with equipment without a built-in Dolby digital decoder or DTS decoder, be sure to set to "LPCM".

• If setting is not done correctly, noise will be generated, and this may hurt your ears or damage speakers.

● To return to the previous screen, press RETURN button.

■ Setting AUDIO [DVD]

- 1 Press the SELECT (◀ , ▶) button to select AUDIO menu .
- 2 Press the SELECT (▲ , ▼) button to select each item and press ENTER button.

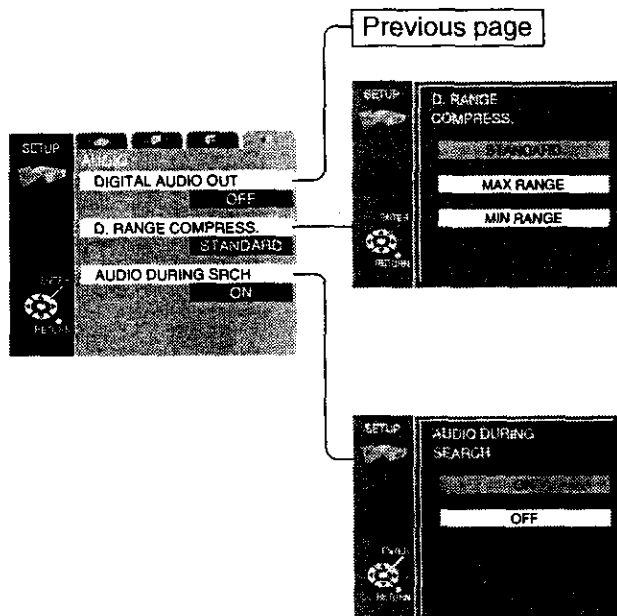

Setting for dynamic range control

This is for selecting the DVD dynamic range (difference between high and low volume).

- This setting works only with DVD discs recorded in Dolby digital.

STANDARD: Set this to listen with a range equivalent to a normal television.

MAX RANGE: Set this to listen with the range recorded on the disc.

MIN RANGE: Set this to listen with a smaller difference between the maximum and minimum volume. (When you want a powerful sound even at low volume, or when you wish to moderate high volume, etc.)

Setting volume during fast forward

This sets whether or not to output audio during fast forward (2x speed) of DVDs and video CDs.

ON: Audio is output during fast forward (2x speed).

OFF: Audio is not output during fast forward (2x speed).

- With a music CD, audio is output at all speeds during fast forward and rewind, regardless of this setting.

- Press return to the previous screen, press RETURN button.

Initial setting condition of DVD SET UP menu

SETUP MENUS	ITEMS	CONTENTS OF SETTING	Ref. page
DISC	AUDIO LANGUAGE	ENGLISH • FRENCH • SPANISH • ORIGINAL • OTHER 0	49
	SUBTITLE LANGUAGE	AUTOMATIC • ENGLISH • FRENCH • SPANISH • OTHER 0	49
	MENUS LANGUAGE	ENGLISH • FRENCH • SPANISH • OTHER 0	50
	RATINGS	LEVEL 8 (NO LIMIT) • LEVEL 1 to 7	50
	PASSWORD	4 digit numeric (1111 Factory setting)	51
VIDEO	TV ASPECT	16:9 • 4:3 LETTERBOX • 4:3 PAN&SCAN	51
DISPLAY	MENU LANGUAGE	ENGLISH • FRANÇAIS • ESPAÑOL	52
	OSD POSITION	POS 1 • POS 2	52
	OSD MESSAGES	ON • OFF	52
AUDIO	DIGITAL AUDIO OUT	OFF • BITSTREAM • LPCM	52
	D. RANGE COMPRESS.	STANDARD • MAX RANGE • MIN RANGE	53
	AUDIO DURING SEARCH	ON • OFF	53

Initial setting (Factory setting)















Language code list

Enter the appropriate code number for the initial settings "AUDIO", "SUBTITLE" and/or "MENUS". (See pages 49, 50)

Code	Language	Code	Language	Code	Language	Code	Language
6565	Afar	7079	Faroese	7678	Lingala	8375	Slovak
6566	Abkhazian	7082	French	7679	Laotian	8376	Slovenian
6570	Afrikaan	7089	Frisian	7684	Lithuanian	8377	Samoan
6577	Ameharic	7165	Irish	7686	Latvian, Lettish	8378	Shona
6582	Arabic	7168	Scots Gaelic	7771	Malagasy	8379	Somali
6583	Assamese	7176	Galician	7773	Maori	8381	Albanian
6588	Aymara	7178	Galician	7775	Macedonian	8382	Serbian
6590	Azerbaijani	7185	Gujarati	7776	Malayalam	8385	Sundanese
6665	Bashkir	7265	Hausa	7778	Mongolian	8386	Swedish
6669	Byelorssian	7273	Hindi	7779	Moldavian	8387	Swahili
6671	Bulgarian	7282	Croatianb	7782	Marathi	8465	Tamil
6672	Bihari	7285	Hungarian	7783	Malay	8469	Telugu
6678	Bengali; Bangla	7289	Armenian	7784	Maltese	8471	Tajiki
6679	Tibetan	7365	Interlingua	7789	Burmese	8472	Thai
6682	Breton	7378	Indonesian	7865	Nauru	8473	Tigrinya
6765	Catalan	7383	Icelandic	7869	Nepali	8475	Turkmen
6779	Corsican	7384	Italian	7876	Dutch	8476	Tagalog
6783	Czech	7387	Hebrew	7879	Norwegian	8479	Tonga
6789	Welsh	7465	Japanese	7982	Oriya	8482	Turkish
6865	Danish	7473	Yiddish	8065	Punjabi	8484	Tatar
6869	German	7487	Javanese	8076	Polish	8487	Twi
6890	Bhutani	7565	Georgian	8083	Pashto, Pushto	8575	Ukrainian
6976	Greek	7575	Kazakh	8084	Portuguese	8582	Urdu
6978	English	7576	Greenlandic	8185	Quechua	8590	Uzbek
6979	Esperanto	7577	Cambodian	8277	Rhaeto-Rmance	8673	Vietnamese
6983	Spanish	7578	Kannada	8279	Romanian	8679	Volapük
6984	Estonian	7579	Korean	8285	Russian	8779	Wolof
6985	Basque	7587	Kashmiri	8365	Sanskrit	8872	Xhosa
7065	Persian	7585	Kurdish	8368	Sindhi	8979	Yoruba
7073	Finnish	7589	Kirghiz	8372	Serbo-Croatian	9072	Chinese
7074	Fiji	7665	Latin	8373	Singhalese	9085	Zulu

How images appear on your TV (aspect ratios of the screen)

The Images on the TV screen depend on the type of software and the TV set.

Type of software	Type of TV set (ASPECT mode)			
	4:3	16:9 ("FULL" mode)	16:9 ("ZOOM" mode)	16:9 ("AUTO" mode)
Wide-screen (pan and scan format) 	Right and left edges are cut off. 	Full screen 	Top and bottom edges are cut off. 	Full screen 
Software (4:3) 	Full screen 	Screen horizontally enlarged 	Top and bottom edges are cut off. 	Full screen (with black bands at right and left) 
Software (4:3, Letterbox) 	Letterbox (with black bands at top and bottom) 	Screen horizontally enlarged (with black bands at top and bottom) 	Full screen 	Screen in which the picture at the far left and far right ends only is extended horizontally (with black bands at top and bottom) 

- The images which appear on the TV screen, and what each screen mode is called, depend on the manufacturer of the TV set and type of TV set. Consult the instruction manual provided with your TV set.

For your reference:

● Letterbox

Black bands are inserted at the top and bottom of the screen to fill in the gaps where the size of the picture is smaller than the screen.

● Pan and Scan

Part of the wide-screen picture (either at both sides or one side of the screen) is automatically eliminated so that the picture fills the whole screen.

Troubleshooting

Before requesting service for this LCD/DVD combo, check the chart below for a possible cause of the problem you are experiencing. Some simple checks or a minor adjustment on your part may eliminate the problem and restore proper operation.

If you are in doubt about some of the check points, or if the remedies indicated in the chart do not solve the problem, consult your dealer for instructions.

For TV broadcasts (VHF, UHF)

Symptom	Cause and remedy	Page
Power supply does not go on	<ul style="list-style-type: none"> ● Is power supply plug unplugged from the outlet? ● If power will not go on with the remote control, is the power supply of the TV "Off"? 	13
Remote control cannot be operated	<ul style="list-style-type: none"> ● Is battery exhausted, or is battery polarity wrong? ● Is the remote control receiver illuminated with strong light from a fluorescent lamp etc.? ● Are you using the special-purpose remote control for this equipment? (The unit will not operate with another remote control.) 	7
Image shakes, or image is unclear	<ul style="list-style-type: none"> ● Is there deterioration, breakage or disconnection of the antenna or antenna wire? ● Is the antenna wire connected correctly? 	8, 9
There are spots on the picture, or the screen shakes	<ul style="list-style-type: none"> ● Is the system affected (by radio wave interference or induced electromagnetic waves) by external sources (automobiles or trains, high-voltage wires, neon, motors, magnetized steel frame, or iron rain shutters, etc.)? ➔ Turn off the power supply, and try changing the equipment setup location. If that has no effect, separate magnet-proofing will be required. 	-
The image appears doubled or tripled	<ul style="list-style-type: none"> ● Is the antenna direction shifted? ● Are reflected electromagnetic waves being received from mountains or buildings? 	-
A color pattern appears, or colors disappear	<ul style="list-style-type: none"> ● Is the equipment being affected by another TV (electromagnetic interference)? ➔ Changing the TV setup location may lead to improvement. 	-
Only a certain channel looks bad	<ul style="list-style-type: none"> ● Is channel fine tuning correct? 	-
The channel number disappears from the screen	<ul style="list-style-type: none"> ● Has the screen display button been pressed? ➔ Press the "Screen display button" again. If the system is switched to external input and there is no external signal video, the number will disappear. 	19
When the image is not stable, the screen turns completely white for a moment	<ul style="list-style-type: none"> ● This occurs when the signal for driving the liquid crystal is lost, and is not a malfunction. 	-
The screen goes dark momentarily when the channel is changed.	<ul style="list-style-type: none"> ● The screen is darkened for a moment to conceal noise generated when changing channels. 	-
The TV makes a hissing noise occasionally	<ul style="list-style-type: none"> ● If the screen and audio are not abnormal, this sound is caused by slight expansion and contraction of the cabinet due to changes in room temperature. It has no effect on performance. 	-
The screen display shakes with video input	<ul style="list-style-type: none"> ● When input is switched to "video input", this may occur if there is no signal at the video/audio input terminal. 	10, 18
There are parts at the top and bottom of the screen where there is no image	<ul style="list-style-type: none"> ● With video software wider than 16:9 (cinema vision size software etc.) there are parts at the top and bottom of the screen where there is no image. 	21
Top and bottom of picture are missing after zoom	<ul style="list-style-type: none"> ● Has the screen position adjustment been left shifted? ➔ Adjust the screen position. 	24

Troubleshooting

For TV broadcasts (VHF, UHF)

Symptoms	Cause and remedy	Page
A black band appears momentarily when selecting channels with video	<ul style="list-style-type: none"> This is due to noise generated when changing channels. 	-
In some parts color tint is poor, and some parts are colored	<ul style="list-style-type: none"> If a bright image (of white clothes, etc.) is stopped, it may be partially colored. This is not a malfunction. This will disappear when the bright screen is gone. 	-
Both edges of the screen, or columns or window frames, appear bent	<ul style="list-style-type: none"> They may appear bent due to the received channel and the screen brightness. This is not a malfunction. 	-
The image from the connected equipment does not appear	<ul style="list-style-type: none"> Are plugs securely inserted into each terminal? <ul style="list-style-type: none"> Securely insert terminals all the way. 	8-10
Parts of the screen are missing with game software	<ul style="list-style-type: none"> When set to self-wide or zoom screen, the top and bottom may be missing. <ul style="list-style-type: none"> Using the screen mode, set to "Full" or "Normal". 	21, 24
The main unit is hot to the touch	<ul style="list-style-type: none"> The main unit radiates heat, so some parts of the console reach a high temperature. This is not a problem for performance or quality. Set up at a location with good ventilation. Do not cover the ventilation holes of the console with anything (tablecloth, etc.), and do not place on top of other equipment (like a video deck). 	-

For DVD operation

Symptoms	Cause and remedy	Page
When the playback button is pressed, playback does not begin, or it stops quickly	<ul style="list-style-type: none"> Is there any condensation? (Let sit for 2-3 hours.) Have you inserted a disc other than a DVD, video CD or music CD? If the disc is dirty, wipe it clean. Insert correctly, with the label surface on the near side. 	-
No sound, or sound is strange	<ul style="list-style-type: none"> When connected to an external amp, set DVD output to "Yes". Check connections and audio settings. There is no sound during pause, still picture, jog or slow playback. 	-
Buttons cannot be operated	<ul style="list-style-type: none"> Operation may be forbidden, depending on the disc. If buttons do not operate at all, try turning the power supply button of the main unit "Off" and "On". The system may fail to operate correctly due to the effects of lightning or static electricity, etc. 	-
Screen messages do not appear	<ul style="list-style-type: none"> Turn On "Screen message" in onscreen setting. 	48, 52
GUI screen display is cut off	<ul style="list-style-type: none"> Change the position of the GUI screen using "Onscreen display position" in onscreen setting. 	-
The picture is disturbed during fast forward or rewind	<ul style="list-style-type: none"> Some disturbance is normal. This is not a malfunction. 	-
Playback does not start even when a title is selected	<ul style="list-style-type: none"> Some titles cannot be played back if viewing restrictions have been set. 	50, 51
The disc is hot when it is removed	<ul style="list-style-type: none"> This is not a problem for quality or performance. 	-
Subtitles do not appear	<ul style="list-style-type: none"> Subtitles are not recorded on the DVD. If the subtitle setting is "Off", set it to "On". 	45
The audio or subtitle language cannot be selected	<ul style="list-style-type: none"> The DVD does not have multiple languages. 	45
The angle cannot be changed	<ul style="list-style-type: none"> Even with a DVD, switching cannot be done at points where multi-angle is not stored. 	43

Troubleshooting

For DVD operation

Symptoms	Cause and remedy	Page
The preset audio or subtitle language does not appear	● The DVD does not have multiple languages.	45
The disc cannot be removed	● Is the child lock "On"?	20

Frequently asked questions (Q&A)

Q (Question)	A (Answer)	Page
Can I do video recording?	● Almost all DVD discs have copy protection so recording is not possible.	-
Can I playback discs with no region number?	● The region number indicates that the disc conforms to the DVD standard. Discs which do not comply with the standard cannot be played.	32
Can the spot light function and real-time text function be used?	● They cannot be used with this equipment.	-
Sound volume seems lower than TV or radio, etc.	● Dolby digital audio signals have a wide dynamic range (i.e., the range between high and low volume) so in general volume seems to sound low.	-
Can I play back DVDs purchased abroad?	● If the region number contains "ALL" or "1" and the format is NTSC, it can be played back.	-
Can I playback videos or CDs purchased overseas?	● They can be played back if they are in NTSC format.	-
Can I play back CD-R, DVD-R and DVD-RAM?	● No. (They are not compatible with this equipment.) If compatibility of other discs is unclear, check the disc logo. Some titles cannot be played back if viewing restrictions have been set.	-

Maintenance

To clean this unit, wipe with a soft, dry cloth.

If the surfaces are extremely dirty, use a soft cloth dipped in soap-and-water solution or a weak detergent solution.

- Use eyeglass cleaner to remove stubborn dirt from the LCD.
- Never use alcohol, paint thinner or benzine to clean this unit.
- Before using chemically treated cloth, read the instructions that came with the cloth carefully.

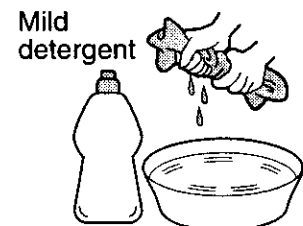

CAUTION :

If water or similar substances get inside the monitor via the liquid crystal panel surface, a malfunction may result.

Specifications

Power Source		AC 120 V, 60 Hz
Power Consumption		Average use : 40 W (Maximum Current 2.5 A) Stand-by condition : 0.8 W
LCD		TFT 11-inch, 16 : 9 aspect ratio, 854 × 480 dots, 409,920 pixel
Screen Size		9.63 " (244 mm) (W) × 5.41 " (137 mm) (H) × 11.04 " (280 mm) (DIAGONAL)
Channel Capability-181		VHF-12 ch : UHF-56 ch : Cable-125 ch
Sound	Speaker	1.57 " (4 cm) × 1.10 " (2.8 cm) 2pcs.
	Audio Output	2 W [1 W + 1 W] (10 % THD) Power Frequency Response 35 Hz ~ 16 kHz
	Headphones	M3 (3.5 mm) Jack (16 Ω ~ 32 Ω)
FEATURES		DVD Player
Disc Played	DVD-VIDEO disc 12 cm single-sided, single-layer 12 cm single-sided, dual-layer 12 cm double-sided, single-layer 8 cm single-sided, single-layer 8 cm single-sided, dual-layer 8 cm double-sided, single-layer	COMPACT disc (CD-DA, VIDEO CD) 12 cm disc 8 cm disc
Accessories Supplied		
Remote control Transmitter	TNQE284	Battery : AAA (R03) Battery 2pcs.
AC Adaptor	AC Adaptor : NOJZHK000005	AC Cord : K2CA2EA00005
Operating Conditions	Temperature : 42 °F - 95 °F (5 ° - 35 °C) Humidity : 20 % - 80 % (non-condensing)	
Connection Terminals		
VIDEO IN	S-VIDEO (Mini DIN 4 pin) VIDEO (Pin Jack) AUDIO L-R (Pin Jack × 2)	Y : 1.0 Vp-p (75 Ω) C : 0.286 Vp-p (75 Ω) 1.0 Vp-p (75 Ω) 0.5 Vrms
DVD OUT	S-VIDEO (Mini DIN 4 pin) AUDIO L-R / DIGITAL AUDIO (STEREO M3 Jack)	Y : 1.0 Vp-p (75 Ω) C : 0.286 Vp-p (75 Ω) 1.3 Vrms (1 kHz, 0 dB) / BITSTREAM, Linear PCM
Dimensions (W × H × D)		
With pedestal	12.8 " (325 mm) × 9.89 " (251 mm) × 6.70 " (170 mm)	
Without pedestal	12.8 " (325 mm) × 8.55 " (217 mm) × 2.72 " (69 mm)	
Weight (Mass)	approx. 7.1 lb. (approx. 3.2 kg) Net	

Note:

- Design and Specifications are subject to change without notice. Weight and Dimensions shown are approximate.

This product incorporates copyright protection technology that is protected by method claims of certain U.S. patents and other intellectual property rights owned by Macrovision Corporation and other rights owners. Use of this copyright protection technology must be authorized by Macrovision Corporation, and is intended for home and other limited viewing uses only unless otherwise authorized by Macrovision Corporation. Reverse engineering or disassembly is prohibited.

Customer' Record

The model number and serial number of this product can be found on its rear panel. You should note this serial number in the space provided below and retain this book, plus your purchase receipt, as a permanent record of your purchase to aid in identification in the event of theft or loss, and for Warranty Service purposes.

Model Number TC-11LV1

Serial Number _____

Panasonic Consumer Electronics Company, Division of Matsushita Electric Corporation of America
One Panasonic Way Secaucus
New Jersey 07094

Panasonic Sales Company, Division of Matsushita Electric of Puerto Rico Inc. ("PSC")
Ave. 65 de Infanteria, Km 9.5
San Gabriel Industrial Park,
Carolina, Puerto Rico 00985

Panasonic Canada Inc.
5770 Ambler Drive
Mississauga, Ontario
L4W 2T3