

SAFETY INFORMATION

WARNING

To reduce risk of fire or shock hazard, do not expose this product to rain or moisture.

WARNING

RISK OF ELECTRIC SHOCK
DO NOT OPEN

TO REDUCE THE RISK OF ELECTRIC SHOCK, DO NOT REMOVE COVER (OR BACK). NO USER SERVICEABLE PARTS INSIDE. REFER SERVICING TO QUALIFIED SERVICE PERSONNEL.



This symbol indicates important instructions accompanying the product.



This symbol indicates "dangerous voltage" inside the product that presents a risk of electric shock or personal injury.

Cautions

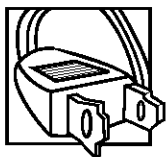

Caution: To reduce the risk of electric shock, match the wide blade of plug to wide slot, and fully insert.

Attention: Pour éviter les chocs électriques, introduire la lame la plus large de la fiche dans la borne correspondante de la prise et pousser jusqu'au fond.

Refer to the identification/rating label located on the back panel of your product for its proper operating voltage.

FCC Regulations state that unauthorized changes or modifications to this equipment may void the user's authority to operate it.

Cable TV Installer: This reminder is provided to call your attention to Article 820-40 of the National Electrical Code (Section 54 of the Canadian Electrical Code, Part 1) which provides guidelines for proper grounding and, in particular, specifies that the cable ground shall be connected to the grounding system of the building as close to the point of cable entry as practical.

Care and Cleaning:

Use a soft cloth or the dusting attachment of your vacuum cleaner to dust your VCR. Remove dust from the ventilation holes.

Plastic surfaces are easily scratched and can be marred by alcohol and various solvents. Avoid excessive use of oil-based furniture polishes since the materials used in the cabinet will accumulate more dust. A nonabrasive, antistatic cleaner/polisher is recommended.

Product Registration

Please fill out the product registration card and return it immediately. Returning the card allows us to contact you if needed.

Keep your sales receipt to obtain warranty parts and service and for proof of purchase. Attach it here and record the serial and model numbers in case you need them. The numbers are located on the back of the product.

Model No. **VR647HF** _____

Serial No. _____

Purchase Date: _____

Dealer/Address/Phone: _____

TABLE OF CONTENTS

First Things First	3
Setting Up the VCR	7
Using The Menu To Set Up Features	8
Language Selection	8
Cable Box Setup	9
VCR Channels List	10
To Auto Channel Search	10
To Change the Signal Type	12
Adding or Removing Channels	12
Time and Date	12
Auto Clock Set Feature	13
Set the Time Zone	13
Set Daylight-Saving Time	14
Setting the Time and Date Manually	15
VCR Plus+ System Channels	16
Additional Set-up Features in the Preferences Menu	18
Remote VCR1/VCR2 Option	18
Auto Play	19
EnergySaver	19
Front Panel Brightness (VCR Display)	20
Preferred Tape Speed	20
VCR Basics	21
Remote Buttons	22
Component Buttons	22
VCR Function Buttons	22
TV Function Buttons	23
Playing a Tape	24
Automatic Rewind	24
Tape Eject	25
Recording	25
Check the Safety Tab	25
Recording	27
Recording Features	28
Express Recording (XPR)	28
Timer Recording	29
Timer Recording with VCR Plus+ Interactive Program Guide System	30
Setting Up the Channel List	30
Using the VCR Plus+ System	30
Stopping a Timer Recording	32
Reviewing and Clearing Programs	32
Recording Broadcast Stereo TV Or SAP (Second Audio Program)	33
Recording Audio Only	33
Using Two VCRs For Copying and Editing Tapes	34

TABLE OF CONTENTS

Program the Remote	35
About Programming the Remote	36
Programming the Remote to Control a TV	36
Other Features	39
COMMERCIAL ADVANCE	40
COMMERCIAL ADVANCE Marking	41
COMMERCIAL ADVANCE Playback	42
COMMERCIAL ADVANCE Display	42
MOVIE ADVANCE	43
Picture Search Options	45
Forward and Reverse Search	45
Slow Motion	45
Frame Advance	46
Index Search	46
Go-To Search	47
Tracking	47
Pro-Tect Plus™ Locking Feature	48
Time Counter	48
On-screen Displays	49
Audio Set-up Features	49
Reception	50
Tape Playback	50
Connections	51
Connecting Your VCR	52
Jacks and Cables	52
RF Jacks and Coaxial Cables (F-type)	52
Audio/Video Jacks and Cables (RCA-type)	52
Choosing a VCR Connection	53
Advantages of Audio/Video Cable Connections	53
TV with RF jack only	54
TV with Audio/Video jacks	55
TV with Audio/Video Jacks and Cable Box to Unscramble Pay Channels Only	56
Reference	57
Front Panel	58
Display Panel	59
Back Panel	60
Troubleshooting Tips	61
Questions and Answers About COMMERCIAL ADVANCE	66
Specifications	67
Cleaning the VCR	67
How to Find Your TV's Video Input Channel	68
Limited Warranty	69
Index	70

FIRST THINGS FIRST

WELCOME TO YOUR NEW VCR...

To help you get started using your VCR with as little reading as possible, we've put all the basic information needed in the first three sections. To help you along, there's even an initial set-up feature the first time you turn on your VCR which walks you through several set-up steps at once.

GETTING STARTED

Before this first step, though, learning about the time and date, your remote control's features, working with channels, and basic video tape operations are essential to get all you can out of the VCR. Once you are comfortable with these features, feel free to refer to other sections because they cover the more detailed information.

WHAT REMAINS?

The final sections of this manual contain playback and recording information, a detailed connections section, and a reference section including troubleshooting tips, warranty information, and an index.

1 FIRST THINGS FIRST



2 SETTING UP THE VCR



3 VCR BASICS



4 RECORDING



5 PROGRAM THE REMOTE



6 OTHER FEATURES



7 CONNECTIONS



8 REFERENCE

READ ME!

These note boxes give you tips for your new video cassette recorder.

FIRST THINGS FIRST

STEP 1: WHAT'S IN THE BOX?

The following items come packed in the box:

- VCR
- Remote control
- RF coaxial cable

STEP 2: INSTALL BATTERIES IN THE REMOTE CONTROL

Follow these steps whenever you need to install or change the batteries in your VCR remote.

1. Remove the cover of the battery compartment.
2. Place the batteries into the remote's back panel. Match the positive (+) and negative (-) ends of each battery to the diagram inside the battery compartment.
3. Replace the cover.

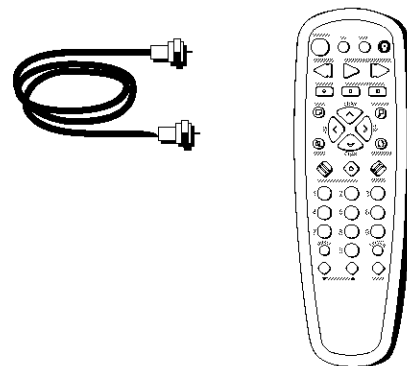
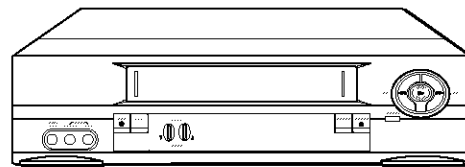

STEP 3: CONNECT YOUR VCR

If you connect your VCR to your home antenna or cable system and then to your TV, use the VCR's ANT. IN and RF OUT jacks for a good signal as shown to the right.

If you have a TV with AUDIO/VIDEO jacks, use the jacks for a better connection. Refer to the section, *Connections*, toward the back of the manual, for additional connection options.

STEP 4: PLUG IN THE VCR

Your VCR's power cord has a plastic band strung through the blades. **Remove plastic band before plugging the cord into the power outlet.** To remove band, cut with a pair of scissors and pull it free of the blades. Once the plastic is removed, match the wide blade of the power cord to the wide slot in the AC outlet. Be sure to insert the plug completely.

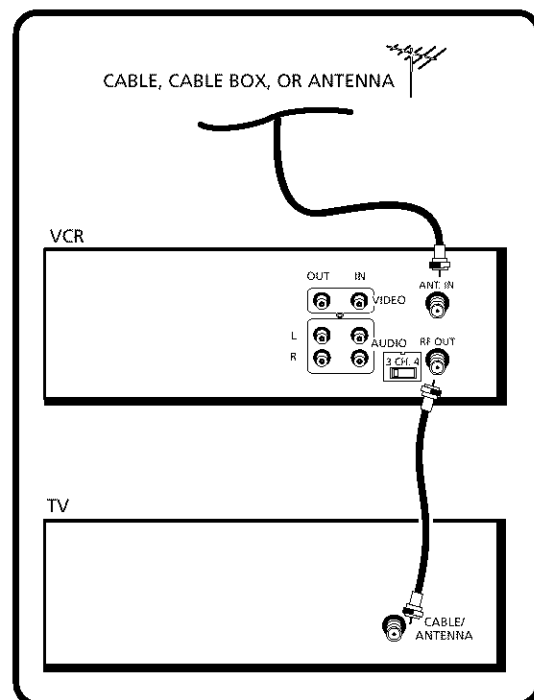

FIRST THINGS FIRST

STEP 5: TUNE THE TV

Tune the TV to the VCR viewing channel. The VCR viewing channel is channel 3 or 4 or the TV's video input.

- If you connect your VCR using the ANT. IN and RF OUT connectors with RF coaxial cable, set the 3 CH. 4 switch to channel 3 or channel 4 — the channel you want to use on your TV.
- If you connect your VCR using the AUDIO/VIDEO jacks with audio/video cables, select the TV's video input with the remote control's INPUT button to see the signal. If you have trouble understanding the Video Input Channel, look to page 68 for a more detailed explanation.

STEP 6: TURN ON THE VCR

Press POWER on the VCR's front panel or the VCR button on the remote control to turn on the VCR. The first time you turn the VCR on, a menu screen appears. This is the start of an initial set up which helps you set different options for your VCR.

STEP 7: INITIAL SETUP

The first on-screen menu during the initial set up asks which language you prefer to use for your VCR. Use the remote control's number buttons to select options.

Select a language.
Seleccione un idioma.
Choisissez une langue.

- 1 English
- 2 Español
- 3 Français

1. Press 1 for English, 2 for Español (Spanish), or 3 for Français (French).

The remaining menus throughout the set up will appear in the chosen language. Just follow the step-by-step procedures until setup is complete.

If the menu does not appear:

- Make sure the TV is tuned to the same channel as the 3 CH. 4 switch or the TV's Video Input Channel (see page 68 for more information).

VCR Viewing Channel

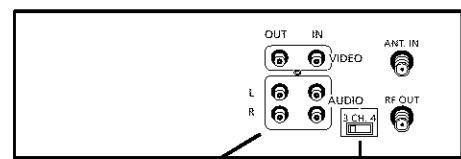

AUDIO/VIDEO OUT Jacks

3 CH. 4 Switch

When using the ANT. IN and RF OUT jacks to connect your VCR, tune your TV to channel 3 or 4.

The 3 CH. 4 switch on the back of the VCR determines which TV channel is used to see the VCR's output.

When using the AUDIO/VIDEO jacks to connect your VCR, tune your TV to the TV's Video Input Channel with the TV and INPUT buttons on your remote control. For more information about selecting your video input channel, see page 68.

FIRST THINGS FIRST

- Make sure the VCR indicator is on in the VCR display if you connected your VCR using the ANT. IN and RF OUT jacks.
- Check your connections.

If you chose to set up your VCR options individually, then go to the next section.

STEP 8: ACCESS THE MENUS

The MENU and number buttons let you access, select, and change your VCR's preferences. For example, to select a different preferred on-screen language than the one you selected during the initial set up, do the following:

1. Press MENU to display the VCR MAIN MENU.

```
VCR MAIN MENU
1 VCR Plus+
2 Timer Recordings
3 Time
4 Channels
5 Preferences
6 Audio
7 Language
0 Exit
```

2. Press 7 to display the LANGUAGE menu.

```
LANGUAGE
Select a language.
1>English
2 Español
3 Français
Press MENU to continue
```

3. On the remote control, press 1 for English, 2 for Español (Spanish), or 3 for Français (French).

All other on-screen menus are worked within similar ways using the remote control to follow on-screen instructions. See *Additional Set-Up Features* in the next section for detailed information about accessing menus.

NEXT SECTION: LEARN VCR'S MENUS

Now that you understand how to move around through menus, go to the next section to set up individual menus of your VCR.

SETTING UP THE VCR

ADDITIONAL SET-UP FEATURES

Below is a list of set-up features that you need to set up before using your VCR for the first time.

- Select a Language
- Set Up for a Cable Box
- Set Up a VCR Channel List (Auto Channel Search)
- Auto Clock Set Feature
- Set Time and Date Manually
- Set Up VCR Plus+ Channels
- Set the Remote VCRI/VCR2 Feature
- Set the Auto Play Feature
- Set the EnergySaver Feature
- Set Front Panel Brightness Feature
- Set the Preferred Tape Speed Feature

1 FIRST THINGS FIRST



2 SETTING UP THE VCR



3 VCR BASICS



4 RECORDING



5 PROGRAM THE REMOTE



6 OTHER FEATURES



7 CONNECTIONS



8 REFERENCE

SETTING UP THE VCR

USING THE MENU TO SET UP FEATURES

You can set up your VCR's features by using the remote control's buttons to enter your choices from on-screen instructions. Each menu item is explained in this section.

You can set up features individually by using the menu system. Each feature that appears in the initial set up is explained in this section as well as a few others you may want to set up before you begin using your VCR.

LANGUAGE SELECTION

1. On your remote control, press the MENU button to display the VCR MAIN MENU.

```
VCR MAIN MENU
1 VCR Plus+
2 Timer Recordings
3 Time
4 Channels
5 Preferences
6 Audio
7 Language
0 Exit
```

2. Press 7 to select the LANGUAGE menu.

```
LANGUAGE
Select a language.
1>English
2 Español
3 Français
Press MENU to continue
```

3. Select English, Español (Spanish), or Français (French) by pressing the appropriate number on the remote control's key pad.

On-Screen Menus

Not all the VCR screens are shown in this manual when explaining the features.

SETTING UP THE VCR

CABLE BOX SETUP

This setup applies only when all channels are received through a cable box. In this case, the VCR will automatically enter the channel used to view cable box programming. Your VCR will use this channel for all future timer recordings.

1. Press MENU to display the VCR MAIN MENU.

```
VCR MAIN MENU
1 VCR Plus+
2 Timer Recordings
3 Time
4 Channels
5 Preferences
6 Audio
7 Language
0 Exit
```

2. Press 4 to display the CHANNELS menu.

```
CHANNELS
1 Auto Channel Search
2 Add/Remove Channels
3 Signal Type: CABLE
4 VCR Plus+ Channel List
5 Cable Box Setup
0 Exit
```

3. Press 5 to display CABLE BOX SETUP. Then select one of the three choices:

```
CABLE BOX SETUP
Do you use your cable
box to receive ALL
channels or only SOME
channels?
1 ALL channels
2 Only SOME channels
3 Cancel setup
```

4. If you selected ALL channels, enter the output channel of your cable box (usually 03 or 04), or press INPUT for the VCR's video line input if you use AUDIO/VIDEO jacks. Then, press MENU.

```
CABLE BOX SETUP
On what channel does
the VCR receive signals
from the cable box?
(usually 3, 4, or Video)
--
Enter 01-13 or INPUT
Press MENU to cancel
```

Cable Box Setup

ALL channels: enter two numbers for output channel of your cable box or press INPUT if you connect your cable box with AUDIO/VIDEO jacks.

Only SOME channels: if you only use the cable box to tune premium channels.

Cancel setup: select to cancel.

SETTING UP THE VCR

```
CABLE BOX SETUP
On what channel does
the VCR receive signals
from the cable box?
(usually 3, 4 or video)

    04

Press CLEAR to correct
Press MENU to continue
```

5. Once you complete the setup, the VCR confirms that the VCR will now receive all signals on the designated channel. For example:

```
CABLE BOX SETUP

The VCR will now
receive all signals
from the cable box
on channel 04.

Press MENU to continue
```

VCR CHANNELS LIST

If you use a cable box for *all channels*, this step is not necessary. Your VCR may come with a channel list preset at the factory, but you may want to add or delete some channels depending on whether they are active.

TO AUTO CHANNEL SEARCH

1. Press MENU to display the VCR MAIN MENU.

```
VCR MAIN MENU
1 VCR Plus+
2 Timer Recordings
3 Time
4 Channels
5 Preferences
6 Audio
7 Language
0 Exit
```

2. Press 4 to display the CHANNELS menu.

Auto Channel Search

Use the Auto Channel Search feature to place all available channels in memory.

If you ever change cable or antenna signals, you may need to Auto Channel Search again.

SETTING UP THE VCR

```
CHANNELS
1 Auto Channel Search
2 Add/Remove Channels
3 Signal Type: CABLE
4 VCR Plus+ Channel List
5 Cable Box Setup

0 Exit
```

3. Press 1 to display the AUTO CHANNEL SEARCH screen.

```
AUTO CHANNEL SEARCH

What type of signal
are you using?

1 Cable TV
2 Antenna
3>Detect Automatically

0 Cancel
```

4. Select one of the three AUTO CHANNEL SEARCH options:

- *Cable TV* searches for cable channels
- *Antenna* searches for local broadcast stations
- *Detect Automatically* will make this decision for you

```
AUTO CHANNEL SEARCH

Now scanning channel 14

Press any key to cancel
```

The VCR begins scanning for the available channels—this takes about one to two minutes. When the scan is complete, the VCR tunes to the lowest channel number. At this point, pressing CHAN up or down on the remote control or VCR should only select the active channels.

Detect Automatically

A strong cable or antenna signal in your area may cause Auto Detect to mis-detect. If this should happen, select 1 or 2 for the system you have.

SETTING UP THE VCR

TO CHANGE THE SIGNAL TYPE

1. Press MENU to display the VCR MAIN MENU.
2. Press 4 to display the CHANNELS menu.
3. Press 3 to change the Signal Type between CABLE and ANTENNA.

ADDING OR REMOVING CHANNELS

You may want to add or remove channels after you Auto Channel Search, especially if some of the channels have weak signals or you don't want to watch them.

1. Press MENU to display the VCR MAIN MENU.
2. Press 4 to display the CHANNELS menu.
3. Press 2 to display the ADD/REMOVE CHANNELS screen. Use the CHAN up or down keys on the remote or number buttons to go to the channels you want to remove or add.

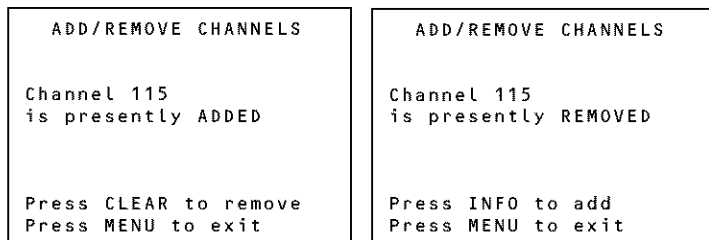

4. When at the channel, it will be added if not already on the list or deleted if it was. If the channel was added, you can press CLEAR to remove it. If the channel was deleted, you can press INFO to add.

TIME AND DATE

The VCR gives you two ways to set the time and date: the Auto Clock Feature or manually. The Auto Clock Feature enables the VCR to update the clock each time the VCR is turned off. The Auto Clock is advantageous because it updates the time for you automatically.

Before you set the time and date, set the Auto DST (Daylight-Saving Time) feature to ON or OFF for your area.

Selecting Channels

The Channel up and down buttons access those channels active in your VCR channel list.

You can still access channels not on the channel list by using the number buttons on the remote control.

SETTING UP THE VCR

AUTO CLOCK SET FEATURE

The Auto Clock Set feature is set to ON at the factory. In the ON setting, the VCR looks for a channel carrying XDS (Extended Data Services) information. XDS updates the clock using the Coordinated Universal Time. To use this automatic feature, certain steps are required such as Auto Channel Search, setting the time zone, and setting the Daylight Saving feature before the Auto Clock feature works.

SET THE TIME ZONE

1. Press MENU on the remote control to display the VCR Main Menu.

```
VCR MAIN MENU
1 VCR Plus+
2 Timer Recordings
3 Time
4 Channels
5 Preferences
6 Audio
7 Language

0 Exit
```

2. Press 3 to display TIME menu.

```
TIME
1 Set Time and Date
2 Auto Clock Set: ON
3 Set Time Zone
4 Set Daylight Savings

XDS Time Data was
found on channel 20.

0 Exit
```

3. Press 3 to display the SET TIME ZONE screen.

```
SET TIME ZONE
What is your Time Zone?
1 Eastern
2 Central
3 Mountain
4 Pacific
5 Alaska
6 Hawaii
7>Automatic
Press MENU to continue
```

4. Select your time zone, then press MENU to continue.

If you chose Automatic for your time zone, the VCR sets the clock using the first Coordinated Universal Time information it finds. If the time is not correct, select another time zone or manually set the time and date through the menu system.

Auto Clock Information

With a cable box, the VCR will not reset the clock after a power outage unless the cable box is set to the channel carrying the XDS signal.

If Auto Clock Set is unsuccessful, try tuning the VCR (or cable box) to a channel carrying the broadcast information (usually PBS), then turn the VCR off. If the time does not set within 10 minutes, set the time and date manually through the menus.

Check your local cable system or TV stations for availability of channels with XDS.

SETTING UP THE VCR

SET DAYLIGHT-SAVING TIME

1. Press MENU to display the VCR MAIN MENU.

```
VCR MAIN MENU
1 VCR Plus+
2 Timer Recordings
3 Time
4 Channels
5 Preferences
6 Audio
7 Language
0 Exit
```

2. Press 3 to display the TIME menu.

```
TIME
1 Set Time and Date
2 Auto Clock Set: ON
3 Set Time Zone
4 Set Daylight Savings

XDS Time Data was
found on channel 20.

0 Exit
```

3. Press 4 to display the SET DAYLIGHT SAVINGS menu.

```
SET DAYLIGHT SAVINGS

Does your area observe
Daylight Savings Time
from April to October?

1 Yes, DST is observed
2 No
3>Automatic
Press MENU to continue
```

4. Select one of the options and then press MENU to continue.
- DST stands for “Daylight Saving Time.”
 - If you chose Automatic, the VCR sets the clock using the DST information broadcast in the signal (channel).

Spring forward, Fall backward

In the Spring, daylight-saving time begins on the first Sunday in April. Because the clock automatically changes from 2 a.m. to 3 a.m. (forward one hour), including the extra hour for timer recording within this time frame is necessary.

In the Fall, Daylight-Saving time ends on the last Sunday in October. The VCR clock automatically changes from 2 a.m. to 1 a.m. (back one hour). Therefore, it can affect your recording length.

SETTING UP THE VCR

SETTING THE TIME AND DATE MANUALLY

If the Auto Clock Set was unsuccessful, set the clock through the TIME menu. The Auto Clock Set feature is set to OFF automatically when you set the clock this way.

1. Press MENU to display the VCR MAIN MENU.

```
VCR MAIN MENU
1 VCR Plus+
2 Timer Recordings
3 Time
4 Channels
5 Preferences
6 Audio
7 Language

0 Exit
```

2. Press 3 to display the TIME menu.

```
TIME
1 Set Time and Date
2 Auto Clock Set: ON
3 Set Time Zone
4 Set Daylight Savings

XDS Time Data was
not found.

0 Exit
```

3. Press 1 to display the SET TIME AND DATE menu.

```
SET TIME AND DATE

Time --:--
(hh:mm)

Date --/--/--

Press MENU to cancel
```

4. Enter the data using the number buttons. Press 0 before single-digit numbers and follow the on-screen directions.

```
SET TIME AND DATE

Time 12:34 PM

Date 11/18/99 Thursday

Press CLEAR to correct
Press MENU to set
```

Time/Date Display

Pressing INFO on the remote displays the time and date on the screen.

SETTING UP THE VCR

VCR PLUS+ SYSTEM CHANNELS

Using the VCR Plus+ system can make programming timer recordings for cable or off-air antenna easier, but you have to put in a little time right now to set up a channel list. A worksheet and abbreviated codes for typical cable services in the United States and Canada are provided.

1. Press MENU to display the VCR MAIN MENU.

```
VCR MAIN MENU
1 VCR Plus+
2 Timer Recordings
3 Time
4 Channels
5 Preferences
6 Audio
7 Language
0 Exit
```

2. Press 4 to display the CHANNELS menu.

```
CHANNELS
1 Auto Channel Search
2 Add/Remove Channels
3 Signal Type: CABLE
4 VCR Plus+ Channel List
5 Cable Box Setup
0 Exit
```

3. Press 4 to display the VCR PLUS+ CHANNEL LIST menu.

```
VCR+ Channel My Channel
5 --
4 --
3 -> -> -> --
2 --
1 --

Use CH+/- to select
Press 0-9 to change
Press MENU to save
```

4. Enter the data following the on-screen directions using your worksheet.

```
VCR+ Channel My Channel
5 46
4 --
3 -> -> -> 23
2 --
1 --

Use CH+/- to select
Press 0-9 to change
Press MENU to save
```

(Screen shown is for an example only)

Two-Digit VCR Plus+ System Channel Numbers for Cable TV (USA List)

35	American Movie Classics
39	Arts & Entertainment
57	Black Entertainment
54	Bravo
42	Cable News Network
45	Cinemax
98	Cinemax 2
37	The Discovery Channel
53	The Disney Channel
63	Entertainment Television
34	ESPN Sports Network
47	The Family Channel
33	Home Box Office
95	Home Box Office 2
96	Home Box Office 3
51	The Learning Channel
46	Lifetime
58	The Movie Channel
48	Music Television
49	The Nashville Network
38	Nickelodeon
64	Nostalgia Television
99	Quality Value Cable
41	Showtime
97	Showtime 2
59	Sports Channel
52	Turner Network Television
44	USA-Network
62	Video Hits 1
93	Viewer's Choice 1
94	Viewer's Choice 2
55	WGN Chicago
43	WTBS Atlanta
60	WWOR-New York

See next page for Canadian List

VCR Plus+ System Channel List

Refer to your local television list for a complete VCR Plus+ channel list for your viewing area or contact your cable company. Using the list may save you some time.

SETTING UP THE VCR

ADDITIONAL SET-UP FEATURES IN THE PREFERENCES MENU

The features in this section are all accessed through the PREFERENCES menu.

1. Press MENU to display the VCR MAIN MENU.

```
VCR MAIN MENU
1 VCR Plus+
2 Timer Recordings
3 Time
4 Channels
5 Preferences
6 Audio
7 Language
0 Exit
```

2. Press 5 to display the PREFERENCES menu.

```
PREFERENCES
1 Remote Control: VCR1
2 Auto Play: ON
3 EnergySaver: 2:00
4 Front Panel: AUTO
5 Tape Speed: SLP
6 Commercial Advance
0 Exit
```

Now you are ready to select an item from the menu to set up.

REMOTE VCR1/VCR2 OPTION

If you own a compatible RCA, GE, or ProScan remote that has a VCR2, VCR2•LD, or VCR2•DVD button, this feature allows you to set this VCR to respond to that button.

In the PREFERENCES menu, press 1 to select REMOTE CONTROL. With the compatible remote control, press the VCR2, VCR2•LD, or VCR2•DVD button to change which remote controls the VCR.

```
PREFERENCES
(Press VCR2 to Change)
2 Auto Play: ON
3 EnergySaver: 2:00
4 Front Panel: AUTO
5 Tape Speed: SLP
6 Commercial Advance
0 Exit
```

```
PREFERENCES
1 Remote Control: VCR2
2 Auto Play: ON
3 EnergySaver: 2:00
4 Front Panel: AUTO
5 Tape Speed: SLP
6 Commercial Advance
0 Exit
```

Remote Control Option

Changing the remote option to VCR2 disables the remote that came with your VCR.

SETTING UP THE VCR

The VCR will only respond to the compatible remote's VCR2, VCR2•LD, or VCR2•DVD button. If the PREFERENCES setting is changed to VCR2, the remote that came with your VCR will no longer control it.

To change the setting back to VCR1, so the remote which came with your VCR can control the unit, use the compatible remote to display the PREFERENCES menu, press 1, and then VCR on this VCR's remote.

AUTO PLAY

This feature allows the VCR to automatically start playing a tape when inserting a tape with the safety tab removed. In the PREFERENCES menu, press 2 to switch between ON and OFF.

- Select ON if you want a tape with its safety tab removed to start playing automatically when inserted in the VCR.
- Select OFF if you *do not* want a tape with its safety tab removed to start playing automatically.

ENERGYSAVER

By default, this VCR automatically turns off after two hours of inactivity. To change the time delay, or to disable the feature, Press 3 in the PREFERENCES menu to switch between ON and OFF.

- OFF means the VCR will remain turned on until you shut it off.
- 1:00, 2:00, or 3:00 means the VCR turns off after one, two, or three hours of inactivity respectively.

Thirty seconds before shutting off, the VCR will warn you with a screen reading, "The VCR will turn off in 30 seconds. Press any key to cancel."

If you use the VCR's tuner instead of your TV to tune channels, you may want to turn this feature off.

PREFERENCES	
1 Remote Control:	VCR2
2 Auto Play:	ON
3 EnergySaver:	2:00
4 Front Panel:	AUTO
5 Tape Speed:	SLP
6 Commercial Advance	
0 Exit	

The PREFERENCES menu allows access to many VCR options including remote control, Auto Play, and EnergySaver features.

SETTING UP THE VCR

FRONT PANEL BRIGHTNESS (VCR DISPLAY)

You can change the brightness level of the fluorescent display panel on the front of the VCR. In the PREFERENCES menu, press 4 to switch between the options.

- AUTO brightens the display when the VCR is on and dims the display when the VCR is off.
- BRIGHT keeps the display bright when the VCR is on or off.
- DIM keeps the display at a low brightness level at all times.

PREFERRED TAPE SPEED

You can set the preferred tape speed between Standard Play (SP) and Super Long Play (SLP). In the PREFERENCES menu, press 5 to switch between the options.

- SP sets the preferred recording speed to SP.
- SLP sets the preferred recording speed to SLP.

Tape Speeds

SP (Standard Play)

Gives the best quality recording, but fewer programs can be recorded on the tape. Special effects such as pause, slow motion, picture search, and frame advance work well when you play back tapes recorded in this speed.

SLP (Super Long Play)

Gives approximately three times the recording time of tapes recorded in SP. Special effects such as pause, slow motion, picture search, and frame advance work well when you play back tapes recorded in this speed.

Approximate Recording Times:

Cassette	SP	SLP
T-120	2 Hr	6 Hr
T-160	2 Hr/40 Min	8 Hr

VCR BASICS

LEARN THE BASICS TO GET YOU STARTED

These VCR basics should be enough for you to begin enjoying your VCR. Learning the remote control functions, playing a recorded tape, and recording a program should do just that.

This section shows you the basics of using your VCR. It discusses things like using the remote control, playing a tape, and recording programs.

1 FIRST THINGS FIRST



2 SETTING UP THE VCR



3 VCR BASICS



4 RECORDING



5 PROGRAM THE REMOTE



6 OTHER FEATURES



7 CONNECTIONS



8 REFERENCE

VCR Basics tells you what you need to know in order to watch a movie or tape your favorite show.

VCR BASICS

REMOTE BUTTONS

Your backlit remote has a light button (📶) that glows in the dark. Press this button to light the buttons on the remote. The remote buttons remain lit when they are pressed within a few seconds of each other. If a button is not pressed within approximately seven seconds, the light turns off to conserve battery power.

The remote control is capable of controlling your VCR and many brands of televisions. If you have an RCA, GE, or PROSCAN TV, you may be able to control it without having to program the remote.

COMPONENT BUTTONS

ON•OFF Turns off VCR when remote is set to control the VCR. Also turns some compatible components on and off.

TV Turns on a compatible RCA, GE, or PROSCAN TV and sets the remote to control the TV. Also used with the ON•OFF button to turn on a different brand of TV (if programmed) and sets the remote to control the TV.

VCR Turns on a compatible RCA, GE, or PROSCAN VCR and sets the remote to control the VCR.

VCR FUNCTION BUTTONS

CHAN Up or Down Selects next higher or lower channel in the VCR's channel memory.

CLEAR Resets time counter to 0:00:00. Allows you to change entries when setting the clock or a timer recording.

F.ADV Lets you view one frame with each press of the button when tape is in pause.

FORWARD Fast forwards the tape when the VCR is stopped. Searches forward through a tape during playback. Starts slow motion during play-pause and increases slow-motion speed.

GO BACK Switches between two channels. Select one channel and then select another using the number buttons. Press GO BACK to switch between the two channels. In menu mode, press to go back to a previous menu.

INFO Shows the status displays on the TV screen.

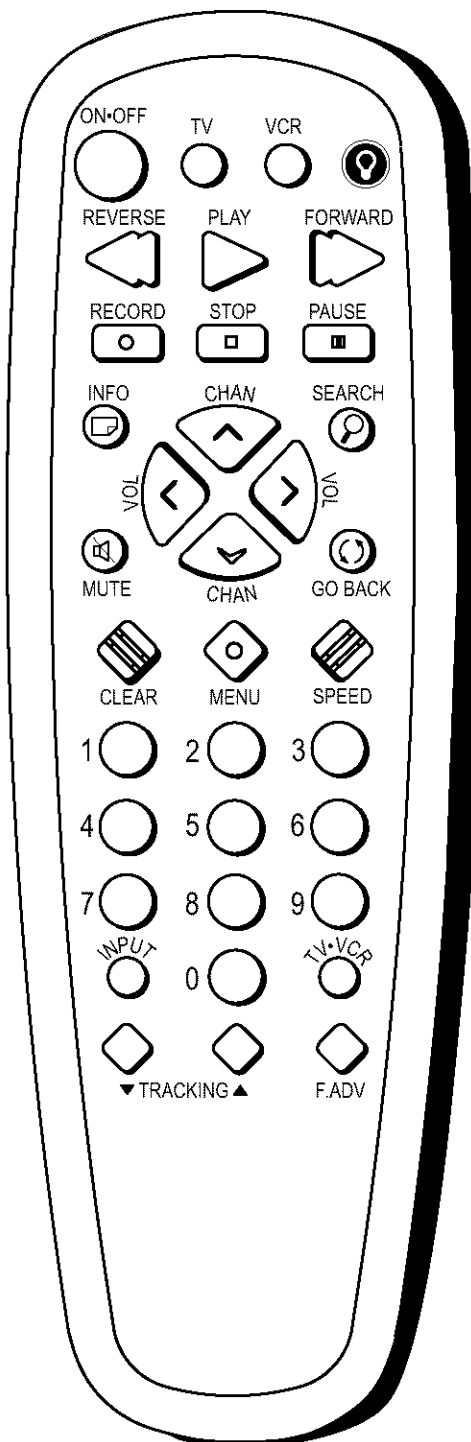

VCR BASICS

INPUT Selects between the VCR's line input or tuner. Line input refers to the signal coming from the component connected to the AUDIO/VIDEO IN jacks on the back (L1) or front (L2) of the VCR.

MENU Brings up VCR MAIN MENU on the TV screen.

Numbers (0 through 9) Select a channel up to 99 by pressing two numbers. Select a cable channel over 99 by pressing and holding 1 until 1 -- appears on the screen. Then press the other two numbers.

PAUSE Pauses playback or recording. Press PAUSE again to return to playback or recording.

PLAY Plays a tape.

RECORD Starts VCR recording. Also used for Express recording.

REVERSE Rewinds the tape when the VCR is stopped. Searches backward through a tape during playback. Starts slow motion during play-pause and decreases slow-motion speed.

SEARCH Displays INDEX and GO-TO Search menus on TV screen when VCR is stopped. Advances the tape 30 seconds of recorded material during playback. Each press advances the tape an additional 30 seconds up to five minutes.

SPEED Selects a recording speed (SP or SLP).

STOP Stops the current VCR function such as record, playback, rewind, or fast forward.

TRACKING Up or Down Lets you manually reduce the streaks that may appear on the picture during play, slow motion, or pause. Reduces picture "jitter" during stop-action playback.

TV•VCR Switches the picture signal so that it either comes from the VCR or cable/antenna system.

TV FUNCTION BUTTONS

CHAN Up or Down Selects next higher or lower channel in the TV's channel memory.

CLEAR Removes menus or status displays from the screen.

GO BACK Switches between two channels. Select one channel and then select another using the number buttons. Press GO BACK to switch between the two channels.

INFO Shows the TV's status displays on the TV screen.

TV Buttons

The TV buttons may not control all features of all models of RCA, GE, or PROSCAN TVs.

If you have trouble getting a picture on the TV screen, refer to "How to Find Your TV's Video Input Channel" on page 68 or the "Troubleshooting" section starting on page 69.

VCR BASICS

INPUT Selects between the TV's input channel or tuner. Press to see the VCR signal if you connected your VCR using the AUDIO/VIDEO jacks.

MUTE Reduces volume to minimum level.

Numbers (0 through 9) Select a channel up to 99 by pressing two numbers. Select a cable channel over 99 by pressing and holding 1 until 1 -- appears on the screen. Then press the other two numbers.

ON•OFF Turns a compatible TV off and on.

VOL Up and Down Raises and lowers sound of TV.

PLAYING A TAPE

1. Tune the TV to your VCR viewing channel (3, 4, or TV's video input- see page 68 for more about the video input channel).
2. Insert a tape in the VCR.

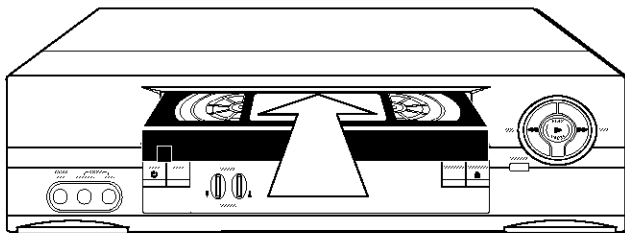

If the Auto Play feature is set to ON, the tape automatically begins playback (if the safety tab on the cassette is removed).

- Press FWD or REV to position the tape.
- Press PLAY PAUSE (if necessary) on the VCR (PLAY on remote) to begin tape play.
- Press PLAY PAUSE (PAUSE on remote) for stop action.
- Press TRACKING up or down to remove any streaks from the picture, if necessary.
- Press STOP•EJECT on VCR (STOP on remote) to stop playback.

AUTOMATIC REWIND

The VCR automatically rewinds the tape if it reaches the end of the tape during playback. While rewinding, you can press POWER on the VCR (ON•OFF on remote) and the VCR will turn off after rewinding.

Pause

If you pause, the VCR automatically switches from pause to stop after a few minutes to reduce tape wear.

Automatic Tracking

The VCR has automatic tracking which adjusts the picture when playing back a tape recorded on another VCR. Automatic tracking is turned on whenever a tape is inserted or the VCR's power is turned on.

VCR BASICS

TAPE EJECT

Press STOP•EJECT on the VCR (STOP on remote) for a few seconds when it is stopped to eject the tape. A tape can be ejected even when the VCR is off.

RECORDING

If you want to record something that you're watching, you can use basic recording. For more detailed information, refer to the "Recording" section starting on the next page.

1. Set the tape speed by pressing TAPE SPEED on the VCR (SPEED on the remote).
2. Press the RECORD button to begin recording.
3. Press STOP to stop recording.

If you just want to pause the recording for a short time (such as during a commercial), press PAUSE instead of STOP.

- For more information about in-depth recording features, refer to the next section.

CHECK THE SAFETY TAB

No matter which recording option you use, you need to make sure there is a tape in the VCR, and that the tape's safety tab is in place. You cannot record on a tape with the safety tab removed.

If the safety tab is removed and you want to record over it, simply cover the hole with vinyl tape.

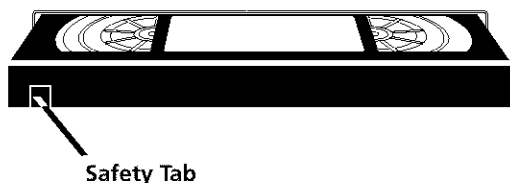

Tape Speeds

SP (Standard Play)

Gives the best quality recording, but fewer programs can be recorded on the tape. Special effects such as pause, slow motion, picture search, and frame advance work well when you play back tapes recorded in this speed.

SLP (Super Long Play)

Gives three times the recording time of tapes recorded in SP. Special effects such as pause, slow motion, picture search, and frame advance work well when you play back tapes recorded in this speed.

Cassette	Recording Time	
	SP	SLP
T-120	2Hr	6Hr
T-160	2Hr	8Hr

RECORDING

SEVERAL RECORDING OPTIONS

Now that you've gone through the basic steps necessary to operate your VCR, it's time to explain the different advanced recording features available to suit your needs.

Recording Features on your VCR include:

- Recording (explained in the *VCR Basics* section)
- Express Recording (XPR)
- Timer Recording
- Timer Recording with VCR Plus+ Interactive Program Guide System
- Broadcast Stereo or Second Audio Program (SAP)
- Audio Only Recording
- Copying and Editing Tapes

1 FIRST THINGS FIRST



2 SETTING UP THE VCR



3 VCR BASICS



4 RECORDING



5 PROGRAM THE REMOTE



6 OTHER FEATURES



7 CONNECTIONS



8 REFERENCE

RECORDING

RECORDING FEATURES

There are four ways to record programs:

- **Recording**– pressing one button to start recording a program (see *VCR Basics* section)
- **Express Recording**– starts recording a program already being watched, and automatically stopping recording after a designated period of time
- **Timer Recording**– automatically starts and stops a recording at a predetermined time
- **Timer Recording with VCR Plus+ System**– programming the VCR by just entering a PlusCode programming number found in TV guides.

EXPRESS RECORDING (XPR)

Use express recording when you want to quickly record the remaining portion of the program you are watching.

1. Set the tape speed to SP or SLP by pressing TAPE SPEED on the VCR (SPEED on the remote).
2. Press the RECORD button to begin recording.
3. Repeatedly press the RECORD button to set up the recording time duration.

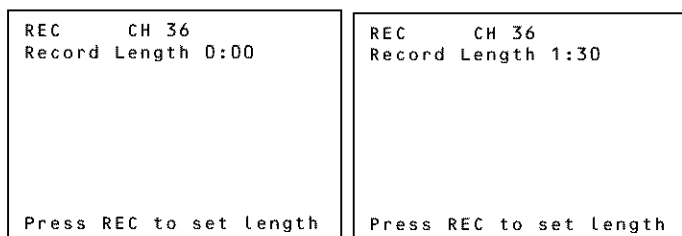

Each time you press the RECORD button, you increase the recording time (up to 4 hours).

The VCR continues to record for the amount of time you indicate, and then automatically turns off.

To stop an express recording, press and hold STOP for three seconds.

Express Recording

Express recording is a great way to tape the last quarter of the game, or the last part of a movie when you have to leave.

RECORDING

TIMER RECORDING

You can set up as many as eight timer recording programs.

1. Press MENU to display the VCR MAIN MENU.

```
VCR MAIN MENU
1 VCR Plus+
2 Timer Recordings
3 Time
4 Channels
5 Preferences
6 Audio
7 Language
0 Exit
```

2. Press 2 to display the TIMER RECORDINGS menu.

```
TIMER RECORDINGS
1 Create a New Program
2 Review Existing Progs.
3 Use VCR Plus+ Code
0 Exit
```

3. Select 1 to Create a New Program.

```
How often should this
program record?
1 One time
2 Daily (every day)
3 Weekdays (M-F)
4 Weekly (once per week)
0 Cancel
```

4. Select how often you want the program to record.

```
Program 1 (One time)
Channel  --
Start Time  --:--
End Time  --:--
Start Date --/--/--
Tape Speed SLP
Press MENU to cancel
```

5. Enter the data for the program with the number buttons.

The data includes the channel number (press INPUT to select the line input), start time, and end time (including AM or PM). The start date is automatically entered based on the VCR clock. The date and/or speed can be changed when flashing.

Timer Recording Information

The Clock must be set correctly.

Insert a tape with the safety tab in place and enough tape to record the program.

“PROGRAMS OVERLAP” appears if you have entered two programs whose times overlap.

The TIMER indicator appears in the display when you turn off the VCR and a timer recording has been set. It flashes if there is no tape in the VCR.

When recording from a cable box or satellite receiver, turn on that unit and tune it to the channel you want to record *before* the recording is to begin. The VCR channel should be set to the cable box's output channel (usually Channel 3 or 4).

RECORDING

- Review the information to make sure it is correct, and then press MENU to save.

Program 1 (One Time) Channel 104 Cable Start Time 08:00 PM End Time 09:30 PM Start Date 11/18/99 Thu Tape Speed SLP Press CLEAR to correct Press MENU for next prog	Program 1 has been saved Remember to insert a recordable tape and turn the VCR off before the program start time. Remember to leave your cable box on and tuned to the desired channel
--	--

TIMER RECORDING WITH VCR Plus+ INTERACTIVE PROGRAM GUIDE SYSTEM

You can use the VCR Plus+ system code numbers to simplify timer programming if you have cable TV and don't receive all channels through a cable box, or if you receive your TV signal off-air.

SETTING UP THE CHANNEL LIST

If you did not set up the VCR Plus+ programming system channel list, you can do it now.

- Display the CHANNELS menu from the VCR MAIN MENU.
- Display the VCR Plus+ Channel List menu.
- Go to section four, *Setting Up Your VCR*, if you need more information on setting up your VCR Plus+ programming system channel list.

USING THE VCR PLUS+ PROGRAMMING SYSTEM

- Press MENU to bring up the VCR MAIN MENU.

VCR MAIN MENU 1 VCR Plus+ 2 Timer Recordings 3 Time 4 Channels 5 Preferences 6 Audio 7 Language 0 Exit
--

VCR MAIN MENU 1 VCR Plus+ 2 Timer Recordings 3 Time 4 Channels	CHANNELS 1 Auto Channel Search 2 Add/Remove Channels 3 Signal Type: CABLE 4 VCR Plus+ Channel List	VCR+ Channel My Channel 5 46 4 -- 3 -> -> -> 23 2 -- 1 -- Use CH+/- to select Press 0-9 to change Press MENU to save
--	--	--

If you receive all channels through your cable box on Channel 3 or 4, you must use the regular Timer Recording method to record programs.

RECORDING

2. Press 1 to display the VCR Plus+ system menu.

```
VCR PLUS+
Enter PlusCode Number
(from TV Listing)
—
Press MENU to cancel
```

3. Enter the VCR PlusCode programming number shown in your local television guide.

```
VCR PLUS+
Enter PlusCode Number
(from TV Listing)
12876
Press CLEAR to correct
Press MENU when done
```

4. Press MENU to enter the VCR PlusCode system number.

```
How often should this
program record?
1 One time
2 Daily (every day)
3 Weekdays (M-F)
4 Weekly (once per week)
0 Cancel
```

5. Indicate how often you want the program to be recorded.

```
Program 1 (One time)
Channel 03 Cable
Start Time 08:00 PM
End Time 09:30 PM
Start Date 11/18/99 Thu
Tape Speed SLP
Press CLEAR to adjust
Press MENU to save
```

6. Change the recording speed with the SPEED button on the remote or the program end time with the CLEAR button on the remote (if necessary).

Changing the end time comes in handy when you are recording a program, such as a sporting event, that may exceed the scheduled broadcast time.

VCR Plus+ Interactive Program Guide System Recording

Clock must be set correctly.

Insert a tape with the safety tab in place and enough tape to record the program.

The **TIMER** indicator appears in the display when you turn off the VCR and a timer recording has been set. It flashes if there is no tape in the VCR.

PROGRAMS OVERLAP appears if you have entered two programs where the times overlap.

UNRECOGNIZED NUMBER... PLEASE RE-ENTER appears when the VCR does not recognize the PlusCode programming system number.

Timer recordings will not be lost in the event of an extended power outage.

RECORDING

7. Press MENU to save the program.

```
Program 1 has been saved  
  
Remember to insert a  
recordable tape and  
turn the VCR off before  
the program start time.  
  
Remember to leave your  
cable box on and tuned  
to the desired channel
```

STOPPING A TIMER RECORDING

To stop or cancel a timer recording in progress (even an express recording):

- Press and hold the STOP button for three seconds.

REVIEWING AND CLEARING PROGRAMS

To review programs that you have already set up:

1. Press 2 when the VCR MAIN MENU is displayed to display the TIMER RECORDINGS menu.

```
TIMER RECORDINGS  
  
1 Create a New Program  
2 Review Existing Progs.  
3 Use VCR Plus+ Code  
  
0 Exit
```

2. Press 2 to display the Review Existing Progs. screen.

```
Program 1 (One Time)  
  
Channel    104 Cable  
Start Time 08:00 PM  
End Time   09:30 PM  
Start Date 11/18/99 Thu  
Tape Speed SLP  
  
Press CLEAR to correct  
Press MENU for next prog
```

3. Press CLEAR to erase or MENU to see the next program.

RECORDING

RECORDING BROADCAST STEREO TV OR SAP (SECOND AUDIO PROGRAM)

Some TV programs are broadcast with stereo audio or SAP (Second Audio Program).

1. Turn on the TV and tune it to the VCR viewing channel (either 3, 4, or TV's video input).
2. Insert a tape with safety tab in place.
3. If your VCR viewing channel is 3 or 4, make sure the VCR indicator appears in the VCR's display panel. If not, press TV•VCR to turn it on.
4. Use the SPEED button on the remote to select a recording speed. The tape speed indicator appears on the TV screen.
5. Select the channel or line input to be recorded.
6. Set the Reception: STEREO/MONO/SAP feature for the type of audio you want to record. See *Other Features* section.

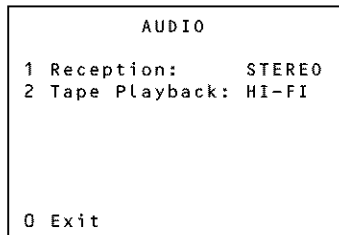

7. Press RECORD to start recording.
8. Press STOP when you are finished.

RECORDING AUDIO ONLY

You can record audio only from another audio source connected to the AUDIO IN (R and L) jacks on the back or front of the VCR.

1. Press the INPUT button on the remote to select the line input (L1 or L2). Select (L1) to record from the back jacks or (L2) to record from the front jacks.

The VCR will record audio from the audio equipment connected to the AUDIO IN jacks.

2. Use TAPE SPEED on the VCR (SPEED on the remote) to select the recording speed.
3. Start audio source playing and press RECORD to begin recording.
4. Press STOP when you are finished.

Video Input Channel Explained

If you're having trouble understanding the TV's Video Input Channel, turn to page 68 for more information.

Recording audio only will erase anything that was previously recorded on the tape.

Audio Connection

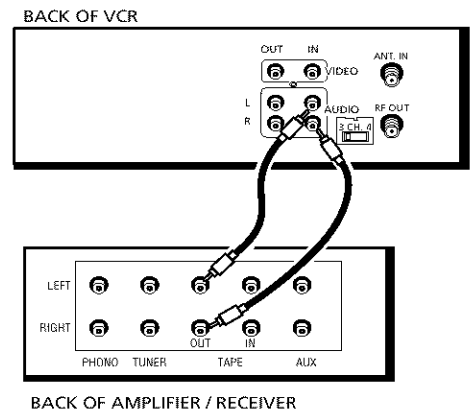

RECORDING

PLAYING BACK AUDIO ONLY

To get stereo sound, connect the AUDIO OUT jacks of the VCR to the appropriate input on your amplifier or receiver. Do not use the phono input. Refer to your amplifier or receiver user's guide.

USING TWO VCERS FOR COPYING AND EDITING TAPES

Use one VCR as the *playback VCR* and the other as the *recording VCR*.

1. Connect the VCRs using the diagram at the right.
2. Turn on both VCRs and TV.
3. Tune the TV to the VCR viewing channel (either 3, 4, or TV's video input). (See page 68 for more information)
4. If you are using coaxial cables for the connection, tune *recording VCR* to channel 3 or 4—the one selected on the *playback VCR*

If you are using audio/video cables, select the line input on the *recording VCR*

5. Insert the tape you want to copy into *playback VCR*. Insert a blank tape with its safety tab in place into *recording VCR*
6. Using visual search, locate the segment you want to copy on the *playback VCR*. Pause the tape at this location
7. Press RECORD on the *recording VCR*, then PAUSE.
8. Press PAUSE on both VCRs to begin copying.
9. Press PAUSE on both VCRs to stop copying.
10. Repeat steps 6–9 to copy or edit additional segments.

Caution:

The unauthorized recording of satellite broadcasts, television programs, or other copyrighted materials may infringe the rights of others.

Two VCR Connection

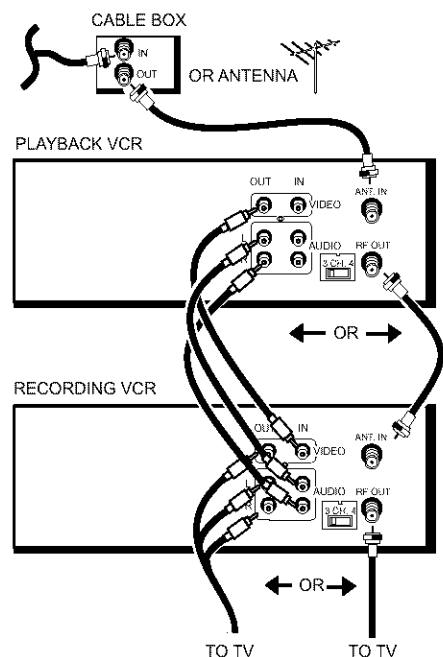

PROGRAM THE REMOTE

CONTROL YOUR TELEVISION

The remote can be programmed to control a television.

It is programmed to control an **RCA, GE, or PROSCAN TV**. Other manufacturer's brands need to be programmed.

1 FIRST THINGS FIRST



2 SETTING UP THE VCR



3 VCR BASICS



4 RECORDING



5 PROGRAM THE REMOTE



6 OTHER FEATURES



7 CONNECTIONS



8 REFERENCE

PROGRAM THE REMOTE

ABOUT PROGRAMMING THE REMOTE

The remote can be programmed to control other brands of remote controllable TVs. It is already programmed to operate most RCA, GE, and PROSCAN televisions.

PROGRAMMING THE REMOTE TO CONTROL A TV

If the TV does not turn on when you press the TV button, the remote needs to be programmed.

Follow these steps to program the remote to control your particular TV:

1. Turn on the TV.
2. Find your TV brand and code number(s) on the code list on the next page.
3. Press and hold the TV button on the remote.
4. Enter the code from the code list.
5. Release TV, and then press CHAN up or down. If the TV responds to the remote commands, the remote is programmed.
6. If the TV does not respond, repeat these steps using the next code listed for your TV's brand.

OPERATING THE TV

After you set up the remote, see which buttons operate your TV.

1. Point the remote at the TV, and press the TV button.
If the TV does not turn on, press the TV button and then press the ON•OFF button.
2. You may want to experiment to see which buttons operate your TV. Try pressing buttons, such as VOL and MUTE. See "TV Function Buttons" in the *VCR Basics* Section for details.

This remote may not operate all models of the brands that are shown.

Note the difference between the TV and VCR on-screen displays to see which one the remote is operating.

PROGRAM THE REMOTE

TV Codes

Akai	03	NAD	07
AOC	06,12	NEC	06
Candle	06	Panasonic	04,08,11
Citizen	06	Philco	04,06,12
Colortyme	06	Philips	03,04,06,12
Concerto	06	Pioneer	06
Curtis Mathes	01,06	Portland	06,12
Daewoo	06,12	PROSCAN	01
Daytron	06	Proton	06
Electrohome	06,12	Quasar	11
Emerson	06	Radio Shack	01,05,13
Envision	05,06	RCA	01,06,12
Fisher	05,08	Realistic	05
GE	00,01,06,11	Sampo	06
Goldstar	06,12	Samsung	06,09,12
Hallmark	06	Sanyo	05,08
Hitachi	06,14	Sears	01,05,06,07, 08,10,12
Infinity	04	Sharp	06,13
J C Penney	00,01,06,09,12	Sony	03
JBL	04	Soundesign	06
Jensen	06	Sylvania	04,06,12
JVC	10,11	Technics	11
Kawasho	03,06	Techwood	06
Kenwood	06,12	Teknika	06
Loewe	04	TMK	06
Luxman	06	Toshiba	05,07,08,09
LXI	04,05,07	Universal	00
Magnavox	04,06,12	Victor	10
Marantz	04,06	Wards	00,01,04,06,12,13
MGA	06,12	Yamaha	12
Mitsubishi	06,12	Zenith	02
MTC	06		

OTHER FEATURES

FEATURES TO ENHANCE VCR OPERATION

- **Commercial ►► Advance***
- **Movie ►► Advance****
- **Picture Search Options**
- **Tracking**
- **Pro-Tect Plus™ Locking**
- **Time Counter**
- **On-Screen Displays**
- **Audio Reception**
- **Audio Playback**

1 FIRST THINGS FIRST



2 SETTING UP THE VCR



3 VCR BASICS



4 RECORDING



5 PROGRAM THE REMOTE



6 OTHER FEATURES



7 CONNECTIONS



8 REFERENCE

*COMMERCIAL ►► ADVANCE is a registered trademark of SRT, Inc.

**MOVIE ►► ADVANCE is a registered trademark of Aurthur D. Little Enterprises, Inc.

OTHER FEATURES

COMMERCIAL▶▶ADVANCE

COMMERCIAL▶▶ADVANCE is patented technology that detects and marks most commercials on your tape for any recording that is more than 15 minutes long. After recording, the VCR rewinds the tape to the beginning of the recording and determines where the commercials are located. It then marks the beginning and end of the detected commercial segments, and when finished, returns the tape to the end of the recording. **It does not erase commercials from the tape.**

During playback, the VCR automatically skips the detected commercial segments, or you can chose to manually skip them. This feature reduces three minutes of commercials to approximately 8-12 seconds of fast forwarding in the SLP speed. You can select a background display of blue or see the video as the commercials are skipped.

Because television signals do not indicate where commercials are located, this feature finds and marks them through a set of formulas based on how television is broadcast today. Since television stations broadcast differently and insert their own commercials, you may experience some variations in this feature's effectiveness. Station promotions, identifications, and announcements are not considered commercials, but might be skipped. For more information, see "Questions and Answers About COMMERCIAL▶▶ADVANCE " in the Reference section. All of the COMMERCIAL▶▶ADVANCE features are accessed through the Commercial Advance menu.

1. Press MENU to display the VCR MAIN MENU.

```
VCR MAIN MENU
1 VCR Plus+
2 Timer Recordings
3 Time
4 Channels
5 Preferences
6 Audio
7 Language
0 Exit
```

2. Press 5 to display the PREFERENCES menu.

OTHER FEATURES

```
      P R E F E R E N C E S
1 Remote Control:  VCR1
2 Auto Play:      ON
3 EnergySaver:    2:00
4 Front Panel:    AUTO
5 Tape Speed:     SLP
6 Commercial Advance

0 Exit
```

3. Press 6 to display the COMMERCIAL ADVANCE menu.

```
    C O M M E R C I A L   A D V A N C E
1 Marking:         ON
2 Playback:        MANUAL
3 Display:         Blue

0 Exit
```

Now you can select one of the COMMERCIAL ►► ADVANCE features.

COMMERCIAL ►► ADVANCE Marking

Press 1 to turn commercial marking ON or OFF.

- Select ON, and the VCR will mark commercials within approximately 30 seconds for the following types of recording:
 - **Timer, Timer with VCR Plus+, or Express Recording**
Sets the VCR to automatically mark commercials after the power is tuned off.
 - **Recording** Allows the VCR to prompt you to mark the commercials when you've stop the recording.

```
The VCR is waiting to
mark commercials in the
program you recorded.

1 Mark them now
2 Mark them later
3 Don't mark commercials

The VCR will begin
marking in 30 seconds...
```

- Select OFF and the VCR will not mark the commercials.

OTHER FEATURES

COMMERCIAL ►► ADVANCE Playback

Press 2 to switch between Playback: AUTO and MANUAL.

- Select AUTO to have the VCR automatically advance through the blocks of marked commercials.

It works with most 30, 45, and 60-second commercials.

A commercial group starting with the first two minutes or last two minutes of a recording will not automatically be skipped.

A commercial will not be skipped if a recording starts in the middle of a commercial segment, one isolated commercial is shown without others, or a commercial is longer than one minute. Press FWD on the VCR (FORWARD on remote) to scan through the commercial.

Part of a recorded program may be skipped if the program segment is between commercials and less than one minute or there are frequent dark and quiet scenes. If part of the program is skipped, rewind the tape to the beginning of the skipped program segment and press PLAY.

- Select MANUAL and the VCR won't advance through the blocks of marked commercials until you press SEARCH.

If you press SEARCH during playback of material other than commercials, the VCR advances to the end of the next "marked" commercial block and resumes playback.

The VCR resumes playback when it reaches the end of the marked commercials.

COMMERCIAL ►► ADVANCE Display

Press 3 to switch between Display: BLUE or VIDEO.

- Select BLUE to display a blue background when the VCR advances through the block of marked commercials.
- Select VIDEO to display the recorded video when the VCR advances through the block of marked commercials.

OTHER FEATURES

MOVIE ►► ADVANCE

MOVIE ►► ADVANCE helps you locate certain parts of prerecorded movies (rented or purchased). This feature works two ways: 1) you can go to the beginning of the movie, or, 2) you can skip from one preview to the next. MOVIE ►► ADVANCE works only on cassettes recorded in the SP speed with the safety tab removed.

1. To select MOVIE ►► ADVANCE, insert a tape with the safety tab removed and press SEARCH. The following menu appears:

```
MOVIE ADVANCE
What type of tape
is this?

1 Purchased/Rented Movie
2 Home Recording
3 Other

Press CLEAR to cancel
```

2. Press 1 if the tape is a purchased or rented movie, press 2 if it's a recording made at home, or press 3 if it's something else, you don't know, or you do not want to select MOVIE ►► ADVANCE.

Pressing 2 or 3 gives the same response and takes you to a different search feature. If you accidentally make a wrong selection, press STOP•EJECT on the VCR (STOP on remote) and reinsert the tape. Press SEARCH.

If you press 1, the MOVIE ADVANCE menu appears.

```
MOVIE ADVANCE

Would you like to go to
the start of the movie
or to the next preview?

1 Go to movie
2 Go to preview

Press CLEAR to cancel
```

3. Press 1 to advance directly to the beginning of the movie or press 2 to view the first (next) preview.

MOVIE ►► ADVANCE works only on cassettes recorded in the SP speed with the safety tab removed.

OTHER FEATURES

- Press 1 to Go To Movie. The following screen appears with a blue background.

```
MOVIE ADVANCE
What type of tape
is this?

1 Purchased/Rented Movie
2 Home Recording
3 Other

Press CLEAR to cancel
```

When the movie is found, the following screen is displayed:

```
MOVIE ADVANCE

The movie is ready.
Press PLAY to start.

Press STOP to cancel
```

This display will time out after a few minutes and the VCR will enter the Stop mode.

- Press 2 to Go To Preview. The following screen appears with a video background:

```
Searching for preview

Press SEARCH to reverse
Press STOP to cancel
```

When a preview is detected, the VCR cues it and begins playing.

```
Press SEARCH for next
```

Preview Search Note

Any time during the preview search mode, pressing SEARCH will reverse the search direction.

OTHER FEATURES

PICTURE SEARCH OPTIONS

The most basic way to search during playback is using the FORWARD or REVERSE buttons on the remote. This section contains several other options available for searching a tape.

FORWARD AND REVERSE SEARCH

You can search a tape during playback. Sound is turned off during picture search. Search works well for tapes recorded at either the SP or SLP speed.

1. Press FORWARD to search forward or REVERSE to search in reverse.
2. Press FORWARD or REVERSE again or press PLAY to return to normal playback.

SLOW MOTION

You can view a tape during play or play-pause using slow motion. Slow motion works well for tapes recorded at the SP or SLP speed.

1. During playback, press PAUSE and then FORWARD or REVERSE to begin slow-motion playback.
2. Press FORWARD to increase or REVERSE to decrease the speed of the search.
3. Use TRACKING up or down to remove any streaks from the picture.
4. Press PLAY to return to normal playback. The VCR switches automatically from slow-motion playback to stop after a few minutes.

OTHER FEATURES

FRAME ADVANCE

Frame advance lets you view recorded action one frame after another during playback. Frame advance works well for tapes recorded at the SP or SLP speed.

- Pressing PAUSE “freezes” the action
- Pressing F.ADV repeatedly views single frames of the action
- Pressing PAUSE or PLAY returns normal playback.

INDEX SEARCH

The VCR has a “VHS Index Search System” that automatically records an index mark on the tape every time you start a recording.

During playback you can locate the program you want to play by the number of index marks or by scanning. The VCR will search forward or reverse from the location you are on the tape.

To Search:

1. Press STOP.
2. Press SEARCH on the remote to display the INDEX SEARCH on-screen display.
3. If you want to search through a certain number of index marks, press two number buttons to enter the number of marks you want to search. Press CLEAR on the remote to correct an entry.
4. Press FORWARD to search forward or REVERSE to search in reverse. The VCR will locate your index mark and begin playback. If you did not enter a specific index number, the VCR will locate the next index mark and begin playback.
5. Press STOP to end index searching.

Some index marks may be missed by the VCR:

- A mark too close to your location on the tape
- The mark at the beginning of a recorded segment of five minutes or less
- The first index mark on the tape when you start at the beginning of the tape.

```
INDEX SEARCH
Press REV OR FWD
to begin scanning
OR
enter a specific
index number
  ---
Press SEARCH to exit
```

```
INDEX SEARCH
Searching for
index number 12...
Press STOP to cancel
```

```
INDEX SEARCH
Searching for
index marks...
Press STOP to cancel
```

OTHER FEATURES

GO-TO SEARCH

The Go-To Search feature enables the VCR to quickly locate a counter reading anywhere on the tape. When the VCR locates the counter reading, it will begin playback.

1. Press STOP.
2. Press SEARCH on the remote until the GO-TO SEARCH menu appears on the screen.
3. Press number buttons to enter the hour and/or minute of the counter reading you want the VCR to "go to." Press CLEAR on the remote to correct an entry.
4. Press FORWARD to search ahead or REVERSE to search behind.
5. Press STOP to end Go-To searching.

```
GO-TO SEARCH
Current tape counter is
      2:17:25
Press REV or FWD
to go to -:--:00
Press SEARCH to exit.
```

```
GO-TO SEARCH
Current tape counter is
      2:17:25
Press REV or FWD
to go to 0:00:00
Press SEARCH to exit.
```

TRACKING

Your VCR has automatic tracking which removes interference like streaks or "snow" from the picture. Automatic tracking is automatically activated when you insert a tape or turn on the VCR. Occasionally you may need to manually adjust tracking, especially if the tape was recorded on a different VCR. Just use the TRACKING buttons to reduce the distortion. You can also use tracking when you pause a tape to reduce jittering of the picture.

When you manually adjust the picture, automatic tracking is turned off. To turn automatic tracking back on, press both TRACKING buttons on the front of the VCR at the same time, or eject the tape and re-insert it. Tracking has no effect during recording—only playback.

If you insert a pre-recorded tape with the safety tab removed-- Index and Go-To searches are not available.

OTHER FEATURES

PRO-TECT PLUS™ LOCKING FEATURE

To disable the usage of the VCR, or to protect your timer recordings, you can lock the VCR so that the buttons on the VCR or remote won't work.

- **To Lock:** Press and hold the VCR button on the remote for approximately six seconds. SAFE appears.
- **To Lock While a Timer Recording is in Progress:** Press and hold the VCR button on the remote for approximately six seconds.
- **To Unlock:** Press and hold the VCR button on the remote for approximately six seconds.

TIME COUNTER

The time counter shows the actual time it takes to record a program or play back a segment of a recorded tape. It helps locate the beginning or end of programs you taped. The time counter resets to 0:00:00 whenever the tape is ejected from the VCR.

For example, if you record a 30-minute program at the beginning of the tape and you want to go to the end of that program to begin another recording, you would:

1. Press INFO **twice** to display the time counter.
2. Press CLEAR to reset the time counter to 0:00:00.
3. Press FORWARD to forward the tape until the time counter reads 0:30:00.
4. Press STOP. This is the approximate end of the program. (You may want to press PLAY to verify.) Now, you can begin recording at this spot.
5. Press INFO to remove the time counter from the screen and return to the normal display mode.

Locking Your VCR

If a timer recording is programmed, make sure your VCR is turned off. Locking your VCR prevents the VCR from being accidentally turned on.

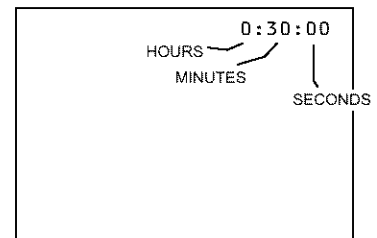

Timer Counter on-screen display shows hours, minutes and seconds of a segment of tape.

OTHER FEATURES

ON-SCREEN DISPLAYS

The INFO button shows the status of the VCR (STOP, PLAY, RECORD, etc.), channel number, time counter, date, time, and tape speed on the TV screen. The date and time must be set before they can be displayed.

1. Press INFO to see the on-screen displays.
 2. Press INFO again to have only the time counter remain on the screen.
 3. Press INFO again to remove the time counter from the screen.
- Turning off the VCR also resets the displays.

AUDIO SET-UP FEATURES

The audio set-up features enhance your tape playback and recordings. The features in this section are accessed through the AUDIO menu and are shown in the displays below.

1. Press MENU to display the VCR MAIN MENU.

```
VCR MAIN MENU
1 VCR Plus+
2 Timer Recordings
3 Time
4 Channels
5 Preferences
6 Audio
7 Language
0 Exit
```

2. Press 6 to display AUDIO menu.

```
AUDIO
1 Reception: STEREO
2 Tape Playback: HI-FI
0 Exit
```

Now you are ready to select an item from the menu to set up.

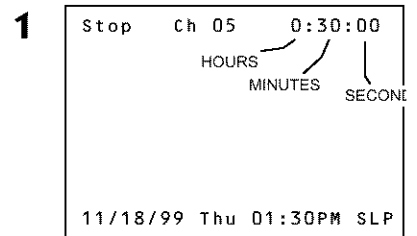

On-screen display (times out)

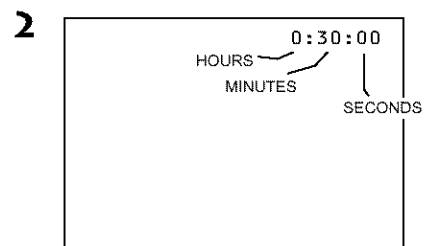

Time counter only (does not time out)

To receive Hi-Fi stereo sound, use audio-video cables with a compatible TV or receiver. Using only the RF OUT jack will not produce stereo sound.

OTHER FEATURES

RECEPTION

Some TV programs are broadcast with stereo audio or a Second Audio Program (SAP) which offers a second language. The reception feature lets you select the type of audio you want to record. Press 1 to switch between Reception: STEREO, MONO, and SAP.

- Select STEREO for normal or stereo broadcast TV recording.
- Select MONO if the stereo signal is weak and the sound is too noisy.
- Select SAP to record a Second Audio Program instead of normal audio on both the Hi-Fi and linear tracks.

TAPE PLAYBACK

The VCR records the same audio on both Hi-Fi and linear tracks on the tape. Hi-Fi sound is recorded on a separate left and right stereo channels. Monaural sound is recorded on the linear track. Press 2 to switch between Tape Playback: HI-FI, LINEAR, or MIX.

To enjoy Hi-Fi sound, connect your VCR to a stereo television or amplifier/receiver using the AUDIO/VIDEO jacks. The Tape Playback feature lets you select which audio you use during playback.

- Select HI-FI to play back sound recorded on the Hi-Fi track and for normal use.
- Select LINEAR to play back sound recorded on a linear monaural track, such as a Second Audio Program (SAP), or a dubbed voice.
- Select MIX to play back the sound recorded on both the linear and Hi-Fi tracks, sound-on-sound.

CONNECTIONS

THINGS TO KNOW BEFORE CONNECTING COMPONENTS

Protect Your Components from Power Surges

- Connect all components before plugging any power cords into the wall outlet.
- Always turn off the TV and other components before you connect or disconnect any cables.

Position Cables Correctly to Avoid Audio Hum or Interference

- Insert all cable plugs firmly into their jacks.
- Place the audio/video cables to the sides of the TV's back panel instead of straight down the middle after you connect your components.
- Try not to coil any twin-lead cables and keep them away from the audio/video cables as much as possible.
- Make sure all antennas and cables are properly grounded. Refer to the Safety Tips sheet packed with your unit.

Protect Your Components from Overheating

- Do not block ventilation holes in any of the components. Arrange the components so that air can circulate freely.
- Do not stack components.
- Allow adequate ventilation when placing your components in a stand.
- Place an amplifier or satellite receiver on the top shelf of the stand so heated air rising from it will not flow around other components.

1 FIRST THINGS FIRST



2 SETTING UP THE VCR



3 VCR BASICS



4 RECORDING



5 PROGRAM THE REMOTE



6 OTHER FEATURES



7 CONNECTIONS



8 REFERENCE

CONNECTIONS

CONNECTING YOUR VCR

Refer to these pages to help you connect your VCR.

JACKS AND CABLES

RF Jacks and Coaxial Cables (F-type)

The RF jacks provide good picture and mono sound quality, and must be used if audio/video connections are not available for your TV.

These jacks are required for antenna or cable-TV connections. The RF jacks on the VCR are labeled ANT. IN and RF OUT. The coaxial cable supplied with your VCR is used to connect the VCR's RF OUT jack and your TV's antenna input.



RF Jack

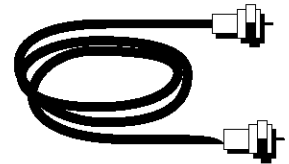

Audio/Video Jacks and Cables (RCA-type)

The AUDIO/VIDEO jacks provide very good picture quality and stereo sound, and can be used if your TV has audio/video input jacks. For more information about the TV's Video Input Channel, see page 68.

These jacks are used for most audio/video connections between components. The VCR's AUDIO/VIDEO jacks are color coded (yellow for video and red and white for audio). If your TV only has one input for audio, you may need a Y-adaptor to hear sound from both channels.



Audio/Video Jack

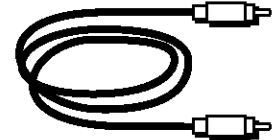

CONNECTIONS

CHOOSING A VCR CONNECTION

There are several different ways to connect your VCR, depending on whether or not you have cable service, and if you have a cable box, and whether some of the channels are scrambled... well, you get the picture.

Three connections are described in this section and one of them should provide you with a VCR connection that works.

- TV with RF Jack Only
- TV with Audio/Video Jacks
- TV with Audio/Video Jacks and Cable Box to Unscramble Pay Channels Only

If you need to connect additional components not shown in the diagrams here (and are unsure of how to connect them), refer to the instruction manual that came with that particular component.

ADVANTAGES OF AUDIO/VIDEO CABLE CONNECTIONS

Using a simple coaxial cable connection gives you good picture quality. If your television has AUDIO/VIDEO jacks though, it is highly recommended that you use them to get even better picture quality and Hi-Fi stereo sound when recording and playing back videotapes. These connections give you more convenient operation by not having to share the TV's antenna signal. If you are having a hard time understanding the TV's Video Input Channel, refer to page 68 for more information.

CONNECTIONS

TV WITH RF JACK ONLY

This connection assumes:

- You are connecting antenna, cable, or cable box system.
- Your television has only an RF input jack.

This connection provides:

- Mono sound playback from VCR
- Record one channel while watching another (except when using a cable box for all channels).

To use this connection, you must have:

- (1) coaxial cable for cable or antenna connection; (2) for cable box.

To connect:

1. Connect cables as shown
2. Return to *First Things First*, then follow the steps.

Using This Connection

Tune your TV to channel 3 or 4, whichever one you selected with the 3 CH. 4 switch on the back of the VCR.

To play a tape:

1. Insert a tape
2. If necessary, press PLAY.

To record one program and watch another:

1. Begin recording a program using one of the recording features
2. Press the TV•VCR button and select a different channel on the TV.

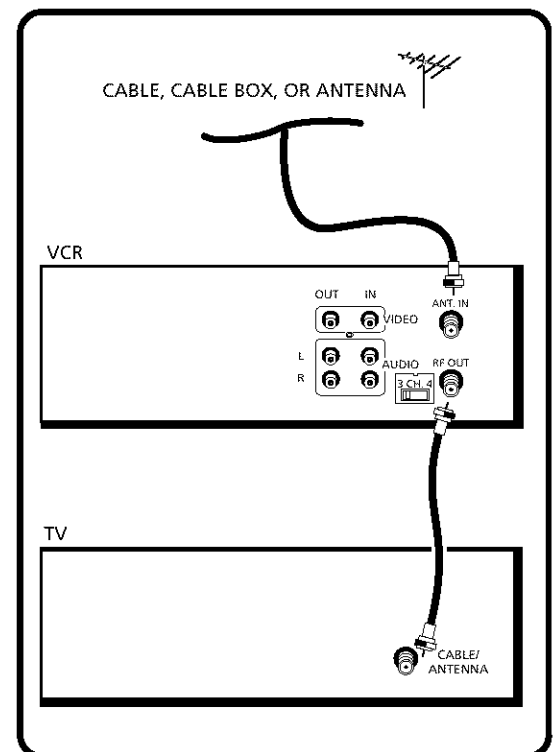

CONNECTIONS

TV WITH AUDIO/VIDEO JACKS

This connection assumes:

- You are connecting an antenna, cable, or cable box system
- Your television has audio/video jacks

This connection provides:

- Hi-Fi stereo sound playback from VCR
- Record one channel while watching another (except when using a cable box for all channels)

To use this connection, you must have:

- (1) coaxial cable for cable/antenna connection; (2) for cable box
- (2) audio/video cables

To connect:

1. Connect cables as shown.
2. Return to *First Things First*, then follow the steps.

Using This Connection

Tune your TV to its Video Input Channel (see page 68 for more information). Use of TV•VCR button is not required.

To play a tape:

1. Insert a tape.
2. If necessary, press PLAY.

To record one program and watch another:

1. Begin recording a program using one of the recording features.
2. Select a different channel on the TV.

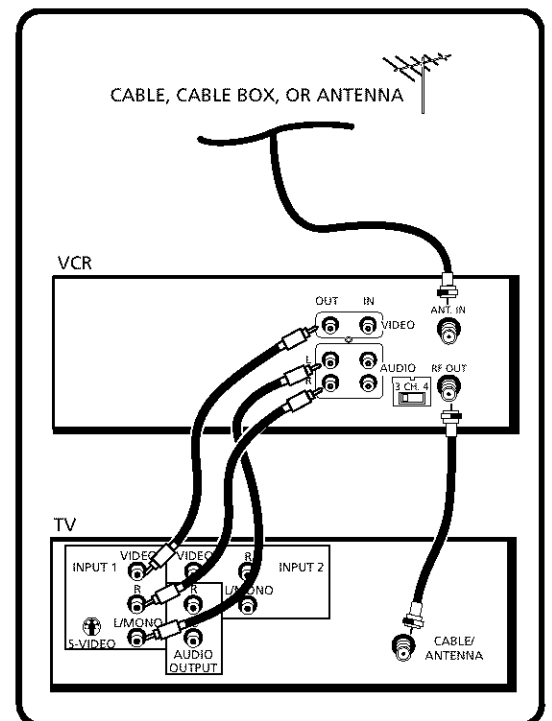

CONNECTIONS

TV WITH AUDIO/VIDEO JACKS AND CABLE BOX TO UNSCRAMBLE PAY CHANNELS ONLY

This connection assumes:

- You are using a cable box only to unscramble premium channels
- Your TV has audio/video input jacks

This connection provides:

- Hi-Fi stereo sound playback from the VCR
- Recording a scrambled or unscrambled channel through the cable box while watching an unscrambled channel

To use this connection, you must have:

- (3) coaxial cables
- (2) audio/video cables
- (1) splitter

To connect:

1. Connect cables as shown.
2. Return to *First Things First*, then follow the steps.

Using This Connection

Tune your TV to its Video Input Channel (see page 68 for more information). Use of TV•VCR button is not required.

To play a tape:

1. Insert a tape.
2. If necessary, press PLAY.

To record a scrambled or unscrambled program and watch another unscrambled program:

1. Begin recording a scrambled or unscrambled program through the cable box using one of the recording features.
2. Select an unscrambled channel on the TV.

All scrambled channels must be viewed through the VCR.

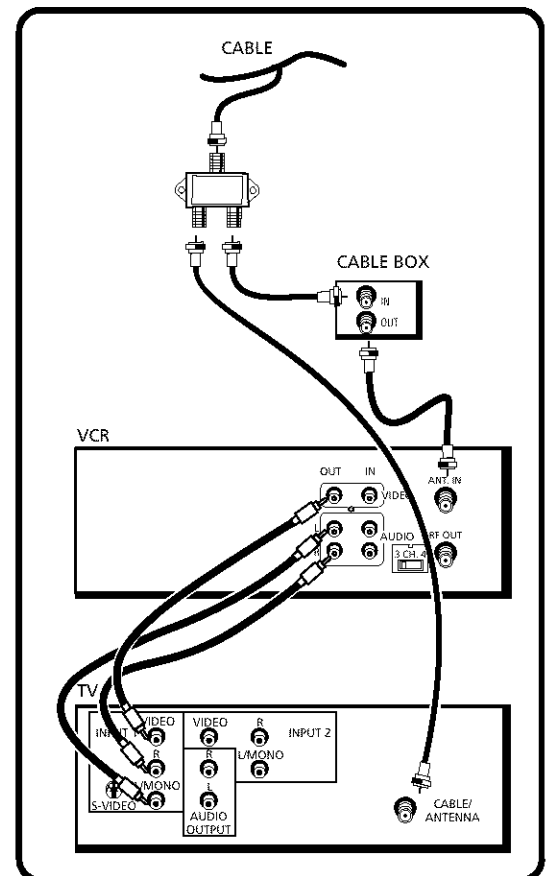

APPENDIX: REFERENCE

This section gives you some additional information about the VCR, including a description of the unit's controls and displays.

You will also find the section, *Troubleshooting Tips*, and a question and answer section about **COMMERCIAL ►► ADVANCE** in this Appendix. These areas might help resolve some of those simple problems.

Finally, this section of the manual also contains your warranty information.

1 FIRST THINGS FIRST



2 SETTING UP THE VCR



3 VCR BASICS



4 RECORDING



5 PROGRAM THE REMOTE



6 OTHER FEATURES



7 CONNECTIONS



8 REFERENCE

APPENDIX: REFERENCE

FRONT PANEL

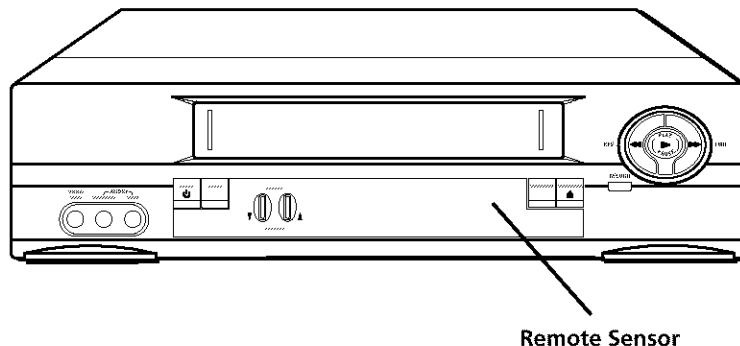

AUDIO (LEFT MONO and RIGHT) and VIDEO INPUT Jacks Receives signals from another component, like a VCR or camcorder, when it is connected to these jacks. Use INPUT on the remote to select L2 to record from these jacks.

CHANNEL TRACKING Up or Down Selects next higher or lower channel in the VCR's channel memory. Adjusts tracking when a tape is playing. Press both together to recenter tracking.

FWD Forwards the tape when the VCR is stopped. Searches the picture forward during playback. Starts slow motion during play-pause and increases slow-motion speed.

PLAY PAUSE Plays a tape. Pauses action for viewing during playback. Pauses recording to prevent recording of unwanted scenes.

POWER Turns the VCR on or off.

RECORD Starts VCR recording. Used for express recording.

Remote Sensor Receives signals from the remote control. Aim the remote at this sensor.

REV Rewinds the tape when the VCR is stopped. Searches the picture in reverse during playback. Starts slow motion during play-pause and decreases slow-motion speed.

TAPE SPEED Selects a recording speed (either SP or SLP).

STOP•EJECT Stops the normal functions such as record, playback, rewind, fast-forward, or pause. Ejects the tape when the VCR is stopped.

TV•VCR Switches the picture signal so that it either comes from the VCR or the cable/antenna system.

APPENDIX: REFERENCE

DISPLAY PANEL



Time, Channel Number, Line Input Indicator (L1 or L2), Tape Speed Indicator, or Status Indicator

Channel Number or Line Input Indicator The channel number appears when the VCR is tuned to a channel. The line indicator (L1 or L2) appears when the VCR's line input is selected. Select L1 to record from the back jacks, L2 to record from the front jacks.

Time The current time appears. Only an AM indicator appears with the time. There is no indicator for PM.

Status Indicators Show what the VCR is doing.

- **EJCT** (Eject) Cassette ejected
- **FF** Fast forwarding
- **HI** VCR turned on and **BYE** VCR turned off
- **PLAY** In playback (flashes during play-pause and slow)
- **REC** Recording and **RECP** For record-pause or pause mode
- **REW** Rewinding
- **R0:30** Express recording in progress
- **SAFE** Pro-Tect Plus feature turned on
- **STILL** Play-pause
- **SCH** and **SCH** – Forward or reverse search
- **SP** and **SLP** Tape speed
- **STOP** Tape is stopped

Timer Indicator (⌚) Lights during an express or timer recording or when the VCR is set for a timer recording and turned off. Flashes when a timer recording is set and there is no tape in the VCR.

VCR Indicator (Applies only if the VCR Viewing Channel is 3 or 4). Press the TV•VCR button to turn on or off.

- VCR indicator on: Picture from VCR.
- VCR indicator off: Picture from TV channel.

APPENDIX: REFERENCE

BACK PANEL

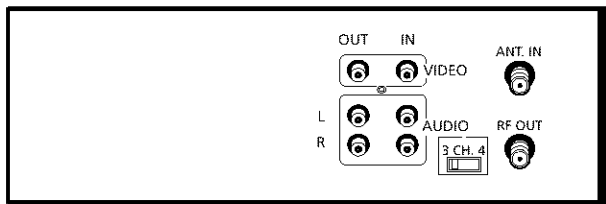

3 CH. 4 Switch Selects the channel to which you will tune the TV to see the VCR picture if you connect the VCR using one of the basic hookups.

AUDIO (R and L) and VIDEO IN Jacks Receives signals from another component, like a VCR or camcorder, when it is connected to these jacks. Use INPUT on the remote to select L1 to record from these jacks.

AUDIO (R and L) and VIDEO OUT Jacks Sends signals from VCR to another component, like a TV or VCR, when it is connected to these jacks.

ANT. IN Jack Receives a signal from an antenna or cable system when attached.

RF OUT Jack Passes signal to TV using the cable supplied.

APPENDIX: REFERENCE

TROUBLESHOOTING TIPS

No power

- Check to make sure it is plugged into an operating outlet.
- Check to make sure your connections are correct.

VCR does not respond to remote

- Check to make sure there are no objects between the VCR and remote.
- The batteries may need changing.
- Make sure the Remote VCR1/VCR2 setting is set to VCR1 so the remote that came packed with your VCR can operate it.

Poor or no picture for normal TV viewing

- Check to make sure the VCR indicator is off.
- Check to make sure the TV is switched to an active channel.
- Check to make sure the antenna connections are secure and correct.

Snowy or no picture during playback

- Press TV•VCR to turn VCR indicator on.
- Check TV channel selected (3 or 4) to make sure it matches the channel selected with 3 CH. 4 switch on back of VCR.
- Check to make sure the TV's fine tuning is correct for the channel you have selected.
- Check video cable connections between VCR and TV monitor.
- Check to make sure the TV monitor is set to Video Input (see page 68 for more information).
- Try another tape.
- Some snow/streaks are normal during search, stop action, frame advance, and slow-motion playback.

Streaks in picture during normal playback

- Press one of the TRACKING buttons to move streaks up or down for the best picture.
- Check to make sure the tape is of good quality and not worn out.

APPENDIX: REFERENCE

Time counter not working or time counter not working in search modes

- The time counter does not advance during unrecorded portions of tape. When an unrecorded segment of tape is encountered, the time counter will hold its count until recorded material is detected again.
- A minus (-) will appear in front of the time if you rewind the tape farther back than a counter reading of 0:00:00.
- The time counter disappears during search; this is normal.

Will not record or play

- Check to make sure there is a tape in the VCR.
- Try ejecting and reinserting the cassette.
- Check to make sure the tape is not broken.
- Check to make sure the VCR is not in pause mode. Press PAUSE or PLAY to return to normal playback.
- Check the ProTect Plus™ feature.

Rewind does not operate

- Check to make sure the tape is not already rewound.

VCR Plus+ programming system or timer recording not made or wrong program recorded

- Check to make sure the correct VCR Plus+ code is entered.
- Check to make sure the cable box or satellite receiver was turned on when recording was to begin.
- Check to make sure the program was entered correctly (wrong channel or times).
- Power interruption. Reset the clock.
- Check to see if time and date are correct – including AM/PM.
- Check to make sure the program did not exceed the tape's length or the tape was not rewound beforehand.
- Check to make sure the VCR was turned off at the time recording was to start.
- Check to make sure there was a tape in the VCR and the cassette's safety tab was intact.
- VCR ejects cassette when the end of the tape is reached during a timer recording.
- Check to make sure VCR Plus+ setup was completed correctly.

APPENDIX: REFERENCE

Will not record

- Check to make sure the safety tab is intact.
- Check to make sure the VCR is not in the line mode. Press INPUT on the remote.

Clock shows incorrect time or date

- Power interruption.
- Check to make sure the clock is set accurately (check AM/PM and date).
- Check Daylight-Saving setting. The clock may have adjusted for daylight-saving time.

Time did not adjust for Daylight-Saving time

- Check to make sure daylight-saving feature is set correctly.

VCR makes noise when stopped

- VCR is removing tape from heads. This is normal. The head cylinder inside the VCR will continue to rotate for a few minutes after you put the VCR in the stop mode.

Will not Auto Channel Search active channels correctly

- Check to make sure the antenna connections are secure and correct.
- Check to make sure the Signal Type: CABLE/ANTENNA feature is set correctly.
- If Detect Automatically was selected for the Signal Type in the AUTO CHANNEL SEARCH menu, try using either CABLE TV or ANTENNA instead.
- May not be necessary if using a cable box for all channels. Contact your local cable company for more information.

Tape plays back in slow motion

- Press PLAY to return to normal playback.

Cannot select channels over 69

- Cable channels over 69 can only be selected if Signal Type: CABLE/ANTENNA feature is set to CABLE.

Cassette with safety tab removed does not start to play automatically

- Check to make sure the AUTO PLAY ON/OFF feature is set to ON.

APPENDIX: REFERENCE

Timer (⌚) indicator flashes

- The clock is not set.
- Check to make sure there is a cassette in the VCR when a timer recording is set.

Time counter disappears during searching

- This is normal.

On-screen menus appear in English, French, or Spanish

- Check LANGUAGE feature.

No stereo sound during playback

- Check to make sure the TAPE PLAYBACK feature is set to Hi-Fi to hear stereo sound during playback. The tape you are playing must be recorded in Hi-Fi in order to use the HI-FI feature.
- Must use the AUDIO/VIDEO jacks on the back of the VCR to hear stereo sound.

Stereo audio too noisy

- Stereo signal is weak. Set reception: STEREO/SAP/MONO feature to MONO.
- Press one of the TRACKING up or down buttons to minimize the noise.

Index and Go-To search features do not operate

- Check to see if MOVIE ►► ADVANCE feature is activated.

Cannot access MOVIE ►► ADVANCE feature

- Cassette must have safety tab removed and be recorded in SP speed.
- Home Recording was selected for the tape type in the menu. Eject cassette and reinsert.

VCR forwards through commercials or momentarily displays a blue screen during playback.

- Commercial Advance Playback feature is set to AUTO. Set it to MANUAL.

APPENDIX: REFERENCE

COMMERCIAL ►► ADVANCE feature does not mark commercials when:

- The Marking feature is set to OFF in the COMMERCIAL ADVANCE menu. Set it to ON.
- A recording is less than 15 minutes or the commercial is longer than one minute.
- A single isolated commercial can not be marked.
- Recording started in the middle of a commercial segment.
- A commercial group within the first or last two minutes of a recording.
- Accuracy and effectiveness can vary depending upon program content and the characteristics of the commercials.
- A commercial is between 30-and-45 seconds and 45-and-60 seconds.
- Effectiveness may vary when local television stations insert their own commercials.

Commercials recorded even though COMMERCIAL ►► ADVANCE feature was set to ON.

- COMMERCIAL ►► ADVANCE is designed to record the commercials, mark them, and then skip over the marked commercials during playback.

APPENDIX: REFERENCE

QUESTIONS AND ANSWERS ABOUT COMMERCIAL▶▶ADVANCE

Will commercials be scanned through only on playback of recordings?

Yes. The VCR does not rewind and mark commercial segments until after recording is finished.

How fast does the COMMERCIAL▶▶ADVANCE VCR scan through the commercial breaks?

In SLP tape speed, a 3-minute commercial break is scanned through in approximately 8-12 seconds. In SP, it takes about 25-35 seconds.

Are commercials still recorded if I want to watch them?

Yes. The recorded program, including commercials, can be viewed by setting the Playback feature to MANUAL.

What if the VCR scans forward through part of my program?

Simply rewind the tape to just before the skipped segment, and press PLAY to view the program.

Once a recording has been marked, does COMMERCIAL▶▶ADVANCE work each time the tape is played?

Yes. If the Playback feature is set to AUTO, the marked commercials should be skipped each time the tape is played in a COMMERCIAL▶▶ADVANCE VCR.

After marking commercials, is the tape left at the beginning or end of the recording?

The tape is left at the end of the recording so it is in position to begin additional programmed recordings.

Does the marking process interfere with other programmed recordings?

No. If two or more recordings are programmed together without sufficient time to mark the first recording, marking will take place after all recordings have completed.

What happens if the marking process is interrupted?

Marking can be interrupted to allow use of the VCR. Marking will resume again when the VCR's power is turned off as long as the tape has not been ejected from the VCR.

Does COMMERCIAL▶▶ADVANCE work in all recording speeds?

Yes, COMMERCIAL▶▶ADVANCE works in SP and SLP.

Will COMMERCIAL▶▶ADVANCE marked recordings work in non-Commercial Advance VCRs?

A COMMERCIAL▶▶ADVANCE marked recording will play in a non-commercial advance VCR, but commercials will not automatically be skipped.

APPENDIX: REFERENCE

SPECIFICATIONS

Format:	VHS
Record/Playback System:	Video: 4-head Audio: Stereo record/playback system
Video Signal System:	EIA standard: NTSC color
Antenna:	75-ohm external VHF/UHF combined antenna terminal
Tuner:	USA: 181 channels capability* (125 cable channels) Canada: 178 channels capability* (122 cable channels)
Type: synthesis	AutoProgramming frequency
Power Requirement:	120V AC, 60 Hz
Power Consumption:	17 watts
Dimensions:	3.54 inches high (90 mm) 14.96 inches wide (380 mm) 10.94 inches deep (278 mm)
Weight:	7.9 pounds (3.6 kg)
Storage Temperature Range:	- 22°F to +149°F (-30°C to +65°C)
Operating Temperature Range:	+41°F to +104°F (+5°C to +40°C)

*Check your cable company's compatibility requirements.

CLEANING THE VCR

Use a soft cloth or dusting attachment of your vacuum cleaner to dust your VCR. Remove dust from the ventilation holes on the cabinet.

Plastic surfaces are easily scratched and can be marred by alcohol and various solvents. Avoid excessive use of oil-based furniture polishes since the materials used in the cabinet will accumulate more dust. We recommend using a nonabrasive, antistatic cleaner and polisher.

Specifications are subject to change.

APPENDIX: REFERENCE

HOW TO FIND YOUR TV'S VIDEO INPUT CHANNEL

You need to tune your TV to the Video Input Channel if you are using the VCR's AUDIO/VIDEO OUT jacks to connect to the TV's AUDIO/VIDEO INPUT jacks. You must select this "channel" before you can see the VCR's menus, the cable or antenna reception, and the content that's on a tape.

The Video Channel on TVs varies for different brands and different models. Below are some steps to try:

- If your TV brand is RCA, GE, or PROSCAN, press the TV button on the remote control that came with the VCR. Then press the INPUT button on the remote.
- If you have another brand of TV, consult the section, Programming The Remote, to see if the VCR's remote control can be set to control your TV. If so, follow the step above.

If those options do not work, try the following ideas. You might access the Video Input Channel by:

- pressing a button on the remote (see table below)
- selecting the channel from the TV's menu system (see table below)
- tuning directly to the channel by selecting a specific channel number (see table below)
- going through all the channels in the channel list by pressing the channel up or down buttons on the TV.

Some common scenarios are listed in the Video Input Channel Variations table that follows:

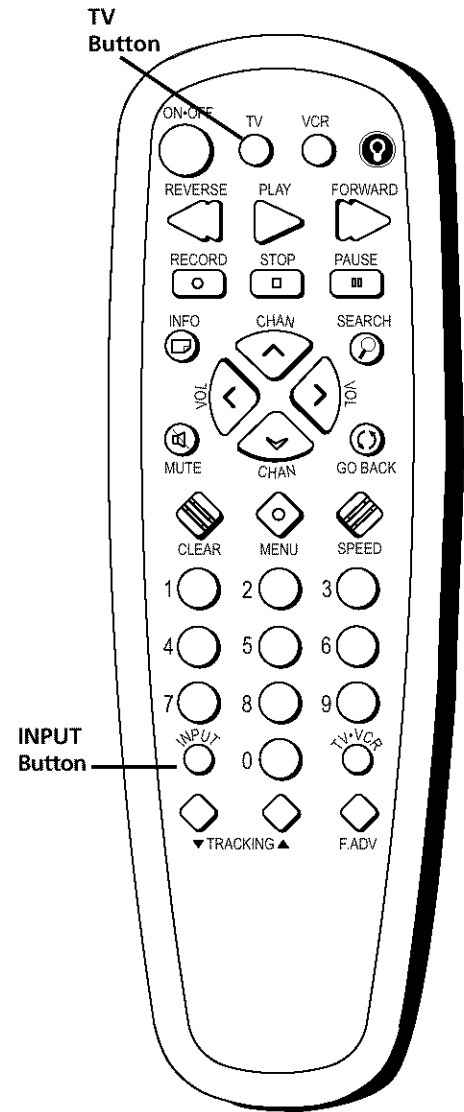

Video Input Channel Variations

Button/Switch on the TV	Button on the TV Remote	Channel Number
VIDEO	VID 1	00
SIGNAL	LINE	90
VID 1	VID	91
VID 2	VIDEO	92
S-VID	S-VID	93
S-VIDEO	INPUT	VID 1
	S-VIDEO	VID 2
	SOURCE	
	AUX	

APPENDIX: REFERENCE

LIMITED WARRANTY

What your warranty covers:

- Any defect in materials or workmanship.

For how long after your purchase:

- Ninety days for labor charges.
- One year for parts.

The warranty period for rental units begins with the first rental or 45 days from date of shipment to the rental firm, whichever comes first.

What we will do:

- Pay any Authorized RCA VCR Service Center the labor charges to repair your VCR.
- Pay any Authorized RCA VCR Service Center for the new or, at our option, refurbished replacement parts required to repair your VCR.

How you get service:

- Take your VCR to any Authorized RCA VCR Service Center. To identify your nearest Authorized RCA VCR Service Center, ask your dealer, look in the Yellow Pages, or call 1-800-336-1900.
- Show the Authorized Service Center Representative your evidence or purchase date or first rental.
- Pick up your VCR when repairs are completed.

What your warranty does not cover:

- Customer instruction. (Your Owner's Manual clearly describes how to install, adjust, and operate your VCR. Any additional information should be obtained from your Dealer.)
- Installation and related adjustments.
- Signal reception problems not caused by your VCR.
- Damage from misuse or neglect.
- Cleaning of video/audio heads.
- Batteries.
- A VCR that has been modified or incorporated into other products or is used for institutional or other commercial purposes.
- A VCR purchased or serviced outside the USA.
- Acts of God, such as but not limited to lightning damage.

Product Registration:

- Please complete and mail the Product Registration Card packed with your VCR. It will make it easier to contact you should it ever be necessary. The return of the card is not required for warranty coverage.

How state law relates to this warranty:

- This warranty gives you specific legal rights and you also may have other rights that vary from state to state.

If you purchased your VCR outside the United States:

- This warranty does not apply. Contact your dealer for warranty information.

INDEX

A

Adding/removing channels 12
ANT IN jack 5, 60
AUDIO menu 49
Audio only
 playing back 34
 recording 33
Audio reception, select 50
Audio set-up features 49
Audio/Video (A/V) jacks
 5, 9, 23, 33, 34, 52, 58, 60, 68
Auto channel search 10
Auto clock set feature 13
Auto play feature 19, 24
Automatic rewind 24
Automatic tracking 24

B

Back panel 60
Batteries
 installing in the remote 4
Broadcast stereo recording (SAP) 33
Buttons, remote 22

C

Cable box setup 9
Cables 52
 positioning 51
CHAN buttons 11, 23, 36
Channel 3/4 switch 5, 54, 60
CHANNEL buttons 22
Channel List 30
Channel number display 59
Channel, VCR viewing 5
CHANNEL•TRACKING button 58
Channels, adding/removing 12
CHANNELS menu 9, 12, 16, 30
Cleaning the VCR 67
CLEAR button 12, 22, 31, 46
Clearing programs 32

COMMERCIAL ADVANCE 40
 display 42
 features 41
 marking 41
 menu 41
 playback 42
 questions and answers 66
Component buttons 22
Connecting your VCR 4
Connections 51
 audio only 33
 audio/video cables 53
 choosing 53
 TV with Audio/Video (A/V) jacks 55
 TV with RF jack only 54
 two VCRs 34
Copying and editing tapes 34

D

Daylight-saving time 14
Display Panel 59
Displays, on-screen 49
DST (Daylight-Saving Time) 12

E

Eject 25
EnergySaver feature 19
Express Recording (XPR) 28

F

F ADV button 22, 46
Forward and reverse search 45
FORWARD button 22, 42, 45
Frame advance 46
Front panel diagram 58
Front panel display feature 20
FWD button 24, 42, 58

INDEX

G

GO BACK button 22
Go-to search 47

I

Index search 46
INFO button 22, 48
INPUT button 9, 23, 29, 33, 60, 68

J

Jacks, types of 52

L

Language feature 8
Light button 22
Line indicators (L1 / L2) 33, 59
Locking feature, Pro-Tect Plus 48

M

MENU button
6, 8, 10, 12, 14, 16, 18, 23, 29, 30, 32, 40, 49
MOVIE ADVANCE 43
MUTE button 24, 36

N

Number buttons 6, 15, 23, 24

O

OFF button 22, 24
ON•OFF button 24, 36
On-screen displays 49
Overheating 51

P

PAUSE button 23, 25, 34, 45, 46
Picture search options 45
PLAY button 23, 24, 45, 46, 48, 54, 56, 58

PLAY•PAUSE button 24
Playback, tape 50
Playing a tape 24
POWER button 24, 58
Power surges 51
PREFERENCES menu 18, 20, 40
Pro-Tect Plus locking 48
Problem solving 61
Programming the remote
to operate TVs 36

R

Reception feature 50
Reception: STEREO/MONO/SAP 33
Reception: STEREO/MONO/SAP feature 50
RECORD button 23, 25, 28, 33, 34, 58
Record-protect tab 25
Recording 25
audio only 33
basic 25
broadcast stereo TV 33
clearing 32
copying and editing tapes 34
Express (XPR) 28
reviewing timer 32
SAP (Second Audio Program) 33
speeds 20
timer 29
types of 28
VCR Plus+ 30
XPR 28
Remote
buttons 22
component buttons 22
installing batteries 4
TV function buttons 23
Remote buttons
light for backlit 22
VCR function 22
Remote Control Option 18
Remote sensor 58

INDEX

Remote VCR1/VCR2 18
Removing/adding channels 12
REV button 24, 58
REVERSE button 23, 45, 46, 47
Review Existing Progs. screen 32
Reviewing programs 32
Rewind, automatic 24
RF OUT jack 5, 60

S

SAFE indicator 48
Safety tab 24
Search
 forward and reverse 45
 frame advance 46
 go-to 47
 index 46
 slow-motion 45
SEARCH button 23, 42, 46
Second Audio Program (SAP), recording 33
Set up
 audio features 49
 cable box 9
 language 8
 using menus 8
Signal type, changing 12
Skipping commercials 39
Slow-motion search 45
SLP indicator 59
SLP tape speed 20, 25
Solving problems 61
SP indicator 59
SP tape speed 20, 25
Specifications 67
SPEED button 23, 28, 31, 33
Speeds, recording 20
Status indicators 59
 BYE 59
 EJEC (Eject) 59
 FF 59
 HI 59

PLAY 59
R0:30 59
REC 59
REW 59
SAFE 59
SCH and SCH- 59
STOP 59

STOP button 23, 24, 28, 32, 43, 46, 48
STOP•EJECT button 24, 43, 58

T

Tape eject 25
Tape playback 24, 50
Tape Playback: HI-FI/LINEAR/MIX feature 50
Tape speed 25
TAPE SPEED button 28, 58
Tape speed indicator 59
Tape speeds 20
Time and date 12
Time and date, set manually 15
Time counter 48
TIME menu 13, 14
Time zone 13
TIMER indicator 59
Timer recording 29
 stopping 32
TIMER RECORDINGS menu 29, 32
Tips, troubleshooting 61
TRACK buttons 23
Tracking 47
TRACKING buttons 24, 45, 47
Troubleshooting tips 61
TV button 22, 36, 68
TV codes 37
TV function buttons 23
TV, programming the remote to control 36
TV•VCR button 23, 33, 54, 56, 58
TV's video input channel 68

INDEX

V

- VCR button 19, 22
- VCR channels list 10
- VCR, cleaning 67
- VCR indicator 33, 59
- VCR MAIN MENU
 - 8, 10, 12, 14, 16, 18, 29, 30, 32, 40, 49
- VCR Plus+
 - channel list 16
 - channel list Canada 17
 - CHANNEL LIST menu 16
 - channel list USA 16
 - channels 16
 - clearing 32
 - menu 31
 - PlusCode programming number 31
 - recording 30
 - reviewing 32
 - stopping a recording 32
 - worksheet for channels 17
- VCR viewing channel 5
- VOL buttons 24, 36

W

- Warranty 69

X

- XDS (Extended Data Services) information 13
- XPR (Express Recording) 28

If your VCR needs service, please contact your dealer or the nearest Servicenter from the yellow pages. Please do not send any products to the Indianapolis address listed in this manual or on the carton. This will only add delays in service for your product.

 **THOMSON CONSUMER ELECTRONICS**
10330 North Meridian Street
Indianapolis, IN 46290

©1999 Thomson Consumer Electronics, Inc.
Trademark(s)® Registered
Marca(s) Registrada(s)
Printed in Mexico
TOCOM 15428200

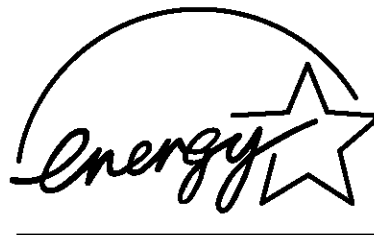

As an ENERGY STAR® Partner, Thomson Consumer Electronics has determined that this product or product model meets the ENERGY STAR® guidelines for energy efficiency.